



Informe de ensayo n°:  
 Test report No:

**NIE: 43480RRF.001A1**

**Test report**  
**REFERENCE STANDARDS:**  
**FCC 47CFR Part 2.1093, Published RF Exposure KDB Procedures,**  
**IC RSS -102 Issue 4:2010**

<b>Identificación del objeto ensayado.....:</b> Identification of item tested	Phablet
<b>Marca .....</b> Trade	YotaPhone
<b>Modelo y/o referencia tipo .....</b> Model and /or type reference	YD201
<b>Other identification of the product .....</b>	Commercial name: YOTAPHONE2 FCC ID: 2ADHW201 IC ID: 12469A-201
<b>Final HW version .....</b>	P2
<b>Final SW version .....</b>	2.6
<b>IMEI TAC .....</b>	IMEI: 004402600038263, 004402600038370
<b>Características .....</b> Features	GSM/GPRS/E-GPRS, WCDMA/HSDPA/HSPA/ HSPA+/DC-HSDPA, WiFi b/g/n20 and WiFi a/n20/ac20/n40
<b>Peticionario .....</b> Applicant	YOTA DEVICES LTD Arch. Makariou & Kalograion, 4, Nicolaides Sea View City, 9th Floor, Flat/Offices 903 -904, Block A-B, 6016, Larnaca, Cyprus. Contact person: Jukka Ollila Telephone: +358405433264 e-mail: jollila@yotadevices.com
<b>Método de ensayo solicitado, norma.....:</b> Test method requested, standard	<ol style="list-style-type: none"> <li>1. FCC 47 CFR Part 2.1093. (10-1-11 Edition) – Radiofrequency radiation exposure evaluation: portable devices.</li> <li>2. FCC OET KDB 447498 D01 General RF Exposure Guidance v05r02 (February 2014).</li> <li>3. FCC OET KDB 865664 D01 v01r03 – SAR Measurement Requirements for 100 MHz to 6 GHz (February 2014).</li> <li>4. FCC OET KDB 248227 D01 - v01r02 – SAR Measurements Procedures 802.11a/b/g Transmitters (May 2007 – Revised).</li> <li>5. FCC OET KDB 941225 D01-v03 – 3G SAR Measurement Procedures (October 2014).</li> <li>6. FCC OET KDB 648474 D04 - v01r02 – SAR Evaluation Considerations for Wireless Handsets (Dec 2013).</li> <li>7. FCC OET KDB 941225 D07 UMPC Mini Tablet v01r01 – SAR Evaluation Procedures for UMPC Mini-Tablet Devices.</li> </ol>

	<ol style="list-style-type: none"> <li>8. FCC OET KDB 941225 D06 Hot Spot SAR v02 – SAR Evaluation Procedures for Portable Devices with Wireless Router Capabilities.</li> <li>9. IC RSS-102 Issue 4 (2010-03). Radio Frequency (RF) Exposure Compliance of Radiocommunication Apparatus (All Frequency Bands).</li> <li>10. Canada’s Safety Code No.6 – Limits of Human Exposure to Radiofrequency Electromagnetic Fields in the Frequency Range from 3 kHz to 300 GHz .</li> </ol>
<p><b>Resultado</b>.....:</p> <p>Summary</p>	<p>Considering the results of the performed test according to FCC 47CFR Part 2.1093, the item under test is IN COMPLIANCE with the requested specifications specified in the standards.</p> <p>The maximum 1g volume averaged SAR for standalone transmission found during this test has been 0.964 W/kg, for body position and WCDMA II Band.</p> <p>The maximum 1g volume averaged SAR for multiband transmission found during this test has been 1.160 W/kg, for body position.</p> <p>NOTE: The results presented in this Test Report apply only to the particular item under test established in page 1 of this document, as presented for test on the date(s) shown in section, “USAGE OF SAMPLES, TESTING PERIOD AND ENVIRONMENTAL CONDITIONS”.</p>
<p><b>Aprobado por (nombre / cargo y firma)</b> .....</p> <p>Approved by (name / position &amp; signature)</p>	<p>F. Cañas</p> <p>Regulatory Lab. Manager</p> 
<p><b>Fecha de realización</b> .....</p> <p>Date of issue</p>	<p>2015-01-07</p>
<p><b>Formato de informe No.</b>.....:</p> <p>Report template No</p>	<p>FDT08_15</p>

# Index

Competences and guarantees.....	4
General conditions.....	4
Uncertainty .....	4
Usage of samples.....	5
Test sample description .....	5
Test samples supplier .....	5
Testing period.....	5
Environmental conditions.....	5
Modifications to the reference test report.....	6
Remarks and comments.....	6
Testing verdicts .....	8
Appendix A – Test configuration .....	10
Appendix B – Test results .....	25
Appendix C – Measurement report .....	56
Appendix D – System Validation Reports .....	78
Appendix E – Calibration data .....	89
Appendix F – Photographs .....	160

## Competences and guarantees

AT4 wireless is a testing laboratory accredited by the National Accreditation Body (ENAC -Entidad Nacional de Acreditación), to perform the tests indicated in the Certificate No. 51/LE 147.

In order to assure the traceability to other national and international laboratories, AT4 wireless has a calibration and maintenance program for its measurement equipment.

AT4 wireless guarantees the reliability of the data presented in this report, which is the result of the measurements and the tests performed to the item under test on the date and under the conditions stated on the report and, it is based on the knowledge and technical facilities available at AT4 wireless at the time of performance of the test.

AT4 wireless is liable to the client for the maintenance of the confidentiality of all information related to the item under test and the results of the test.

The results presented in this Test Report apply only to the particular item under test established in this document.

**IMPORTANT:** No parts of this report may be reproduced or quoted out of context, in any form or by any means, except in full, without the previous written permission of AT4 wireless.

## General conditions

1. This report is only referred to the item that has undergone the test.
2. This report does not constitute or imply on its own an approval of the product by the Certification Bodies or competent Authorities.
3. This document is only valid if complete; no partial reproduction can be made without previous written permission of AT4 wireless.
4. This test report cannot be used partially or in full for publicity and/or promotional purposes without previous written permission of AT4 wireless and the Accreditation Bodies.

## Uncertainty

Uncertainty (factor  $k=2$ ) was calculated according to the following documents:

1. FCC OET KDB 865664 – SAR Measurements Requirements for 100 MHz to 6 GHz (February 2014).

## Usage of samples

Samples undergoing test have been selected by: **the client**

Sample M/01 is composed of the following elements:

Control N°	Description	Model	Serial N°	Date of reception
43116/001	AC/DC Adapter	YDC101	-	2014-07-08
43116/014	USB Cable	-	-	2014-07-09
43116/010	Handset	YT0224F02	004402600038503	2014-07-08
43480/001	Handset	YT0224F02	004402600038222	2014-09-29

Sample M/02 is composed of the following elements:

Control N°	Description	Model	Serial N°	Date of reception
43116/001	AC/DC Adapter	YDC101	-	2014-07-08
43116/014	USB Cable	-	-	2014-07-09
43116/025	Handset	YT0224F02	004402600038263	2014-07-11
43116/026	Handset	YT0224F02	004402600038370	2014-07-11

1. Sample M/01 has undergone the test(s) specified in subclause “Test method requested”: Conducted average output power.
2. Sample M/02 has undergone the test(s) specified in subclause “Test method requested”: SAR evaluation for 2G, 3G, and 802.11 a/b/g/n/ac modes.

## Test sample description

The test sample consists of Smartphone.

## Test samples supplier

Same as applicant

## Testing period

The performed test started on 2014-09-22 and finished on 2014-10-09.

The tests have been performed at AT4 wireless.

## Environmental conditions

In the laboratory for measurements, the following limits were not exceeded during the test:

<b>Temperature</b>	Min. = 21 °C Max. = 25 °C
<b>Relative humidity</b>	Min. = 30 % Max. = 70 %

## Modifications to the reference test report

It was introduced the following modifications in respect to the test report number 43480RRF.001 related with the same samples, in the next clauses and sub-clauses:

Clauses / Sub-clauses	Modification	Justification
Title Page-Test method requested, standard	Standard KDB 941225 D03v02 has been removed.	Removed from the FCC KDB list.
Title Page-Test method requested, standard	Standard KDB 648474 D01 has been removed.	Standard no longer active.
Title Page-Test method requested, standard	Standard KDB 450824 D01 has been replaced for KDB 865664 D01 v01r03.	Standard no longer active.
Title Page-Test method requested, standard	Standard KDB 941225 D01 v02 has been replaced for 941225 D01 v03.	Standard has been updated.
Title Page-Test method requested, standard	Standard 941225 D02 v02r02 has been removed.	Standard no longer active.
Title Page-Test method requested, standard	Standard 941225 D07 UMPC Mini Tablet v01r01 has been included.	Information updated.
Appendix B. 5.3. Result for head simultaneous multi-band transmission	WWAN + 2.4GHz WLAN Simultaneous SAR level has been included.	Information updated.
Appendix B. 5.4. Result for body simultaneous multi-band transmission	WWAN + 2.4GHz WLAN Simultaneous SAR level has been included.	Information updated.
Title Page-Test method requested, standard	Standard 941225 D06 Hot Spot SAR – v02 has been included.	Information updated.

This modification test report cancels and replaces the test report 43480RRF.001.

## Remarks and comments

- 1: Testing of other required channels is not required according to FCC OET KDB 447498 D01 General RF Exposure Guidance v05r02, paragraph “4.3.3. SAR test reduction considerations”.
- 2: Zoom scan is not required due to Area scan based 1-g estimation mention in FCC 447498 D01 – General Exposure Guidance (May 2013).
- 3: GSM, GPRS and EDGE mode tested only for one position due to testing reductions mentioned in FCC OET KDB 447498 D01 – General RF Exposure Guidance v05r02 (February 2014).
- 4: Testing of EDGE mode is not required according to FCC OET KDB 447498 D01 – General RF Exposure Guidance v05r02 (February 2014).
- 5: Testing of HSDPA/HSPA/HSPA+/DC-HSDPA modes are not required according to FCC OET KDB 941225 D01 – 3G SAR Measurement Procedures (October 2014) .
- 6: Testing of Bluetooth mode is not required according to FCC OET KDB 447498 D01 General RF Exposure Guidance v05r02, paragraph “4.3.1. Standalone SAR test exclusion considerations Individual Transmitters”.
- 7: Only the plots of the highest reported SAR for each test position and mode/band are included in appendix C.

## Used instrumentation

1. Dosimetric E-field probe SPEAG ES3DV3, SPEAG EX3DV4
2. Data acquisition device SPEAG DAE4
3. Electro-optical converter SPEAG EOC3
4. 900 MHz dipole validation kit SPEAG D900V2
5. 1800MHz dipole validation kit SPEAG D1800V2
6. 2450 MHz dipole validation kit SPEAG D2450V2
7. 5 GHz dipole validation kit SPEAG D5GHzV2
8. Robot Stäubli RX60BL
9. Robot controller Stäubli CM7MB
10. SAR measurement software SPEAG DASY52 V52.8.8.1222
11. SAR post processing software SPEAG SEMCAD X
12. Measurement server SPEAG DASY5 SE UMS 011 BS
13. SAM head-body simulator SPEAG Twin SAM V4.0
14. Oval flat phantom SPEAG ELI 4
15. Head and Body Tissue Equivalent Liquids for 900MHz, 1800MHz, 2450MHz and 5 GHz bands
16. Radio Communication Tester R&S CMU 200
17. Wideband Radio Communication Tester R&S CMW 500
18. Vector network analyzer Agilent FieldFox N9923A
19. Dielectric probe kit SPEAG DAK-3.5
20. Power meter R&S NRVD
21. Power sensor R&S NRV-Z51
22. Power sensor R&S NRV-Z1
23. RF Generator R&S SMU200A
24. DC Power supply R&S NGSM 32/10
25. Dual directional coupler NARDA FSCM 99899
26. Dual directional coupler HP 778D.
27. Power amplifier MITEQ AMF-4D-00400600-50-30P
28. Handset positioner SPEAG Device Holder
29. Anritsu MT8852A Bluetooth testing unit.

## Testing verdicts

<b>Not applicable</b> .....	N/A
<b>Pass</b> .....	P
<b>Fail</b> .....	F
<b>Not measured</b> .....	N/M

### 850 MHz band

FCC 47CFR Part 2.1093 Paragraph	VERDICT			
	NA	P	F	NM
(d)(2) GSM		P		
(d)(2) GPRS		P		
(d)(2) EDGE				NM <sup>4</sup>
(d)(2) WCDMA Band V		P		
(d)(2) HSDPA, HSPA, HSPA <sup>+</sup> and DC-HSDPA Band V				NM <sup>5</sup>

4 and 5: See Remarks and Comments.

### 1900 MHz band

FCC 47CFR Part 2.1093 Paragraph	VERDICT			
	NA	P	F	NM
(d)(2) GSM		P		
(d)(2) GPRS		P		
(d)(2) EDGE				NM <sup>4</sup>
(d)(2) WCDMA Band II		P		
(d)(2) HSDPA, HSPA, HSPA <sup>+</sup> and DC-HSDPA Band II				NM <sup>5</sup>

4 and 5: See Remarks and Comments.



2450 MHz band

FCC 47CFR Part 2.1093 Paragraph	VERDICT			
	NA	P	F	NM
(d)(2) 802.11b		P		
(d)(2) 802.11g		P		
(d)(2) 802.11n		P		
(d)(2) 802.11ac		P		
(d)(2) Bluetooth				NM <sup>6</sup>

6: See Remarks and Comments.

5 GHz bands

FCC 47CFR Part 2.1093 Paragraph	VERDICT			
	NA	P	F	NM
(d)(2) 802.11a		P		
(d)(2) 802.11n		P		
(d)(2) 802.11ac		P		

FCC 47CFR Part 2.1093 Paragraph	VERDICT			
	NA	P	F	NM
(d)(2) Simultaneous multi-band transmission		P		

## Appendix A – Test configuration

## INDEX

1.	GENERAL INTRODUCTION .....	12
1.1.	Application Standard .....	12
1.2.	General requirements .....	12
1.3.	Measurement system requirements .....	12
1.4.	Phantom requirements .....	12
1.5.	Measurement Liquids requirements. ....	13
2.	MEASUREMENT SYSTEM .....	14
2.1.	Measurement System .....	14
2.2.	Test Positions of device relative to head and body .....	19
2.3.	Test to be performed .....	20
2.4.	Description of interpolation/extrapolation scheme.....	21
2.5.	Determination of the largest peak spatial-average SAR .....	21
2.6.	System Validation .....	21
3.	UNCERTAINTY .....	22
4.	SAR LIMIT .....	23
5.	DEVICE UNDER TEST .....	23
5.1.	Dimmensions.....	23
5.2.	Wireless Technology .....	23
5.3.	Simultaneous Transmission.....	24
5.4.	DUT Antenna Location .....	24

## 1. GENERAL INTRODUCTION

### 1.1. Application Standard

The Federal Communications Commission (FCC) sets the limits for General Population / Uncontrolled exposure to radio frequency electromagnetic fields for transmitting devices designed to be used within 20 centimeters of the body of the user under FCC 47 CFR Part 2.1093 - “Radiofrequency radiation exposure evaluation: portable devices”, paragraph (d)(2).

### 1.2. General requirements

The SAR measurement has been performed continuing the following considerations and environment conditions:

- The ambient temperature shall be in the range of 18°C to 25°C and the variation shall not exceed +/- 2°C during the test.
- The ambient humidity shall be in the range of and 30% - 70%.
- The device battery shall be fully charged before each measurement.

### 1.3. Measurement system requirements

The measurement system used for SAR tests fulfils the procedural and technical requirements described at the reference standards used.

### 1.4. Phantom requirements

The phantom for head worn is a simplified representation of the human anatomy and comprised of material with electrical properties similar to the corresponding tissues in human body. The human model has the following proportions:

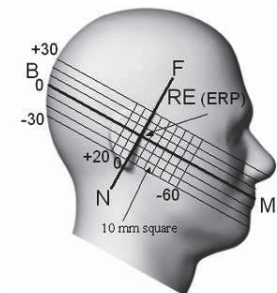

Figure 1: Proportions of Phantom

The shell model is a shaped container and it has the representation shown in the following figure:

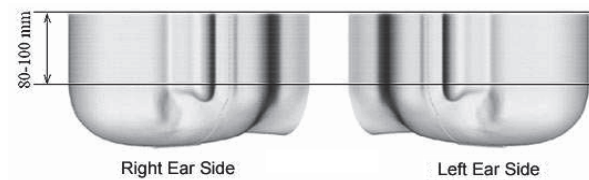

Figure 2: Proportions and shape of Phantom shell

The phantom model for body measurements is an elliptical open-top container with a flat bottom, with the following shape and dimension:

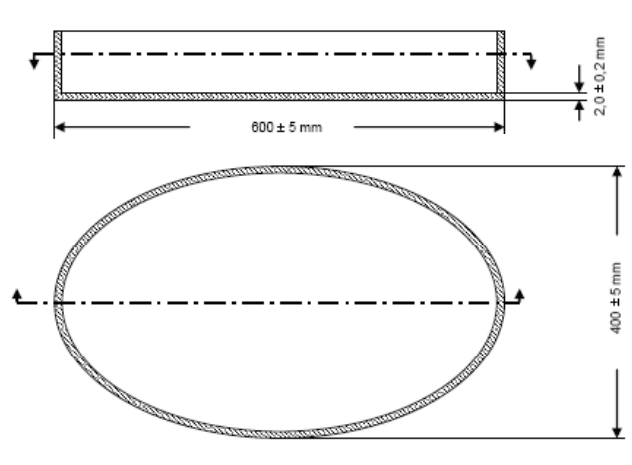

Figure 3: Proportions and shape of Phantom shell

### 1.5. Measurement Liquids requirements.

The liquids used to simulate the human tissues, must fulfil the requirements of the dielectric properties required. These target dielectric properties per FCC OET KDB 450824 instructions come from the dipole and probe calibration data which are included in Appendix B, Section 3, of this document.

## 2. MEASUREMENT SYSTEM

### 2.1. Measurement System

The DASY5 system for performing compliance tests consists of the following items:

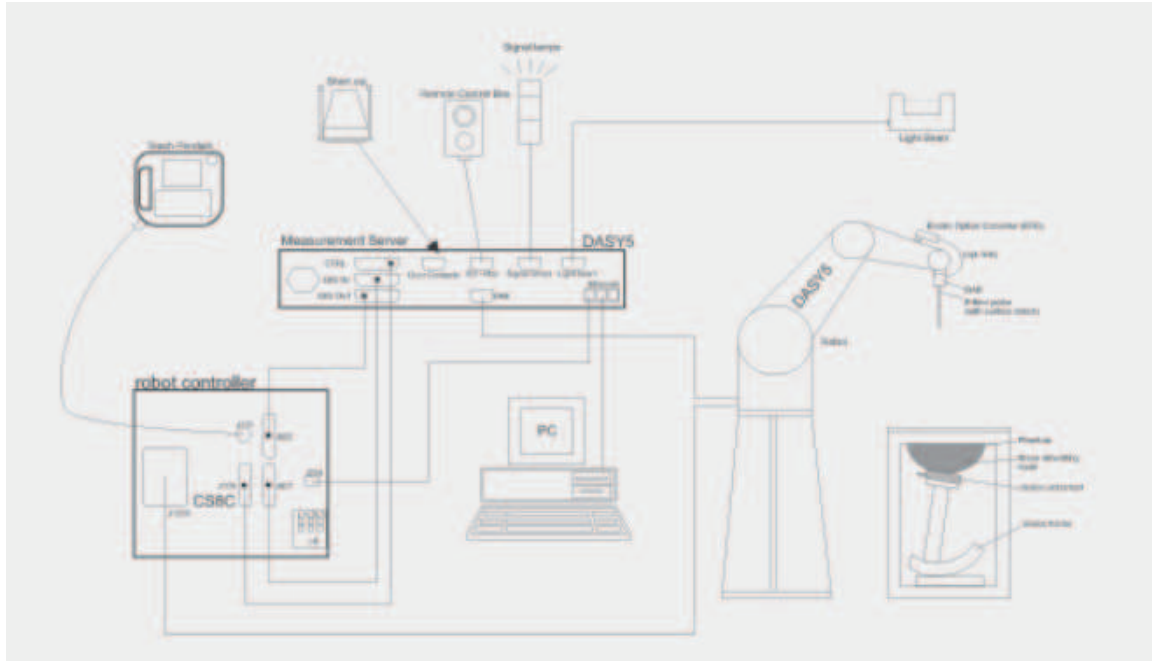

**Figure 4:** SAR Measurement system

- A standard high precision 6-axis robot (Stäubli TX=RX family) with controller, teach pendant and software. An arm extension for accommodating the data acquisition electronics (DAE).
- An isotropic field probe optimized and calibrated for the targeted measurement.
- A data acquisition electronics (DAE) which performs the signal amplification, signal multiplexing, AD-conversion, offset measurements, mechanical surface detection, collision detection, etc. The unit is battery powered with standard or rechargeable batteries. The signal is optically transmitted to the EOC.
- The Electro-optical converter (EOC) performs the conversion from optical to electrical signals for the digital communication to the DAE. To use optical surface detection, a special version of the EOC is required. The EOC signal is transmitted to the measurement server.
- The function of the measurement server is to perform the time critical tasks such as signal filtering, control of the robot operation and fast movement interrupts.
- The Light Beam used is for probe alignment. This improves the (absolute) accuracy of the probe positioning.
- A computer running Win7 professional operating system and the DASY5 software.
- Remote control and teach pendant as well as additional circuitry for robot safety such as warning lamps, etc.
- The phantom, the device holder and other accessories according to the targeted measurement.

Manufacturer	Device	Type
Schmid & Partner Engineering AG	Dosimetric E-Field Probe	ES3DV3
Schmid & Partner Engineering AG	Dosimetric E-Field Probe	EX3DV4
Schmid & Partner Engineering AG	Data Acquisition Electronics	DAE4
Schmid & Partner Engineering AG	Electro-Optical Converter	EOC3
Stäubli	Robot	RX60BL
Stäubli	Robot controller	CS7MB
Schmid & Partner Engineering AG	Measurement Server	DASY5 SE UMS 011 BS
Schmid & Partner Engineering AG	SAM head-body simulator	TWIN SAM V4.0
Schmid & Partner Engineering AG	Oval flat phantom	SPEAG ELI 4
Schmid & Partner Engineering AG	Handset Positioner	SD000 HD1HA
Schmid & Partner Engineering AG	Measurement Software	DASY52 V52.8.8.1222
Schmid & Partner Engineering AG	Postprocessing Software	SEMCAD X
Rohde & Schwarz	RF Generator	SMU 200A
MITEQ	Power amplifier	AMF-4D-00400600-50-30P
Rohde & Schwarz	DC Power supply	NGSM 32/10
NARDA	Directional coupler	FSCM 99899
HP	Dual directional coupler	778D
Weinschel	6dB attenuator	75A-6-11
Rohde & Schwarz	Power Meter	NRVD
Rohde & Schwarz	Power Sensor	NRV-Z51
Rohde & Schwarz	Power Sensor	NRV-Z1
Schmid & Partner Engineering AG	900 MHz System Validation Dipole	D900V2
Schmid & Partner Engineering AG	1800 MHz System Validation Dipole	D1800V2
Schmid & Partner Engineering AG	2450 MHz System Validation Dipole	D2450V2
Schmid & Partner Engineering AG	5 GHz System Validation Dipole	D5GHzV2
Agilent	Vector Network Analyser	FieldFox N9923A
Schmid & Partner Engineering AG	Dielectric Probe Kit	DAK-3.5
Rohde & Schwarz	Radio Communication Tester	CMU 200
Rohde & Schwarz	Wideband Radio Communication Tester	CMW 500

**Table 1:** Measurement Equipment

### DOSIMETRIC E-FIELD PROBE

<b>ES3DV3</b> Isotropic E-Field Probe for Dosimetric Measurements	
	Symmetrical design with triangular core Interleaved sensors Built-in shielding against static charges PEEK enclosure material (resistant to organic solvents, e.g., DGBE)
<b>Calibration</b>	ISO/IEC 17025
<b>Frequency</b>	10 MHz to 4 GHz Linearity: ± 0.2 dB (30 MHz to 4 GHz)
<b>Directivity</b>	± 0.2 dB in TSL (rotation around probe axis) ± 0.3 dB in TSL (rotation normal to probe axis)
<b>Dynamic Range</b>	5 µW/g to > 100 mW/g; Linearity: ± 0.2 dB
<b>Dimensions</b>	Overall length: 337 mm (Tip: 20 mm) Tip diameter: 3.9 mm (Body: 12 mm) Distance from probe tip to dipole centers: 2.0 mm

### DOSIMETRIC E-FIELD PROBE

<b>EX3DV4</b> Smallest Isotropic E-Field Probe for Dosimetric Measurements	
	Symmetrical design with triangular core Built-in shielding against static charges PEEK enclosure material (resistant to organic solvents, e.g., DGBE)
<b>Calibration</b>	ISO/IEC 17025
<b>Frequency</b>	10 MHz to > 6 GHz Linearity: ± 0.2 dB (30 MHz to 6 GHz)
<b>Directivity</b>	± 0.3 dB in TSL (rotation around probe axis) ± 0.5 dB in TSL (rotation normal to probe axis)
<b>Dynamic Range</b>	10 µW/g to > 100 mW/g Linearity: ± 0.2 dB (noise: typically < 1 µW/g)
<b>Dimensions</b>	Overall length: 337 mm (Tip: 20 mm) Tip diameter: 2.5 mm (Body: 12 mm) Typical distance from probe tip to dipole centers: 1 mm

### DATA ACQUISITION ELECTRONICS

<b>DAE4 - Data Acquisition Electronics</b>	
	Signal amplifier, multiplexer, A/D converter, and control logic Serial optical link for communication with DASY4/5 embedded system (fully remote controlled) Two-step probe touch detector for mechanical surface detection and emergency robot stop
<b>Measurement Range</b>	-100 to +300 mV (16 bit resolution and two range settings: 4mV, 400mV)
<b>Input Offset Voltage</b>	< 5 µV (with auto zero)
<b>Input Resistance</b>	200 MOhm
<b>Input Bias Current</b>	< 50 fA



## OVAL FLAT PHANTOM

ELI	
	<p>Phantom for compliance testing of handheld and body-mounted wireless devices in the frequency range of 30 MHz to 6 GHz. ELI is fully compatible with the IEC 62209-2 standard and all known tissue simulating liquids. ELI has been optimized regarding its performance and can be integrated into our standard phantom tables. A cover prevents evaporation of the liquid. Reference markings on the phantom allow installation of the complete setup, including all predefined phantom positions and measurement grids, by teaching three points. The phantom is compatible with all SPEAG dosimetric probes and dipoles.</p> <p>ELI V5.0 has the same shell geometry and is manufactured from the same material as ELI4, but has reinforced top structure.</p>
<b>Material</b>	Vinylester, glass fiber reinforced (VE-GF)
<b>Liquid Compatibility</b>	Compatible with all SPEAG tissue simulating liquids (incl. DGBE type)
<b>Shell Thickness</b>	2.0 ± 0.2 mm (bottom plate)
<b>Dimensions</b>	Major axis: 600 mm Minor axis: 400 mm
<b>Filling Volume</b>	approx. 30 liters
<b>Wooden Support</b>	SPEAG standard phantom table

## SAM HEAD-BODY SIMULATOR

Twin SAM	
	<p>The shell corresponds to the specifications of the Specific Anthropomorphic Mannequin (SAM) phantom defined in IEEE 1528 and IEC 62209-1. It enables the dosimetric evaluation of left and right hand phone usage as well as body mounted usage at the flat phantom region. A cover prevents evaporation of the liquid. Reference markings on the phantom allow the complete setup of all predefined phantom positions and measurement grids by teaching three points with the robot.</p> <p>Twin SAM V5.0 has the same shell geometry and is manufactured from the same material as Twin SAM V4.0, but has reinforced top structure.</p>
<b>Material</b>	Vinylester, glass fiber reinforced (VE-GF)
<b>Liquid Compatibility</b>	Compatible with all SPEAG tissue simulating liquids (incl. DGBE type)
<b>Shell Thickness</b>	2 ± 0.2 mm (6 ± 0.2 mm at ear point)
<b>Dimensions (incl. Wooden Support)</b>	Length: 1000 mm Width: 500 mm Height: adjustable feet
<b>Filling Volume</b>	approx. 25 liters
<b>Wooden Support</b>	SPEAG standard phantom table

## HANDSET POSITIONER

	<p><b>Mounting Device for Hand-Held Transmitters</b></p> <p>In combination with the Twin SAM V5.0/V5.0c or ELI Phantoms, the Mounting Device for Hand-Held Transmitters enables rotation of the mounted transmitter device to specified spherical coordinates. At the heads, the rotation axis is at the ear opening. Transmitter devices can be easily and accurately positioned according to IEC 62209-1, IEEE 1528, FCC, or other specifications. The device holder can be locked for positioning at different phantom sections (left head, right head, flat).</p> <p><b>Material:</b> Polyoxymethylene (POM)</p>
-------------------------------------------------------------------------------------	----------------------------------------------------------------------------------------------------------------------------------------------------------------------------------------------------------------------------------------------------------------------------------------------------------------------------------------------------------------------------------------------------------------------------------------------------------------------------------------------------------------------------------------------------------------------------------------------------------------------

## DIPOLES

System Validation Kits 300 MHz – 6 GHz			
	Symmetrical dipole with 1/4 balun Enables measurement of feedpoint impedance with NWA Matched for use near flat phantoms filled with tissue simulating solutions		
<b>Calibration</b>	ISO/IEC 17025		
<b>Frequency</b>	300, 400, 450, 600, 733, 750, 835, 850, 900, 1300, 1450, 1500, 1640, 1750, 1800, 1900, 1950, 2000, 2100, 2300, 2450, 2550, 2600, 3000, 3300, 3500, 3700 MHz and D5GHz (5100-5800 MHz)		
<b>Return Loss</b>	> 20 dB at specified validation position		
<b>Power Capability</b>	> 100 W (f < 1GHz); > 40 W (f > 1GHz)		
<b>Dimensions (length and overall height in mm)</b>	<b>Product</b>	<b>Dipole length</b>	<b>Overall height</b>
	D750V3	179.0	330.0
	D900V2	148.5	340.0
	D1800V2	72.5	300.0
	D2000V2	65.0	300.0
	D2450V2	52.0	290.0
	D2600V2	49.2	290.0
	D5GHzV2	20.6	300.0

## 2.2. Test Positions of device relative to head and body

Two test positions for the handset in the head are required. These positions are the "cheek" position and the "tilted" position. The tests positions used are described below. The handset should be tested in both positions (left and right sides) in the SAM phantom.

The EUT shall be placed in the Phantom in such way that the main point of the mobile terminal (acoustic output) coincides with the reference point located at the Phantom's ear.

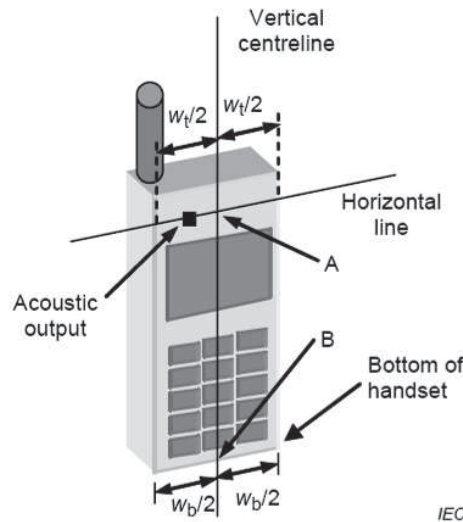

Figure 5: EUT's basic scheme

SAR measurements will be performed for the following configurations as indicated in the reference standard:

- Right side of Phantom, Cheek position.
- Right side of Phantom, 15° Tilted position.
- Left side of Phantom, Cheek position.
- Left side of Phantom, 15° Tilted position.

### Definition of the "cheek" position

The "cheek" position relative to Phantom is described as follows:

1. - Position the device with the vertical centre line of the body of the device and the horizontal line crossing the centre of the ear piece in a plane parallel to the sagittal plane of the Phantom. While maintaining the device in this plane, align the centre line with the reference plane containing the three ear and mouth reference points (M, RE and LE).
2. - Translate the mobile phone box towards the Phantom until the ear-piece touches the ear reference point (RE or LE). While maintaining the device in the reference plane, move the bottom of the box until any point of the front side is in contact with the cheek of the Phantom.

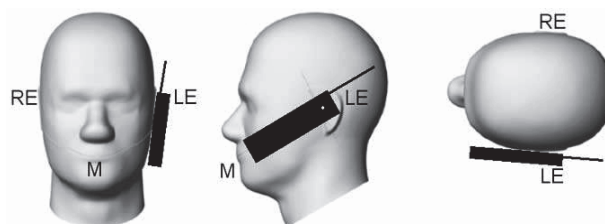
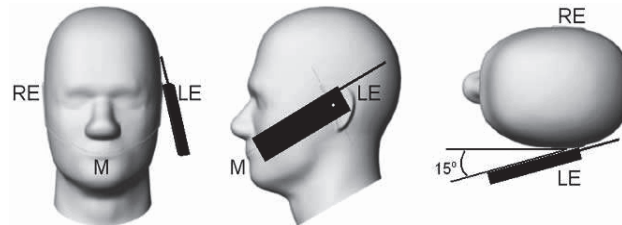

Figure 6: "Cheek" position of EUT

### Definition of the tilted position:

The "15° tilted" position relative to Phantom is described as follows:

1. - Position the device in the "cheek" position described above.
2. - While maintaining the device in the reference plane described above and pivoting against the ear, move it outward away from the mouth by an angle of 15 degrees.



**Figure 7:** "Tilted" position of EUT

For devices that are designed to operate in body configurations SAR compliance should be evaluated using a flat phantom.

### 2.3. Test to be performed

Test shall be performed at both phone positions previously described, on each side of the head (left and right side) and using the centre frequency of each operating band.

Additionally, the configuration giving to the maximum mass averaged SAR shall be used to test the low-end and the high-end frequencies of each transmitting band. Thus, the tests to be performed in mobile phones are as follows:

- Measurements at Central Channel of application band:
  1. SAR measurement at the left side of Phantom and the cheek position of the EUT.
  2. SAR measurement at the left side of Phantom and the tilted 15° position of the EUT.
  3. SAR measurement at the right side of Phantom and the cheek position of the EUT.
  4. SAR measurement at the right side of Phantom and the tilted 15° position of the EUT.
- Measurements at Low Channel of application band: SAR measurement at the side and position where the maximum SAR level, measured at Central channel, was found.
- Measurements at High Channel of application band: SAR measurement at the side and position where the maximum SAR level, measured at Central channel, was found.

As noted above, measurements shall be performed using a flat phantom for body configurations. EUT will be placed at the center of flat phantom. The EUT position using during the body SAR tests will be the one where the maximum peak SAR was found. Low and high channels for each band should be tested at this position.

If the mobile phone is also designed to transmit with other configurations (antenna fully extended/retracted, keypad cover opened/closed...), all tests described above shall be performed for each configuration. When considering multi-mode and multi-band mobile phones, all of the above tests shall be performed at each transmitting mode/band with the corresponding maximum peak power level

## 2.4. Description of interpolation/extrapolation scheme

The local SAR inside the Phantom is measured using small dipole sensing elements inside a probe element. The probe tip must not be in contact with the Phantoms surface in order to minimise measurement errors, but the highest local SAR is obtained from measurements at a certain distances from the shell trough extrapolation. The accurate assessment of the maximum SAR averaged over 1 gr. requires a very fine resolution in the three dimensional scanned data array. Since the measurements have to be performed over a limited time, the measured data have to be interpolated to provide an array of sufficient resolution.

The interpolation of 2D area scan is used after the initial area scan, at a fixed distance from the Phantom shell wall. The initial scan data is collected with approx. 15 mm spatial resolution and this interpolation is used to find the location of the local maximum for positioning the subsequent 3D scanning within a 1mm resolution.

For the 3D scan, data is collected on a spatially regular 3D grid having 5 mm steps in both directions. After the data collection by the SAR probe, the data are extrapolated in the depth direction to assign values to points in the 3D array closer to the shell wall. A notional extrapolation value is also assigned to the first point outside the shell wall so that subsequent interpolation schemes will be applicable right up to the shell wall boundary.

## 2.5. Determination of the largest peak spatial-average SAR

To determine the maximum value of the peak spatial-average SAR of a EUT, all device positions, configurations and operational modes should be tested for each frequency band.

The averaging volume shall be chosen as 1gr. of contiguous tissue. The cubic volumes, over which the SAR measurements are averaged after extrapolation and interpolation, are chosen in order to include the highest values of local SAR.

The maximum SAR level for the EUT will be the maximum level obtained of the performed measurements, and indicated in the previous points.

## 2.6. System Validation

Prior to the SAR measurements, system verification is done daily to verify the system accuracy. A complete SAR evaluation is done using a half-wavelength dipole as source with the frequency of the mid-band channel of the operating band, or within 10% of this channel.

The measured one-gram SAR should be within 10% of the expected target values specified in the calibration certificate of the dipole, for the specific tissue and frequency used.

### 3. UNCERTAINTY

#### Uncertainty for 300 MHz – 6 GHz

ERROR SOURCES	Uncertainty value (± %)	Probability distribution	Divisor	(c <sub>i</sub> ) 1g	(c <sub>i</sub> ) 10g	Standard uncertainty (1g) (± %)	Standard uncertainty (10g) (± %)
<b>Measurement Equipment</b>							
Probe Calibration	6.550	N	1	1	1	6.550	6.550
Isotropy	7.558	R	√3	1	1	4.364	4.364
Linearity	4.700	R	√3	1	1	2.714	2.714
Probe modulation response	2.300	R	√3	1	1	1.328	1.328
Detection limits	0.250	R	√3	1	1	0.144	0.144
Boundary effect	2.000	R	√3	1	1	1.155	1.155
Readout electronics	0.300	N	1	1	1	0.300	0.300
Response time	0.000	R	√3	1	1	0.000	0.000
Integration time	1.900	R	√3	1	1	1.097	1.097
RF Ambien conditions - noise	3.000	R	√3	1	1	1.732	1.732
RF Ambien conditions – reflections	3.000	R	√3	1	1	1.732	1.732
Probe positioner mech. restrictions	0.400	R	√3	1	1	0.231	0.231
Probe positioning with respect to phantom shell	6.700	R	√3	1	1	3.868	3.868
Post-processing	4.000	R	√3	1	1	2.309	2.309
<b>Test Sample Related</b>							
Device holder uncertainty	2.900	N	1	1	1	2.900	2.900
Test sample positioning	3.600	N	1	1	1	3.600	3.600
Drift of output power	5.000	R	√3	1	1	2.887	2.887
<b>Phantom and Setup</b>							
Phantom uncertainty (shape and thickness tolerances)	7.900	R	√3	1	1	4.561	4.561
Algorithm for correcting SAR for deviations in permittivity and conductivity	1.900	N	1	1	0.84	1.900	1.596
Liquid conductivity (meas.)	3.350	N	1	0.78	0.71	2.613	2.379
Liquid permittivity (meas.)	1.500	N	1	0.23	0.26	0.345	0.390
Liquid conductivity – temperature uncertainty	0.440	R	√3	0.78	0.71	0.198	0.180
Liquid permittivity – temperature uncertainty	3.120	R	√3	0.23	0.26	0.414	0.468
<b>Combined standard uncertainty</b>	$u_c = \sqrt{\sum_{i=1}^m c_i^2 \cdot u_i^2}$					<b>12.70</b>	<b>12.62</b>
<b>Expanded uncertainty (confidence interval of 95%)</b>	$u_e = 2.00 u_c$					<b>25.40</b>	<b>25.23</b>

**Table 2:** Uncertainty Assessment for 300 MHz - 6 GHz



#### 4. SAR LIMIT

Having a worst case measurement, the SAR limit is valid for general population/uncontrolled exposure.

The SAR values have to be averaged over a mass of 1 gr. (SAR 1 gr.) with the shape of a cube. This level couldn't exceed the values indicated in the application Standard:

Standard	SAR	SAR Limit (W/Kg)
FCC 47 CFR Part 2.1093 Paragraph (d)(2)	SAR <sub>1 gr.</sub>	1.6

**Table 3:** SAR limit

#### 5. DEVICE UNDER TEST

##### 5.1. Dimmensions

Dimmensions	Millimetres
Height x Width x Depth	145.0 x 70.0 x 8.0
Overall Diagonal:	148.0
Display Diagonal:	127.0

**Table 4:** Dimensions

##### 5.2. Wireless Technology

Wireless Technology	Frequency Bands	Modes
GSM	850 / 1900	- Voice (GMSK) - GPRS (GMSK, Multi-slot class 14) - EGPRS (8PSK, Multi-slot class 14)
W-CDMA	II / V	- UMTS Rel. 99 (Voice & Data) - HSDPA (Rel. 7) - HSUPA (Rel. 6) - DC-HSDPA (Rel. 8) - HSPA+ (Rel. 6)
Wi-Fi	2.4 GHz	- 802.11b/g/n(20MHz & 40MHz)/ac(20MHz)
	5 GHz	- 802.11a/n(20MHz & 40MHz)/ac(20MHz)
Bluetooth	2.4 GHz	- Bluetooth

**Table 5:** Supported modes

### 5.3. Simultaneous Transmission

Simultaneous transmission evaluation was performed following the FCC OET KDB 648474 D01 – SAR Evaluation Considerations for Handsets with Multiple Transmitters and Antennas (Sept 2008), the EUT only admits simultaneous operation in 802.11 a/b/g/n/ac mode with the other ones. The detailed simultaneous transmission combination is:

RF Exposure Condition	Capable Transmit Configurations
Head	1. GSM 850/1900 Voice + WiFi 2.4/5GHz 2. GSM 850/1900 (GPRS/EDGE) + WiFi 2.4/5GHz 3. WCDMA Band II/V + WiFi 2.4/5GHz
Body-worn Accessory/Hotspot	1. GSM 850/1900 Voice + (WiFi 2.4/5GHz or BT) 2. GSM 850/1900 (GPRS/EDGE) + (WiFi 2.4/5GHz or BT) 3. WCDMA Band II/V + (WiFi 2.4/5GHz or BT)
Notes:	
1. WiFi cannot transmit simultaneously with Bluetooth Radio.	

**Table 6:** Simultaneous transmission

### 5.4. DUT Antenna Location

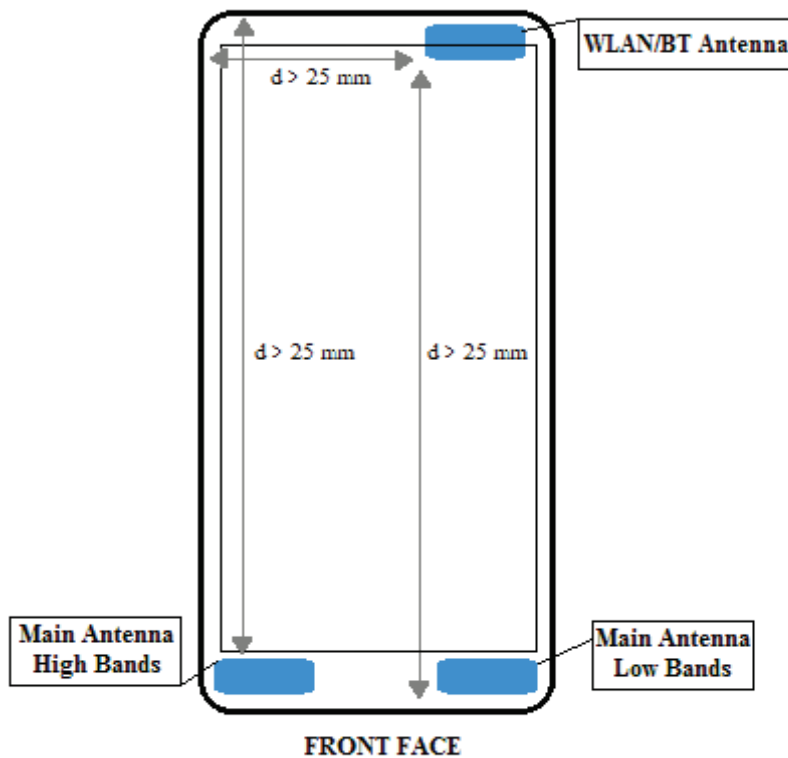

**Figure 8:** Antenna location.



## Appendix B – Test results

## INDEX

1.	TEST CONDITIONS .....	27
1.1.	Power supply (V): .....	27
1.2.	Temperature (°C): .....	27
1.3.	Test signal, Output Power and Frequencies .....	27
1.4.	EUT and test-site configurations.....	27
2.	CONDUCTED AVERAGE POWER MEASUREMENTS .....	28
2.1.	GSM/GPRS/EGPRS Bands.....	28
2.2.	WCDMA/HSDPA/HSPA/HSPA+/DC-HSDPA Bands.....	30
2.3.	Wi-Fi & Bluetooth 2.4 GHz .....	35
2.4.	Wi-Fi 5 GHz.....	36
3.	TISSUE PARAMETERS MEASUREMENTS .....	38
4.	SYSTEM CHECK MEASUREMENTS.....	40
4.1.	Validation results in 900 MHz Band for Head TSL .....	40
4.2.	Validation results in 900 MHz Band for Body TSL.....	40
4.3.	Validation results in 1800 MHz Band for Head TSL .....	40
4.4.	Validation results in 1800 MHz Band for Body TSL.....	40
4.5.	Validation results in 2450 MHz Band for Head TSL .....	40
4.6.	Validation results in 2450 MHz Band for Body TSL.....	41
4.7.	Validation results in 5200 MHz Band for Head TSL .....	41
4.8.	Validation results in 5200 MHz Band for Body TSL.....	41
4.9.	Validation results in 5500 MHz Band for Head TSL .....	41
4.10.	Validation results in 5500 MHz Band for Body TSL.....	41
5.	MEASUREMENT RESULTS FOR SAR (SPECIFIC ABSORPTION RATE).....	42
5.1.	Summary maximum results for head measurements. ....	42
5.2.	Summary maximum results for body measurements.....	43
5.3.	Result for head simultaneous multi-band transmission .....	44
5.4.	Result for body simultaneous multi-band transmission .....	45
5.5.	Results for GSM 850 MHz band.....	46
5.6.	Results for GPRS 850 MHz band – 2 slots. ....	47
5.7.	Results for GSM 1900 MHz Band .....	48
5.8.	Results for GPRS 1900 MHz Band – 2 slots. ....	49
5.9.	Results for WCDMA Band II.....	50
5.10.	Results for WCDMA Band V .....	51
5.11.	Results for Wifi 2.4 GHz Band .....	52
5.12.	Results for Wi-Fi 5200 MHz Band. ....	53
5.13.	Results for Wi-Fi 5300 MHz Band.....	54
5.14.	Results for Wi-Fi 5600 MHz Band.....	55

## 1. TEST CONDITIONS

### 1.1. Power supply (V):

$V_n = 3.8$  Li-polymer rechargeable battery

Type of power supply = DC Voltage from rechargeable Li-Ion 3.8 V battery.

### 1.2. Temperature (°C):

$T_n = +21.12$  to  $+24.89$

The subscript n indicates normal test conditions.

### 1.3. Test signal, Output Power and Frequencies

For the GSM/GPRS/EDGE and WCDMA modes, the samples (**IMEI: 004402600038263** and **IMEI: 004402600038370**) were put into operation by using a R&S CMU 200 and R&S CMW 500 as base station simulator. The output power of the device was set to Power Control Level (PCL) maximum for all tests.

For the 802.11 a/b/g/n/ac, the device was put into operation by using a manufacturer proprietary test mode, setting the maximum output power for each mode. For 802.11 a/b/g/n/ac mode, the duty factor is set to maximum (aprox. 100%).

A fully charged battery was used for every test sequence. In all operating bands and test position, the measurements were performed on middle channels. In each band, for those positions with the maximum averaged SAR was found, measurements were performed on lowest and highest channels except those with applicable test reductions<sup>1, 4, 5</sup>.

1, 4, and 5: See remarks and comments

The maximum time-average conducted power of the device for each mode was measured with a Power meter R&S NRVD and a thermo-coupled power sensor NRV-Z51.

The actual SAR samples does not have accessible antenna connectors for conducted measurements, so the conducted average output power was measured using an identical sample for WWAN (**IMEI: 004402600038222**) and another for WLAN (**IMEI: 004402600038503**), provided by the manufacturer, with auxiliary external connectors that makes the measurements representative and applicable for all the tested samples. See 'usage of samples' paragraph of this report.

### 1.4. EUT and test-site configurations

For both modes, voice modes and only-data modes, the EUT was tested over head and body exposure conditions.

For head tests, the EUT was placed in cheek and tilt position on the right/left side of the SAM phantom.

For body tests, the EUT was placed in each edge position against the flat phantom surface.

The separation distance between EUT and flat phantom surface was 10 mm.

## 2. CONDUCTED AVERAGE POWER MEASUREMENTS

### 2.1. GSM/GPRS/EGPRS Bands

- GSM 850: For voice mode PCL 5 was set in the CMU-200 to allow DUT's max power transmission.

Conducted Average Power Measurement 2G: GSM850					
Channel Number	Frequency (MHz)	Frame Average Output Power (dBm)	Average Burst Output Power (dBm)	PCL	Modulation
128	824.2	23.9	32.9	5	GMSK
190	836.6	23.8	32.8	5	GMSK
251	848.8	24.5	33.5	5	GMSK

- GPRS 850: For data mode. PCL 5, CS1 coding scheme and Gamma 3 were set in the CMU-200 to allow DUT's max power transmission for each slot.

GPRS 850 - Frame Average Output Power							
Channel Number	Frequency (MHz)	Power (dBm) 1 Slot	Power (dBm) 2 Slot	Power (dBm) 3 Slot	Power (dBm) 4 Slot	PCL	Modulation
128	824.2	23.9	25.1	24.3	23.8	5	GMSK-CS1
190	836.6	23.8	24.9	24.2	23.6	5	GMSK-CS1
251	848.8	24.4	24.5	24.0	23.3	5	GMSK-CS1

GPRS 850 - Average Burst Output Power							
Channel Number	Frequency (MHz)	Power (dBm) 1 Slot	Power (dBm) 2 Slot	Power (dBm) 3 Slot	Power (dBm) 4 Slot	PCL	Modulation
128	824.2	32.9	31.1	28.5	26.8	5	GMSK-CS1
190	836.6	32.8	30.9	28.4	26.6	5	GMSK-CS1
251	848.8	33.5	30.5	28.2	26.3	5	GMSK-CS1

- EGPRS 850: For data mode. PCL 8, MCS5 coding scheme and Gamma 6 were set in the CMU-500 to allow DUT's max power transmission for each slot.

EDGE 850 - Frame Average Output Power							
Channel Number	Frequency (MHz)	Power (dBm) 1 Slot	Power (dBm) 2 Slot	Power (dBm) 3 Slot	Power (dBm) 4 Slot	PCL	Modulation
128	824.2	20.7	20.4	19.6	18.8	8	8PSK-MCS5
190	836.6	20.6	20.5	19.4	18.8	8	8PSK-MCS5
251	848.8	20.7	20.3	19.2	18.4	8	8PSK-MCS5

EDGE 850 - Average Burst Output Power							
Channel Number	Frequency (MHz)	Power (dBm) 1 Slot	Power (dBm) 2 Slot	Power (dBm) 3 Slot	Power (dBm) 4 Slot	PCL	Modulation
128	824.2	29.7	26.5	23.9	21.8	8	8PSK-MCS5
190	836.6	29.7	26.5	23.7	21.8	8	8PSK-MCS5
251	848.8	29.7	26.3	23.5	21.5	8	8PSK-MCS5

- GSM 1900: For voice mode PCL 0 was set in the CMU-200 to allow DUT's max power transmission.

Conducted Average Power Measurement 2G: GSM 1900					
Channel Number	Frecuency (MHz)	Frame Average Output Power (dBm)	Average Burst Output Power (dBm)	PCL	Modulation
512	1850.2	20.7	29.7	0	GMSK-CS1
661	1880	20.9	29.9	0	GMSK-CS1
810	1909.8	20.9	29.9	0	GMSK-CS1

- GPRS1900: For data mode. PCL 0, CS1 coding scheme and Gamma 3 were set in the CMU-200 to allow max power transmission for each slot.

GPRS 1900 - Frame Average Output Power							
Channel Number	Frecuency (MHz)	Power (dBm) 1 Slot	Power (dBm) 2 Slot	Power (dBm) 3 Slot	Power (dBm) 4 Slot	PCL	Modulation
512	1850.2	20.6	20.6	20.4	19.6	0	GMSK-CS1
661	1880	20.8	20.8	20.5	19.8	0	GMSK-CS1
810	1909.8	20.9	21.0	20.6	19.9	0	GMSK-CS1

GPRS 1900 - Average Burst Output Power							
Channel Number	Frecuency (MHz)	Power (dBm) 1 Slot	Power (dBm) 2 Slot	Power (dBm) 3 Slot	Power (dBm) 4 Slot	PCL	Modulation
512	1850.2	29.6	26.6	24.7	22.6	0	GMSK-CS1
661	1880	29.8	26.8	24.8	22.8	0	GMSK-CS1
810	1909.8	29.9	27.0	24.9	22.9	0	GMSK-CS1

- EGPRS 1900: For data mode, PCL 2, MCS5 coding scheme and Gamma 5 were set in the CMU-200 to allow max power transmission for each slot.

EDGE 1900 - Frame Average Output Power							
Channel Number	Frecuency (MHz)	Power (dBm) 1 Slot	Power (dBm) 2 Slot	Power (dBm) 3 Slot	Power (dBm) 4 Slot	PCL	Modulation
512	1850.2	16.0	17.2	17.0	16.1	2	8PSK-MCS5
661	1880	16.2	17.7	17.1	16.2	2	8PSK-MCS5
810	1909.8	16.3	18.1	17.4	16.7	2	8PSK-MCS5

EDGE 1900 - Average Burst Output Power							
Channel Number	Frecuency (MHz)	Power (dBm) 1 Slot	Power (dBm) 2 Slot	Power (dBm) 3 Slot	Power (dBm) 4 Slot	PCL	Modulation
512	1850.2	25.0	23.2	21.3	19.1	2	8PSK-MCS5
661	1880	25.2	23.7	21.4	19.2	2	8PSK-MCS5
810	1909.8	25.3	24.2	21.7	19.7	2	8PSK-MCS5

## 2.2. WCDMA/HSDPA/HSPA/HSPA+/DC-HSDPA Bands

- **WCDMA:** The DUT supports power Class 3, with a nominal maximum output power of 24 dBm (+1.7/-3.7). The tests were completed according to 3GPP TS31.121-1 test requirements.

Mode	Subtest	Rel99
WCDMA	Loopback Mode	Test Mode 1
	Rel99 RMC	12.2Kbps RMC
	Power Control Algorithm	Algorithm2
	$\beta_c/\beta_d$	8/15

Band	Mode	CH	Freq	Average Output Power (dBm)
FDD II 1900	WCDMA	9262	1852.4	23.29
FDD II 1900	WCDMA	9400	1880	23.54
FDD II 1900	WCDMA	9538	1907.6	23.52

Band	Mode	CH	Freq	Average Output Power (dBm)
FDD V 850	WCDMA	4132	826.4	23.84
FDD V 850	WCDMA	4182	836.4	23.79
FDD V 850	WCDMA	4233	846.6	23.65

- **HSDPA:**

Mode	Subtest	1	2	3	4
HSDPA	Loopback Mode	Test Mode 1			
	Rel99 RMC	12.2Kbps RMC			
	HSDPA FRC	H-Set1			
	HSUPA Test	HSUPA Loopback			
	Power Control Algorithm	Algorithm 2			
	$\beta_c$	2/15	12/15	15/15	15/15
	$\beta_d$	15/15	15/15	8/15	4/15
	Bd (SF)	64	64	64	64
	$\beta_c/\beta_d$	2/15	12/15	15/8	15/4
	$\beta_{hs}$	4/15	24/15	30/15	30/15
	MPR	0	0	0.5	0.5
	Dack	8			
	Dnak	8			
	Ack-Nack repetition factor	3			
	DCQI	8			
	CQI Feedback	4ms			
	CQI Repetition Factor	2			
	$A_{hs} = \beta_{hs}/\beta_c$	30/15			

Band	Mode	CH	Freq	Average Output Power (dBm)			
				Subtest 1 HSDPA	Subtest 2 HSDPA	Subtest3 HSDPA	Subtest 4 HSDPA
FDD II 1900	HSDPA	9262	1852.4	22.21	22.08	21.58	21.57
FDD II 1900	HSDPA	9400	1880	22.49	22.57	22.1	22.1
FDD II 1900	HSDPA	9538	1907.6	22.49	22.58	22.06	22.05

Band	Mode	CH	Freq	Average Output Power (dBm)			
				Subtest 1 HSDPA	Subtest 2 HSDPA	Subtest3 HSDPA	Subtest 4 HSDPA
FDD V 850	HSDPA	4132	826.4	22.9	22.95	22.52	22.52
FDD V 850	HSDPA	4182	836.4	22.79	22.82	22.39	22.4
FDD V 850	HSDPA	4233	846.6	22.65	22.65	22.2	22.25

**- HSPA:**

Mode	Subtest	1	2	3	4	5
<b>HSPA</b>	Loopback Mode	Test Mode 1				
	Rel99 RMC	12.2Kbps RMC				
	HSDPA FRC	H-Set1				
	HSUPA Test	HSUPA Loopback				
	Power Control Algorithm	Algorithm 2				
	$\beta_c$	11/15	6/15	15/15	2/15	15/15
	$\beta_d$	15/15	15/15	9/15	15/15	15/15
	$\beta_{ec}$	209/225	12/15	30/15	2/15	24/15
	$\beta_c/\beta_d$	11/15	6/15	15/9	2/15	15/15
	$\beta_{hs}$	22/15	12/15	30/15	4/15	30/15
	$\beta_{ed}$	1309/225	94/75	47/15	56/75	134/15
	MPR (dB)	0	2	1	2	0
	Dack	8				
	Dnak	8				
	Ack-Nack repetition factor	3				
	DCQI	8				
	CQI Feedback	4ms				
	CQI Repetition Factor	2				
	$A_{hs} = \beta_{hs}/\beta_c$	30/15				
	AG Index	20	12	15	17	21
ETFCI	75	67	92	71	81	

Band	Mode	CH	Freq	Average Output Power (dBm)				
				Subtest 1 HSUPA	Subtest 2 HSUPA	Subtest3 HSUPA	Subtest 4 HSUPA	Subtest 5 HSUPA
FDD II 1900	HSPA	9262	1852.4	21.71	22.14	22.29	21.32	21.84
FDD II 1900	HSPA	9400	1880	22.09	22.61	22.67	21.75	22.26
FDD II 1900	HSPA	9538	1907.6	22.06	22.68	22.68	21.76	22.26

Band	Mode	CH	Freq	Average Output Power (dBm)				
				Subtest 1 HSUPA	Subtest 2 HSUPA	Subtest3 HSUPA	Subtest 4 HSUPA	Subtest 5 HSUPA
FDD V 850	HSPA	4132	826.4	22.55	22.99	23.06	22.23	22.7
FDD V 850	HSPA	4182	836.4	22.39	22.84	22.84	22.03	22.52
FDD V 850	HSPA	4233	846.6	22.28	22.8	22.78	21.94	22.44

**- HSPA+**

Mode	Subtest	1
HSPA+	Loopback Mode	Test Mode 1
	Rel99 RMC	12.2Kbps RMC
	HSDPA FRC	H-Set1
	HSUPA Test	HSUPA Loopback
	Power Control Algorithm	Algorithm 2
	$\beta_c$	1
	$\beta_d$	0
	$\beta_{ec}$	30/15
	$\beta_{hs}$	30/15
	$\beta_{ed}$ (2xSF2)	$\beta_{ed1}$ : 30/15 $\beta_{ed2}$ : 30/15
	$\beta_{ed}$ (2xSF4)	$\beta_{ed3}$ : 24/15 $\beta_{ed4}$ : 24/15
	CM (dB)	3.5
	MPR (dB)	2.5
	D E-DPCCH	7
	AG Index	14
ETFCI	105	



Band	Mode	CH	Freq	Average Output Power (dBm)
FDD II 1900	HSPA+	9262	1852.4	22.17
FDD II 1900	HSPA+	9400	1880	22.6
FDD II 1900	HSPA+	9538	1907.6	22.75

Band	Mode	CH	Freq	Average Output Power (dBm)
FDD V 850	HSPA+	4132	826.4	22.89
FDD V 850	HSPA+	4182	836.4	22.87
FDD V 850	HSPA+	4233	846.6	22.66

**DC-HSDPA**

	Mode	HSDPA	HSDPA	HSDPA	HSDPA
	Subtest	1	2	3	4
W-CDMA General Settings	Loopback Mode	Test Mode 1			
	Rel99 RMC	12.2 Kbps RMC			
	HSDPA FRC	H-Set 12			
	Power Control Algorithm	Algorithm 2			
	$\beta_c$	2/15	12/15	15/15	15/15
	$\beta_d$	15/15	15/15	8/15	4/15
	Bd (SF)	64			
	$\beta_c/\beta_d$	2/15	12/15	15/8	15/4
	$\beta_{hs}$	4/15	24/15	30/15	30/15
	CM (dB)	0	1	1.5	1.5
MPR	0.0	0.0	0.5	0.5	
HSDPA Specific Settings	Dack	8			
	Dnak	8			
	DCQI	8			
	Ack-Nack repetition factor	3			
	CQI Feedback	4ms			
	CQI Repetition Factor	2			
	A <sub>hs</sub> = $\beta_{hs}/\beta_c$	30/15			

Band	Mode	CH	Freq	Average Output Power (dBm)			
				Subtest 1 DC-HSDPA	Subtest 2 DC-HSDPA	Subtest 3 DC-HSDPA	Subtest 4 DC-HSDPA
FDD II 1900	DC-HSDPA	9262	1852.4	22.07	22.08	21.61	21.63
FDD II 1900	DC-HSDPA	9400	1880	22.52	22.54	22.07	22.08
FDD II 1900	DC-HSDPA	9538	1907.6	22.5	22.65	22.08	22.08

Band	Mode	CH	Freq	Average Output Power (dBm)			
				Subtest 1 DC-HSDPA	Subtest 2 DC-HSDPA	Subtest 3 DC-HSDPA	Subtest 4 DC-HSDPA
FDD V 850	DC-HSDPA	4132	826.4	22.92	22.95	22.55	22.50
FDD V 850	DC-HSDPA	4182	836.4	22.85	22.83	22.36	22.35
FDD V 850	DC-HSDPA	4233	846.6	22.72	22.73	22.28	22.27

### 2.3. Wi-Fi & Bluetooth 2.4 GHz

Band	Mode	Channel / Freq (MHz)	Averaged Power (dBm)
2.4 GHz	802.11b	1/2412	15.3
		2/2417	15.65
		3/2422	15.2
		4/2427	15.14
		5/2432	15.56
		6/2437	15.2
		7/2442	15.24
		8/2447	15.31
		9/2452	15.46
		10/2457	15.46
		11/2462	15.3
	802.11g	1/2412	15.8
		2/2417	15.94
		3/2422	15.85
		4/2427	15.85
		5/2432	15.97
		6/2437	15.8
		7/2442	15.59
		8/2447	15.68
		9/2452	15.83
		10/2457	15.81
		11/2462	15.7
	802.11n20	1/2412	15.0
		2/2417	14.94
		3/2422	14.85
		4/2427	14.73
		5/2432	14.8
		6/2437	14.9
		7/2442	14.77
		8/2447	14.84
		9/2452	14.96
		10/2457	14.93
		11/2462	14.9

Band	Mode	Average Conducted Power (dBm)		
		CH Low	CH Mid	CH High
2450	Bluetooth GFSK	7.265	7.715	5.965
	Bluetooth $\pi/4$ DQPSK	8.095	8.695	6.085
	Bluetooth 8 DPSK	8.385	8.815	7.095

Based on the paragraph “4.3.1. Standalone SAR test exclusion considerations” of the KDB 447498 D01 - General RF Exposure Guidance v05r02:

$$\frac{[(\text{max. power of channel, including tune-up tolerance, mW}) / (\text{min. test separation distance, mm})] \cdot [\sqrt{f(\text{GHz})}]}{\leq 3.0 \text{ for 1-g SAR and } \leq 7.5 \text{ for 10-g extremity SAR}}$$

Communication System	Time Average Max Conducted Power		Min. Test separation distance (mm)	Frequency (Ghz)	Result
	(dBm)	(mW)			
Bluetooth 8 DPSK	8.815	7.612	5	2441	2.38

The computed value is <3.0, Bluetooth qualifies for Standalone SAR test exclusion for 1-g SAR.

## 2.4. Wi-Fi 5 GHz

### 5.2 GHz Band:

Band	Mode	Channel / Freq (MHz)	Averaged Power (dBm)
5.2 GHz	802.11a	36/5180	14.30
		40/5200	14.28
		44/5200	14.32
		48/5240	14.36
	802.11n20	36/5180	14.24
		40/5200	14.29
		44/5200	14.31
		48/5240	14.41
	802.11ac20	36/5180	13.07
		40/5200	13.07
		44/5200	13.26
		48/5240	13.68
802.11n40	38/5190	13.60	
	46/5230	13.42	

**- 5.3 GHz Band:**

Band	Mode	Channel / Freq (MHz)	Averaged Power (dBm)
5.3 GHz	802.11a	52/5260	14.52
		56/5280	14.51
		60/5300	14.14
		64/5320	14.19
	802.11n20	52/5260	14.53
		56/5280	14.52
		60/5300	14.19
		64/5320	14.18
	802.11ac20	52/5260	13.43
		56/5280	13.28
		60/5300	13.12
		64/5320	12.97
802.11n40	54/5270	13.80	
	62/5310	13.40	

**- 5.6 GHz Band:**

Band	Mode	Channel / Freq (MHz)	Averaged Power (dBm)
5.6 GHz	802.11a	100/5500	14.67
		104/5520	14.53
		108/5540	14.75
		116/5580	14.72
		132/5660	14.74
		136/5680	14.59
		140/5700	14.50
	802.11n20	100/5500	13.69
		104/5520	13.97
		108/5540	14.22
		116/5580	14.12
		132/5660	14.03
		136/5680	13.81
		140/5700	13.86
	802.11ac20	100/5500	13.62
		104/5520	13.89
		108/5540	14.17
		116/5580	13.95
		132/5660	13.88
		136/5680	13.77
		140/5700	13.78
	802.11n40	102/5510	13.74
		110/5550	14.19
		134/ 5670	14.01

### 3. TISSUE PARAMETERS MEASUREMENTS

Frequency (MHz)	Target Head Tissue: Parameters used in Probe Calibration		Target Head Tissue: Parameters used in Dipole Calibration		Measured Head Tissue		Measured Date
	Permittivity	Conductivity [S/m]	Permittivity	Conductivity [S/m]	Permittivity	Conductivity [S/m]	
900	41.5 ± 5%	0.97 ± 5%	41.6 ± 6%	0.94 ± 6%	39.98	0.94	06-10-2014
1800	40.0 ± 5%	1.40 ± 5%	38.7 ± 6%	1.37 ± 6%	41.28	1.37	01-10-2014
2450	39.2 ± 5%	1.80 ± 5%	37.8 ± 6%	1.81 ± 6%	39.55	1.86	08-10-2014
2450	39.2 ± 5%	1.80 ± 5%	37.8 ± 6%	1.81 ± 6%	39.58	1.82	15-10-2014
5200	36 ± 5%	4.66 ± 5%	35.2 ± 6%	4.46 ± 6%	35.40	4.51	24-09-2014
5500	35.6 ± 5%	4.97 ± 5%	34.8 ± 6%	4.74 ± 6%	35.58	4.87	25-09-2014

Frequency (MHz)	Target Body Tissue: Parameters used in Probe Calibration		Target Body Tissue: Parameters used in Dipole Calibration		Measured Body Tissue		Measured Date
	Permittivity	Conductivity [S/m]	Permittivity	Conductivity [S/m]	Permittivity	Conductivity [S/m]	
900	55.0 ± 5%	1.05 ± 5%	54.8 ± 6%	1.03 ± 6%	55.44	1.00	06-10-2014
1800	53.3 ± 5%	1.52 ± 5%	51.4 ± 6%	1.53 ± 6%	52.15	1.55	02-10-2014
2450	52.7 ± 5%	1.95 ± 5%	50.5 ± 6%	2.01 ± 6%	52.39	2.00	08-10-2014
2450	52.7 ± 5%	1.95 ± 5%	50.5 ± 6%	2.01 ± 6%	52.42	2.03	16-10-2014
5200	49 ± 5%	5.30 ± 5%	48.9 ± 6%	5.40 ± 6%	47.01	5.08	29-09-2014
5500	48.6 ± 5%	5.65 ± 5%	48.4 ± 6%	5.79 ± 6%	46.45	5.45	25-09-2014

Note: The dielectric properties have been measured by the contact probe method at 23° C.

## **- Composition / Information on ingredients**

### **Head and Muscle Tissue Simulation Liquids HSL900/MSL900**

H2O	Water, 35 – 58%
Sucrose	Sugar, white, refined, 40 – 60%
NaCl	Sodium Chloride, 0 – 6%
Hydroxyethyl-cellulose	Medium Viscosity (CAS# 9004-62-0), <0.3%
Preventol-D7	Preservative: aqueous preparation, (CAS# 55965-84-9), containing 5-chloro-2-methyl-3(2H)-isothiazolone and 2-methyl-3(2H)-isothiazolone, 0.1 – 0.7%

### **Head and Muscle Tissue Simulation Liquids HSL1800/MSL1800**

H2O	Water, 52 – 75%
C8H18O3	Diethylene glycol monobutyl ether (DGBE), 25 – 48% (CAS-No. 112-34-5, EC-No. 203-961-6, EC-index-No. 603-096-00-8)
NaCl	Sodium Chloride, <1.0%

### **Head and Muscle Tissue Simulation Liquids HBBL1900-3800V3/M HBBL1900-3800V3**

Water	50 – 73 %
Non-ionic detergents	27 – 50 % polyoxyethylenesorbitan monolaurate
NaCl	0 – 2 %
Preservative	0.05 – 0.1% Preventol-D7
Safety relevant ingredients:	
CAS-No. 55965-84-9	< 0.1 % aqueous preparation, containing 5-chloro-2-methyl-3(2H)-isothiazolone and 2-methyl-3(2H)-isothiazolone
CAS-No. 9005-64-5	<50 % polyoxyethylenesorbitan monolaurate

### **Head and Muscle Tissue Simulation Liquids HBBL5GHzV2**

Water	76 – 80 %
Mineral Oil	10 – 12 %
Emulsifiers	8 – 10 %
Additives and Salt	1 – 3%

## 4. SYSTEM CHECK MEASUREMENTS

### 4.1. Validation results in 900 MHz Band for Head TSL

DATE	SAR	Target SAR	Measured SAR	Drift (%)	± 10% Limit	Sar 1g	Fast SAR 1g	±3%
06/10/2014	1 gr.	10.70	11.16	4.31	√	2.80	2.87	√
	10 gr.	6.85	7.18	4.75	√	1.80	-	-

### 4.2. Validation results in 900 MHz Band for Body TSL

DATE	SAR	Target SAR	Measured SAR	Drift (%)	± 10% Limit	Sar 1g	Fast SAR 1g	±3%
07/10/2014	1 gr.	10.70	11.20	4.66	√	2.79	2.83	√
	10 gr.	6.95	7.27	4.53	√	1.81	-	-

### 4.3. Validation results in 1800 MHz Band for Head TSL

DATE	SAR	Target SAR	Measured SAR	Drift (%)	± 10% Limit	Sar 1g	Fast SAR 1g	±3%
01/10/2014	1 gr.	38.90	40.45	3.98	√	10.10	10.30	√
	10 gr.	20.40	20.94	2.67	√	5.23	-	-

### 4.4. Validation results in 1800 MHz Band for Body TSL

DATE	SAR	Target SAR	Measured SAR	Drift (%)	± 10% Limit	Sar 1g	Fast SAR 1g	±3%
02/10/2014	1 gr.	39.50	42.85	8.49	√	10.80	10.90	√
	10 gr.	21.00	22.34	6.38	√	5.63	-	-

### 4.5. Validation results in 2450 MHz Band for Head TSL

DATE	SAR	Target SAR	Measured SAR	Drift (%)	± 10% Limit	Sar 1g	Fast SAR 1g	±3%
08/10/14	1 gr.	53.00	56.74	7.06	√	14.30	14.30	√
	10 gr.	24.60	25.79	4.84	√	6.50	-	-

DATE	SAR	Target SAR	Measured SAR	Drift (%)	± 10% Limit	Sar 1g	Fast SAR 1g	±3%
15/10/14	1 gr.	53.00	55.55	4.81	√	14.00	14.10	√
	10 gr.	24.60	25.71	4.52	√	6.48	-	-



**4.6. Validation results in 2450 MHz Band for Body TSL**

DATE	SAR	Target SAR	Measured SAR	Drift (%)	± 10% Limit	Sar 1g	Fast SAR 1g	±3%
09/10/2014	1 gr.	51.10	53.69	5.07	√	13.3	13.10	√
	10 gr.	23.90	24.95	4.39	√	6.18	-	-

DATE	SAR	Target SAR	Measured SAR	Drift (%)	± 10% Limit	Sar 1g	Fast SAR 1g	±3%
16/10/2014	1 gr.	51.10	55.36	8.33	√	14.0	13.90	√
	10 gr.	23.90	25.70	7.54	√	6.50	-	-

**4.7. Validation results in 5200 MHz Band for Head TSL**

DATE	SAR	Target SAR	Measured SAR	Drift (%)	± 10% Limit	Sar 1g	Fast SAR 1g	±3%
24/09/2014	1 gr.	79.10	84.71	7.09	√	8.51	8.03	X
	10 gr.	22.70	24.09	6.12	√	2.42	-	-

**4.8. Validation results in 5200 MHz Band for Body TSL**

DATE	SAR	Target SAR	Measured SAR	Drift (%)	± 10% Limit	Sar 1g	Fast SAR 1g	±3%
29/09/2014	1 gr.	74.70	77.68	3.99	√	7.75	7.14	X
	10 gr.	20.90	22.15	5.99	√	2.21	-	-

**4.9. Validation results in 5500 MHz Band for Head TSL**

DATE	SAR	Target SAR	Measured SAR	Drift (%)	± 10% Limit	Sar 1g	Fast SAR 1g	±3%
25/09/2014	1 gr.	83.00	90.76	9.35	√	9.18	7.71	X
	10 gr.	23.70	25.41	7.21	√	2.57	-	-

**4.10. Validation results in 5500 MHz Band for Body TSL**

DATE	SAR	Target SAR	Measured SAR	Drift (%)	± 10% Limit	Sar 1g	Fast SAR 1g	±3%
26/09/2014	1 gr.	78.70	79.45	0.95	√	7.89	7.22	X
	10 gr.	21.90	23.26	6.21	√	2.31	-	-

## 5. MEASUREMENT RESULTS FOR SAR (SPECIFIC ABSORPTION RATE)

### 5.1. Summary maximum results for head measurements.

Band	Mode	Side / Position	Channel (Frequency)	Reported SAR (1g avg) (W/Kg)	SAR limit (1g avg) (W/Kg)
850 MHz	GSM	Right / Cheek	CH 251 (848.8 MHz)	0.236	1.6
	GPRS 2 slots	Right / Cheek	CH 190 (836.6 MHz)	0.491	1.6
	WCDMA Band V	Right / Cheek	CH 4183 (836.6 MHz)	0.255	1.6
1900 MHz	GSM	Right / Cheek	CH 661 (1880 MHz)	0.269	1.6
	GPRS 2 slots	Right / Cheek	CH 661 (1880 MHz)	0.265	1.6
	WCDMA Band II	Right / Cheek	CH 9400 (1880 MHz)	0.380	1.6
2450 MHz	802.11g	Left / Cheek	CH 6 (2437 MHz)	0.397	1.6
5200 MHz	802.11n40	Left / Cheek	CH 38 (5190 MHz)	0.438	1.6
5300 MHz	802.11n40	Left / Tilted	CH 54 (5270 MHz)	0.438	1.6
5600 MHz	802.11n40	Left / Cheek	CH 110 (5550 MHz)	0.426	1.6

**5.2. Summary maximum results for body measurements**

<b>Band</b>	<b>Mode</b>	<b>Side / Position</b>	<b>Channel (Frequency)</b>	<b>Reported SAR (1g avg) (W/Kg)</b>	<b>SAR limit (1g avg) (W/Kg)</b>
850 MHz	GSM	Back face 10 mm	CH 251 (848.8 MHz)	0.256	1.6
	GPRS 2 slots	Back face 10mm	CH 190 (836.6 MHz)	0.603	1.6
	WCDMA Band V	Back face 10 mm	CH 4183 (836.6 MHz)	0.378	1.6
1900 MHz	GSM	Front face 10mm	CH 661 (1880 MHz)	0.585	1.6
	GPRS 2 slots	Front face 10 mm	CH 661 (1880 MHz)	0.571	1.6
	WCDMA Band II	Back face 10 mm	CH 9400 (1880 Mhz)	0.964	1.6
2450 MHz	802.11b	Back face 10 mm	CH 6 (2437MHz)	0.187	1.6
5200 MHz	802.11n40	Right Edge 10 mm	CH 38 (5190 MHz)	0.13	1.6
5300 MHz	802.11a	Back face 10 mm	CH 52 (5260 MHz)	0.115	1.6
5600 MHz	802.11n40	Top edge 10 mm	CH 110 (5500 MHz)	0.196	1.6

### 5.3. Result for head simultaneous multi-band transmission

#### WWAN + Wi-Fi 2.4 GHz

Transmission Mode	Band	Max SAR (1g avg) (W/Kg)	$\Sigma$ SARi (W/kg)	SAR limit (W/Kg)	Veredict
GSM / GPRS /EDGE	850MHz	0.491	0.888	1.6	Pass
802.11g	2.4 GHz	0.397			
GSM / GPRS /EDGE	1900MHz	0.269	0.666	1.6	Pass
802.11g	2.4 GHz	0.397			
WCDMA	FDD V	0.255	0.652	1.6	Pass
802.11g	2.4 GHz	0.397			
WCDMA	FDD II	0.380	0.777	1.6	Pass
802.11g	2.4 GHz	0.397			

#### WWAN + Wi-Fi 5 GHz

Transmission Mode	Band	Max SAR (1g avg) (W/Kg)	$\Sigma$ SARi (W/kg)	SAR limit (W/Kg)	Veredict
GSM / GPRS /EDGE	850MHz	0.491	0.929	1.6	Pass
802.11n40	5.2/5.3GHz	0.438			
GSM / GPRS /EDGE	1900MHz	0.269	0.707	1.6	Pass
802.11n40	5.2/5.3GHz	0.438			
WCDMA	FDD V	0.255	0.693	1.6	Pass
802.11n40	5.2/5.3GHz	0.438			
WCDMA	FDD II	0.380	0.818	1.6	Pass
802.11n40	5.2/5.3GHz	0.438			

#### 5.4. Result for body simultaneous multi-band transmission

##### WWAN + Wi-Fi 2.4 GHz

Transmission Mode	Band	Max SAR (1g avg) (W/Kg)	Σ SARI (W/kg)	SAR limit (W/Kg)	Verdict
GSM / GPRS /EDGE	850MHz	0.603	0.790	1.6	Pass
802.11b	2.4 GHz	0.187			
GSM / GPRS /EDGE	1900MHz	0.585	0.772	1.6	Pass
802.11b	2.4 GHz	0.187			
WCDMA	FDD V	0.378	0.556	1.6	Pass
802.11b	2.4 GHz	0.187			
WCDMA	FDD II	0.964	1.151	1.6	Pass
802.11b	2.4 GHz	0.187			

##### WWAN + Wi-Fi 5 GHz

Transmission Mode	Band	Max SAR (1g avg) (W/Kg)	Σ SARI (W/kg)	SAR limit (W/Kg)	Verdict
GSM / GPRS /EDGE	850MHz	0.603	0.799	1.6	Pass
802.11n40	5.6 GHz	0.196			
GSM / GPRS /EDGE	1900MHz	0.585	0.781	1.6	Pass
802.11n40	5.6 GHz	0.196			
WCDMA	FDD V	0.378	0.574	1.6	Pass
802.11n40	5.6 GHz	0.196			
WCDMA	FDD II	0.964	1.160	1.6	Pass
802.11n40	5.6 GHz	0.196			

### 5.5. Results for GSM 850 MHz band.

- **Head measurements**

Side / Position	Dist (mm)	Channel (Frequency)	SAR extrapolated 1gr (W/Kg)	SAR Max. over 1gr (W/Kg)	±0.1 (W/Kg)	Power Drift (%)	Max Output Power (dBm)	Max. Reported SAR	Plot	
Left / Cheek	0	CH 251 (848.8 Mhz)	0.208	NM <sup>2</sup>	-	0.58	33.5	0.208		
Left / 15° Tilted	0	CH 251 (848.8 Mhz)	0.125	NM <sup>2</sup>	-	4.59	33.5	0.125		
Right / Cheek	0	CH 251 (848.8 Mhz)	0.231	0.236	√	0.69	33.5	0.236	1	
Right / 15° Tilted	0	CH 251 (848.8 Mhz)	0.127	NM <sup>2</sup>	-	1.04	33.5	0.127		
Right / Cheek	0	CH 128 (824.2 Mhz)	NM <sup>1</sup>					33.5	-	
Right / Cheek	0	CH 190 (836.6 Mhz)	NM <sup>1</sup>					33.5	-	

1 and 2: See remarks and comments.

- **Body measurements**

Side / Position	Dist (mm)	Channel (Frequency)	SAR extrapolated 1gr (W/Kg)	SAR Max. over 1 gr (W/Kg)	±0.1 (W/Kg)	Power Drift (%)	Max Output Power (dBm)	Max. Reported SAR	Plot	
Front face	10	CH 251 (848.8 Mhz)	0.232	NM <sup>2</sup>	-	0.35	33.5	0.232		
Back face	10	CH 251 (848.8 Mhz)	0.248	0.256	√	1.27	33.5	0.256	2	
Left edge	10	CH 251 (848.8 Mhz)	0.208	NM <sup>2</sup>	-	-0.23	33.5	0.208		
Right edge	10	CH 251 (848.8 Mhz)	0.222	NM <sup>2</sup>	-	0.93	33.5	0.222		
Bottom edge	10	CH 251 (848.8 Mhz)	0.151	NM <sup>2</sup>	-	-0.57	33.5	0.151		
Back face	10	CH 128 (824.2 Mhz)	NM <sup>1</sup>					33.5	-	
Back face	10	CH 190 (836.6 Mhz)	NM <sup>1</sup>					33.5	-	

1 and 2: See remarks and comments.

**5.6. Results for GPRS 850 MHz band – 2 slots.**

• **Head measurements**

Side / Position	Dist (mm)	Channel (Frequency)	SAR extrapolated 1gr (W/Kg)	SAR Max. over 1 gr (W/Kg)	±0.1 (W/Kg)	Power Drift (%)	Max Output Power (dBm)	Max. Reported SAR	Plot
Left / Cheek	0	CH 190 (836.6 Mhz)	0.363	NM <sup>2</sup>	-	0.69	31.5	0.417	
Left / 15° Tilted	0	CH 190 (836.6 Mhz)	0.211	NM <sup>2</sup>	-	2.33	31.5	0.242	
Right / Cheek	0	CH 190 (836.6 Mhz)	0.417	0.428	√	0.58	31.5	0.491	3
Right / 15° Tilted	0	CH 190 (836.6 Mhz)	0.225	NM <sup>2</sup>	-	0.69	31.5	0.258	
Right / Cheek	0	CH 128 (824.2 Mhz)	NM <sup>1</sup>				31.5	-	
Right / Cheek	0	CH 251 (848.8 Mhz)	NM <sup>1</sup>				31.5	-	

1 and 2: See remarks and comments.

• **Body measurements**

Side / Position	Dist (mm)	Channel (Frequency)	SAR extrapolated 1gr (W/Kg)	SAR Max. over 1 gr (W/Kg)	±0.1 (W/Kg)	Power Drift (%)	Max Output Power (dBm)	Max. Reported SAR	Plot
Front face	10	CH 190 (836.6 Mhz)	0.451	NM <sup>2</sup>	-	0	31.5	0.518	
Back face	10	CH 190 (836.6 Mhz)	0.572	0.525	√	-1.26	31.5	0.603	4
Left edge	10	CH 190 (836.6 Mhz)	0.331	NM <sup>2</sup>	-	0.69	31.5	0.38	
Right edge	10	CH 190 (836.6 Mhz)	0.439	NM <sup>2</sup>	-	0.58	31.5	0.504	
Bottom edge	10	CH 190 (836.6 Mhz)	0.260	NM <sup>2</sup>	-	-0.92	31.5	0.299	
Back face	10	CH 128 (824.2 Mhz)	NM <sup>1</sup>				31.5	-	
Back face	10	CH 251 (848.8 Mhz)	NM <sup>1</sup>				31.5	-	

1 and 2: See remarks and comments.

### 5.7. Results for GSM 1900 MHz Band

- **Head measurements**

Side / Position	Dist (mm)	Channel (Frequency)	SAR extrapolated 1gr (W/Kg)	SAR Max. over 1 gr (W/Kg)	±0.1 (W/Kg)	Power Drift (%)	Max Output Power (dBm)	Max. Reported SAR	Plot	
Left / Cheek	0	CH 661 (1880 Mhz)	0.109	NM <sup>2</sup>	-	0.35	31.5	0.158		
Left / 15° Tilted	0	CH 661 (1880 Mhz)	0.05	NM <sup>2</sup>	-	1.39	31.5	0.072		
Right / Cheek	0	CH 661 (1880 Mhz)	0.185	0.186	√	-0.23	31.5	0.269	5	
Right / 15° Tilted	0	CH 661 (1880 Mhz)	0.059	NM <sup>2</sup>	-	3.99	31.5	0.085		
Right / Cheek	0	CH 512 (1850.2 Mhz)	NM <sup>1</sup>					31.5	-	
Right / Cheek	0	CH 810 (1909.8 Mhz)	NM <sup>1</sup>					31.5	-	

1 and 2: See remarks and comments

- **Body measurements**

Side / Position	Dist (mm)	Channel (Frequency)	SAR extrapolated 1gr (W/Kg)	SAR Max. over 1 gr (W/Kg)	±0.1 (W/Kg)	Power Drift (%)	Max Output Power (dBm)	Max. Reported SAR	Plot	
Front face	10	CH 661 (1880 Mhz)	0.405	0.405	√	-0.69	31.5	0.585	6	
Back face	10	CH 661 (1880 Mhz)	0.383	NM <sup>2</sup>	-	-0.23	31.5	0.554		
Left edge	10	CH 661 (1880 Mhz)	0.226	NM <sup>2</sup>	-	0	31.5	0.327		
Right edge	10	CH 661 (1880 Mhz)	0.147	NM <sup>2</sup>	-	1.62	31.5	0.212		
Bottom edge	10	CH 661 (1880 Mhz)	0.327	NM <sup>2</sup>	-	0.23	31.5	0.473		
Front face	10	CH 512 (1850.2 Mhz)	NM <sup>1</sup>					31.5	-	
Front face	10	CH 810 (1909.8 Mhz)	NM <sup>1</sup>					31.5	-	

1 and 2: See remarks and comments.



**5.8. Results for GPRS 1900 MHz Band – 2 slots.**

• **Head measurements**

Side / Position	Dist (mm)	Channel (Frequency)	SAR extrapolated 1gr (W/Kg)	SAR Max. over 1 gr (W/Kg)	±0.1 (W/Kg)	Power Drift (%)	Max Output Power (dBm)	Max. Reported SAR	Plot
Left / Cheek	0	CH 661 (1880 Mhz)	0.101	NM <sup>2</sup>	-	2.21	28.5	0.149	
Left / 15° Tilted	0	CH 661 (1880 Mhz)	0.059	NM <sup>2</sup>	-	0.35	28.5	0.087	
Right / Cheek	0	CH 661 (1880 Mhz)	0.181	0.179	√	-1.83	28.5	0.265	7
Right / 15° Tilted	0	CH 661 (1880 Mhz)	0.063	NM <sup>2</sup>	-	2.68	28.5	0.093	
Right / Cheek	0	CH 512 (1850.2 Mhz)	NM <sup>1</sup>				28.5	-	
Right / Cheek	0	CH 810 (1909.8 Mhz)	NM <sup>1</sup>				28.5	-	

1 and 2: See remarks and comments.

• **Body measurements**

Side / Position	Dist (mm)	Channel (Frequency)	SAR extrapolated 1gr (W/Kg)	SAR Max. over 1 gr (W/Kg)	±0.1 (W/Kg)	Power Drift (%)	Max Output Power (dBm)	Max. Reported SAR	Plot
Front face	10	CH 661 (1880 Mhz)	0.390	0.386	√	0.35	28.5	0.571	8
Back face	10	CH 661 (1880 Mhz)	0.355	NM <sup>2</sup>	-	-0.12	28.5	0.525	
Left edge	10	CH 661 (1880 Mhz)	0.217	NM <sup>2</sup>	-	2.09	28.5	0.321	
Right edge	10	CH 661 (1880 Mhz)	0.134	NM <sup>2</sup>	-	2.21	28.5	0.198	
Bottom edge	10	CH 661 (1880 Mhz)	0.362	NM <sup>2</sup>	-	0.46	28.5	0.535	
Front face	10	CH 512 (1850.2 Mhz)	NM <sup>1</sup>				28.5	-	
Front face	10	CH 810 (1909.8 Mhz)	NM <sup>1</sup>				28.5	-	

1 and 2: See remarks and comments.

## 5.9. Results for WCDMA Band II

- **Head measurements**

Side / Position	Dist (mm)	Channel (Frequency)	SAR extrapolated 1gr (W/Kg)	SAR Max. over 1 gr (W/Kg)	±0.1 (W/Kg)	Power Drift (%)	Max Output Power (dBm)	Max. Reported SAR	Plot
Left / Cheek	0	CH 9400 (1880 Mhz)	0.217	NM <sup>2</sup>	-	2.92	24	0.241	
Left / 15° Tilted	0	CH 9400 (1880 Mhz)	0.138	NM <sup>2</sup>	-	-2.61	24	0.153	
Right / Cheek	0	CH 9400 (1880 Mhz)	0.337	0.342	√	-0.57	24	0.380	9
Right / 15° Tilted	0	CH 9400 (1880 Mhz)	0.152	NM <sup>2</sup>	-	0.69	24	0.169	
Right / Cheek	0	CH 9262 (1852.4 Mhz)	NM <sup>1</sup>				24	-	
Right / Cheek	0	CH 9538 (1907.6 Mhz)	NM <sup>1</sup>				24	-	

1 and 2: See remarks and comments

- **Body measurements**

Side / Position	Dist (mm)	Channel (Frequency)	SAR extrapolated 1gr (W/Kg)	SAR Max. over 1 gr (W/Kg)	±0.1 (W/Kg)	Power Drift (%)	Max Output Power (dBm)	Max. Reported SAR	Plot
Front face	10	CH 9400 (1880 Mhz)	0.729	0.732	√	0	24	0.814	
Back face	10	CH 9400 (1880 Mhz)	0.855	0.867	√	0.46	24	0.964	10
Left edge	10	CH 9400 (1880 Mhz)	0.434	NM <sup>2</sup>	-	-0.12	24	0.482	
Right edge	10	CH 9400 (1880 Mhz)	0.263	NM <sup>2</sup>	-	3.51	24	0.292	
Bottom edge	10	CH 9400 (1880 Mhz)	0.591	NM <sup>2</sup>	-	-1.83	24	0.657	
Back face	10	CH 9262 (1852.4 Mhz)	0.839	0.816	√	-1.94	24	0.961	
Back face	10	CH 9538 (1907.6 Mhz)	0.791	0.791	√	-0.23	24	0.883	
Variability Back face	10	CH 9400 (1880 Mhz)	0.842	0.836	√	-1.60	24	0.929	11

2: See remarks and comments

## 5.10. Results for WCDMA Band V

- **Head measurements**

Side / Position	Dist (mm)	Channel (Frequency)	SAR extrapolated 1gr (W/Kg)	SAR Max. over 1 gr (W/Kg)	±0.1 (W/Kg)	Power Drift (%)	Max Output Power (dBm)	Max. Reported SAR	Plot
Left / Cheek	0	CH 4183 (836.6 Mhz)	0.209	NM <sup>2</sup>	-	1.04	24	0.219	
Left / 15° Tilted	0	CH 4183 (836.6 Mhz)	0.128	NM <sup>2</sup>	-	1.98	24	0.134	
Right / Cheek	0	CH 4183 (836.6 Mhz)	0.237	0.243	√	4.11	24	0.255	12
Right / 15° Tilted	0	CH 4183 (836.6 Mhz)	0.125	NM <sup>2</sup>	-	1.86	24	0.131	
Right / Cheek	0	CH 4132 (826.4 Mhz)	NM <sup>1</sup>				24	-	
Right / Cheek	0	CH 4233 (846.6 Mhz)	NM <sup>1</sup>				24	-	

1 and 2: See remarks and comments

- **Body measurements**

Side / Position	Dist (mm)	Channel (Frequency)	SAR extrapolated 1gr (W/Kg)	SAR Max. over 1 gr (W/Kg)	±0.1 (W/Kg)	Power Drift (%)	Max Output Power (dBm)	Max. Reported SAR	Plot
Front face	10	CH 4183 (836.6 Mhz)	0.276	NM <sup>2</sup>	-	-0.34	24	0.29	
Back face	10	CH 4183 (836.6 Mhz)	0.365	0.36	√	0.69	24	0.378	13
Left edge	10	CH 4183 (836.6 Mhz)	0.287	NM <sup>2</sup>	-	0.23	24	0.301	
Right edge	10	CH 4183 (836.6 Mhz)	0.194	NM <sup>2</sup>	-	0.58	24	0.204	
Bottom edge	10	CH 4183 (836.6 Mhz)	0.157	NM <sup>2</sup>	-	0.35	24	0.165	
Back face	10	CH 4132 (826.4 Mhz)	NM <sup>1</sup>				24	-	
Back face	10	CH 4233 (846.6 Mhz)	NM <sup>1</sup>				24	-	

1 and 2: See remarks and comments

### 5.11. Results for Wifi 2.4 GHz Band

- **Head measurements**

Side / Position	Dist (mm)	Mode	Ch #. (Freq)	SAR extrapolated 1gr (W/Kg)	SAR Max. 1gr (W/Kg)	±0.1 (W/Kg)	Power Drift (%)	Max Output Power (dBm)	Max. Reported SAR	Plot
Left / Cheek	0	802.11b	CH 6 (2437 Mhz)	0.333	0.337	√	-0.12	15	0.337	
Left / 15° Tilted	0	802.11b	CH 6 (2437 Mhz)	0.274	NM <sup>2</sup>	-	0.69	15	0.274	
Right / Cheek	0	802.11b	CH 6 (2437 Mhz)	0.195	NM <sup>2</sup>	-	4.47	15	0.195	
Right / 15° Tilted	0	802.11b	CH 6 (2437 Mhz)	0.221	NM <sup>2</sup>	-	0.93	15	0.221	
Left / Cheek	0	802.11b	CH 1 (2412 Mhz)	NM <sup>1</sup>				15	-	
Left / Cheek	0	802.11b	CH 11 (2462 Mhz)	NM <sup>1</sup>				15	-	
Left / Cheek	0	802.11g	CH 6 (2437 Mhz)	0.384	0.379	√	-2.21	16	0.397	14
Left / Cheek	0	802.11n20	CH 6 (2437 Mhz)	0.300	0.296	√	0.69	15	0.303	

1 and 2: See remarks and comments

- **Body measurements**

Side / Position	Dist (mm)	Mode	Ch #. (Freq)	SAR extrapolated 1gr (W/Kg)	SAR Max. 1gr (W/Kg)	±0.1 (W/Kg)	Power Drift (%)	Max Output Power (dBm)	Max. Reported SAR	Plot
Front face	10	802.11b	CH 6 (2437 Mhz)	0.097	NM <sup>2</sup>	-	0	15	0.097	
Back face	10	802.11b	CH 6 (2437 Mhz)	0.19	0.187	√	-1.49	15	0.187	15
Right edge	10	802.11b	CH 6 (2437 Mhz)	0.06	NM <sup>2</sup>	-	-0.69	15	0.060	
Top edge	10	802.11b	CH 6 (2437 Mhz)	0.053	NM <sup>2</sup>	-	-3.39	15	0.053	
Back face	10	802.11b	CH 1 (2412 Mhz)	NM <sup>1</sup>				15	-	
Back face	10	802.11b	CH 11 (2462 Mhz)	NM <sup>1</sup>				15	-	
Back face	10	802.11g	CH 6 (2437 Mhz)	0.171	0.166	√	2.21	16	0.174	
Back face	10	802.11n20	CH 6 (2437 Mhz)	0.137	0.132	√	0.69	15	0.135	

1 and 2: See remarks and comments

### 5.12. Results for Wi-Fi 5200 MHz Band.

- Head measurements

Side / Position	Dist (mm)	Mode	Ch #. (Freq)	SAR Max. 1gr (W/Kg)	Power Drift (%)	Max Output Power (dBm)	Max. Reported SAR	Plot
Left / Cheek	0	802.11a	48 (5240 Mhz)	0.310	2.09	15	0.359	
Left / 15° Tilted	0	802.11a	48 (5240 Mhz)	0.284	4.59	15	0.329	
Right / Cheek	0	802.11a	48 (5240 Mhz)	0.204	-1.03	15	0.236	
Right / 15° Tilted	0	802.11a	48 (5240 Mhz)	0.218	-0.80	15	0.253	
Left / Cheek	0	802.11a	36 (5180 Mhz)	NM <sup>1</sup>		15	-	
Left / Cheek	0	802.11a	40 (5200 Mhz)	NM <sup>1</sup>		15	-	
Left / Cheek	0	802.11n20	48 (5240 Mhz)	0.283	2.33	15	0.324	
Left / Cheek	0	802.11ac20	48 (5240 Mhz)	0.220	1.62	14	0.237	
Left / Cheek	0	802.11n40	38 (5190 Mhz)	0.252	-2.95	16	0.438	16

1: See remarks and comments

- Body measurements

Side / Position	Dist (mm)	Mode	Ch #. (Freq)	SAR Max. 1gr (W/Kg)	Power Drift (%)	Max Output Power (dBm)	Max. Reported SAR	Plot
Front face	10	802.11a	48 (5240 Mhz)	0.082	1.27	15	0.095	
Back face	10	802.11a	48 (5240 Mhz)	0.086	-0.92	15	0.100	
Right edge	10	802.11a	48 (5240 Mhz)	0.095	-0.69	15	0.110	
Top edge	10	802.11a	48 (5240 Mhz)	0.07	2.09	15	0.081	
Right edge	10	802.11a	36 (5180 Mhz)	NM <sup>1</sup>		15	-	
Right edge	10	802.11a	40 (5200 Mhz)	NM <sup>1</sup>		15	-	
Right edge	10	802.11n20	48 (5240 Mhz)	0.093	-1.71	15	0.107	
Right edge	10	802.11ac20	48 (5240 Mhz)	0.068	0	14	0.073	
Right edge	10	802.11n40	38 (5190 Mhz)	0.075	1.04	16	0.130	17

1: See remarks and comments

### 5.13. Results for Wi-Fi 5300 MHz Band.

- Head measurements

Side / Position	Dist (mm)	Mode	Ch #. (Freq)	SAR Max. 1gr (W/Kg)	Power Drift (%)	Max Output Power (dBm)	Max. Reported SAR	Plot
Left / Cheek	0	802.11a	52 (5260 Mhz)	0.286	1.16	15	0.319	
Left / 15° Tilted	0	802.11a	52 (5260 Mhz)	0.325	1.04	15	0.363	
Right / Cheek	0	802.11a	52 (5260 Mhz)	0.225	1.74	15	0.251	
Right / 15° Tilted	0	802.11a	52 (5260 Mhz)	0.228	3.16	15	0.255	
Left / Cheek	0	802.11a	60 (5300 Mhz)	NM <sup>1</sup>		15	-	
Left / Cheek	0	802.11a	64 (5320 Mhz)	NM <sup>1</sup>		15	-	
Left / Cheek	0	802.11n20	52 (5260 Mhz)	0.299	-3.17	15	0.333	
Left / Cheek	0	802.11ac20	52 (5260 Mhz)	0.218	1.16	14	0.249	
Left / Cheek	0	802.11n40	54 (5270 Mhz)	0.264	2.33	16	0.438	18

1: See remarks and comments

- Body measurements

Side / Position	Dist (mm)	Mode	Ch #. (Freq)	SAR Max. 1gr (W/Kg)	Power Drift (%)	Max Output Power (dBm)	Max. Reported SAR	Plot
Front face	10	802.11a	52 (5260 Mhz)	0.072	3.40	15	0.08	
Back face	10	802.11a	52 (5260 Mhz)	0.103	4.23	15	0.115	19
Right edge	10	802.11a	52 (5260 Mhz)	0.095	3.87	15	0.106	
Top edge	10	802.11a	52 (5260 Mhz)	0.078	0.12	15	0.087	
Back face	10	802.11a	60 (5300 Mhz)	NM <sup>1</sup>		15	-	
Back face	10	802.11a	64 (5320 Mhz)	NM <sup>1</sup>		15	-	
Back face	10	802.11n20	52 (5260 Mhz)	0.084	1.74	15	0.094	
Back face	10	802.11ac20	52 (5260 Mhz)	0.049	2.80	14	0.056	
Back face	10	802.11n40	54 (5270 Mhz)	0.066	1.04	16	0.11	

1: See remarks and comments

### 5.14. Results for Wi-Fi 5600 MHz Band.

- Head measurements

Side / Position	Dist (mm)	Mode	Ch #. (Freq)	SAR Max. 1gr (W/Kg)	Power Drift (%)	Max Output Power (dBm)	Max. Reported SAR	Plot
Left / Cheek	0	802.11a	108 (5260 Mhz)	0.24	1.51	15	0.254	
Left / 15° Tilted	0	802.11a	108 (5260 Mhz)	0.236	-0.34	15	0.25	
Right / Cheek	0	802.11a	108 (5260 Mhz)	0.181	1.98	15	0.192	
Right / 15° Tilted	0	802.11a	108 (5260 Mhz)	0.167	2.68	15	0.177	
Left / Cheek	0	802.11a	104 (5520 Mhz)	NM <sup>1</sup>		15	-	
Left / Cheek	0	802.11a	136 (5680 Mhz)	NM <sup>1</sup>		15	-	
Left / Cheek	0	802.11n20	108 (5540 Mhz)	0.265	2.21	14	0.265	
Left / Cheek	0	802.11ac20	108 (5540 Mhz)	0.263	3.75	14	0.263	
Left / Cheek	0	802.11n40	110 (5550 Mhz)	0.281	3.16	16	0.426	20

1: See remarks and comments

- Body measurements

Side / Position	Dist (mm)	Mode	Ch #. (Freq)	SAR Max. 1gr (W/Kg)	Power Drift (%)	Max Output Power (dBm)	Max. Reported SAR	Plot
Front face	10	802.11a	108 (5260 Mhz)	0.046	0.58	15	0.049	
Back face	10	802.11a	108 (5260 Mhz)	0.065	0.35	15	0.069	
Right edge	10	802.11a	108 (5260 Mhz)	0.064	3.40	15	0.068	
Top edge	10	802.11a	108 (5260 Mhz)	0.077	1.16	15	0.082	
Top edge	10	802.11a	104 (5520 Mhz)	NM <sup>1</sup>		15	-	
Top edge	10	802.11a	136 (5680 Mhz)	NM <sup>1</sup>		15	-	
Top edge	10	802.11n20	108 (5540 Mhz)	0.063	4.23	14	0.063	
Top edge	10	802.11ac20	108 (5540 Mhz)	0.074	0.93	14	0.074	
Top edge	10	802.11n40	110 (5550 Mhz)	0.129	-0.23	16	0.196	21

1: See remarks and comments