



TEST REPORT

Report Number. : 13174919-E1V3

Applicant : SOCIAL BICYCLES LLC
55 PROSPECT ST.
SUITE 410,
BROOKLYN, NY 11201, U.S.A.

Model : JUMP PACK 25

FCC ID : 2ADEKJUMPPACK25

EUT Description : RECHARGEABLE LI-ION BATTERY PACK

Test Standard(s) : FCC 47 CFR PART 15 SUBPART C

Date Of Issue:

April 07, 2020

Prepared by:

UL Verification Services Inc.
47173 Benicia Street
Fremont, CA 94538 U.S.A.
TEL: (510) 319-4000
FAX: (510) 661-0888

Revision History

<u>Rev.</u>	<u>Issue Date</u>	<u>Revisions</u>	<u>Revised By</u>
V1	3/20/2020	Initial Issue	--
V2	4/6/2020	Addressed TCB questions	Tina Chu
V3	4/7/2020	Addressed TCB questions	Tina Chu

TABLE OF CONTENTS

1. ATTESTATION OF TEST RESULTS	4
2. TEST METHODOLOGY	6
3. FACILITIES AND ACCREDITATION	6
4. DECISION RULES AND MEASUREMENT UNCERTAINTY	7
4.1. <i>METROLOGICAL TRACEABILITY</i>	<i>7</i>
4.2. <i>DECISION RULES.....</i>	<i>7</i>
4.3. <i>MEASUREMENT UNCERTAINTY.....</i>	<i>7</i>
4.4. <i>SAMPLE CALCULATION</i>	<i>7</i>
5. EQUIPMENT UNDER TEST.....	8
5.1. <i>DESCRIPTION OF EUT</i>	<i>8</i>
5.2. <i>MAXIMUM FIELD STRENGTH.....</i>	<i>8</i>
5.3. <i>DESCRIPTION OF AVAILABLE ANTENNAS</i>	<i>8</i>
5.4. <i>SOFTWARE AND FIRMWARE.....</i>	<i>8</i>
5.5. <i>WORST-CASE CONFIGURATION AND MODE.....</i>	<i>8</i>
5.6. <i>DESCRIPTION OF TEST SETUP.....</i>	<i>9</i>
6. TEST AND MEASUREMENT EQUIPMENT	11
7. OCCUPIED BANDWIDTH	12
7.1. <i>CARD MODE WITH HOLSTER.....</i>	<i>13</i>
7.2. <i>READER MODE WITH HOLSTER</i>	<i>14</i>
7.3. <i>READER MODE WITHOUT HOLSTER.....</i>	<i>15</i>
8. RADIATED EMISSION TEST RESULTS.....	16
8.1. <i>LIMITS AND PROCEDURE.....</i>	<i>16</i>
8.2. <i>FUNDAMENTAL AND SPURIOUS EMISSIONS (0.15 - 30 MHz), EUT WITH AC/DC ADAPTER.....</i>	<i>18</i>
8.2.1. <i>CARD MODE WITH HOLSTER</i>	<i>18</i>
8.2.2. <i>READER MODE WITH HOLSTER</i>	<i>20</i>
8.2.3. <i>READER MODE WITHOUT HOLSTER.....</i>	<i>22</i>
8.3. <i>TX SPURIOUS EMISSION 30 TO 1000 MHz, EUT WITH AC/DC ADAPTER.....</i>	<i>24</i>
8.3.1. <i>CARD MODE WITH HOLSTER</i>	<i>24</i>
8.3.2. <i>READER MODE WITH HOLSTER</i>	<i>26</i>
8.3.3. <i>READER MODE WITHOUT HOLSTER.....</i>	<i>28</i>
9. FREQUENCY STABILITY	30
10. SETUP PHOTOS.....	31

1. ATTESTATION OF TEST RESULTS

COMPANY NAME: SOCIAL BICYCLES, LLC
55 PROSPECT ST.
SUITE 410,
BROOKLYN, NY 11201, U.S.A.

EUT DESCRIPTION: RECHARGEABLE LI-ION BATTERY PACK

MODEL: JUMP PACK 25

SERIAL NUMBER: BBXA1935400059

DATE TESTED: JANUARY 30 to FEBRUARY 04, 2020

APPLICABLE STANDARDS	
STANDARD	TEST RESULTS
FCC PART 15 SUBPART C	Complies

UL Verification Services Inc. tested the above equipment in accordance with the requirements set forth in the above standards. The test results show that the equipment tested is capable of demonstrating compliance with the requirements as documented in this report.

The results documented in this report apply only to the tested sample, under the conditions and modes of operation as described herein. It is the manufacturer's responsibility to assure that additional production units of this model are manufactured with identical electrical and mechanical components. All samples tested were in good operating condition throughout the entire test program. Measurement Uncertainties are published for informational purposes only and were not taken into account unless noted otherwise.

This document may not be altered or revised in any way unless done so by UL Verification Services Inc. and all revisions are duly noted in the revisions section. Any alteration of this document not carried out by UL Verification Services Inc. will constitute fraud and shall nullify the document.

Approved & Released For
UL Verification Services Inc. By:



Francisco de Anda
Operations Leader
Consumer Technology Division
UL Verification Services Inc.

Prepared By:



Kevin Wu
Test Engineer
Consumer Technology Division
UL Verification Services Inc.

Reviewed By:



Tina Chu
Senior Project Engineer
Consumer Technology Division
UL Verification Services Inc.

2. TEST METHODOLOGY

The tests documented in this report were performed in accordance with ANSI C63.10-2013, FCC CFR 47 Part 2, FCC CFR 47 Part 15.

3. FACILITIES AND ACCREDITATION

The test sites and measurement facilities used to collect data are located at 47173 and 47266 Benicia Street, and 47658 Kato Road, Fremont, California, USA. Line conducted emissions are measured only at the 47173 address. The following table identifies which facilities were utilized for radiated emission measurements documented in this report. Specific facilities are also identified in the test results sections.

47173 Benicia Street	47266 Benicia Street	47658 Kato Rd
<input type="checkbox"/> Chamber A	<input type="checkbox"/> Chamber D	<input type="checkbox"/> Chamber I
<input type="checkbox"/> Chamber B	<input type="checkbox"/> Chamber E	<input type="checkbox"/> Chamber J
<input type="checkbox"/> Chamber C	<input type="checkbox"/> Chamber F	<input checked="" type="checkbox"/> Chamber K
	<input type="checkbox"/> Chamber G	<input type="checkbox"/> Chamber L
	<input type="checkbox"/> Chamber H	<input type="checkbox"/> Chamber M

The above test sites and facilities are covered under FCC Test Firm Registration # 208313. Chambers above are covered under Industry Canada company address and respective code: 2324A.

4. DECISION RULES AND MEASUREMENT UNCERTAINTY

4.1. METROLOGICAL TRACEABILITY

All test and measuring equipment utilized to perform the tests documented in this report are calibrated on a regular basis, with a maximum time between calibrations of one year or the manufacturers' recommendation, whichever is less, and where applicable is traceable to recognized national standards.

4.2. DECISION RULES

The Decision Rule is based on Simple Acceptance in accordance with ISO Guide 98-4:2012 Clause 8.2. (Measurement uncertainty is not taken into account when stating conformity with a specified requirement.)

4.3. MEASUREMENT UNCERTAINTY

Where relevant, the following measurement uncertainty levels have been estimated for tests performed on the apparatus:

PARAMETER	U _{Lab}
Conducted Disturbance, 9KHz to 0.15 MHz	3.39 dB
Conducted Disturbance, 0.15 to 30 MHz	3.07 dB
Radiated Disturbance, 9KHz to 30 MHz	2.52 dB
Radiated Disturbance, 30 to 1000 MHz	4.88 dB
Radiated Disturbance, 1000 to 18000 MHz	4.24 dB
Radiated Disturbance, 18000 to 26000 MHz	4.37 dB
Radiated Disturbance, 26000 to 40000 MHz	5.17 dB

Uncertainty figures are valid to a confidence level of 95%.

4.4. SAMPLE CALCULATION

RADIATED EMISSIONS

Where relevant, the following sample calculation is provided:

$$\text{Field Strength (dBuV/m)} = \text{Measured Voltage (dBuV)} + \text{Antenna Factor (dB/m)} + \text{Cable Loss (dB)} - \text{Preamp Gain (dB)}$$

$$36.5 \text{ dBuV} + 18.7 \text{ dB/m} + 0.6 \text{ dB} - 26.9 \text{ dB} = 28.9 \text{ dBuV/m}$$

MAINS CONDUCTED EMISSIONS

Where relevant, the following sample calculation is provided:

$$\text{Final Voltage (dBuV)} = \text{Measured Voltage (dBuV)} + \text{Cable Loss (dB)} + \text{Limiter Factor (dB)} + \text{LISN Insertion Loss.}$$

$$36.5 \text{ dBuV} + 0 \text{ dB} + 10.1 \text{ dB} + 0 \text{ dB} = 46.6 \text{ dBuV}$$

5. EQUIPMENT UNDER TEST

5.1. DESCRIPTION OF EUT

The EUT is a rechargeable Li-ion battery assembly that includes an NFC radio.

5.2. MAXIMUM FIELD STRENGTH

The transmitter has a maximum peak radiated magnetic field strength as follows:

Frequency Range (MHz)	Type	E Field at 30m distance (dBuV/m)
13.56	A	8.58

Note: Tested @3 meters

5.3. DESCRIPTION OF AVAILABLE ANTENNAS

The radio utilizes a coil antenna.

5.4. SOFTWARE AND FIRMWARE

The firmware installed in the EUT during testing was 2019-07-01-1425_Device_S.

5.5. WORST-CASE CONFIGURATION AND MODE

Three configurations have been investigated:

1. Card mode: EUT with holster
2. Reader mode: EUT with holster
3. Reader mode: EUT without holster

The fundamental of the EUT was investigated under three orthogonal orientations X (Flatbed), Y (Landscape), and Z (Portrait) for with and without holster. The X (Flatbed) orientation was determined to be the worst-case orientation and all final radiated testing was performed at this orientation.

The EUT was investigated from 9kHz to 1000MHz.

When the EUT is installed in the holster is only powered by DC and does not connected to AC mains. Therefore AC conducted emissions is not applicable.

5.6. DESCRIPTION OF TEST SETUP

SUPPORT EQUIPMENT

Support Equipment List				
Description	Manufacturer	Model	Serial Number	FCC ID
Holster	Flex	H30	110014	2ADEK-191230

I/O CABLES

I/O Cable List						
Cable No	Port	# of identical ports	Connector Type	Cable Type	Cable Length (m)	Remarks
1	DC	1	DC	Un-shielded	1	N/A
2	AC	1	AC	Un-shielded	1	N/A

RADIATED EMISSIONS SETUP DIAGRAM

EUT with Holster

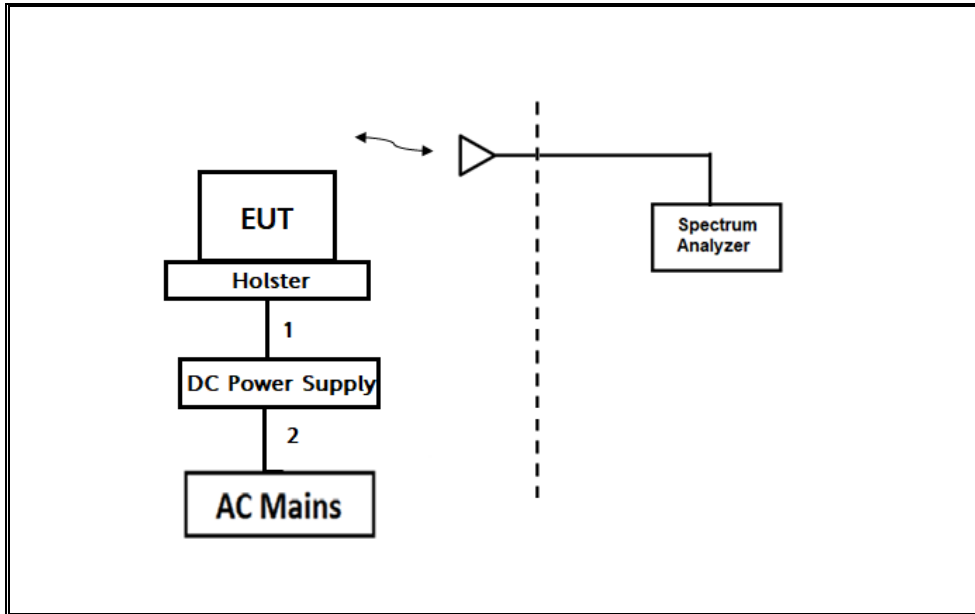

EUT without Holster

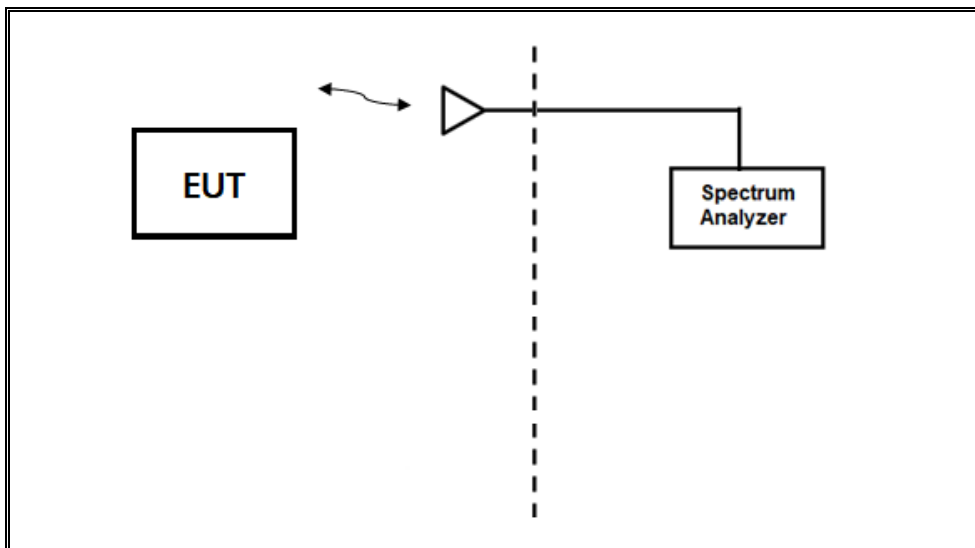

TEST SETUP

EUT is standalone or connected to Holster. Holster is powered by DC power supply.

6. TEST AND MEASUREMENT EQUIPMENT

The following test and measurement equipment was utilized for the tests documented in this report:

TEST EQUIPMENT LIST					
Description	Manufacturer	Model	ID Num	Cal Due	Last Cal
Amplifier, 9KHz to 1GHz, 32dB	SONOMA INSTRUMENT	310	175953	01/23/2021	01/23/2020
Antenna, Active Loop 9kHz to 30MHz	COM-POWER CORP.	AL-130R	PRE0165308	04/11/2020	04/11/2019
Antenna, BroadBand Hybrid, 30MHz to 3GHz	Sunol Sciences Corp.	JB3	PRE0181574	10/14/2020	10/14/2019
EMI TEST RECEIVER	Rohde & Schwarz	ESW44	PRE0179372	02/16/2020	02/16/2019
Spectrum Analyzer, PXA, 3Hz to 44GHz	Keysight Technologies	N9030A	T908	01/28/2021	01/28/2020
Environmental Chamber	Thermotron Industries	SE-600-10-10	T80	05/07/2020	05/07/2019

UL SOFTWARE			
*Radiated Software	UL	UL EMC	Rev 9.5 24 Sep 2019
*Conducted Software	UL	UL EMC	AP2019.11.13

Note: * indicates automation software version used in the compliance certification testing

7. OCCUPIED BANDWIDTH

LIMITS

None; for reporting purposes only.

TEST PROCEDURE

The loop antenna is connected to the spectrum analyzer. The RBW is set to 10kHz. The VBW is set to 3 times the RBW. The sweep time is coupled. The spectrum analyzer internal 99% bandwidth function is utilized.

Note: Because the measured signal is CW or CW-like adjusting the RBW per C63.10 would not be practical since measured bandwidth will always follow the RBW and the result will be approximately twice the RBW.

RESULTS

99% and 20dB BW

Card Mode with Holster

Frequency (MHz)	99% Bandwidth (KHz)	20dB Bandwidth (KHz)
13.56	23.253	26.83

Reader Mode with Holster

Frequency (MHz)	99% Bandwidth (KHz)	20dB Bandwidth (KHz)
13.56	23.068	26.84

Reader Mode without Holster

Frequency (MHz)	99% Bandwidth (KHz)	20dB Bandwidth (KHz)
13.56	23.159	27.34

7.1. CARD MODE WITH HOLSTER

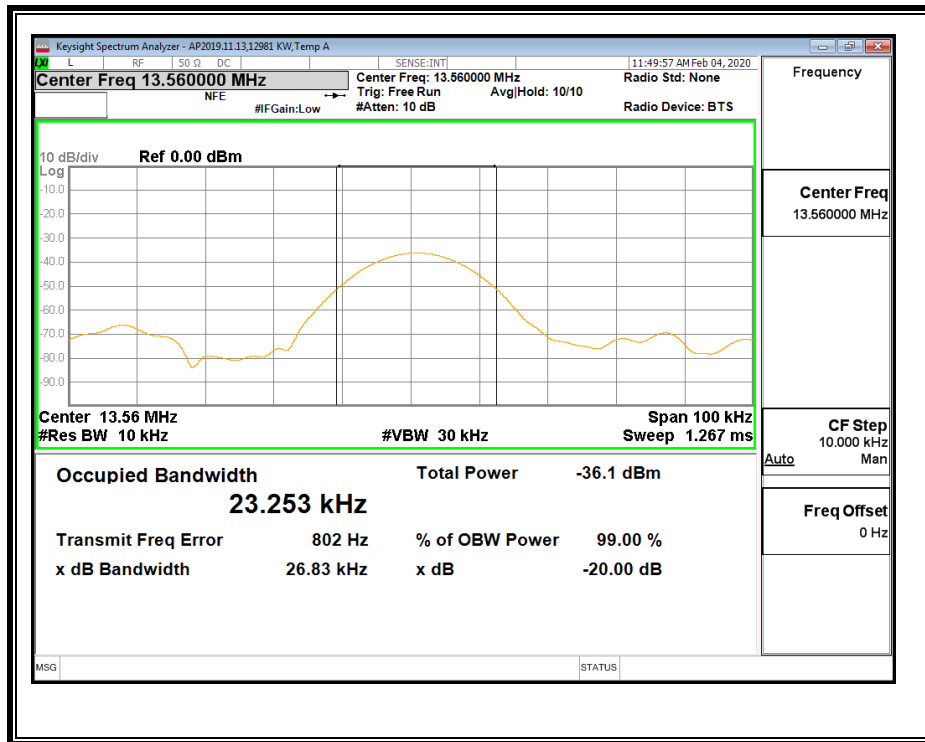

7.2. READER MODE WITH HOLSTER

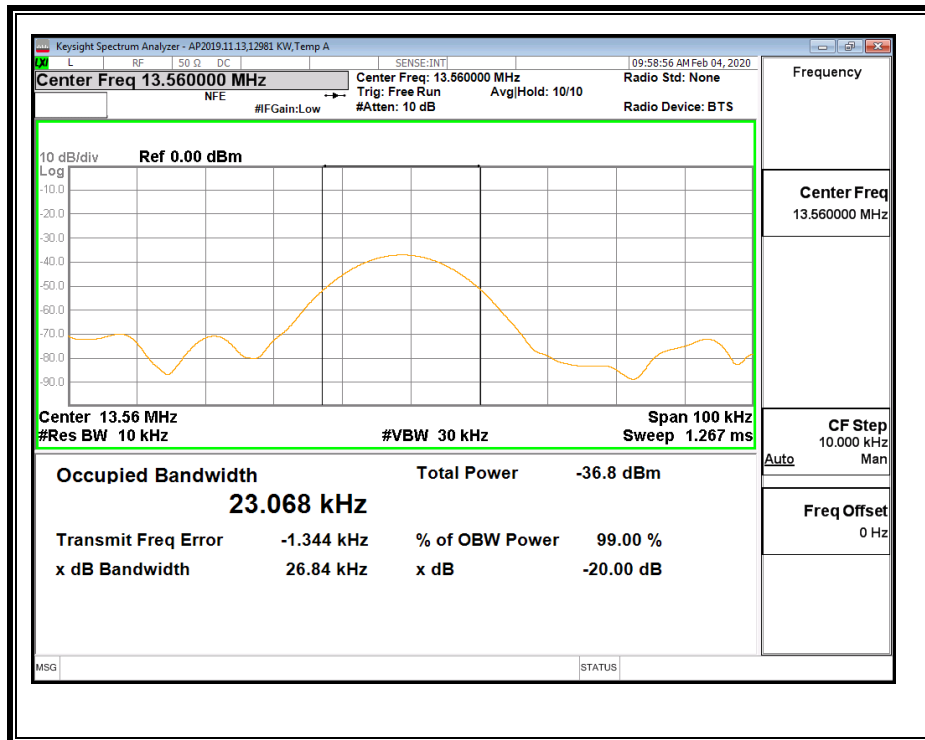

7.3. READER MODE WITHOUT HOLSTER

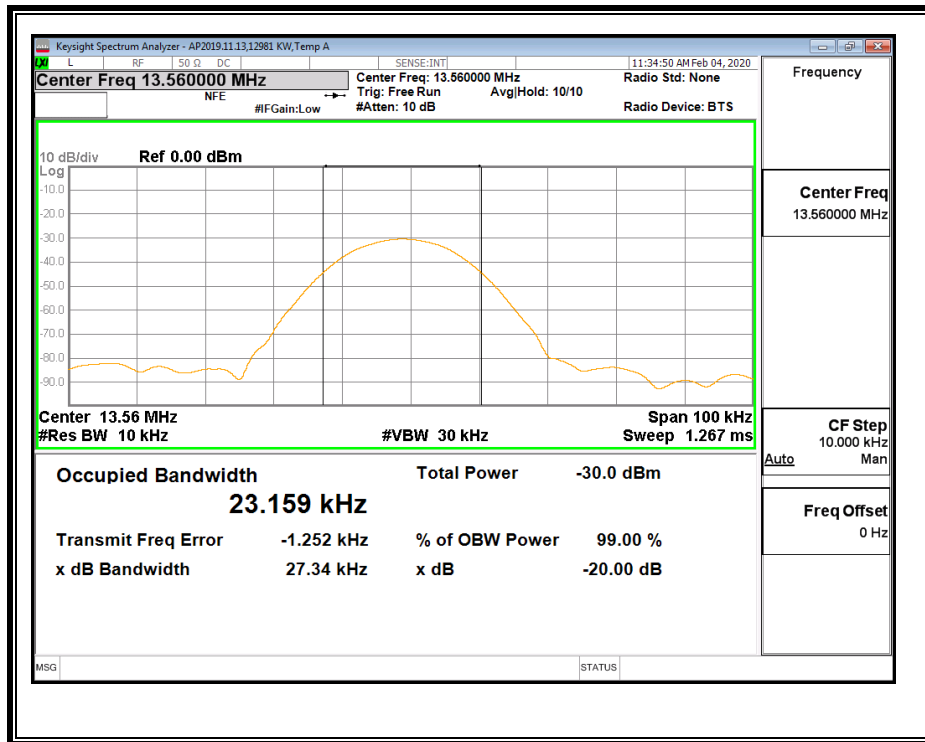

8. RADIATED EMISSION TEST RESULTS

8.1. LIMITS AND PROCEDURE

LIMIT

§15.225

(a) The field strength of any emissions within the band 13.553–13.567 MHz shall not exceed 15,848 microvolts/ meter at 30 meters.

(b) Within the bands 13.410–13.553 MHz and 13.567–13.710 MHz, the field strength of any emissions shall not exceed 334 microvolts/meter at 30 meters.

(c) Within the bands 13.110–13.410 MHz and 13.710–14.010 MHz the field strength of any emissions shall not exceed 106 microvolts/meter at 30 meters.

(d) The field strength of any emissions appearing outside of the 13.110– 14.010 MHz and shall not exceed the general radiated emission limits in § 15.209 as follows:

§15.209 (a) Except as provided elsewhere in this subpart, the emissions from an intentional radiator shall not exceed the field strength levels specified in the following table:

Limits for radiated disturbance of an intentional radiator		
Frequency range (MHz)	Limits (µV/m)	Measurement Distance (m)
0.009 – 0.490	2400 / F (kHz)	300
0.490 – 1.705	24000 / F (kHz)	30
1.705 – 30.0	30	30
30 – 88	100**	3
88 - 216	150**	3
216 – 960	200**	3
Above 960	500	3

** Except as provided in paragraph (g), fundamental emissions from intentional radiators operating under this section shall not be located in the frequency bands 54-72 MHz, 76-88 MHz, 174-216 MHz or 470-806 MHz. However, operation within these frequency bands is permitted under other sections of this part, e.g. §§ 15.231 and 15.241.

§15.209 (b) In the emission table above, the tighter limit applies at the band edges.

Formula for converting the filed strength from uV/m to dBuV/m is:

Limit (dBuV/m) = 20 log limit (uV/m)

In addition:

§15.209 (d) The emission limits shown the above table are based on measurements employing a CISPR quasi-peak detector except for the frequency bands 9-90 kHz, 110-490 kHz and above 1000 MHz. Radiated emissions limits in these three bands are based on measurements employing an average detector.

§15.209 (d) The provisions in §§ 15.225, measuring emissions at distances other than the distances specified in the above table, determining the frequency range over which radiated emissions are to be measured, and limiting peak emissions apply to all devices operated under this part.

TEST PROCEDURE

ANSI C63.10, 2013

The EUT is an intentional radiator that incorporates a digital device, the highest fundamental frequency generated or used in the device is 13.56 MHz; therefore, the frequency range was investigated from 0.15 MHz to the 10th harmonic of the highest fundamental frequency, or 1000 MHz, whichever is greater.

For below 30MHz testing, investigation was done on three antenna orientations (parallel, perpendicular, and ground-parallel), parallel and perpendicular are the worst orientations, therefore testing was performed on these two orientations only.

KDB 414788 Open Field Site(OFS) and Chamber Correlation Justification

Base on FCC 15.31 (f) (2): measurements may be performed at a distance closer than that specified in the regulations; however, an attempt should be made to avoid making measurements in the near field.

OFS and chamber correlation testing had been performed and chamber measured test result is the worst case test result.

RESULTS

8.2. FUNDAMENTAL AND SPURIOUS EMISSIONS (0.15 - 30 MHz), EUT WITH AC/DC ADAPTER

8.2.1. CARD MODE WITH HOLSTER

FUNDAMENTAL

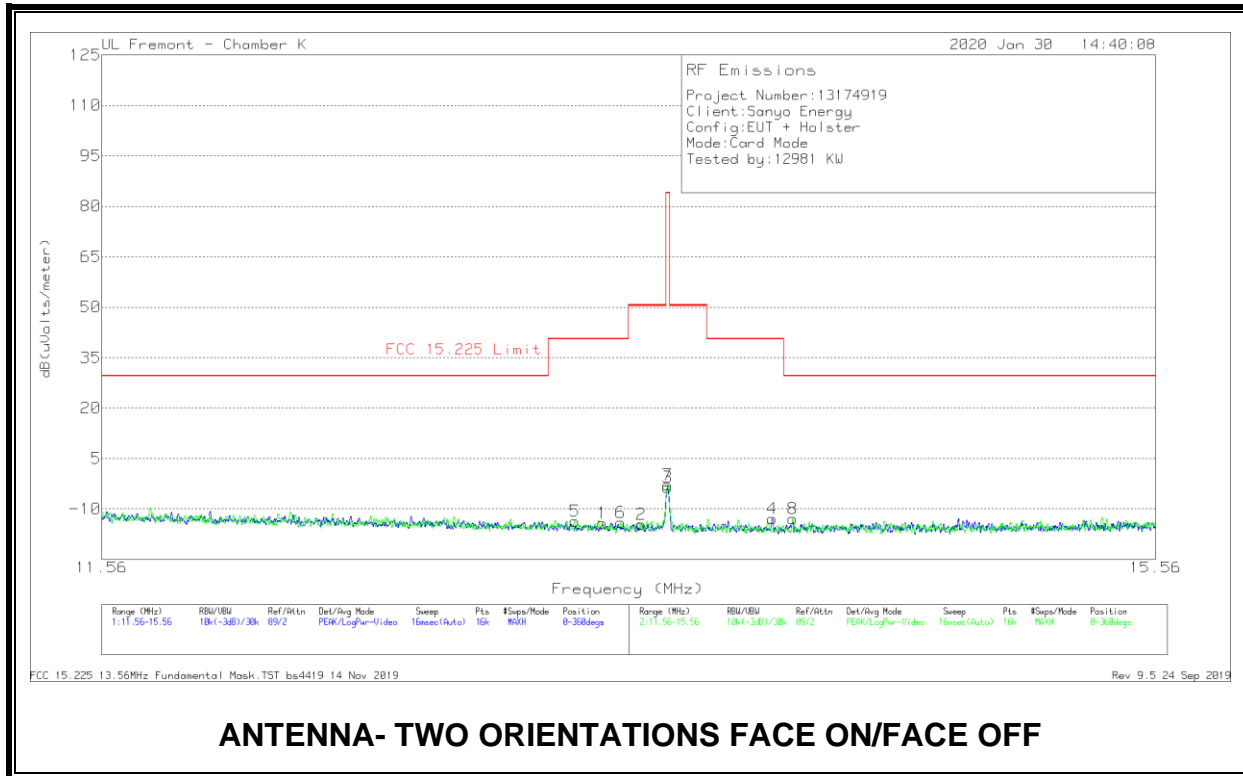

Trace Markers

Marker	Frequency (MHz)	Meter Reading (dBuV)	Det	Loop Antenna (dB/m)	Cables (dB)	Dist Corr 30m (dB) 40Log	Corrected Reading (dBuV/m)	FCC 15.225 Limit	PK Margin (dB)	Azimuth (Degs)
1	13.31338	10.54	Pk	14.8	.4	-40	-14.26	40.51	-54.77	0-360
2	13.45925	10.18	Pk	14.8	.4	-40	-14.62	50.5	-65.12	0-360
3	13.5595	21.19	Pk	14.8	.4	-40	-3.61	84	-87.61	0-360
4	13.96663	12.04	Pk	14.7	.4	-40	-12.86	40.51	-53.37	0-360
5	13.20975	-13.28	Pk	14.9	.4	-40	-37.98	40.51	-78.49	0-360
6	13.38225	10.82	Pk	14.8	.4	-40	-13.98	40.51	-54.49	0-360
7	13.56025	21.99	Pk	14.8	.4	-40	-2.81	84	-86.81	0-360
8	14.04825	12.03	Pk	14.7	.4	-40	-12.87	29.54	-42.41	0-360

Pk - Peak detector

SPURIOUS EMISSION (0.09 – 30MHz)

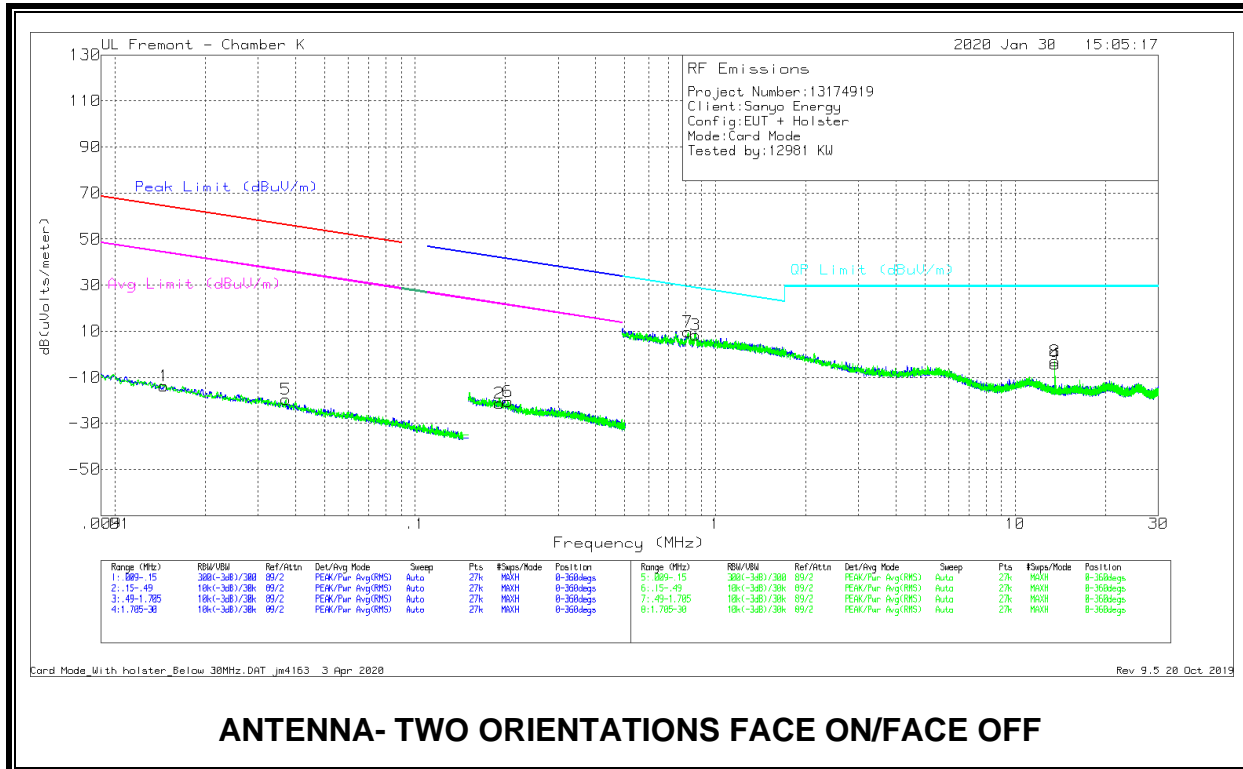

Trace Markers

Marker	Frequency (MHz)	Meter Reading (dBuV)	Det	Loop Antenna (dB/m)	Cables (dB)	Dist Corr 30m	Corrected Reading (dBuV/m)	Peak Limit (dBuV/m)	Margin (dB)	Avg Limit (dBuV/m)	Margin (dB)	Peak Limit (dBuV/m)	Margin (dB)	Avg Limit (dBuV/m)	Margin (dB)	Azimuth (Degs)
1	.01456	51.13	Pk	15.1	0	-80	-13.77	64.32	-78.09	44.32	-58.09	-	-	-	-	0-360
2	.19093	44.57	Pk	14	.1	-80	-21.33	-	-	-	-	42	-63.33	22	-43.33	0-360
5	.03715	45.33	Pk	15.1	0	-80	-19.57	56.19	-75.76	36.19	-55.76	-	-	-	-	0-360
6	.20386	45.36	Pk	14	.1	-80	-20.54	-	-	-	-	41.43	-61.97	21.43	-41.97	0-360

Pk - Peak detector

Marker	Frequency (MHz)	Meter Reading (dBuV)	Det	Loop Antenna (dB/m)	Cables (dB)	Dist Corr 30m (dB)	Corrected Reading (dBuV/m)	QP Limit (dBuV/m)	Margin (dB)	Azimuth (Degs)
3	.85992	34.08	Pk	14.2	.1	-40	8.38	28.93	-20.55	0-360
4	13.55893	20.49	Pk	14.8	.4	-40	-4.31	29.5	-33.81	0-360
7	.81087	35.54	Pk	14.1	.1	-40	9.74	29.44	-19.7	0-360
8	13.55893	21.78	Pk	14.8	.4	-40	-3.02	29.5	-32.52	0-360

Pk - Peak detector

8.2.2. READER MODE WITH HOLSTER

FUNDAMENTAL

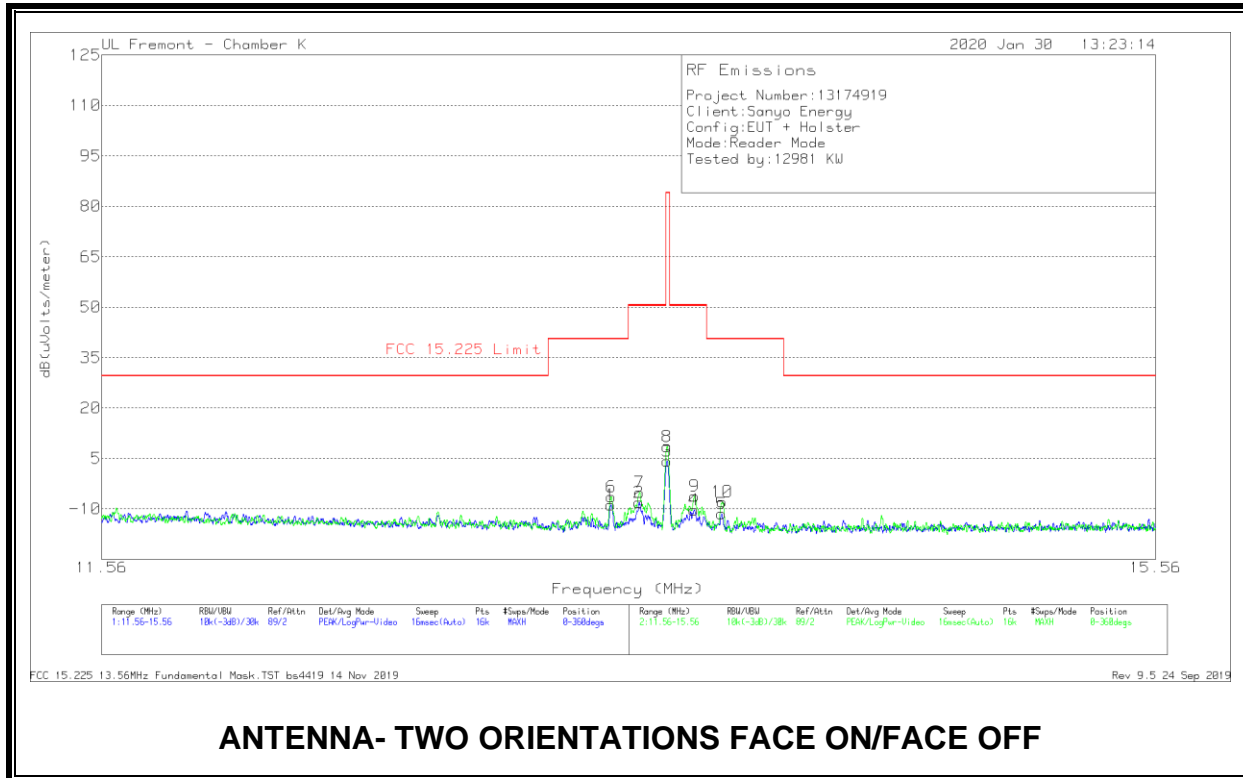

Trace Markers

Marker	Frequency (MHz)	Meter Reading (dBuV)	Det	Loop Antenna (dB/m)	Cables (dB)	Dist Corr 30m (dB) 40Log	Corrected Reading (dBuV/m)	FCC 15.225 Limit	PK Margin (dB)	Azimuth (Degs)
1	13.34513	16.07	Pk	14.8	.4	-40	-8.73	40.51	-49.24	0-360
2	13.45188	16.71	Pk	14.8	.4	-40	-8.09	50.5	-58.59	0-360
3	13.55813	29.07	Pk	14.8	.4	-40	4.27	84	-79.73	0-360
4	13.66238	14.57	Pk	14.8	.4	-40	-10.23	50.5	-60.73	0-360
5	13.76838	13.46	Pk	14.7	.4	-40	-11.44	40.51	-51.95	0-360
6	13.34625	18.45	Pk	14.8	.4	-40	-6.35	40.51	-46.86	0-360
7	13.45388	19.75	Pk	14.8	.4	-40	-5.05	50.5	-55.55	0-360
8	13.55813	33.38	Pk	14.8	.4	-40	8.58	84	-75.42	0-360
9	13.66338	18.63	Pk	14.8	.4	-40	-6.17	50.5	-56.67	0-360
10	13.77125	16.96	Pk	14.7	.4	-40	-7.94	40.51	-48.45	0-360

Pk - Peak detector

SPURIOUS EMISSION (0.09 – 30MHz)

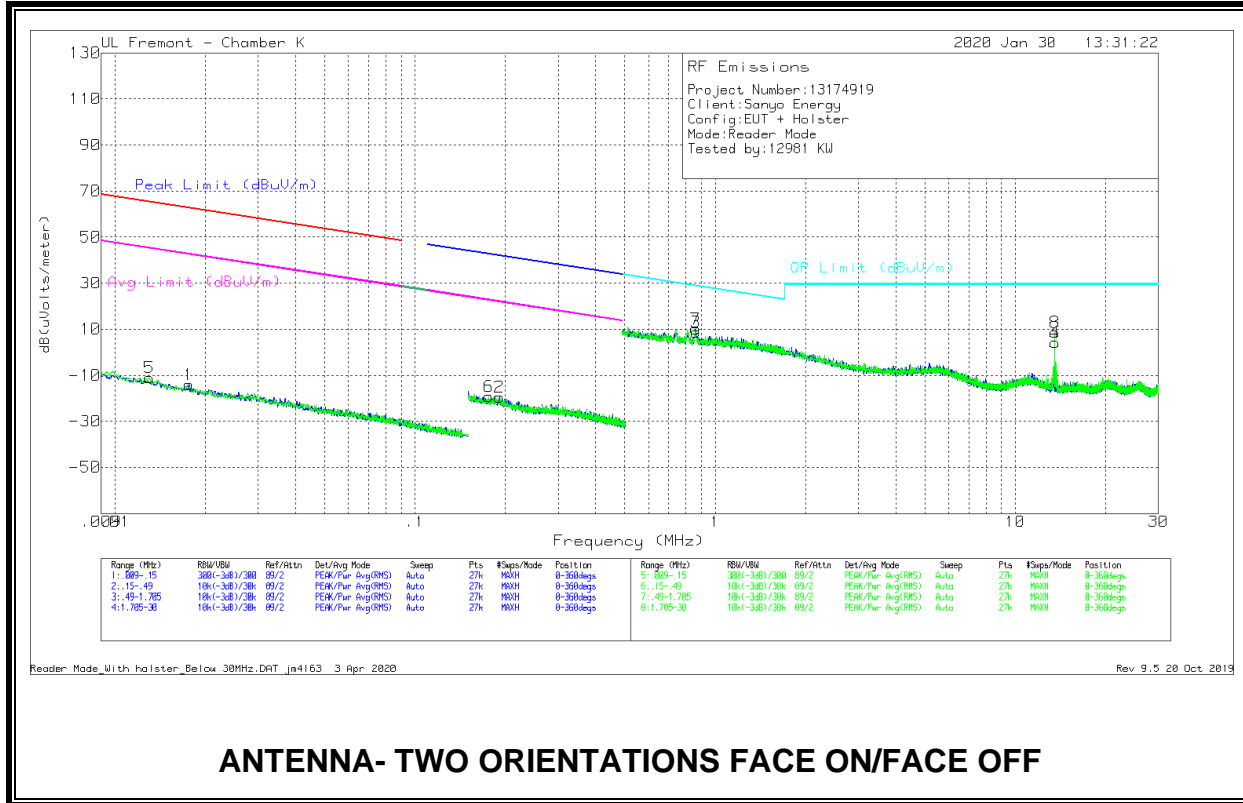

Trace Markers

Marker	Frequency (MHz)	Meter Reading (dBuV)	Det	Loop Antenna (dB/m)	Cables (dB)	Dist Corr 300m	Corrected Reading (dBuV/m)	Peak Limit (dBuV/m)	Margin (dB)	Avg Limit (dBuV/m)	Margin (dB)	Peak Limit (dBuV/m)	Margin (dB)	Avg Limit (dBuV/m)	Margin (dB)	Azimuth (Degs)
1	.01763	51.11	Pk	14.9	0	-80	-13.99	62.66	-76.65	42.66	-56.65	-	-	-	-	0-360
2	.1912	46.44	Pk	14	.1	-80	-19.46	-	-	-	-	41.99	-61.45	21.99	-41.45	0-360
5	.01301	53.68	Pk	15.2	0	-80	-11.12	65.3	-76.42	45.3	-56.42	-	-	-	-	0-360
6	.17591	46.65	Pk	14	.1	-80	-19.25	-	-	-	-	42.71	-61.96	22.71	-41.96	0-360

Pk - Peak detector

Marker	Frequency (MHz)	Meter Reading (dBuV)	Det	Loop Antenna (dB/m)	Cables (dB)	Dist Corr 30m (dB) 40Log	Corrected Reading (dBuV/m)	QP Limit (dBuV/m)	Margin (dB)	Azimuth (Degs)
3	.86283	34.53	Pk	14.2	.1	-40	8.83	28.9	-20.07	0-360
4	13.55683	28.96	Pk	14.8	.4	-40	4.16	29.5	-25.34	0-360
7	.86159	35.84	Pk	14.2	.1	-40	10.14	28.91	-18.77	0-360
8	13.55683	33.38	Pk	14.8	.4	-40	8.58	29.5	-20.92	0-360

Pk - Peak detector

8.2.3. READER MODE WITHOUT HOLSTER

FUNDAMENTAL

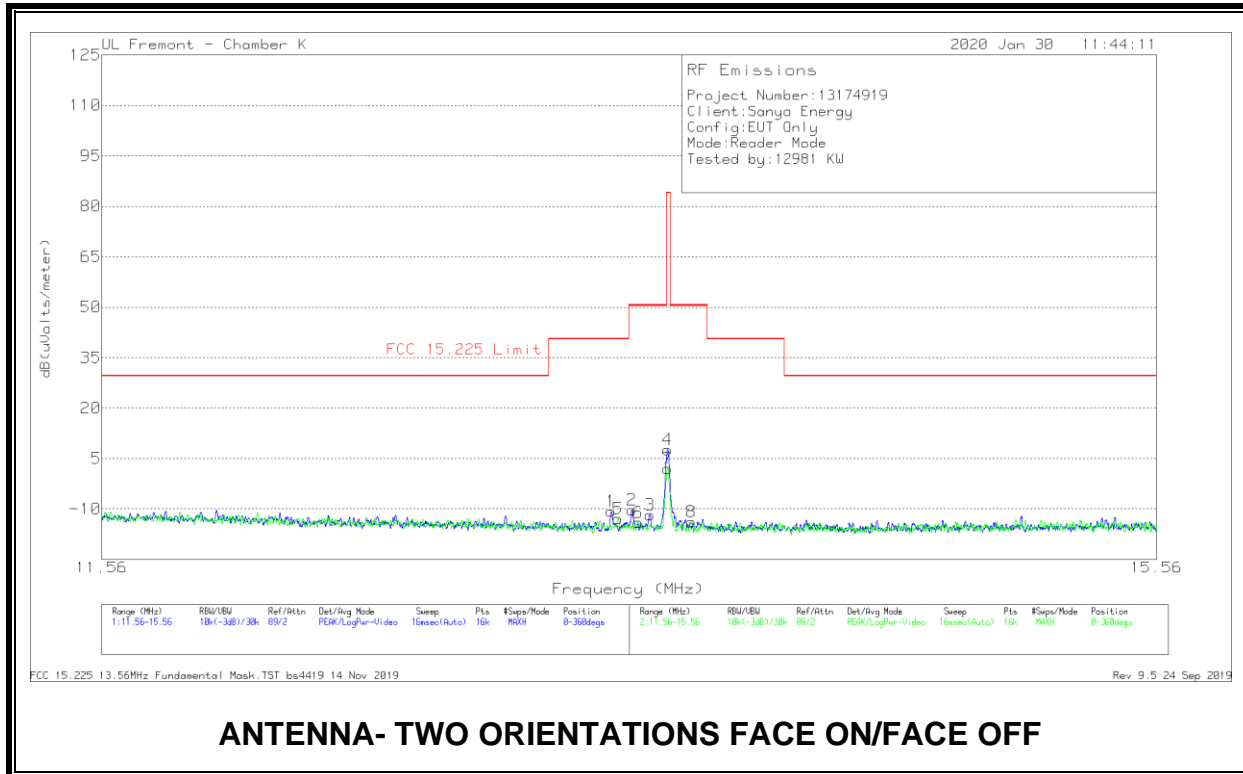

Trace Markers

Marker	Frequency (MHz)	Meter Reading (dBuV)	Det	Loop Antenna (dB/m)	Cables (dB)	Dist Corr 30m (dB) 40Log	Corrected Reading (dBuV/m)	FCC 15.225 Limit	PK Margin (dB)	Azimuth (Degs)
1	13.34475	14.09	Pk	14.8	.4	-40	-10.71	40.51	-51.22	0-360
2	13.42188	14.53	Pk	14.8	.4	-40	-10.27	50.5	-60.77	0-360
3	13.49013	12.94	Pk	14.8	.4	-40	-11.86	50.5	-62.36	0-360
4	13.55788	32.37	Pk	14.8	.4	-40	7.57	84	-76.43	0-360
5	13.37113	11.95	Pk	14.8	.4	-40	-12.85	40.51	-53.36	0-360
6	13.44638	10.81	Pk	14.8	.4	-40	-13.99	50.5	-64.49	0-360
7	13.55775	26.78	Pk	14.8	.4	-40	1.98	84	-82.02	0-360
8	13.64975	11	Pk	14.8	.4	-40	-13.8	50.5	-64.3	0-360

Pk - Peak detector

SPURIOUS EMISSION (0.09 – 30MHz)

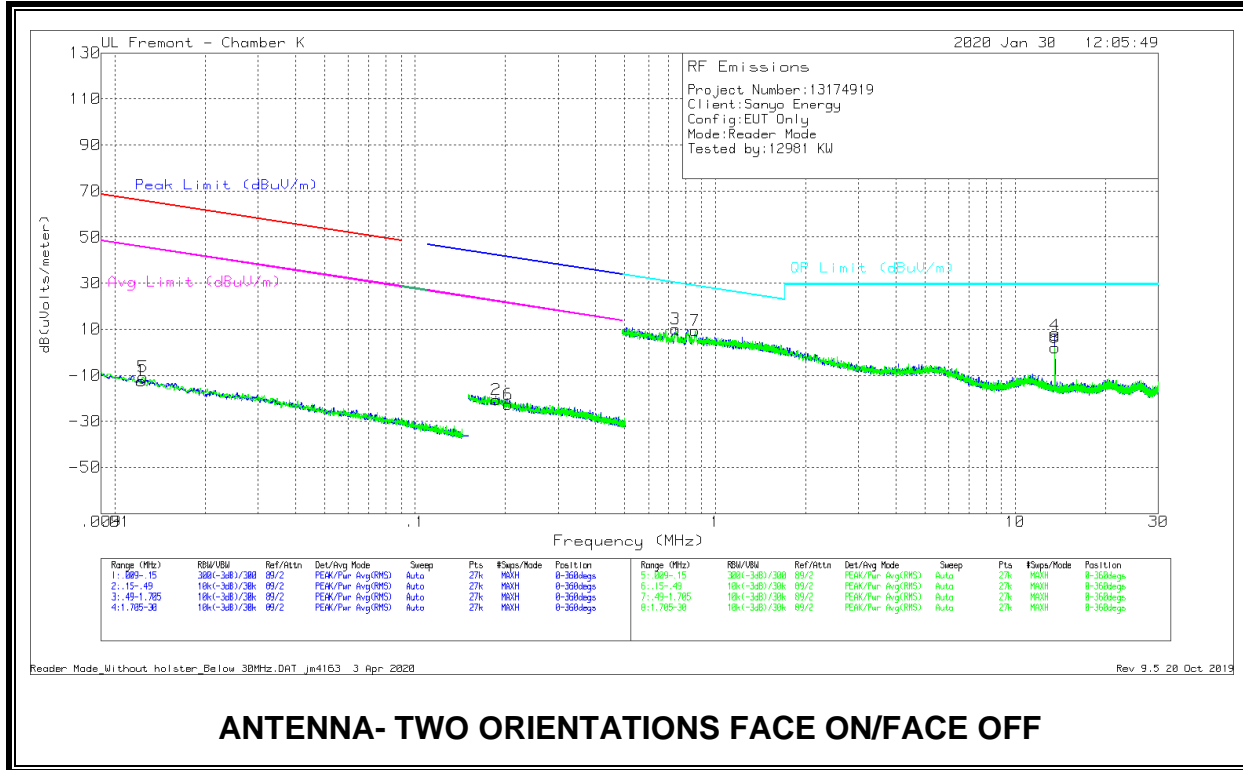

Trace Markers

Marker	Frequency (MHz)	Meter Reading (dBuV)	Det	Loop Antenna (dB/m)	Cables (dB)	Dist Corr 300m	Corrected Reading (dBuV/m)	Peak Limit (dBuV/m)	Margin (dB)	Avg Limit (dBuV/m)	Margin (dB)	QP Limit (dBuV/m)	Margin (dB)	Avg Limit (dBuV/m)	Margin (dB)	Azimuth (Degs)
1	.01225	52.35	Pk	15.2	0	-80	-12.45	65.82	-	45.82	-	-	-	-	-	0-360
2	.18645	45.32	Pk	14	.1	-80	-20.58	-	-	-	58.27	42.21	-	22.21	-	0-360
5	.01241	54.04	Pk	15.2	0	-80	-10.76	65.71	-	45.71	-	-	-	-	-	0-360
6	.2044	43.3	Pk	14	.1	-80	-22.6	-	-	-	56.47	41.41	-	21.41	-	0-360

Pk - Peak detector

Marker	Frequency (MHz)	Meter Reading (dBuV)	Det	Loop Antenna (dB/m)	Cables (dB)	Dist Corr 30m (dB) 40Log	Corrected Reading (dBuV/m)	QP Limit (dBuV/m)	Margin (dB)	Azimuth (Degs)
3	.73851	35.96	Pk	14.1	.1	-40	10.16	30.25	-20.09	0-360
4	13.55683	32.25	Pk	14.8	.4	-40	7.45	29.5	-22.05	0-360
7	.85875	35.1	Pk	14.2	.1	-40	9.4	28.94	-19.54	0-360
8	13.55683	26.8	Pk	14.8	.4	-40	2	29.5	-27.5	0-360

Pk - Peak detector

8.3. TX SPURIOUS EMISSION 30 TO 1000 MHz, EUT WITH AC/DC ADAPTER

8.3.1. CARD MODE WITH HOLSTER

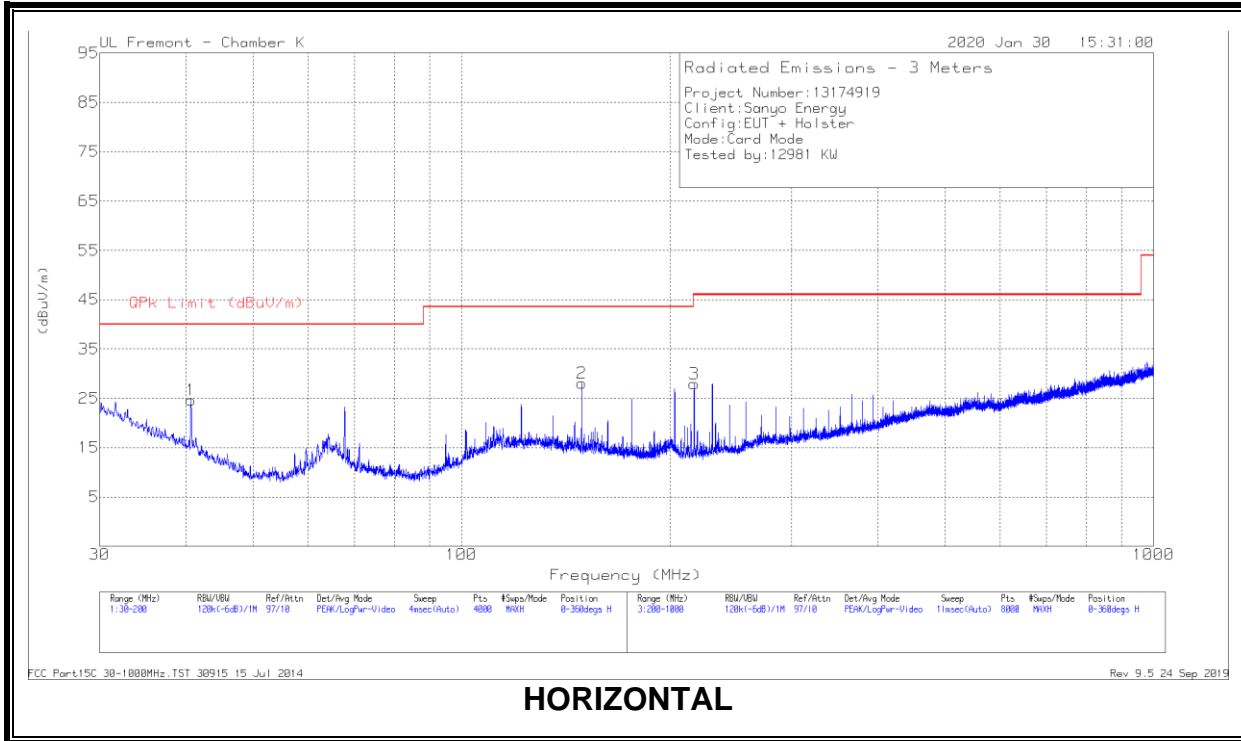

HORIZONTAL

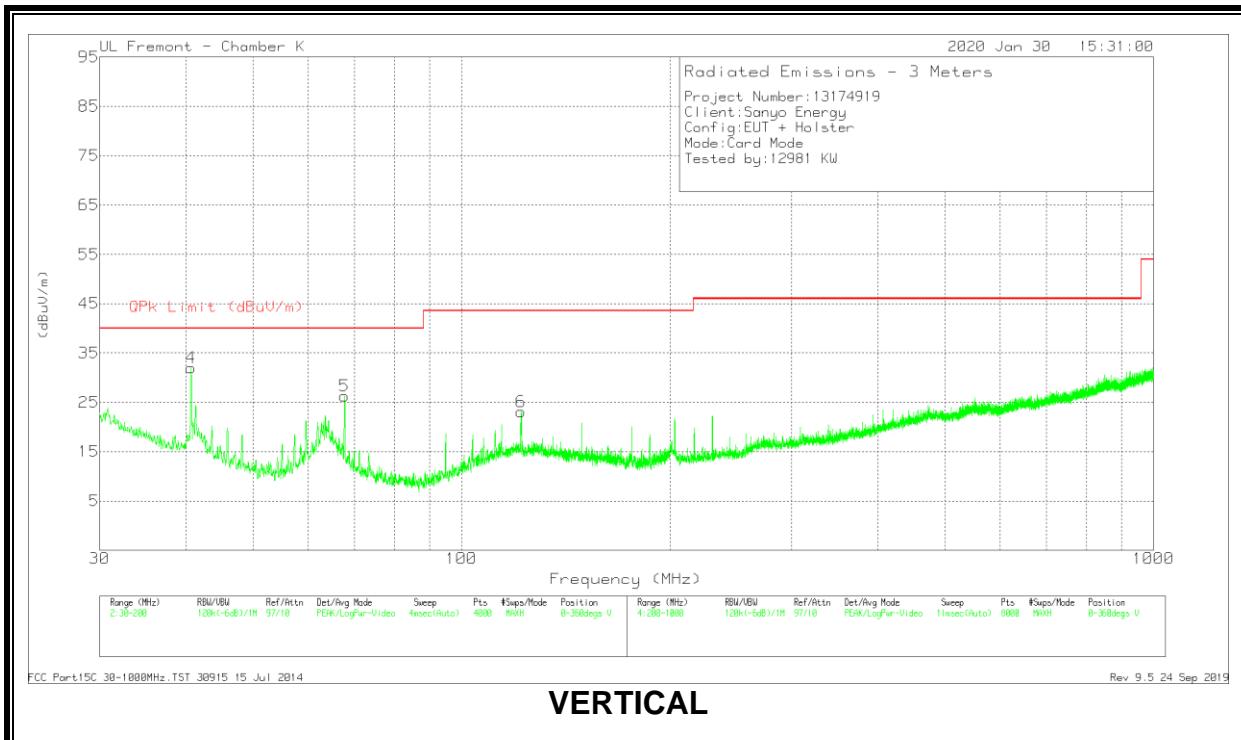

VERTICAL

Trace Markers

Marker	Frequency (MHz)	Meter Reading (dBuV)	Det	AF PRE0181574 (dB/m)	Amp/Cbl (dB)	Corrected Reading (dBuV/m)	QPk Limit (dBuV/m)	Margin (dB)	Azimuth (Degs)	Height (cm)	Polarity
1	40.6278	36.94	Pk	19.2	-31.5	24.64	40	-15.36	0-360	399	H
2	149.1583	40.23	Pk	18.4	-30.6	28.03	43.52	-15.49	0-360	199	H
4	40.6703	44.45	Pk	19.1	-31.5	32.05	40	-7.95	0-360	100	V
5	67.7923	43.51	Pk	14	-31.2	26.31	40	-13.69	0-360	100	V
6	* 122.0363	34.09	Pk	19.8	-30.8	23.09	43.52	-20.43	0-360	100	V
3	216.9022	41.71	Pk	16.5	-30.3	27.91	46.02	-18.11	0-360	100	H

* - indicates frequency in CFR47 Pt 15 / IC RSS-Restricted Band

Pk - Peak detector

Radiated Emissions

Frequency (MHz)	Meter Reading (dBuV)	Det	AF PRE0181574 (dB/m)	Amp/Cbl (dB)	Corrected Reading (dBuV/m)	QPk Limit (dBuV/m)	Margin (dB)	Azimuth (Degs)	Height (cm)	Polarity
40.6828	45.53	Pk	19.1	-31.5	33.13	40	-6.87	61	96	V
40.6828	43.88	Qp	19.1	-31.5	31.48	40	-8.52	61	96	V

* - indicates frequency in CFR47 Pt 15 / IC RSS-Restricted Band

Pk - Peak detector

Qp - Quasi-Peak detector

8.3.2. READER MODE WITH HOLSTER

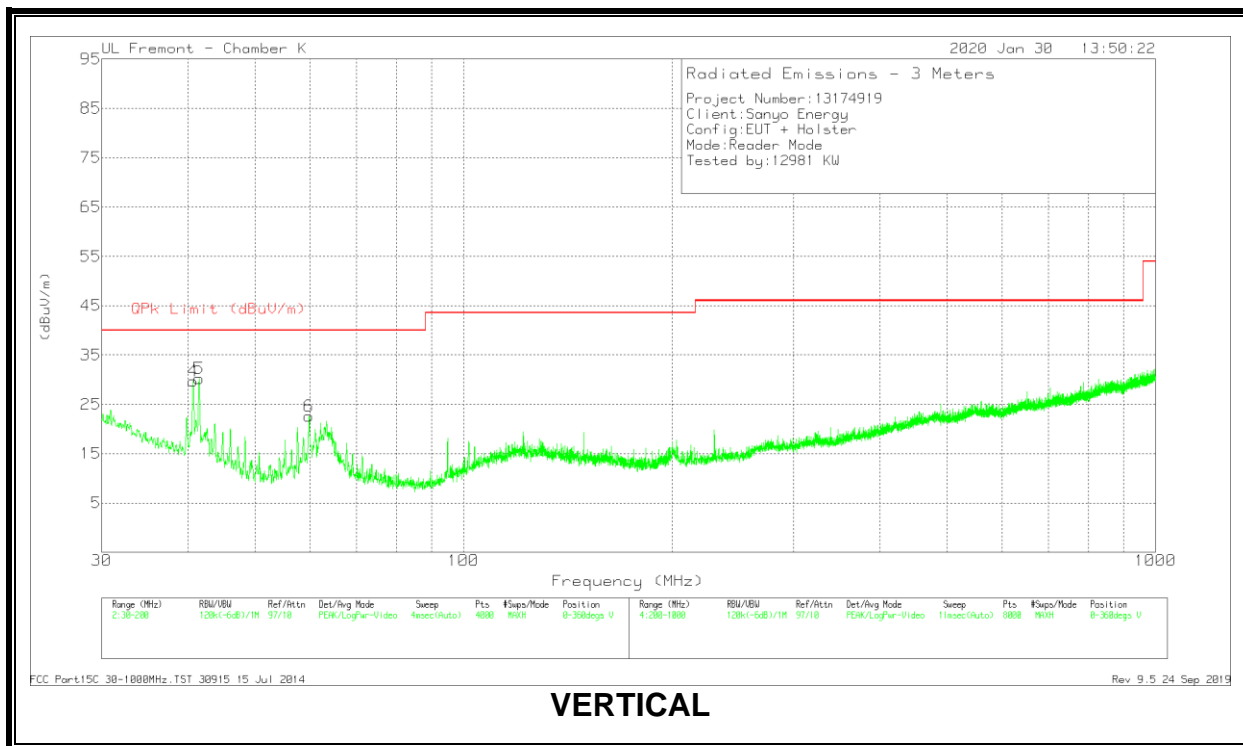
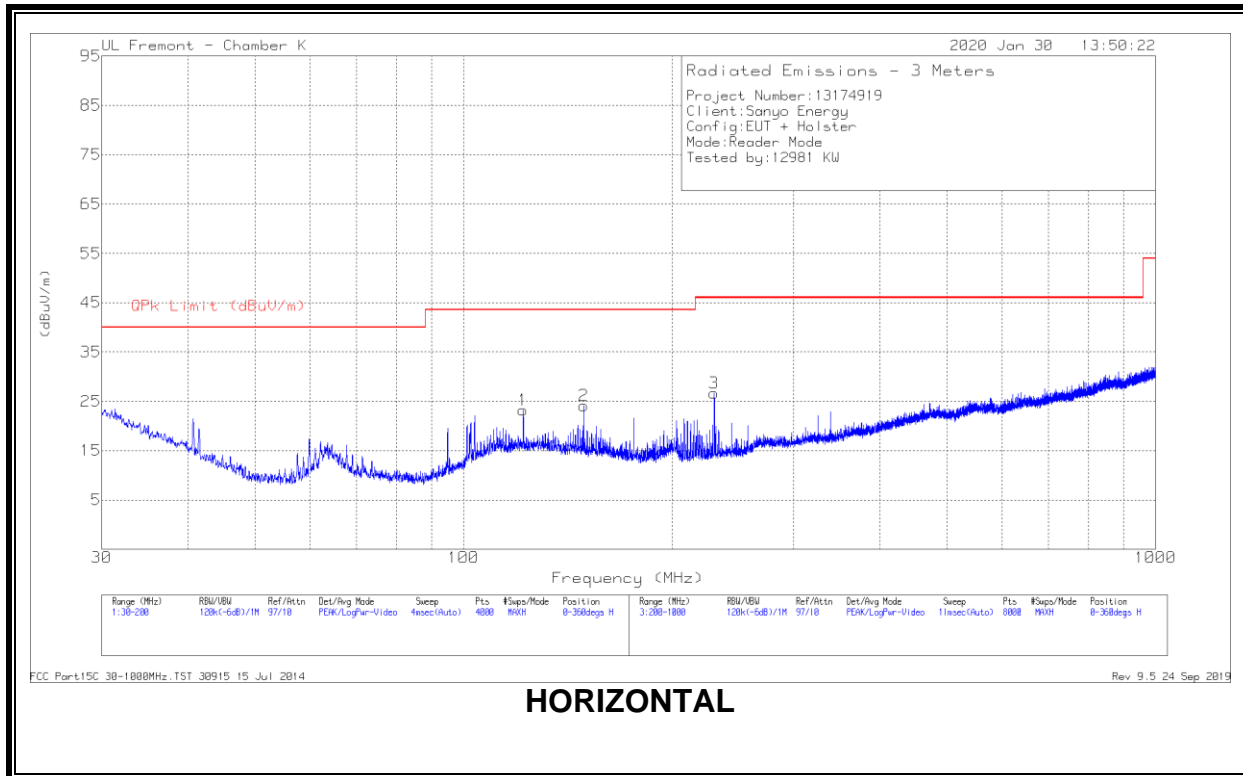

Trace Markers

Marker	Frequency (MHz)	Meter Reading (dBuV)	Det	AF PRE0181574 (dB/m)	Amp/Cbl (dB)	Corrected Reading (dBuV/m)	QPk Limit (dBuV/m)	Margin (dB)	Azimuth (Degs)	Height (cm)	Polarity
1	* 121.9938	34.23	Pk	19.8	-30.8	23.23	43.52	-20.29	0-360	199	H
2	149.1158	36.32	Pk	18.4	-30.6	24.12	43.52	-19.4	0-360	199	H
4	40.6703	42.12	Pk	19.1	-31.5	29.72	40	-10.28	0-360	100	V
5	41.478	43.05	Pk	18.6	-31.4	30.25	40	-9.75	0-360	100	V
6	59.8427	40.43	Pk	13.4	-31.2	22.63	40	-17.37	0-360	100	V
3	230.404	39.93	Pk	17	-30.2	26.73	46.02	-19.29	0-360	100	H

* - indicates frequency in CFR47 Pt 15 / IC RSS-Restricted Band
 Pk - Peak detector

Radiated Emissions

Frequency (MHz)	Meter Reading (dBuV)	Det	AF PRE0181574 (dB/m)	Amp/Cbl (dB)	Corrected Reading (dBuV/m)	QPk Limit (dBuV/m)	Margin (dB)	Azimuth (Degs)	Height (cm)	Polarity
41.514	44.71	Pk	18.5	-31.4	31.81	40	-8.19	58	102	V
41.514	39.95	Qp	18.5	-31.4	27.05	40	-12.95	58	102	V

* - indicates frequency in CFR47 Pt 15 / IC RSS-Restricted Band
 Pk - Peak detector
 Qp - Quasi-Peak detector

8.3.3. READER MODE WITHOUT HOLSTER

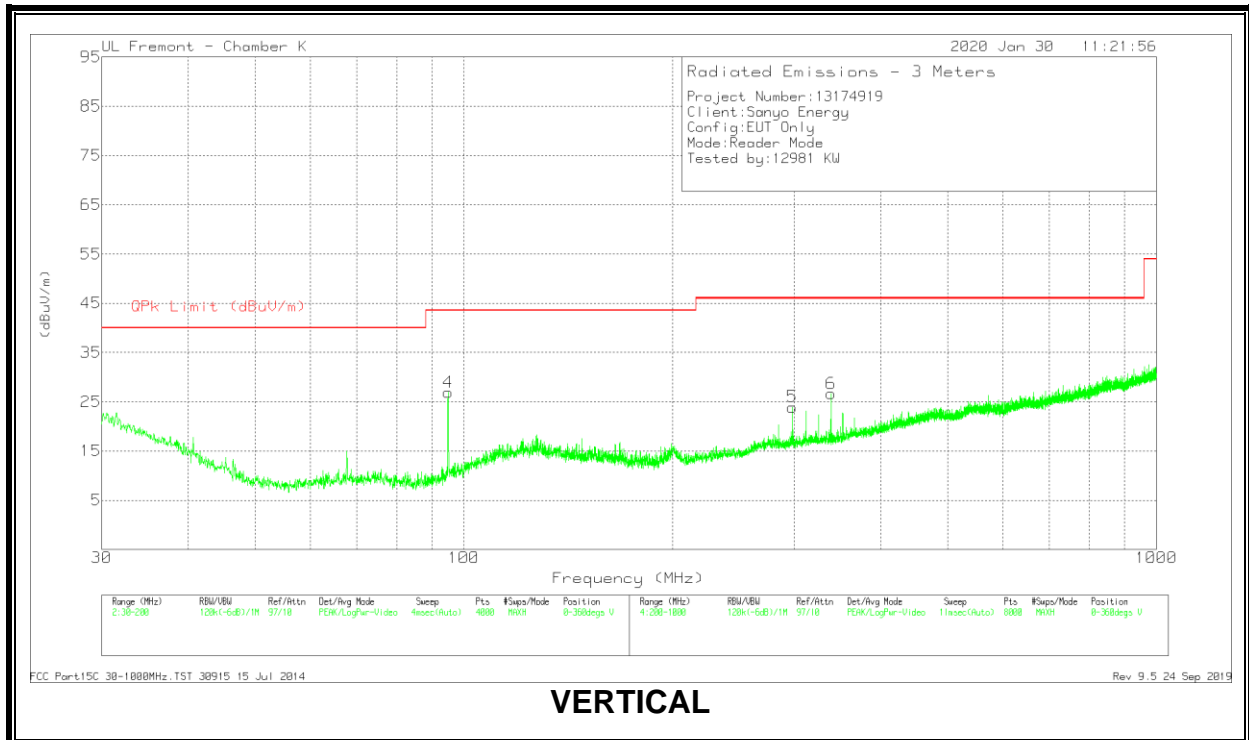
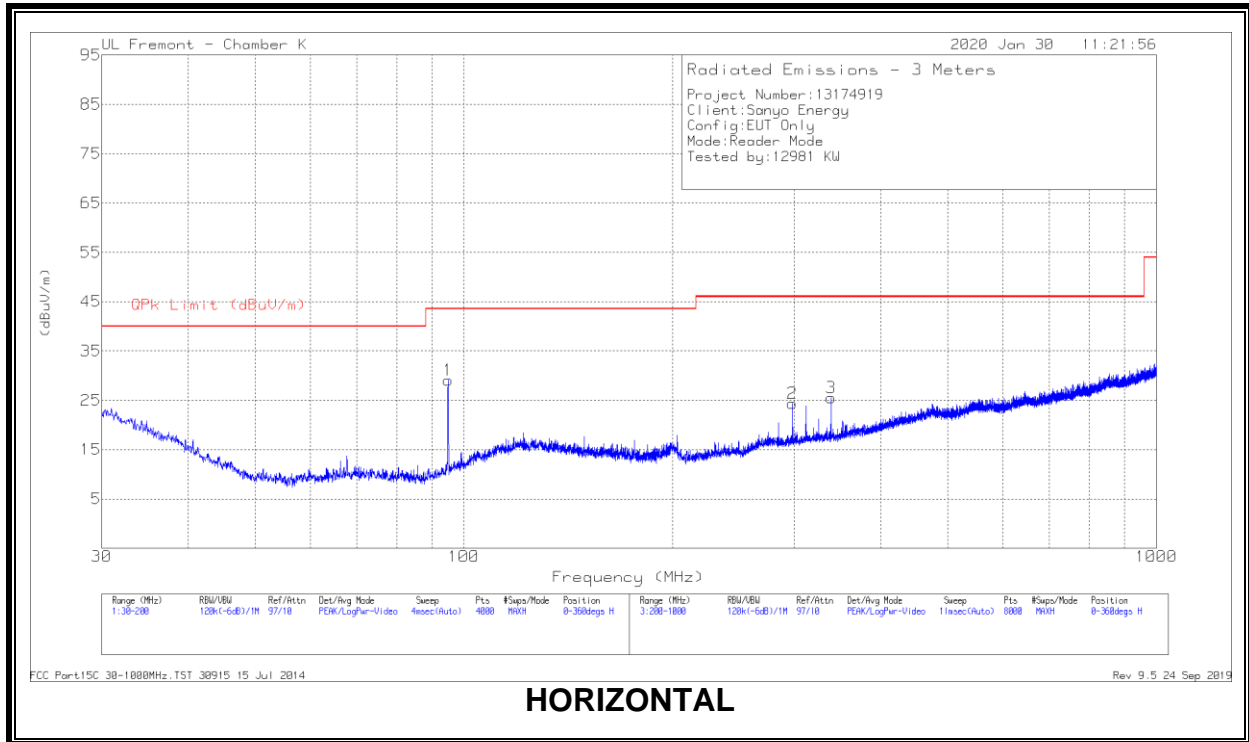

Trace Markers

Marker	Frequency (MHz)	Meter Reading (dBuV)	Det	AF PRE0181574 (dB/m)	Amp/Cbl (dB)	Corrected Reading (dBuV/m)	QPk Limit (dBuV/m)	Margin (dB)	Azimuth (Degs)	Height (cm)	Polarity
1	94.8718	45.14	Pk	14.8	-30.9	29.04	43.52	-14.48	0-360	199	H
4	94.8718	42.98	Pk	14.8	-30.9	26.88	43.52	-16.64	0-360	100	V
2	298.2128	35.09	Pk	19.2	-29.9	24.39	46.02	-21.63	0-360	101	H
3	338.9181	35.39	Pk	19.8	-29.7	25.49	46.02	-20.53	0-360	101	H
5	298.2128	34.64	Pk	19.2	-29.9	23.94	46.02	-22.08	0-360	199	V
6	338.9181	36.58	Pk	19.8	-29.7	26.68	46.02	-19.34	0-360	199	V

Pk - Peak detector

Radiated Emissions

Frequency (MHz)	Meter Reading (dBuV)	Det	AF PRE0181574 (dB/m)	Amp/Cbl (dB)	Corrected Reading (dBuV/m)	QPk Limit (dBuV/m)	Margin (dB)	Azimuth (Degs)	Height (cm)	Polarity
94.9116	45.71	Pk	14.8	-30.9	29.61	43.52	-13.91	288	185	H
94.9116	44.54	Qp	14.8	-30.9	28.44	43.52	-15.08	288	185	H

Pk - Peak detector

Qp - Quasi-Peak detector

9. FREQUENCY STABILITY

LIMIT

§15.225 (e) The frequency tolerance of the carrier signal shall be maintained within $\pm 0.01\%$ of the operating frequency, over a temperature variation of -20 degrees to +50 degrees C at normal supply voltage, and for a variation in the primary supply voltage from 85% to 115% of the rated supply voltage at a temperature of 20 degrees C. For battery operated equipment, the equipment tests shall be performed using a new battery.

TEST PROCEDURE

ANSI C63.10-2013 Clause 6.8

RESULTS

No non-compliance noted.

READER MODE WITH HOLSTER (WORST CASE)

ID:	12981 KW	Date:	2/4/2020
------------	----------	--------------	----------

No non-compliance noted.

Reference Frequency: EUT Channel 13.56 MHz @ 20°C										
Limit: ± 100 ppm = 1.356 kHz										
Power Supply	Envir. Temp	Frequency Deviation Measured with Time Elapse								
(Vdc)	(°C)	Startup (MHz)	Delta (ppm)	@ 2 mins (MHz)	Delta (ppm)	@ 5 mins (MHz)	Delta (ppm)	@ 10 mins (MHz)	Delta (ppm)	Limit (ppm)
36.00	50	13.5593443	-0.478	13.5593403	-0.179	13.5593528	-1.098	13.5593260	0.873	± 100
36.00	40	13.5593516	-1.013	13.5593172	1.528	13.5593221	1.162	13.5593489	-0.815	± 100
36.00	30	13.5593975	-4.396	13.5593887	-3.747	13.5593426	-0.348	13.5592864	3.792	± 100
36.00	20	13.5593379	0.000	13.5593429	-0.371	13.5593680	-2.219	13.5593670	-2.146	± 100
36.00	10	13.5593937	-4.119	13.5593788	-3.016	13.5594143	-5.637	13.5594062	-5.037	± 100
36.00	0	13.5594258	-6.484	13.5593688	-2.278	13.5594053	-4.974	13.5593632	-1.865	± 100
36.00	-10	13.5593841	-3.412	13.5593899	-3.841	13.5594317	-6.923	13.5594119	-5.458	± 100
30.60	20	13.5593633	-1.875	13.5593723	-2.539	13.5593370	0.067	13.5593176	1.498	± 100
41.4	20	13.5593448	-0.508	13.5593401	-0.166	13.5593631	-1.861	13.5593381	-0.017	± 100