

Report No.: SEWM2309000380RG04
 Rev.: 01
 Page: 1 of 112

TEST REPORT

Application No.: SEWM2309000380RG
Applicant: Wuxi iData Technology Company Ltd.
Address of Applicant: Floor 11, Building B1, Wuxi Binhu National Sensing Information Center, No.999 Gaolang East Road, Wuxi, China
Manufacturer: Wuxi iData Technology Company Ltd.
Address of Manufacturer: Floor 11, Building B1, Wuxi Binhu National Sensing Information Center, No.999 Gaolang East Road, Wuxi, China
EUT Description: New Mobile Computer
Model No.: iData T3 Pro
Trade Mark: iData
FCC ID: 2ADE3IDATAT3PRO
Standards: FCC 47 CFR Part 2, Subpart J
 FCC 47 CFR Part 15, Subpart C
Date of Receipt: 2023/10/23
Date of Test: 2023/10/31 to 2023/12/10
Date of Issue: 2024/01/12

Test Result :	PASS *
----------------------	---------------

* In the configuration tested, the EUT detailed in this report complied with the standards specified above.

Authorized Signature:

Well Wei
 Wireless Laboratory Manager



Unless otherwise agreed in writing, this document is issued by the Company subject to its General Conditions of Service printed overleaf, available on request or accessible at <http://www.sgs.com/en/Terms-and-Conditions.aspx> and, for electronic format documents, subject to Terms and Conditions for Electronic Documents at <http://www.sgs.com/en/Terms-and-Conditions/Terms-e-Document.aspx>. Attention is drawn to the limitation of liability, indemnification and jurisdiction issues defined therein. Any holder of this document is advised that information contained hereon reflects the Company's findings at the time of its intervention only and within the limits of Client's instructions, if any. The Company's sole responsibility is to its Client and this document does not exonerate parties to a transaction from exercising all their rights and obligations under the transaction documents. This document cannot be reproduced except in full, without prior written approval of the Company. Any unauthorized alteration, forgery or falsification of the content or appearance of this document is unlawful and offenders may be prosecuted to the fullest extent of the law. Unless otherwise stated the results shown in this test report refer only to the sample(s) tested and such sample(s) are retained for 30 days only.
 Attention: To check the authenticity of testing/inspection report & certificate, please contact us at telephone: (86-755) 8307 1443, or email: CN.Doccheck@sgs.com
 South of No. 6 Plant, No. 1, Runsheng Road, Suzhou Industrial Park, Suzhou Area, China (Jiangsu) Pilot Free Trade Zone 215000 t (86-512) 62992980 www.sgs.com.cn
 中国·苏州·中国(江苏)自由贸易试验区苏州片区苏州工业园区润胜路1号的6号厂房南楼 邮编: 215000 t (86-512) 62992980 sgs.china@sgs.com

Report No.: SEWM2309000380RG04

Rev.: 01

Page: 2 of 112

1 Version

Revision Record				
Version	Chapter	Date	Modifier	Remark
01		2024/01/12		Original

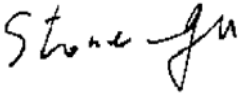
Prepared By		 <hr/> (Ives Cheng) / Test Engineer
Checked By		 <hr/> (Stone Gu) / Reviewer



Unless otherwise agreed in writing, this document is issued by the Company subject to its General Conditions of Service printed overleaf, available on request or accessible at <http://www.sgs.com/en/Terms-and-Conditions.aspx> and, for electronic format documents, subject to Terms and Conditions for Electronic Documents at <http://www.sgs.com/en/Terms-and-Conditions/Terms-e-Document.aspx>. Attention is drawn to the limitation of liability, indemnification and jurisdiction issues defined therein. Any holder of this document is advised that information contained hereon reflects the Company's findings at the time of its intervention only and within the limits of Client's instructions, if any. The Company's sole responsibility is to its Client and this document does not exonerate parties to a transaction from exercising all their rights and obligations under the transaction documents. This document cannot be reproduced except in full, without prior written approval of the Company. Any unauthorized alteration, forgery or falsification of the content or appearance of this document is unlawful and offenders may be prosecuted to the fullest extent of the law. Unless otherwise stated the results shown in this test report refer only to the sample(s) tested and such sample(s) are retained for 30 days only.

Attention: To check the authenticity of testing/inspection report & certificate, please contact us at telephone: (86-755) 8307 1443, or email: CN.Doccheck@sgs.com

South of No. 6 Plant, No. 1, Runsheng Road, Suzhou Industrial Park, Suzhou Area, China (Jiangsu) Pilot Free Trade Zone 215000 t (86-512) 62992980 www.sgs.com.cn
 中国·苏州·中国(江苏)自由贸易试验区苏州片区苏州工业园区润胜路1号的6号厂房南楼 邮编: 215000 t (86-512) 62992980 sgs.china@sgs.com

2 Test Summary

Test Item	FCC Rule No.	Test Method	Test Result	Result
Antenna Requirement	15.203/15.247(b)	--	Clause 4.1	PASS
AC Power Line Conducted Emission	15.207	ANSI C63.10-2013 Section 6.2	Clause 4.2	PASS
Duty Cycle	--	ANSI C63.10-2013 Section 11.6	Clause 4.3	For Report Purpose
Conducted Output Power	15.247 (b)(3)	ANSI C63.10-2013 Section 11.9.1.3	Clause 4.4	PASS
DTS (6 dB) Bandwidth & 99% Occupied Bandwidth	15.247 (a)(2)	ANSI C63.10-2013 Section 11.8 Option 2 / 6.9.3	Clause 4.5	PASS
Power Spectral Density	15.247 (e)	ANSI C63.10-2013 Section 11.10.2	Clause 4.6	PASS
Band-edge for RF Conducted Emissions	15.247(d)	ANSI C63.10-2013 Section 11.11	Clause 4.7	PASS
RF Conducted Spurious Emissions	15.247(d)	ANSI C63.10-2013 Section 11.11	Clause 4.8	PASS
Radiated Spurious Emissions	15.247(d);15.205/15.209	ANSI C63.10-2013 Section 11.12	Clause 4.9	PASS
Restricted bands around fundamental frequency (Radiated Emission)	15.247(d);15.205/15.209	ANSI C63.10-2013 Section 11.12	Clause 4.10	PASS



Unless otherwise agreed in writing, this document is issued by the Company subject to its General Conditions of Service printed overleaf, available on request or accessible at <http://www.sgs.com/en/Terms-and-Conditions.aspx> and, for electronic format documents, subject to Terms and Conditions for Electronic Documents at <http://www.sgs.com/en/Terms-and-Conditions/Terms-e-Documents.aspx>. Attention is drawn to the limitation of liability, indemnification and jurisdiction issues defined therein. Any holder of this document is advised that information contained hereon reflects the Company's findings at the time of its intervention only and within the limits of Client's instructions, if any. The Company's sole responsibility is to its Client and this document does not exonerate parties to a transaction from exercising all their rights and obligations under the transaction documents. This document cannot be reproduced except in full, without prior written approval of the Company. Any unauthorized alteration, forgery or falsification of the content or appearance of this document is unlawful and offenders may be prosecuted to the fullest extent of the law. Unless otherwise stated the results shown in this test report refer only to the sample(s) tested and such sample(s) are retained for 30 days only.

Attention: To check the authenticity of testing/inspection report & certificate, please contact us at telephone: (86-755) 8307 1443, or email: CN.Doccheck@sgs.com

South of No. 6 Plant, No. 1, Runsheng Road, Suzhou Industrial Park, Suzhou Area, China (Jiangsu) Pilot Free Trade Zone 215000
中国·苏州·中国(江苏)自由贸易试验区苏州片区苏州工业园区润胜路1号的6号厂房南楼 邮编: 215000

t (86-512) 62992980 www.sgs.com.cn
t (86-512) 62992980 sgs.china@sgs.com

Contents

1	Version	2
2	Test Summary	3
3	General Information	5
3.1	Details of Client	5
3.2	Test Location	5
3.3	Test Facility	5
3.4	General Description of EUT	6
3.5	Test Environment and Mode	8
3.6	Description of Support Units	8
3.7	Worst-case configuration and mode	8
4	Test results and Measurement Data	9
4.1	Antenna Requirement	9
4.2	AC Power Line Conducted Emissions	10
4.3	Duty Cycle	14
4.4	Conducted Output Power	15
4.5	DTS (6 dB) Bandwidth & 99% Occupied Bandwidth	16
4.6	Power Spectral Density	17
4.7	Band-edge for RF Conducted Emissions	18
4.8	RF Conducted Spurious Emissions	19
4.9	Radiated Spurious Emissions	20
4.10	Restricted bands around fundamental frequency	23
5	Measurement Uncertainty (95% confidence levels, k=2)	26
6	Equipment List	27
7	Photographs - Setup Photos	29



Unless otherwise agreed in writing, this document is issued by the Company subject to its General Conditions of Service printed overleaf, available on request or accessible at <http://www.sgs.com/en/Terms-and-Conditions.aspx> and, for electronic format documents, subject to Terms and Conditions for Electronic Documents at <http://www.sgs.com/en/Terms-and-Conditions/Terms-e-Documents.aspx>. Attention is drawn to the limitation of liability, indemnification and jurisdiction issues defined therein. Any holder of this document is advised that information contained hereon reflects the Company's findings at the time of its intervention only and within the limits of Client's instructions, if any. The Company's sole responsibility is to its Client and this document does not exonerate parties to a transaction from exercising all their rights and obligations under the transaction documents. This document cannot be reproduced except in full, without prior written approval of the Company. Any unauthorized alteration, forgery or falsification of the content or appearance of this document is unlawful and offenders may be prosecuted to the fullest extent of the law. Unless otherwise stated the results shown in this test report refer only to the sample(s) tested and such sample(s) are retained for 30 days only.

Attention: To check the authenticity of testing/inspection report & certificate, please contact us at telephone: (86-755) 8307 1443, or email: CN.Doccheck@sgs.com

South of No. 6 Plant, No. 1, Runsheng Road, Suzhou Industrial Park, Suzhou Area, China (Jiangsu) Pilot Free Trade Zone 215000
 中国·苏州·中国(江苏)自由贸易试验区苏州片区苏州工业园区润胜路1号的6号厂房南楼 邮编: 215000

t (86-512) 62992980 www.sgs.com.cn
 t (86-512) 62992980 sgs.china@sgs.com

3 General Information

3.1 Details of Client

Applicant:	Wuxi iData Technology Company Ltd.
Address of Applicant:	Floor 11,Building B1.Wuxi Binhu National Sensing Information Center,No.999 Gaolang East Road,Wuxi,China
Manufacturer:	Wuxi iData Technology Company Ltd.
Address of Manufacturer:	Floor 11,Building B1.Wuxi Binhu National Sensing Information Center,No.999 Gaolang East Road,Wuxi,China

3.2 Test Location

Company:	SGS-CSTC Standards Technical Services (Suzhou) Co., Ltd.
Address:	South of No. 6 Plant, No. 1, Runsheng Road, Suzhou Industrial Park, Suzhou Area, China (Jiangsu) Pilot Free Trade Zone
Post code:	215000
Test engineer:	Ives Cheng, Tizzy Song

3.3 Test Facility

The test facility is recognized, certified, or accredited by the following organizations:

• A2LA (Certificate No. 6336.01)

SGS-CSTC STANDARDS TECHNICAL SERVICES (SUZHOU) CO., LTD. is accredited by the American Association for Laboratory Accreditation(A2LA). Certificate No. 6336.01.

• Innovation, Science and Economic Development Canada

SGS-CSTC STANDARDS TECHNICAL SERVICES (SUZHOU) CO., LTD. has been recognized by ISED as an accredited testing laboratory.

CAB identifier: CN0120.

IC#: 27594.

• FCC –Designation Number: CN1312

SGS-CSTC STANDARDS TECHNICAL SERVICES (SUZHOU) CO., LTD. has been recognized as an accredited testing laboratory.

Designation Number: CN1312.

Test Firm Registration Number: 717327



Unless otherwise agreed in writing, this document is issued by the Company subject to its General Conditions of Service printed overleaf, available on request or accessible at <http://www.sgs.com/en/Terms-and-Conditions.aspx> and, for electronic format documents, subject to Terms and Conditions for Electronic Documents at <http://www.sgs.com/en/Terms-and-Conditions/Terms-e-Documents.aspx>. Attention is drawn to the limitation of liability, indemnification and jurisdiction issues defined therein. Any holder of this document is advised that information contained hereon reflects the Company's findings at the time of its intervention only and within the limits of Client's instructions, if any. The Company's sole responsibility is to its Client and this document does not exonerate parties to a transaction from exercising all their rights and obligations under the transaction documents. This document cannot be reproduced except in full, without prior written approval of the Company. Any unauthorized alteration, forgery or falsification of the content or appearance of this document is unlawful and offenders may be prosecuted to the fullest extent of the law. Unless otherwise stated the results shown in this test report refer only to the sample(s) tested and such sample(s) are retained for 30 days only.

Attention: To check the authenticity of testing/inspection report & certificate, please contact us at telephone: (86-755) 8307 1443, or email: CN_Doccheck@sgs.com

South of No. 6 Plant, No. 1, Runsheng Road, Suzhou Industrial Park, Suzhou Area, China (Jiangsu) Pilot Free Trade Zone 215000 t (86-512) 62992980 www.sgs.com.cn
 中国·苏州·中国(江苏)自由贸易试验区苏州片区苏州工业园区海胜路1号的6号厂房南楼 邮编: 215000 t (86-512) 62992980 sgs.china@sgs.com

3.4 General Description of EUT

EUT Description:	New Mobile Computer	
Model No.:	iData T3 Pro	
Trade Mark:	iData	
Hardware Version:	H2110Z0-V06	
Software Version:	12.00.001	
Power Supply:	Lithium Battery (3.85V)	
IMEI:	RF Conducted	866185060736792(IMEI1)/866185065718035(IMEI2)
	RSE & AC power line	866185060737014(IMEI1)/866185065718258(IMEI2)
Operation Frequency:	802.11b/g/n(HT20):	2412MHz to 2462MHz
	802.11n(HT40):	2422MHz to 2452MHz
Modulation Type:	802.11b:	DSSS (DBPSK, DQPSK, CCK)
	802.11g/n:	OFDM (BPSK, QPSK, 16QAM, 64QAM)
Number of Channels:	802.11b/g/n(HT20): 11 802.11n(HT40): 7	
Channel Spacing:	5MHz	
Smart System:	<input checked="" type="checkbox"/> SISO	802.11b/g/n
	<input type="checkbox"/> MIMO	CDD: 802.11b/g/n: Tx & Rx
		STBC: 802.11n: Tx & Rx TXBF: 802.11n: Tx & Rx
	<input type="checkbox"/> Diversity	802.11b/g : Tx & Rx
Antenna Type:	PIFA Antenna	
Antenna Gain:	1.1dBi (Ant2)	
	Note: The antenna gain are derived from the gain information report provided by the manufacturer.	
RF Cable:	1.0dB	
Remark:	As above information is provided and confirmed by the applicant. SGS is not liable to the accuracy, suitability, reliability or/and integrity of the information.	



Unless otherwise agreed in writing, this document is issued by the Company subject to its General Conditions of Service printed overleaf, available on request or accessible at <http://www.sgs.com/en/Terms-and-Conditions.aspx> and, for electronic format documents, subject to Terms and Conditions for Electronic Documents at <http://www.sgs.com/en/Terms-and-Conditions/Terms-e-Documents.aspx>. Attention is drawn to the limitation of liability, indemnification and jurisdiction issues defined therein. Any holder of this document is advised that information contained hereon reflects the Company's findings at the time of its intervention only and within the limits of Client's instructions, if any. The Company's sole responsibility is to its Client and this document does not exonerate parties to a transaction from exercising all their rights and obligations under the transaction documents. This document cannot be reproduced except in full, without prior written approval of the Company. Any unauthorized alteration, forgery or falsification of the content or appearance of this document is unlawful and offenders may be prosecuted to the fullest extent of the law. Unless otherwise stated the results shown in this test report refer only to the sample(s) tested and such sample(s) are retained for 30 days only.
Attention: To check the authenticity of testing/inspection report & certificate, please contact us at telephone: (86-755) 8307 1443, or email: CN.Doccheck@sgs.com

South of No. 6 Plant, No. 1, Runsheng Road, Suzhou Industrial Park, Suzhou Area, China (Jiangsu) Pilot Free Trade Zone 215000
中国·苏州·中国(江苏)自由贸易试验区苏州片区苏州工业园区润胜路1号的6号厂房南楼 邮编: 215000

t (86-512) 62992980 www.sgs.com.cn
t (86-512) 62992980 sgs.china@sgs.com

Operation Frequency of each channel (802.11b/g/n HT20)							
Channel	Frequency	Channel	Frequency	Channel	Frequency	Channel	Frequency
1	2412MHz	4	2427MHz	7	2442MHz	10	2457MHz
2	2417MHz	5	2432MHz	8	2447MHz	11	2462MHz
3	2422MHz	6	2437MHz	9	2452MHz		
Operation Frequency of each channel (802.11n HT40)							
Channel	Frequency	Channel	Frequency	Channel	Frequency	Channel	Frequency
3	2422MHz	6	2437MHz	9	2452MHz		
4	2427MHz	7	2442MHz				
5	2432MHz	8	2447MHz				
Remark: In section 15.31(m), regards to the operating frequency range over 10 MHz, the Lowest frequency, the middle frequency, and the highest frequency of channel were selected to perform the test, and the selected channel see below:							
Channel	Frequency for 802.11 b/g/n (HT20)			Frequency for 802.11n (HT40)			
The Lowest channel	2412MHz			2422MHz			
The Middle channel	2437MHz			2437MHz			
The Highest channel	2462MHz			2452MHz			



Unless otherwise agreed in writing, this document is issued by the Company subject to its General Conditions of Service printed overleaf, available on request or accessible at <http://www.sgs.com/en/Terms-and-Conditions.aspx> and, for electronic format documents, subject to Terms and Conditions for Electronic Documents at <http://www.sgs.com/en/Terms-and-Conditions/Terms-e-Documents.aspx>. Attention is drawn to the limitation of liability, indemnification and jurisdiction issues defined therein. Any holder of this document is advised that information contained hereon reflects the Company's findings at the time of its intervention only and within the limits of Client's instructions, if any. The Company's sole responsibility is to its Client and this document does not exonerate parties to a transaction from exercising all their rights and obligations under the transaction documents. This document cannot be reproduced except in full, without prior written approval of the Company. Any unauthorized alteration, forgery or falsification of the content or appearance of this document is unlawful and offenders may be prosecuted to the fullest extent of the law. Unless otherwise stated the results shown in this test report refer only to the sample(s) tested and such sample(s) are retained for 30 days only.

Attention: To check the authenticity of testing/inspection report & certificate, please contact us at telephone: (86-755) 8307 1443, or email: CN.Doccheck@sgs.com

South of No. 6 Plant, No. 1, Runsheng Road, Suzhou Industrial Park, Suzhou Area, China (Jiangsu) Pilot Free Trade Zone 215000 t (86-512) 62992980 www.sgs.com.cn
 中国·苏州·中国(江苏)自由贸易试验区苏州片区工业园区润胜路1号的6号厂房南楼 邮编: 215000 t (86-512) 62992980 sgs.china@sgs.com

3.5 Test Environment and Mode

Environment Parameter	101.0 kPa Selected Values During Tests	
Relative Humidity	44-46 % RH Ambient	
Value	Temperature(°C)	Voltage(V)
NTNV	22~23	3.85
Remark: NV: Normal Voltage NT: Normal Temperature		

3.6 Description of Support Units

The EUT has been tested as an independent unit.

3.7 Worst-case configuration and mode

Low data rate was used to test on antenna port conducted tests and radiated spurious emissions since it has the highest maximum power. Following are the worst-case data rates set for test:

Modulation Type	SISO - Data Rate	MIMO - Data Rate
802.11b	1 Mbps	/
802.11g	6 Mbps	/
802.11n (HT 20)	MCS0 (6.5 Mbps)	/
802.11n (HT 40)	MCS0 (13.5 Mbps)	/



Unless otherwise agreed in writing, this document is issued by the Company subject to its General Conditions of Service printed overleaf, available on request or accessible at <http://www.sgs.com/en/Terms-and-Conditions.aspx> and, for electronic format documents, subject to Terms and Conditions for Electronic Documents at <http://www.sgs.com/en/Terms-and-Conditions/Terms-e-Document.aspx>. Attention is drawn to the limitation of liability, indemnification and jurisdiction issues defined therein. Any holder of this document is advised that information contained hereon reflects the Company's findings at the time of its intervention only and within the limits of Client's instructions, if any. The Company's sole responsibility is to its Client and this document does not exonerate parties to a transaction from exercising all their rights and obligations under the transaction documents. This document cannot be reproduced except in full, without prior written approval of the Company. Any unauthorized alteration, forgery or falsification of the content or appearance of this document is unlawful and offenders may be prosecuted to the fullest extent of the law. Unless otherwise stated the results shown in this test report refer only to the sample(s) tested and such sample(s) are retained for 30 days only.
 Attention: To check the authenticity of testing/inspection report & certificate, please contact us at telephone: (86-755) 8307 1443, or email: CN.Doccheck@sgs.com

South of No. 6 Plant, No. 1, Runsheng Road, Suzhou Industrial Park, Suzhou Area, China (Jiangsu) Pilot Free Trade Zone 215000 t (86-512) 62992980 www.sgs.com.cn
 中国·苏州·中国(江苏)自由贸易试验区苏州片区苏州工业园区润胜路1号的6号厂房南楼 邮编: 215000 t (86-512) 62992980 sgs.china@sgs.com

4 Test results and Measurement Data

4.1 Antenna Requirement

Standard requirement:	47 CFR Part 15C Section 15.203 /247(b)
<p>15.203 requirement: An intentional radiator shall be designed to ensure that no antenna other than that furnished by the responsible party shall be used with the device. The use of a permanently attached antenna or of an antenna that uses a unique coupling to the intentional radiator, the manufacturer may design the unit so that a broken antenna can be replaced by the user, but the use of a standard antenna jack or electrical connector is prohibited.</p> <p>15.247(b) (4) requirement: The conducted output power limit specified in paragraph (b) of this section is based on the use of antennas with directional gains that do not exceed 6 dBi. Except as shown in paragraph (c) of this section, if transmitting antennas of directional gain greater than 6 dBi are used, the conducted output power from the intentional radiator shall be reduced below the stated values in paragraphs (b)(1), (b)(2), and (b)(3) of this section, as appropriate, by the amount in dB that the directional gain of the antenna exceeds 6 dBi.</p>	
<p>The antenna is PIFA Antenna and no consideration of replacement. The best case gain of the antenna is 1.1dBi (Ant2);*</p> <p><i>*Note: The antenna gain are derived from the gain information report provided by the manufacturer.</i></p> <p><i>Remark: As above information is provided and confirmed by the applicant. SGS is not liable to the accuracy, suitability, reliability or/and integrity of the information.</i></p>	



Unless otherwise agreed in writing, this document is issued by the Company subject to its General Conditions of Service printed overleaf, available on request or accessible at <http://www.sgs.com/en/Terms-and-Conditions.aspx> and, for electronic format documents, subject to Terms and Conditions for Electronic Documents at <http://www.sgs.com/en/Terms-and-Conditions/Terms-e-Documents.aspx>. Attention is drawn to the limitation of liability, indemnification and jurisdiction issues defined therein. Any holder of this document is advised that information contained hereon reflects the Company's findings at the time of its intervention only and within the limits of Client's instructions, if any. The Company's sole responsibility is to its Client and this document does not exonerate parties to a transaction from exercising all their rights and obligations under the transaction documents. This document cannot be reproduced except in full, without prior written approval of the Company. Any unauthorized alteration, forgery or falsification of the content or appearance of this document is unlawful and offenders may be prosecuted to the fullest extent of the law. Unless otherwise stated the results shown in this test report refer only to the sample(s) tested and such sample(s) are retained for 30 days only.

Attention: To check the authenticity of testing/inspection report & certificate, please contact us at telephone: (86-755) 8307 1443, or email: CN.Doccheck@sgs.com

South of No. 6 Plant, No. 1, Runsheng Road, Suzhou Industrial Park, Suzhou Area, China (Jiangsu) Pilot Free Trade Zone 215000 t (86-512) 62992980 www.sgs.com.cn
 中国·苏州·中国(江苏)自由贸易试验区苏州片区苏州工业园区润胜路1号的6号厂房南楼 邮编: 215000 t (86-512) 62992980 sgs.china@sgs.com

4.2 AC Power Line Conducted Emissions

Test Requirement:	47 CFR Part 15C Section 15.207		
Test Method:	ANSI C63.10-2013 Section 6.2		
Test Frequency Range:	150kHz to 30MHz		
Receiver Setup:	RBW = 9kHz, VBW = 30kHz		
Limit:	Frequency range (MHz)	Limit (dBuV)	
		Quasi-peak	Average
	0.15-0.5	66 to 56*	56 to 46*
	0.5-5	56	46
	5-30	60	50
* Decreases with the logarithm of the frequency.			
Test Procedure:	<p>1) The mains terminal disturbance voltage test was conducted in a shielded room.</p> <p>2) The EUT was connected to AC power source through a LISN 1 (Line Impedance Stabilization Network) which provides a 50Ω/50μH + 5Ω linear impedance. The power cables of all other units of the EUT were connected to a second LISN 2, which was bonded to the ground reference plane in the same way as the LISN 1 for the unit being measured. A multiple socket outlet strip was used to connect multiple power cables to a single LISN provided the rating of the LISN was not exceeded.</p> <p>3) The tabletop EUT was placed upon a non-metallic table 0.8m above the ground reference plane. And for floor-standing arrangement, the EUT was placed on the horizontal ground reference plane,</p> <p>4) The test was performed with a vertical ground reference plane. The rear of the EUT shall be 0.4 m from the vertical ground reference plane. The vertical ground reference plane was bonded to the horizontal ground reference plane. The LISN 1 was placed 0.8 m from the boundary of the unit under test and bonded to a ground reference plane for LISNs mounted on top of the ground reference plane. This distance was between the closest points of the LISN 1 and the EUT. All other units of the EUT and associated equipment was at least 0.8 m from the LISN 2. In order to find the maximum emission, the relative positions of equipment and all of the interface cables must be changed according to ANSI C63.10-2013 on conducted measurement.</p>		



Unless otherwise agreed in writing, this document is issued by the Company subject to its General Conditions of Service printed overleaf, available on request or accessible at <http://www.sgs.com/en/Terms-and-Conditions.aspx> and, for electronic format documents, subject to Terms and Conditions for Electronic Documents at <http://www.sgs.com/en/Terms-and-Conditions/Terms-e-Documents.aspx>. Attention is drawn to the limitation of liability, indemnification and jurisdiction issues defined therein. Any holder of this document is advised that information contained hereon reflects the Company's findings at the time of its intervention only and within the limits of Client's instructions, if any. The Company's sole responsibility is to its Client and this document does not exonerate parties to a transaction from exercising all their rights and obligations under the transaction documents. This document cannot be reproduced except in full, without prior written approval of the Company. Any unauthorized alteration, forgery or falsification of the content or appearance of this document is unlawful and offenders may be prosecuted to the fullest extent of the law. Unless otherwise stated the results shown in this test report refer only to the sample(s) tested and such sample(s) are retained for 30 days only.

Attention: To check the authenticity of testing/inspection report & certificate, please contact us at telephone: (86-755) 8307 1443, or email: CN.Doccheck@sgs.com

South of No. 6 Plant, No. 1, Runsheng Road, Suzhou Industrial Park, Suzhou Area, China (Jiangsu) Pilot Free Trade Zone 215000 t (86-512) 62992980 www.sgs.com.cn
 中国·苏州·中国(江苏)自由贸易试验区苏州片区苏州工业园区润胜路1号的6号厂房南楼 邮编: 215000 t (86-512) 62992980 sgs.china@sgs.com

<p>Test Setup:</p>	
<p>Exploratory Test Mode:</p>	<p>Transmitting with all kind of modulations, data rates at lowest, middle and highest channel. Charge + Transmitting mode.</p>
<p>Final Test Mode:</p>	<p>Refer to section 3.7 for details. Only the worst case is recorded in the report.</p>
<p>Instruments Used:</p>	<p>Refer to section 6 for details.</p>
<p>Test Results:</p>	<p>Pass</p>



Unless otherwise agreed in writing, this document is issued by the Company subject to its General Conditions of Service printed overleaf, available on request or accessible at <http://www.sgs.com/en/Terms-and-Conditions.aspx> and, for electronic format documents, subject to Terms and Conditions for Electronic Documents at <http://www.sgs.com/en/Terms-and-Conditions/Terms-e-Document.aspx>. Attention is drawn to the limitation of liability, indemnification and jurisdiction issues defined therein. Any holder of this document is advised that information contained hereon reflects the Company's findings at the time of its intervention only and within the limits of Client's instructions, if any. The Company's sole responsibility is to its Client and this document does not exonerate parties to a transaction from exercising all their rights and obligations under the transaction documents. This document cannot be reproduced except in full, without prior written approval of the Company. Any unauthorized alteration, forgery or falsification of the content or appearance of this document is unlawful and offenders may be prosecuted to the fullest extent of the law. Unless otherwise stated the results shown in this test report refer only to the sample(s) tested and such sample(s) are retained for 30 days only.
Attention: To check the authenticity of testing/inspection report & certificate, please contact us at telephone: (86-755) 8307 1443, or email: CN.Doccheck@sgs.com

South of No. 6 Plant, No. 1, Runsheng Road, Suzhou Industrial Park, Suzhou Area, China (Jiangsu) Pilot Free Trade Zone 215000 t (86-512) 62992980 www.sgs.com.cn
中国·苏州·中国(江苏)自由贸易试验区苏州片区苏州工业园区润胜路1号的6号厂房南座 邮编: 215000 t (86-512) 62992980 sgs.china@sgs.com

Measurement Data

An initial pre-scan was performed on the live and neutral lines with peak detector. Quasi-Peak and Average measurement were performed at the frequencies with maximized peak emission were detected.

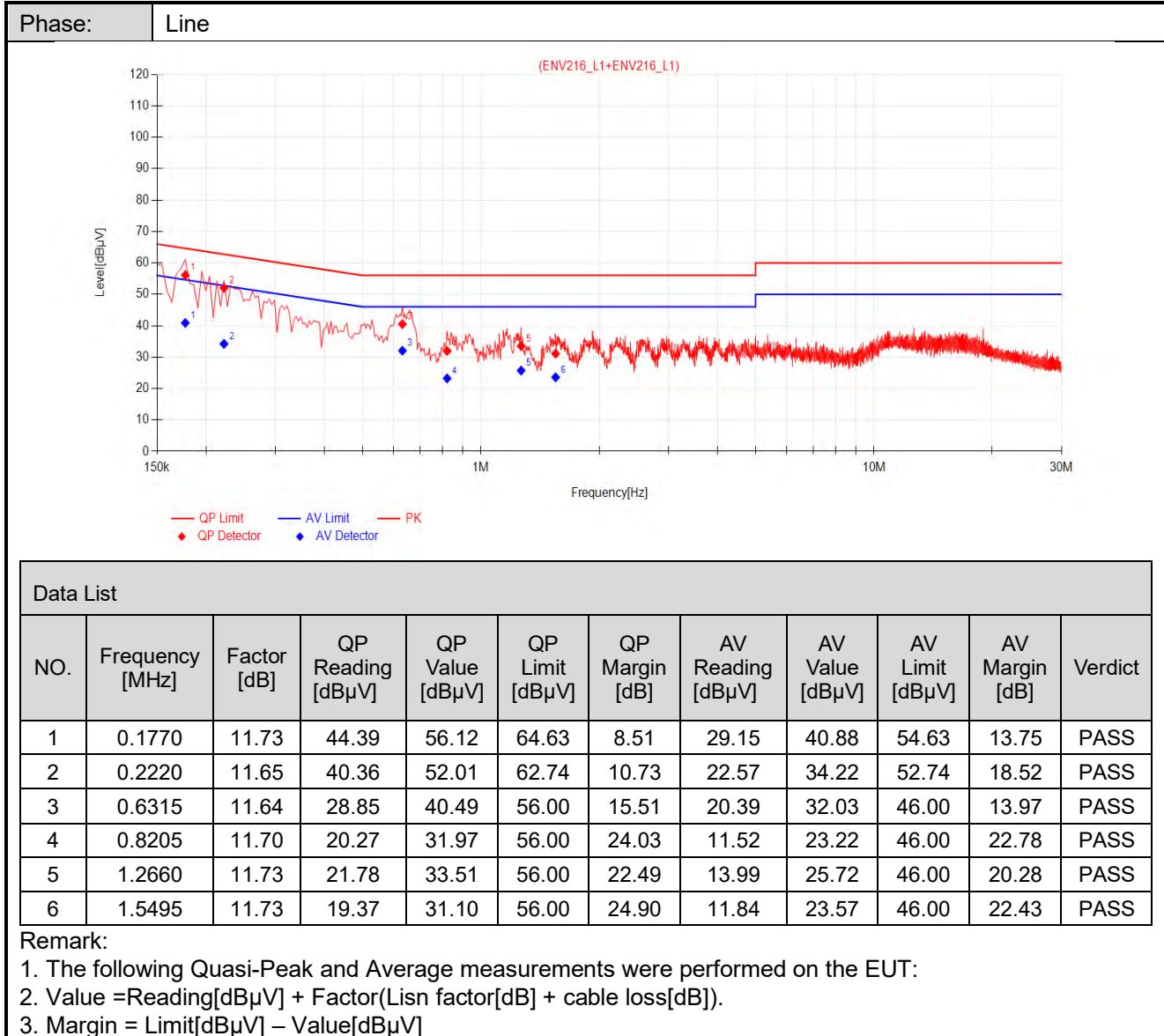

Phase: Neutral

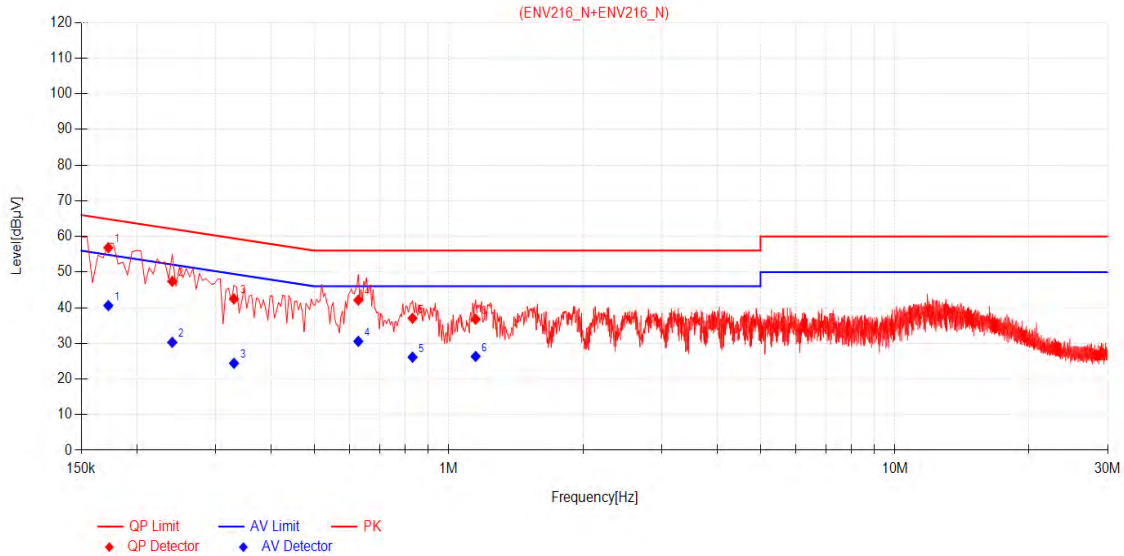

Data List											
NO.	Frequency [MHz]	Factor [dB]	QP Reading [dBµV]	QP Value [dBµV]	QP Limit [dBµV]	QP Margin [dB]	AV Reading [dBµV]	AV Value [dBµV]	AV Limit [dBµV]	AV Margin [dB]	Verdict
1	0.1725	11.75	45.06	56.81	64.84	8.03	28.84	40.59	54.84	14.25	PASS
2	0.2400	11.64	35.74	47.38	62.10	14.72	18.64	30.28	52.10	21.82	PASS
3	0.3300	11.62	30.84	42.46	59.45	16.99	12.79	24.41	49.45	25.04	PASS
4	0.6270	11.64	30.49	42.13	56.00	13.87	18.93	30.57	46.00	15.43	PASS
5	0.8295	11.70	25.34	37.04	56.00	18.96	14.43	26.13	46.00	19.87	PASS
6	1.1490	11.72	25.04	36.76	56.00	19.24	14.61	26.33	46.00	19.67	PASS

Remark:

- The following Quasi-Peak and Average measurements were performed on the EUT:
- Value = Reading[dBµV] + Factor(Lisn factor[dB] + cable loss[dB]).
- Margin = Limit[dBµV] – Value[dBµV]



Unless otherwise agreed in writing, this document is issued by the Company subject to its General Conditions of Service printed overleaf, available on request or accessible at <http://www.sgs.com/en/Terms-and-Conditions.aspx> and, for electronic format documents, subject to Terms and Conditions for Electronic Documents at <http://www.sgs.com/en/Terms-and-Conditions/Terms-e-Documents.aspx>. Attention is drawn to the limitation of liability, indemnification and jurisdiction issues defined therein. Any holder of this document is advised that information contained hereon reflects the Company's findings at the time of its intervention only and within the limits of Client's instructions, if any. The Company's sole responsibility is to its Client and this document does not exonerate parties to a transaction from exercising all their rights and obligations under the transaction documents. This document cannot be reproduced except in full, without prior written approval of the Company. Any unauthorized alteration, forgery or falsification of the content or appearance of this document is unlawful and offenders may be prosecuted to the fullest extent of the law. Unless otherwise stated the results shown in this test report refer only to the sample(s) tested and such sample(s) are retained for 30 days only.

Attention: To check the authenticity of testing/inspection report & certificate, please contact us at telephone: (86-755) 8307 1443, or email: CN.Doccheck@sgs.com
 South of No. 6 Plant, No. 1, Runsheng Road, Suzhou Industrial Park, Suzhou Area, China (Jiangsu) Pilot Free Trade Zone 215000 t (86-512) 62992980 www.sgs.com.cn
 中国·苏州·中国(江苏)自由贸易试验区苏州片区苏州工业园区润胜路1号的6号厂房南楼 邮编: 215000 t (86-512) 62992980 sgs.china@sgs.com

4.3 Duty Cycle

Test Requirement:	ANSI C63.10-2013 Section 11.6
Test Method:	ANSI C63.10-2013 Section 11.6
Test Setup:	
Instruments Used:	Refer to section 6 for details
Exploratory Test Mode:	Transmitting with all kind of modulations, data rates
Final Test Mode:	Refer to section 3.7 for details.
Limit:	No restriction limits
Test Results:	For Report Purpose
The detailed test data see: Appendix	



Unless otherwise agreed in writing, this document is issued by the Company subject to its General Conditions of Service printed overleaf, available on request or accessible at <http://www.sgs.com/en/Terms-and-Conditions.aspx> and, for electronic format documents, subject to Terms and Conditions for Electronic Documents at <http://www.sgs.com/en/Terms-and-Conditions/Terms-e-Documents.aspx>. Attention is drawn to the limitation of liability, indemnification and jurisdiction issues defined therein. Any holder of this document is advised that information contained hereon reflects the Company's findings at the time of its intervention only and within the limits of Client's instructions, if any. The Company's sole responsibility is to its Client and this document does not exonerate parties to a transaction from exercising all their rights and obligations under the transaction documents. This document cannot be reproduced except in full, without prior written approval of the Company. Any unauthorized alteration, forgery or falsification of the content or appearance of this document is unlawful and offenders may be prosecuted to the fullest extent of the law. Unless otherwise stated the results shown in this test report refer only to the sample(s) tested and such sample(s) are retained for 30 days only.

Attention: To check the authenticity of testing/inspection report & certificate, please contact us at telephone: (86-755) 8307 1443, or email: CN_Doccheck@sgs.com

South of No. 6 Plant, No. 1, Runsheng Road, Suzhou Industrial Park, Suzhou Area, China (Jiangsu) Pilot Free Trade Zone 215000 t (86-512) 62992980 www.sgs.com.cn
 中国·苏州·中国(江苏)自由贸易试验区苏州片区苏州工业园区润胜路1号的6号厂房南楼 邮编: 215000 t (86-512) 62992980 sgs.china@sgs.com

4.4 Conducted Output Power

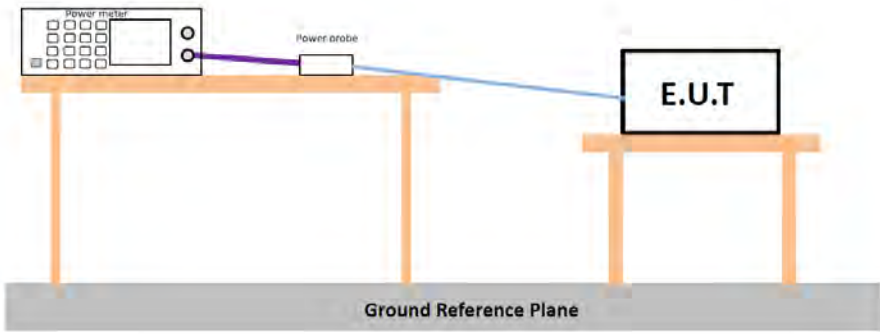
Test Requirement:	47 CFR Part 15C Section 15.247 (b)(3)
Test Method:	ANSI C63.10-2013 Section 11.9.1.3
Test Setup:	 <p>* Test with power meter (Detector function: Peak)</p>
Test Instruments:	Refer to section 6 for details.
Exploratory Test Mode:	Transmitting with all kind of modulations, data rates
Final Test Mode:	Refer to section 3.7 for details.
Limit:	30dBm
Test Results:	Pass
The detailed test data see: Appendix	



Unless otherwise agreed in writing, this document is issued by the Company subject to its General Conditions of Service printed overleaf, available on request or accessible at <http://www.sgs.com/en/Terms-and-Conditions.aspx> and, for electronic format documents, subject to Terms and Conditions for Electronic Documents at <http://www.sgs.com/en/Terms-and-Conditions/Terms-e-Documents.aspx>. Attention is drawn to the limitation of liability, indemnification and jurisdiction issues defined therein. Any holder of this document is advised that information contained hereon reflects the Company's findings at the time of its intervention only and within the limits of Client's instructions, if any. The Company's sole responsibility is to its Client and this document does not exonerate parties to a transaction from exercising all their rights and obligations under the transaction documents. This document cannot be reproduced except in full, without prior written approval of the Company. Any unauthorized alteration, forgery or falsification of the content or appearance of this document is unlawful and offenders may be prosecuted to the fullest extent of the law. Unless otherwise stated the results shown in this test report refer only to the sample(s) tested and such sample(s) are retained for 30 days only.

Attention: To check the authenticity of testing/inspection report & certificate, please contact us at telephone: (86-755) 8307 1443, or email: CN.Doccheck@sgs.com

South of No. 6 Plant, No. 1, Runsheng Road, Suzhou Industrial Park, Suzhou Area, China (Jiangsu) Pilot Free Trade Zone 215000 t (86-512) 62992980 www.sgs.com.cn
 中国·苏州·中国(江苏)自由贸易试验区苏州片区苏州工业园区润胜路1号的6号厂房南楼 邮编: 215000 t (86-512) 62992980 sgs.china@sgs.com

4.5 DTS (6 dB) Bandwidth & 99% Occupied Bandwidth

Test Requirement:	47 CFR Part 15C Section 15.247 (a)(2)
Test Method:	ANSI C63.10-2013 Section 11.8 Option 2 / 6.9.3
Test Setup:	
Instruments Used:	Refer to section 6 for details.
Exploratory Test Mode:	Transmitting with all kind of modulations, data rates
Final Test Mode:	Refer to section 3.7 for details.
Limit:	≥ 500 kHz for DTS Bandwidth
Test Results:	Pass
The detailed test data see: Appendix	



Unless otherwise agreed in writing, this document is issued by the Company subject to its General Conditions of Service printed overleaf, available on request or accessible at <http://www.sgs.com/en/Terms-and-Conditions.aspx> and, for electronic format documents, subject to Terms and Conditions for Electronic Documents at <http://www.sgs.com/en/Terms-and-Conditions/Terms-e-Document.aspx>. Attention is drawn to the limitation of liability, indemnification and jurisdiction issues defined therein. Any holder of this document is advised that information contained hereon reflects the Company's findings at the time of its intervention only and within the limits of Client's instructions, if any. The Company's sole responsibility is to its Client and this document does not exonerate parties to a transaction from exercising all their rights and obligations under the transaction documents. This document cannot be reproduced except in full, without prior written approval of the Company. Any unauthorized alteration, forgery or falsification of the content or appearance of this document is unlawful and offenders may be prosecuted to the fullest extent of the law. Unless otherwise stated the results shown in this test report refer only to the sample(s) tested and such sample(s) are retained for 30 days only.

Attention: To check the authenticity of testing/inspection report & certificate, please contact us at telephone: (86-755) 8307 1443, or email: CN.Doccheck@sgs.com

South of No. 6 Plant, No. 1, Runsheng Road, Suzhou Industrial Park, Suzhou Area, China (Jiangsu) Pilot Free Trade Zone 215000 t (86-512) 62992980 www.sgs.com.cn
 中国·苏州·中国(江苏)自由贸易试验区苏州片区苏州工业园区润胜路1号的6号厂房南楼 邮编: 215000 t (86-512) 62992980 sgs.china@sgs.com

4.6 Power Spectral Density

Test Requirement:	47 CFR Part 15C Section 15.247 (e)
Test Method:	ANSI C63.10-2013 Section 11.10.2
Test Setup:	
Test Instruments:	Refer to section 6 for details.
Exploratory Test Mode:	Transmitting with all kind of modulations, data rates
Final Test Mode:	Refer to section 3.7 for details.
Limit:	≤8.00dBm/3kHz
Test Results:	Pass
The detailed test data see: Appendix	



Unless otherwise agreed in writing, this document is issued by the Company subject to its General Conditions of Service printed overleaf, available on request or accessible at <http://www.sgs.com/en/Terms-and-Conditions.aspx> and, for electronic format documents, subject to Terms and Conditions for Electronic Documents at <http://www.sgs.com/en/Terms-and-Conditions/Terms-e-Documents.aspx>. Attention is drawn to the limitation of liability, indemnification and jurisdiction issues defined therein. Any holder of this document is advised that information contained hereon reflects the Company's findings at the time of its intervention only and within the limits of Client's instructions, if any. The Company's sole responsibility is to its Client and this document does not exonerate parties to a transaction from exercising all their rights and obligations under the transaction documents. This document cannot be reproduced except in full, without prior written approval of the Company. Any unauthorized alteration, forgery or falsification of the content or appearance of this document is unlawful and offenders may be prosecuted to the fullest extent of the law. Unless otherwise stated the results shown in this test report refer only to the sample(s) tested and such sample(s) are retained for 30 days only.

Attention: To check the authenticity of testing/inspection report & certificate, please contact us at telephone: (86-755) 8307 1443, or email: CN.Doccheck@sgs.com

South of No. 6 Plant, No. 1, Runsheng Road, Suzhou Industrial Park, Suzhou Area, China (Jiangsu) Pilot Free Trade Zone 215000 t (86-512) 62992980 www.sgs.com.cn
 中国·苏州·中国(江苏)自由贸易试验区苏州片区苏州工业园区润胜路1号的6号厂房南楼 邮编: 215000 t (86-512) 62992980 sgs.china@sgs.com

4.7 Band-edge for RF Conducted Emissions

Test Requirement:	47 CFR Part 15C Section 15.247 (d)
Test Method:	ANSI C63.10-2013 Section 11.11
Test Setup:	
Instruments Used:	Refer to section 6 for details.
Exploratory Test Mode:	Transmitting with all kind of modulations, data rates
Final Test Mode:	Refer to section 3.7 for details.
Limit:	In any 100 kHz bandwidth outside the frequency band in which the spread spectrum intentional radiator is operating, the radio frequency power that is produced by the intentional radiator shall be at least 20 dB below that in the 100 kHz bandwidth within the band that contains the highest level of the desired power, based on either an RF conducted or a radiated measurement.
Test Results:	Pass
The detailed test data see: Appendix	



4.8 RF Conducted Spurious Emissions

Test Requirement:	47 CFR Part 15C Section 15.247 (d)
Test Method:	ANSI C63.10-2013 Section 11.11
Test Setup:	
Instruments Used:	Refer to section 6 for details.
Exploratory Test Mode:	Transmitting with all kind of modulations, data rates
Final Test Mode:	Refer to section 3.7 for details.
Limit:	In any 100 kHz bandwidth outside the frequency band in which the spread spectrum intentional radiator is operating, the radio frequency power that is produced by the intentional radiator shall be at least 20 dB below that in the 100 kHz bandwidth within the band that contains the highest level of the desired power, based on either an RF conducted or a radiated measurement.
Test Results:	Pass
The detailed test data see: Appendix	



4.9 Radiated Spurious Emissions

Test Requirement:	47 CFR Part 15C Section 15.209 and 15.205				
Test Method:	ANSI C63.10-2013 Section 11.12				
Test Site:	Measurement Distance: 3m (Semi-Anechoic Chamber)				
Test Frequency:	9kHz ~ 25GHz				
Receiver Setup:	Frequency	Detector	RBW	VBW	Remark
	0.009MHz-0.090MHz	Peak	10kHz	30kHz	Peak
	0.009MHz-0.090MHz	Average	10kHz	30kHz	Average
	0.090MHz-0.110MHz	Quasi-peak	10kHz	30kHz	Quasi-peak
	0.110MHz-0.490MHz	Peak	10kHz	30kHz	Peak
	0.110MHz-0.490MHz	Average	10kHz	30kHz	Average
	0.490MHz -30MHz	Quasi-peak	10kHz	30kHz	Quasi-peak
	30MHz-1GHz	Quasi-peak	120kHz	300kHz	Quasi-peak
Above 1GHz	Peak	1MHz	3MHz	Peak	
	Peak	1MHz	3MHz	Peak	
Limit:	Frequency	Field strength (microvolt/meter)	Limit (dBuV/m)	Remark	Measurement distance (m)
	0.009MHz-0.490MHz	2400/F(kHz)	-	-	300
	0.490MHz-1.705MHz	24000/F(kHz)	-	-	30
	1.705MHz-30MHz	30	-	-	30
	30MHz-88MHz	100	40.0	Quasi-peak	3
	88MHz-216MHz	150	43.5	Quasi-peak	3
	216MHz-960MHz	200	46.0	Quasi-peak	3
	960MHz-1GHz	500	54.0	Quasi-peak	3
	Above 1GHz	500	54.0	Average	3
Remark: 15.35(b), Unless otherwise specified, the limit on peak radio frequency emissions is 20dB above the maximum permitted average emission limit applicable to the equipment under test. This peak limit applies to the total peak emission level radiated by the device.					



Test Setup:

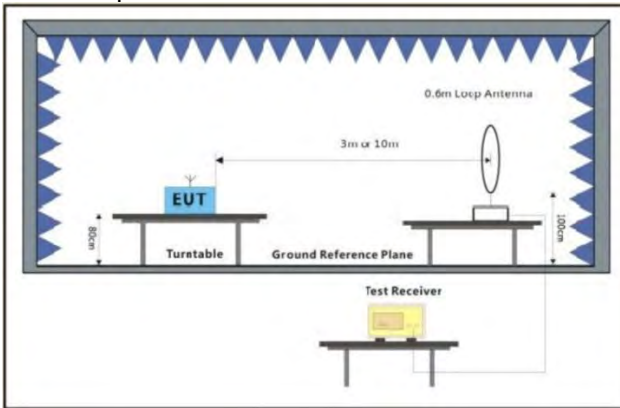

Figure 1. Below 30MHz

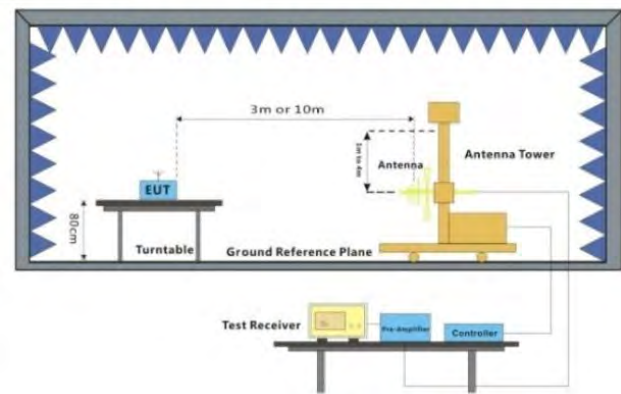

Figure 2. 30MHz to 1GHz

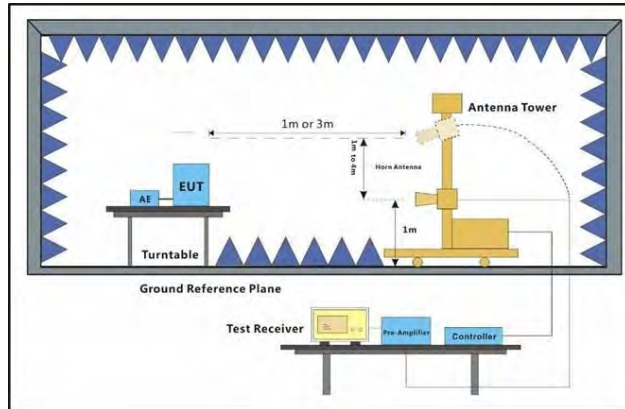

Figure 3. Above 1 GHz

Test Procedure:

- a. For below 1GHz, the EUT was placed on the top of a rotating table 0.8 meters above the ground at a 3 or 10 meter semi-anechoic chamber. The table was rotated 360 degrees to determine the position of the highest radiation.
- b. For above 1GHz, the EUT was placed on the top of a rotating table 1.5 meters above the ground at a 3 meter semi-anechoic chamber. The table was rotated 360 degrees to determine the position of the highest radiation (Distance from antenna to EUT is 1m for measurements >18GHz).
- c. The EUT was set 3 or 10 meters away from the interference-receiving antenna, which was mounted on the top of a variable-height antenna tower.
- d. The antenna height is varied from one meter to four meters above the ground to determine the maximum value of the field strength. Both horizontal and vertical polarizations of the antenna are set to make the measurement.
- e. For each suspected emission, the EUT was arranged to its worst case and then the antenna was tuned to heights from 1 meter to 4 meters (for the test frequency of below 30MHz, the antenna was tuned to heights 1 meter) and the rotatable table was turned from 0 degrees to 360 degrees to find the maximum reading.
- f. The test-receiver system was set to Peak Detect Function and Specified



Unless otherwise agreed in writing, this document is issued by the Company subject to its General Conditions of Service printed overleaf, available on request or accessible at <http://www.sgs.com/en/Terms-and-Conditions.aspx> and, for electronic format documents, subject to Terms and Conditions for Electronic Documents at <http://www.sgs.com/en/Terms-and-Conditions/Terms-e-Documents.aspx>. Attention is drawn to the limitation of liability, indemnification and jurisdiction issues defined therein. Any holder of this document is advised that information contained hereon reflects the Company's findings at the time of its intervention only and within the limits of Client's instructions, if any. The Company's sole responsibility is to its Client and this document does not exonerate parties to a transaction from exercising all their rights and obligations under the transaction documents. This document cannot be reproduced except in full, without prior written approval of the Company. Any unauthorized alteration, forgery or falsification of the content or appearance of this document is unlawful and offenders may be prosecuted to the fullest extent of the law. Unless otherwise stated the results shown in this test report refer only to the sample(s) tested and such sample(s) are retained for 30 days only.

Attention: To check the authenticity of testing/inspection report & certificate, please contact us at telephone: (86-755) 8307 1443, or email: CN.Doccheck@sgs.com

South of No. 6 Plant, No. 1, Puzheng Road, Suzhou Industrial Park, Suzhou Area, China (Jiangsu) Pilot Free Trade Zone 215000
 中国·苏州·中国(江苏)自由贸易试验区苏州片区工业园区海旺路1号的6号厂房南楼 邮编: 215000

t (86-512) 62992980 www.sgs.com.cn
 t (86-512) 62992980 sgs.china@sgs.com

	<p>Bandwidth with Maximum Hold Mode.</p> <p>g. Test the EUT in the lowest channel, the middle channel ,the Highest channel.</p> <p>h. The radiation measurements are performed in X, Y, Z axis positioning for Transmitting mode, And found the X axis positioning which it is worse case.</p> <p>i. Repeat above procedures until all frequencies measured was complete.</p> <p>j. The low frequency, which started from 9 kHz to 30MHz, was pre-scanned and the result which was 20dB lower than the limit line was not reported</p> <p>k. The disturbance above 18GHz was very low, and the harmonics were the highest point could be found when testing, so only the harmonics had been displayed.</p> <p>l. At a measurement distance of 1 meter the limit line was increased by $20 \cdot \text{LOG}(3/1) = 9.54 \text{ dB}$.</p>
Test Configuration:	<p>Measurements below 30MHz</p> <ul style="list-style-type: none"> • RBW = 10 kHz • VBW = 30 kHz • Detector = Peak & Average & Quasi-peak • Trace mode = max hold <p>Measurements Below 1000MHz</p> <ul style="list-style-type: none"> • RBW = 120 kHz • VBW = 300 kHz • Detector = Quasi-peak • Trace mode = max hold <p>Peak Measurements Above 1000 MHz</p> <ul style="list-style-type: none"> • RBW = 1 MHz • VBW \geq 3 MHz • Detector = Peak • Sweep time = auto • Trace mode = max hold <p>Average Measurements Above 1000MHz</p> <ul style="list-style-type: none"> • RBW = 1 MHz • VBW = 10 Hz, when duty cycle is no less than 98 percent. • VBW \geq 1/T, when duty cycle is less than 98 percent where T is the minimum transmission duration over which the transmitter is on and is transmitting at its maximum power control level for the tested mode of operation.
Exploratory Test Mode:	<p>Transmitting with all kind of modulations, data rates.</p> <p>Charge + Transmitting mode.</p>
Final Test Mode:	<p>Refer to section 3.7 for details.</p> <p>For below 1GHz part, through pre-scan all channels, but only the worst case is recorded in the report.</p>
Instruments Used:	Refer to section 6 for details.
Test Results:	Pass
The detailed test data see: Appendix	



Unless otherwise agreed in writing, this document is issued by the Company subject to its General Conditions of Service printed overleaf, available on request or accessible at <http://www.sgs.com/en/Terms-and-Conditions.aspx> and, for electronic format documents, subject to Terms and Conditions for Electronic Documents at <http://www.sgs.com/en/Terms-and-Conditions/Terms-e-Documents.aspx>. Attention is drawn to the limitation of liability, indemnification and jurisdiction issues defined therein. Any holder of this document is advised that information contained hereon reflects the Company's findings at the time of its intervention only and within the limits of Client's instructions, if any. The Company's sole responsibility is to its Client and this document does not exonerate parties to a transaction from exercising all their rights and obligations under the transaction documents. This document cannot be reproduced except in full, without prior written approval of the Company. Any unauthorized alteration, forgery or falsification of the content or appearance of this document is unlawful and offenders may be prosecuted to the fullest extent of the law. Unless otherwise stated the results shown in this test report refer only to the sample(s) tested and such sample(s) are retained for 30 days only.

Attention: To check the authenticity of testing/inspection report & certificate, please contact us at telephone: (86-755) 8307 1443, or email: CN.Doccheck@sgs.com

South of No. 6 Plant, No. 1, Runsheng Road, Suzhou Industrial Park, Suzhou Area, China (Jiangsu) Pilot Free Trade Zone 215000
 中国·苏州·中国(江苏)自由贸易试验区苏州片区苏州工业园区润胜路1号的6号厂房南楼 邮编: 215000

t (86-512) 62992980 www.sgsgroup.com.cn
 t (86-512) 62992980 sgs.china@sgs.com

4.10 Restricted bands around fundamental frequency

Test Requirement:	47 CFR Part 15C Section 15.209 and 15.205		
Test Method:	ANSI C63.10-2013 Section 11.12		
Test Site:	Measurement Distance: 3m (Semi-Anechoic Chamber)		
Limit:	Frequency	Limit (dBuV/m)	Remark
	30MHz-88MHz	40.0	Quasi-peak
	88MHz-216MHz	43.5	Quasi-peak
	216MHz-960MHz	46.0	Quasi-peak
	960MHz-1GHz	54.0	Quasi-peak
Above 1GHz		54.0	Average Value
		74.0	Peak Value

Test Setup:

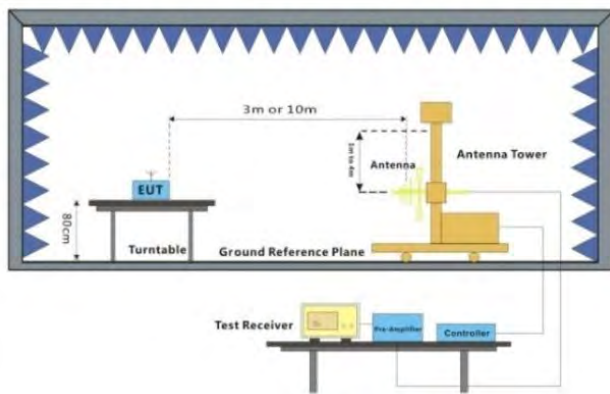

Figure 1. 30MHz to 1GHz

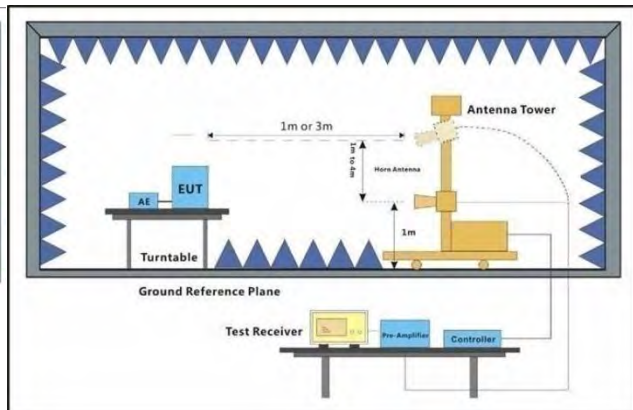

Figure 2. Above 1 GHz



Unless otherwise agreed in writing, this document is issued by the Company subject to its General Conditions of Service printed overleaf, available on request or accessible at <http://www.sgs.com/en/Terms-and-Conditions.aspx> and, for electronic format documents, subject to Terms and Conditions for Electronic Documents at <http://www.sgs.com/en/Terms-and-Conditions/Terms-e-Documents.aspx>. Attention is drawn to the limitation of liability, indemnification and jurisdiction issues defined therein. Any holder of this document is advised that information contained hereon reflects the Company's findings at the time of its intervention only and within the limits of Client's instructions, if any. The Company's sole responsibility is to its Client and this document does not exonerate parties to a transaction from exercising all their rights and obligations under the transaction documents. This document cannot be reproduced except in full, without prior written approval of the Company. Any unauthorized alteration, forgery or falsification of the content or appearance of this document is unlawful and offenders may be prosecuted to the fullest extent of the law. Unless otherwise stated the results shown in this test report refer only to the sample(s) tested and such sample(s) are retained for 30 days only.

Attention: To check the authenticity of testing/inspection report & certificate, please contact us at telephone: (86-755) 8307 1443, or email: CN.Doccheck@sgs.com

South of No. 6 Plant, No. 1, Runsheng Road, Suzhou Industrial Park, Suzhou Area, China (Jiangsu) Pilot Free Trade Zone 215000
 中国·苏州·中国(江苏)自由贸易试验区苏州片区苏州工业园区润胜路1号的6号厂房南楼 邮编: 215000

t (86-512) 62992980 www.sgs.com.cn
 t (86-512) 62992980 sgs.china@sgs.com

<p>Test Procedure:</p>	<ol style="list-style-type: none"> For below 1GHz, the EUT was placed on the top of a rotating table 0.8 meters above the ground at a 3 or 10 meter semi-anechoic chamber. The table was rotated 360 degrees to determine the position of the highest radiation. For above 1GHz, the EUT was placed on the top of a rotating table 1.5 meters above the ground at a 3 meter semi-anechoic chamber. The table was rotated 360 degrees to determine the position of the highest radiation. The EUT was set 3 or 10 meters away from the interference-receiving antenna, which was mounted on the top of a variable-height antenna tower. The antenna height is varied from one meter to four meters above the ground to determine the maximum value of the field strength. Both horizontal and vertical polarizations of the antenna are set to make the measurement. For each suspected emission, the EUT was arranged to its worst case and then the antenna was tuned to heights from 1 meter to 4 meters and the rotatable table was turned from 0 degrees to 360 degrees to find the maximum reading. The test-receiver system was set to Peak Detect Function and Specified Bandwidth with Maximum Hold Mode. Place a marker at the end of the restricted band closest to the transmit frequency to show compliance. Also measure any emissions in the restricted bands. Save the spectrum analyzer plot. Repeat for each power and modulation for lowest and highest channel Test the EUT in the lowest channel , the Highest channel The radiation measurements are performed in X, Y, Z axis positioning for Transmitting mode,And found the X axis positioning which it is worse case. Repeat above procedures until all frequencies measured was complete.
<p>Test Configuration:</p>	<p>Measurements Below 1000MHz</p> <ul style="list-style-type: none"> • RBW = 120 kHz • VBW = 300 kHz • Detector = Quasi-peak • Trace mode = max hold <p>Peak Measurements Above 1000 MHz</p> <ul style="list-style-type: none"> • RBW = 1 MHz • VBW ≥ 3 MHz • Detector = Peak • Sweep time = auto • Trace mode = max hold <p>Average Measurements Above 1000MHz</p> <ul style="list-style-type: none"> • RBW = 1 MHz • VBW = 10 Hz, when duty cycle is no less than 98 percent. • VBW ≥ 1/T, when duty cycle is less than 98 percent where T is the minimum transmission duration over which the transmitter is on and is transmitting at its maximum power control level for the tested mode of operation.
<p>Exploratory Test Mode:</p>	<p>Transmitting with all kind of modulations, data rates. Charge + Transmitting mode.</p>
<p>Final Test Mode:</p>	<p>Refer to section 3.7 for details.</p>
<p>Instruments Used:</p>	<p>Refer to section 6 for details.</p>



Unless otherwise agreed in writing, this document is issued by the Company subject to its General Conditions of Service printed overleaf, available on request or accessible at <http://www.sgs.com/en/Terms-and-Conditions.aspx> and, for electronic format documents, subject to Terms and Conditions for Electronic Documents at <http://www.sgs.com/en/Terms-and-Conditions/Terms-e-Documents.aspx>. Attention is drawn to the limitation of liability, indemnification and jurisdiction issues defined therein. Any holder of this document is advised that information contained hereon reflects the Company's findings at the time of its intervention only and within the limits of Client's instructions, if any. The Company's sole responsibility is to its Client and this document does not exonerate parties to a transaction from exercising all their rights and obligations under the transaction documents. This document cannot be reproduced except in full, without prior written approval of the Company. Any unauthorized alteration, forgery or falsification of the content or appearance of this document is unlawful and offenders may be prosecuted to the fullest extent of the law. Unless otherwise stated the results shown in this test report refer only to the sample(s) tested and such sample(s) are retained for 30 days only.

Attention: To check the authenticity of testing/inspection report & certificate, please contact us at telephone: (86-755) 8307 1443, or email: CN.Doccheck@sgs.com

South of No. 6 Plant, No. 1, Pansheng Road, Suzhou Industrial Park, Suzhou Area, China (Jiangsu) Pilot Free Trade Zone 215000 t (86-512) 62992980 www.sgs.com.cn
 中国·苏州·中国(江苏)自由贸易试验区苏州片区苏州工业园区海胜路1号的6号厂房南楼 邮编: 215000 t (86-512) 62992980 sgs.china@sgs.com



Report No.: SEWM2309000380RG04

Rev.: 01

Page: 25 of 112

Test Results:	Pass
The detailed test data see: Appendix	



Unless otherwise agreed in writing, this document is issued by the Company subject to its General Conditions of Service printed overleaf, available on request or accessible at <http://www.sgs.com/en/Terms-and-Conditions.aspx> and, for electronic format documents, subject to Terms and Conditions for Electronic Documents at <http://www.sgs.com/en/Terms-and-Conditions/Terms-e-Documents.aspx>. Attention is drawn to the limitation of liability, indemnification and jurisdiction issues defined therein. Any holder of this document is advised that information contained hereon reflects the Company's findings at the time of its intervention only and within the limits of Client's instructions, if any. The Company's sole responsibility is to its Client and this document does not exonerate parties to a transaction from exercising all their rights and obligations under the transaction documents. This document cannot be reproduced except in full, without prior written approval of the Company. Any unauthorized alteration, forgery or falsification of the content or appearance of this document is unlawful and offenders may be prosecuted to the fullest extent of the law. Unless otherwise stated the results shown in this test report refer only to the sample(s) tested and such sample(s) are retained for 30 days only.

Attention: To check the authenticity of testing/inspection report & certificate, please contact us at telephone: (86-755) 8307 1443, or email: CN.Doccheck@sgs.com

South of No. 6 Plant, No. 1, Runsheng Road, Suzhou Industrial Park, Suzhou Area, China (Jiangsu) Pilot Free Trade Zone 215000 t (86-512) 62992980 www.sgs.com.cn
 中国·苏州·中国(江苏)自由贸易试验区苏州片区苏州工业园区润胜路1号的6号厂房南楼 邮编: 215000 t (86-512) 62992980 sgs.china@sgs.com

5 Measurement Uncertainty (95% confidence levels, k=2)

No.	Item	Measurement Uncertainty
1	Total RF power, conducted	±0.54dB
2	RF power density, conducted	±1.03dB
3	Spurious emissions, conducted	±0.54dB
4	Radio Frequency	±1.0 %
5	Duty Cycle	±0.37%
6	Occupied Bandwidth	±1.0 %
7	Conduction Emission	± 2.90dB (150kHz to 30MHz)
8	Radiated Emission	± 3.13dB (9k -30MHz)
		± 4.88dB (30M -1GHz)
		± 4.75dB (1GHz to 18GHz)
		± 4.77dB (Above 18GHz)

Remark:

The U_{lab} (lab Uncertainty) is less than $U_{CISPR/ETSI}$ (CISPR/ETSI Uncertainty), so the test results
 – compliance is deemed to occur if no measured disturbance level exceeds the disturbance limit;
 – non-compliance is deemed to occur if any measured disturbance level exceeds the disturbance limit.



Unless otherwise agreed in writing, this document is issued by the Company subject to its General Conditions of Service printed overleaf, available on request or accessible at <http://www.sgs.com/en/Terms-and-Conditions.aspx> and, for electronic format documents, subject to Terms and Conditions for Electronic Documents at <http://www.sgs.com/en/Terms-and-Conditions/Terms-e-Documents.aspx>. Attention is drawn to the limitation of liability, indemnification and jurisdiction issues defined therein. Any holder of this document is advised that information contained hereon reflects the Company's findings at the time of its intervention only and within the limits of Client's instructions, if any. The Company's sole responsibility is to its Client and this document does not exonerate parties to a transaction from exercising all their rights and obligations under the transaction documents. This document cannot be reproduced except in full, without prior written approval of the Company. Any unauthorized alteration, forgery or falsification of the content or appearance of this document is unlawful and offenders may be prosecuted to the fullest extent of the law. Unless otherwise stated the results shown in this test report refer only to the sample(s) tested and such sample(s) are retained for 30 days only.
Attention: To check the authenticity of testing/inspection report & certificate, please contact us at telephone: (86-755) 8307 1443, or email: CN.Doccheck@sgs.com

South of No. 6 Plant, No. 1, Runsheng Road, Suzhou Industrial Park, Suzhou Area, China (Jiangsu) Pilot Free Trade Zone 215000 t (86-512) 62992980 www.sgs.com.cn
 中国·苏州·中国(江苏)自由贸易试验区苏州片区苏州工业园区润胜路1号的6号厂房南楼 邮编: 215000 t (86-512) 62992980 sgs.china@sgs.com

6 Equipment List

RF Test Equipment					
Test Equipment	Manufacturer	Model No.	Inventory No.	Cal. date (yyyy/mm/dd)	Cal.Due date (yyyy/mm/dd)
Shielding Room	Brilliant-emc	N/A	SUWI-04-01-06	2021/05/08	2024/05/07
Temperature and humidity meter	MingGao	TH101B	SUWI-01-01-07	2023/02/06	2024/02/05
Signal Analyzer	ROHDE&SCHWARZ	FSV3030	SUWI-01-02-02	2023/05/11	2024/05/10
Measurement Software	Tonscend	JS1120-3 Test System V 3.3.20	SUWI-02-09-09	NCR	NCR
Signal Analyzer	ROHDE&SCHWARZ	FSW43	SUWI-01-02-04	2023/05/11	2024/05/10
Temperature Chamber	ESPEC	SU-242	SUWI-01-13-01	2023/02/06	2024/02/05
Wideband Radio Communication Tester	ROHDE&SCHWARZ	CMW500	SUWI-01-16-05	2023/02/06	2024/02/05
DC Power Supply	HYELEC	HY3005B	SUWI-01-18-01	2023/02/06	2024/02/05
Power meter	Anritsu	ML2495A	SUWI-01-31-01	2022/11/23	2023/11/22
				2023/11/21	2024/11/20
Pulse power sensor	Anritsu	MA2411B	SUWI-01-32-01	2022/11/23	2023/11/22
				2023/11/21	2024/11/20
MXG Vector signal genitor	KEYSIGHT	N5182B	SUWI-01-38-01	2023/02/06	2024/02/05

Remark: NCR=No Calibration Requirement

Conduction Test Equipment					
Test Equipment	Manufacturer	Model No.	Inventory No.	Cal. date (yyyy/mm/dd)	Cal.Due date (yyyy/mm/dd)
Shielding Room	Brilliant-emc	N/A	SUWI-04-03-01	2021/05/08	2024/05/07
Test receiver	ROHDE&SCHWARZ	ESR7	SUWI-01-10-01	2023/02/08	2024/02/07
Temperature and humidity meter	MingGao	TH101B	SUWI-01-01-06	2023/02/07	2024/02/06
Artificial network	ROHDE&SCHWARZ	ENV216	SUWI-01-19-03	2023/02/08	2024/02/07
Artificial network	ROHDE&SCHWARZ	ENV216	SUWI-01-19-04	2023/02/08	2024/02/07
Measurement Software	Tonscend	JS32-CE V4.0.0.2	SUWI-02-09-05	NCR	NCR

Remark: NCR=No Calibration Requirement



Unless otherwise agreed in writing, this document is issued by the Company subject to its General Conditions of Service printed overleaf, available on request or accessible at <http://www.sgs.com/en/Terms-and-Conditions.aspx> and, for electronic format documents, subject to Terms and Conditions for Electronic Documents at <http://www.sgs.com/en/Terms-and-Conditions/Terms-e-Documents.aspx>. Attention is drawn to the limitation of liability, indemnification and jurisdiction issues defined therein. Any holder of this document is advised that information contained hereon reflects the Company's findings at the time of its intervention only and within the limits of Client's instructions, if any. The Company's sole responsibility is to its Client and this document does not exonerate parties to a transaction from exercising all their rights and obligations under the transaction documents. This document cannot be reproduced except in full, without prior written approval of the Company. Any unauthorized alteration, forgery or falsification of the content or appearance of this document is unlawful and offenders may be prosecuted to the fullest extent of the law. Unless otherwise stated the results shown in this test report refer only to the sample(s) tested and such sample(s) are retained for 30 days only.

Attention: To check the authenticity of testing/inspection report & certificate, please contact us at telephone: (86-755) 8307 1443, or email: CN.Doccheck@sgs.com
 South of No. 6 Plant, No. 1, Runsheng Road, Suzhou Industrial Park, Suzhou Area, China (Jiangsu) Pilot Free Trade Zone 215000 t (86-512) 62992980 www.sgs.com.cn
 中国·苏州·中国(江苏)自由贸易试验区苏州片区苏州工业园区润胜路1号的6号厂房南楼 邮编: 215000 t (86-512) 62992980 sgs.china@sgs.com

RSE Test System					
Test Equipment	Manufacturer	Model No.	Inventory No.	Cal. date (yyyy/mm/dd)	Cal.Due date (yyyy/mm/dd)
Semi-Anechoic Chamber	Brilliant-emc	N/A	SUWI-04-02-02	2021/11/25	2024/11/24
Temperature and humidity meter	MingGao	TH101B	SUWI-01-01-13	2023/02/07	2024/02/06
Signal Analyzer	ROHDE&SCHWARZ	FSW43	SUWI-01-02-04	2023/05/11	2024/05/10
Signal Analyzer	KEYSIGHT	N9020A	SUWI-01-02-06	2022/11/23	2023/11/22
				2023/11/21	2024/11/20
Test receiver	ROHDE&SCHWARZ	ESR7	SUWI-01-10-01	2023/02/08	2024/02/07
Receiving antenna	SCHWRZBECK MESS-ELEKTRONIK	VULB 9168	SUWI-01-11-04	2021/12/05	2023/12/04
				2023/11/25	2024/11/24
Receiving antenna	SCHWRZBECK MESS-ELEKTRONIK	BBHA 9120D	SUWI-01-11-05	2021/12/05	2023/12/04
				2023/11/25	2024/11/24
Receiving antenna	SCHWRZBECK MESS-ELEKTRONIK	BBHA 9170	SUWI-01-11-03	2023/05/12	2024/05/11
Active Loop Antenna	SCHWRZBECK MESS-ELEKTRONIK	FMZB 1519B	SUWI-01-21-01	2023/05/13	2024/05/12
Amplifier	Tonscend	TAP9K3G32	SUWI-01-14-06	2022/11/23	2023/11/22
				2023/11/21	2024/11/20
Amplifier	Tonscend	TAP01018050	SUWI-01-14-04	2022/11/23	2023/11/22
				2023/11/21	2024/11/20
Amplifier	Tonscend	TAP30M7G30	SUWI-01-14-05	2022/11/23	2023/11/22
				2023/11/21	2024/11/20
Measurement Software	Tonscend	JS32-RE V4.0.0.0	SUWI-02-09-04	NCR	NCR

Remark: NCR=No Calibration Requirement



Unless otherwise agreed in writing, this document is issued by the Company subject to its General Conditions of Service printed overleaf, available on request or accessible at <http://www.sgs.com/en/Terms-and-Conditions.aspx> and, for electronic format documents, subject to Terms and Conditions for Electronic Documents at <http://www.sgs.com/en/Terms-and-Conditions/Terms-e-Documents.aspx>. Attention is drawn to the limitation of liability, indemnification and jurisdiction issues defined therein. Any holder of this document is advised that information contained hereon reflects the Company's findings at the time of its intervention only and within the limits of Client's instructions, if any. The Company's sole responsibility is to its Client and this document does not exonerate parties to a transaction from exercising all their rights and obligations under the transaction documents. This document cannot be reproduced except in full, without prior written approval of the Company. Any unauthorized alteration, forgery or falsification of the content or appearance of this document is unlawful and offenders may be prosecuted to the fullest extent of the law. Unless otherwise stated the results shown in this test report refer only to the sample(s) tested and such sample(s) are retained for 30 days only.

Attention: To check the authenticity of testing/inspection report & certificate, please contact us at telephone: (86-755) 8307 1443, or email: CN.Doccheck@sgs.com

South of No. 6 Plant, No. 1, Runsheng Road, Suzhou Industrial Park, Suzhou Area, China (Jiangsu) Pilot Free Trade Zone 215000
 中国·苏州·中国(江苏)自由贸易试验区苏州片区苏州工业园区润胜路1号的6号厂房南楼 邮编: 215000

t (86-512) 62992980 www.sgs.com.cn
 t (86-512) 62992980 sgs.china@sgs.com

Report No.: SEWM2309000380RG04

Rev.: 01

Page: 29 of 112

7 Photographs - Setup Photos

Refer to Appendix A.2 WLAN Setup Photos.



Unless otherwise agreed in writing, this document is issued by the Company subject to its General Conditions of Service printed overleaf, available on request or accessible at <http://www.sgs.com/en/Terms-and-Conditions.aspx> and, for electronic format documents, subject to Terms and Conditions for Electronic Documents at <http://www.sgs.com/en/Terms-and-Conditions/Terms-e-Documents.aspx>. Attention is drawn to the limitation of liability, indemnification and jurisdiction issues defined therein. Any holder of this document is advised that information contained hereon reflects the Company's findings at the time of its intervention only and within the limits of Client's instructions, if any. The Company's sole responsibility is to its Client and this document does not exonerate parties to a transaction from exercising all their rights and obligations under the transaction documents. This document cannot be reproduced except in full, without prior written approval of the Company. Any unauthorized alteration, forgery or falsification of the content or appearance of this document is unlawful and offenders may be prosecuted to the fullest extent of the law. Unless otherwise stated the results shown in this test report refer only to the sample(s) tested and such sample(s) are retained for 30 days only.
Attention: To check the authenticity of testing/inspection report & certificate, please contact us at telephone: (86-755) 8307 1443, or email: CN.Doccheck@sgs.com

South of No. 6 Plant, No. 1, Runsheng Road, Suzhou Industrial Park, Suzhou Area, China (Jiangsu) Pilot Free Trade Zone 215000
中国·苏州·中国(江苏)自由贸易试验区苏州片区苏州工业园区润胜路1号的6号厂房南楼 邮编: 215000

t (86-512) 62992980 www.sgs.com.cn
t (86-512) 62992980 sgs.china@sgs.com

Report No.: SEWM2309000380RG04

Rev.: 01

Page: 30 of 112

Appendix



Unless otherwise agreed in writing, this document is issued by the Company subject to its General Conditions of Service printed overleaf, available on request or accessible at <http://www.sgs.com/en/Terms-and-Conditions.aspx> and, for electronic format documents, subject to Terms and Conditions for Electronic Documents at <http://www.sgs.com/en/Terms-and-Conditions/Terms-e-Document.aspx>. Attention is drawn to the limitation of liability, indemnification and jurisdiction issues defined therein. Any holder of this document is advised that information contained hereon reflects the Company's findings at the time of its intervention only and within the limits of Client's instructions, if any. The Company's sole responsibility is to its Client and this document does not exonerate parties to a transaction from exercising all their rights and obligations under the transaction documents. This document cannot be reproduced except in full, without prior written approval of the Company. Any unauthorized alteration, forgery or falsification of the content or appearance of this document is unlawful and offenders may be prosecuted to the fullest extent of the law. Unless otherwise stated the results shown in this test report refer only to the sample(s) tested and such sample(s) are retained for 30 days only.

Attention: To check the authenticity of testing/inspection report & certificate, please contact us at telephone: (86-755) 8307 1443, or email: CN.Doccheck@sgs.com

South of No. 6 Plant, No. 1, Runsheng Road, Suzhou Industrial Park, Suzhou Area, China (Jiangsu) Pilot Free Trade Zone 215000 t (86-512) 62992980 www.sgs.com.cn
中国·苏州·中国(江苏)自由贸易试验区苏州片区苏州工业园区润胜路1号的6号厂房南楼 邮编: 215000 t (86-512) 62992980 sgs.china@sgs.com

Report No.: SEWM2309000380RG04

Rev.: 01

Page: 31 of 112

DTS Bandwidth Test Result

TestMode	Antenna	Frequency[MHz]	DTS BW [MHz]	FL[MHz]	FH[MHz]	Limit[MHz]	Verdict
11b	Ant2	2412	8.60	2407.48	2416.08	≥0.5	PASS
11b	Ant2	2437	8.16	2432.92	2441.08	≥0.5	PASS
11b	Ant2	2462	8.12	2457.92	2466.04	≥0.5	PASS
11g	Ant2	2412	15.16	2404.44	2419.60	≥0.5	PASS
11g	Ant2	2437	15.24	2429.36	2444.60	≥0.5	PASS
11g	Ant2	2462	15.12	2454.44	2469.56	≥0.5	PASS
11n20SISO	Ant2	2412	15.20	2404.40	2419.60	≥0.5	PASS
11n20SISO	Ant2	2437	15.24	2429.36	2444.60	≥0.5	PASS
11n20SISO	Ant2	2462	15.16	2454.40	2469.56	≥0.5	PASS
11n40SISO	Ant2	2422	35.28	2404.32	2439.60	≥0.5	PASS
11n40SISO	Ant2	2437	35.28	2419.32	2454.60	≥0.5	PASS
11n40SISO	Ant2	2452	35.28	2434.32	2469.60	≥0.5	PASS



Unless otherwise agreed in writing, this document is issued by the Company subject to its General Conditions of Service printed overleaf, available on request or accessible at <http://www.sgs.com/en/Terms-and-Conditions.aspx> and, for electronic format documents, subject to Terms and Conditions for Electronic Documents at <http://www.sgs.com/en/Terms-and-Conditions/Terms-e-Document.aspx>. Attention is drawn to the limitation of liability, indemnification and jurisdiction issues defined therein. Any holder of this document is advised that information contained hereon reflects the Company's findings at the time of its intervention only and within the limits of Client's instructions, if any. The Company's sole responsibility is to its Client and this document does not exonerate parties to a transaction from exercising all their rights and obligations under the transaction documents. This document cannot be reproduced except in full, without prior written approval of the Company. Any unauthorized alteration, forgery or falsification of the content or appearance of this document is unlawful and offenders may be prosecuted to the fullest extent of the law. Unless otherwise stated the results shown in this test report refer only to the sample(s) tested and such sample(s) are retained for 30 days only.

Attention: To check the authenticity of testing/inspection report & certificate, please contact us at telephone: (86-755) 8307 1443, or email: CN.Doccheck@sgs.com

South of No. 6 Plant, No. 1, Runsheng Road, Suzhou Industrial Park, Suzhou Area, China (Jiangsu) Pilot Free Trade Zone 215000
 中国·苏州·中国(江苏)自由贸易试验区苏州片区苏州工业园区润胜路1号的6号厂房南楼 邮编: 215000

t (86-512) 62992980 www.sgs.com.cn
 t (86-512) 62992980 sgs.china@sgs.com

Test Graphs

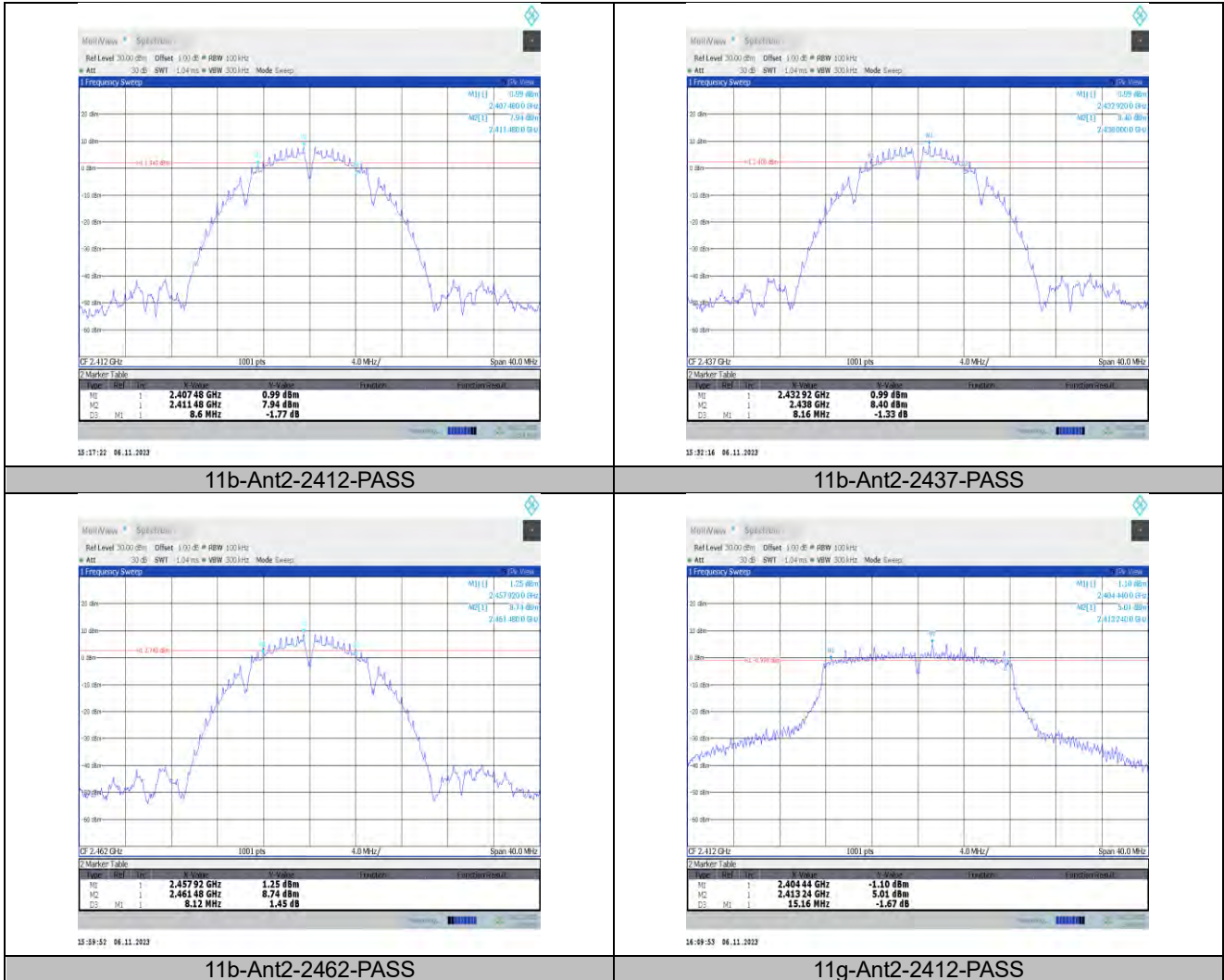

Unless otherwise agreed in writing, this document is issued by the Company subject to its General Conditions of Service printed overleaf, available on request or accessible at <http://www.sgs.com/en/Terms-and-Conditions.aspx> and, for electronic format documents, subject to Terms and Conditions for Electronic Documents at <http://www.sgs.com/en/Terms-and-Conditions/Terms-e-Documents.aspx>. Attention is drawn to the limitation of liability, indemnification and jurisdiction issues defined therein. Any holder of this document is advised that information contained hereon reflects the Company's findings at the time of its intervention only and within the limits of Client's instructions, if any. The Company's sole responsibility is to its Client and this document does not exonerate parties to a transaction from exercising all their rights and obligations under the transaction documents. This document cannot be reproduced except in full, without prior written approval of the Company. Any unauthorized alteration, forgery or falsification of the content or appearance of this document is unlawful and offenders may be prosecuted to the fullest extent of the law. Unless otherwise stated the results shown in this test report refer only to the sample(s) tested and such sample(s) are retained for 30 days only.
Attention: To check the authenticity of testing/inspection report & certificate, please contact us at telephone: (86-755) 8307 1443, or email: CN.Doccheck@sgs.com
 South of No. 6 Plant, No. 1, Runsheng Road, Suzhou Industrial Park, Suzhou Area, China (Jiangsu) Pilot Free Trade Zone 215000 t (86-512) 62992980 www.sgs.com.cn
 中国·苏州·中国(江苏)自由贸易试验区苏州片区苏州工业园区润胜路1号的6号厂房南座 邮编: 215000 t (86-512) 62992980 sgs.china@sgs.com

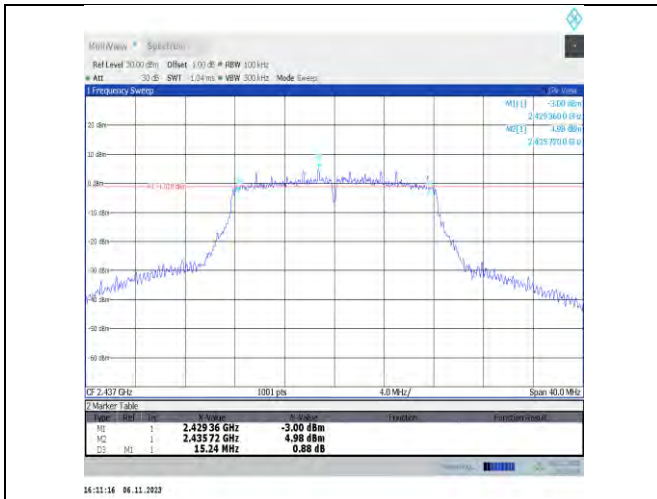

11g-Ant2-2437-PASS

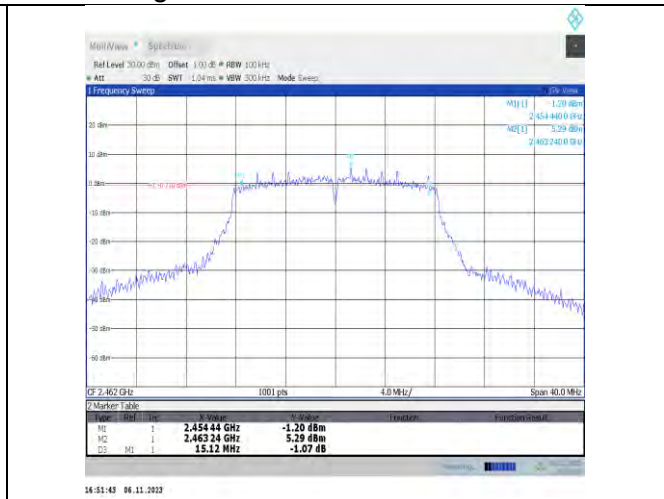

11g-Ant2-2462-PASS

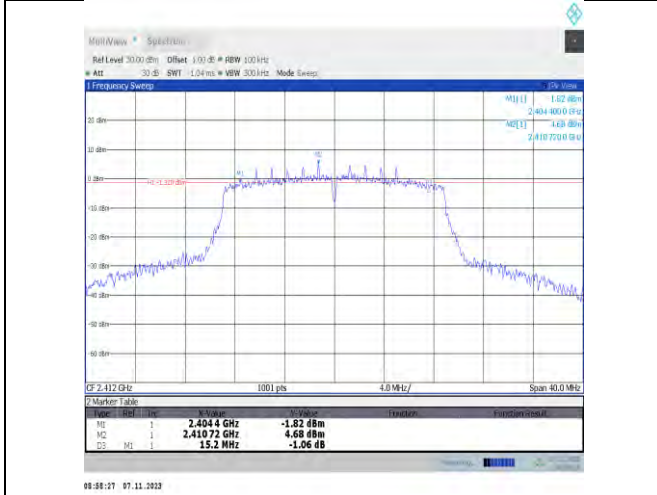

11n20SISO-Ant2-2412-PASS

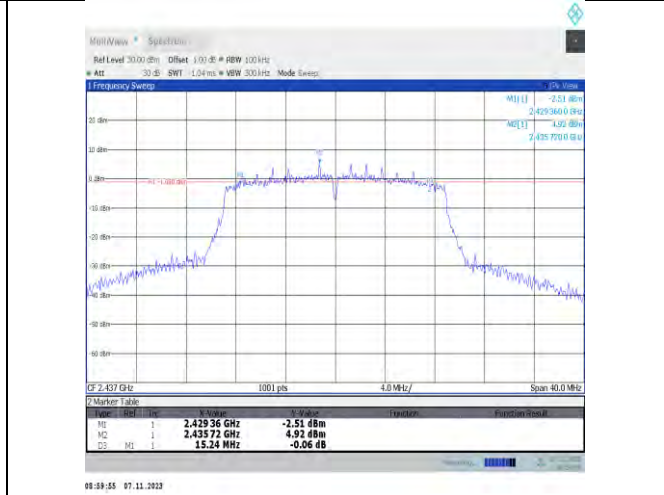

11n20SISO-Ant2-2437-PASS

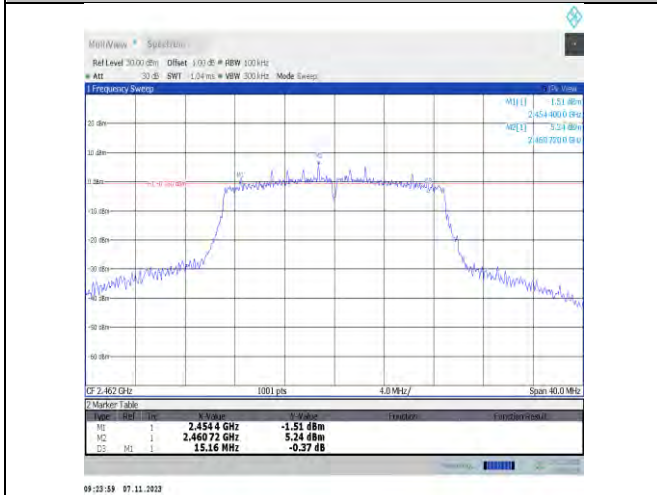

11n20SISO-Ant2-2462-PASS

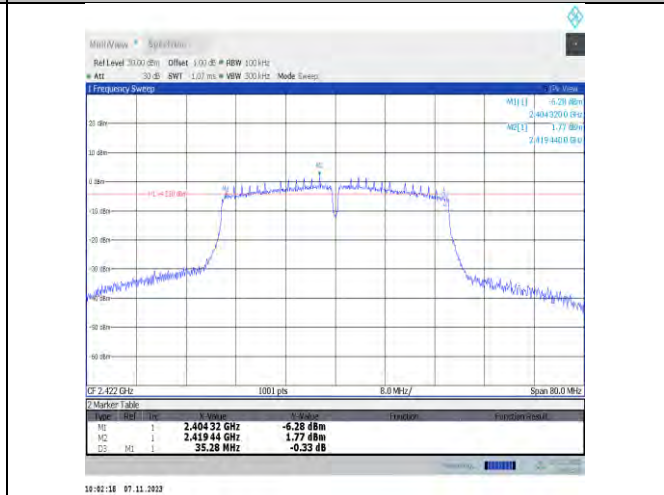

11n40SISO-Ant2-2422-PASS



Unless otherwise agreed in writing, this document is issued by the Company subject to its General Conditions of Service printed overleaf, available on request or accessible at <http://www.sgs.com/en/Terms-and-Conditions.aspx> and, for electronic format documents, subject to Terms and Conditions for Electronic Documents at <http://www.sgs.com/en/Terms-and-Conditions/Terms-e-Documents.aspx>. Attention is drawn to the limitation of liability, indemnification and jurisdiction issues defined therein. Any holder of this document is advised that information contained hereon reflects the Company's findings at the time of its intervention only and within the limits of Client's instructions, if any. The Company's sole responsibility is to its Client and this document does not exonerate parties to a transaction from exercising all their rights and obligations under the transaction documents. This document cannot be reproduced except in full, without prior written approval of the Company. Any unauthorized alteration, forgery or falsification of the content or appearance of this document is unlawful and offenders may be prosecuted to the fullest extent of the law. Unless otherwise stated the results shown in this test report refer only to the sample(s) tested and such sample(s) are retained for 30 days only.

Attention: To check the authenticity of testing/inspection report & certificate, please contact us at telephone: (86-755) 8307 1443, or email: CN.Doccheck@sgs.com
 South of No. 6 Plant, No. 1, Runsheng Road, Suzhou Industrial Park, Suzhou Area, China (Jiangsu) Pilot Free Trade Zone 215000 t (86-512) 62992980 www.sgs.com.cn
 中国·苏州·中国(江苏)自由贸易试验区苏州片区苏州工业园区润胜路1号的6号厂房南楼 邮编: 215000 t (86-512) 62992980 sgs.china@sgs.com

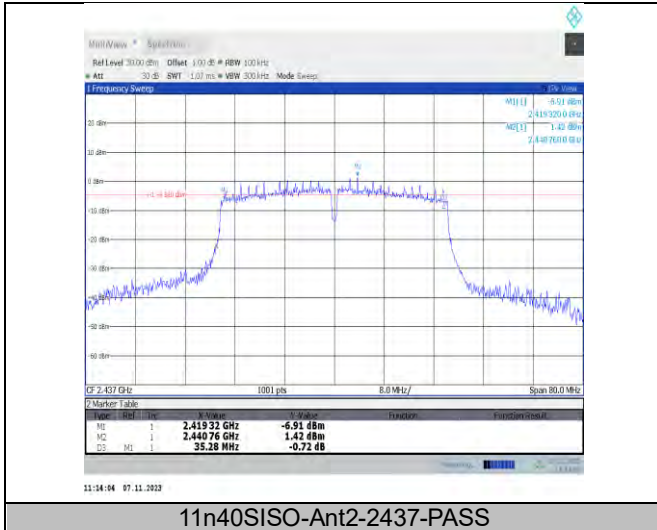

11n40SISO-Ant2-2437-PASS

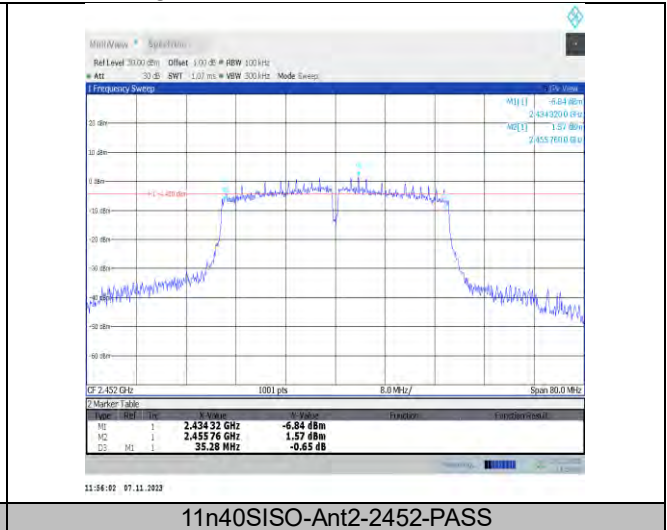

11n40SISO-Ant2-2452-PASS



Unless otherwise agreed in writing, this document is issued by the Company subject to its General Conditions of Service printed overleaf, available on request or accessible at <http://www.sgs.com/en/Terms-and-Conditions.aspx> and, for electronic format documents, subject to Terms and Conditions for Electronic Documents at <http://www.sgs.com/en/Terms-and-Conditions/Terms-e-Documents.aspx>. Attention is drawn to the limitation of liability, indemnification and jurisdiction issues defined therein. Any holder of this document is advised that information contained hereon reflects the Company's findings at the time of its intervention only and within the limits of Client's instructions, if any. The Company's sole responsibility is to its Client and this document does not exonerate parties to a transaction from exercising all their rights and obligations under the transaction documents. This document cannot be reproduced except in full, without prior written approval of the Company. Any unauthorized alteration, forgery or falsification of the content or appearance of this document is unlawful and offenders may be prosecuted to the fullest extent of the law. Unless otherwise stated the results shown in this test report refer only to the sample(s) tested and such sample(s) are retained for 30 days.

Attention: To check the authenticity of testing/inspection report & certificate, please contact us at telephone: (86-755) 8307 1443, or email: CN.Doccheck@sgs.com

South of No. 6 Plant, No. 1, Runsheng Road, Suzhou Industrial Park, Suzhou Area, China (Jiangsu) Pilot Free Trade Zone 215000 t (86-512) 62992980 www.sgs.com.cn
 中国·苏州·中国(江苏)自由贸易试验区苏州片区苏州工业园区润胜路1号的6号厂房南楼 邮编: 215000 t (86-512) 62992980 sgs.china@sgs.com

Occupied Channel Bandwidth Test Result

TestMode	Antenna	Channel Frequency[MHz]	OCB [MHz]	FL[MHz]	FH[MHz]	Verdict
11b	Ant2	2412	12.925	2405.4914	2418.4161	For Report Purpose
11b	Ant2	2437	12.905	2430.5206	2443.4259	
11b	Ant2	2462	12.896	2455.5049	2468.4006	
11g	Ant2	2412	17.024	2403.4316	2420.4555	
11g	Ant2	2437	16.978	2428.4808	2445.4590	
11g	Ant2	2462	16.989	2453.4973	2470.4861	
11n20SISO	Ant2	2412	17.988	2402.9952	2420.9834	
11n20SISO	Ant2	2437	17.98	2427.9718	2445.9516	
11n20SISO	Ant2	2462	17.993	2452.9848	2470.9778	
11n40SISO	Ant2	2422	36.336	2403.7697	2440.1060	
11n40SISO	Ant2	2437	36.298	2418.7862	2455.0841	
11n40SISO	Ant2	2452	36.334	2433.7697	2470.1033	



Unless otherwise agreed in writing, this document is issued by the Company subject to its General Conditions of Service printed overleaf, available on request or accessible at <http://www.sgs.com/en/Terms-and-Conditions.aspx> and, for electronic format documents, subject to Terms and Conditions for Electronic Documents at <http://www.sgs.com/en/Terms-and-Conditions/Terms-e-Documents.aspx>. Attention is drawn to the limitation of liability, indemnification and jurisdiction issues defined therein. Any holder of this document is advised that information contained hereon reflects the Company's findings at the time of its intervention only and within the limits of Client's instructions, if any. The Company's sole responsibility is to its Client and this document does not exonerate parties to a transaction from exercising all their rights and obligations under the transaction documents. This document cannot be reproduced except in full, without prior written approval of the Company. Any unauthorized alteration, forgery or falsification of the content or appearance of this document is unlawful and offenders may be prosecuted to the fullest extent of the law. Unless otherwise stated the results shown in this test report refer only to the sample(s) tested and such sample(s) are retained for 30 days only.

Attention: To check the authenticity of testing/inspection report & certificate, please contact us at telephone: (86-755) 8307 1443, or email: CN.Doccheck@sgs.com

South of No. 6 Plant, No. 1, Runsheng Road, Suzhou Industrial Park, Suzhou Area, China (Jiangsu) Pilot Free Trade Zone 215000
 中国·苏州·中国(江苏)自由贸易试验区苏州片区苏州工业园区润胜路1号的6号厂房南楼 邮编: 215000

t (86-512) 62992980 www.sgs.com.cn
 t (86-512) 62992980 sgs.china@sgs.com

Test Graphs

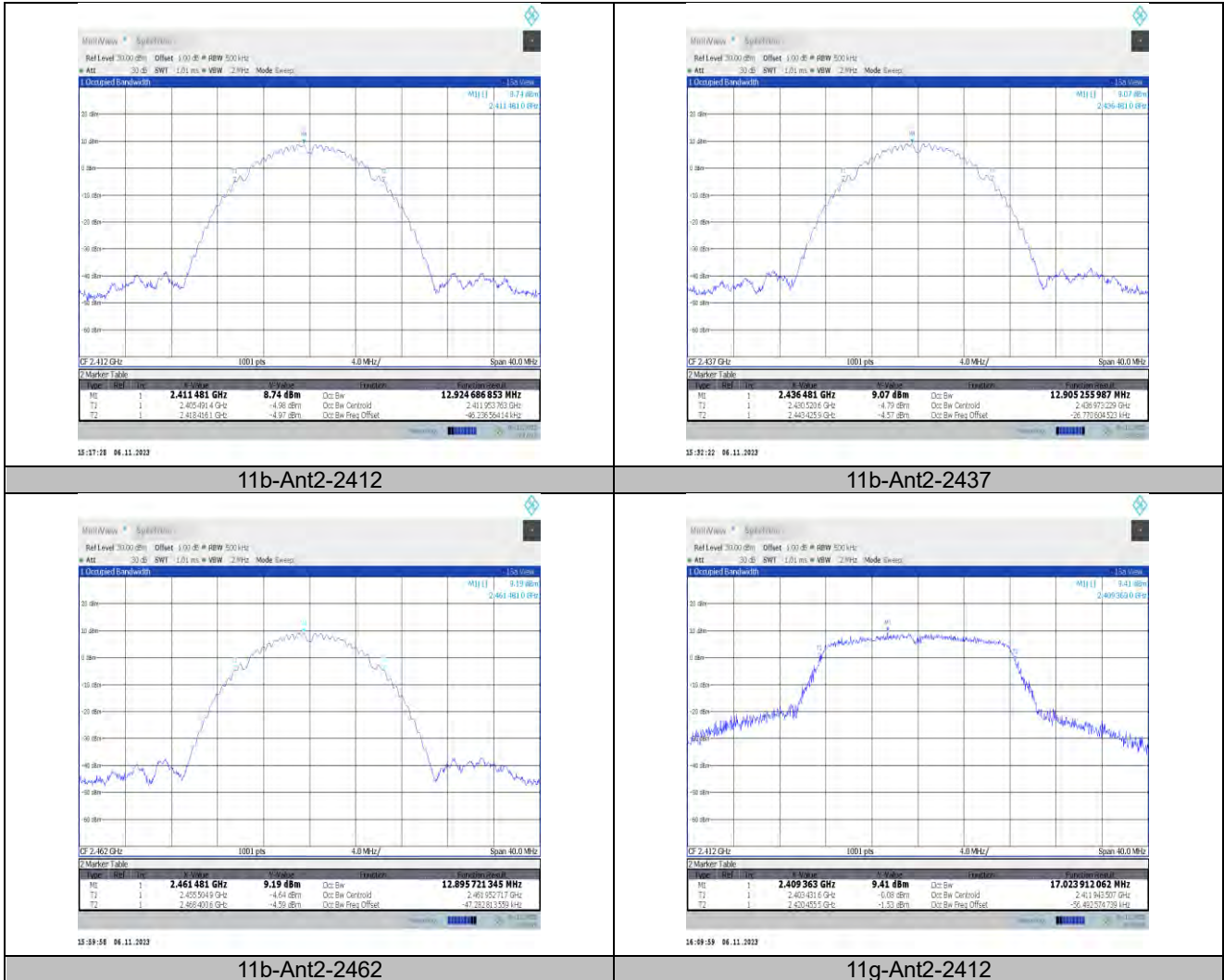

Unless otherwise agreed in writing, this document is issued by the Company subject to its General Conditions of Service printed overleaf, available on request or accessible at <http://www.sgs.com/en/Terms-and-Conditions.aspx> and, for electronic format documents, subject to Terms and Conditions for Electronic Documents at <http://www.sgs.com/en/Terms-and-Conditions/Terms-e-Documents.aspx>. Attention is drawn to the limitation of liability, indemnification and jurisdiction issues defined therein. Any holder of this document is advised that information contained hereon reflects the Company's findings at the time of its intervention only and within the limits of Client's instructions, if any. The Company's sole responsibility is to its Client and this document does not exonerate parties to a transaction from exercising all their rights and obligations under the transaction documents. This document cannot be reproduced except in full, without prior written approval of the Company. Any unauthorized alteration, forgery or falsification of the content or appearance of this document is unlawful and offenders may be prosecuted to the fullest extent of the law. Unless otherwise stated the results shown in this test report refer only to the sample(s) tested and such sample(s) are retained for 30 days only.

Attention: To check the authenticity of testing/inspection report & certificate, please contact us at telephone: (86-755) 8307 1443, or email: CN.Doccheck@sgs.com

South of No. 6 Plant, No. 1, Runsheng Road, Suzhou Industrial Park, Suzhou Area, China (Jiangsu) Pilot Free Trade Zone 215000 t (86-512) 62992980 www.sgs.com.cn
 中国·苏州·中国(江苏)自由贸易试验区苏州片区苏州工业园区润胜路1号的6号厂房南座 邮编: 215000 t (86-512) 62992980 sgs.china@sgs.com

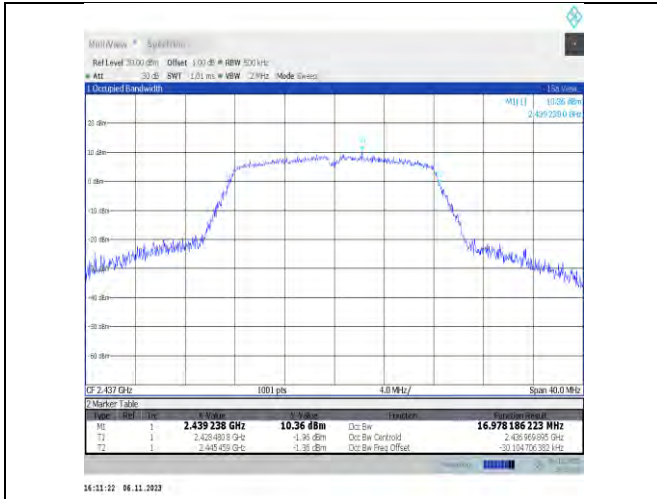

11g-Ant2-2437

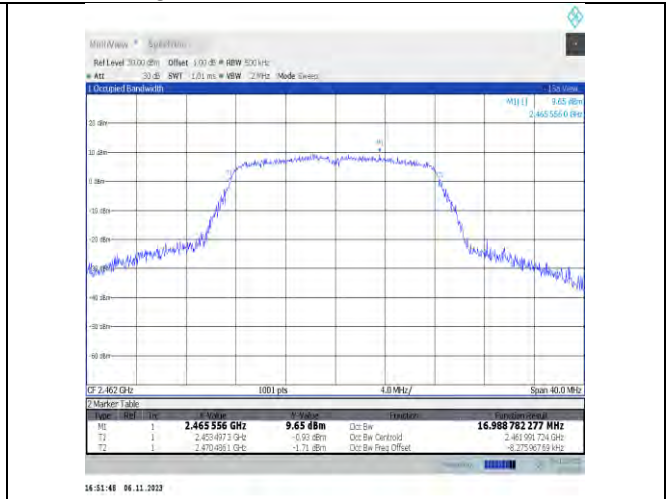

11g-Ant2-2462

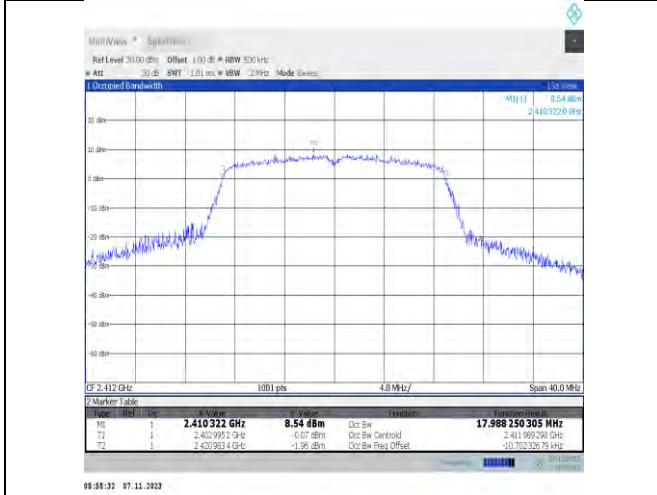

11n20SISO-Ant2-2412

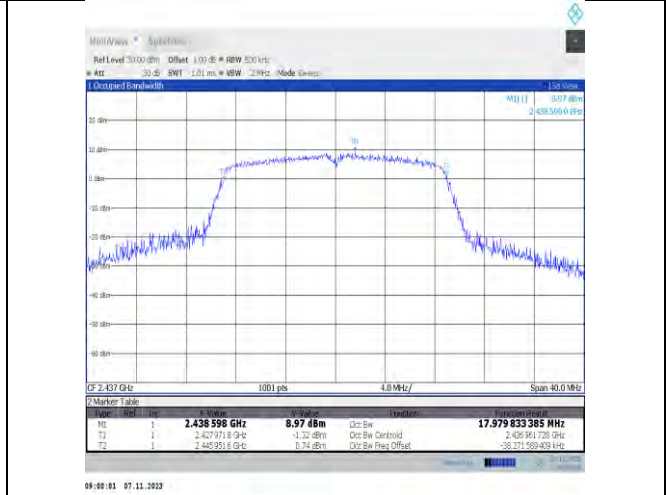

11n20SISO-Ant2-2437

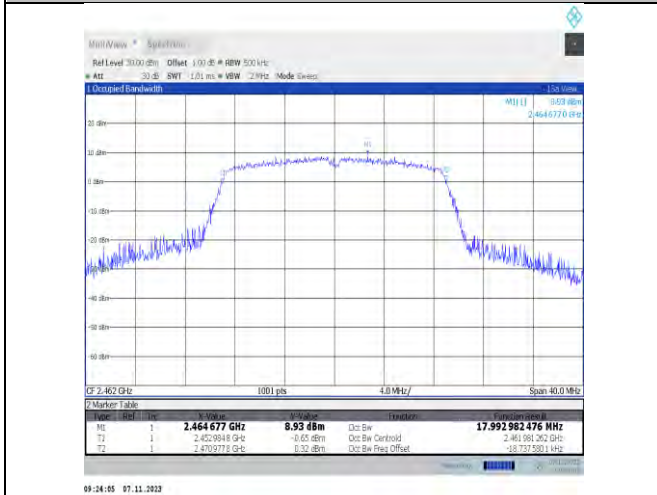

11n20SISO-Ant2-2462

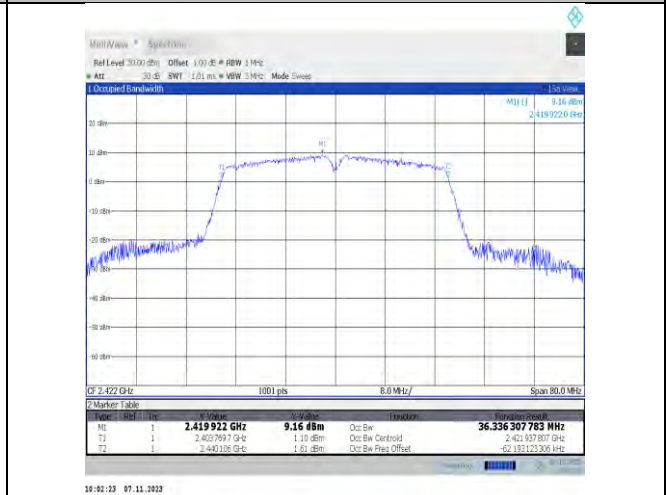

11n40SISO-Ant2-2422



Unless otherwise agreed in writing, this document is issued by the Company subject to its General Conditions of Service printed overleaf, available on request or accessible at <http://www.sgs.com/en/Terms-and-Conditions.aspx> and, for electronic format documents, subject to Terms and Conditions for Electronic Documents at <http://www.sgs.com/en/Terms-and-Conditions/Terms-e-Documents.aspx>. Attention is drawn to the limitation of liability, indemnification and jurisdiction issues defined therein. Any holder of this document is advised that information contained hereon reflects the Company's findings at the time of its intervention only and within the limits of Client's instructions, if any. The Company's sole responsibility is to its Client and this document does not exonerate parties to a transaction from exercising all their rights and obligations under the transaction documents. This document cannot be reproduced except in full, without prior written approval of the Company. Any unauthorized alteration, forgery or falsification of the content or appearance of this document is unlawful and offenders may be prosecuted to the fullest extent of the law. Unless otherwise stated the results shown in this test report refer only to the sample(s) tested and such sample(s) are retained for 30 days only.

Attention: To check the authenticity of testing/inspection report & certificate, please contact us at telephone: (86-755) 8307 1443, or email: CN.Doccheck@sgs.com
 South of No. 6 Plant, No. 1, Runsheng Road, Suzhou Industrial Park, Suzhou Area, China (Jiangsu) Pilot Free Trade Zone 215000 t (86-512) 62992980 www.sgs.com.cn
 中国·苏州·中国(江苏)自由贸易试验区苏州片区苏州工业园区润胜路1号的6号厂房南楼 邮编: 215000 t (86-512) 62992980 sgs.china@sgs.com

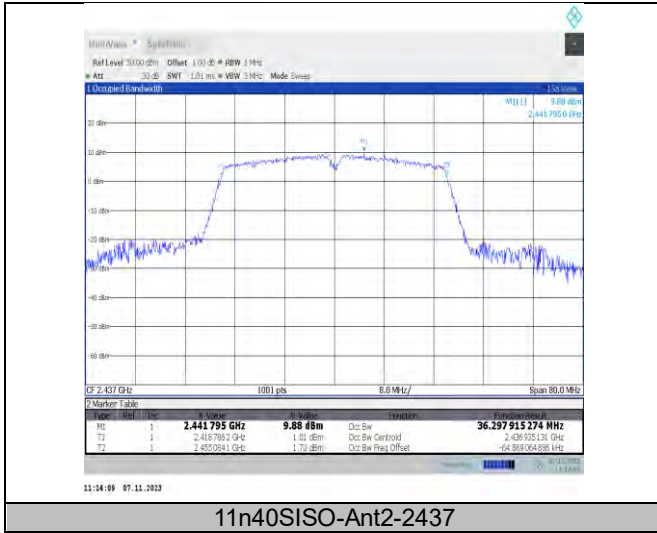

11n40SISO-Ant2-2437

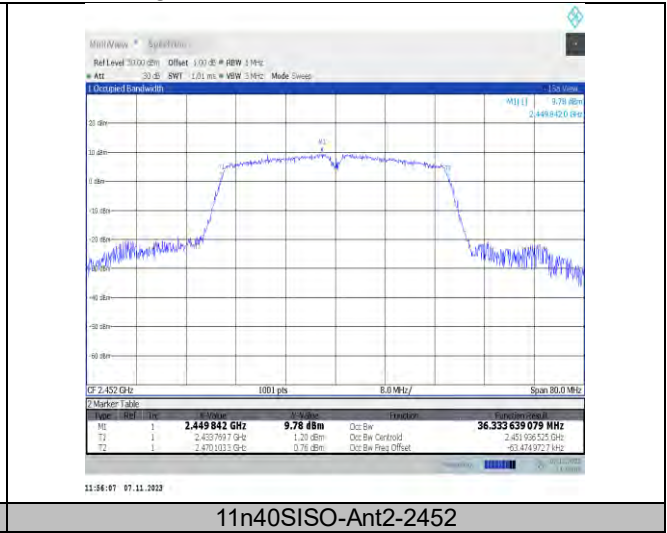

11n40SISO-Ant2-2452



Unless otherwise agreed in writing, this document is issued by the Company subject to its General Conditions of Service printed overleaf, available on request or accessible at <http://www.sgs.com/en/Terms-and-Conditions.aspx> and, for electronic format documents, subject to Terms and Conditions for Electronic Documents at <http://www.sgs.com/en/Terms-and-Conditions/Terms-e-Documents.aspx>. Attention is drawn to the limitation of liability, indemnification and jurisdiction issues defined therein. Any holder of this document is advised that information contained hereon reflects the Company's findings at the time of its intervention only and within the limits of Client's instructions, if any. The Company's sole responsibility is to its Client and this document does not exonerate parties to a transaction from exercising all their rights and obligations under the transaction documents. This document cannot be reproduced except in full, without prior written approval of the Company. Any unauthorized alteration, forgery or falsification of the content or appearance of this document is unlawful and offenders may be prosecuted to the fullest extent of the law. Unless otherwise stated the results shown in this test report refer only to the sample(s) tested and such sample(s) are retained for 30 days only.

Attention: To check the authenticity of testing/inspection report & certificate, please contact us at telephone: (86-755) 8307 1443, or email: CN.Doccheck@sgs.com

South of No. 6 Plant, No. 1, Runsheng Road, Suzhou Industrial Park, Suzhou Area, China (Jiangsu) Pilot Free Trade Zone 215000 t (86-512) 62992980 www.sgs.com.cn
 中国·苏州·中国(江苏)自由贸易试验区苏州片区苏州工业园区润胜路1号的6号厂房南楼 邮编: 215000 t (86-512) 62992980 sgs.china@sgs.com

Report No.: SEWM2309000380RG04

Rev.: 01

Page: 39 of 112

**Maximum conducted output power
Test Result Peak**

TestMode	Antenna	Frequency[MHz]	Peak Power[dBm]	Conducted Limit[dBm]	Verdict
11b	Ant2	2412	18.70	≤30.00	PASS
11b	Ant2	2437	18.93	≤30.00	PASS
11b	Ant2	2462	18.87	≤30.00	PASS
11g	Ant2	2412	23.23	≤30.00	PASS
11g	Ant2	2437	23.56	≤30.00	PASS
11g	Ant2	2462	23.88	≤30.00	PASS
11n20SISO	Ant2	2412	23.53	≤30.00	PASS
11n20SISO	Ant2	2437	23.60	≤30.00	PASS
11n20SISO	Ant2	2462	23.51	≤30.00	PASS
11n40SISO	Ant2	2422	23.12	≤30.00	PASS
11n40SISO	Ant2	2437	23.16	≤30.00	PASS
11n40SISO	Ant2	2452	23.11	≤30.00	PASS



Unless otherwise agreed in writing, this document is issued by the Company subject to its General Conditions of Service printed overleaf, available on request or accessible at <http://www.sgs.com/en/Terms-and-Conditions.aspx> and, for electronic format documents, subject to Terms and Conditions for Electronic Documents at <http://www.sgs.com/en/Terms-and-Conditions/Terms-e-Documents.aspx>. Attention is drawn to the limitation of liability, indemnification and jurisdiction issues defined therein. Any holder of this document is advised that information contained hereon reflects the Company's findings at the time of its intervention only and within the limits of Client's instructions, if any. The Company's sole responsibility is to its Client and this document does not exonerate parties to a transaction from exercising all their rights and obligations under the transaction documents. This document cannot be reproduced except in full, without prior written approval of the Company. Any unauthorized alteration, forgery or falsification of the content or appearance of this document is unlawful and offenders may be prosecuted to the fullest extent of the law. Unless otherwise stated the results shown in this test report refer only to the sample(s) tested and such sample(s) are retained for 30 days only.

Attention: To check the authenticity of testing/inspection report & certificate, please contact us at telephone: (86-755) 8307 1443, or email: CN.Doccheck@sgs.com

South of No. 6 Plant, No. 1, Runsheng Road, Suzhou Industrial Park, Suzhou Area, China (Jiangsu) Pilot Free Trade Zone 215000
中国·苏州·中国(江苏)自由贸易试验区苏州片区苏州工业园区润胜路1号的6号厂房南楼 邮编: 215000

t (86-512) 62992980 www.sgs.com.cn
t (86-512) 62992980 sgs.china@sgs.com

Report No.: SEWM2309000380RG04

Rev.: 01

Page: 40 of 112

**Maximum power spectral density
Test Result**

TestMode	Antenna	Frequency[MHz]	Result[dBm/3kHz]	Limit[dBm/3kHz]	Verdict
11b	Ant2	2412	-5.28	≤8.00	PASS
11b	Ant2	2437	-4.68	≤8.00	PASS
11b	Ant2	2462	-5.12	≤8.00	PASS
11g	Ant2	2412	-7.65	≤8.00	PASS
11g	Ant2	2437	-8.46	≤8.00	PASS
11g	Ant2	2462	-6.91	≤8.00	PASS
11n20SISO	Ant2	2412	-8.84	≤8.00	PASS
11n20SISO	Ant2	2437	-6.64	≤8.00	PASS
11n20SISO	Ant2	2462	-9.21	≤8.00	PASS
11n40SISO	Ant2	2422	-9.97	≤8.00	PASS
11n40SISO	Ant2	2437	-12.04	≤8.00	PASS
11n40SISO	Ant2	2452	-12.87	≤8.00	PASS



Unless otherwise agreed in writing, this document is issued by the Company subject to its General Conditions of Service printed overleaf, available on request or accessible at <http://www.sgs.com/en/Terms-and-Conditions.aspx> and, for electronic format documents, subject to Terms and Conditions for Electronic Documents at <http://www.sgs.com/en/Terms-and-Conditions/Terms-e-Documents.aspx>. Attention is drawn to the limitation of liability, indemnification and jurisdiction issues defined therein. Any holder of this document is advised that information contained hereon reflects the Company's findings at the time of its intervention only and within the limits of Client's instructions, if any. The Company's sole responsibility is to its Client and this document does not exonerate parties to a transaction from exercising all their rights and obligations under the transaction documents. This document cannot be reproduced except in full, without prior written approval of the Company. Any unauthorized alteration, forgery or falsification of the content or appearance of this document is unlawful and offenders may be prosecuted to the fullest extent of the law. Unless otherwise stated the results shown in this test report refer only to the sample(s) tested and such sample(s) are retained for 30 days only.

Attention: To check the authenticity of testing/inspection report & certificate, please contact us at telephone: (86-755) 8307 1443, or email: CN.Doccheck@sgs.com

South of No. 6 Plant, No. 1, Runsheng Road, Suzhou Industrial Park, Suzhou Area, China (Jiangsu) Pilot Free Trade Zone 215000 t (86-512) 62992980 www.sgs.com.cn
 中国·苏州·中国(江苏)自由贸易试验区苏州片区苏州工业园区润胜路1号的6号厂房南楼 邮编: 215000 t (86-512) 62992980 sgs.china@sgs.com

Test Graphs

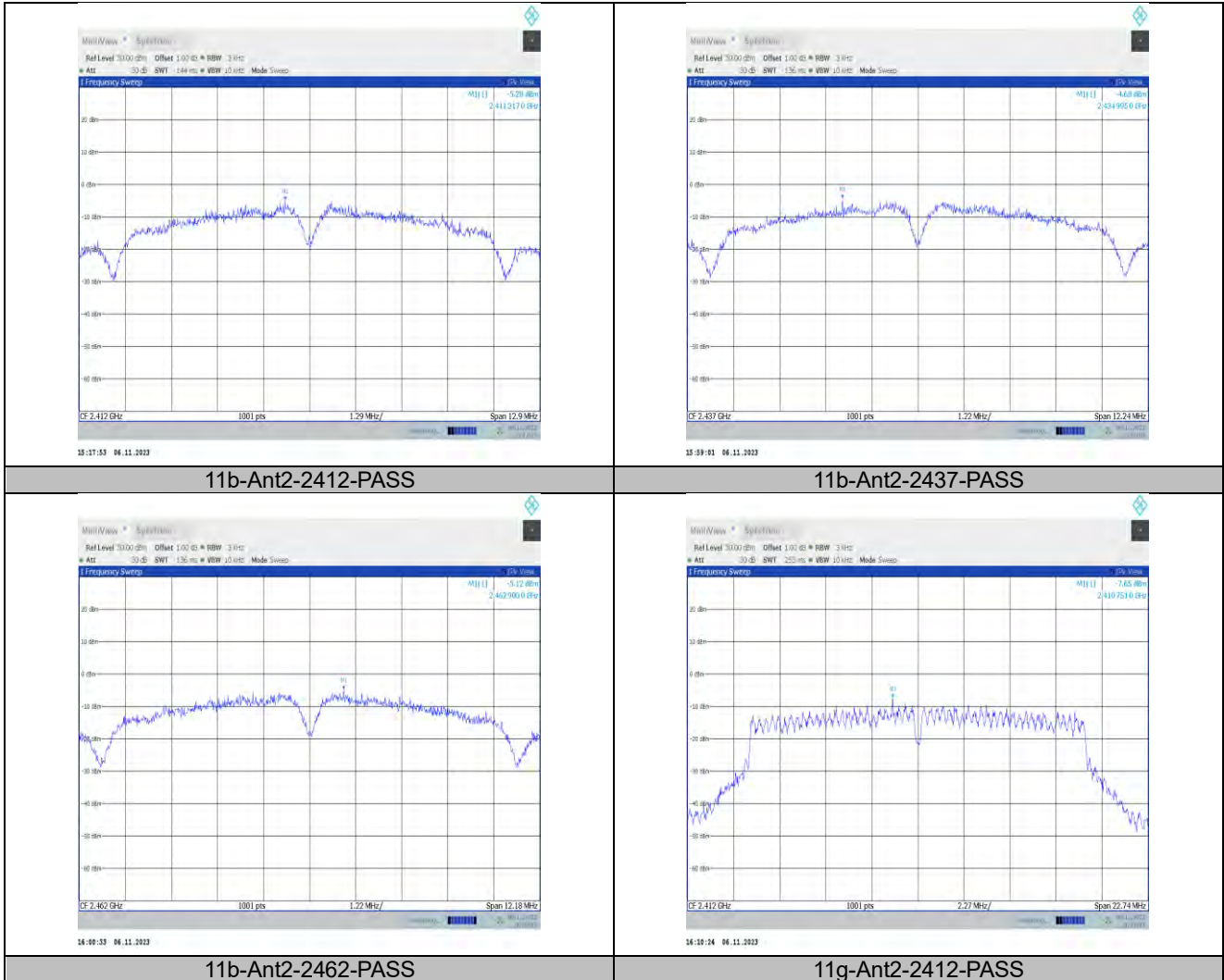

Unless otherwise agreed in writing, this document is issued by the Company subject to its General Conditions of Service printed overleaf, available on request or accessible at <http://www.sgs.com/en/Terms-and-Conditions.aspx> and, for electronic format documents, subject to Terms and Conditions for Electronic Documents at <http://www.sgs.com/en/Terms-and-Conditions/Terms-e-Documents.aspx>. Attention is drawn to the limitation of liability, indemnification and jurisdiction issues defined therein. Any holder of this document is advised that information contained hereon reflects the Company's findings at the time of its intervention only and within the limits of Client's instructions, if any. The Company's sole responsibility is to its Client and this document does not exonerate parties to a transaction from exercising all their rights and obligations under the transaction documents. This document cannot be reproduced except in full, without prior written approval of the Company. Any unauthorized alteration, forgery or falsification of the content or appearance of this document is unlawful and offenders may be prosecuted to the fullest extent of the law. Unless otherwise stated the results shown in this test report refer only to the sample(s) tested and such sample(s) are retained for 30 days only.

Attention: To check the authenticity of testing/inspection report & certificate, please contact us at telephone: (86-755) 8307 1443, or email: CN_Doccheck@sgs.com

South of No. 6 Plant, No. 1, Runsheng Road, Suzhou Industrial Park, Suzhou Area, China (Jiangsu) Pilot Free Trade Zone 215000 t (86-512) 62992980 www.sgs.com.cn
 中国·苏州·中国(江苏)自由贸易试验区苏州片区苏州工业园区润胜路1号的6号厂房南楼 邮编: 215000 t (86-512) 62992980 sgs.china@sgs.com

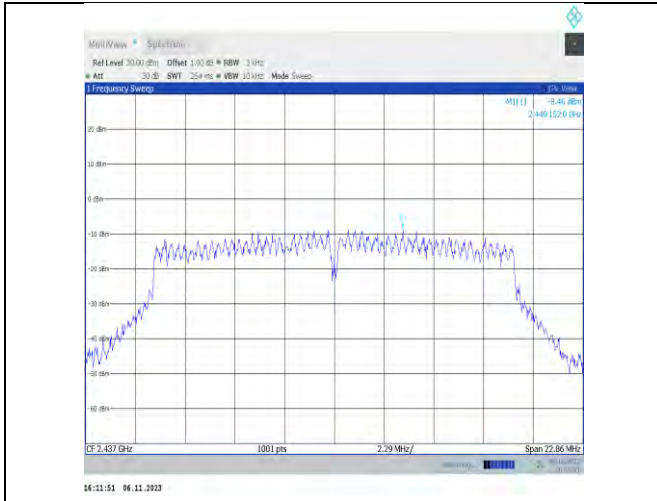

11g-Ant2-2437-PASS

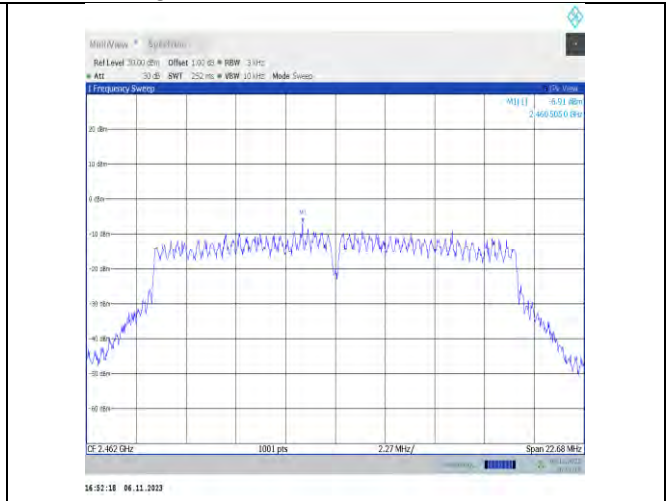

11g-Ant2-2462-PASS

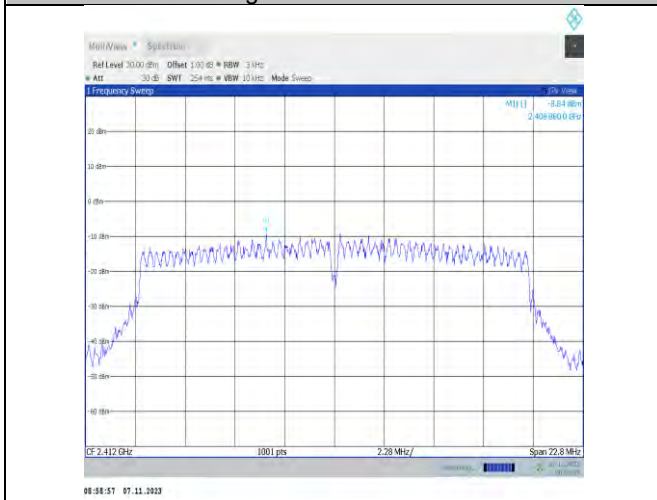

11n20SISO-Ant2-2412-PASS

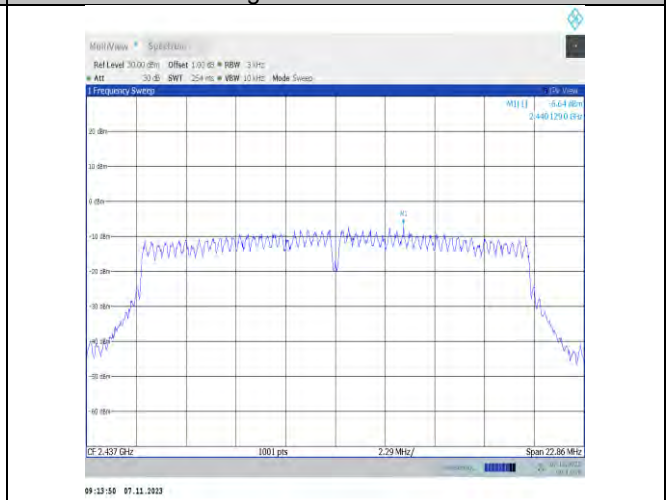

11n20SISO-Ant2-2437-PASS

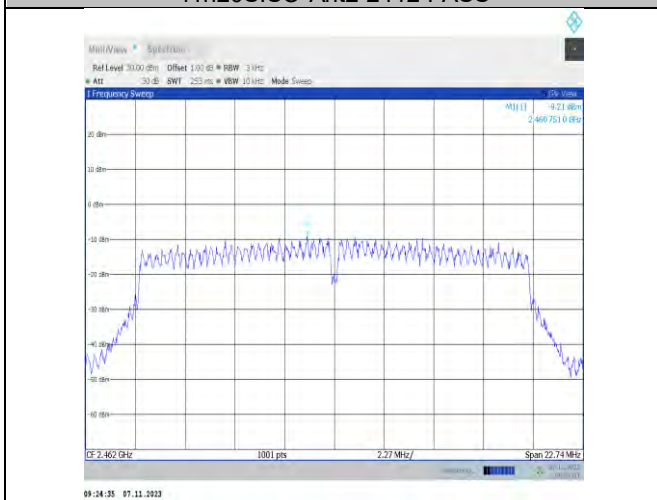

11n20SISO-Ant2-2462-PASS

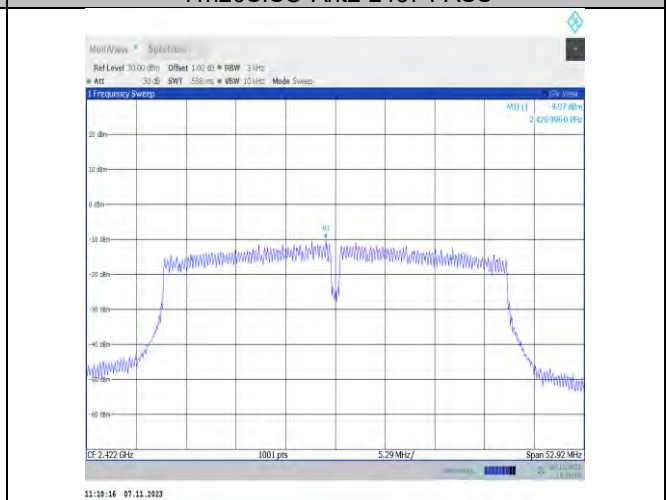

11n40SISO-Ant2-2422-PASS



Unless otherwise agreed in writing, this document is issued by the Company subject to its General Conditions of Service printed overleaf, available on request or accessible at <http://www.sgs.com/en/Terms-and-Conditions.aspx> and, for electronic format documents, subject to Terms and Conditions for Electronic Documents at <http://www.sgs.com/en/Terms-and-Conditions/Terms-e-Documents.aspx>. Attention is drawn to the limitation of liability, indemnification and jurisdiction issues defined therein. Any holder of this document is advised that information contained hereon reflects the Company's findings at the time of its intervention only and within the limits of Client's instructions, if any. The Company's sole responsibility is to its Client and this document does not exonerate parties to a transaction from exercising all their rights and obligations under the transaction documents. This document cannot be reproduced except in full, without prior written approval of the Company. Any unauthorized alteration, forgery or falsification of the content or appearance of this document is unlawful and offenders may be prosecuted to the fullest extent of the law. Unless otherwise stated the results shown in this test report refer only to the sample(s) tested and such sample(s) are retained for 30 days only.

Attention: To check the authenticity of testing/inspection report & certificate, please contact us at telephone: (86-755) 8307 1443, or email: CN_Doccheck@sgs.com
 South of No. 6 Plant, No. 1, Runsheng Road, Suzhou Industrial Park, Suzhou Area, China (Jiangsu) Pilot Free Trade Zone 215000 t (86-512) 62992980 www.sgs.com.cn
 中国·苏州·中国(江苏)自由贸易试验区苏州片区苏州工业园区润胜路1号的6号厂房南楼 邮编: 215000 t (86-512) 62992980 sgs.china@sgs.com

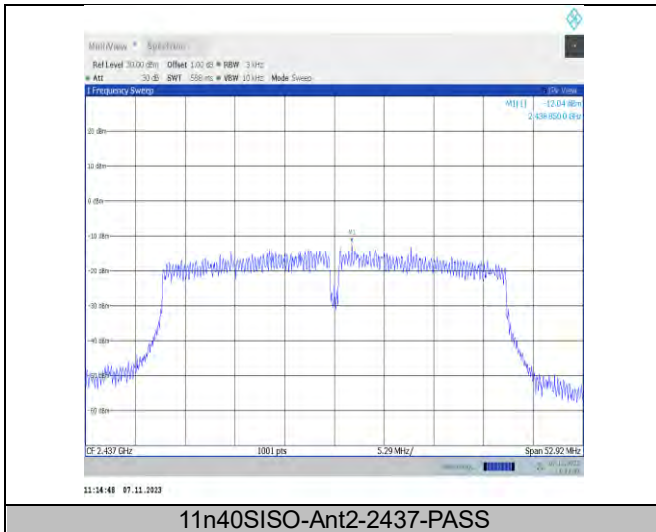

11n40SISO-Ant2-2437-PASS

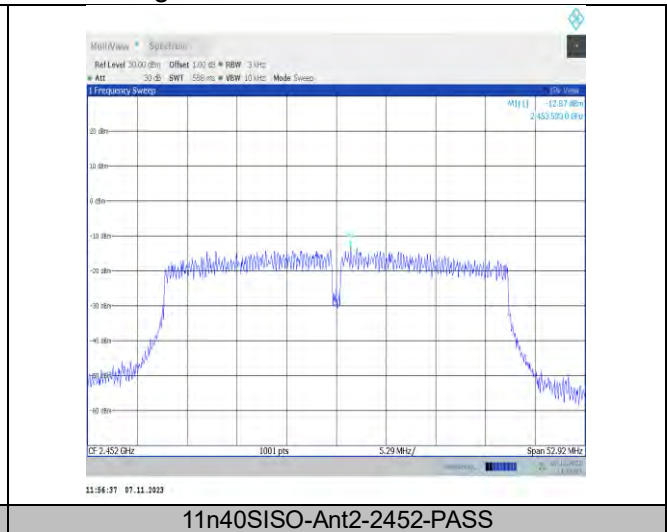

11n40SISO-Ant2-2452-PASS



Unless otherwise agreed in writing, this document is issued by the Company subject to its General Conditions of Service printed overleaf, available on request or accessible at <http://www.sgs.com/en/Terms-and-Conditions.aspx> and, for electronic format documents, subject to Terms and Conditions for Electronic Documents at <http://www.sgs.com/en/Terms-and-Conditions/Terms-e-Documents.aspx>. Attention is drawn to the limitation of liability, indemnification and jurisdiction issues defined therein. Any holder of this document is advised that information contained hereon reflects the Company's findings at the time of its intervention only and within the limits of Client's instructions, if any. The Company's sole responsibility is to its Client and this document does not exonerate parties to a transaction from exercising all their rights and obligations under the transaction documents. This document cannot be reproduced except in full, without prior written approval of the Company. Any unauthorized alteration, forgery or falsification of the content or appearance of this document is unlawful and offenders may be prosecuted to the fullest extent of the law. Unless otherwise stated the results shown in this test report refer only to the sample(s) tested and such sample(s) are retained for 30 days only.

Attention: To check the authenticity of testing/inspection report & certificate, please contact us at telephone: (86-755) 8307 1443, or email: CN.Doccheck@sgs.com

South of No. 6 Plant, No. 1, Runsheng Road, Suzhou Industrial Park, Suzhou Area, China (Jiangsu) Pilot Free Trade Zone 215000 t (86-512) 62992980 www.sgsgroup.com.cn
 中国·苏州·中国(江苏)自由贸易试验区苏州片区苏州工业园区润胜路1号的6号厂房南楼 邮编: 215000 t (86-512) 62992980 sgs.china@sgs.com

Band edge measurements Test Graphs

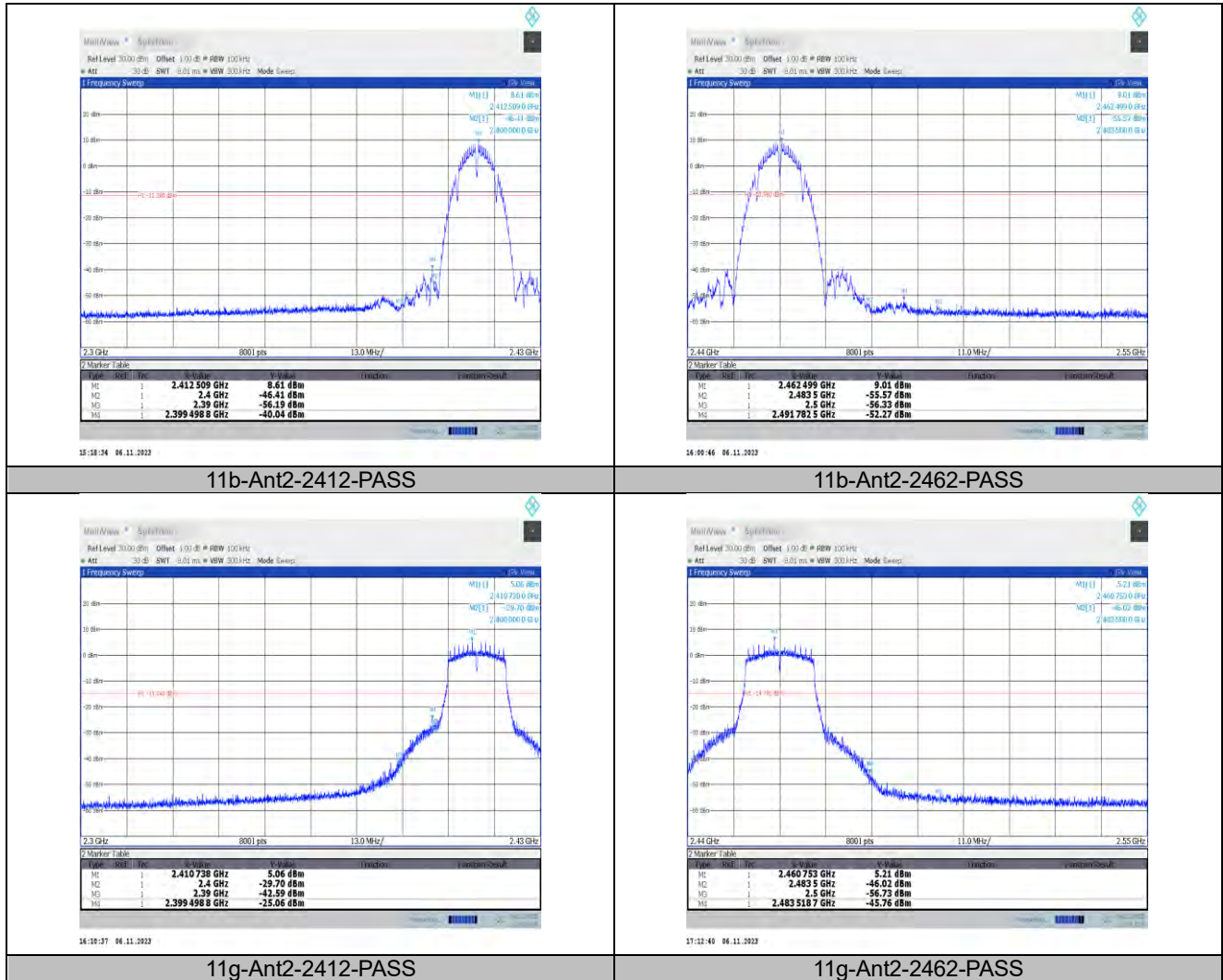

Unless otherwise agreed in writing, this document is issued by the Company subject to its General Conditions of Service printed overleaf, available on request or accessible at <http://www.sgs.com/en/Terms-and-Conditions.aspx> and, for electronic format documents, subject to Terms and Conditions for Electronic Documents at <http://www.sgs.com/en/Terms-and-Conditions/Terms-e-Documents.aspx>. Attention is drawn to the limitation of liability, indemnification and jurisdiction issues defined therein. Any holder of this document is advised that information contained hereon reflects the Company's findings at the time of its intervention only and within the limits of Client's instructions, if any. The Company's sole responsibility is to its Client and this document does not exonerate parties to a transaction from exercising all their rights and obligations under the transaction documents. This document cannot be reproduced except in full, without prior written approval of the Company. Any unauthorized alteration, forgery or falsification of the content or appearance of this document is unlawful and offenders may be prosecuted to the fullest extent of the law. Unless otherwise stated the results shown in this test report refer only to the sample(s) tested and such sample(s) are retained for 30 days only.

Attention: To check the authenticity of testing/inspection report & certificate, please contact us at telephone: (86-755) 8307 1443, or email: CN.Doccheck@sgs.com

South of No. 6 Plant, No. 1, Runsheng Road, Suzhou Industrial Park, Suzhou Area, China (Jiangsu) Pilot Free Trade Zone 215000 t (86-512) 62992980 www.sgs.com.cn
 中国·苏州·中国(江苏)自由贸易试验区苏州片区苏州工业园区润胜路1号的6号厂房南楼 邮编: 215000 t (86-512) 62992980 sgs.china@sgs.com

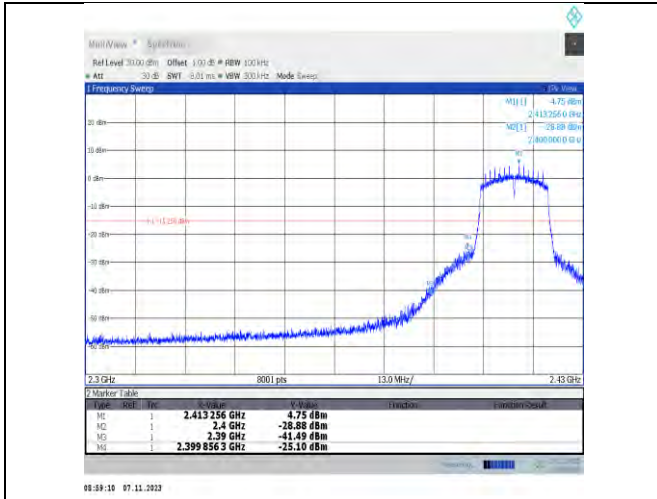

11n20SISO-Ant2-2412-PASS

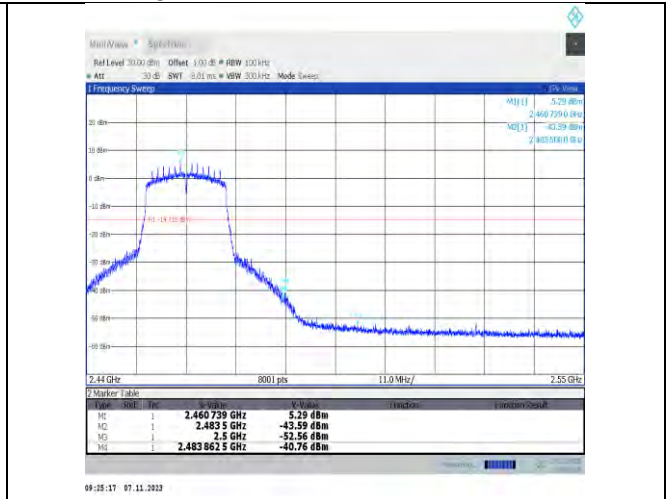

11n20SISO-Ant2-2462-PASS

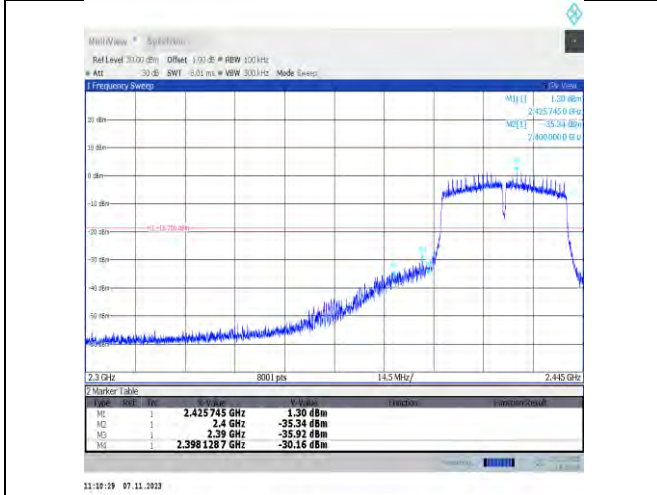

11n40SISO-Ant2-2422-PASS

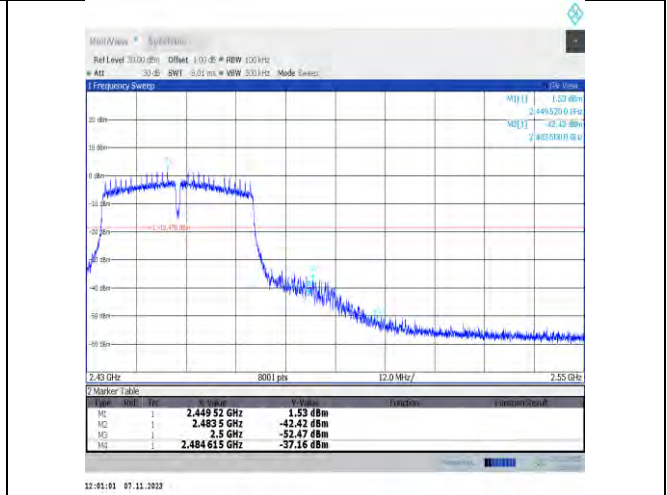

11n40SISO-Ant2-2452-PASS



Unless otherwise agreed in writing, this document is issued by the Company subject to its General Conditions of Service printed overleaf, available on request or accessible at <http://www.sgs.com/en/Terms-and-Conditions.aspx> and, for electronic format documents, subject to Terms and Conditions for Electronic Documents at <http://www.sgs.com/en/Terms-and-Conditions/Terms-e-Documents.aspx>. Attention is drawn to the limitation of liability, indemnification and jurisdiction issues defined therein. Any holder of this document is advised that information contained hereon reflects the Company's findings at the time of its intervention only and within the limits of Client's instructions, if any. The Company's sole responsibility is to its Client and this document does not exonerate parties to a transaction from exercising all their rights and obligations under the transaction documents. This document cannot be reproduced except in full, without prior written approval of the Company. Any unauthorized alteration, forgery or falsification of the content or appearance of this document is unlawful and offenders may be prosecuted to the fullest extent of the law. Unless otherwise stated the results shown in this test report refer only to the sample(s) tested and such sample(s) are retained for 30 days only.

Attention: To check the authenticity of testing/inspection report & certificate, please contact us at telephone: (86-755) 8307 1443, or email: CN.Doccheck@sgs.com

South of No. 6 Plant, No. 1, Runsheng Road, Suzhou Industrial Park, Suzhou Area, China (Jiangsu) Pilot Free Trade Zone 215000 t (86-512) 62992980 www.sgs.com.cn
 中国·苏州·中国(江苏)自由贸易试验区苏州片区工业园区润胜路1号的6号厂房南楼 邮编: 215000 t (86-512) 62992980 sgs.china@sgs.com

Conducted Spurious Emission Test Graphs

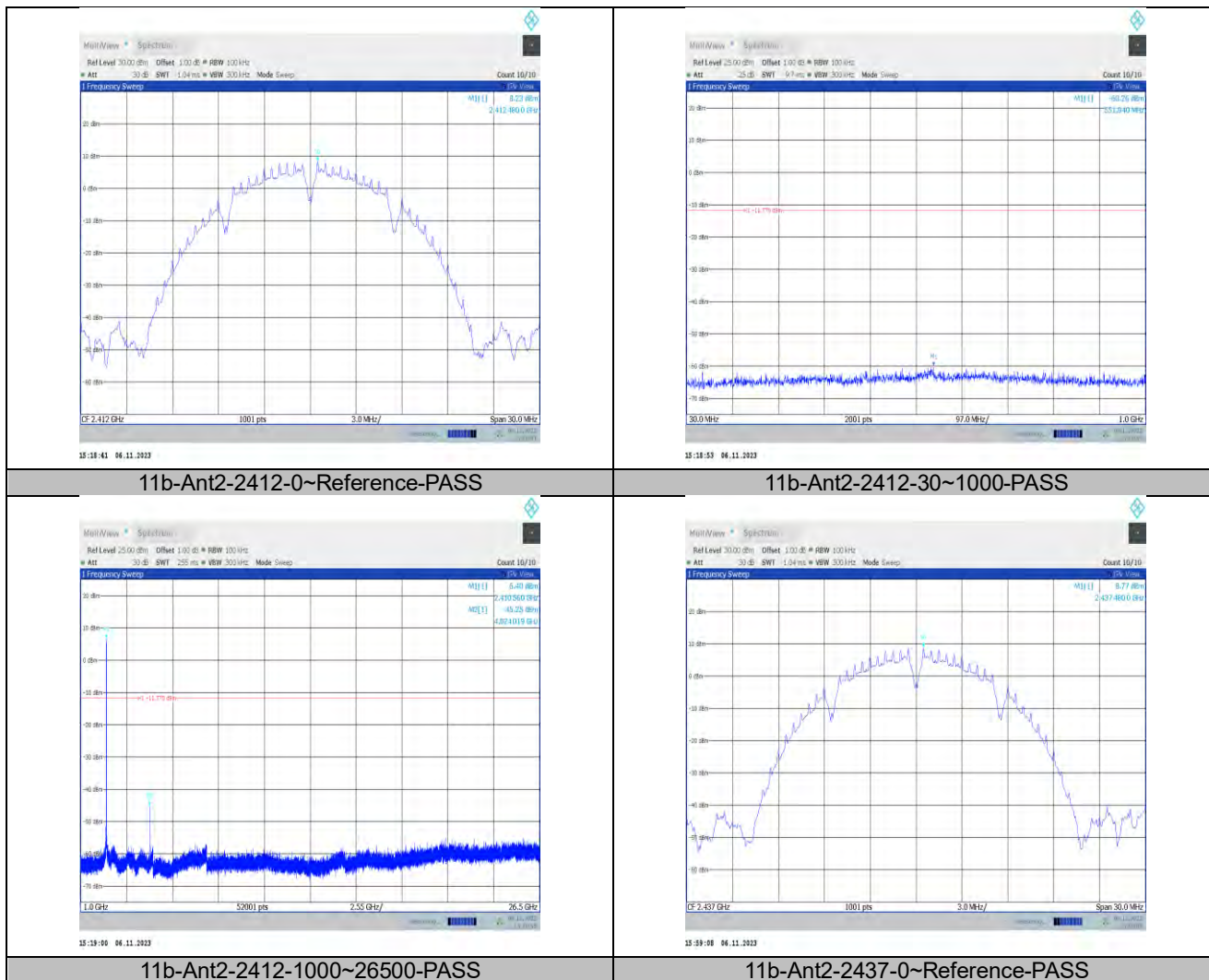

Unless otherwise agreed in writing, this document is issued by the Company subject to its General Conditions of Service printed overleaf, available on request or accessible at <http://www.sgs.com/en/Terms-and-Conditions.aspx> and, for electronic format documents, subject to Terms and Conditions for Electronic Documents at <http://www.sgs.com/en/Terms-and-Conditions/Terms-e-Documents.aspx>. Attention is drawn to the limitation of liability, indemnification and jurisdiction issues defined therein. Any holder of this document is advised that information contained hereon reflects the Company's findings at the time of its intervention only and within the limits of Client's instructions, if any. The Company's sole responsibility is to its Client and this document does not exonerate parties to a transaction from exercising all their rights and obligations under the transaction documents. This document cannot be reproduced except in full, without prior written approval of the Company. Any unauthorized alteration, forgery or falsification of the content or appearance of this document is unlawful and offenders may be prosecuted to the fullest extent of the law. Unless otherwise stated the results shown in this test report refer only to the sample(s) tested and such sample(s) are retained for 30 days only.

Attention: To check the authenticity of testing/inspection report & certificate, please contact us at telephone: (86-755) 8307 1443, or email: CN_Doccheck@sgs.com

South of No. 6 Plant, No. 1, Runsheng Road, Suzhou Industrial Park, Suzhou Area, China (Jiangsu) Pilot Free Trade Zone 215000 t (86-512) 62992980 www.sgs.com.cn
 中国·苏州·中国(江苏)自由贸易试验区苏州片区苏州工业园区润胜路1号的6号厂房南楼 邮编: 215000 t (86-512) 62992980 sgs.china@sgs.com

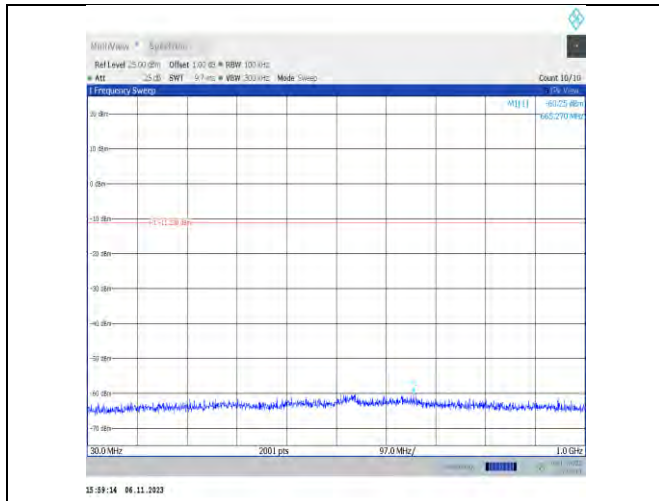

11b-Ant2-2437-30~1000-PASS

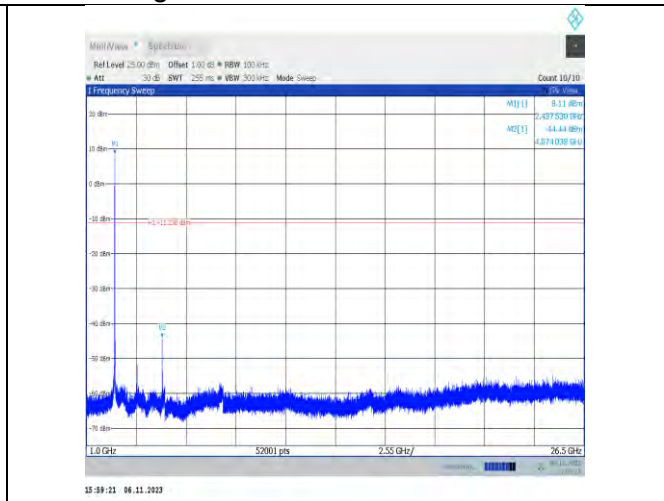

11b-Ant2-2437-1000~26500-PASS

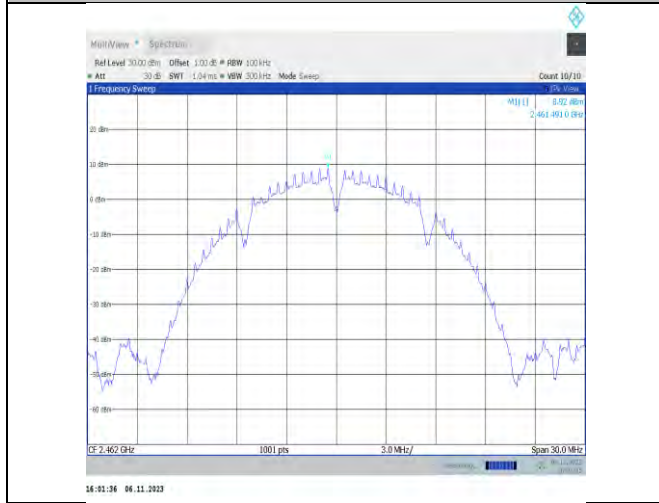

11b-Ant2-2462-0~Reference-PASS

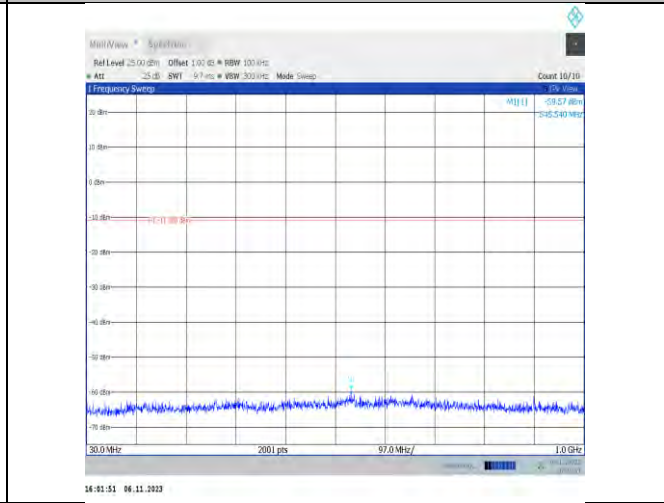

11b-Ant2-2462-30~1000-PASS

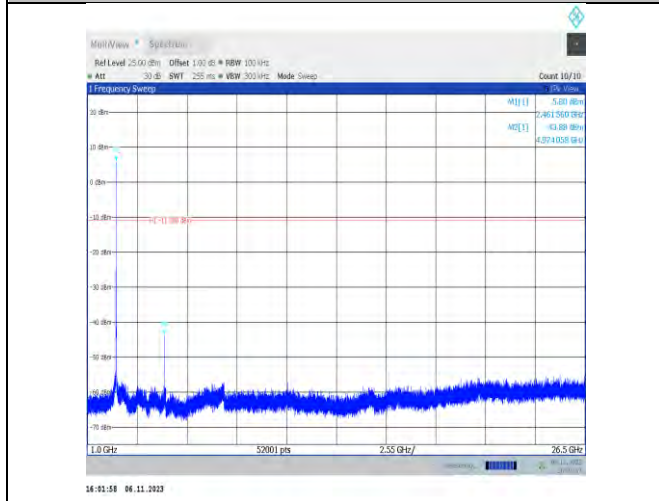

11b-Ant2-2462-1000~26500-PASS

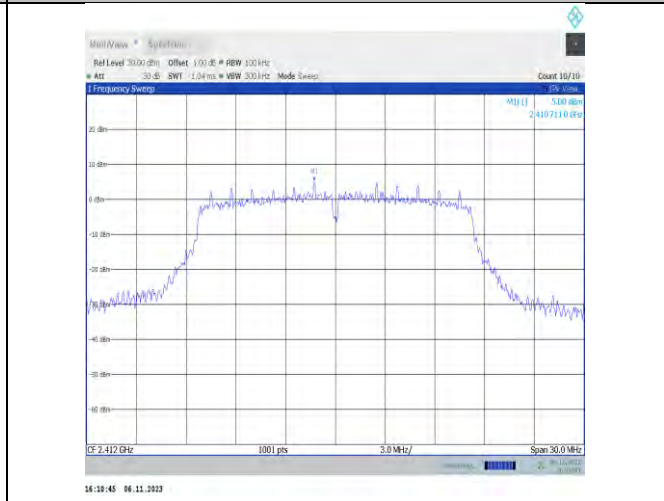

11g-Ant2-2412-0~Reference-PASS



Unless otherwise agreed in writing, this document is issued by the Company subject to its General Conditions of Service printed overleaf, available on request or accessible at <http://www.sgs.com/en/Terms-and-Conditions.aspx> and, for electronic format documents, subject to Terms and Conditions for Electronic Documents at <http://www.sgs.com/en/Terms-and-Conditions/Terms-e-Documents.aspx>. Attention is drawn to the limitation of liability, indemnification and jurisdiction issues defined therein. Any holder of this document is advised that information contained hereon reflects the Company's findings at the time of its intervention only and within the limits of Client's instructions, if any. The Company's sole responsibility is to its Client and this document does not exonerate parties to a transaction from exercising all their rights and obligations under the transaction documents. This document cannot be reproduced except in full, without prior written approval of the Company. Any unauthorized alteration, forgery or falsification of the content or appearance of this document is unlawful and offenders may be prosecuted to the fullest extent of the law. Unless otherwise stated the results shown in this test report refer only to the sample(s) tested and such sample(s) are retained for 30 days only.

Attention: To check the authenticity of testing/inspection report & certificate, please contact us at telephone: (86-755) 8307 1443, or email: CN.Doccheck@sgs.com
 South of No. 6 Plant, No. 1, Runsheng Road, Suzhou Industrial Park, Suzhou Area, China (Jiangsu) Pilot Free Trade Zone 215000 t (86-512) 62992980 www.sgs.com.cn
 中国·苏州·中国(江苏)自由贸易试验区苏州片区苏州工业园区润胜路1号的6号厂房南楼 邮编: 215000 t (86-512) 62992980 sgs.china@sgs.com

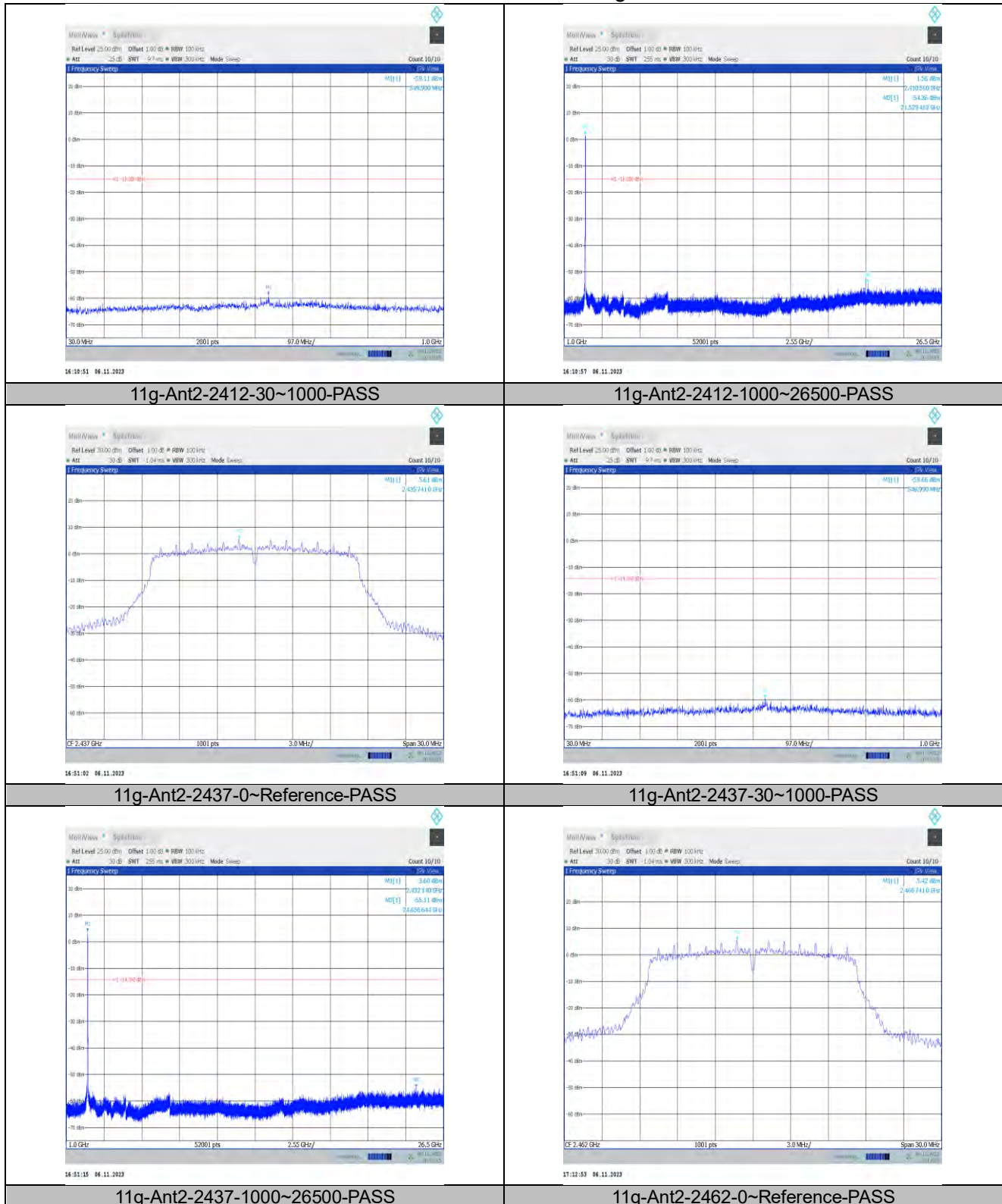

Unless otherwise agreed in writing, this document is issued by the Company subject to its General Conditions of Service printed overleaf, available on request or accessible at <http://www.sgs.com/en/Terms-and-Conditions.aspx> and, for electronic format documents, subject to Terms and Conditions for Electronic Documents at <http://www.sgs.com/en/Terms-and-Conditions/Terms-e-Documents.aspx>. Attention is drawn to the limitation of liability, indemnification and jurisdiction issues defined therein. Any holder of this document is advised that information contained hereon reflects the Company's findings at the time of its intervention only and within the limits of Client's instructions, if any. The Company's sole responsibility is to its Client and this document does not exonerate parties to a transaction from exercising all their rights and obligations under the transaction documents. This document cannot be reproduced except in full, without prior written approval of the Company. Any unauthorized alteration, forgery or falsification of the content or appearance of this document is unlawful and offenders may be prosecuted to the fullest extent of the law. Unless otherwise stated the results shown in this test report refer only to the sample(s) tested and such sample(s) are retained for 30 days only.

Attention: To check the authenticity of testing/inspection report & certificate, please contact us at telephone: (86-755) 8307 1443, or email: CN_Doccheck@sgs.com

South of No. 6 Plant, No. 1, Runsheng Road, Suzhou Industrial Park, Suzhou Area, China (Jiangsu) Pilot Free Trade Zone 215000 t (86-512) 62992980 www.sgs.com.cn
 中国·苏州·中国(江苏)自由贸易试验区苏州片区苏州工业园区润胜路1号的6号厂房南楼 邮编: 215000 t (86-512) 62992980 sgs.china@sgs.com

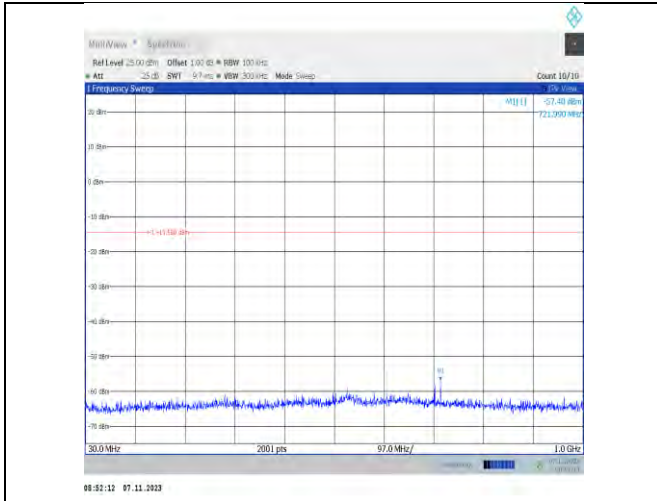

11g-Ant2-2462-30~1000-PASS

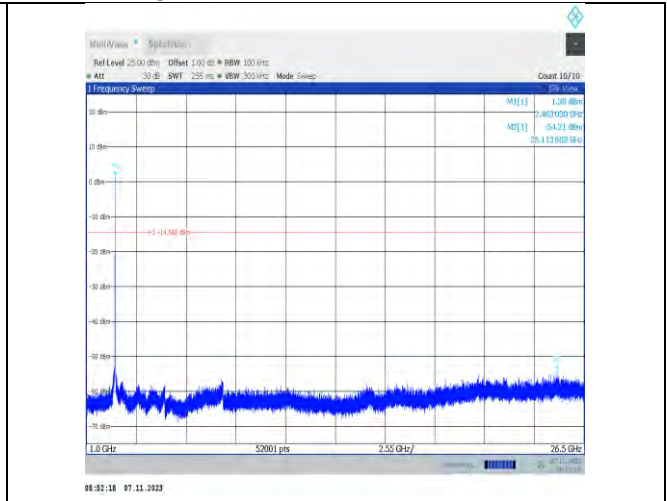

11g-Ant2-2462-1000~26500-PASS

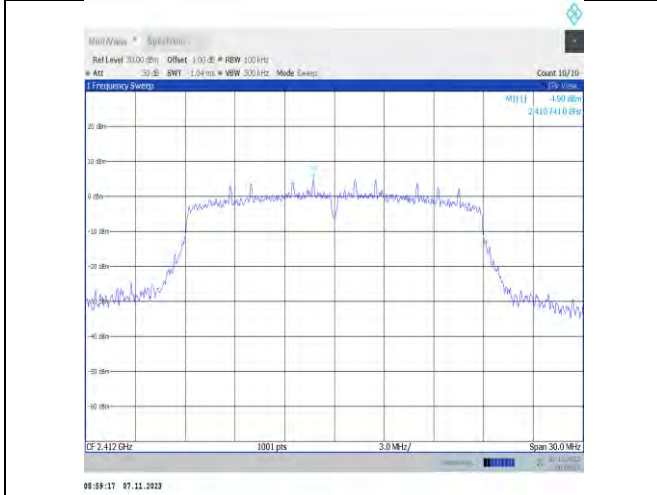

11n20SISO-Ant2-2412-0-Reference-PASS

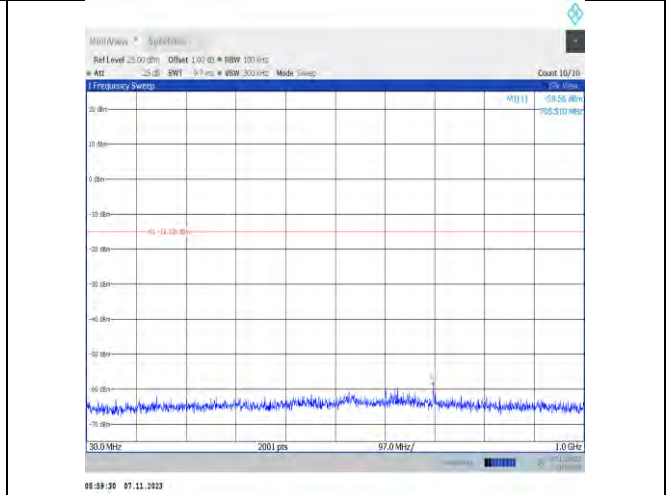

11n20SISO-Ant2-2412-30~1000-PASS

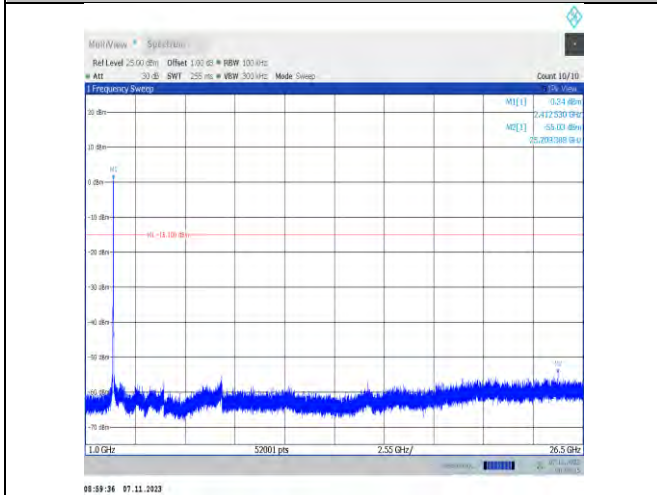

11n20SISO-Ant2-2412-1000~26500-PASS

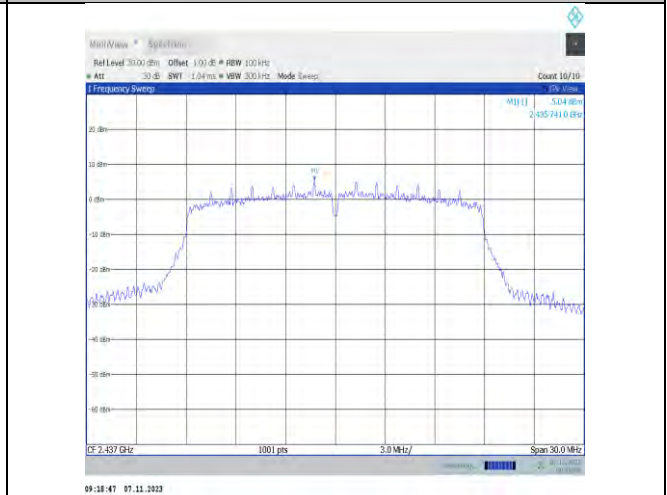

11n20SISO-Ant2-2437-0-Reference-PASS



Unless otherwise agreed in writing, this document is issued by the Company subject to its General Conditions of Service printed overleaf, available on request or accessible at <http://www.sgs.com/en/Terms-and-Conditions.aspx> and, for electronic format documents, subject to Terms and Conditions for Electronic Documents at <http://www.sgs.com/en/Terms-and-Conditions/Terms-e-Documents.aspx>. Attention is drawn to the limitation of liability, indemnification and jurisdiction issues defined therein. Any holder of this document is advised that information contained hereon reflects the Company's findings at the time of its intervention only and within the limits of Client's instructions, if any. The Company's sole responsibility is to its Client and this document does not exonerate parties to a transaction from exercising all their rights and obligations under the transaction documents. This document cannot be reproduced except in full, without prior written approval of the Company. Any unauthorized alteration, forgery or falsification of the content or appearance of this document is unlawful and offenders may be prosecuted to the fullest extent of the law. Unless otherwise stated the results shown in this test report refer only to the sample(s) tested and such sample(s) are retained for 30 days only.

Attention: To check the authenticity of testing/inspection report & certificate, please contact us at telephone: (86-755) 8307 1443, or email: CN.Doccheck@sgs.com
 South of No. 6 Plant, No. 1, Runsheng Road, Suzhou Industrial Park, Suzhou Area, China (Jiangsu) Pilot Free Trade Zone 215000 t (86-512) 62992980 www.sgsgroup.com.cn
 中国·苏州·中国(江苏)自由贸易试验区苏州片区苏州工业园区润胜路1号的6号厂房南楼 邮编: 215000 t (86-512) 62992980 sgs.china@sgs.com

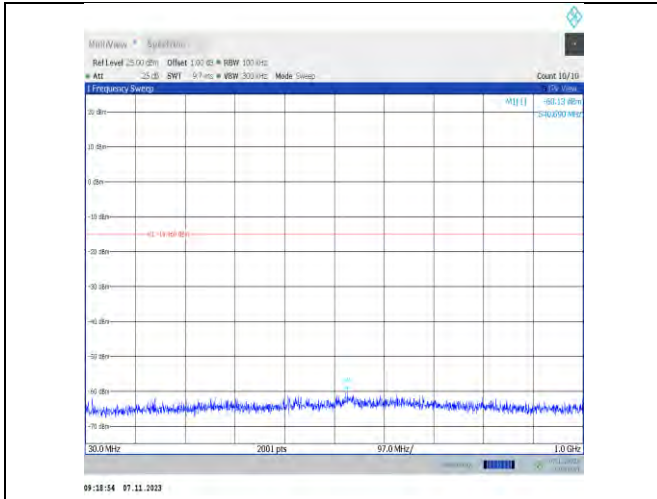

11n20SISO-Ant2-2437-30~1000-PASS

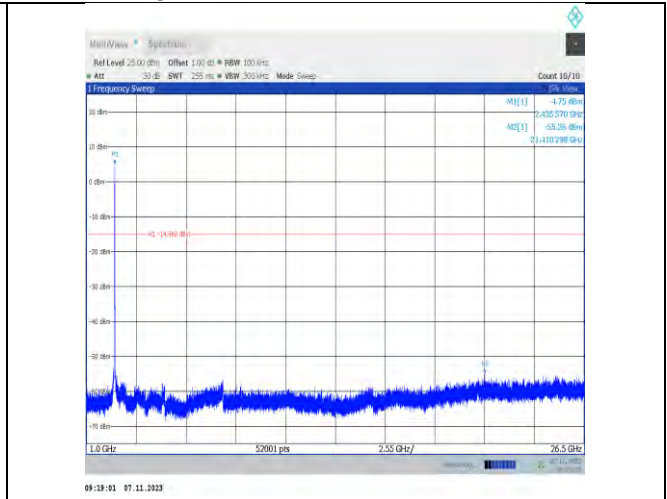

11n20SISO-Ant2-2437-1000~26500-PASS

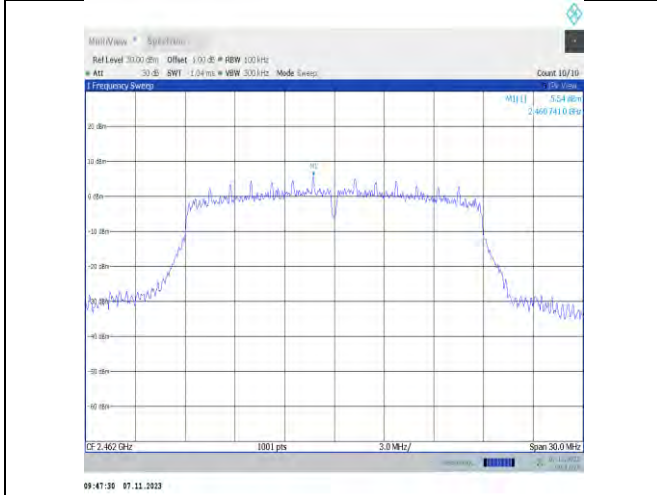

11n20SISO-Ant2-2462-0~Reference-PASS

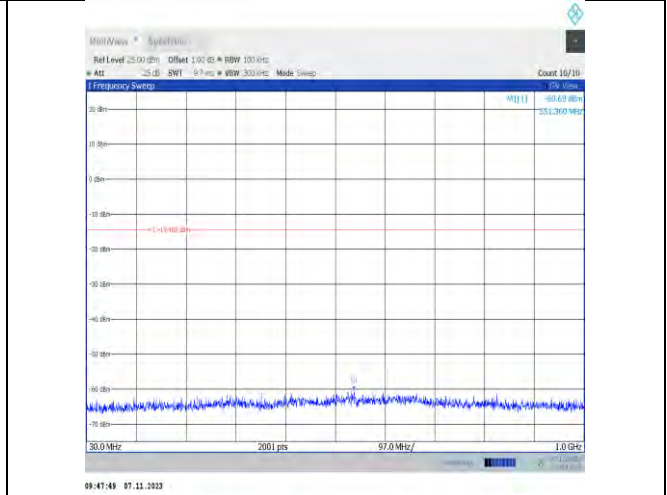

11n20SISO-Ant2-2462-30~1000-PASS

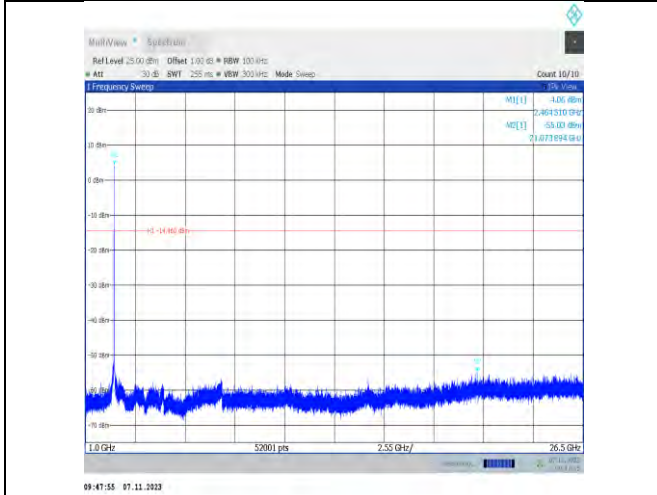

11n20SISO-Ant2-2462-1000~26500-PASS

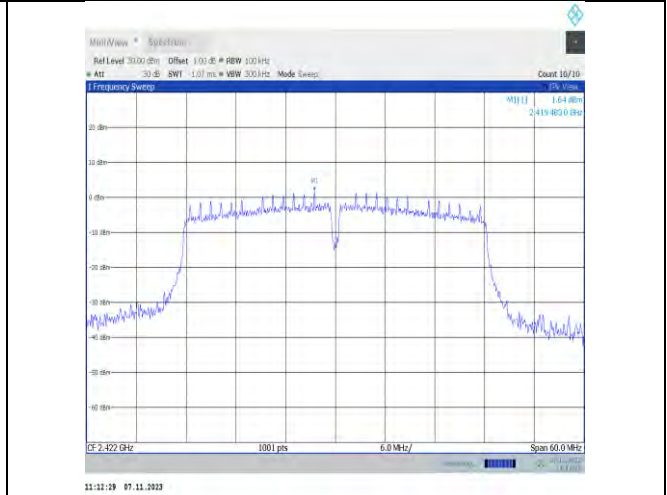

11n40SISO-Ant2-2422-0~Reference-PASS



Unless otherwise agreed in writing, this document is issued by the Company subject to its General Conditions of Service printed overleaf, available on request or accessible at <http://www.sgs.com/en/Terms-and-Conditions.aspx> and, for electronic format documents, subject to Terms and Conditions for Electronic Documents at <http://www.sgs.com/en/Terms-and-Conditions/Terms-e-Documents.aspx>. Attention is drawn to the limitation of liability, indemnification and jurisdiction issues defined therein. Any holder of this document is advised that information contained hereon reflects the Company's findings at the time of its intervention only and within the limits of Client's instructions, if any. The Company's sole responsibility is to its Client and this document does not exonerate parties to a transaction from exercising all their rights and obligations under the transaction documents. This document cannot be reproduced except in full, without prior written approval of the Company. Any unauthorized alteration, forgery or falsification of the content or appearance of this document is unlawful and offenders may be prosecuted to the fullest extent of the law. Unless otherwise stated the results shown in this test report refer only to the sample(s) tested and such sample(s) are retained for 30 days only.

Attention: To check the authenticity of testing/inspection report & certificate, please contact us at telephone: (86-755) 8307 1443, or email: CN.Doccheck@sgs.com
 South of No. 6 Plant, No. 1, Runsheng Road, Suzhou Industrial Park, Suzhou Area, China (Jiangsu) Pilot Free Trade Zone 215000 t (86-512) 62992980 www.sgs.com.cn
 中国·苏州·中国(江苏)自由贸易试验区苏州片区苏州工业园区润胜路1号的6号厂房南楼 邮编: 215000 t (86-512) 62992980 sgs.china@sgs.com

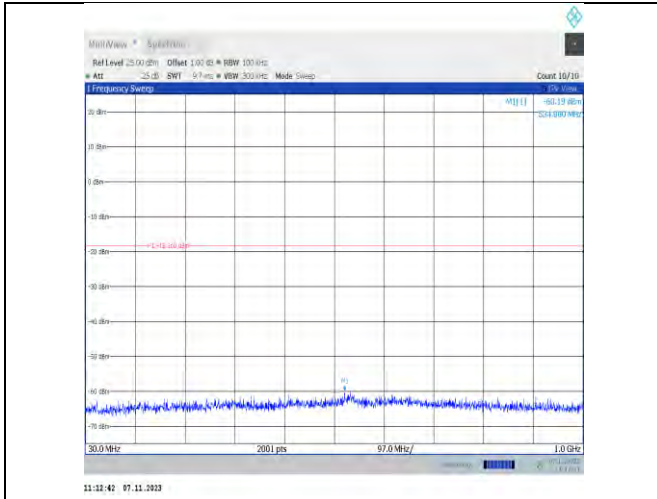

11n40SISO-Ant2-2422-30~1000-PASS

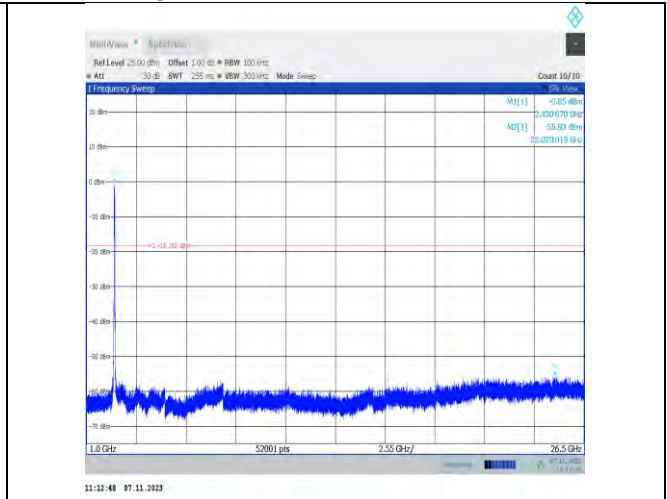

11n40SISO-Ant2-2422-1000~26500-PASS

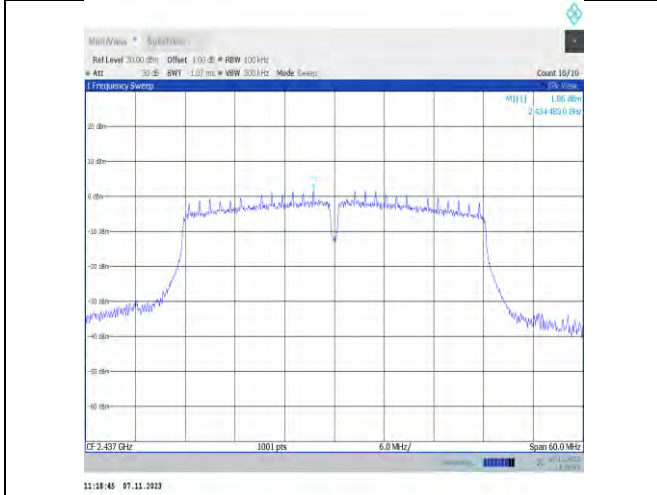

11n40SISO-Ant2-2437-0~Reference-PASS

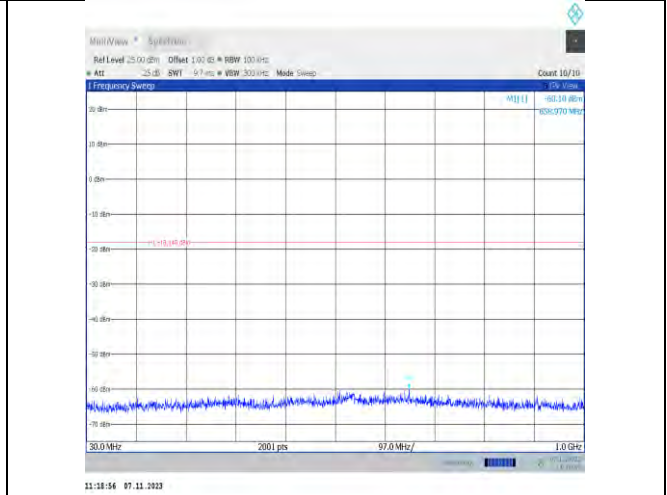

11n40SISO-Ant2-2437-30~1000-PASS

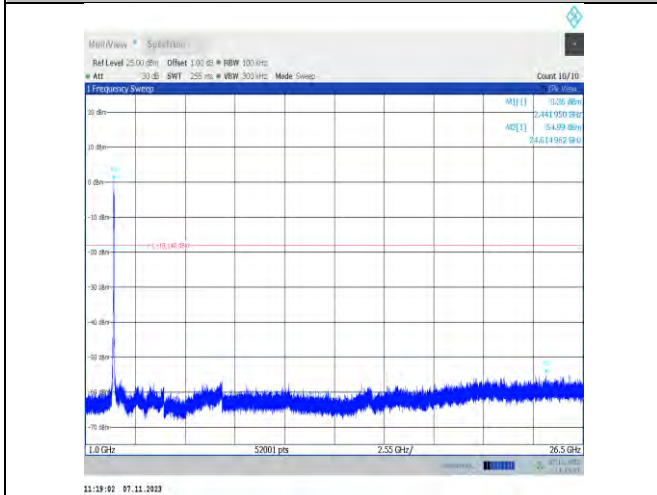

11n40SISO-Ant2-2437-1000~26500-PASS

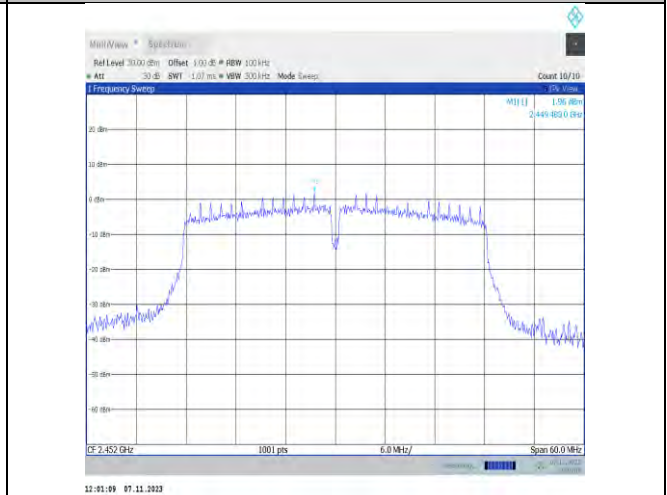

11n40SISO-Ant2-2452-0~Reference-PASS



Unless otherwise agreed in writing, this document is issued by the Company subject to its General Conditions of Service printed overleaf, available on request or accessible at <http://www.sgs.com/en/Terms-and-Conditions.aspx> and, for electronic format documents, subject to Terms and Conditions for Electronic Documents at <http://www.sgs.com/en/Terms-and-Conditions/Terms-e-Documents.aspx>. Attention is drawn to the limitation of liability, indemnification and jurisdiction issues defined therein. Any holder of this document is advised that information contained hereon reflects the Company's findings at the time of its intervention only and within the limits of Client's instructions, if any. The Company's sole responsibility is to its Client and this document does not exonerate parties to a transaction from exercising all their rights and obligations under the transaction documents. This document cannot be reproduced except in full, without prior written approval of the Company. Any unauthorized alteration, forgery or falsification of the content or appearance of this document is unlawful and offenders may be prosecuted to the fullest extent of the law. Unless otherwise stated the results shown in this test report refer only to the sample(s) tested and such sample(s) are retained for 30 days only.

Attention: To check the authenticity of testing/inspection report & certificate, please contact us at telephone: (86-755) 8307 1443, or email: CN_Doccheck@sgs.com
 South of No. 6 Plant, No. 1, Runsheng Road, Suzhou Industrial Park, Suzhou Area, China (Jiangsu) Pilot Free Trade Zone 215000 t (86-512) 62992980 www.sgs.com.cn
 中国·苏州·中国(江苏)自由贸易试验区苏州工业园区润胜路1号的6号厂房南楼 邮编: 215000 t (86-512) 62992980 sgs.china@sgs.com

Report No.: SEWM2309000380RG04

Rev.: 01

Page: 52 of 112

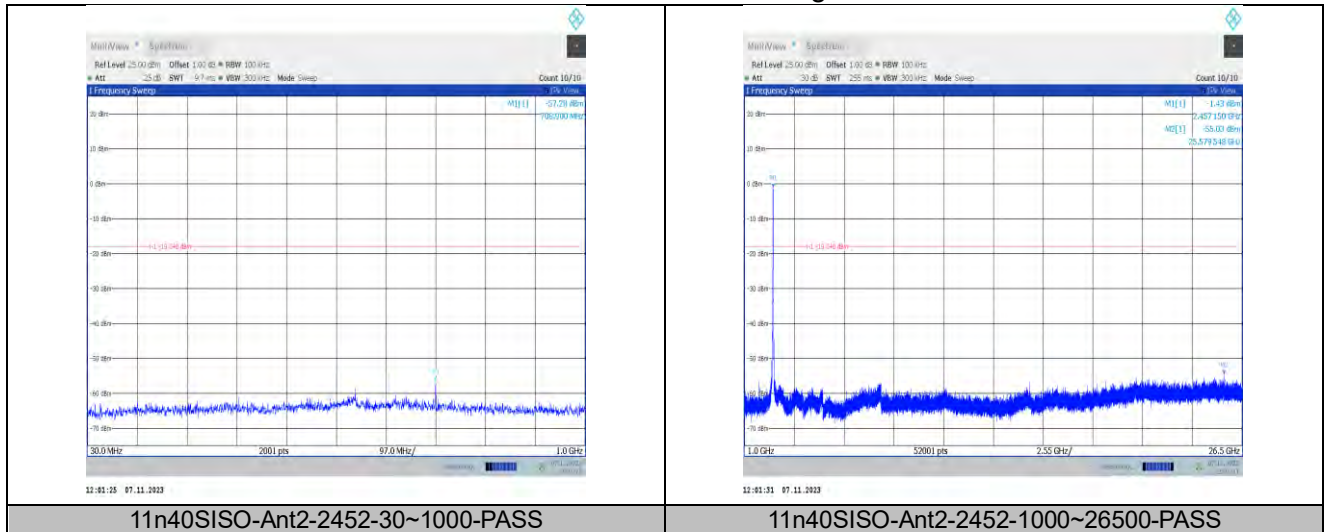

11n40SISO-Ant2-2452-30~1000-PASS

11n40SISO-Ant2-2452-1000~26500-PASS



Unless otherwise agreed in writing, this document is issued by the Company subject to its General Conditions of Service printed overleaf, available on request or accessible at <http://www.sgs.com/en/Terms-and-Conditions.aspx> and, for electronic format documents, subject to Terms and Conditions for Electronic Documents at <http://www.sgs.com/en/Terms-and-Conditions/Terms-e-Documents.aspx>. Attention is drawn to the limitation of liability, indemnification and jurisdiction issues defined therein. Any holder of this document is advised that information contained hereon reflects the Company's findings at the time of its intervention only and within the limits of Client's instructions, if any. The Company's sole responsibility is to its Client and this document does not exonerate parties to a transaction from exercising all their rights and obligations under the transaction documents. This document cannot be reproduced except in full, without prior written approval of the Company. Any unauthorized alteration, forgery or falsification of the content or appearance of this document is unlawful and offenders may be prosecuted to the fullest extent of the law. Unless otherwise stated the results shown in this test report refer only to the sample(s) tested and such sample(s) are retained for 30 days only.

Attention: To check the authenticity of testing/inspection report & certificate, please contact us at telephone: (86-755) 8307 1443, or email: CN.Doccheck@sgs.com

South of No. 6 Plant, No. 1, Runsheng Road, Suzhou Industrial Park, Suzhou Area, China (Jiangsu) Pilot Free Trade Zone 215000 t (86-512) 62992980 www.sgs.com.cn
 中国·苏州·中国(江苏)自由贸易试验区苏州片区苏州工业园区润胜路1号的6号厂房南楼 邮编: 215000 t (86-512) 62992980 sgs.china@sgs.com

Report No.: SEWM2309000380RG04

Rev.: 01

Page: 53 of 112

Duty Cycle Test Result

TestMode	Antenna	Frequency[MHz]	Transmission Duration [ms]	Transmission Period [ms]	Duty Cycle [%]	Factor
11b	Ant2	2412	20.00	20.00	100.00	0.00
11g	Ant2	2412	1.39	1.43	97.20	0.12
11n20SISO	Ant2	2412	1.30	1.34	97.01	0.13
11n40SISO	Ant2	2422	0.64	0.68	94.12	0.26

Note:

Radiated Emission Average VBW = 1 / T

TestMode	T[ms]	Period[ms]	Duty Cycle[%]	1/T[kHz]	VBW Setting
11b	20.00	20.00	100.00	0.05000	10Hz*
11g	1.39	1.43	97.20	0.71942	0.75KHz
11n20SISO	1.30	1.34	97.01	0.76923	0.82KHz
11n40SISO	0.64	0.68	94.12	1.56250	1.6KHz

*Duty cycle > 98% VBW setting=10Hz



Unless otherwise agreed in writing, this document is issued by the Company subject to its General Conditions of Service printed overleaf, available on request or accessible at <http://www.sgs.com/en/Terms-and-Conditions.aspx> and, for electronic format documents, subject to Terms and Conditions for Electronic Documents at <http://www.sgs.com/en/Terms-and-Conditions/Terms-e-Documents.aspx>. Attention is drawn to the limitation of liability, indemnification and jurisdiction issues defined therein. Any holder of this document is advised that information contained hereon reflects the Company's findings at the time of its intervention only and within the limits of Client's instructions, if any. The Company's sole responsibility is to its Client and this document does not exonerate parties to a transaction from exercising all their rights and obligations under the transaction documents. This document cannot be reproduced except in full, without prior written approval of the Company. Any unauthorized alteration, forgery or falsification of the content or appearance of this document is unlawful and offenders may be prosecuted to the fullest extent of the law. Unless otherwise stated the results shown in this test report refer only to the sample(s) tested and such sample(s) are retained for 30 days only.

Attention: To check the authenticity of testing/inspection report & certificate, please contact us at telephone: (86-755) 8307 1443, or email: CN.Doccheck@sgs.com

South of No. 6 Plant, No. 1, Runsheng Road, Suzhou Industrial Park, Suzhou Area, China (Jiangsu) Pilot Free Trade Zone 215000
 中国·苏州·中国(江苏)自由贸易试验区苏州片区苏州工业园区润胜路1号的6号厂房南楼 邮编: 215000

t (86-512) 62992980 www.sgs.com.cn
 t (86-512) 62992980 sgs.china@sgs.com

Test Graphs

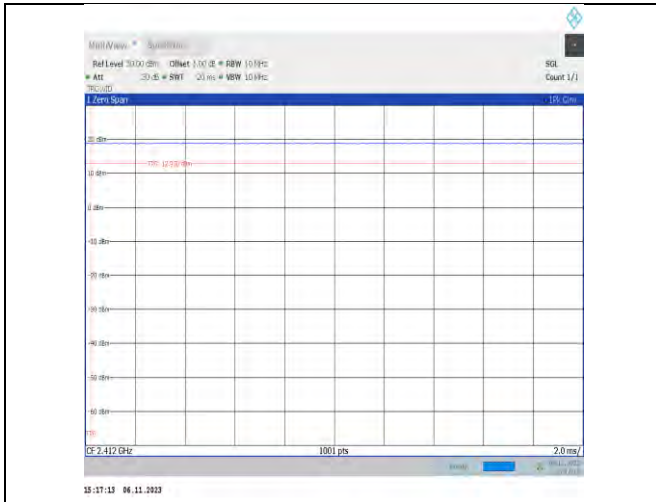

NTNV-11b-Ant2-2412

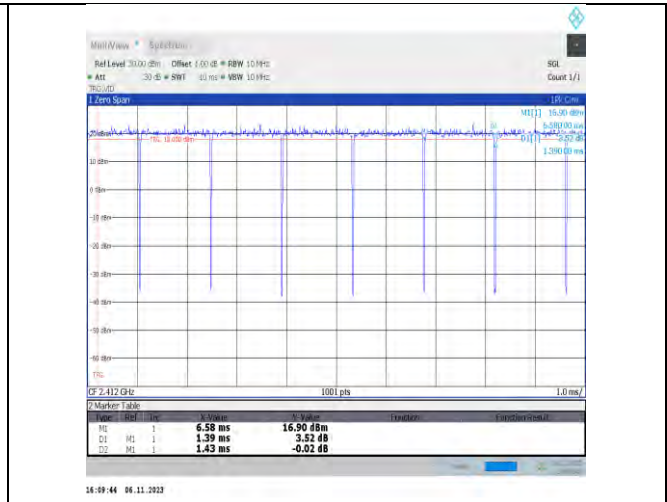

NTNV-11g-Ant2-2412

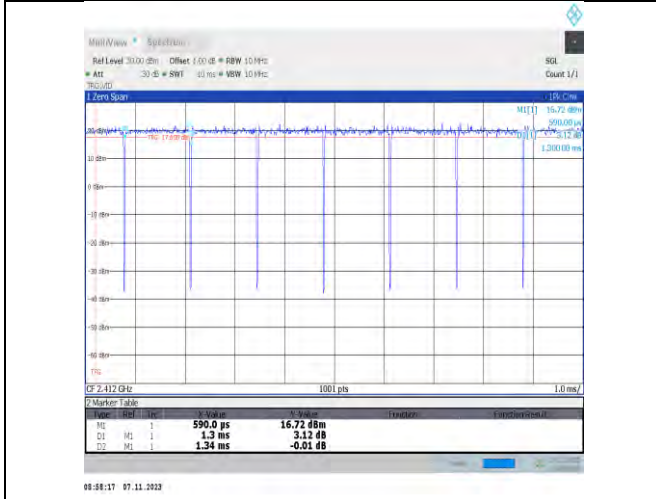

NTNV-11n20SISO-Ant2-2412

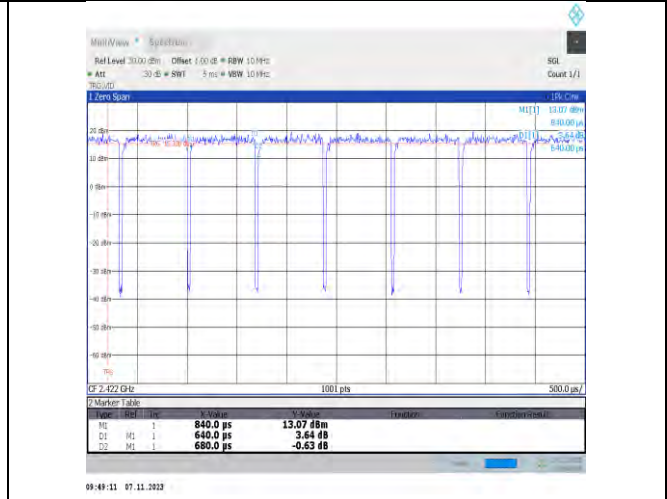

NTNV-11n40SISO-Ant2-2422



Radiated Spurious Emissions

Radiated emission below 1GHz

Worst case Mode: 802.11n20_Channel 01

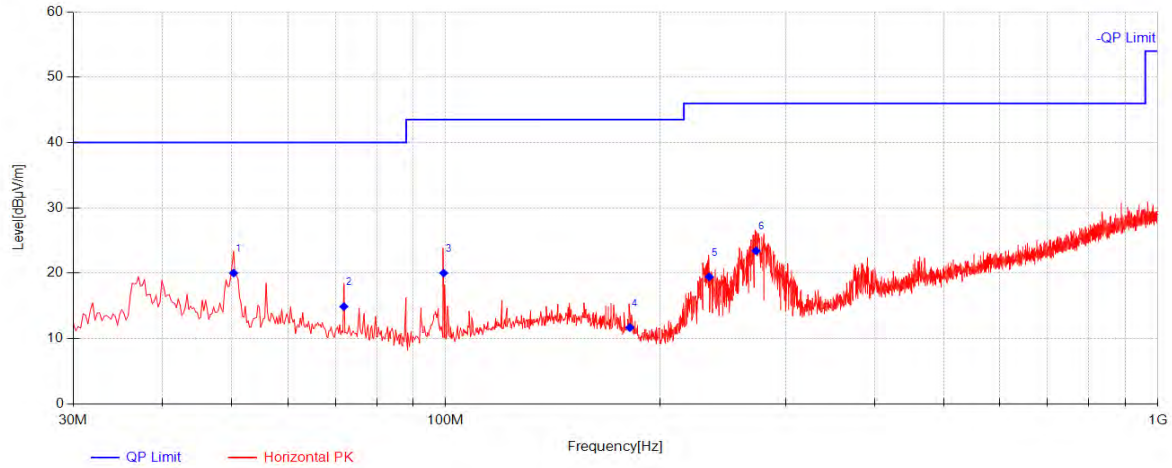

Data List								
NO.	Frequency [MHz]	Reading [dBμV]	Factor [dB]	AF [dB/m]	QP Value [dBμV/m]	QP Limit [dBμV/m]	QP Margin [dB]	Polarity
1	50.37	43.22	-42.37	19.19	20.03	40.00	19.97	Horizontal
2	71.9525	40.19	-42.03	16.73	14.89	40.00	25.11	Horizontal
3	99.355	46.23	-41.65	15.45	20.02	43.50	23.48	Horizontal
4	181.32	36.28	-41.01	16.41	11.68	43.50	31.82	Horizontal
5	234.4275	43.18	-40.75	17.02	19.45	46.00	26.55	Horizontal
6	272.7425	46.19	-40.38	17.61	23.42	46.00	22.58	Horizontal



Unless otherwise agreed in writing, this document is issued by the Company subject to its General Conditions of Service printed overleaf, available on request or accessible at <http://www.sgs.com/en/Terms-and-Conditions.aspx> and, for electronic format documents, subject to Terms and Conditions for Electronic Documents at <http://www.sgs.com/en/Terms-and-Conditions/Terms-e-Documents.aspx>. Attention is drawn to the limitation of liability, indemnification and jurisdiction issues defined therein. Any holder of this document is advised that information contained hereon reflects the Company's findings at the time of its intervention only and within the limits of Client's instructions, if any. The Company's sole responsibility is to its Client and this document does not exonerate parties to a transaction from exercising all their rights and obligations under the transaction documents. This document cannot be reproduced except in full, without prior written approval of the Company. Any unauthorized alteration, forgery or falsification of the content or appearance of this document is unlawful and offenders may be prosecuted to the fullest extent of the law. Unless otherwise stated the results shown in this test report refer only to the sample(s) tested and such sample(s) are retained for 30 days only.

Attention: To check the authenticity of testing/inspection report & certificate, please contact us at telephone: (86-755) 8307 1443, or email: CN_Doccheck@sgs.com

South of No. 6 Plant, No. 1, Runsheng Road, Suzhou Industrial Park, Suzhou Area, China (Jiangsu) Pilot Free Trade Zone 215000
 中国·苏州·中国(江苏)自由贸易试验区苏州片区苏州工业园区润胜路1号的6号厂房南楼 邮编: 215000

t (86-512) 62992980 www.sgsgroup.com.cn
 t (86-512) 62992980 sgs.china@sgs.com

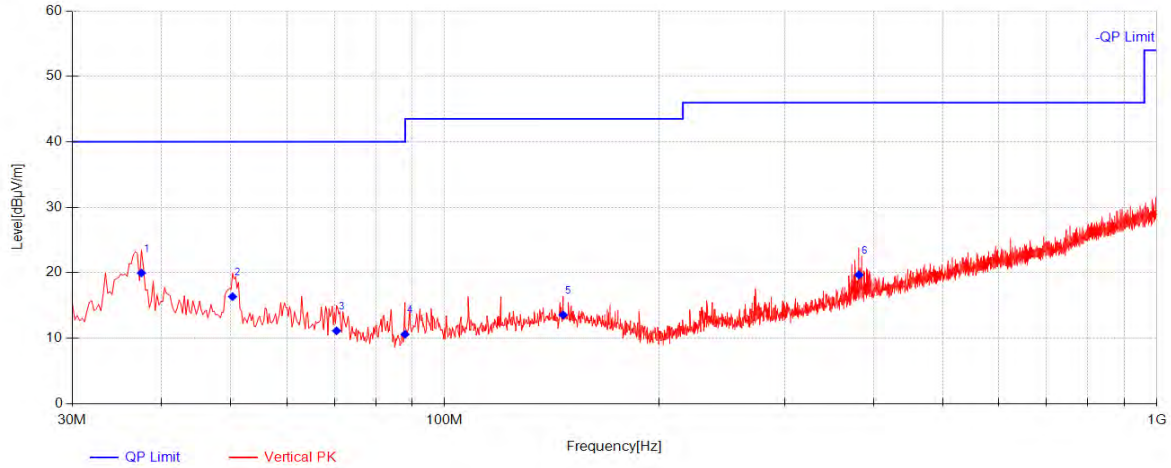

Data List								
NO.	Frequency [MHz]	Reading [dBµV]	Factor [dB]	AF [dB/m]	QP Value [dBµV/m]	QP Limit [dBµV/m]	QP Margin [dB]	Polarity
1	37.5175	43.21	-42.34	19.10	19.97	40.00	20.03	Vertical
2	50.37	39.54	-42.37	19.19	16.35	40.00	23.65	Vertical
3	70.4975	36.19	-42.07	17.01	11.13	40.00	28.87	Vertical
4	87.9575	37.52	-41.73	14.80	10.59	40.00	29.41	Vertical
5	146.6425	36.15	-41.08	18.50	13.57	43.50	29.93	Vertical
6	381.625	38.46	-39.57	20.79	19.68	46.00	26.32	Vertical

Remark:

1) The field strength is calculated by adding the Antenna Factor, Cable Factor & Pre-amplifier gain. The basic equation with a sample calculation is as follows:

$$\text{Value} = \text{Reading}(\text{dB}\mu\text{V}) + \text{AF}(\text{dB}/\text{m}) + \text{Factor}(\text{dB})$$

$$\text{AF} = \text{Antenna Factor}(\text{dB}/\text{m})$$

$$\text{Factor} = \text{Cable Factor}(\text{dB}) - \text{Pre-amplifier gain}(\text{dB})$$

$$\text{Margin} = \text{Limit}(\text{dB}\mu\text{V}/\text{m}) - \text{Value}(\text{dB}\mu\text{V}/\text{m})$$

2) All channels have been tested, but only the worst case data displayed in this report.



Unless otherwise agreed in writing, this document is issued by the Company subject to its General Conditions of Service printed overleaf, available on request or accessible at <http://www.sgs.com/en/Terms-and-Conditions.aspx> and, for electronic format documents, subject to Terms and Conditions for Electronic Documents at <http://www.sgs.com/en/Terms-and-Conditions/Terms-e-Documents.aspx>. Attention is drawn to the limitation of liability, indemnification and jurisdiction issues defined therein. Any holder of this document is advised that information contained hereon reflects the Company's findings at the time of its intervention only and within the limits of Client's instructions, if any. The Company's sole responsibility is to its Client and this document does not exonerate parties to a transaction from exercising all their rights and obligations under the transaction documents. This document cannot be reproduced except in full, without prior written approval of the Company. Any unauthorized alteration, forgery or falsification of the content or appearance of this document is unlawful and offenders may be prosecuted to the fullest extent of the law. Unless otherwise stated the results shown in this test report refer only to the sample(s) tested and such sample(s) are retained for 30 days only.

Attention: To check the authenticity of testing/inspection report & certificate, please contact us at telephone: (86-755) 8307 1443, or email: CN_Doccheck@sgs.com
 South of No. 6 Plant, No. 1, Runsheng Road, Suzhou Industrial Park, Suzhou Area, China (Jiangsu) Pilot Free Trade Zone 215000 t (86-512) 62992980 www.sgs.com.cn
 中国·苏州·中国(江苏)自由贸易试验区苏州片区苏州工业园区润胜路1号的6号厂房南楼 邮编: 215000 t (86-512) 62992980 sgs.china@sgs.com

Transmitter emission Above 1GHz

802.11b_Channel 01

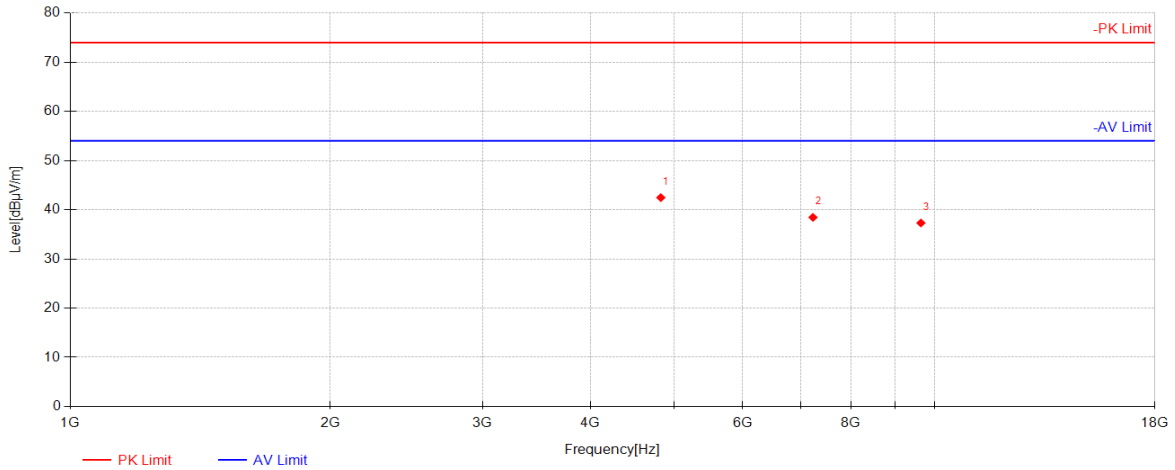

Data List								
NO.	Frequency [MHz]	Reading [dBµV]	AF [dB/m]	Factor [dB]	Level [dBµV/m]	Limit [dBµV/m]	Margin [dB]	Polarity
1	4824.0000	56.99	31.01	-45.54	42.47	74.00	31.53	Horizontal
2	7236.0000	46.13	35.86	-43.54	38.45	74.00	35.55	Horizontal
3	9648.0000	39.34	37.53	-39.56	37.31	74.00	36.69	Horizontal



Unless otherwise agreed in writing, this document is issued by the Company subject to its General Conditions of Service printed overleaf, available on request or accessible at <http://www.sgs.com/en/Terms-and-Conditions.aspx> and, for electronic format documents, subject to Terms and Conditions for Electronic Documents at <http://www.sgs.com/en/Terms-and-Conditions/Terms-e-Documents.aspx>. Attention is drawn to the limitation of liability, indemnification and jurisdiction issues defined therein. Any holder of this document is advised that information contained hereon reflects the Company's findings at the time of its intervention only and within the limits of Client's instructions, if any. The Company's sole responsibility is to its Client and this document does not exonerate parties to a transaction from exercising all their rights and obligations under the transaction documents. This document cannot be reproduced except in full, without prior written approval of the Company. Any unauthorized alteration, forgery or falsification of the content or appearance of this document is unlawful and offenders may be prosecuted to the fullest extent of the law. Unless otherwise stated the results shown in this test report refer only to the sample(s) tested and such sample(s) are retained for 30 days only.

Attention: To check the authenticity of testing/inspection report & certificate, please contact us at telephone: (86-755) 8307 1443, or email: CN.Doccheck@sgs.com

South of No. 6 Plant, No. 1, Runsheng Road, Suzhou Industrial Park, Suzhou Area, China (Jiangsu) Pilot Free Trade Zone 215000 t (86-512) 62992980 www.sgs.com.cn
 中国·苏州·中国(江苏)自由贸易试验区苏州片区苏州工业园区润胜路1号的6号厂房南楼 邮编: 215000 t (86-512) 62992980 sgs.china@sgs.com

802.11b_Channel 01

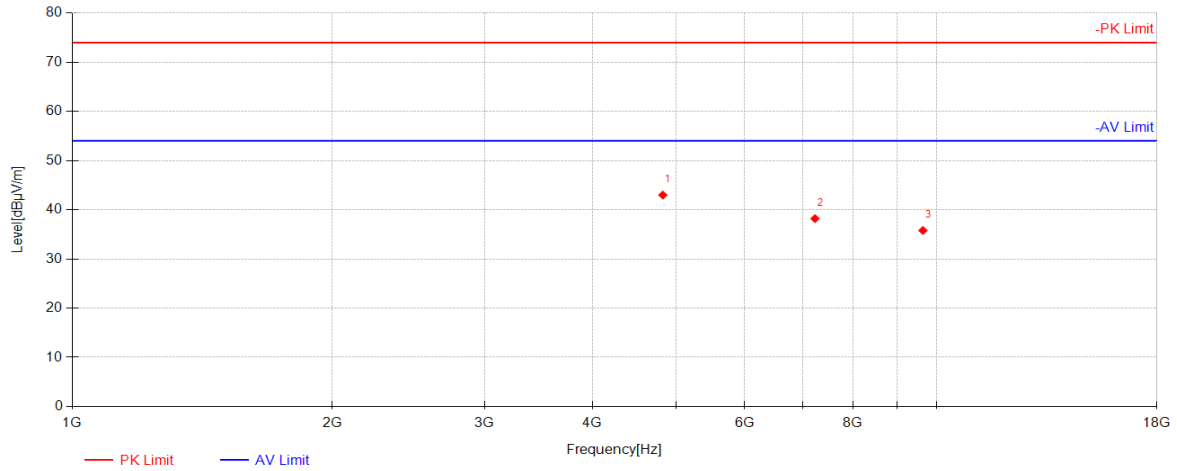

Data List								
NO.	Frequency [MHz]	Reading [dBµV]	AF [dB/m]	Factor [dB]	Level [dBµV/m]	Limit [dBµV/m]	Margin [dB]	Polarity
1	4824.0000	57.51	31.01	-45.54	42.99	74.00	31.01	Vertical
2	7236.0000	45.88	35.86	-43.54	38.20	74.00	35.80	Vertical
3	9648.0000	37.81	37.53	-39.56	35.78	74.00	38.22	Vertical



Unless otherwise agreed in writing, this document is issued by the Company subject to its General Conditions of Service printed overleaf, available on request or accessible at <http://www.sgs.com/en/Terms-and-Conditions.aspx> and, for electronic format documents, subject to Terms and Conditions for Electronic Documents at <http://www.sgs.com/en/Terms-and-Conditions/Terms-e-Documents.aspx>. Attention is drawn to the limitation of liability, indemnification and jurisdiction issues defined therein. Any holder of this document is advised that information contained hereon reflects the Company's findings at the time of its intervention only and within the limits of Client's instructions, if any. The Company's sole responsibility is to its Client and this document does not exonerate parties to a transaction from exercising all their rights and obligations under the transaction documents. This document cannot be reproduced except in full, without prior written approval of the Company. Any unauthorized alteration, forgery or falsification of the content or appearance of this document is unlawful and offenders may be prosecuted to the fullest extent of the law. Unless otherwise stated the results shown in this test report refer only to the sample(s) tested and such sample(s) are retained for 30 days only.

Attention: To check the authenticity of testing/inspection report & certificate, please contact us at telephone: (86-755) 8307 1443, or email: CN.Doccheck@sgs.com
 South of No. 6 Plant, No. 1, Runsheng Road, Suzhou Industrial Park, Suzhou Area, China (Jiangsu) Pilot Free Trade Zone 215000 t (86-512) 62992980 www.sgsgroup.com.cn
 中国·苏州·中国(江苏)自由贸易试验区苏州片区苏州工业园区润胜路1号的6号厂房南楼 邮编: 215000 t (86-512) 62992980 sgs.china@sgs.com

802.11b_Channel 06

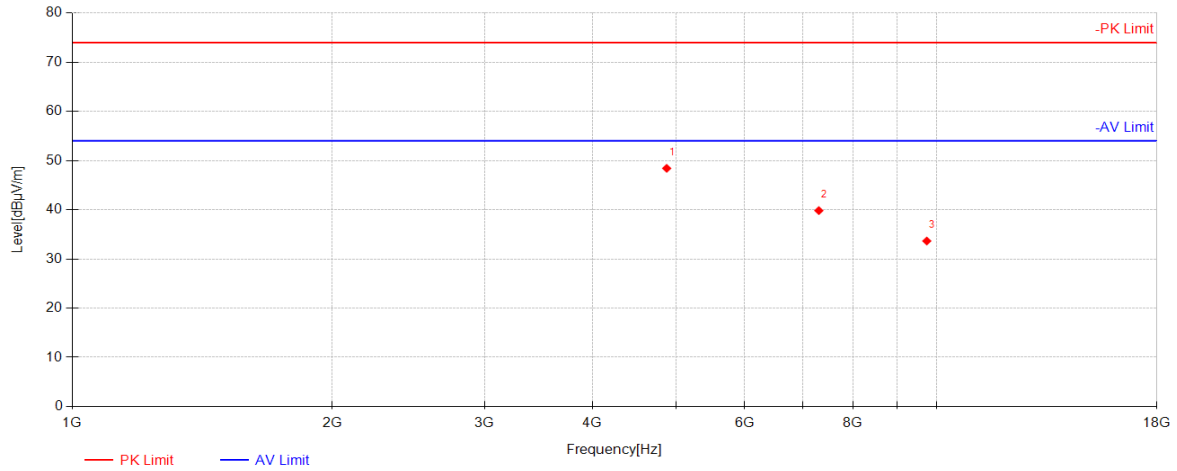

Data List								
NO.	Frequency [MHz]	Reading [dBµV]	AF [dB/m]	Factor [dB]	Level [dBµV/m]	Limit [dBµV/m]	Margin [dB]	Polarity
1	4874.0000	62.84	31.12	-45.53	48.43	74.00	25.57	Horizontal
2	7311.0000	47.47	36.07	-43.71	39.83	74.00	34.17	Horizontal
3	9748.0000	35.39	37.72	-39.46	33.65	74.00	40.35	Horizontal



Unless otherwise agreed in writing, this document is issued by the Company subject to its General Conditions of Service printed overleaf, available on request or accessible at <http://www.sgs.com/en/Terms-and-Conditions.aspx> and, for electronic format documents, subject to Terms and Conditions for Electronic Documents at <http://www.sgs.com/en/Terms-and-Conditions/Terms-e-Documents.aspx>. Attention is drawn to the limitation of liability, indemnification and jurisdiction issues defined therein. Any holder of this document is advised that information contained hereon reflects the Company's findings at the time of its intervention only and within the limits of Client's instructions, if any. The Company's sole responsibility is to its Client and this document does not exonerate parties to a transaction from exercising all their rights and obligations under the transaction documents. This document cannot be reproduced except in full, without prior written approval of the Company. Any unauthorized alteration, forgery or falsification of the content or appearance of this document is unlawful and offenders may be prosecuted to the fullest extent of the law. Unless otherwise stated the results shown in this test report refer only to the sample(s) tested and such sample(s) are retained for 30 days only.

Attention: To check the authenticity of testing/inspection report & certificate, please contact us at telephone: (86-755) 8307 1443, or email: CN.Doccheck@sgs.com

South of No. 6 Plant, No. 1, Runsheng Road, Suzhou Industrial Park, Suzhou Area, China (Jiangsu) Pilot Free Trade Zone 215000 t (86-512) 62992980 www.sgsgroup.com.cn
 中国·苏州·中国(江苏)自由贸易试验区苏州片区苏州工业园区润胜路1号的6号厂房南楼 邮编: 215000 t (86-512) 62992980 sgs.china@sgs.com

802.11b_Channel 06

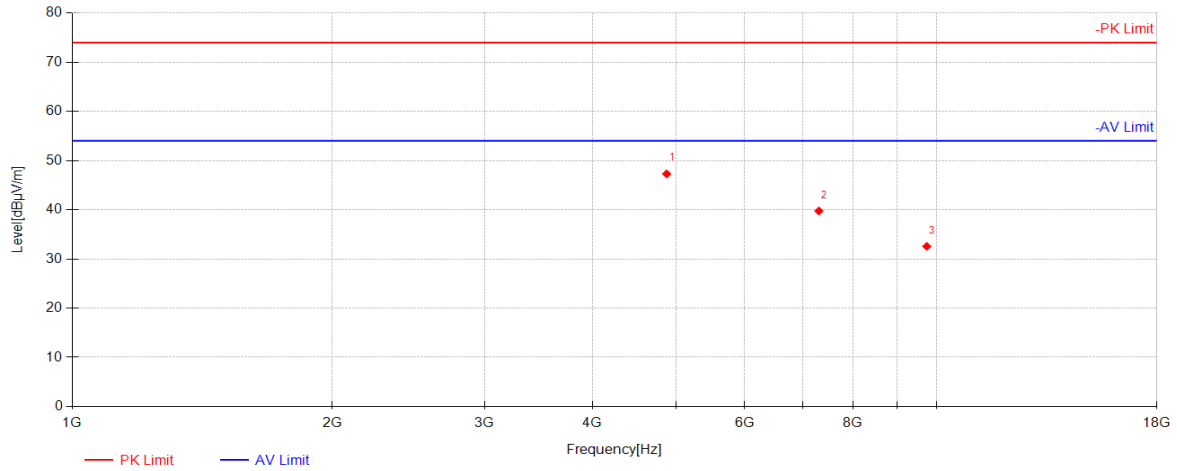

Data List								
NO.	Frequency [MHz]	Reading [dBµV]	AF [dB/m]	Factor [dB]	Level [dBµV/m]	Limit [dBµV/m]	Margin [dB]	Polarity
1	4874.0000	61.70	31.12	-45.53	47.29	74.00	26.71	Vertical
2	7311.0000	47.39	36.07	-43.71	39.75	74.00	34.25	Vertical
3	9748.0000	34.30	37.72	-39.46	32.56	74.00	41.44	Vertical



Unless otherwise agreed in writing, this document is issued by the Company subject to its General Conditions of Service printed overleaf, available on request or accessible at <http://www.sgs.com/en/Terms-and-Conditions.aspx> and, for electronic format documents, subject to Terms and Conditions for Electronic Documents at <http://www.sgs.com/en/Terms-and-Conditions/Terms-e-Documents.aspx>. Attention is drawn to the limitation of liability, indemnification and jurisdiction issues defined therein. Any holder of this document is advised that information contained hereon reflects the Company's findings at the time of its intervention only and within the limits of Client's instructions, if any. The Company's sole responsibility is to its Client and this document does not exonerate parties to a transaction from exercising all their rights and obligations under the transaction documents. This document cannot be reproduced except in full, without prior written approval of the Company. Any unauthorized alteration, forgery or falsification of the content or appearance of this document is unlawful and offenders may be prosecuted to the fullest extent of the law. Unless otherwise stated the results shown in this test report refer only to the sample(s) tested and such sample(s) are retained for 30 days only.

Attention: To check the authenticity of testing/inspection report & certificate, please contact us at telephone: (86-755) 8307 1443, or email: CN.Doccheck@sgs.com

South of No. 6 Plant, No. 1, Runsheng Road, Suzhou Industrial Park, Suzhou Area, China (Jiangsu) Pilot Free Trade Zone 215000 t (86-512) 62992980 www.sgs.com.cn
 中国·苏州·中国(江苏)自由贸易试验区苏州片区苏州工业园区润胜路1号的6号厂房南楼 邮编: 215000 t (86-512) 62992980 sgs.china@sgs.com

802.11b_Channel 11

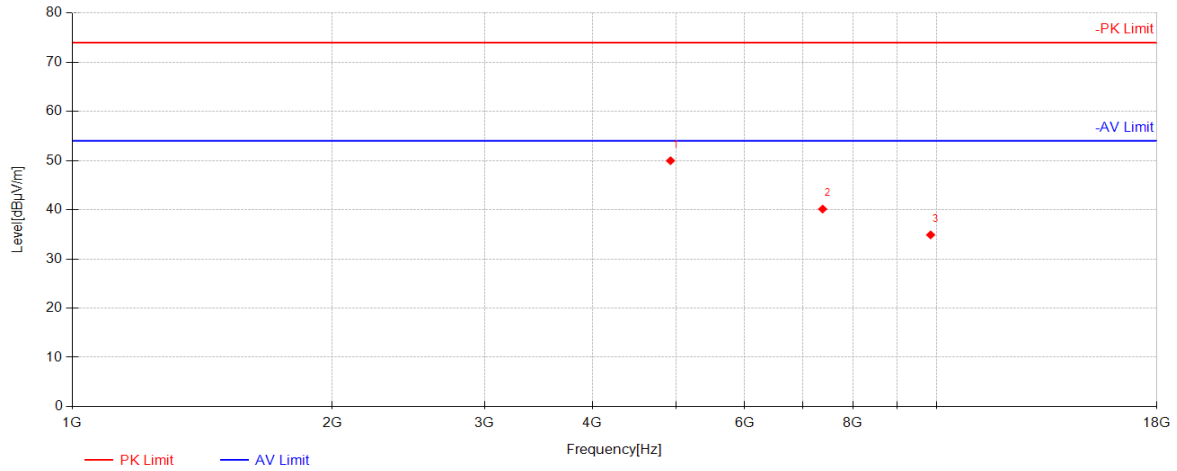

Data List								
NO.	Frequency [MHz]	Reading [dBµV]	AF [dB/m]	Factor [dB]	Level [dBµV/m]	Limit [dBµV/m]	Margin [dB]	Polarity
1	4924.0000	64.30	31.23	-45.56	49.98	74.00	24.02	Horizontal
2	7386.0000	47.32	36.28	-43.46	40.14	74.00	33.86	Horizontal
3	9848.0000	36.39	37.91	-39.41	34.89	74.00	39.11	Horizontal



Unless otherwise agreed in writing, this document is issued by the Company subject to its General Conditions of Service printed overleaf, available on request or accessible at <http://www.sgs.com/en/Terms-and-Conditions.aspx> and, for electronic format documents, subject to Terms and Conditions for Electronic Documents at <http://www.sgs.com/en/Terms-and-Conditions/Terms-e-Documents.aspx>. Attention is drawn to the limitation of liability, indemnification and jurisdiction issues defined therein. Any holder of this document is advised that information contained hereon reflects the Company's findings at the time of its intervention only and within the limits of Client's instructions, if any. The Company's sole responsibility is to its Client and this document does not exonerate parties to a transaction from exercising all their rights and obligations under the transaction documents. This document cannot be reproduced except in full, without prior written approval of the Company. Any unauthorized alteration, forgery or falsification of the content or appearance of this document is unlawful and offenders may be prosecuted to the fullest extent of the law. Unless otherwise stated the results shown in this test report refer only to the sample(s) tested and such sample(s) are retained for 30 days only.

Attention: To check the authenticity of testing/inspection report & certificate, please contact us at telephone: (86-755) 8307 1443, or email: CN.Doccheck@sgs.com
 South of No. 6 Plant, No. 1, Runsheng Road, Suzhou Industrial Park, Suzhou Area, China (Jiangsu) Pilot Free Trade Zone 215000 t (86-512) 62992980 www.sgs.com.cn
 中国·苏州·中国(江苏)自由贸易试验区苏州片区苏州工业园区润胜路1号的6号厂房南楼 邮编: 215000 t (86-512) 62992980 sgs.china@sgs.com

802.11b_Channel 11

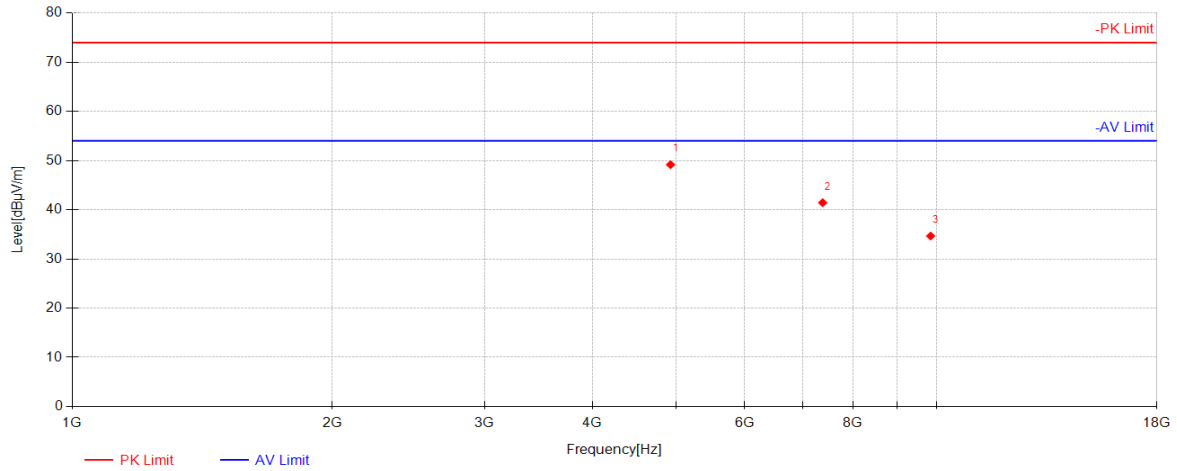

Data List								
NO.	Frequency [MHz]	Reading [dBµV]	AF [dB/m]	Factor [dB]	Level [dBµV/m]	Limit [dBµV/m]	Margin [dB]	Polarity
1	4924.0000	63.50	31.23	-45.56	49.18	74.00	24.82	Vertical
2	7386.0000	48.62	36.28	-43.46	41.44	74.00	32.56	Vertical
3	9848.0000	36.16	37.91	-39.41	34.66	74.00	39.34	Vertical



Unless otherwise agreed in writing, this document is issued by the Company subject to its General Conditions of Service printed overleaf, available on request or accessible at <http://www.sgs.com/en/Terms-and-Conditions.aspx> and, for electronic format documents, subject to Terms and Conditions for Electronic Documents at <http://www.sgs.com/en/Terms-and-Conditions/Terms-e-Documents.aspx>. Attention is drawn to the limitation of liability, indemnification and jurisdiction issues defined therein. Any holder of this document is advised that information contained hereon reflects the Company's findings at the time of its intervention only and within the limits of Client's instructions, if any. The Company's sole responsibility is to its Client and this document does not exonerate parties to a transaction from exercising all their rights and obligations under the transaction documents. This document cannot be reproduced except in full, without prior written approval of the Company. Any unauthorized alteration, forgery or falsification of the content or appearance of this document is unlawful and offenders may be prosecuted to the fullest extent of the law. Unless otherwise stated the results shown in this test report refer only to the sample(s) tested and such sample(s) are retained for 30 days only.

Attention: To check the authenticity of testing/inspection report & certificate, please contact us at telephone: (86-755) 8307 1443, or email: CN.Doccheck@sgs.com

South of No. 6 Plant, No. 1, Runsheng Road, Suzhou Industrial Park, Suzhou Area, China (Jiangsu) Pilot Free Trade Zone 215000 t (86-512) 62992980 www.sgs.com.cn
 中国·苏州·中国(江苏)自由贸易试验区苏州片区苏州工业园区润胜路1号的6号厂房南楼 邮编: 215000 t (86-512) 62992980 sgs.china@sgs.com

802.11g_Channel 01

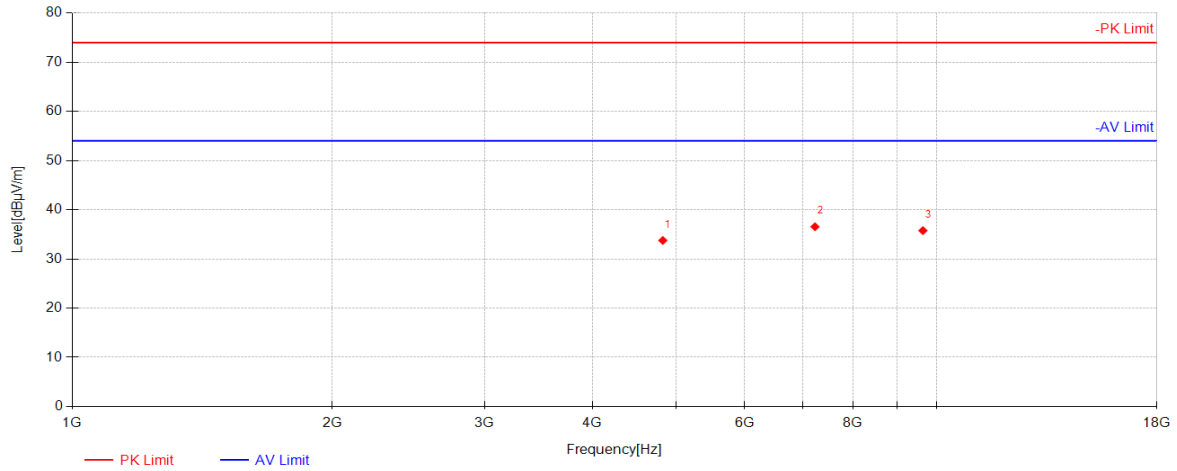

Data List								
NO.	Frequency [MHz]	Reading [dBµV]	AF [dB/m]	Factor [dB]	Level [dBµV/m]	Limit [dBµV/m]	Margin [dB]	Polarity
1	4824.0000	48.28	31.01	-45.54	33.76	74.00	40.24	Horizontal
2	7236.0000	44.23	35.86	-43.54	36.55	74.00	37.45	Horizontal
3	9648.0000	37.79	37.53	-39.56	35.76	74.00	38.24	Horizontal



Unless otherwise agreed in writing, this document is issued by the Company subject to its General Conditions of Service printed overleaf, available on request or accessible at <http://www.sgs.com/en/Terms-and-Conditions.aspx> and, for electronic format documents, subject to Terms and Conditions for Electronic Documents at <http://www.sgs.com/en/Terms-and-Conditions/Terms-e-Documents.aspx>. Attention is drawn to the limitation of liability, indemnification and jurisdiction issues defined therein. Any holder of this document is advised that information contained hereon reflects the Company's findings at the time of its intervention only and within the limits of Client's instructions, if any. The Company's sole responsibility is to its Client and this document does not exonerate parties to a transaction from exercising all their rights and obligations under the transaction documents. This document cannot be reproduced except in full, without prior written approval of the Company. Any unauthorized alteration, forgery or falsification of the content or appearance of this document is unlawful and offenders may be prosecuted to the fullest extent of the law. Unless otherwise stated the results shown in this test report refer only to the sample(s) tested and such sample(s) are retained for 30 days only.

Attention: To check the authenticity of testing/inspection report & certificate, please contact us at telephone: (86-755) 8307 1443, or email: CN.Doccheck@sgs.com

South of No. 6 Plant, No. 1, Runsheng Road, Suzhou Industrial Park, Suzhou Area, China (Jiangsu) Pilot Free Trade Zone 215000 t (86-512) 62992980 www.sgsgroup.com.cn
 中国·苏州·中国(江苏)自由贸易试验区苏州片区苏州工业园区润胜路1号的6号厂房南楼 邮编: 215000 t (86-512) 62992980 sgs.china@sgs.com

802.11g_Channel 01

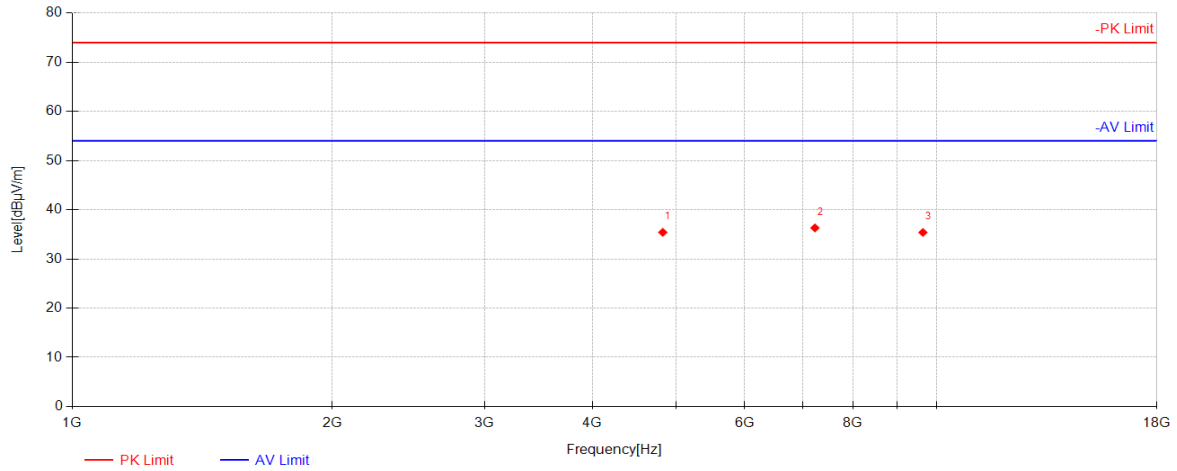

Data List								
NO.	Frequency [MHz]	Reading [dBµV]	AF [dB/m]	Factor [dB]	Level [dBµV/m]	Limit [dBµV/m]	Margin [dB]	Polarity
1	4824.0000	49.93	31.01	-45.54	35.41	74.00	38.59	Vertical
2	7236.0000	43.99	35.86	-43.54	36.31	74.00	37.69	Vertical
3	9648.0000	37.42	37.53	-39.56	35.39	74.00	38.61	Vertical



Unless otherwise agreed in writing, this document is issued by the Company subject to its General Conditions of Service printed overleaf, available on request or accessible at <http://www.sgs.com/en/Terms-and-Conditions.aspx> and, for electronic format documents, subject to Terms and Conditions for Electronic Documents at <http://www.sgs.com/en/Terms-and-Conditions/Terms-e-Documents.aspx>. Attention is drawn to the limitation of liability, indemnification and jurisdiction issues defined therein. Any holder of this document is advised that information contained hereon reflects the Company's findings at the time of its intervention only and within the limits of Client's instructions, if any. The Company's sole responsibility is to its Client and this document does not exonerate parties to a transaction from exercising all their rights and obligations under the transaction documents. This document cannot be reproduced except in full, without prior written approval of the Company. Any unauthorized alteration, forgery or falsification of the content or appearance of this document is unlawful and offenders may be prosecuted to the fullest extent of the law. Unless otherwise stated the results shown in this test report refer only to the sample(s) tested and such sample(s) are retained for 30 days only.

Attention: To check the authenticity of testing/inspection report & certificate, please contact us at telephone: (86-755) 8307 1443, or email: CN.Doccheck@sgs.com

South of No. 6 Plant, No. 1, Runsheng Road, Suzhou Industrial Park, Suzhou Area, China (Jiangsu) Pilot Free Trade Zone 215000 t (86-512) 62992980 www.sgs.com.cn
 中国·苏州·中国(江苏)自由贸易试验区苏州片区苏州工业园区润胜路1号的6号厂房南楼 邮编: 215000 t (86-512) 62992980 sgs.china@sgs.com

802.11g_Channel 06

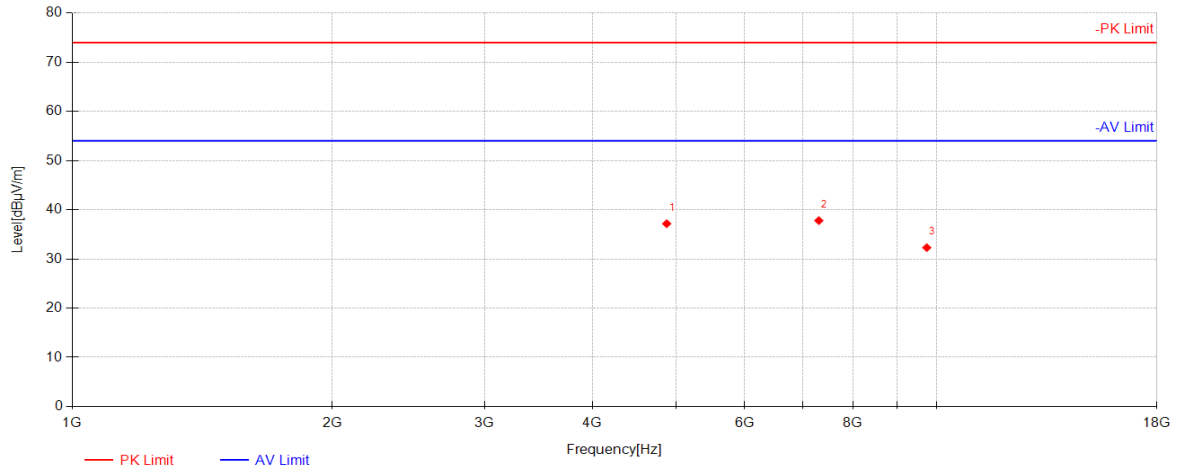

Data List								
NO.	Frequency [MHz]	Reading [dBµV]	AF [dB/m]	Factor [dB]	Level [dBµV/m]	Limit [dBµV/m]	Margin [dB]	Polarity
1	4874.0000	51.58	31.12	-45.53	37.17	74.00	36.83	Horizontal
2	7311.0000	45.44	36.07	-43.71	37.80	74.00	36.20	Horizontal
3	9748.0000	34.04	37.72	-39.46	32.30	74.00	41.70	Horizontal



Unless otherwise agreed in writing, this document is issued by the Company subject to its General Conditions of Service printed overleaf, available on request or accessible at <http://www.sgs.com/en/Terms-and-Conditions.aspx> and, for electronic format documents, subject to Terms and Conditions for Electronic Documents at <http://www.sgs.com/en/Terms-and-Conditions/Terms-e-Documents.aspx>. Attention is drawn to the limitation of liability, indemnification and jurisdiction issues defined therein. Any holder of this document is advised that information contained hereon reflects the Company's findings at the time of its intervention only and within the limits of Client's instructions, if any. The Company's sole responsibility is to its Client and this document does not exonerate parties to a transaction from exercising all their rights and obligations under the transaction documents. This document cannot be reproduced except in full, without prior written approval of the Company. Any unauthorized alteration, forgery or falsification of the content or appearance of this document is unlawful and offenders may be prosecuted to the fullest extent of the law. Unless otherwise stated the results shown in this test report refer only to the sample(s) tested and such sample(s) are retained for 30 days only.

Attention: To check the authenticity of testing/inspection report & certificate, please contact us at telephone: (86-755) 8307 1443, or email: CN.Doccheck@sgs.com

South of No. 6 Plant, No. 1, Runsheng Road, Suzhou Industrial Park, Suzhou Area, China (Jiangsu) Pilot Free Trade Zone 215000 t (86-512) 62992980 www.sgs.com.cn
 中国·苏州·中国(江苏)自由贸易试验区苏州片区苏州工业园区润胜路1号的6号厂房南楼 邮编: 215000 t (86-512) 62992980 sgs.china@sgs.com

802.11g_Channel 06

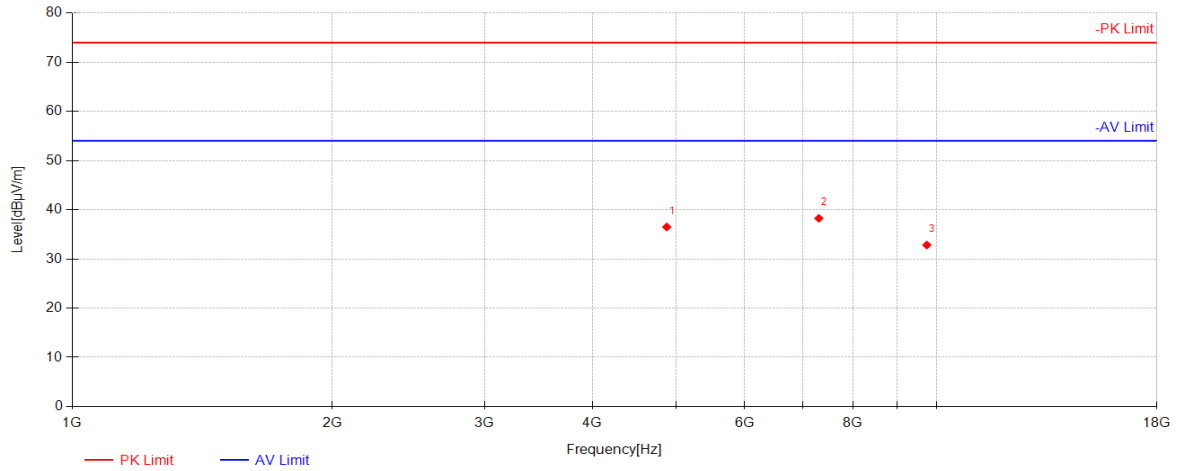

Data List								
NO.	Frequency [MHz]	Reading [dBµV]	AF [dB/m]	Factor [dB]	Level [dBµV/m]	Limit [dBµV/m]	Margin [dB]	Polarity
1	4874.0000	50.91	31.12	-45.53	36.50	74.00	37.50	Vertical
2	7311.0000	45.90	36.07	-43.71	38.26	74.00	35.74	Vertical
3	9748.0000	34.56	37.72	-39.46	32.82	74.00	41.18	Vertical



Unless otherwise agreed in writing, this document is issued by the Company subject to its General Conditions of Service printed overleaf, available on request or accessible at <http://www.sgs.com/en/Terms-and-Conditions.aspx> and, for electronic format documents, subject to Terms and Conditions for Electronic Documents at <http://www.sgs.com/en/Terms-and-Conditions/Terms-e-Documents.aspx>. Attention is drawn to the limitation of liability, indemnification and jurisdiction issues defined therein. Any holder of this document is advised that information contained hereon reflects the Company's findings at the time of its intervention only and within the limits of Client's instructions, if any. The Company's sole responsibility is to its Client and this document does not exonerate parties to a transaction from exercising all their rights and obligations under the transaction documents. This document cannot be reproduced except in full, without prior written approval of the Company. Any unauthorized alteration, forgery or falsification of the content or appearance of this document is unlawful and offenders may be prosecuted to the fullest extent of the law. Unless otherwise stated the results shown in this test report refer only to the sample(s) tested and such sample(s) are retained for 30 days only.

Attention: To check the authenticity of testing/inspection report & certificate, please contact us at telephone: (86-755) 8307 1443, or email: CN.Doccheck@sgs.com

South of No. 6 Plant, No. 1, Runsheng Road, Suzhou Industrial Park, Suzhou Area, China (Jiangsu) Pilot Free Trade Zone 215000 t (86-512) 62992980 www.sgsgroup.com.cn
 中国·苏州·中国(江苏)自由贸易试验区苏州片区苏州工业园区润胜路1号的6号厂房南楼 邮编: 215000 t (86-512) 62992980 sgs.china@sgs.com

802.11g_Channel 11

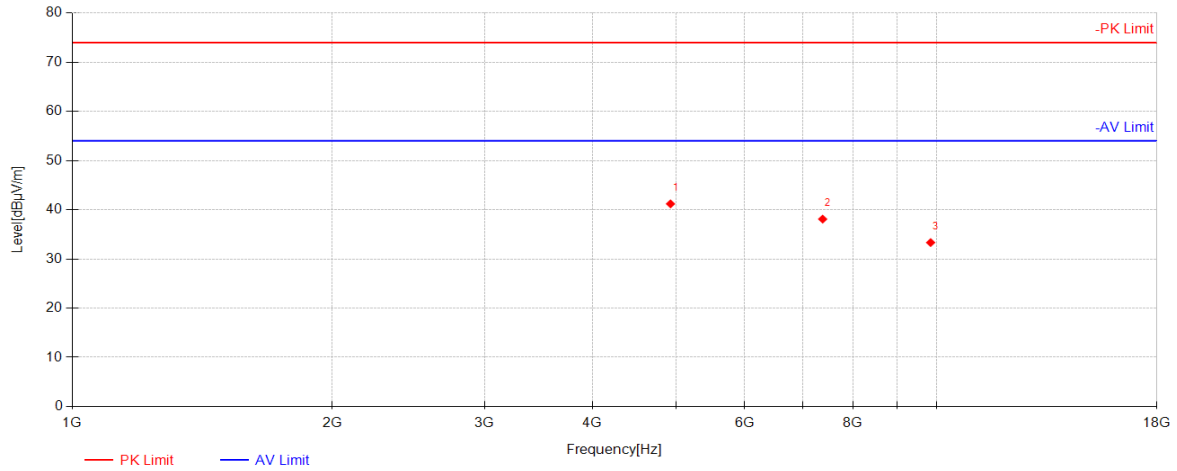

Data List								
NO.	Frequency [MHz]	Reading [dBµV]	AF [dB/m]	Factor [dB]	Level [dBµV/m]	Limit [dBµV/m]	Margin [dB]	Polarity
1	4924.0000	55.52	31.23	-45.56	41.20	74.00	32.80	Horizontal
2	7386.0000	45.28	36.28	-43.46	38.10	74.00	35.90	Horizontal
3	9848.0000	34.83	37.91	-39.41	33.33	74.00	40.67	Horizontal



Unless otherwise agreed in writing, this document is issued by the Company subject to its General Conditions of Service printed overleaf, available on request or accessible at <http://www.sgs.com/en/Terms-and-Conditions.aspx> and, for electronic format documents, subject to Terms and Conditions for Electronic Documents at <http://www.sgs.com/en/Terms-and-Conditions/Terms-e-Documents.aspx>. Attention is drawn to the limitation of liability, indemnification and jurisdiction issues defined therein. Any holder of this document is advised that information contained hereon reflects the Company's findings at the time of its intervention only and within the limits of Client's instructions, if any. The Company's sole responsibility is to its Client and this document does not exonerate parties to a transaction from exercising all their rights and obligations under the transaction documents. This document cannot be reproduced except in full, without prior written approval of the Company. Any unauthorized alteration, forgery or falsification of the content or appearance of this document is unlawful and offenders may be prosecuted to the fullest extent of the law. Unless otherwise stated the results shown in this test report refer only to the sample(s) tested and such sample(s) are retained for 30 days only.

Attention: To check the authenticity of testing/inspection report & certificate, please contact us at telephone: (86-755) 8307 1443, or email: CN.Doccheck@sgs.com

South of No. 6 Plant, No. 1, Runsheng Road, Suzhou Industrial Park, Suzhou Area, China (Jiangsu) Pilot Free Trade Zone 215000 t (86-512) 62992980 www.sgsgroup.com.cn
 中国·苏州·中国(江苏)自由贸易试验区苏州片区苏州工业园区润胜路1号的6号厂房南楼 邮编: 215000 t (86-512) 62992980 sgs.china@sgs.com

802.11g_Channel 11

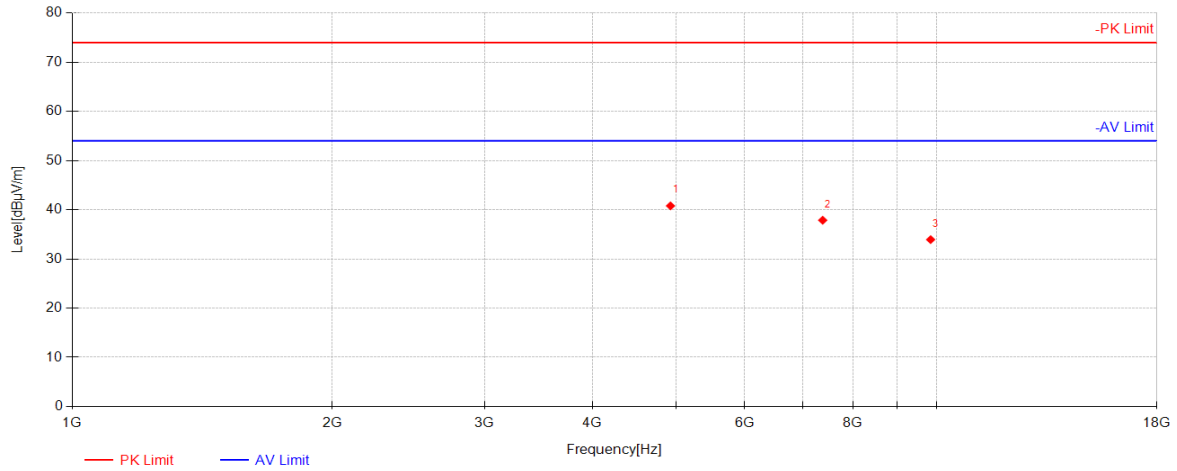

Data List								
NO.	Frequency [MHz]	Reading [dBµV]	AF [dB/m]	Factor [dB]	Level [dBµV/m]	Limit [dBµV/m]	Margin [dB]	Polarity
1	4924.0000	55.11	31.23	-45.56	40.79	74.00	33.21	Vertical
2	7386.0000	45.05	36.28	-43.46	37.87	74.00	36.13	Vertical
3	9848.0000	35.43	37.91	-39.41	33.93	74.00	40.07	Vertical



Unless otherwise agreed in writing, this document is issued by the Company subject to its General Conditions of Service printed overleaf, available on request or accessible at <http://www.sgs.com/en/Terms-and-Conditions.aspx> and, for electronic format documents, subject to Terms and Conditions for Electronic Documents at <http://www.sgs.com/en/Terms-and-Conditions/Terms-e-Documents.aspx>. Attention is drawn to the limitation of liability, indemnification and jurisdiction issues defined therein. Any holder of this document is advised that information contained hereon reflects the Company's findings at the time of its intervention only and within the limits of Client's instructions, if any. The Company's sole responsibility is to its Client and this document does not exonerate parties to a transaction from exercising all their rights and obligations under the transaction documents. This document cannot be reproduced except in full, without prior written approval of the Company. Any unauthorized alteration, forgery or falsification of the content or appearance of this document is unlawful and offenders may be prosecuted to the fullest extent of the law. Unless otherwise stated the results shown in this test report refer only to the sample(s) tested and such sample(s) are retained for 30 days only.

Attention: To check the authenticity of testing/inspection report & certificate, please contact us at telephone: (86-755) 8307 1443, or email: CN.Doccheck@sgs.com

South of No. 6 Plant, No. 1, Runsheng Road, Suzhou Industrial Park, Suzhou Area, China (Jiangsu) Pilot Free Trade Zone 215000 t (86-512) 62992980 www.sgsgroup.com.cn
 中国·苏州·中国(江苏)自由贸易试验区苏州片区苏州工业园区润胜路1号的6号厂房南楼 邮编: 215000 t (86-512) 62992980 sgs.china@sgs.com

802.11n20_Channel 01

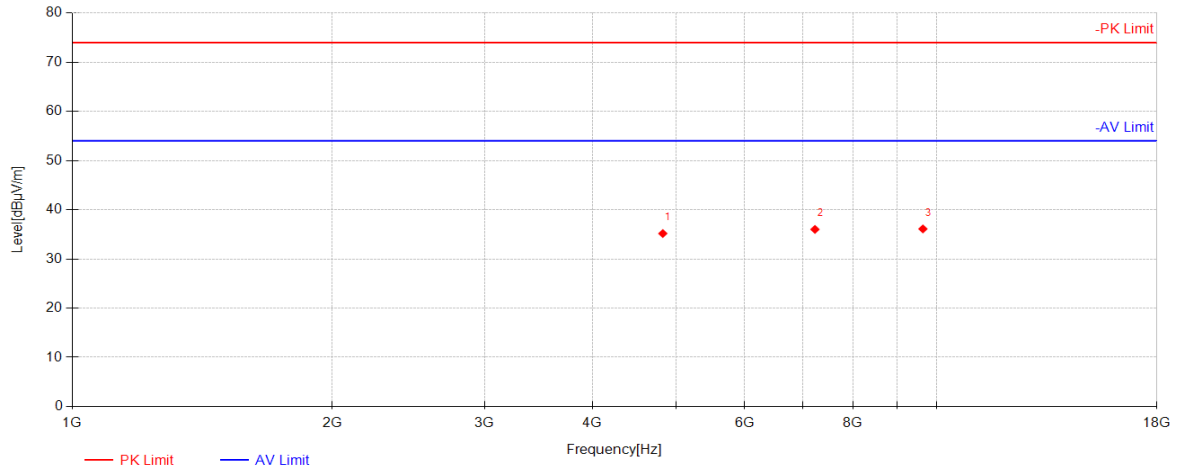

Data List								
NO.	Frequency [MHz]	Reading [dBµV]	AF [dB/m]	Factor [dB]	Level [dBµV/m]	Limit [dBµV/m]	Margin [dB]	Polarity
1	4824.0000	49.69	31.01	-45.54	35.17	74.00	38.83	Horizontal
2	7236.0000	43.69	35.86	-43.54	36.01	74.00	37.99	Horizontal
3	9648.0000	38.14	37.53	-39.56	36.11	74.00	37.89	Horizontal



Unless otherwise agreed in writing, this document is issued by the Company subject to its General Conditions of Service printed overleaf, available on request or accessible at <http://www.sgs.com/en/Terms-and-Conditions.aspx> and, for electronic format documents, subject to Terms and Conditions for Electronic Documents at <http://www.sgs.com/en/Terms-and-Conditions/Terms-e-Documents.aspx>. Attention is drawn to the limitation of liability, indemnification and jurisdiction issues defined therein. Any holder of this document is advised that information contained hereon reflects the Company's findings at the time of its intervention only and within the limits of Client's instructions, if any. The Company's sole responsibility is to its Client and this document does not exonerate parties to a transaction from exercising all their rights and obligations under the transaction documents. This document cannot be reproduced except in full, without prior written approval of the Company. Any unauthorized alteration, forgery or falsification of the content or appearance of this document is unlawful and offenders may be prosecuted to the fullest extent of the law. Unless otherwise stated the results shown in this test report refer only to the sample(s) tested and such sample(s) are retained for 30 days only.

Attention: To check the authenticity of testing/inspection report & certificate, please contact us at telephone: (86-755) 8307 1443, or email: CN.Doccheck@sgs.com

South of No. 6 Plant, No. 1, Runsheng Road, Suzhou Industrial Park, Suzhou Area, China (Jiangsu) Pilot Free Trade Zone 215000 t (86-512) 62992980 www.sgsgroup.com.cn
 中国·苏州·中国(江苏)自由贸易试验区苏州片区苏州工业园区润胜路1号的6号厂房南楼 邮编: 215000 t (86-512) 62992980 sgs.china@sgs.com

802.11n20_Channel 01

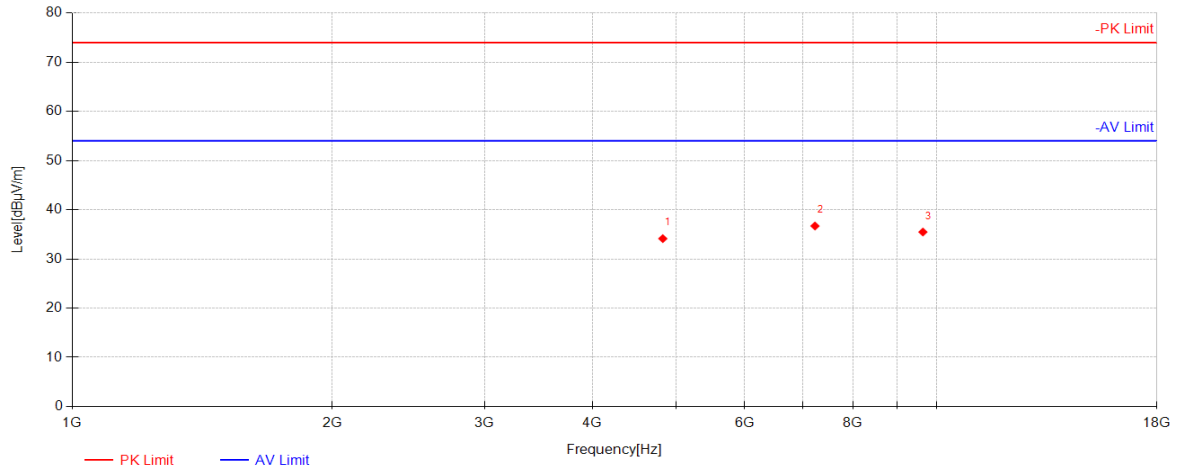

Data List								
NO.	Frequency [MHz]	Reading [dBµV]	AF [dB/m]	Factor [dB]	Level [dBµV/m]	Limit [dBµV/m]	Margin [dB]	Polarity
1	4824.0000	48.65	31.01	-45.54	34.13	74.00	39.87	Vertical
2	7236.0000	44.38	35.86	-43.54	36.70	74.00	37.30	Vertical
3	9648.0000	37.51	37.53	-39.56	35.48	74.00	38.52	Vertical



Unless otherwise agreed in writing, this document is issued by the Company subject to its General Conditions of Service printed overleaf, available on request or accessible at <http://www.sgs.com/en/Terms-and-Conditions.aspx> and, for electronic format documents, subject to Terms and Conditions for Electronic Documents at <http://www.sgs.com/en/Terms-and-Conditions/Terms-e-Documents.aspx>. Attention is drawn to the limitation of liability, indemnification and jurisdiction issues defined therein. Any holder of this document is advised that information contained hereon reflects the Company's findings at the time of its intervention only and within the limits of Client's instructions, if any. The Company's sole responsibility is to its Client and this document does not exonerate parties to a transaction from exercising all their rights and obligations under the transaction documents. This document cannot be reproduced except in full, without prior written approval of the Company. Any unauthorized alteration, forgery or falsification of the content or appearance of this document is unlawful and offenders may be prosecuted to the fullest extent of the law. Unless otherwise stated the results shown in this test report refer only to the sample(s) tested and such sample(s) are retained for 30 days only.

Attention: To check the authenticity of testing/inspection report & certificate, please contact us at telephone: (86-755) 8307 1443, or email: CN.Doccheck@sgs.com

South of No. 6 Plant, No. 1, Runsheng Road, Suzhou Industrial Park, Suzhou Area, China (Jiangsu) Pilot Free Trade Zone 215000 t (86-512) 62992980 www.sgs.com.cn
 中国·苏州·中国(江苏)自由贸易试验区苏州片区苏州工业园区润胜路1号的6号厂房南楼 邮编: 215000 t (86-512) 62992980 sgs.china@sgs.com

802.11n20_Channel 06

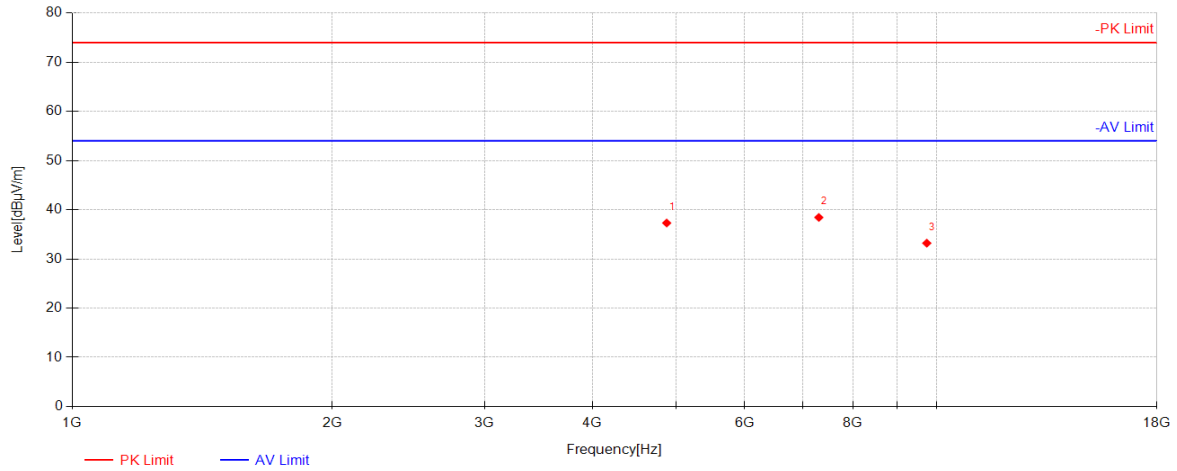

Data List								
NO.	Frequency [MHz]	Reading [dBµV]	AF [dB/m]	Factor [dB]	Level [dBµV/m]	Limit [dBµV/m]	Margin [dB]	Polarity
1	4874.0000	51.72	31.12	-45.53	37.31	74.00	36.69	Horizontal
2	7311.0000	46.08	36.07	-43.71	38.44	74.00	35.56	Horizontal
3	9748.0000	34.95	37.72	-39.46	33.21	74.00	40.79	Horizontal



Unless otherwise agreed in writing, this document is issued by the Company subject to its General Conditions of Service printed overleaf, available on request or accessible at <http://www.sgs.com/en/Terms-and-Conditions.aspx> and, for electronic format documents, subject to Terms and Conditions for Electronic Documents at <http://www.sgs.com/en/Terms-and-Conditions/Terms-e-Documents.aspx>. Attention is drawn to the limitation of liability, indemnification and jurisdiction issues defined therein. Any holder of this document is advised that information contained hereon reflects the Company's findings at the time of its intervention only and within the limits of Client's instructions, if any. The Company's sole responsibility is to its Client and this document does not exonerate parties to a transaction from exercising all their rights and obligations under the transaction documents. This document cannot be reproduced except in full, without prior written approval of the Company. Any unauthorized alteration, forgery or falsification of the content or appearance of this document is unlawful and offenders may be prosecuted to the fullest extent of the law. Unless otherwise stated the results shown in this test report refer only to the sample(s) tested and such sample(s) are retained for 30 days only.

Attention: To check the authenticity of testing/inspection report & certificate, please contact us at telephone: (86-755) 8307 1443, or email: CN.Doccheck@sgs.com

South of No. 6 Plant, No. 1, Runsheng Road, Suzhou Industrial Park, Suzhou Area, China (Jiangsu) Pilot Free Trade Zone 215000 t (86-512) 62992980 www.sgsgroup.com.cn
 中国·苏州·中国(江苏)自由贸易试验区苏州片区苏州工业园区润胜路1号的6号厂房南楼 邮编: 215000 t (86-512) 62992980 sgs.china@sgs.com

802.11n20_Channel 06

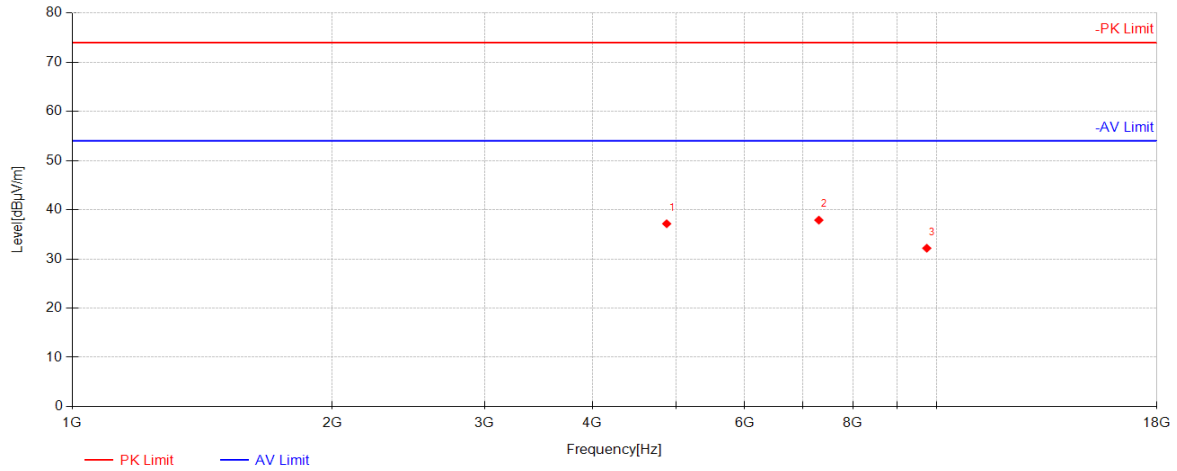

Data List								
NO.	Frequency [MHz]	Reading [dBµV]	AF [dB/m]	Factor [dB]	Level [dBµV/m]	Limit [dBµV/m]	Margin [dB]	Polarity
1	4874.0000	51.57	31.12	-45.53	37.16	74.00	36.84	Vertical
2	7311.0000	45.53	36.07	-43.71	37.89	74.00	36.11	Vertical
3	9748.0000	33.92	37.72	-39.46	32.18	74.00	41.82	Vertical



Unless otherwise agreed in writing, this document is issued by the Company subject to its General Conditions of Service printed overleaf, available on request or accessible at <http://www.sgs.com/en/Terms-and-Conditions.aspx> and, for electronic format documents, subject to Terms and Conditions for Electronic Documents at <http://www.sgs.com/en/Terms-and-Conditions/Terms-e-Documents.aspx>. Attention is drawn to the limitation of liability, indemnification and jurisdiction issues defined therein. Any holder of this document is advised that information contained hereon reflects the Company's findings at the time of its intervention only and within the limits of Client's instructions, if any. The Company's sole responsibility is to its Client and this document does not exonerate parties to a transaction from exercising all their rights and obligations under the transaction documents. This document cannot be reproduced except in full, without prior written approval of the Company. Any unauthorized alteration, forgery or falsification of the content or appearance of this document is unlawful and offenders may be prosecuted to the fullest extent of the law. Unless otherwise stated the results shown in this test report refer only to the sample(s) tested and such sample(s) are retained for 30 days only.

Attention: To check the authenticity of testing/inspection report & certificate, please contact us at telephone: (86-755) 8307 1443, or email: CN.Doccheck@sgs.com

South of No. 6 Plant, No. 1, Runsheng Road, Suzhou Industrial Park, Suzhou Area, China (Jiangsu) Pilot Free Trade Zone 215000 t (86-512) 62992980 www.sgsgroup.com.cn
 中国·苏州·中国(江苏)自由贸易试验区苏州片区苏州工业园区润胜路1号的6号厂房南楼 邮编: 215000 t (86-512) 62992980 sgs.china@sgs.com

802.11n20_Channel 11

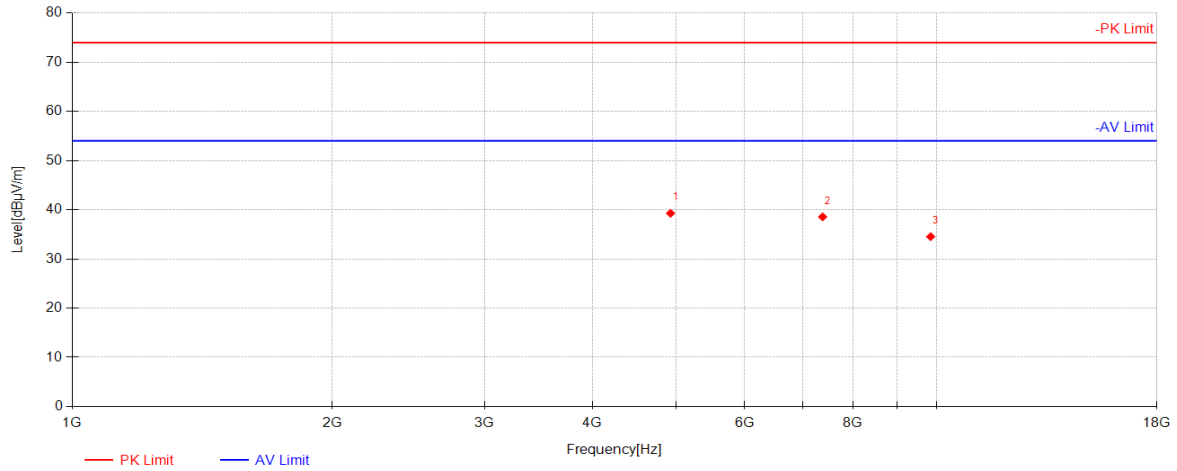

Data List								
NO.	Frequency [MHz]	Reading [dBµV]	AF [dB/m]	Factor [dB]	Level [dBµV/m]	Limit [dBµV/m]	Margin [dB]	Polarity
1	4924.0000	53.60	31.23	-45.56	39.28	74.00	34.72	Horizontal
2	7386.0000	45.74	36.28	-43.46	38.56	74.00	35.44	Horizontal
3	9848.0000	36.03	37.91	-39.41	34.53	74.00	39.47	Horizontal



Unless otherwise agreed in writing, this document is issued by the Company subject to its General Conditions of Service printed overleaf, available on request or accessible at <http://www.sgs.com/en/Terms-and-Conditions.aspx> and, for electronic format documents, subject to Terms and Conditions for Electronic Documents at <http://www.sgs.com/en/Terms-and-Conditions/Terms-e-Documents.aspx>. Attention is drawn to the limitation of liability, indemnification and jurisdiction issues defined therein. Any holder of this document is advised that information contained hereon reflects the Company's findings at the time of its intervention only and within the limits of Client's instructions, if any. The Company's sole responsibility is to its Client and this document does not exonerate parties to a transaction from exercising all their rights and obligations under the transaction documents. This document cannot be reproduced except in full, without prior written approval of the Company. Any unauthorized alteration, forgery or falsification of the content or appearance of this document is unlawful and offenders may be prosecuted to the fullest extent of the law. Unless otherwise stated the results shown in this test report refer only to the sample(s) tested and such sample(s) are retained for 30 days only.

Attention: To check the authenticity of testing/inspection report & certificate, please contact us at telephone: (86-755) 8307 1443, or email: CN.Doccheck@sgs.com

South of No. 6 Plant, No. 1, Runsheng Road, Suzhou Industrial Park, Suzhou Area, China (Jiangsu) Pilot Free Trade Zone 215000 t (86-512) 62992980 www.sgsgroup.com.cn
 中国·苏州·中国(江苏)自由贸易试验区苏州片区苏州工业园区润胜路1号的6号厂房南楼 邮编: 215000 t (86-512) 62992980 sgs.china@sgs.com

802.11n20_Channel 11

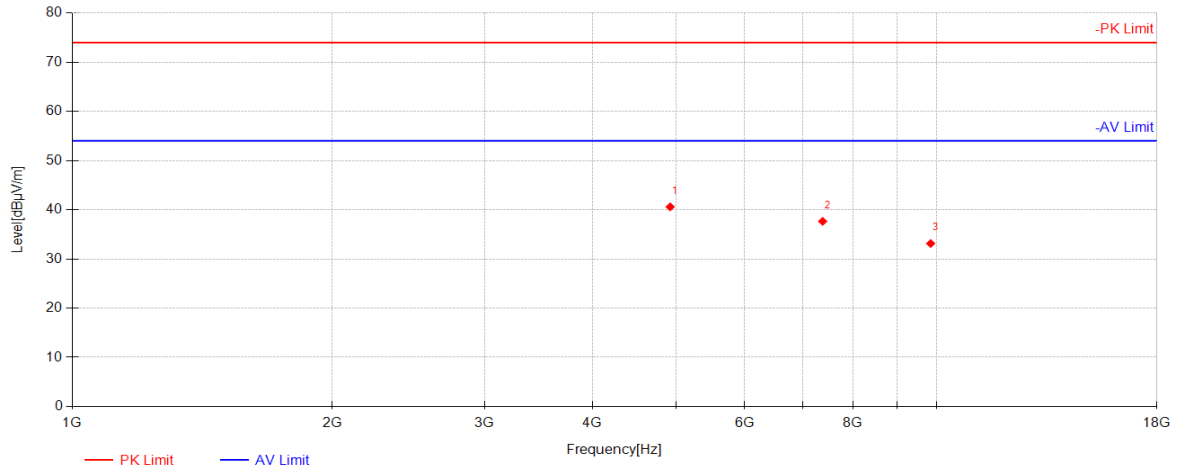

Data List								
NO.	Frequency [MHz]	Reading [dBµV]	AF [dB/m]	Factor [dB]	Level [dBµV/m]	Limit [dBµV/m]	Margin [dB]	Polarity
1	4919.5	54.92	31.22	-45.55	40.59	74.00	33.41	Vertical
2	7386.0000	44.83	36.28	-43.46	37.65	74.00	36.35	Vertical
3	9848.0000	34.64	37.91	-39.41	33.14	74.00	40.86	Vertical



Unless otherwise agreed in writing, this document is issued by the Company subject to its General Conditions of Service printed overleaf, available on request or accessible at <http://www.sgs.com/en/Terms-and-Conditions.aspx> and, for electronic format documents, subject to Terms and Conditions for Electronic Documents at <http://www.sgs.com/en/Terms-and-Conditions/Terms-e-Documents.aspx>. Attention is drawn to the limitation of liability, indemnification and jurisdiction issues defined therein. Any holder of this document is advised that information contained hereon reflects the Company's findings at the time of its intervention only and within the limits of Client's instructions, if any. The Company's sole responsibility is to its Client and this document does not exonerate parties to a transaction from exercising all their rights and obligations under the transaction documents. This document cannot be reproduced except in full, without prior written approval of the Company. Any unauthorized alteration, forgery or falsification of the content or appearance of this document is unlawful and offenders may be prosecuted to the fullest extent of the law. Unless otherwise stated the results shown in this test report refer only to the sample(s) tested and such sample(s) are retained for 30 days only.

Attention: To check the authenticity of testing/inspection report & certificate, please contact us at telephone: (86-755) 8307 1443, or email: CN.Doccheck@sgs.com

South of No. 6 Plant, No. 1, Runsheng Road, Suzhou Industrial Park, Suzhou Area, China (Jiangsu) Pilot Free Trade Zone 215000 t (86-512) 62992980 www.sgsgroup.com.cn
 中国·苏州·中国(江苏)自由贸易试验区苏州片区苏州工业园区润胜路1号的6号厂房南楼 邮编: 215000 t (86-512) 62992980 sgs.china@sgs.com

802.11n40_Channel 03

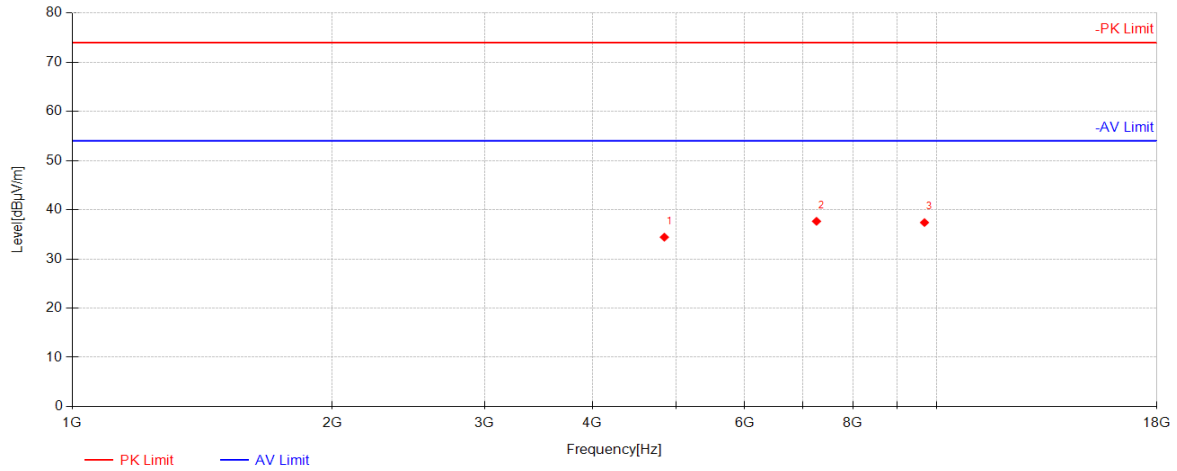

Data List								
NO.	Frequency [MHz]	Reading [dBµV]	AF [dB/m]	Factor [dB]	Level [dBµV/m]	Limit [dBµV/m]	Margin [dB]	Polarity
1	4844.0000	48.91	31.06	-45.54	34.43	74.00	39.57	Horizontal
2	7266.0000	45.35	35.94	-43.64	37.66	74.00	36.34	Horizontal
3	9688.0000	39.26	37.61	-39.47	37.40	74.00	36.60	Horizontal



Unless otherwise agreed in writing, this document is issued by the Company subject to its General Conditions of Service printed overleaf, available on request or accessible at <http://www.sgs.com/en/Terms-and-Conditions.aspx> and, for electronic format documents, subject to Terms and Conditions for Electronic Documents at <http://www.sgs.com/en/Terms-and-Conditions/Terms-e-Documents.aspx>. Attention is drawn to the limitation of liability, indemnification and jurisdiction issues defined therein. Any holder of this document is advised that information contained hereon reflects the Company's findings at the time of its intervention only and within the limits of Client's instructions, if any. The Company's sole responsibility is to its Client and this document does not exonerate parties to a transaction from exercising all their rights and obligations under the transaction documents. This document cannot be reproduced except in full, without prior written approval of the Company. Any unauthorized alteration, forgery or falsification of the content or appearance of this document is unlawful and offenders may be prosecuted to the fullest extent of the law. Unless otherwise stated the results shown in this test report refer only to the sample(s) tested and such sample(s) are retained for 30 days only.

Attention: To check the authenticity of testing/inspection report & certificate, please contact us at telephone: (86-755) 8307 1443, or email: CN.Doccheck@sgs.com

South of No. 6 Plant, No. 1, Runsheng Road, Suzhou Industrial Park, Suzhou Area, China (Jiangsu) Pilot Free Trade Zone 215000 t (86-512) 62992980 www.sgsgroup.com.cn
 中国·苏州·中国(江苏)自由贸易试验区苏州片区苏州工业园区润胜路1号的6号厂房南楼 邮编: 215000 t (86-512) 62992980 sgs.china@sgs.com

802.11n40_Channel 03

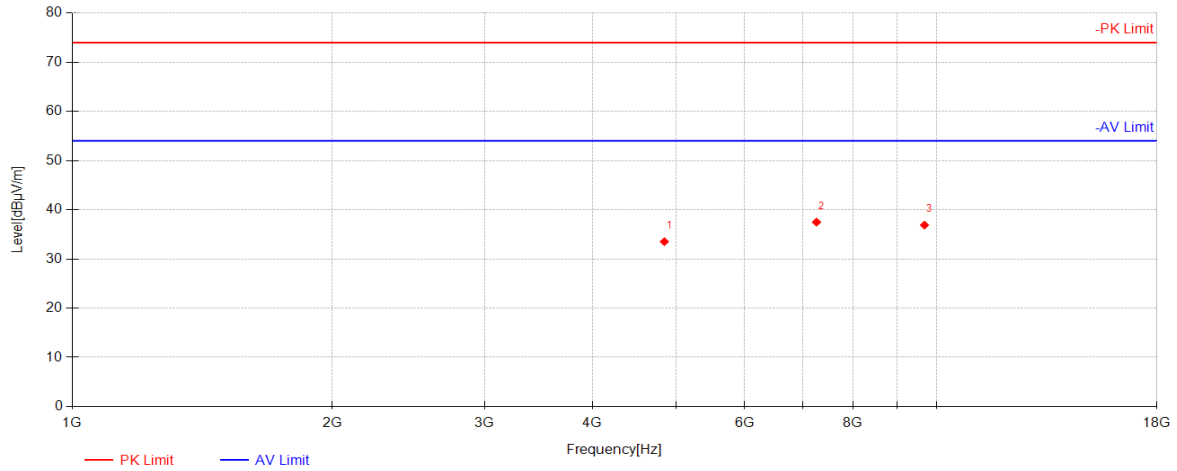

Data List								
NO.	Frequency [MHz]	Reading [dBµV]	AF [dB/m]	Factor [dB]	Level [dBµV/m]	Limit [dBµV/m]	Margin [dB]	Polarity
1	4844.0000	48.00	31.06	-45.54	33.52	74.00	40.48	Vertical
2	7266.0000	45.18	35.94	-43.64	37.49	74.00	36.51	Vertical
3	9688.0000	38.75	37.61	-39.47	36.89	74.00	37.11	Vertical



Unless otherwise agreed in writing, this document is issued by the Company subject to its General Conditions of Service printed overleaf, available on request or accessible at <http://www.sgs.com/en/Terms-and-Conditions.aspx> and, for electronic format documents, subject to Terms and Conditions for Electronic Documents at <http://www.sgs.com/en/Terms-and-Conditions/Terms-e-Documents.aspx>. Attention is drawn to the limitation of liability, indemnification and jurisdiction issues defined therein. Any holder of this document is advised that information contained hereon reflects the Company's findings at the time of its intervention only and within the limits of Client's instructions, if any. The Company's sole responsibility is to its Client and this document does not exonerate parties to a transaction from exercising all their rights and obligations under the transaction documents. This document cannot be reproduced except in full, without prior written approval of the Company. Any unauthorized alteration, forgery or falsification of the content or appearance of this document is unlawful and offenders may be prosecuted to the fullest extent of the law. Unless otherwise stated the results shown in this test report refer only to the sample(s) tested and such sample(s) are retained for 30 days only.

Attention: To check the authenticity of testing/inspection report & certificate, please contact us at telephone: (86-755) 8307 1443, or email: CN.Doccheck@sgs.com

South of No. 6 Plant, No. 1, Runsheng Road, Suzhou Industrial Park, Suzhou Area, China (Jiangsu) Pilot Free Trade Zone 215000 t (86-512) 62992980 www.sgs.com.cn
 中国·苏州·中国(江苏)自由贸易试验区苏州片区苏州工业园区润胜路1号的6号厂房南楼 邮编: 215000 t (86-512) 62992980 sgs.china@sgs.com

802.11n40_Channel 06

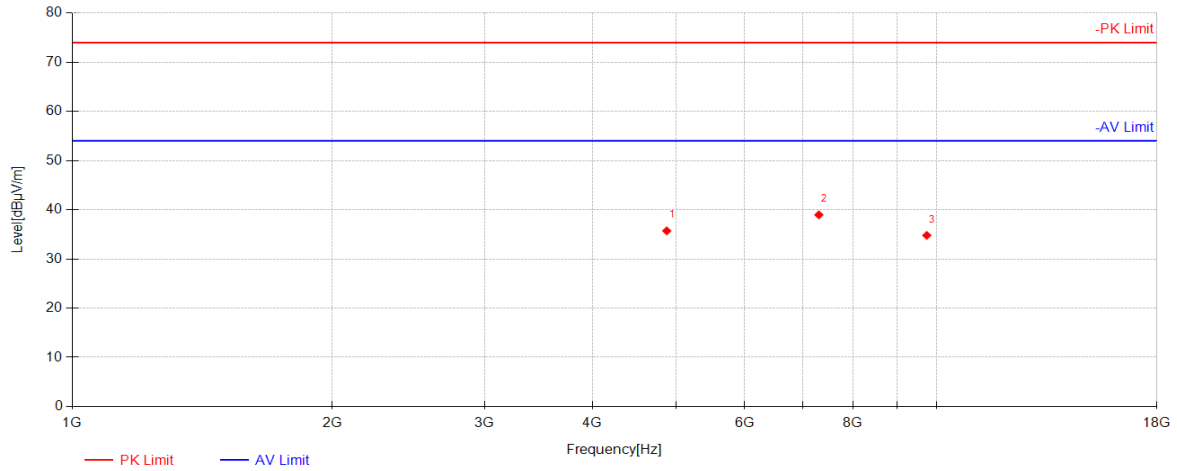

Data List								
NO.	Frequency [MHz]	Reading [dBµV]	AF [dB/m]	Factor [dB]	Level [dBµV/m]	Limit [dBµV/m]	Margin [dB]	Polarity
1	4874.0000	50.12	31.12	-45.53	35.71	74.00	38.29	Horizontal
2	7311.0000	46.60	36.07	-43.71	38.96	74.00	35.04	Horizontal
3	9748.0000	36.53	37.72	-39.46	34.79	74.00	39.21	Horizontal



Unless otherwise agreed in writing, this document is issued by the Company subject to its General Conditions of Service printed overleaf, available on request or accessible at <http://www.sgs.com/en/Terms-and-Conditions.aspx> and, for electronic format documents, subject to Terms and Conditions for Electronic Documents at <http://www.sgs.com/en/Terms-and-Conditions/Terms-e-Documents.aspx>. Attention is drawn to the limitation of liability, indemnification and jurisdiction issues defined therein. Any holder of this document is advised that information contained hereon reflects the Company's findings at the time of its intervention only and within the limits of Client's instructions, if any. The Company's sole responsibility is to its Client and this document does not exonerate parties to a transaction from exercising all their rights and obligations under the transaction documents. This document cannot be reproduced except in full, without prior written approval of the Company. Any unauthorized alteration, forgery or falsification of the content or appearance of this document is unlawful and offenders may be prosecuted to the fullest extent of the law. Unless otherwise stated the results shown in this test report refer only to the sample(s) tested and such sample(s) are retained for 30 days only.

Attention: To check the authenticity of testing/inspection report & certificate, please contact us at telephone: (86-755) 8307 1443, or email: CN.Doccheck@sgs.com

South of No. 6 Plant, No. 1, Runsheng Road, Suzhou Industrial Park, Suzhou Area, China (Jiangsu) Pilot Free Trade Zone 215000 t (86-512) 62992980 www.sgsgroup.com.cn
 中国·苏州·中国(江苏)自由贸易试验区苏州片区苏州工业园区润胜路1号的6号厂房南楼 邮编: 215000 t (86-512) 62992980 sgs.china@sgs.com

802.11n40_Channel 06

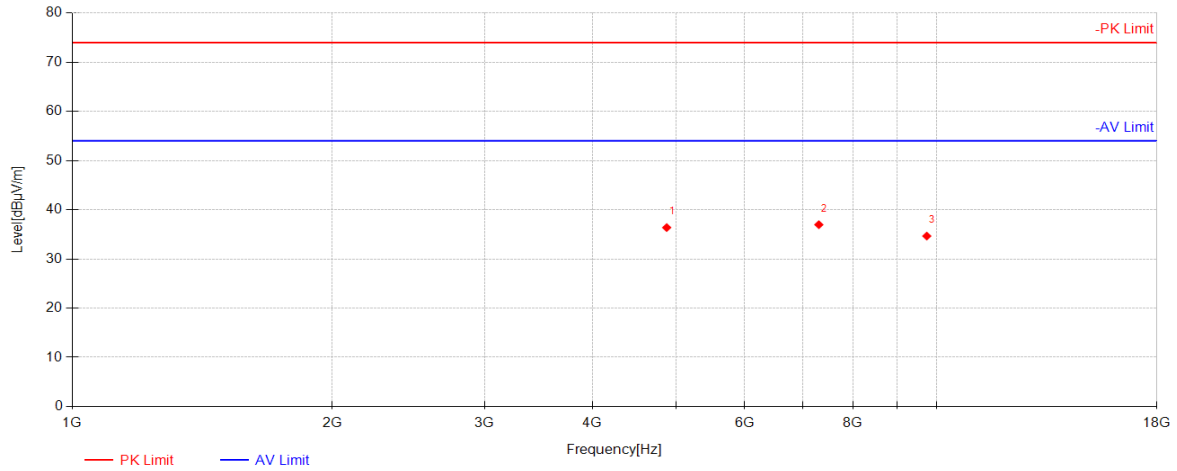

Data List								
NO.	Frequency [MHz]	Reading [dBµV]	AF [dB/m]	Factor [dB]	Level [dBµV/m]	Limit [dBµV/m]	Margin [dB]	Polarity
1	4874.0000	50.79	31.12	-45.53	36.38	74.00	37.62	Vertical
2	7311.0000	44.61	36.07	-43.71	36.97	74.00	37.03	Vertical
3	9748.0000	36.39	37.72	-39.46	34.65	74.00	39.35	Vertical



Unless otherwise agreed in writing, this document is issued by the Company subject to its General Conditions of Service printed overleaf, available on request or accessible at <http://www.sgs.com/en/Terms-and-Conditions.aspx> and, for electronic format documents, subject to Terms and Conditions for Electronic Documents at <http://www.sgs.com/en/Terms-and-Conditions/Terms-e-Documents.aspx>. Attention is drawn to the limitation of liability, indemnification and jurisdiction issues defined therein. Any holder of this document is advised that information contained hereon reflects the Company's findings at the time of its intervention only and within the limits of Client's instructions, if any. The Company's sole responsibility is to its Client and this document does not exonerate parties to a transaction from exercising all their rights and obligations under the transaction documents. This document cannot be reproduced except in full, without prior written approval of the Company. Any unauthorized alteration, forgery or falsification of the content or appearance of this document is unlawful and offenders may be prosecuted to the fullest extent of the law. Unless otherwise stated the results shown in this test report refer only to the sample(s) tested and such sample(s) are retained for 30 days only.

Attention: To check the authenticity of testing/inspection report & certificate, please contact us at telephone: (86-755) 8307 1443, or email: CN.Doccheck@sgs.com

South of No. 6 Plant, No. 1, Runsheng Road, Suzhou Industrial Park, Suzhou Area, China (Jiangsu) Pilot Free Trade Zone 215000 t (86-512) 62992980 www.sgsgroup.com.cn
 中国·苏州·中国(江苏)自由贸易试验区苏州片区苏州工业园区润胜路1号的6号厂房南楼 邮编: 215000 t (86-512) 62992980 sgs.china@sgs.com

802.11n40_Channel 09

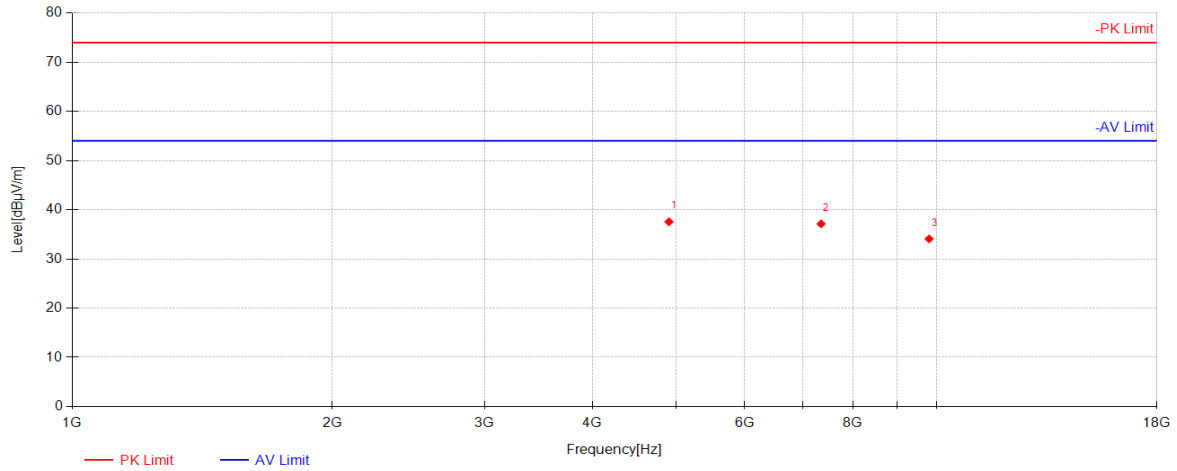

Data List								
NO.	Frequency [MHz]	Reading [dBµV]	AF [dB/m]	Factor [dB]	Level [dBµV/m]	Limit [dBµV/m]	Margin [dB]	Polarity
1	4904.0000	51.91	31.19	-45.53	37.56	74.00	36.44	Horizontal
2	7356.0000	44.50	36.20	-43.56	37.14	74.00	36.86	Horizontal
3	9808.0000	35.72	37.84	-39.47	34.09	74.00	39.91	Horizontal



Unless otherwise agreed in writing, this document is issued by the Company subject to its General Conditions of Service printed overleaf, available on request or accessible at <http://www.sgs.com/en/Terms-and-Conditions.aspx> and, for electronic format documents, subject to Terms and Conditions for Electronic Documents at <http://www.sgs.com/en/Terms-and-Conditions/Terms-e-Documents.aspx>. Attention is drawn to the limitation of liability, indemnification and jurisdiction issues defined therein. Any holder of this document is advised that information contained hereon reflects the Company's findings at the time of its intervention only and within the limits of Client's instructions, if any. The Company's sole responsibility is to its Client and this document does not exonerate parties to a transaction from exercising all their rights and obligations under the transaction documents. This document cannot be reproduced except in full, without prior written approval of the Company. Any unauthorized alteration, forgery or falsification of the content or appearance of this document is unlawful and offenders may be prosecuted to the fullest extent of the law. Unless otherwise stated the results shown in this test report refer only to the sample(s) tested and such sample(s) are retained for 30 days only.

Attention: To check the authenticity of testing/inspection report & certificate, please contact us at telephone: (86-755) 8307 1443, or email: CN.Doccheck@sgs.com

South of No. 6 Plant, No. 1, Runsheng Road, Suzhou Industrial Park, Suzhou Area, China (Jiangsu) Pilot Free Trade Zone 215000 t (86-512) 62992980 www.sgsgroup.com.cn
 中国·苏州·中国(江苏)自由贸易试验区苏州片区苏州工业园区润胜路1号的6号厂房南楼 邮编: 215000 t (86-512) 62992980 sgs.china@sgs.com

802.11n40_Channel 09

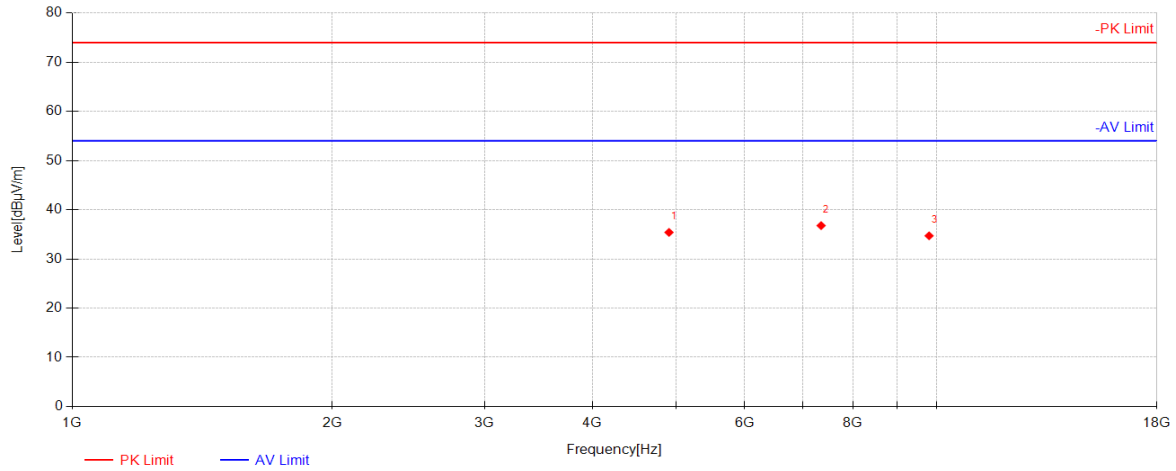

Data List								
NO.	Frequency [MHz]	Reading [dBµV]	AF [dB/m]	Factor [dB]	Level [dBµV/m]	Limit [dBµV/m]	Margin [dB]	Polarity
1	4904.0000	49.75	31.19	-45.53	35.40	74.00	38.60	Vertical
2	7356.0000	44.14	36.20	-43.56	36.78	74.00	37.22	Vertical
3	9808.0000	36.33	37.84	-39.47	34.70	74.00	39.30	Vertical

Remark:

- The field strength is calculated by adding the Antenna Factor, Cable Factor & Pre-amplifier gain. The basic equation with a sample calculation is as follows:
 $Level = Reading(dB\mu V) + AF(dB/m) + Factor(dB)$
 $AF = Antenna\ Factor(dB/m)$
 $Factor = Cable\ Factor(dB) - Pre-amplifier\ gain(dB)$
 $Margin = Limit(dB\mu V/m) - Level(dB\mu V/m)$
- All channels have been tested, but only the worst case data displayed in this report.
- Both peak and average measured complies with the limit line, so test result is "PASS"



Unless otherwise agreed in writing, this document is issued by the Company subject to its General Conditions of Service printed overleaf, available on request or accessible at <http://www.sgs.com/en/Terms-and-Conditions.aspx> and, for electronic format documents, subject to Terms and Conditions for Electronic Documents at <http://www.sgs.com/en/Terms-and-Conditions/Terms-e-Documents.aspx>. Attention is drawn to the limitation of liability, indemnification and jurisdiction issues defined therein. Any holder of this document is advised that information contained hereon reflects the Company's findings at the time of its intervention only and within the limits of Client's instructions, if any. The Company's sole responsibility is to its Client and this document does not exonerate parties to a transaction from exercising all their rights and obligations under the transaction documents. This document cannot be reproduced except in full, without prior written approval of the Company. Any unauthorized alteration, forgery or falsification of the content or appearance of this document is unlawful and offenders may be prosecuted to the fullest extent of the law. Unless otherwise stated the results shown in this test report refer only to the sample(s) tested and such sample(s) are retained for 30 days only.

Attention: To check the authenticity of testing/inspection report & certificate, please contact us at telephone: (86-755) 8307 1443, or email: CN.Doccheck@sgs.com
 South of No. 6 Plant, No. 1, Runsheng Road, Suzhou Industrial Park, Suzhou Area, China (Jiangsu) Pilot Free Trade Zone 215000 t (86-512) 62992980 www.sgs.com.cn
 中国·苏州·中国(江苏)自由贸易试验区苏州片区工业园区润胜路1号的6号厂房南楼 邮编: 215000 t (86-512) 62992980 sgs.china@sgs.com

Restricted bands around fundamental frequency

802.11b_Channel 01

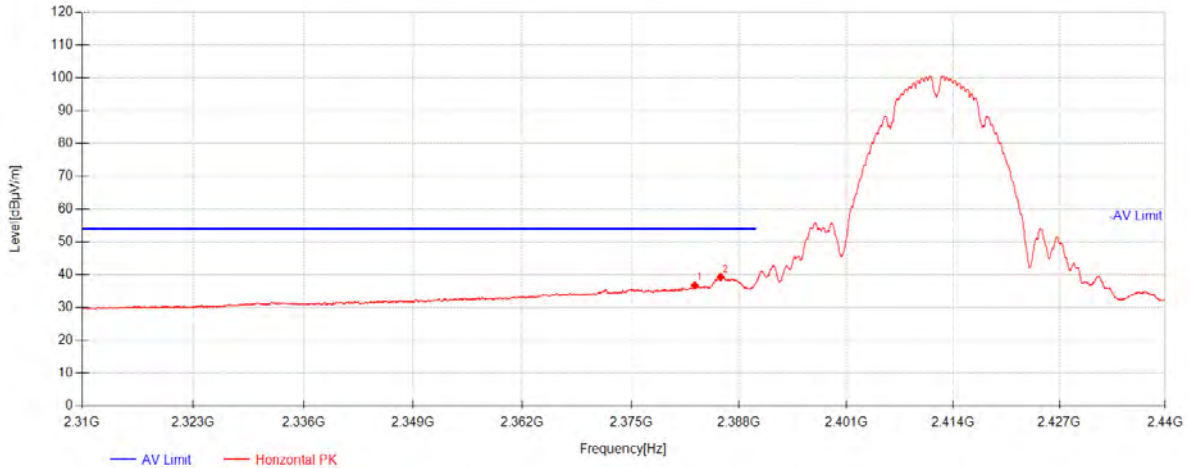

Data List								
NO.	Frequency [MHz]	Reading [dBµV]	AF [dB/m]	Factor [dB]	Level [dBµV/m]	Limit [dBµV/m]	Margin [dB]	Polarity
1	2382.67	33.34	26.97	-23.57	36.74	54.00	17.26	Horizontal
2	2385.79	35.88	26.98	-23.57	39.29	54.00	14.71	Horizontal



Unless otherwise agreed in writing, this document is issued by the Company subject to its General Conditions of Service printed overleaf, available on request or accessible at <http://www.sgs.com/en/Terms-and-Conditions.aspx> and, for electronic format documents, subject to Terms and Conditions for Electronic Documents at <http://www.sgs.com/en/Terms-and-Conditions/Terms-e-Documents.aspx>. Attention is drawn to the limitation of liability, indemnification and jurisdiction issues defined therein. Any holder of this document is advised that information contained hereon reflects the Company's findings at the time of its intervention only and within the limits of Client's instructions, if any. The Company's sole responsibility is to its Client and this document does not exonerate parties to a transaction from exercising all their rights and obligations under the transaction documents. This document cannot be reproduced except in full, without prior written approval of the Company. Any unauthorized alteration, forgery or falsification of the content or appearance of this document is unlawful and offenders may be prosecuted to the fullest extent of the law. Unless otherwise stated the results shown in this test report refer only to the sample(s) tested and such sample(s) are retained for 30 days only.

Attention: To check the authenticity of testing/inspection report & certificate, please contact us at telephone: (86-755) 8307 1443, or email: CN.Doccheck@sgs.com

South of No. 6 Plant, No. 1, Runsheng Road, Suzhou Industrial Park, Suzhou Area, China (Jiangsu) Pilot Free Trade Zone 215000 t (86-512) 62992980 www.sgs.com.cn
 中国·苏州·中国(江苏)自由贸易试验区苏州片区苏州工业园区润胜路1号的6号厂房南楼 邮编: 215000 t (86-512) 62992980 sgs.china@sgs.com

802.11b_Channel 01

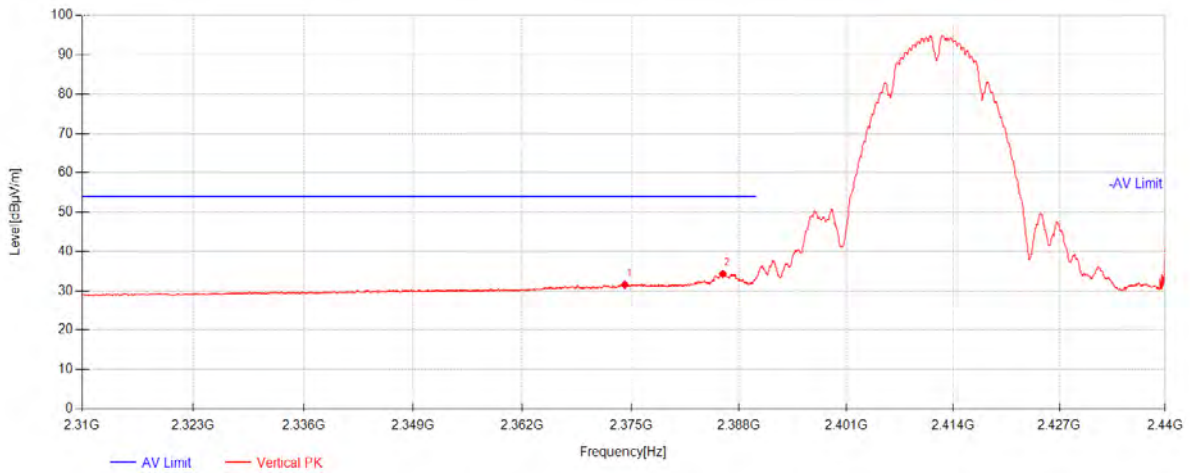

Data List								
NO.	Frequency [MHz]	Reading [dBµV]	AF [dB/m]	Factor [dB]	Level [dBµV/m]	Limit [dBµV/m]	Margin [dB]	Polarity
1	2374.2633	28.19	26.95	-23.57	31.57	54.00	22.43	Vertical
2	2386.05	30.88	26.98	-23.57	34.29	54.00	19.71	Vertical



Unless otherwise agreed in writing, this document is issued by the Company subject to its General Conditions of Service printed overleaf, available on request or accessible at <http://www.sgs.com/en/Terms-and-Conditions.aspx> and, for electronic format documents, subject to Terms and Conditions for Electronic Documents at <http://www.sgs.com/en/Terms-and-Conditions/Terms-e-Documents.aspx>. Attention is drawn to the limitation of liability, indemnification and jurisdiction issues defined therein. Any holder of this document is advised that information contained hereon reflects the Company's findings at the time of its intervention only and within the limits of Client's instructions, if any. The Company's sole responsibility is to its Client and this document does not exonerate parties to a transaction from exercising all their rights and obligations under the transaction documents. This document cannot be reproduced except in full, without prior written approval of the Company. Any unauthorized alteration, forgery or falsification of the content or appearance of this document is unlawful and offenders may be prosecuted to the fullest extent of the law. Unless otherwise stated the results shown in this test report refer only to the sample(s) tested and such sample(s) are retained for 30 days only.

Attention: To check the authenticity of testing/inspection report & certificate, please contact us at telephone: (86-755) 8307 1443, or email: CN.Doccheck@sgs.com

South of No. 6 Plant, No. 1, Runsheng Road, Suzhou Industrial Park, Suzhou Area, China (Jiangsu) Pilot Free Trade Zone 215000 t (86-512) 62992980 www.sgs.com.cn
 中国·苏州·中国(江苏)自由贸易试验区苏州片区苏州工业园区润胜路1号的6号厂房南楼 邮编: 215000 t (86-512) 62992980 sgs.china@sgs.com

802.11b_Channel 01

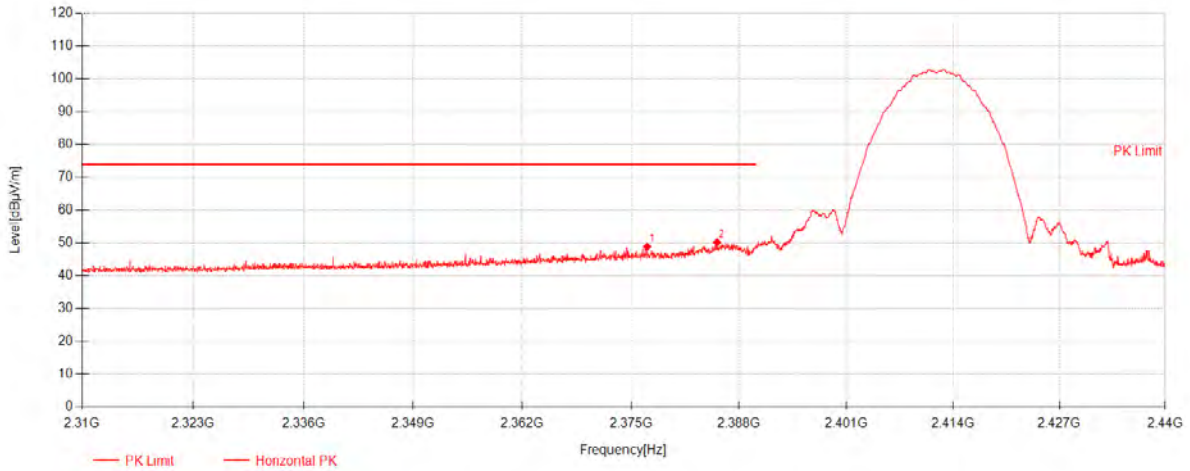

Data List								
NO.	Frequency [MHz]	Reading [dBµV]	AF [dB/m]	Factor [dB]	Level [dBµV/m]	Limit [dBµV/m]	Margin [dB]	Polarity
1	2376.95	45.46	26.96	-23.57	48.84	74.00	25.16	Horizontal
2	2385.3567	46.80	26.98	-23.57	50.21	74.00	23.79	Horizontal



Unless otherwise agreed in writing, this document is issued by the Company subject to its General Conditions of Service printed overleaf, available on request or accessible at <http://www.sgs.com/en/Terms-and-Conditions.aspx> and, for electronic format documents, subject to Terms and Conditions for Electronic Documents at <http://www.sgs.com/en/Terms-and-Conditions/Terms-e-Documents.aspx>. Attention is drawn to the limitation of liability, indemnification and jurisdiction issues defined therein. Any holder of this document is advised that information contained hereon reflects the Company's findings at the time of its intervention only and within the limits of Client's instructions, if any. The Company's sole responsibility is to its Client and this document does not exonerate parties to a transaction from exercising all their rights and obligations under the transaction documents. This document cannot be reproduced except in full, without prior written approval of the Company. Any unauthorized alteration, forgery or falsification of the content or appearance of this document is unlawful and offenders may be prosecuted to the fullest extent of the law. Unless otherwise stated the results shown in this test report refer only to the sample(s) tested and such sample(s) are retained for 30 days only.

Attention: To check the authenticity of testing/inspection report & certificate, please contact us at telephone: (86-755) 8307 1443, or email: CN.Doccheck@sgs.com

South of No. 6 Plant, No. 1, Runsheng Road, Suzhou Industrial Park, Suzhou Area, China (Jiangsu) Pilot Free Trade Zone 215000 t (86-512) 62992980 www.sgs.com.cn
 中国·苏州·中国(江苏)自由贸易试验区苏州片区苏州工业园区润胜路1号的6号厂房南楼 邮编: 215000 t (86-512) 62992980 sgs.china@sgs.com

802.11b_Channel 01

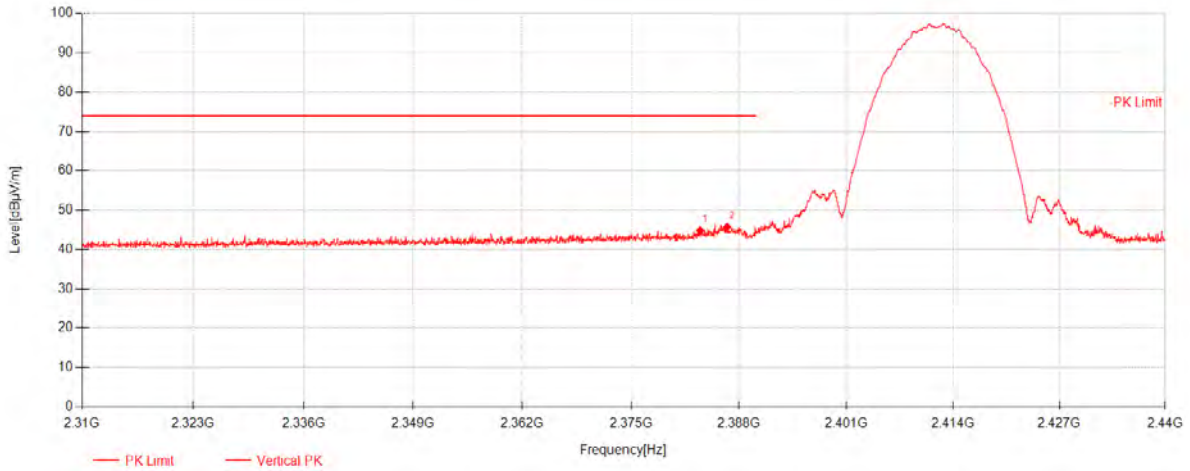

Data List								
NO.	Frequency [MHz]	Reading [dBµV]	AF [dB/m]	Factor [dB]	Level [dBµV/m]	Limit [dBµV/m]	Margin [dB]	Polarity
1	2383.32	41.37	26.97	-23.57	44.77	74.00	29.23	Vertical
2	2386.57	42.28	26.98	-23.57	45.69	74.00	28.31	Vertical



Unless otherwise agreed in writing, this document is issued by the Company subject to its General Conditions of Service printed overleaf, available on request or accessible at <http://www.sgs.com/en/Terms-and-Conditions.aspx> and, for electronic format documents, subject to Terms and Conditions for Electronic Documents at <http://www.sgs.com/en/Terms-and-Conditions/Terms-e-Documents.aspx>. Attention is drawn to the limitation of liability, indemnification and jurisdiction issues defined therein. Any holder of this document is advised that information contained hereon reflects the Company's findings at the time of its intervention only and within the limits of Client's instructions, if any. The Company's sole responsibility is to its Client and this document does not exonerate parties to a transaction from exercising all their rights and obligations under the transaction documents. This document cannot be reproduced except in full, without prior written approval of the Company. Any unauthorized alteration, forgery or falsification of the content or appearance of this document is unlawful and offenders may be prosecuted to the fullest extent of the law. Unless otherwise stated the results shown in this test report refer only to the sample(s) tested and such sample(s) are retained for 30 days only.

Attention: To check the authenticity of testing/inspection report & certificate, please contact us at telephone: (86-755) 8307 1443, or email: CN.Doccheck@sgs.com

South of No. 6 Plant, No. 1, Runsheng Road, Suzhou Industrial Park, Suzhou Area, China (Jiangsu) Pilot Free Trade Zone 215000 t (86-512) 62992980 www.sgs.com.cn
 中国·苏州·中国(江苏)自由贸易试验区苏州片区苏州工业园区润胜路1号的6号厂房南楼 邮编: 215000 t (86-512) 62992980 sgs.china@sgs.com

802.11b_Channel 11

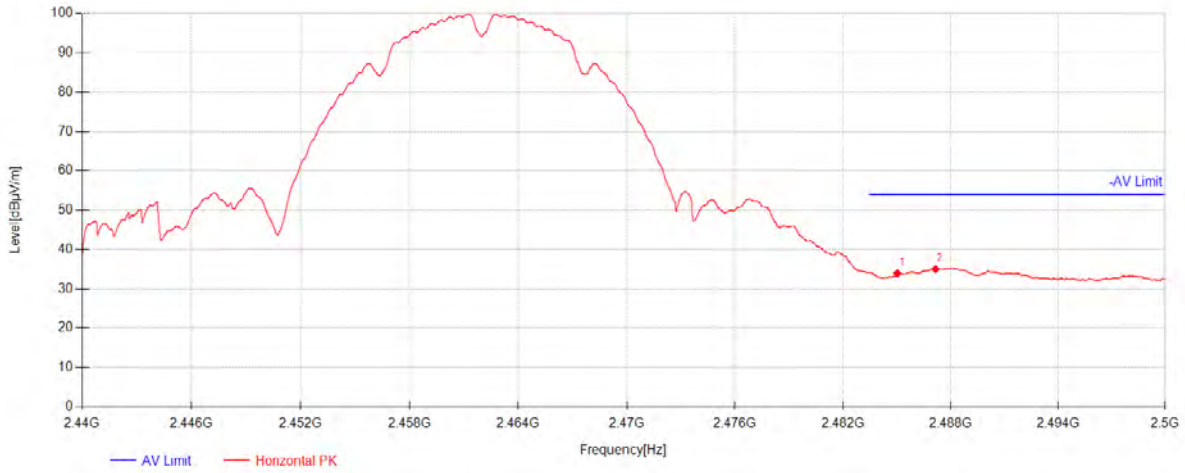

Data List								
NO.	Frequency [MHz]	Reading [dBµV]	AF [dB/m]	Factor [dB]	Level [dBµV/m]	Limit [dBµV/m]	Margin [dB]	Polarity
1	2485.03	30.20	27.26	-23.54	33.91	54.00	20.09	Horizontal
2	2487.16	31.30	27.26	-23.54	35.02	54.00	18.98	Horizontal



Unless otherwise agreed in writing, this document is issued by the Company subject to its General Conditions of Service printed overleaf, available on request or accessible at <http://www.sgs.com/en/Terms-and-Conditions.aspx> and, for electronic format documents, subject to Terms and Conditions for Electronic Documents at <http://www.sgs.com/en/Terms-and-Conditions/Terms-e-Documents.aspx>. Attention is drawn to the limitation of liability, indemnification and jurisdiction issues defined therein. Any holder of this document is advised that information contained hereon reflects the Company's findings at the time of its intervention only and within the limits of Client's instructions, if any. The Company's sole responsibility is to its Client and this document does not exonerate parties to a transaction from exercising all their rights and obligations under the transaction documents. This document cannot be reproduced except in full, without prior written approval of the Company. Any unauthorized alteration, forgery or falsification of the content or appearance of this document is unlawful and offenders may be prosecuted to the fullest extent of the law. Unless otherwise stated the results shown in this test report refer only to the sample(s) tested and such sample(s) are retained for 30 days only.

Attention: To check the authenticity of testing/inspection report & certificate, please contact us at telephone: (86-755) 8307 1443, or email: CN.Doccheck@sgs.com

South of No. 6 Plant, No. 1, Runsheng Road, Suzhou Industrial Park, Suzhou Area, China (Jiangsu) Pilot Free Trade Zone 215000 t (86-512) 62992980 www.sgsgroup.com.cn
 中国·苏州·中国(江苏)自由贸易试验区苏州片区苏州工业园区润胜路1号的6号厂房南楼 邮编: 215000 t (86-512) 62992980 sgs.china@sgs.com

802.11b_Channel 11

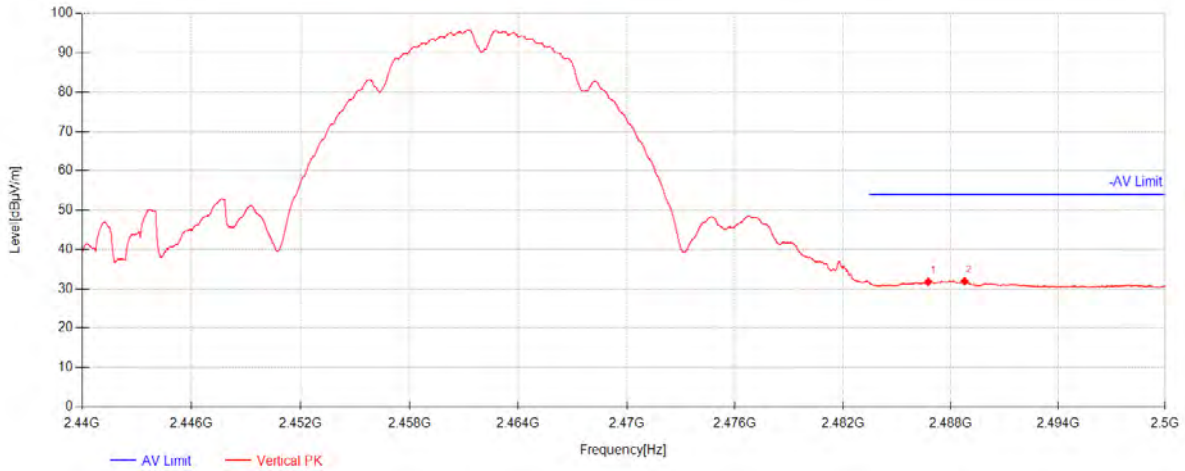

Data List								
NO.	Frequency [MHz]	Reading [dBµV]	AF [dB/m]	Factor [dB]	Level [dBµV/m]	Limit [dBµV/m]	Margin [dB]	Polarity
1	2486.755	28.05	27.26	-23.54	31.77	54.00	22.23	Vertical
2	2488.78	28.20	27.27	-23.54	31.93	54.00	22.07	Vertical



Unless otherwise agreed in writing, this document is issued by the Company subject to its General Conditions of Service printed overleaf, available on request or accessible at <http://www.sgs.com/en/Terms-and-Conditions.aspx> and, for electronic format documents, subject to Terms and Conditions for Electronic Documents at <http://www.sgs.com/en/Terms-and-Conditions/Terms-e-Documents.aspx>. Attention is drawn to the limitation of liability, indemnification and jurisdiction issues defined therein. Any holder of this document is advised that information contained hereon reflects the Company's findings at the time of its intervention only and within the limits of Client's instructions, if any. The Company's sole responsibility is to its Client and this document does not exonerate parties to a transaction from exercising all their rights and obligations under the transaction documents. This document cannot be reproduced except in full, without prior written approval of the Company. Any unauthorized alteration, forgery or falsification of the content or appearance of this document is unlawful and offenders may be prosecuted to the fullest extent of the law. Unless otherwise stated the results shown in this test report refer only to the sample(s) tested and such sample(s) are retained for 30 days only.

Attention: To check the authenticity of testing/inspection report & certificate, please contact us at telephone: (86-755) 8307 1443, or email: CN.Doccheck@sgs.com
 South of No. 6 Plant, No. 1, Runsheng Road, Suzhou Industrial Park, Suzhou Area, China (Jiangsu) Pilot Free Trade Zone 215000 t (86-512) 62992980 www.sgsgroup.com.cn
 中国·苏州·中国(江苏)自由贸易试验区苏州片区苏州工业园区润胜路1号的6号厂房南楼 邮编: 215000 t (86-512) 62992980 sgs.china@sgs.com

802.11b_Channel 11

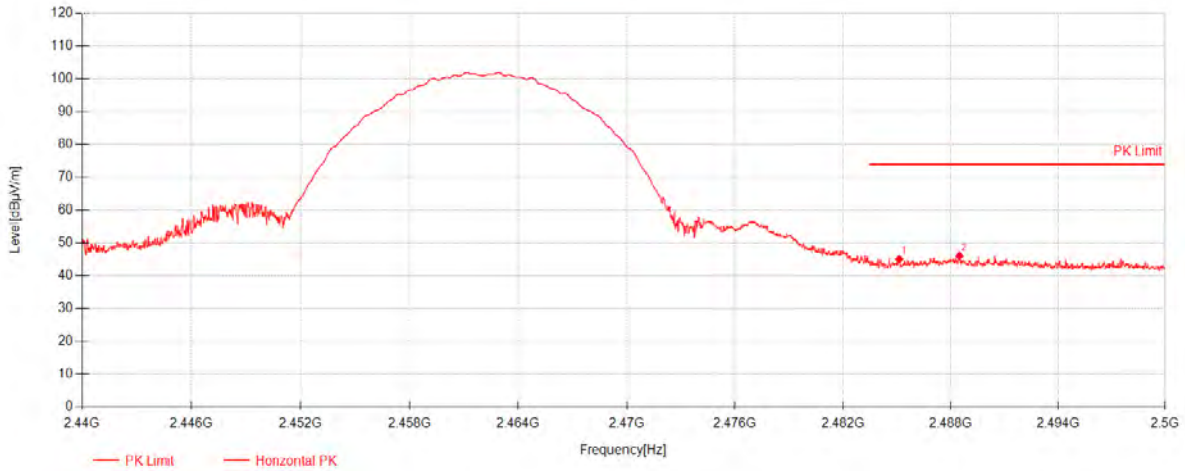

Data List								
NO.	Frequency [MHz]	Reading [dBµV]	AF [dB/m]	Factor [dB]	Level [dBµV/m]	Limit [dBµV/m]	Margin [dB]	Polarity
1	2485.135	41.37	27.26	-23.54	45.08	74.00	28.92	Horizontal
2	2488.495	42.32	27.27	-23.54	46.04	74.00	27.96	Horizontal



Unless otherwise agreed in writing, this document is issued by the Company subject to its General Conditions of Service printed overleaf, available on request or accessible at <http://www.sgs.com/en/Terms-and-Conditions.aspx> and, for electronic format documents, subject to Terms and Conditions for Electronic Documents at <http://www.sgs.com/en/Terms-and-Conditions/Terms-e-Documents.aspx>. Attention is drawn to the limitation of liability, indemnification and jurisdiction issues defined therein. Any holder of this document is advised that information contained hereon reflects the Company's findings at the time of its intervention only and within the limits of Client's instructions, if any. The Company's sole responsibility is to its Client and this document does not exonerate parties to a transaction from exercising all their rights and obligations under the transaction documents. This document cannot be reproduced except in full, without prior written approval of the Company. Any unauthorized alteration, forgery or falsification of the content or appearance of this document is unlawful and offenders may be prosecuted to the fullest extent of the law. Unless otherwise stated the results shown in this test report refer only to the sample(s) tested and such sample(s) are retained for 30 days only.

Attention: To check the authenticity of testing/inspection report & certificate, please contact us at telephone: (86-755) 8307 1443, or email: CN.Doccheck@sgs.com

South of No. 6 Plant, No. 1, Runsheng Road, Suzhou Industrial Park, Suzhou Area, China (Jiangsu) Pilot Free Trade Zone 215000 t (86-512) 62992980 www.sgsgroup.com.cn
 中国·苏州·中国(江苏)自由贸易试验区苏州片区苏州工业园区润胜路1号的6号厂房南楼 邮编: 215000 t (86-512) 62992980 sgs.china@sgs.com

802.11b_Channel 11

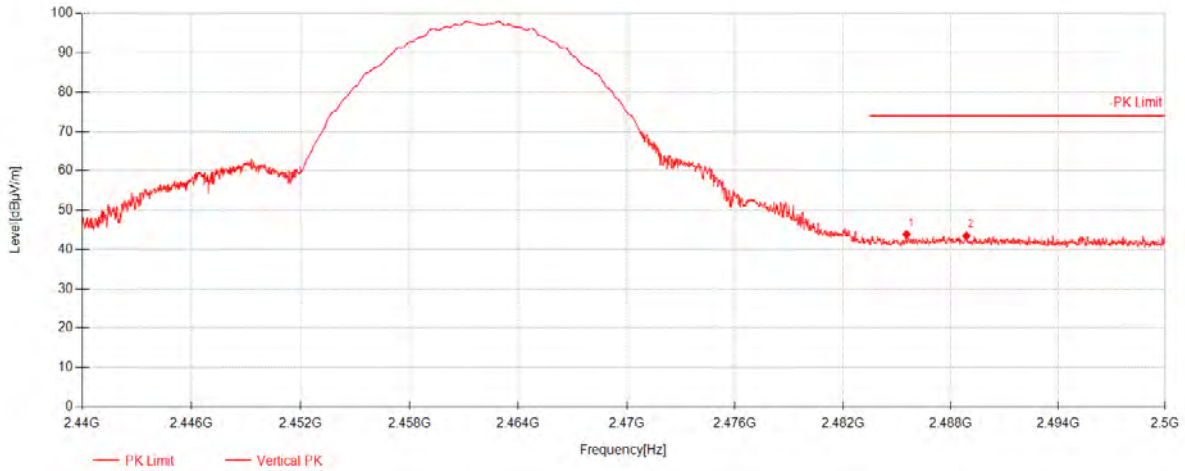

Data List								
NO.	Frequency [MHz]	Reading [dBµV]	AF [dB/m]	Factor [dB]	Level [dBµV/m]	Limit [dBµV/m]	Margin [dB]	Polarity
1	2485.54	40.16	27.26	-23.54	43.88	74.00	30.12	Vertical
2	2488.885	39.75	27.27	-23.54	43.48	74.00	30.52	Vertical



Unless otherwise agreed in writing, this document is issued by the Company subject to its General Conditions of Service printed overleaf, available on request or accessible at <http://www.sgs.com/en/Terms-and-Conditions.aspx> and, for electronic format documents, subject to Terms and Conditions for Electronic Documents at <http://www.sgs.com/en/Terms-and-Conditions/Terms-e-Documents.aspx>. Attention is drawn to the limitation of liability, indemnification and jurisdiction issues defined therein. Any holder of this document is advised that information contained hereon reflects the Company's findings at the time of its intervention only and within the limits of Client's instructions, if any. The Company's sole responsibility is to its Client and this document does not exonerate parties to a transaction from exercising all their rights and obligations under the transaction documents. This document cannot be reproduced except in full, without prior written approval of the Company. Any unauthorized alteration, forgery or falsification of the content or appearance of this document is unlawful and offenders may be prosecuted to the fullest extent of the law. Unless otherwise stated the results shown in this test report refer only to the sample(s) tested and such sample(s) are retained for 30 days only.

Attention: To check the authenticity of testing/inspection report & certificate, please contact us at telephone: (86-755) 8307 1443, or email: CN.Doccheck@sgs.com

South of No. 6 Plant, No. 1, Runsheng Road, Suzhou Industrial Park, Suzhou Area, China (Jiangsu) Pilot Free Trade Zone 215000 t (86-512) 62992980 www.sgs.com.cn
 中国·苏州·中国(江苏)自由贸易试验区苏州片区苏州工业园区润胜路1号的6号厂房南楼 邮编: 215000 t (86-512) 62992980 sgs.china@sgs.com

802.11g_Channel 01

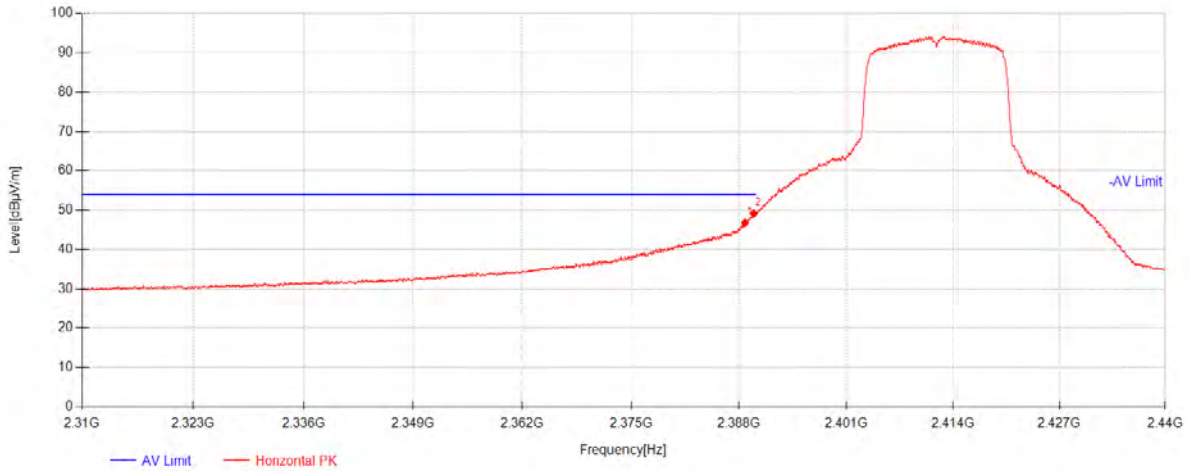

Data List								
NO.	Frequency [MHz]	Reading [dBµV]	AF [dB/m]	Factor [dB]	Level [dBµV/m]	Limit [dBµV/m]	Margin [dB]	Polarity
1	2388.7367	43.31	26.99	-23.57	46.73	54.00	7.27	Horizontal
2	2389.7767	45.72	26.99	-23.57	49.14	54.00	4.86	Horizontal



Unless otherwise agreed in writing, this document is issued by the Company subject to its General Conditions of Service printed overleaf, available on request or accessible at <http://www.sgs.com/en/Terms-and-Conditions.aspx> and, for electronic format documents, subject to Terms and Conditions for Electronic Documents at <http://www.sgs.com/en/Terms-and-Conditions/Terms-e-Documents.aspx>. Attention is drawn to the limitation of liability, indemnification and jurisdiction issues defined therein. Any holder of this document is advised that information contained hereon reflects the Company's findings at the time of its intervention only and within the limits of Client's instructions, if any. The Company's sole responsibility is to its Client and this document does not exonerate parties to a transaction from exercising all their rights and obligations under the transaction documents. This document cannot be reproduced except in full, without prior written approval of the Company. Any unauthorized alteration, forgery or falsification of the content or appearance of this document is unlawful and offenders may be prosecuted to the fullest extent of the law. Unless otherwise stated the results shown in this test report refer only to the sample(s) tested and such sample(s) are retained for 30 days only.

Attention: To check the authenticity of testing/inspection report & certificate, please contact us at telephone: (86-755) 8307 1443, or email: CN.Doccheck@sgs.com

South of No. 6 Plant, No. 1, Runsheng Road, Suzhou Industrial Park, Suzhou Area, China (Jiangsu) Pilot Free Trade Zone 215000 t (86-512) 62992980 www.sgsgroup.com.cn
 中国·苏州·中国(江苏)自由贸易试验区苏州片区苏州工业园区润胜路1号的6号厂房南楼 邮编: 215000 t (86-512) 62992980 sgs.china@sgs.com

802.11g_Channel 01

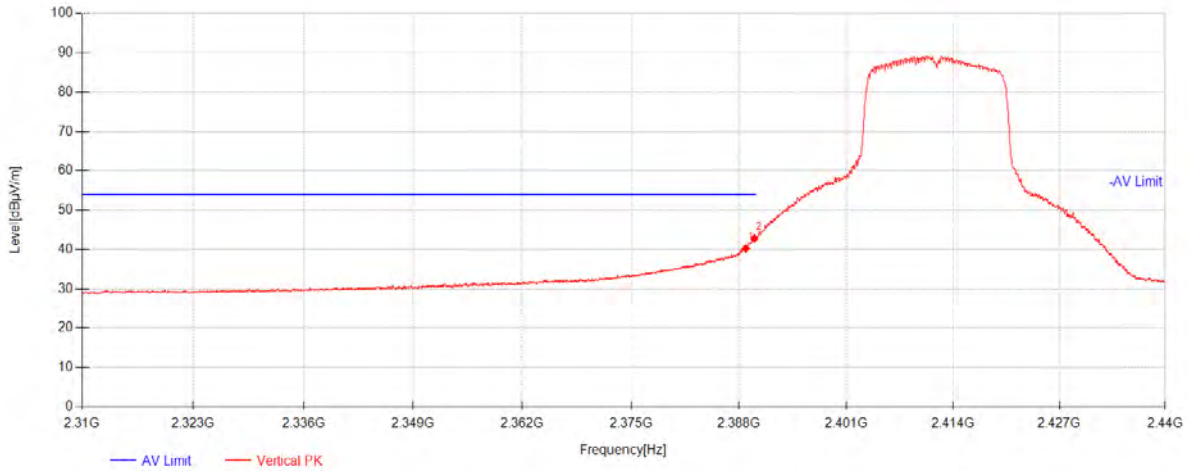

Data List								
NO.	Frequency [MHz]	Reading [dBµV]	AF [dB/m]	Factor [dB]	Level [dBµV/m]	Limit [dBµV/m]	Margin [dB]	Polarity
1	2388.8233	36.85	26.99	-23.57	40.27	54.00	13.73	Vertical
2	2389.8633	39.43	26.99	-23.57	42.85	54.00	11.15	Vertical



Unless otherwise agreed in writing, this document is issued by the Company subject to its General Conditions of Service printed overleaf, available on request or accessible at <http://www.sgs.com/en/Terms-and-Conditions.aspx> and, for electronic format documents, subject to Terms and Conditions for Electronic Documents at <http://www.sgs.com/en/Terms-and-Conditions/Terms-e-Documents.aspx>. Attention is drawn to the limitation of liability, indemnification and jurisdiction issues defined therein. Any holder of this document is advised that information contained hereon reflects the Company's findings at the time of its intervention only and within the limits of Client's instructions, if any. The Company's sole responsibility is to its Client and this document does not exonerate parties to a transaction from exercising all their rights and obligations under the transaction documents. This document cannot be reproduced except in full, without prior written approval of the Company. Any unauthorized alteration, forgery or falsification of the content or appearance of this document is unlawful and offenders may be prosecuted to the fullest extent of the law. Unless otherwise stated the results shown in this test report refer only to the sample(s) tested and such sample(s) are retained for 30 days.

Attention: To check the authenticity of testing/inspection report & certificate, please contact us at telephone: (86-755) 8307 1443, or email: CN.Doccheck@sgs.com

South of No. 6 Plant, No. 1, Runsheng Road, Suzhou Industrial Park, Suzhou Area, China (Jiangsu) Pilot Free Trade Zone 215000 t (86-512) 62992980 www.sgsgroup.com.cn
 中国·苏州·中国(江苏)自由贸易试验区苏州片区苏州工业园区润胜路1号的6号厂房南楼 邮编: 215000 t (86-512) 62992980 sgs.china@sgs.com

802.11g_Channel 01

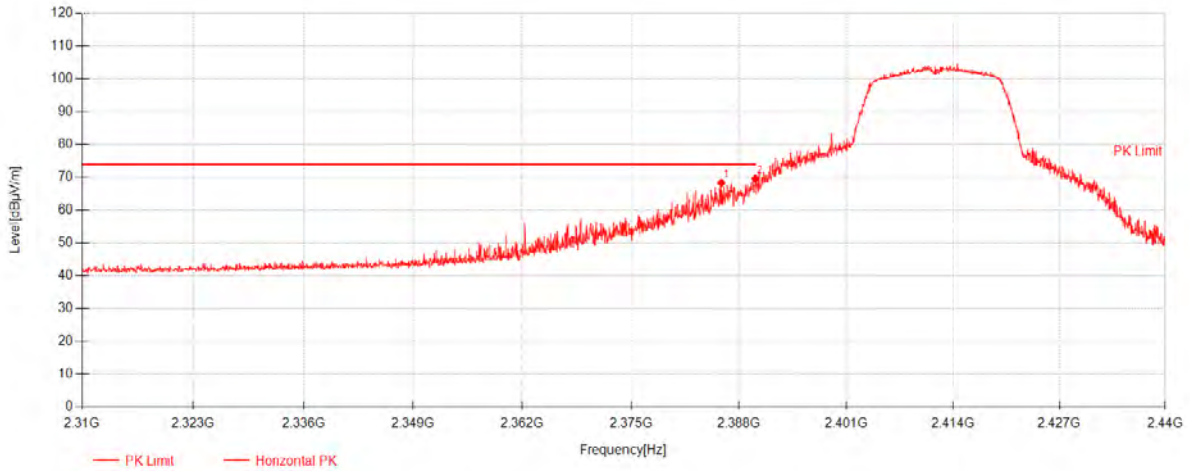

Data List								
NO.	Frequency [MHz]	Reading [dBµV]	AF [dB/m]	Factor [dB]	Level [dBµV/m]	Limit [dBµV/m]	Margin [dB]	Polarity
1	2385.8767	64.92	26.98	-23.57	68.33	74.00	5.67	Horizontal
2	2389.9933	66.19	26.99	-23.57	69.61	74.00	4.39	Horizontal



Unless otherwise agreed in writing, this document is issued by the Company subject to its General Conditions of Service printed overleaf, available on request or accessible at <http://www.sgs.com/en/Terms-and-Conditions.aspx> and, for electronic format documents, subject to Terms and Conditions for Electronic Documents at <http://www.sgs.com/en/Terms-and-Conditions/Terms-e-Documents.aspx>. Attention is drawn to the limitation of liability, indemnification and jurisdiction issues defined therein. Any holder of this document is advised that information contained hereon reflects the Company's findings at the time of its intervention only and within the limits of Client's instructions, if any. The Company's sole responsibility is to its Client and this document does not exonerate parties to a transaction from exercising all their rights and obligations under the transaction documents. This document cannot be reproduced except in full, without prior written approval of the Company. Any unauthorized alteration, forgery or falsification of the content or appearance of this document is unlawful and offenders may be prosecuted to the fullest extent of the law. Unless otherwise stated the results shown in this test report refer only to the sample(s) tested and such sample(s) are retained for 30 days only.

Attention: To check the authenticity of testing/inspection report & certificate, please contact us at telephone: (86-755) 8307 1443, or email: CN.Doccheck@sgs.com

South of No. 6 Plant, No. 1, Runsheng Road, Suzhou Industrial Park, Suzhou Area, China (Jiangsu) Pilot Free Trade Zone 215000 t (86-512) 62992980 www.sgsgroup.com.cn
 中国·苏州·中国(江苏)自由贸易试验区苏州片区苏州工业园区润胜路1号的6号厂房南楼 邮编: 215000 t (86-512) 62992980 sgs.china@sgs.com

802.11g_Channel 01

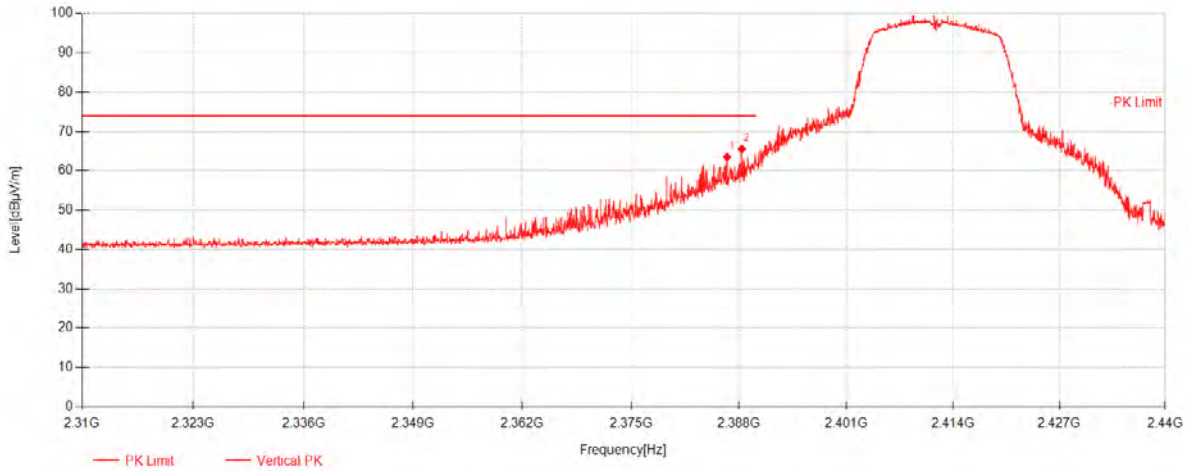

Data List								
NO.	Frequency [MHz]	Reading [dBµV]	AF [dB/m]	Factor [dB]	Level [dBµV/m]	Limit [dBµV/m]	Margin [dB]	Polarity
1	2386.57	60.12	26.98	-23.57	63.53	74.00	10.47	Vertical
2	2388.3467	62.12	26.99	-23.57	65.54	74.00	8.46	Vertical



Unless otherwise agreed in writing, this document is issued by the Company subject to its General Conditions of Service printed overleaf, available on request or accessible at <http://www.sgs.com/en/Terms-and-Conditions.aspx> and, for electronic format documents, subject to Terms and Conditions for Electronic Documents at <http://www.sgs.com/en/Terms-and-Conditions/Terms-e-Documents.aspx>. Attention is drawn to the limitation of liability, indemnification and jurisdiction issues defined therein. Any holder of this document is advised that information contained hereon reflects the Company's findings at the time of its intervention only and within the limits of Client's instructions, if any. The Company's sole responsibility is to its Client and this document does not exonerate parties to a transaction from exercising all their rights and obligations under the transaction documents. This document cannot be reproduced except in full, without prior written approval of the Company. Any unauthorized alteration, forgery or falsification of the content or appearance of this document is unlawful and offenders may be prosecuted to the fullest extent of the law. Unless otherwise stated the results shown in this test report refer only to the sample(s) tested and such sample(s) are retained for 30 days.

Attention: To check the authenticity of testing/inspection report & certificate, please contact us at telephone: (86-755) 8307 1443, or email: CN.Doccheck@sgs.com

South of No. 6 Plant, No. 1, Runsheng Road, Suzhou Industrial Park, Suzhou Area, China (Jiangsu) Pilot Free Trade Zone 215000 t (86-512) 62992980 www.sgs.com.cn
 中国·苏州·中国(江苏)自由贸易试验区苏州片区苏州工业园区润胜路1号的6号厂房南楼 邮编: 215000 t (86-512) 62992980 sgs.china@sgs.com

802.11g_Channel 11

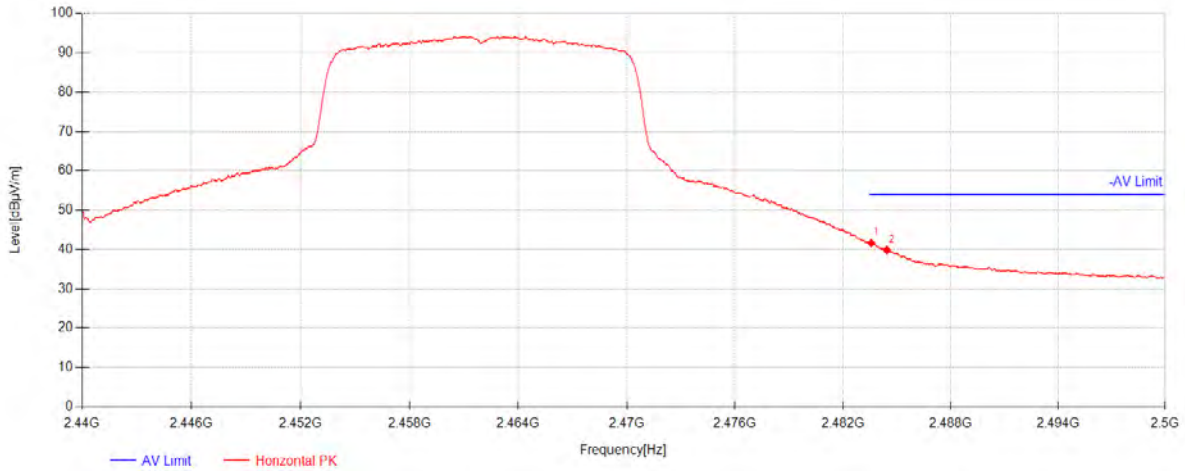

Data List								
NO.	Frequency [MHz]	Reading [dBµV]	AF [dB/m]	Factor [dB]	Level [dBµV/m]	Limit [dBµV/m]	Margin [dB]	Polarity
1	2483.575	37.95	27.25	-23.54	41.66	54.00	12.34	Horizontal
2	2484.445	36.12	27.26	-23.54	39.83	54.00	14.17	Horizontal



Unless otherwise agreed in writing, this document is issued by the Company subject to its General Conditions of Service printed overleaf, available on request or accessible at <http://www.sgs.com/en/Terms-and-Conditions.aspx> and, for electronic format documents, subject to Terms and Conditions for Electronic Documents at <http://www.sgs.com/en/Terms-and-Conditions/Terms-e-Documents.aspx>. Attention is drawn to the limitation of liability, indemnification and jurisdiction issues defined therein. Any holder of this document is advised that information contained hereon reflects the Company's findings at the time of its intervention only and within the limits of Client's instructions, if any. The Company's sole responsibility is to its Client and this document does not exonerate parties to a transaction from exercising all their rights and obligations under the transaction documents. This document cannot be reproduced except in full, without prior written approval of the Company. Any unauthorized alteration, forgery or falsification of the content or appearance of this document is unlawful and offenders may be prosecuted to the fullest extent of the law. Unless otherwise stated the results shown in this test report refer only to the sample(s) tested and such sample(s) are retained for 30 days only.

Attention: To check the authenticity of testing/inspection report & certificate, please contact us at telephone: (86-755) 8307 1443, or email: CN.Doccheck@sgs.com

South of No. 6 Plant, No. 1, Runsheng Road, Suzhou Industrial Park, Suzhou Area, China (Jiangsu) Pilot Free Trade Zone 215000 t (86-512) 62992980 www.sgs.com.cn
 中国·苏州·中国(江苏)自由贸易试验区苏州片区苏州工业园区润胜路1号的6号厂房南楼 邮编: 215000 t (86-512) 62992980 sgs.china@sgs.com

802.11g_Channel 11

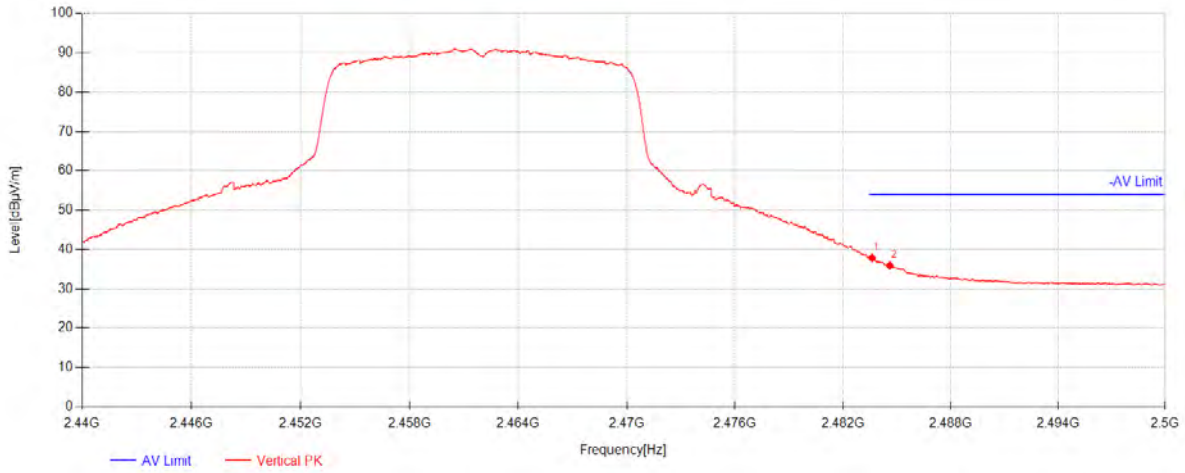

Data List								
NO.	Frequency [MHz]	Reading [dBµV]	AF [dB/m]	Factor [dB]	Level [dBµV/m]	Limit [dBµV/m]	Margin [dB]	Polarity
1	2483.62	34.17	27.25	-23.54	37.88	54.00	16.12	Vertical
2	2484.61	32.24	27.26	-23.54	35.95	54.00	18.05	Vertical



Unless otherwise agreed in writing, this document is issued by the Company subject to its General Conditions of Service printed overleaf, available on request or accessible at <http://www.sgs.com/en/Terms-and-Conditions.aspx> and, for electronic format documents, subject to Terms and Conditions for Electronic Documents at <http://www.sgs.com/en/Terms-and-Conditions/Terms-e-Documents.aspx>. Attention is drawn to the limitation of liability, indemnification and jurisdiction issues defined therein. Any holder of this document is advised that information contained hereon reflects the Company's findings at the time of its intervention only and within the limits of Client's instructions, if any. The Company's sole responsibility is to its Client and this document does not exonerate parties to a transaction from exercising all their rights and obligations under the transaction documents. This document cannot be reproduced except in full, without prior written approval of the Company. Any unauthorized alteration, forgery or falsification of the content or appearance of this document is unlawful and offenders may be prosecuted to the fullest extent of the law. Unless otherwise stated the results shown in this test report refer only to the sample(s) tested and such sample(s) are retained for 30 days only.

Attention: To check the authenticity of testing/inspection report & certificate, please contact us at telephone: (86-755) 8307 1443, or email: CN.Doccheck@sgs.com

South of No. 6 Plant, No. 1, Runsheng Road, Suzhou Industrial Park, Suzhou Area, China (Jiangsu) Pilot Free Trade Zone 215000 t (86-512) 62992980 www.sgsgroup.com.cn
 中国·苏州·中国(江苏)自由贸易试验区苏州片区苏州工业园区润胜路1号的6号厂房南楼 邮编: 215000 t (86-512) 62992980 sgs.china@sgs.com

802.11g_Channel 11

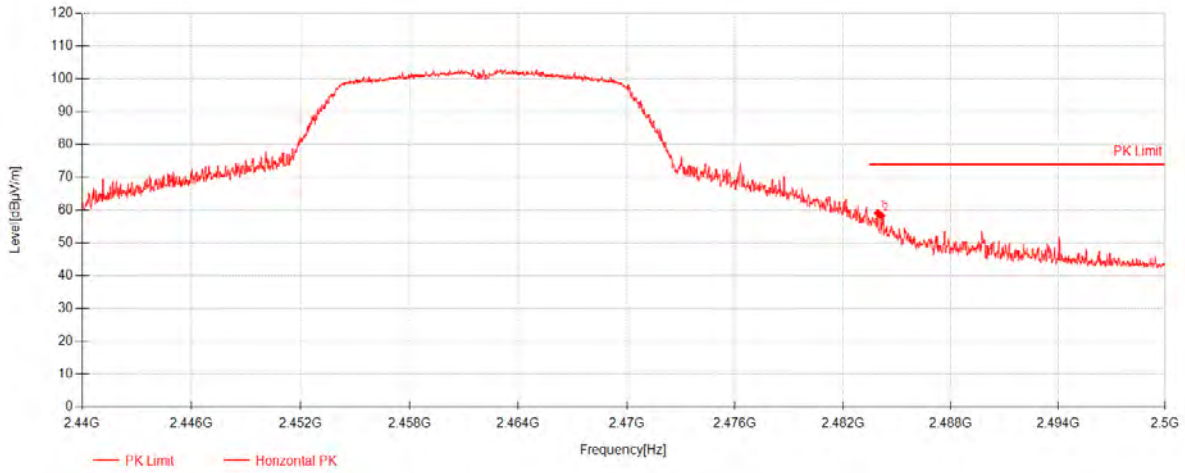

Data List								
NO.	Frequency [MHz]	Reading [dBµV]	AF [dB/m]	Factor [dB]	Level [dBµV/m]	Limit [dBµV/m]	Margin [dB]	Polarity
1	2483.95	55.40	27.26	-23.54	59.11	74.00	14.89	Horizontal
2	2484.13	54.64	27.26	-23.54	58.35	74.00	15.65	Horizontal



Unless otherwise agreed in writing, this document is issued by the Company subject to its General Conditions of Service printed overleaf, available on request or accessible at <http://www.sgs.com/en/Terms-and-Conditions.aspx> and, for electronic format documents, subject to Terms and Conditions for Electronic Documents at <http://www.sgs.com/en/Terms-and-Conditions/Terms-e-Documents.aspx>. Attention is drawn to the limitation of liability, indemnification and jurisdiction issues defined therein. Any holder of this document is advised that information contained hereon reflects the Company's findings at the time of its intervention only and within the limits of Client's instructions, if any. The Company's sole responsibility is to its Client and this document does not exonerate parties to a transaction from exercising all their rights and obligations under the transaction documents. This document cannot be reproduced except in full, without prior written approval of the Company. Any unauthorized alteration, forgery or falsification of the content or appearance of this document is unlawful and offenders may be prosecuted to the fullest extent of the law. Unless otherwise stated the results shown in this test report refer only to the sample(s) tested and such sample(s) are retained for 30 days only.

Attention: To check the authenticity of testing/inspection report & certificate, please contact us at telephone: (86-755) 8307 1443, or email: CN.Doccheck@sgs.com

South of No. 6 Plant, No. 1, Runsheng Road, Suzhou Industrial Park, Suzhou Area, China (Jiangsu) Pilot Free Trade Zone 215000 t (86-512) 62992980 www.sgs.com.cn
 中国·苏州·中国(江苏)自由贸易试验区苏州片区苏州工业园区润胜路1号的6号厂房南楼 邮编: 215000 t (86-512) 62992980 sgs.china@sgs.com

802.11g_Channel 11

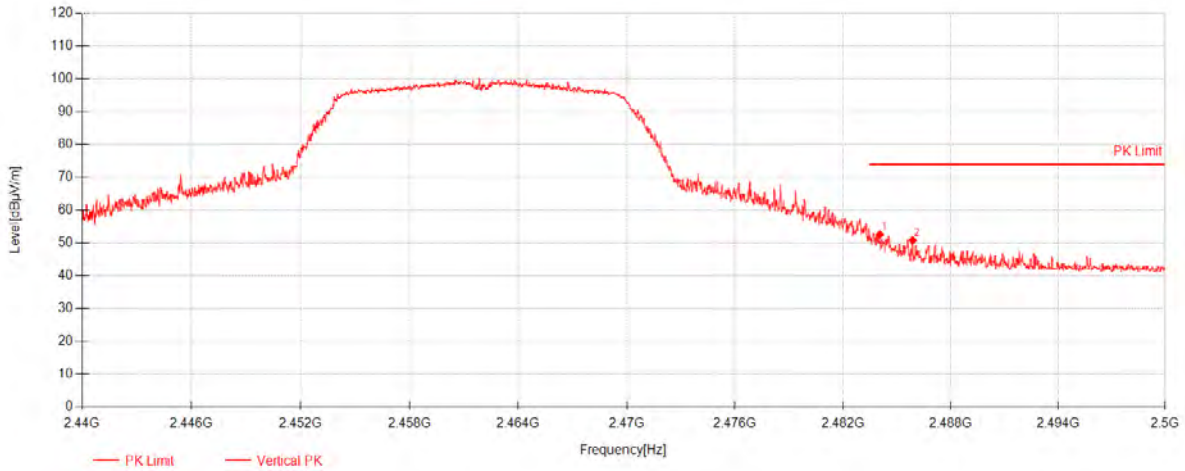

Data List								
NO.	Frequency [MHz]	Reading [dBµV]	AF [dB/m]	Factor [dB]	Level [dBµV/m]	Limit [dBµV/m]	Margin [dB]	Polarity
1	2484.055	48.90	27.26	-23.54	52.61	74.00	21.39	Vertical
2	2485.885	47.10	27.26	-23.54	50.82	74.00	23.18	Vertical



Unless otherwise agreed in writing, this document is issued by the Company subject to its General Conditions of Service printed overleaf, available on request or accessible at <http://www.sgs.com/en/Terms-and-Conditions.aspx> and, for electronic format documents, subject to Terms and Conditions for Electronic Documents at <http://www.sgs.com/en/Terms-and-Conditions/Terms-e-Documents.aspx>. Attention is drawn to the limitation of liability, indemnification and jurisdiction issues defined therein. Any holder of this document is advised that information contained hereon reflects the Company's findings at the time of its intervention only and within the limits of Client's instructions, if any. The Company's sole responsibility is to its Client and this document does not exonerate parties to a transaction from exercising all their rights and obligations under the transaction documents. This document cannot be reproduced except in full, without prior written approval of the Company. Any unauthorized alteration, forgery or falsification of the content or appearance of this document is unlawful and offenders may be prosecuted to the fullest extent of the law. Unless otherwise stated the results shown in this test report refer only to the sample(s) tested and such sample(s) are retained for 30 days only.

Attention: To check the authenticity of testing/inspection report & certificate, please contact us at telephone: (86-755) 8307 1443, or email: CN.Doccheck@sgs.com

South of No. 6 Plant, No. 1, Runsheng Road, Suzhou Industrial Park, Suzhou Area, China (Jiangsu) Pilot Free Trade Zone 215000 t (86-512) 62992980 www.sgsgroup.com.cn
 中国·苏州·中国(江苏)自由贸易试验区苏州片区苏州工业园区润胜路1号的6号厂房南楼 邮编: 215000 t (86-512) 62992980 sgs.china@sgs.com

802.11n20_Channel 01

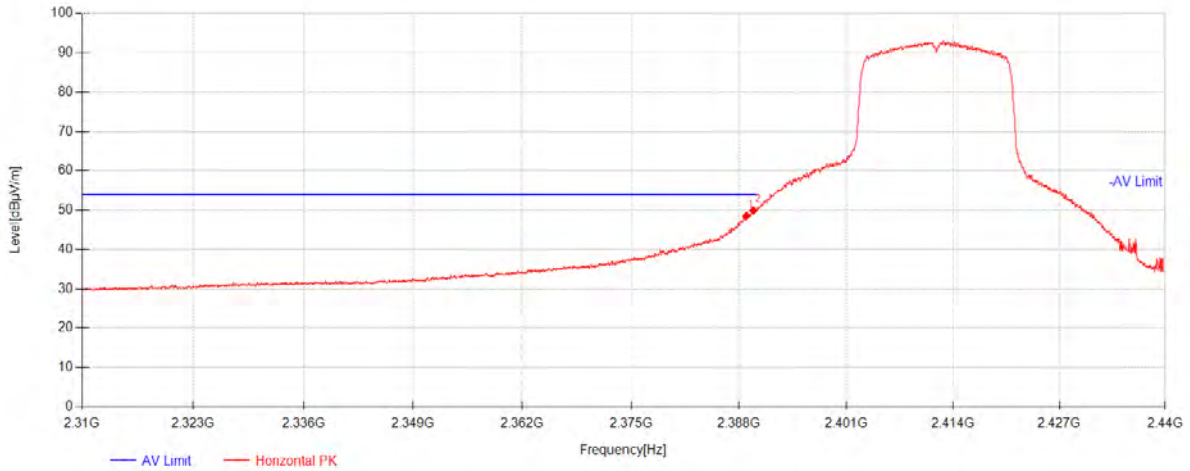

Data List								
NO.	Frequency [MHz]	Reading [dBµV]	AF [dB/m]	Factor [dB]	Level [dBµV/m]	Limit [dBµV/m]	Margin [dB]	Polarity
1	2388.91	45.14	26.99	-23.57	48.56	54.00	5.44	Horizontal
2	2389.7333	46.50	26.99	-23.57	49.92	54.00	4.08	Horizontal



Unless otherwise agreed in writing, this document is issued by the Company subject to its General Conditions of Service printed overleaf, available on request or accessible at <http://www.sgs.com/en/Terms-and-Conditions.aspx> and, for electronic format documents, subject to Terms and Conditions for Electronic Documents at <http://www.sgs.com/en/Terms-and-Conditions/Terms-e-Documents.aspx>. Attention is drawn to the limitation of liability, indemnification and jurisdiction issues defined therein. Any holder of this document is advised that information contained hereon reflects the Company's findings at the time of its intervention only and within the limits of Client's instructions, if any. The Company's sole responsibility is to its Client and this document does not exonerate parties to a transaction from exercising all their rights and obligations under the transaction documents. This document cannot be reproduced except in full, without prior written approval of the Company. Any unauthorized alteration, forgery or falsification of the content or appearance of this document is unlawful and offenders may be prosecuted to the fullest extent of the law. Unless otherwise stated the results shown in this test report refer only to the sample(s) tested and such sample(s) are retained for 30 days only.

Attention: To check the authenticity of testing/inspection report & certificate, please contact us at telephone: (86-755) 8307 1443, or email: CN.Doccheck@sgs.com

South of No. 6 Plant, No. 1, Runsheng Road, Suzhou Industrial Park, Suzhou Area, China (Jiangsu) Pilot Free Trade Zone 215000 t (86-512) 62992980 www.sgs.com.cn
 中国·苏州·中国(江苏)自由贸易试验区苏州片区苏州工业园区润胜路1号的6号厂房南楼 邮编: 215000 t (86-512) 62992980 sgs.china@sgs.com

802.11n20_Channel 01

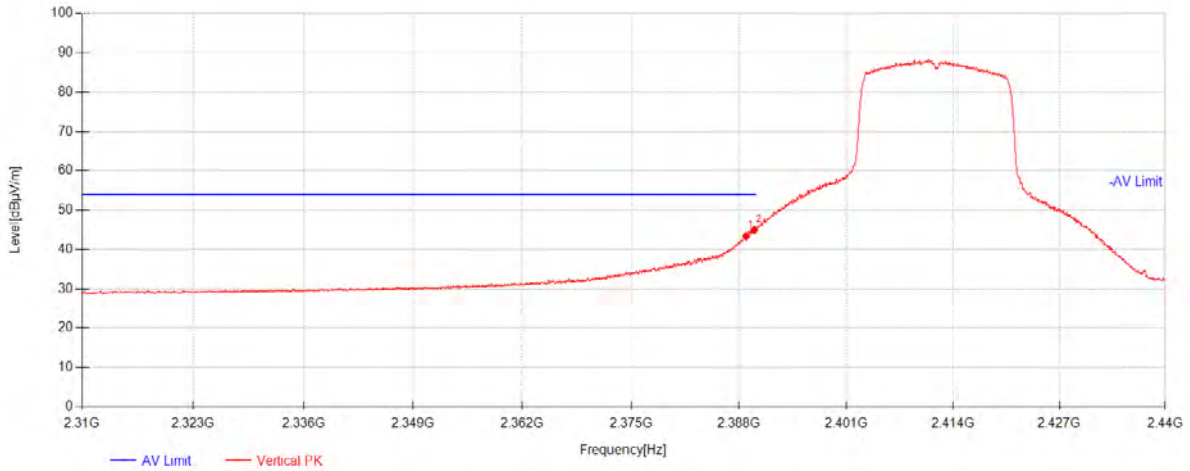

Data List								
NO.	Frequency [MHz]	Reading [dBµV]	AF [dB/m]	Factor [dB]	Level [dBµV/m]	Limit [dBµV/m]	Margin [dB]	Polarity
1	2388.8667	39.98	26.99	-23.57	43.40	54.00	10.60	Vertical
2	2389.82	41.47	26.99	-23.57	44.89	54.00	9.11	Vertical



Unless otherwise agreed in writing, this document is issued by the Company subject to its General Conditions of Service printed overleaf, available on request or accessible at <http://www.sgs.com/en/Terms-and-Conditions.aspx> and, for electronic format documents, subject to Terms and Conditions for Electronic Documents at <http://www.sgs.com/en/Terms-and-Conditions/Terms-e-Documents.aspx>. Attention is drawn to the limitation of liability, indemnification and jurisdiction issues defined therein. Any holder of this document is advised that information contained hereon reflects the Company's findings at the time of its intervention only and within the limits of Client's instructions, if any. The Company's sole responsibility is to its Client and this document does not exonerate parties to a transaction from exercising all their rights and obligations under the transaction documents. This document cannot be reproduced except in full, without prior written approval of the Company. Any unauthorized alteration, forgery or falsification of the content or appearance of this document is unlawful and offenders may be prosecuted to the fullest extent of the law. Unless otherwise stated the results shown in this test report refer only to the sample(s) tested and such sample(s) are retained for 30 days.

Attention: To check the authenticity of testing/inspection report & certificate, please contact us at telephone: (86-755) 8307 1443, or email: CN.Doccheck@sgs.com

South of No. 6 Plant, No. 1, Runsheng Road, Suzhou Industrial Park, Suzhou Area, China (Jiangsu) Pilot Free Trade Zone 215000 t (86-512) 62992980 www.sgs.com.cn
 中国·苏州·中国(江苏)自由贸易试验区苏州片区苏州工业园区润胜路1号的6号厂房南楼 邮编: 215000 t (86-512) 62992980 sgs.china@sgs.com

802.11n20_Channel 01

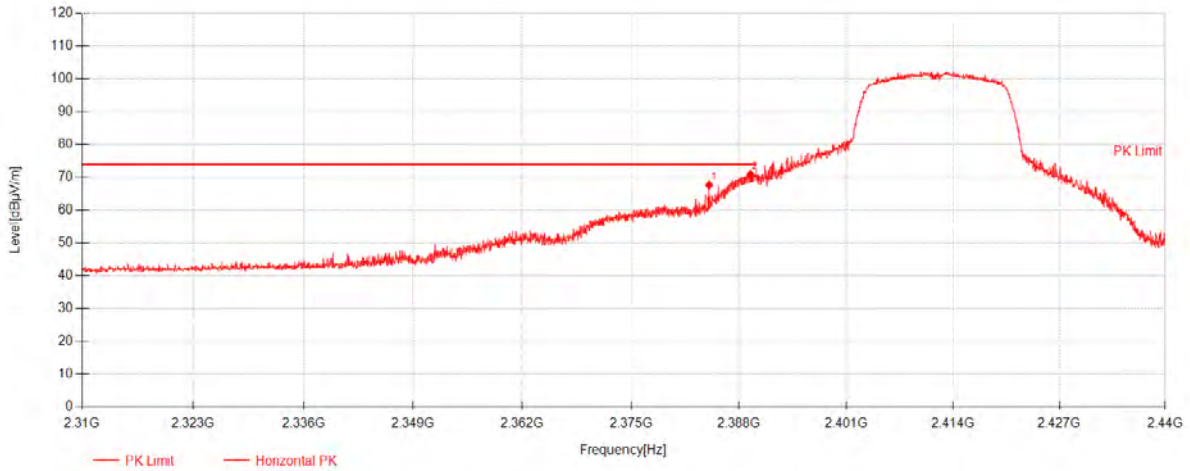

Data List								
NO.	Frequency [MHz]	Reading [dBµV]	AF [dB/m]	Factor [dB]	Level [dBµV/m]	Limit [dBµV/m]	Margin [dB]	Polarity
1	2384.4033	64.32	26.98	-23.57	67.72	74.00	6.28	Horizontal
2	2389.3867	67.47	26.99	-23.57	70.89	74.00	3.11	Horizontal



Unless otherwise agreed in writing, this document is issued by the Company subject to its General Conditions of Service printed overleaf, available on request or accessible at <http://www.sgs.com/en/Terms-and-Conditions.aspx> and, for electronic format documents, subject to Terms and Conditions for Electronic Documents at <http://www.sgs.com/en/Terms-and-Conditions/Terms-e-Documents.aspx>. Attention is drawn to the limitation of liability, indemnification and jurisdiction issues defined therein. Any holder of this document is advised that information contained hereon reflects the Company's findings at the time of its intervention only and within the limits of Client's instructions, if any. The Company's sole responsibility is to its Client and this document does not exonerate parties to a transaction from exercising all their rights and obligations under the transaction documents. This document cannot be reproduced except in full, without prior written approval of the Company. Any unauthorized alteration, forgery or falsification of the content or appearance of this document is unlawful and offenders may be prosecuted to the fullest extent of the law. Unless otherwise stated the results shown in this test report refer only to the sample(s) tested and such sample(s) are retained for 30 days.

Attention: To check the authenticity of testing/inspection report & certificate, please contact us at telephone: (86-755) 8307 1443, or email: CN.Doccheck@sgs.com

South of No. 6 Plant, No. 1, Runsheng Road, Suzhou Industrial Park, Suzhou Area, China (Jiangsu) Pilot Free Trade Zone 215000 t (86-512) 62992980 www.sgsgroup.com.cn
 中国·苏州·中国(江苏)自由贸易试验区苏州片区苏州工业园区润胜路1号的6号厂房南楼 邮编: 215000 t (86-512) 62992980 sgs.china@sgs.com

802.11n20_Channel 01

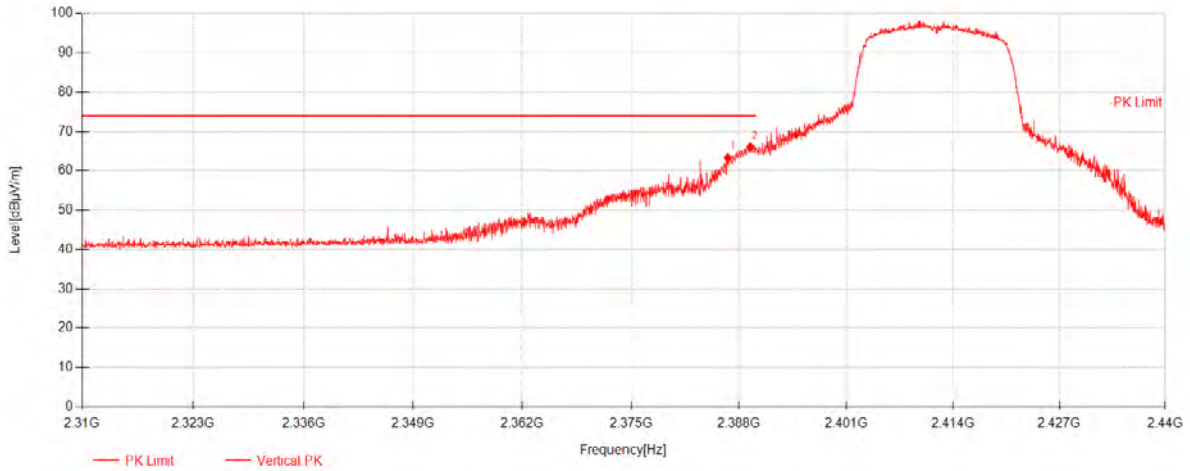

Data List								
NO.	Frequency [MHz]	Reading [dBμV]	AF [dB/m]	Factor [dB]	Level [dBμV/m]	Limit [dBμV/m]	Margin [dB]	Polarity
1	2386.6567	59.95	26.98	-23.57	63.36	74.00	10.64	Vertical
2	2389.3867	62.70	26.99	-23.57	66.12	74.00	7.88	Vertical



Unless otherwise agreed in writing, this document is issued by the Company subject to its General Conditions of Service printed overleaf, available on request or accessible at <http://www.sgs.com/en/Terms-and-Conditions.aspx> and, for electronic format documents, subject to Terms and Conditions for Electronic Documents at <http://www.sgs.com/en/Terms-and-Conditions/Terms-e-Documents.aspx>. Attention is drawn to the limitation of liability, indemnification and jurisdiction issues defined therein. Any holder of this document is advised that information contained hereon reflects the Company's findings at the time of its intervention only and within the limits of Client's instructions, if any. The Company's sole responsibility is to its Client and this document does not exonerate parties to a transaction from exercising all their rights and obligations under the transaction documents. This document cannot be reproduced except in full, without prior written approval of the Company. Any unauthorized alteration, forgery or falsification of the content or appearance of this document is unlawful and offenders may be prosecuted to the fullest extent of the law. Unless otherwise stated the results shown in this test report refer only to the sample(s) tested and such sample(s) are retained for 30 days only.

Attention: To check the authenticity of testing/inspection report & certificate, please contact us at telephone: (86-755) 8307 1443, or email: CN.Doccheck@sgs.com

South of No. 6 Plant, No. 1, Runsheng Road, Suzhou Industrial Park, Suzhou Area, China (Jiangsu) Pilot Free Trade Zone 215000 t (86-512) 62992980 www.sgsgroup.com.cn
 中国·苏州·中国(江苏)自由贸易试验区苏州片区苏州工业园区润胜路1号的6号厂房南楼 邮编: 215000 t (86-512) 62992980 sgs.china@sgs.com

802.11n20_Channel 11

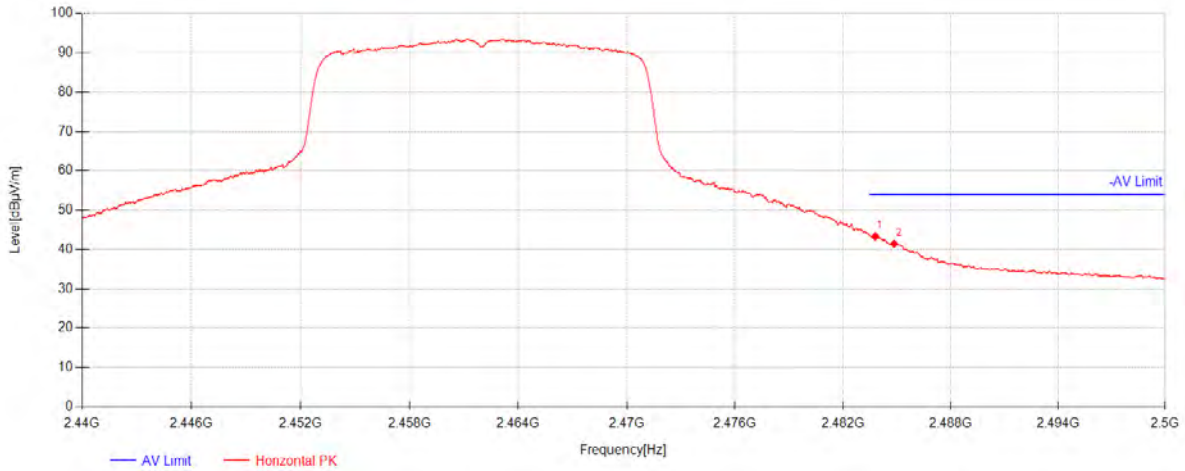

Data List								
NO.	Frequency [MHz]	Reading [dBµV]	AF [dB/m]	Factor [dB]	Level [dBµV/m]	Limit [dBµV/m]	Margin [dB]	Polarity
1	2483.8	39.64	27.25	-23.54	43.35	54.00	10.65	Horizontal
2	2484.85	37.74	27.26	-23.54	41.45	54.00	12.55	Horizontal



Unless otherwise agreed in writing, this document is issued by the Company subject to its General Conditions of Service printed overleaf, available on request or accessible at <http://www.sgs.com/en/Terms-and-Conditions.aspx> and, for electronic format documents, subject to Terms and Conditions for Electronic Documents at <http://www.sgs.com/en/Terms-and-Conditions/Terms-e-Documents.aspx>. Attention is drawn to the limitation of liability, indemnification and jurisdiction issues defined therein. Any holder of this document is advised that information contained hereon reflects the Company's findings at the time of its intervention only and within the limits of Client's instructions, if any. The Company's sole responsibility is to its Client and this document does not exonerate parties to a transaction from exercising all their rights and obligations under the transaction documents. This document cannot be reproduced except in full, without prior written approval of the Company. Any unauthorized alteration, forgery or falsification of the content or appearance of this document is unlawful and offenders may be prosecuted to the fullest extent of the law. Unless otherwise stated the results shown in this test report refer only to the sample(s) tested and such sample(s) are retained for 30 days.

Attention: To check the authenticity of testing/inspection report & certificate, please contact us at telephone: (86-755) 8307 1443, or email: CN.Doccheck@sgs.com

South of No. 6 Plant, No. 1, Runsheng Road, Suzhou Industrial Park, Suzhou Area, China (Jiangsu) Pilot Free Trade Zone 215000 t (86-512) 62992980 www.sgsgroup.com.cn
 中国·苏州·中国(江苏)自由贸易试验区苏州片区苏州工业园区润胜路1号的6号厂房南楼 邮编: 215000 t (86-512) 62992980 sgs.china@sgs.com

802.11n20_Channel 11

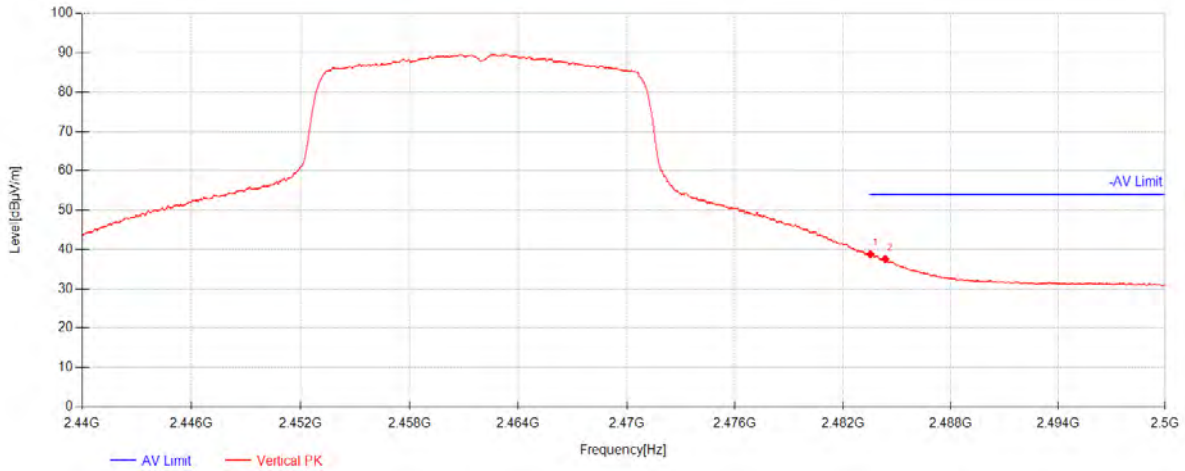

Data List								
NO.	Frequency [MHz]	Reading [dBµV]	AF [dB/m]	Factor [dB]	Level [dBµV/m]	Limit [dBµV/m]	Margin [dB]	Polarity
1	2483.53	35.08	27.25	-23.54	38.79	54.00	15.21	Vertical
2	2484.355	33.88	27.26	-23.54	37.59	54.00	16.41	Vertical



Unless otherwise agreed in writing, this document is issued by the Company subject to its General Conditions of Service printed overleaf, available on request or accessible at <http://www.sgs.com/en/Terms-and-Conditions.aspx> and, for electronic format documents, subject to Terms and Conditions for Electronic Documents at <http://www.sgs.com/en/Terms-and-Conditions/Terms-e-Documents.aspx>. Attention is drawn to the limitation of liability, indemnification and jurisdiction issues defined therein. Any holder of this document is advised that information contained hereon reflects the Company's findings at the time of its intervention only and within the limits of Client's instructions, if any. The Company's sole responsibility is to its Client and this document does not exonerate parties to a transaction from exercising all their rights and obligations under the transaction documents. This document cannot be reproduced except in full, without prior written approval of the Company. Any unauthorized alteration, forgery or falsification of the content or appearance of this document is unlawful and offenders may be prosecuted to the fullest extent of the law. Unless otherwise stated the results shown in this test report refer only to the sample(s) tested and such sample(s) are retained for 30 days only.

Attention: To check the authenticity of testing/inspection report & certificate, please contact us at telephone: (86-755) 8307 1443, or email: CN.Doccheck@sgs.com

South of No. 6 Plant, No. 1, Runsheng Road, Suzhou Industrial Park, Suzhou Area, China (Jiangsu) Pilot Free Trade Zone 215000 t (86-512) 62992980 www.sgs.com.cn
 中国·苏州·中国(江苏)自由贸易试验区苏州片区苏州工业园区润胜路1号的6号厂房南楼 邮编: 215000 t (86-512) 62992980 sgs.china@sgs.com

802.11n20_Channel 11

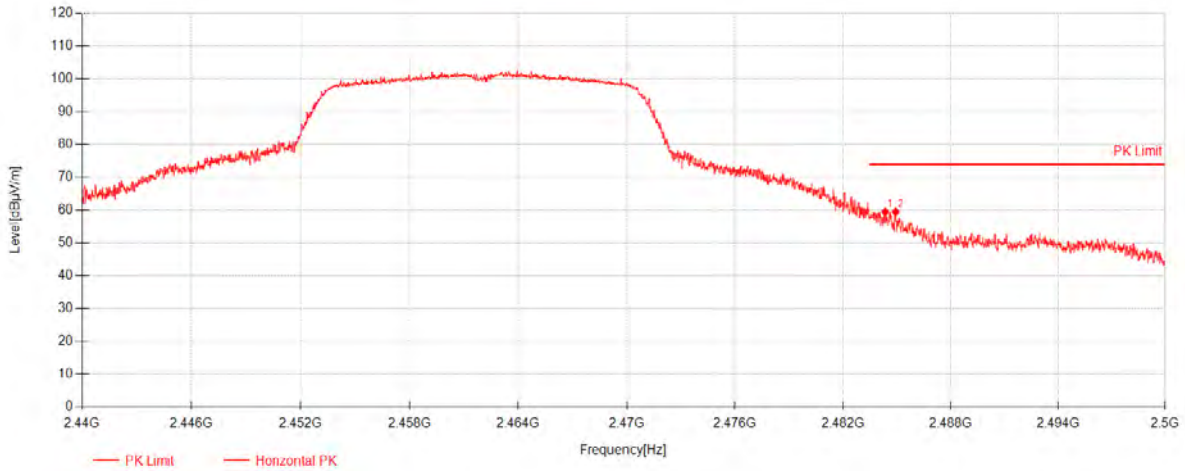

Data List								
NO.	Frequency [MHz]	Reading [dBµV]	AF [dB/m]	Factor [dB]	Level [dBµV/m]	Limit [dBµV/m]	Margin [dB]	Polarity
1	2484.355	55.83	27.26	-23.54	59.54	74.00	14.46	Horizontal
2	2484.94	55.82	27.26	-23.54	59.53	74.00	14.47	Horizontal



Unless otherwise agreed in writing, this document is issued by the Company subject to its General Conditions of Service printed overleaf, available on request or accessible at <http://www.sgs.com/en/Terms-and-Conditions.aspx> and, for electronic format documents, subject to Terms and Conditions for Electronic Documents at <http://www.sgs.com/en/Terms-and-Conditions/Terms-e-Documents.aspx>. Attention is drawn to the limitation of liability, indemnification and jurisdiction issues defined therein. Any holder of this document is advised that information contained hereon reflects the Company's findings at the time of its intervention only and within the limits of Client's instructions, if any. The Company's sole responsibility is to its Client and this document does not exonerate parties to a transaction from exercising all their rights and obligations under the transaction documents. This document cannot be reproduced except in full, without prior written approval of the Company. Any unauthorized alteration, forgery or falsification of the content or appearance of this document is unlawful and offenders may be prosecuted to the fullest extent of the law. Unless otherwise stated the results shown in this test report refer only to the sample(s) tested and such sample(s) are retained for 30 days only.

Attention: To check the authenticity of testing/inspection report & certificate, please contact us at telephone: (86-755) 8307 1443, or email: CN.Doccheck@sgs.com

South of No. 6 Plant, No. 1, Runsheng Road, Suzhou Industrial Park, Suzhou Area, China (Jiangsu) Pilot Free Trade Zone 215000 t (86-512) 62992980 www.sgs.com.cn
 中国·苏州·中国(江苏)自由贸易试验区苏州片区苏州工业园区润胜路1号的6号厂房南楼 邮编: 215000 t (86-512) 62992980 sgs.china@sgs.com

802.11n20_Channel 11

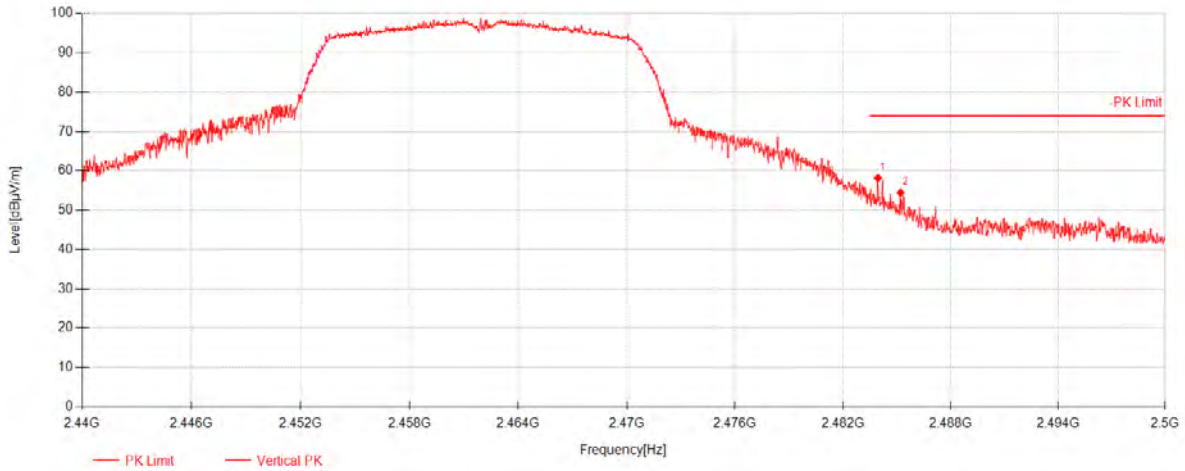

Data List								
NO.	Frequency [MHz]	Reading [dBµV]	AF [dB/m]	Factor [dB]	Level [dBµV/m]	Limit [dBµV/m]	Margin [dB]	Polarity
1	2483.95	54.44	27.26	-23.54	58.15	74.00	15.85	Vertical
2	2485.21	50.74	27.26	-23.54	54.45	74.00	19.55	Vertical



Unless otherwise agreed in writing, this document is issued by the Company subject to its General Conditions of Service printed overleaf, available on request or accessible at <http://www.sgs.com/en/Terms-and-Conditions.aspx> and, for electronic format documents, subject to Terms and Conditions for Electronic Documents at <http://www.sgs.com/en/Terms-and-Conditions/Terms-e-Documents.aspx>. Attention is drawn to the limitation of liability, indemnification and jurisdiction issues defined therein. Any holder of this document is advised that information contained hereon reflects the Company's findings at the time of its intervention only and within the limits of Client's instructions, if any. The Company's sole responsibility is to its Client and this document does not exonerate parties to a transaction from exercising all their rights and obligations under the transaction documents. This document cannot be reproduced except in full, without prior written approval of the Company. Any unauthorized alteration, forgery or falsification of the content or appearance of this document is unlawful and offenders may be prosecuted to the fullest extent of the law. Unless otherwise stated the results shown in this test report refer only to the sample(s) tested and such sample(s) are retained for 30 days only.

Attention: To check the authenticity of testing/inspection report & certificate, please contact us at telephone: (86-755) 8307 1443, or email: CN.Doccheck@sgs.com
 South of No. 6 Plant, No. 1, Runsheng Road, Suzhou Industrial Park, Suzhou Area, China (Jiangsu) Pilot Free Trade Zone 215000 t (86-512) 62992980 www.sgs.com.cn
 中国·苏州·中国(江苏)自由贸易试验区苏州片区苏州工业园区润胜路1号的6号厂房南楼 邮编: 215000 t (86-512) 62992980 sgs.china@sgs.com

802.11n40_Channel 03

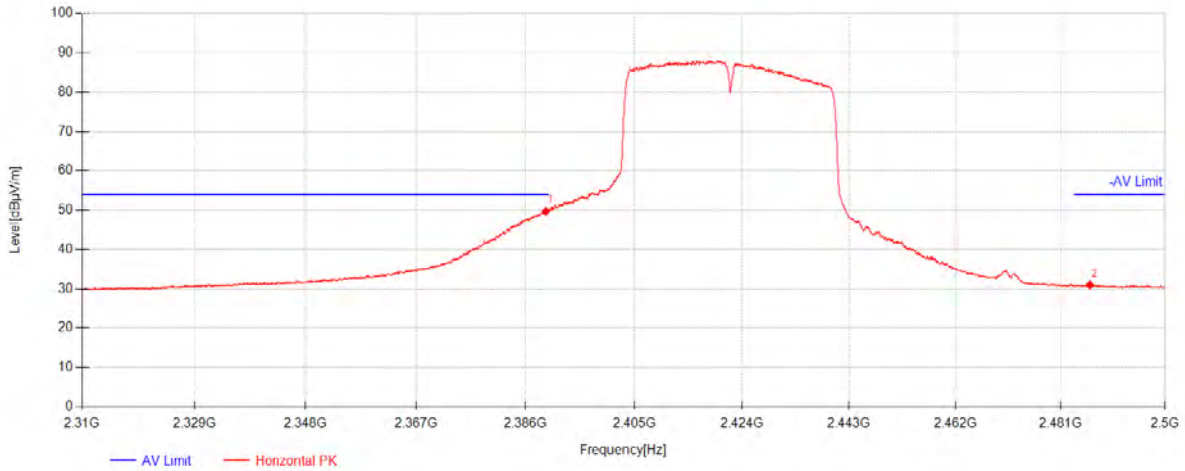

Data List								
NO.	Frequency [MHz]	Reading [dBµV]	AF [dB/m]	Factor [dB]	Level [dBµV/m]	Limit [dBµV/m]	Margin [dB]	Polarity
1	2389.5167	46.26	26.99	-23.57	49.68	54.00	4.32	Horizontal
2	2486.32	27.31	27.26	-23.54	31.03	54.00	22.97	Horizontal



Unless otherwise agreed in writing, this document is issued by the Company subject to its General Conditions of Service printed overleaf, available on request or accessible at <http://www.sgs.com/en/Terms-and-Conditions.aspx> and, for electronic format documents, subject to Terms and Conditions for Electronic Documents at <http://www.sgs.com/en/Terms-and-Conditions/Terms-e-Documents.aspx>. Attention is drawn to the limitation of liability, indemnification and jurisdiction issues defined therein. Any holder of this document is advised that information contained hereon reflects the Company's findings at the time of its intervention only and within the limits of Client's instructions, if any. The Company's sole responsibility is to its Client and this document does not exonerate parties to a transaction from exercising all their rights and obligations under the transaction documents. This document cannot be reproduced except in full, without prior written approval of the Company. Any unauthorized alteration, forgery or falsification of the content or appearance of this document is unlawful and offenders may be prosecuted to the fullest extent of the law. Unless otherwise stated the results shown in this test report refer only to the sample(s) tested and such sample(s) are retained for 30 days only.

Attention: To check the authenticity of testing/inspection report & certificate, please contact us at telephone: (86-755) 8307 1443, or email: CN.Doccheck@sgs.com

South of No. 6 Plant, No. 1, Runsheng Road, Suzhou Industrial Park, Suzhou Area, China (Jiangsu) Pilot Free Trade Zone 215000 t (86-512) 62992980 www.sgsgroup.com.cn
 中国·苏州·中国(江苏)自由贸易试验区苏州片区苏州工业园区润胜路1号的6号厂房南楼 邮编: 215000 t (86-512) 62992980 sgs.china@sgs.com

802.11n40_Channel 03

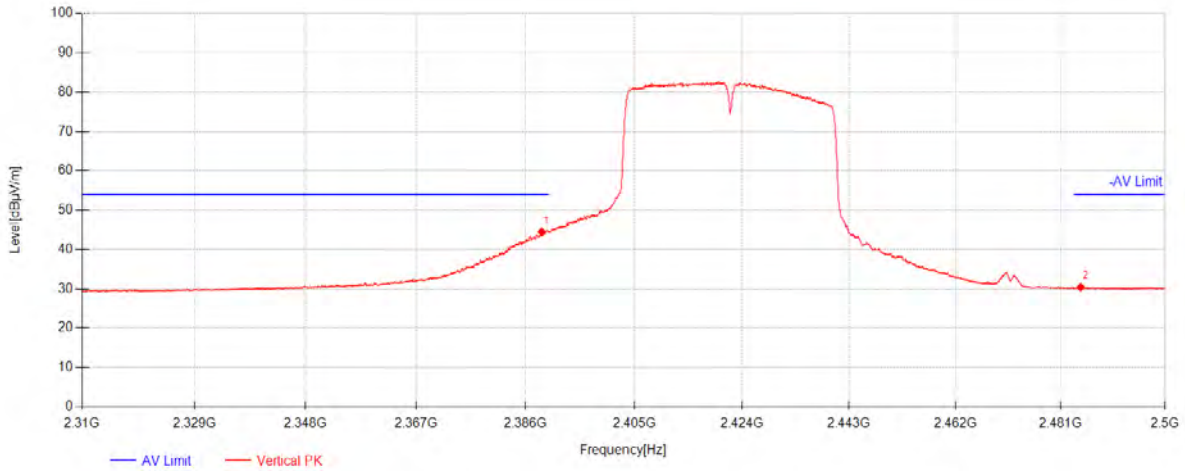

Data List								
NO.	Frequency [MHz]	Reading [dBµV]	AF [dB/m]	Factor [dB]	Level [dBµV/m]	Limit [dBµV/m]	Margin [dB]	Polarity
1	2388.8233	41.10	26.99	-23.57	44.52	54.00	9.48	Vertical
2	2484.64	26.73	27.26	-23.54	30.44	54.00	23.56	Vertical



Unless otherwise agreed in writing, this document is issued by the Company subject to its General Conditions of Service printed overleaf, available on request or accessible at <http://www.sgs.com/en/Terms-and-Conditions.aspx> and, for electronic format documents, subject to Terms and Conditions for Electronic Documents at <http://www.sgs.com/en/Terms-and-Conditions/Terms-e-Documents.aspx>. Attention is drawn to the limitation of liability, indemnification and jurisdiction issues defined therein. Any holder of this document is advised that information contained hereon reflects the Company's findings at the time of its intervention only and within the limits of Client's instructions, if any. The Company's sole responsibility is to its Client and this document does not exonerate parties to a transaction from exercising all their rights and obligations under the transaction documents. This document cannot be reproduced except in full, without prior written approval of the Company. Any unauthorized alteration, forgery or falsification of the content or appearance of this document is unlawful and offenders may be prosecuted to the fullest extent of the law. Unless otherwise stated the results shown in this test report refer only to the sample(s) tested and such sample(s) are retained for 30 days only.

Attention: To check the authenticity of testing/inspection report & certificate, please contact us at telephone: (86-755) 8307 1443, or email: CN.Doccheck@sgs.com

South of No. 6 Plant, No. 1, Runsheng Road, Suzhou Industrial Park, Suzhou Area, China (Jiangsu) Pilot Free Trade Zone 215000 t (86-512) 62992980 www.sgsgroup.com.cn
 中国·苏州·中国(江苏)自由贸易试验区苏州片区苏州工业园区润胜路1号的6号厂房南楼 邮编: 215000 t (86-512) 62992980 sgs.china@sgs.com

802.11n40_Channel 03

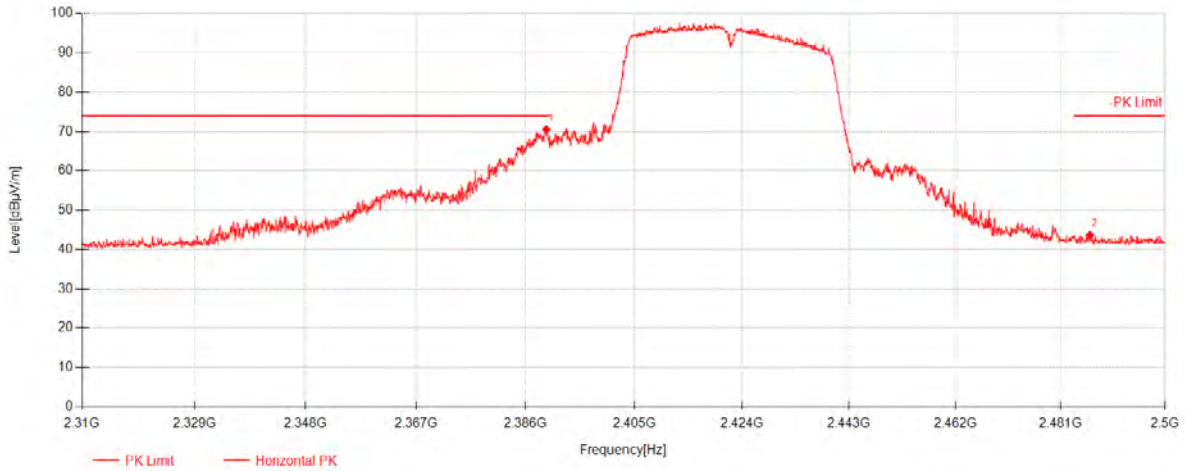

Data List								
NO.	Frequency [MHz]	Reading [dBµV]	AF [dB/m]	Factor [dB]	Level [dBµV/m]	Limit [dBµV/m]	Margin [dB]	Polarity
1	2389.6033	67.09	26.99	-23.57	70.51	74.00	3.49	Horizontal
2	2486.32	39.97	27.26	-23.54	43.69	74.00	30.31	Horizontal



Unless otherwise agreed in writing, this document is issued by the Company subject to its General Conditions of Service printed overleaf, available on request or accessible at <http://www.sgs.com/en/Terms-and-Conditions.aspx> and, for electronic format documents, subject to Terms and Conditions for Electronic Documents at <http://www.sgs.com/en/Terms-and-Conditions/Terms-e-Documents.aspx>. Attention is drawn to the limitation of liability, indemnification and jurisdiction issues defined therein. Any holder of this document is advised that information contained hereon reflects the Company's findings at the time of its intervention only and within the limits of Client's instructions, if any. The Company's sole responsibility is to its Client and this document does not exonerate parties to a transaction from exercising all their rights and obligations under the transaction documents. This document cannot be reproduced except in full, without prior written approval of the Company. Any unauthorized alteration, forgery or falsification of the content or appearance of this document is unlawful and offenders may be prosecuted to the fullest extent of the law. Unless otherwise stated the results shown in this test report refer only to the sample(s) tested and such sample(s) are retained for 30 days.

Attention: To check the authenticity of testing/inspection report & certificate, please contact us at telephone: (86-755) 8307 1443, or email: CN.Doccheck@sgs.com

South of No. 6 Plant, No. 1, Runsheng Road, Suzhou Industrial Park, Suzhou Area, China (Jiangsu) Pilot Free Trade Zone 215000 t (86-512) 62992980 www.sgsgroup.com.cn
 中国·苏州·中国(江苏)自由贸易试验区苏州片区苏州工业园区润胜路1号的6号厂房南楼 邮编: 215000 t (86-512) 62992980 sgs.china@sgs.com

802.11n40_Channel 03

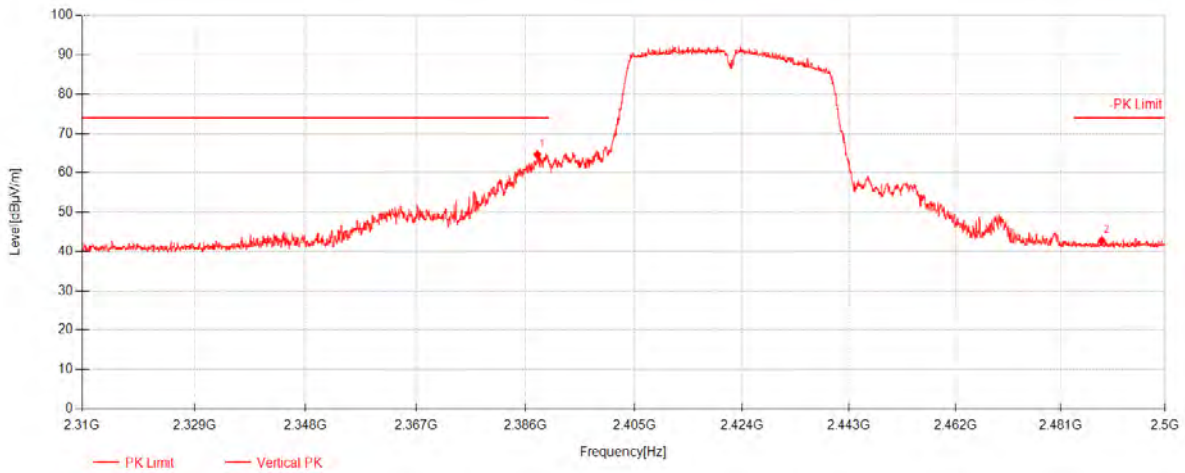

Data List								
NO.	Frequency [MHz]	Reading [dBµV]	AF [dB/m]	Factor [dB]	Level [dBµV/m]	Limit [dBµV/m]	Margin [dB]	Polarity
1	2388.0433	61.19	26.99	-23.57	64.61	74.00	9.39	Vertical
2	2488.48	39.08	27.27	-23.54	42.80	74.00	31.20	Vertical



Unless otherwise agreed in writing, this document is issued by the Company subject to its General Conditions of Service printed overleaf, available on request or accessible at <http://www.sgs.com/en/Terms-and-Conditions.aspx> and, for electronic format documents, subject to Terms and Conditions for Electronic Documents at <http://www.sgs.com/en/Terms-and-Conditions/Terms-e-Documents.aspx>. Attention is drawn to the limitation of liability, indemnification and jurisdiction issues defined therein. Any holder of this document is advised that information contained hereon reflects the Company's findings at the time of its intervention only and within the limits of Client's instructions, if any. The Company's sole responsibility is to its Client and this document does not exonerate parties to a transaction from exercising all their rights and obligations under the transaction documents. This document cannot be reproduced except in full, without prior written approval of the Company. Any unauthorized alteration, forgery or falsification of the content or appearance of this document is unlawful and offenders may be prosecuted to the fullest extent of the law. Unless otherwise stated the results shown in this test report refer only to the sample(s) tested and such sample(s) are retained for 30 days only.

Attention: To check the authenticity of testing/inspection report & certificate, please contact us at telephone: (86-755) 8307 1443, or email: CN.Doccheck@sgs.com

South of No. 6 Plant, No. 1, Runsheng Road, Suzhou Industrial Park, Suzhou Area, China (Jiangsu) Pilot Free Trade Zone 215000 t (86-512) 62992980 www.sgs.com.cn
 中国·苏州·中国(江苏)自由贸易试验区苏州片区苏州工业园区润胜路1号的6号厂房南楼 邮编: 215000 t (86-512) 62992980 sgs.china@sgs.com

802.11n40_Channel 09

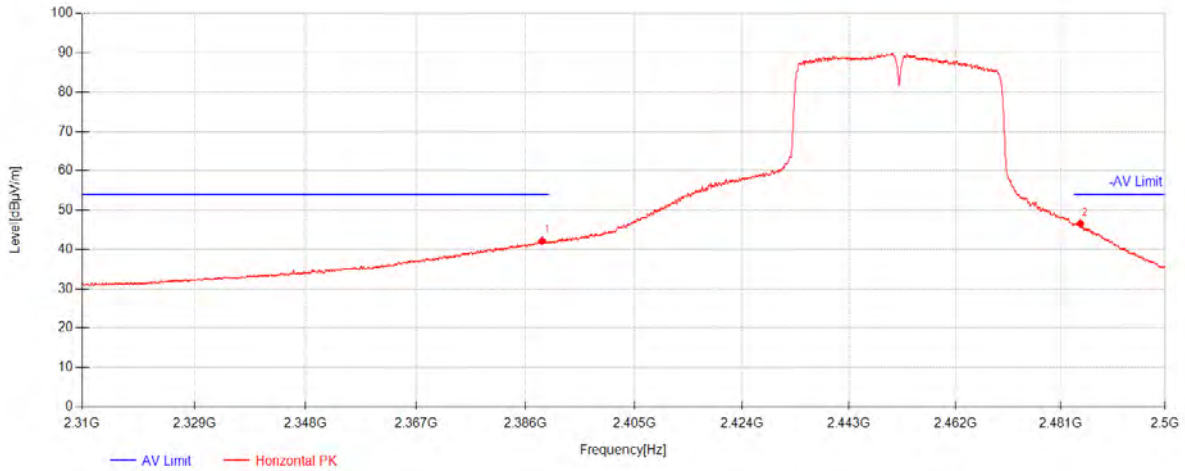

Data List								
NO.	Frequency [MHz]	Reading [dBµV]	AF [dB/m]	Factor [dB]	Level [dBµV/m]	Limit [dBµV/m]	Margin [dB]	Polarity
1	2388.91	38.79	26.99	-23.57	42.21	54.00	11.79	Horizontal
2	2484.58	42.86	27.26	-23.54	46.57	54.00	7.43	Horizontal



Unless otherwise agreed in writing, this document is issued by the Company subject to its General Conditions of Service printed overleaf, available on request or accessible at <http://www.sgs.com/en/Terms-and-Conditions.aspx> and, for electronic format documents, subject to Terms and Conditions for Electronic Documents at <http://www.sgs.com/en/Terms-and-Conditions/Terms-e-Documents.aspx>. Attention is drawn to the limitation of liability, indemnification and jurisdiction issues defined therein. Any holder of this document is advised that information contained hereon reflects the Company's findings at the time of its intervention only and within the limits of Client's instructions, if any. The Company's sole responsibility is to its Client and this document does not exonerate parties to a transaction from exercising all their rights and obligations under the transaction documents. This document cannot be reproduced except in full, without prior written approval of the Company. Any unauthorized alteration, forgery or falsification of the content or appearance of this document is unlawful and offenders may be prosecuted to the fullest extent of the law. Unless otherwise stated the results shown in this test report refer only to the sample(s) tested and such sample(s) are retained for 30 days only.

Attention: To check the authenticity of testing/inspection report & certificate, please contact us at telephone: (86-755) 8307 1443, or email: CN.Doccheck@sgs.com

South of No. 6 Plant, No. 1, Runsheng Road, Suzhou Industrial Park, Suzhou Area, China (Jiangsu) Pilot Free Trade Zone 215000 t (86-512) 62992980 www.sgs.com.cn
 中国·苏州·中国(江苏)自由贸易试验区苏州片区苏州工业园区润胜路1号的6号厂房南楼 邮编: 215000 t (86-512) 62992980 sgs.china@sgs.com

802.11n40_Channel 09

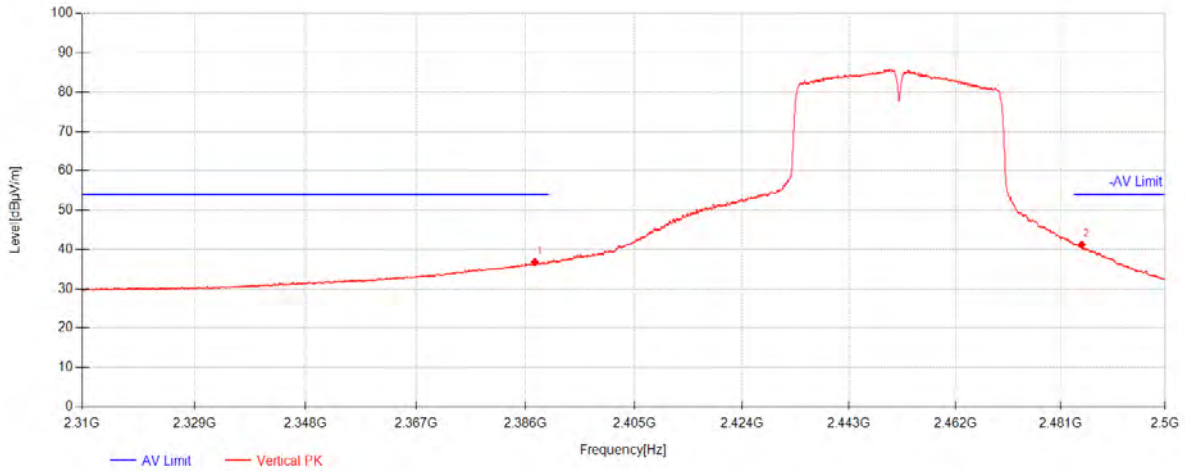

Data List								
NO.	Frequency [MHz]	Reading [dBµV]	AF [dB/m]	Factor [dB]	Level [dBµV/m]	Limit [dBµV/m]	Margin [dB]	Polarity
1	2387.61	33.40	26.99	-23.57	36.81	54.00	17.19	Vertical
2	2484.82	37.51	27.26	-23.54	41.22	54.00	12.78	Vertical



Unless otherwise agreed in writing, this document is issued by the Company subject to its General Conditions of Service printed overleaf, available on request or accessible at <http://www.sgs.com/en/Terms-and-Conditions.aspx> and, for electronic format documents, subject to Terms and Conditions for Electronic Documents at <http://www.sgs.com/en/Terms-and-Conditions/Terms-e-Documents.aspx>. Attention is drawn to the limitation of liability, indemnification and jurisdiction issues defined therein. Any holder of this document is advised that information contained hereon reflects the Company's findings at the time of its intervention only and within the limits of Client's instructions, if any. The Company's sole responsibility is to its Client and this document does not exonerate parties to a transaction from exercising all their rights and obligations under the transaction documents. This document cannot be reproduced except in full, without prior written approval of the Company. Any unauthorized alteration, forgery or falsification of the content or appearance of this document is unlawful and offenders may be prosecuted to the fullest extent of the law. Unless otherwise stated the results shown in this test report refer only to the sample(s) tested and such sample(s) are retained for 30 days only.

Attention: To check the authenticity of testing/inspection report & certificate, please contact us at telephone: (86-755) 8307 1443, or email: CN.Doccheck@sgs.com

South of No. 6 Plant, No. 1, Runsheng Road, Suzhou Industrial Park, Suzhou Area, China (Jiangsu) Pilot Free Trade Zone 215000 t (86-512) 62992980 www.sgs.com.cn
 中国·苏州·中国(江苏)自由贸易试验区苏州片区苏州工业园区润胜路1号的6号厂房南楼 邮编: 215000 t (86-512) 62992980 sgs.china@sgs.com

802.11n40_Channel 09

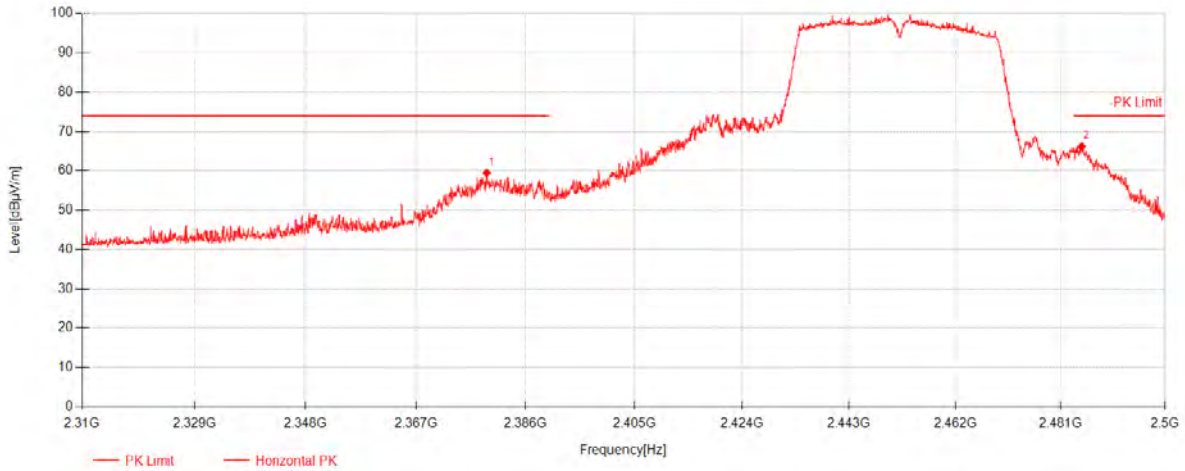

Data List								
NO.	Frequency [MHz]	Reading [dBµV]	AF [dB/m]	Factor [dB]	Level [dBµV/m]	Limit [dBµV/m]	Margin [dB]	Polarity
1	2379.2467	56.05	26.96	-23.57	59.44	74.00	14.56	Horizontal
2	2484.82	62.45	27.26	-23.54	66.16	74.00	7.84	Horizontal



Unless otherwise agreed in writing, this document is issued by the Company subject to its General Conditions of Service printed overleaf, available on request or accessible at <http://www.sgs.com/en/Terms-and-Conditions.aspx> and, for electronic format documents, subject to Terms and Conditions for Electronic Documents at <http://www.sgs.com/en/Terms-and-Conditions/Terms-e-Documents.aspx>. Attention is drawn to the limitation of liability, indemnification and jurisdiction issues defined therein. Any holder of this document is advised that information contained hereon reflects the Company's findings at the time of its intervention only and within the limits of Client's instructions, if any. The Company's sole responsibility is to its Client and this document does not exonerate parties to a transaction from exercising all their rights and obligations under the transaction documents. This document cannot be reproduced except in full, without prior written approval of the Company. Any unauthorized alteration, forgery or falsification of the content or appearance of this document is unlawful and offenders may be prosecuted to the fullest extent of the law. Unless otherwise stated the results shown in this test report refer only to the sample(s) tested and such sample(s) are retained for 30 days.

Attention: To check the authenticity of testing/inspection report & certificate, please contact us at telephone: (86-755) 8307 1443, or email: CN.Doccheck@sgs.com

South of No. 6 Plant, No. 1, Runsheng Road, Suzhou Industrial Park, Suzhou Area, China (Jiangsu) Pilot Free Trade Zone 215000 t (86-512) 62992980 www.sgs.com.cn
 中国·苏州·中国(江苏)自由贸易试验区苏州片区苏州工业园区润胜路1号的6号厂房南楼 邮编: 215000 t (86-512) 62992980 sgs.china@sgs.com

802.11n40_Channel 09

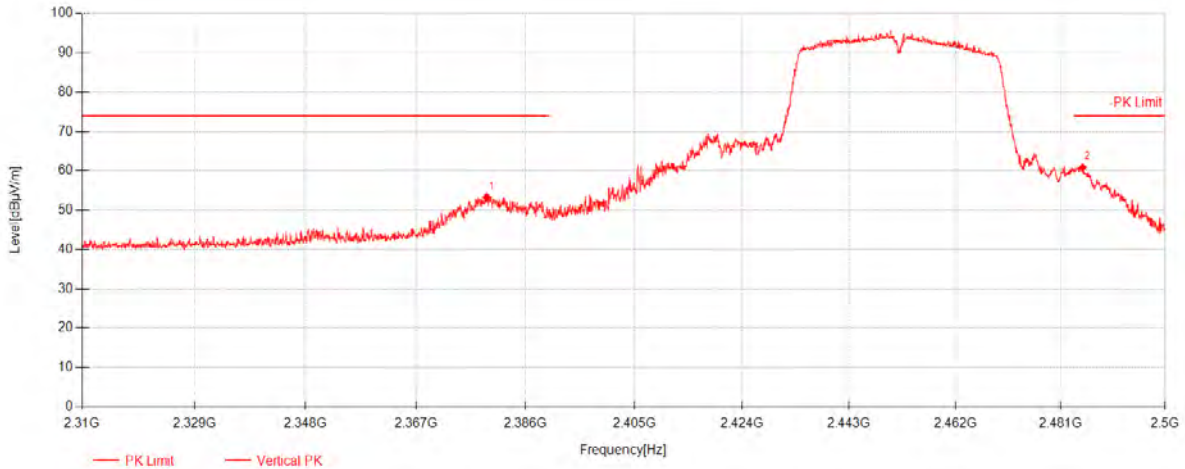

Data List								
NO.	Frequency [MHz]	Reading [dBµV]	AF [dB/m]	Factor [dB]	Level [dBµV/m]	Limit [dBµV/m]	Margin [dB]	Polarity
1	2379.2467	49.88	26.96	-23.57	53.27	74.00	20.73	Vertical
2	2485	57.13	27.26	-23.54	60.84	74.00	13.16	Vertical

Remark:

- The field strength is calculated by adding the Antenna Factor, Cable Factor & Preamplifier gain. The basic equation with a sample calculation is as follows:
 $Level = Reading(dB\mu V) + AF(dB/m) + Factor(dB)$
 $AF = Antenna\ Factor(dB/m)$
 $Factor = Cable\ Factor(dB) - Preamplifier\ gain(dB)$
 $Margin = Limit(dB\mu V/m) - Level(dB\mu V/m)$
- Both peak and average measured complies with the limit line, so test result is "PASS"

---End of Report---



Unless otherwise agreed in writing, this document is issued by the Company subject to its General Conditions of Service printed overleaf, available on request or accessible at <http://www.sgs.com/en/Terms-and-Conditions.aspx> and, for electronic format documents, subject to Terms and Conditions for Electronic Documents at <http://www.sgs.com/en/Terms-and-Conditions/Terms-e-Documents.aspx>. Attention is drawn to the limitation of liability, indemnification and jurisdiction issues defined therein. Any holder of this document is advised that information contained hereon reflects the Company's findings at the time of its intervention only and within the limits of Client's instructions, if any. The Company's sole responsibility is to its Client and this document does not exonerate parties to a transaction from exercising all their rights and obligations under the transaction documents. This document cannot be reproduced except in full, without prior written approval of the Company. Any unauthorized alteration, forgery or falsification of the content or appearance of this document is unlawful and offenders may be prosecuted to the fullest extent of the law. Unless otherwise stated the results shown in this test report refer only to the sample(s) tested and such sample(s) are retained for 30 days only.

Attention: To check the authenticity of testing/inspection report & certificate, please contact us at telephone: (86-755) 8307 1443, or email: CN.Doccheck@sgs.com
 South of No. 6 Plant, No. 1, Runsheng Road, Suzhou Industrial Park, Suzhou Area, China (Jiangsu) Pilot Free Trade Zone 215000 t (86-512) 62992980 www.sgsgroup.com.cn
 中国·苏州·中国(江苏)自由贸易试验区苏州片区苏州工业园区润胜路1号的6号厂房南楼 邮编: 215000 t (86-512) 62992980 sgs.china@sgs.com