

iData[®]

iData 50

User Manual

www.idatachina.com

Contents

1 Introduction	1
1.1 Appearance of iData 50.....	1
1.2 Installing the Battery	2
1.3 Removing the Battery	2
1.4 Inserting a SIM Card.....	2
1.5 Inserting a TF Card	3
1.6 Charging	4
2.1 Powering On/Off the iData 50	5
2.2 Locking and Unlocking the iData 50.....	5
2.3 Keys	5
2.4 Home Screen.....	6
2.5 Status Icons and Indicators	6
2.6 Basic Settings	7
3 Call Function	12
3.1 Making a Call	12
3.2 Contacts.....	12
3.3 SMS and MMS.....	13
3.4 Email	14
4 Network Connection and Connection Synchronization	16
4.1 GPRS Data Connection	16
4.2 Wi-Fi Network Connection	17
4.3 Bluetooth	17
4.4 GPS.....	19
4.5 Connecting the iData 50 to a PC	19
4.6 Synchronization.....	20
5 Enabling the Scan Function	21
5.1 To start the iScan program and enable scanning, do as follows:	21
6 Enabling the NFC Function	22
6.1 To enable the NFC function, do as follows.....	22
7 Managing the iData 50	23
7.1 Installing Applications	23
7.2 Uninstalling Applications	23
7.3 Managing Applications	24
8 Precautions and Troubleshooting	25
8.1 Precautions	25
8.2 Troubleshooting.....	26
Appendix	29

1 Introduction

1.1 Appearance of iData 50

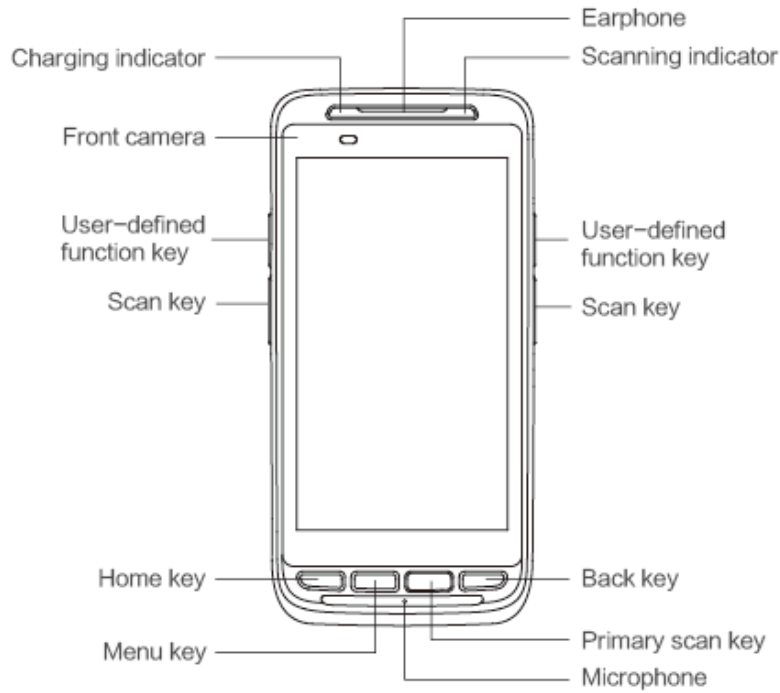

Figure 1-1 Front view of iData 50

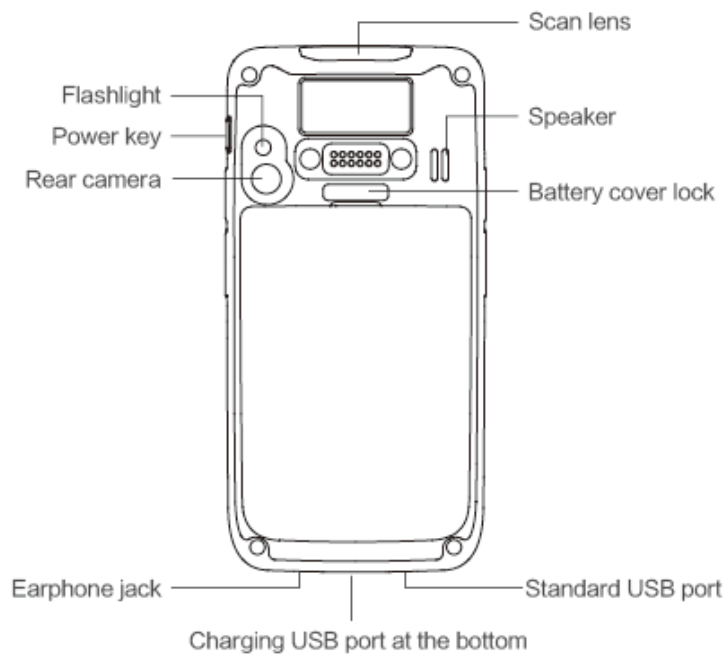
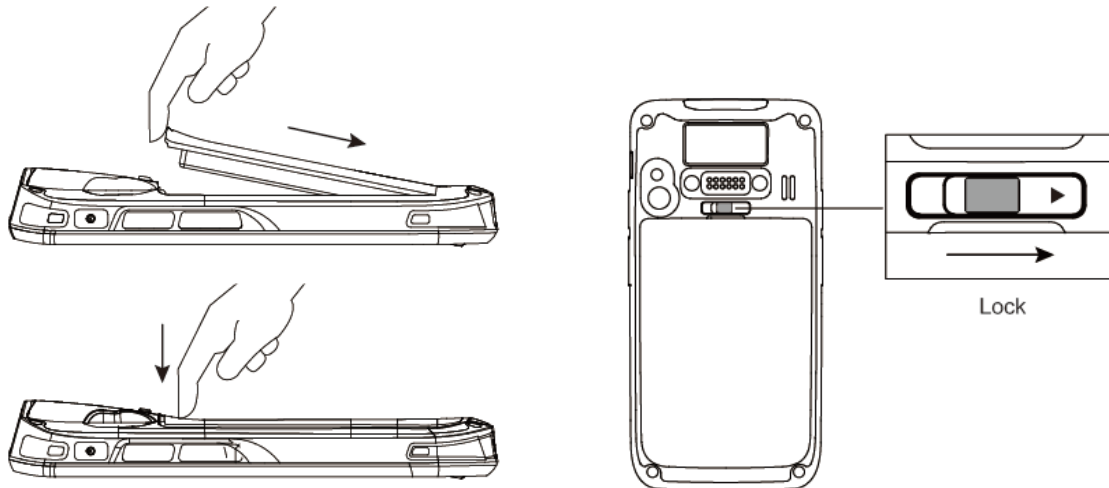

Figure 1-2 Rear view of iData 50

1.2 Installing the Battery

1. Push the battery to the bottom of the battery compartment and press it downwards.
2. Push the battery cover lock to the right to lock the battery cover.



1.3 Removing the Battery

1. Push the battery cover lock to the left.
 2. Pull up the battery cover from the groove at the upper end of the battery cover.
- (Note: The iData 50 adapts integrated design for the battery and battery cover.)

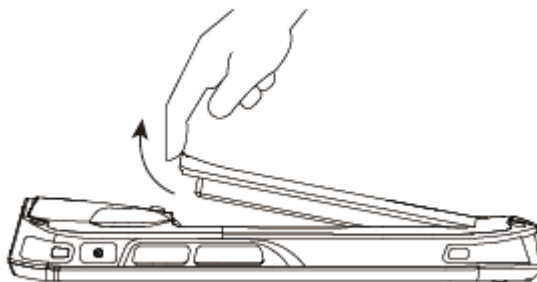

1.4 Inserting a SIM Card

1. Insert a SIM card by following the direction in the figure below.
- (Note: Micro SIM cards are applicable to the iData 50. After replacing a SIM card, restart the iData 50.)

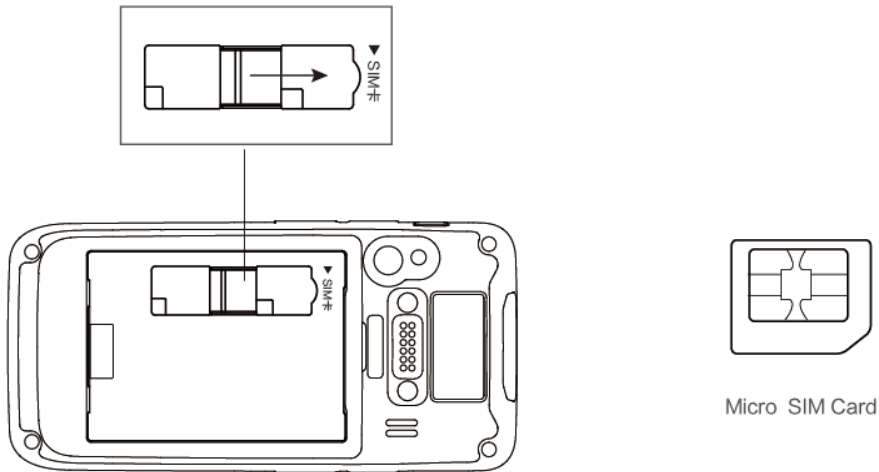

1.5 Inserting a TF Card

1. Push the card cover by following the OPEN direction marked on the card cover.
2. Open the card cover upwards and insert a TF card, as shown in the figure below.

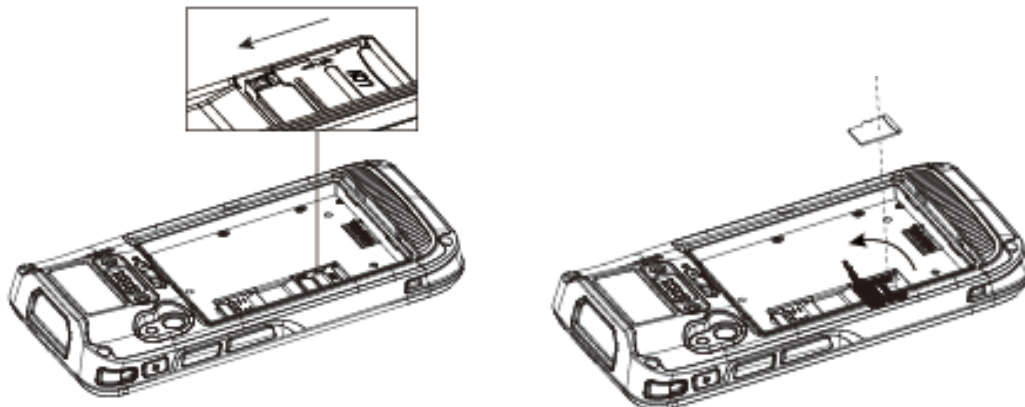

3. Close the card cover, as shown in the figure below.
4. Pull back the card cover by following the LOCK direction marked on the card cover.
(Note: TF cards, namely Micro SD cards, are applicable to the iData 50. After replacing a TF card, restart the iData 50.)

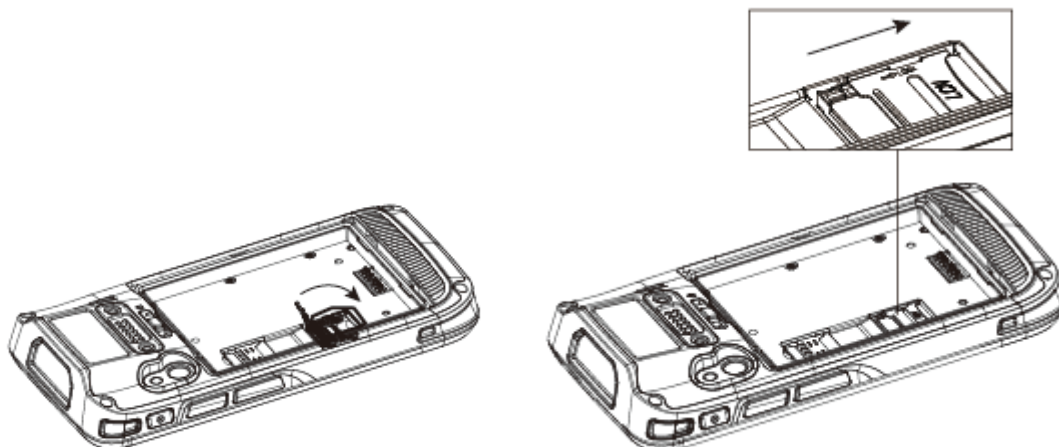

1.6 Charging

You can charge a battery in the following ways:

1. Bottom charging cable;
2. 1-slot charging & communication stand (to be purchased separately).



Bottom charging cable



1-slot charging & communication stand

Description of charging indicator:

When the battery is in the charging status, the charging indicator is in red.

When the battery is fully charged, the charging indicator is in green.

When the battery volume is low,

- (1) a message indicating that the battery volume is less than 20% is displayed on the screen.
- (2) the iData 50 gives out a low battery prompt tone.
- (3) the charging indicator blinks in red.

★ Tips



- ◆ The following operations help obtain a longer standby duration of the iData 50.
- ◆ Shorten the time to sleep by selecting Settings > Display > Sleep.
- ◆ Set the screen brightness to a small value by selecting Settings > Display > Brightness.

Disable functions that are not frequently used, for example, GPS, Bluetooth, Wi-Fi and 3G communication.

2 Using the iData 50

2.1 Powering On/Off the iData 50

After installing a SIM card and a battery and charging the iData 50 completely, you can use the iData 50.

1. To power on the iData 50, press the On/Off key  on the right for some time. The iData 50 vibrates, displays the startup screen and enters the Android OS after the guide progress is complete. It takes some time for the iData 50 to initialize. Please wait patiently.
2. To power off the iData 50, press the On/Off key on the right  for some time. A dialog box that provides shutdown options is displayed. Click **Power Off**.

2.2 Locking and Unlocking the iData 50

Locking the iData 50

Press the On/Off key  momentarily to lock the iData 50. If you do not perform any operation for the iData 50 within the default locking time, the iData 50 is automatically locked.

Unlocking the iData 50

Press the On/Off key  momentarily and slide the unlock key to the right on the screen.



2.3 Keys

The iData 50 provides a physical keypad that consists of four keys, as shown in the figure below.

On the physical keypad of the iData 50, keys are respectively home key, menu key, scan key, and back key from left to right.

Home key: used to go back to the home screen.

Menu key: used to show menus.

Scan key: used to scan.

Return key: used to return to the previous operation screen.



2.4 Home Screen

By default, the iData 50 has one home screen. You can add home screens by placing applications to the home screen and slide to the left or right to switch to another home screen. On the home screen, click the icon of any application to open the application.

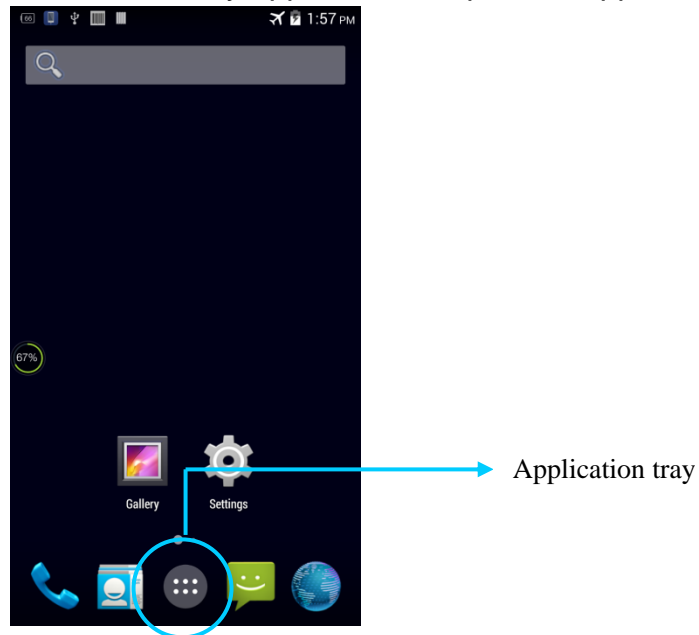

















★ Tips

- ◆ You can freely add or delete the icon of an application in the blank of the home screen.
- ◆ If you click the application tray, all applications can be viewed.

2.5 Status Icons and Indicators

Status icons and indicators are in the status bar at the upper part of the screen and show device status and notifications.

Table 2-1 Status icons

Icon	Description	Icon	Description
	WLAN		Signal strength
	Bluetooth		Flight mode
	USB connection		Network access restricted
	Missed calls		USB debugging
	New messages		Charging
	Modem logs		Battery full
	Silent mode		Multiple notification icons, which are beyond the scope of display
	Application permission		EDGE
	Connection between USB and PC pea pod		

★ Note

As software is upgraded continuously, status indicators may be different from those displayed on the iData 50. The actual status indicators prevail.

2.6 Basic Settings

2.6.1 Date and Time Settings

To change the date and time in the iData 50, do as follows:

1. Find the following icon.



2. Select **Settings > Date & time > Set date or Set time.**

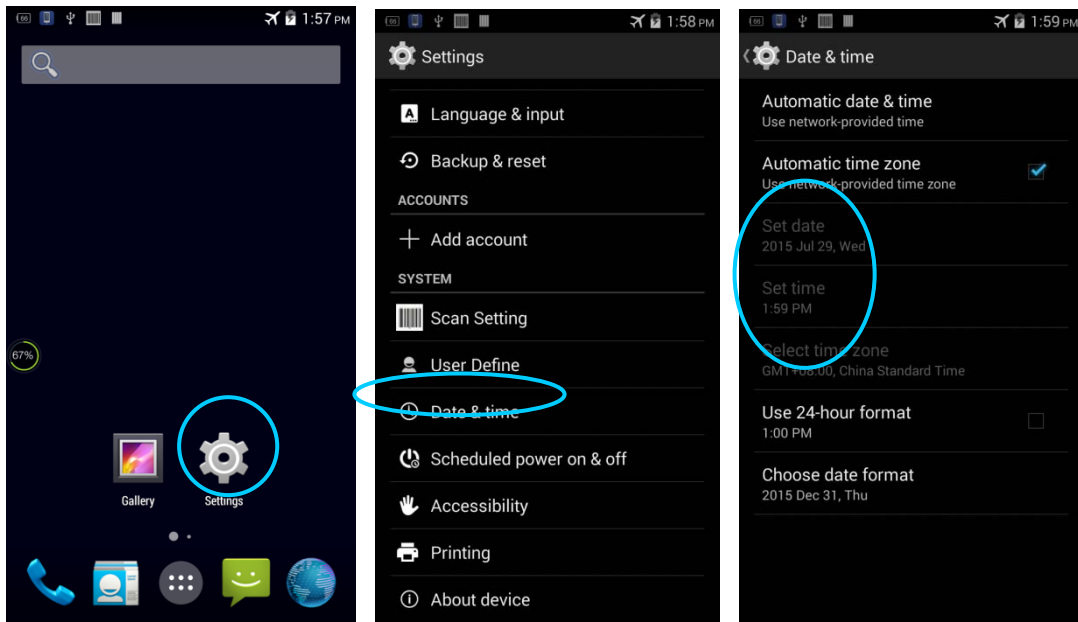

2.6.2 Display Setting

1. Find the following icon.



2. Select **Settings > Display > Lock screen notification/Wallpaper/Brightness/Auto-rotate screen/Sleep/Interactive screensaver/Font size/Cast screen.**

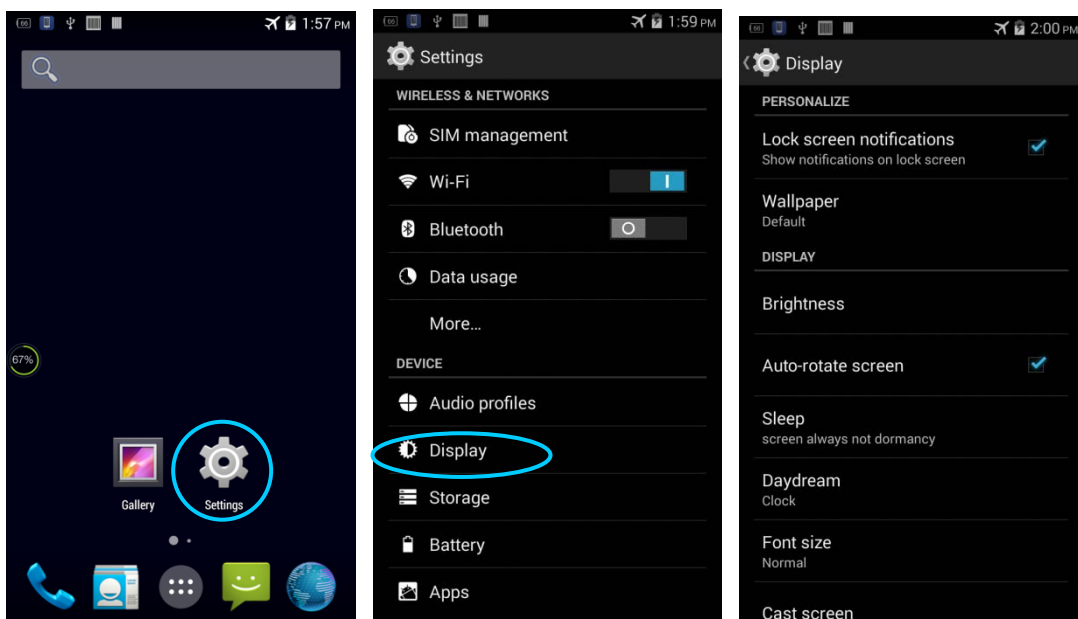

2.6.3 Ringtone Setting

1. Find the following icon.



2. Select **Settings > Audio profiles > General/Silent/Meeting/Outdoor**. Click different modes and set the ringtone in the modes.

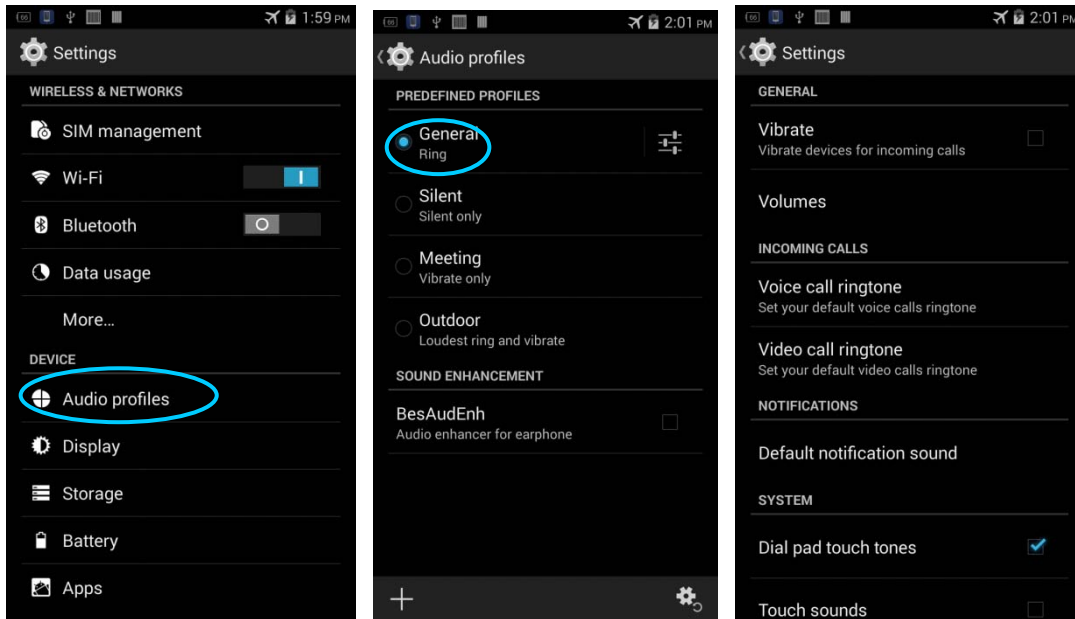

2.6.4 Security Setting

1. Find the following icon.



2. Select **Settings > Backup & reset > Factory data reset**.

The iData 50 starts to restore factory settings.

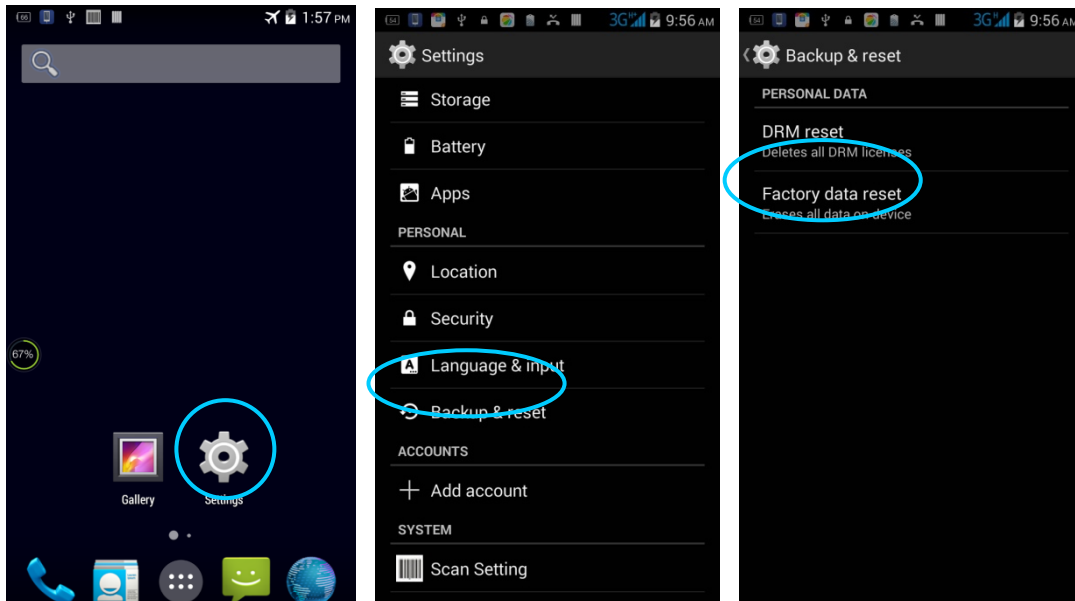

★ Caution

If you perform the preceding operation, the following data will be cleared:

- ♦ Account
- ♦ Data and settings of the system and applications
- ♦ Downloaded applications

The following data will not be cleared:

- ♦ Current system software and bound applications
- ♦ Files in the SD card, for example, music and photos

2.6.5 Language and Input Method Setting

1. Find the following icon.



2. Select **Settings** > **Language & input**, click **Language**, select a language, click **Default**, and select an input method.

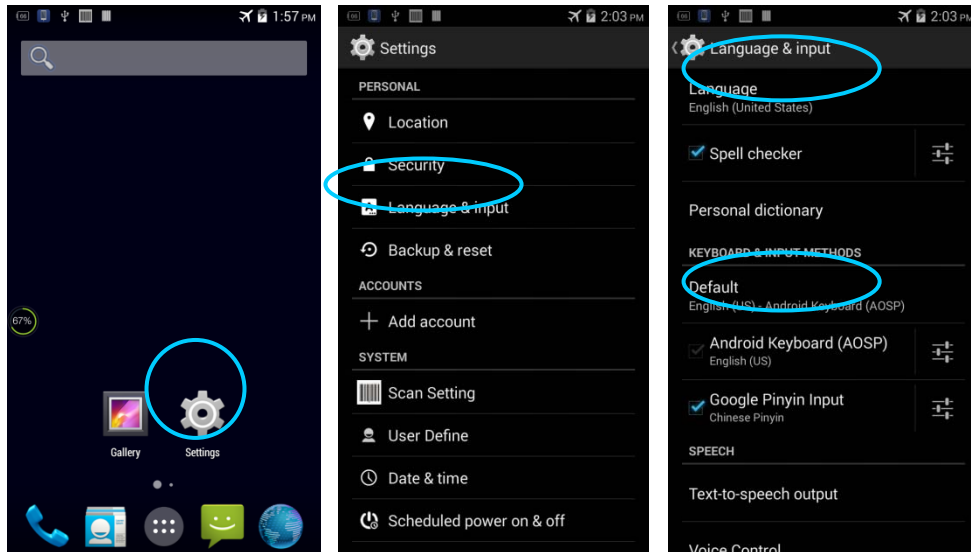

2.6.6 Shortcuts

You can add shortcut icons on the home screen of the iData 50.

On the home screen, click the icon of application tray, press and hold an icon and drag it to the home screen.

2.6.7 Widgets

You can add widgets such as clock, music player and calendar on the home screen of the iData 50.

On the home screen, press and hold a blank space. The entry for setting wallpaper and widgets is displayed. Click a widget and drag it to a blank space.

Click the icon of a widget to open the widget.





3 Call Function

3.1 Making a Call

1. Find the following icon.



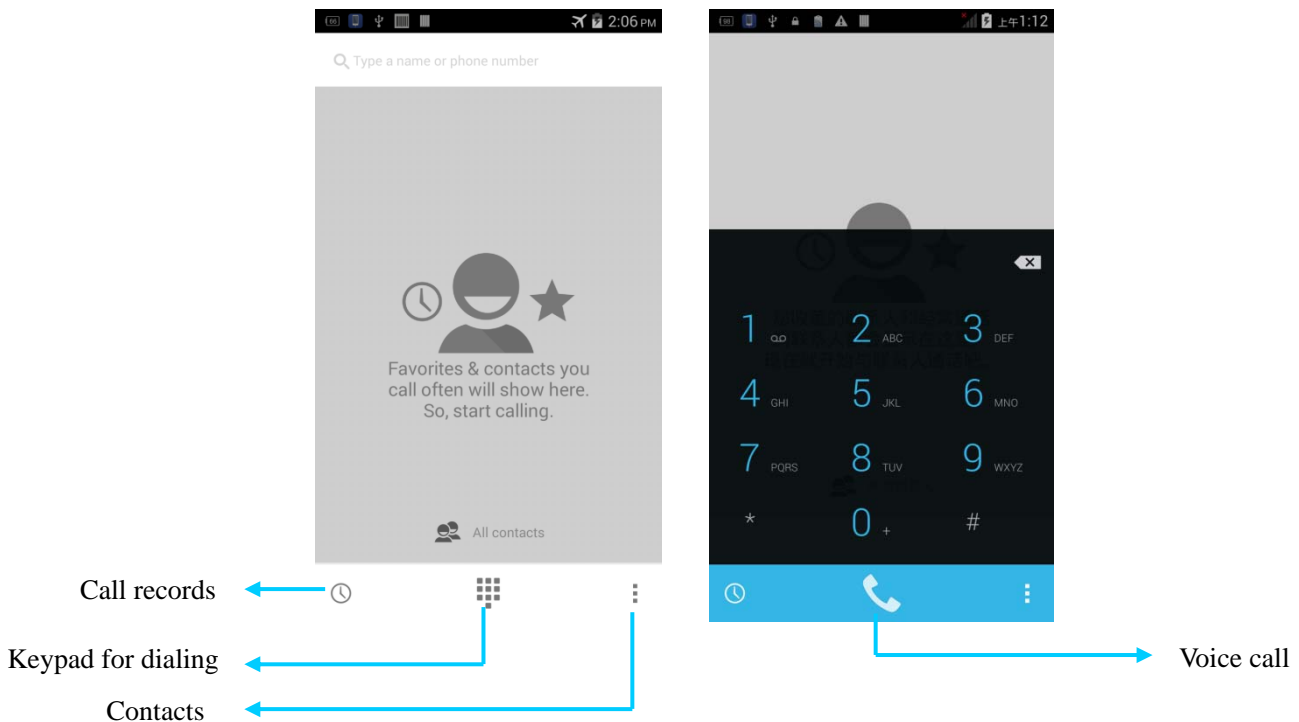

2. Enter a phone number.
3. Click  to make a call.
4. Click  to terminate the call.

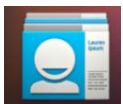

3.2 Contacts

1. Find the following icon.



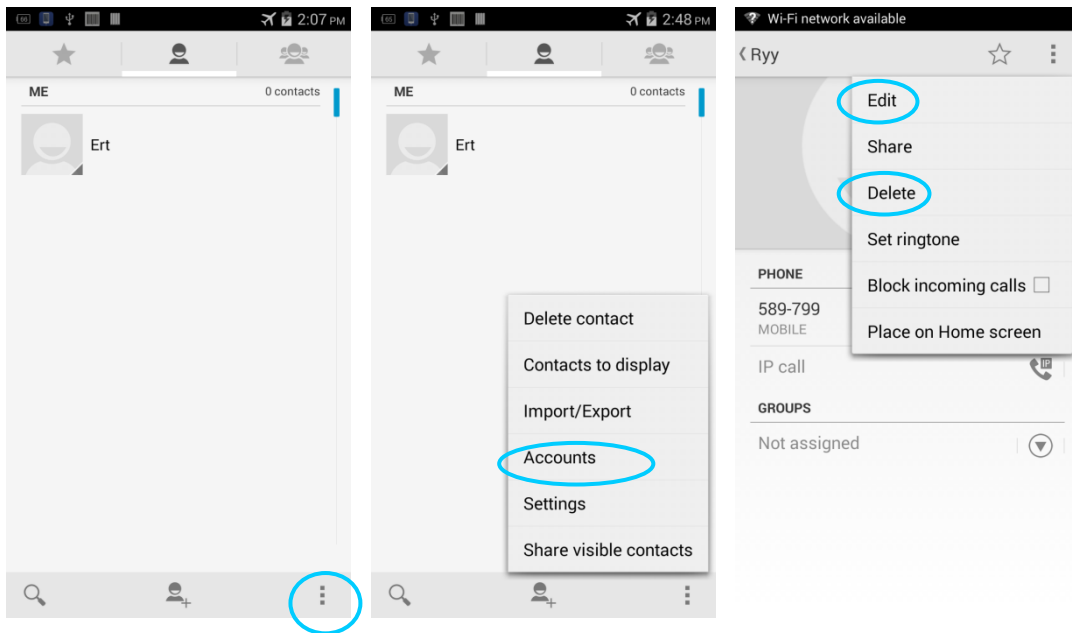

2. Click **Contacts** to open the list of contacts.
3. To add a contact, click .
4. To import or export contacts, press the menu key and click **Import/Export**.
5. To edit or delete a contact, select the contact, press the menu key and click **Edit/Delete**.



3.3 SMS and MMS

1. Find the following icon.



2. Click  enter a receiver and text to be sent.
3. Click  to send the message.
4. On the message editing page, press the menu key, click **Add subject** to convert the message into a multimedia message. After editing the message, click  to send the message.

★ Tips

Click  to add attachments such as photo, video and audio.

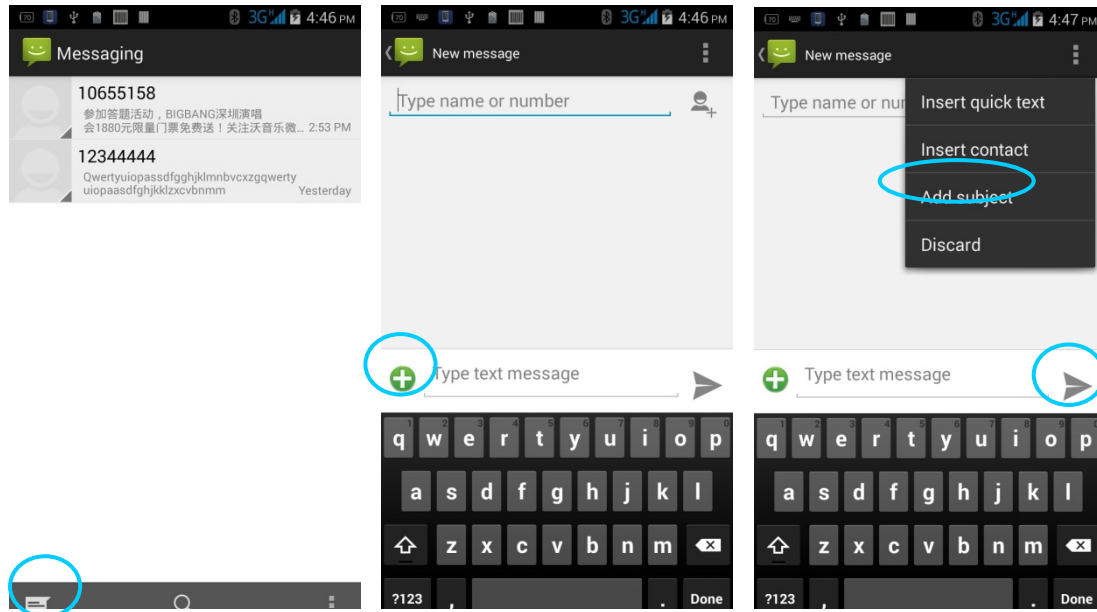

3.4 Email

You can send or receive emails.

★ Note

To create an email account on the iData 50, first set the account on a PC. Take a QQ email account as an example. Log in to the QQ email account, click **Settings** in the upper right corner of the email account page, find and select the server option and inbox option and then save. The email account is set.

To set an email account on the iData 50, do as follows:

1. Find the following icon.



2. Enter an email address and password and click **Next**.
3. Set **Inbox checking frequency** and click **Next**.
4. Create a name for the account and click **Next**. The email receiving page is displayed.

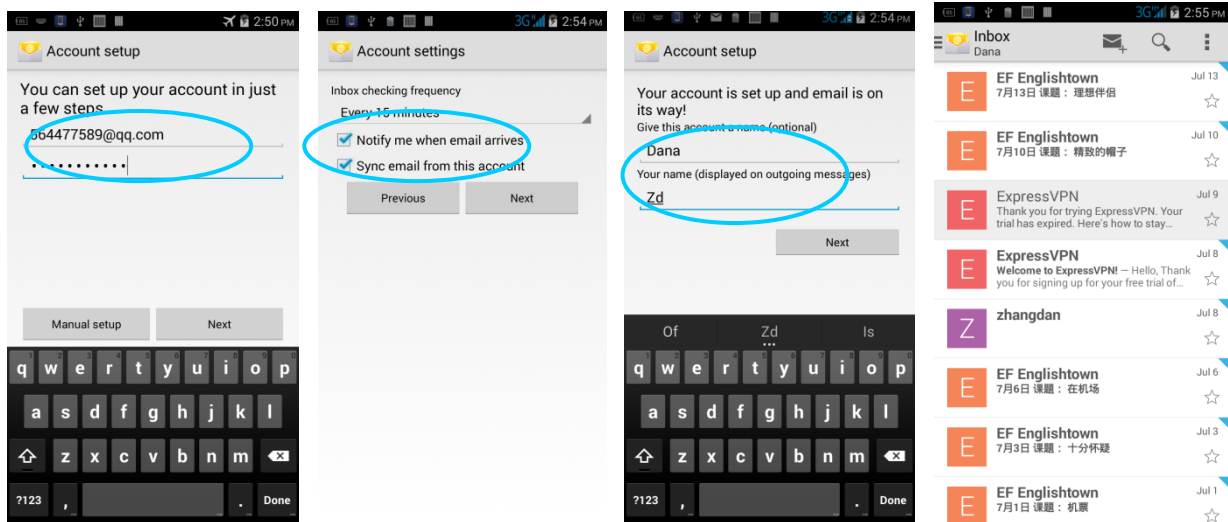

To synchronize or delete an account, do as follows:

1. On the home screen, click **Settings**.
2. Under the **ACCOUNTS** option, click **POP3** to open added accounts and click the name of an account to be synchronized or deleted. On the **Sync** page, click  in the upper right corner and select **Sync now** or **Remove account**.

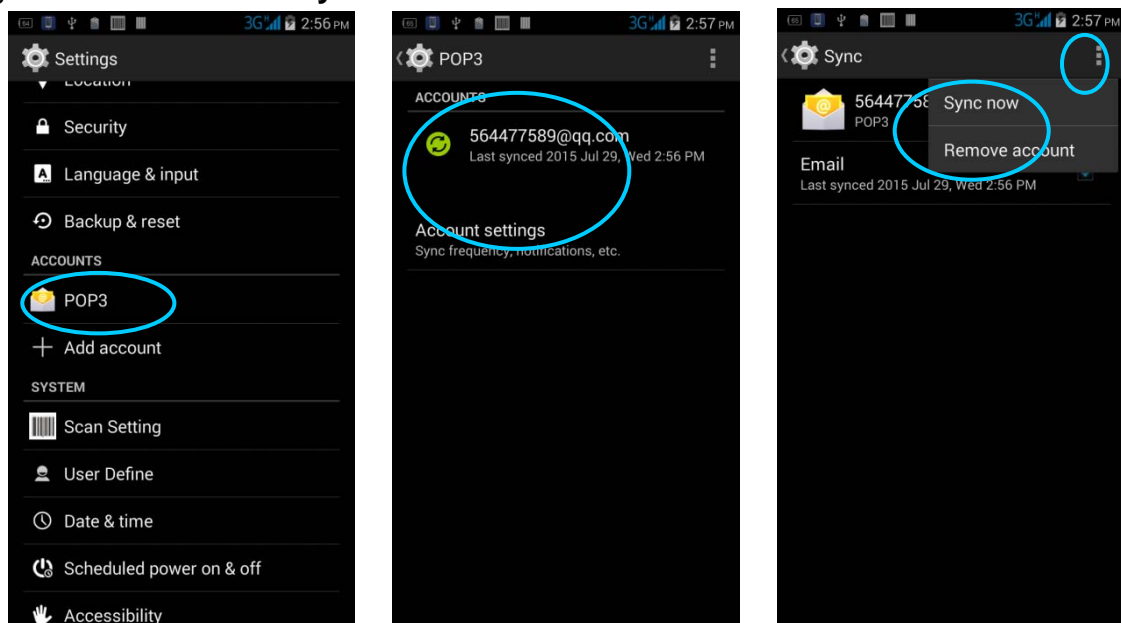

4 Network Connection and Connection Synchronization

4.1 GPRS Data Connection

After a GPRS data connection is established, you can access the Internet. To establish a GPRS data connection, ensure that a SIM card is installed in the iData 50. In general, the Internet access configuration is set on the iData 50. If you delete the default configuration by accident, you can set the network by performing the following steps (take the network of China Unicom as the example):

1. Find the following icon.



2. Select **Settings > More > Mobile network > APN > China Unicom 3G Network**.

Then set the following items:

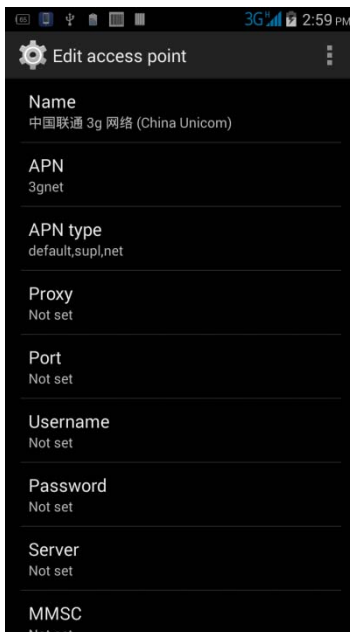

Name: China Unicom 3G network

APN: 3gnet

APN type: default, supl, net

Proxy: not set

Port: not set

Username: not set

Password: not set

Server: null

MMSC: not set

MMSC: not set

MMS port: not set

MCC: 460

MNC: 01

Authentication type: not set

APN protocol: IPv4

Enable/disable APN: APN enabled

Bearer system: not set

4.2 Wi-Fi Network Connection

1. Find the following icon.



2. Select **Settings > WIRELESS & NETWORKS > WLAN**.
3. Click **Enable/disable WLAN**. The iData 50 starts to search for networks. If WLAN is enabled, click **Scan**. The iData 50 lists networks in the range of search.
4. Click a network and enter the password in the dialog box that is displayed.
5. Click **Connect**. The Wi-Fi connection is completed.

Click to enable Wi-Fi and search for networks

Click to connect the network

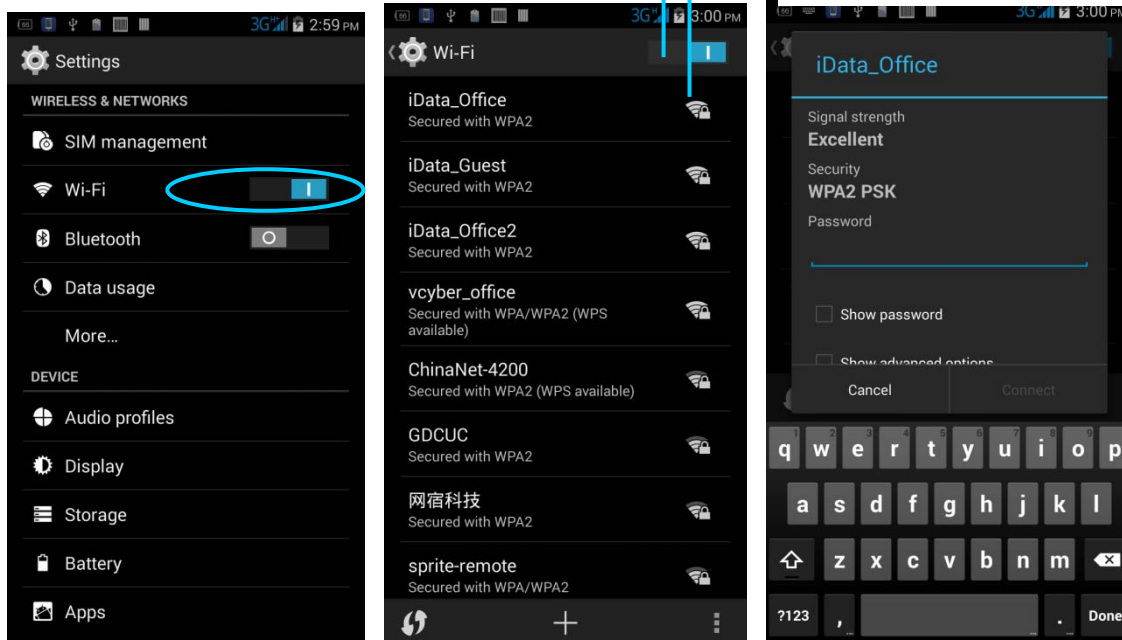

4.3 Bluetooth

After you enable the Bluetooth function on the iData 50, you can establish wireless connections with other Bluetooth devices such as computers and mobile phones. In the scope without solid obstacles, the effect of Bluetooth connections is good.

1. Find the following icon.





2. Select **Setting > WIRELESS & NETWORKS > Bluetooth**.
3. Click the icon for enabling/disabling Bluetooth to enable Bluetooth and search for other Bluetooth devices.
4. In the list of searched devices, click a device to pair the device.

5. In the dialog box that is displayed, confirm the PIN and click **Pair** to connect the device.

Click to make other devices able to detect the device

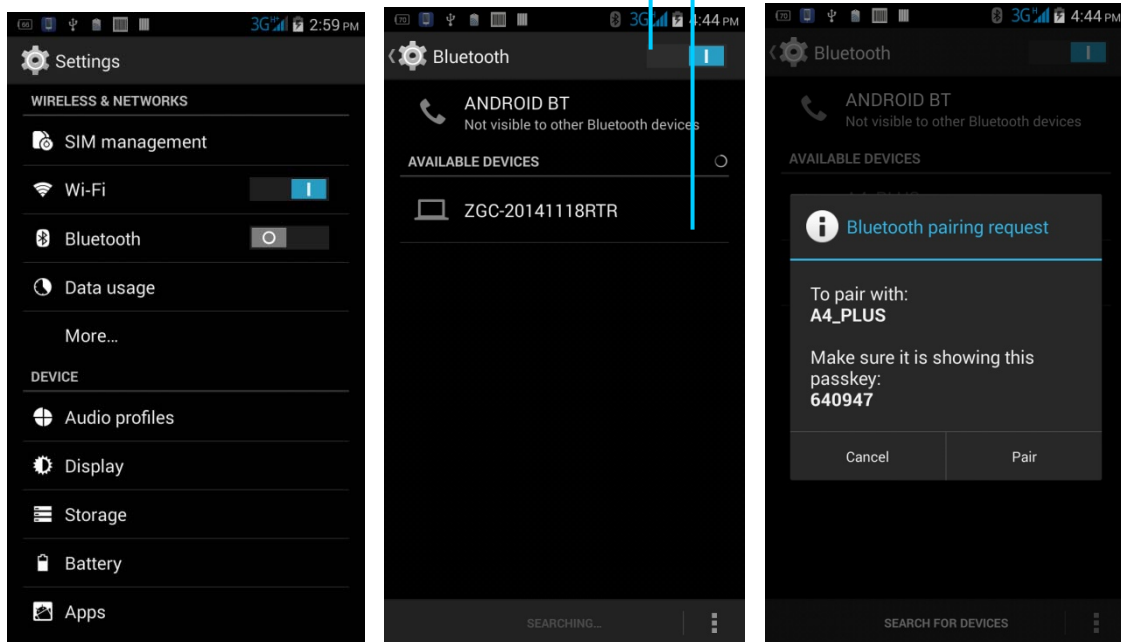
Click to enable Bluetooth and search for Bluetooth devices



6. Click  on the right of a paired device. The **Rename**, **Unpair** and **Internet access** options are displayed. Perform operation as required.

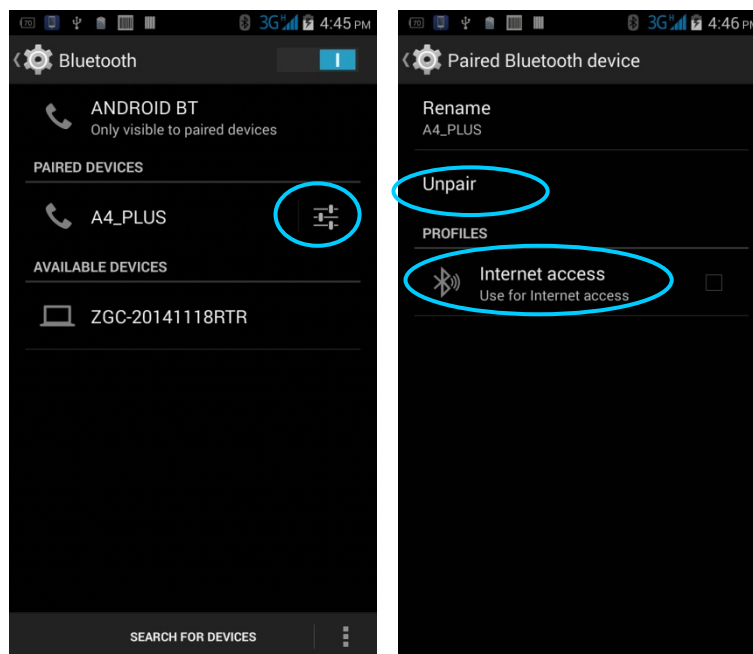

★ Caution

- ◆ Ensure that the device to be connected to the iData 50 has enabled the Bluetooth function and Bluetooth visibility.
- ◆ During the connection process, set and pair the PIN. The iData 50 does not support connection without a password.

4.4 GPS

The iData 50 is equipped with a high-performance navigation chip and can quickly and accurately obtain position information. iData provides a GPS positioning demonstration program GPS Test. Before using GTS positioning, install the demonstration program. You can download navigation software in HiMarket (for details about how to install GPS navigation software and information about HiMarket, see 6.1 “Installing Programs”) and view position information.

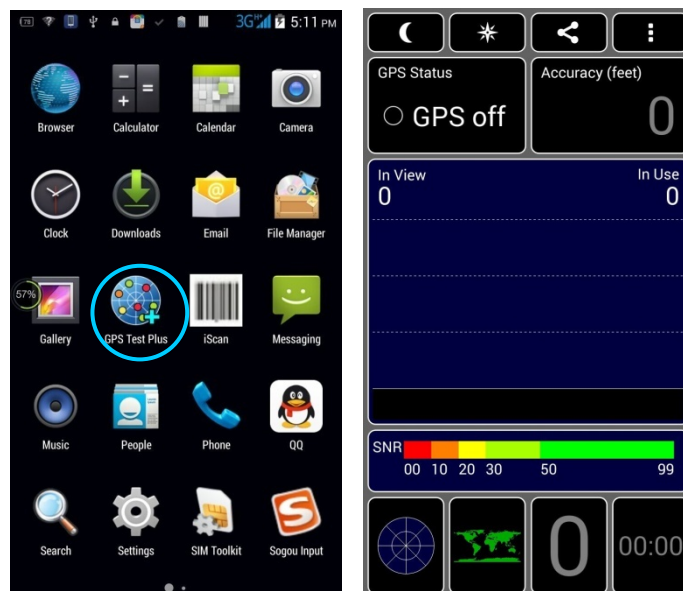

4.5 Connecting the iData 50 to a PC

Connect the iData 50 to a PC by using a USB data cable so that you can transmit and process files such as photo, video and music files between the memory card of the iData 50 and the PC.

1. Connect the device to a USB port of the PC by using a USB data cable.
2. The status bar of the iData 50 displays the USB connection icon. Slide downwards the status bar. The USB connection status can be viewed and the USB connection mode can be selected.

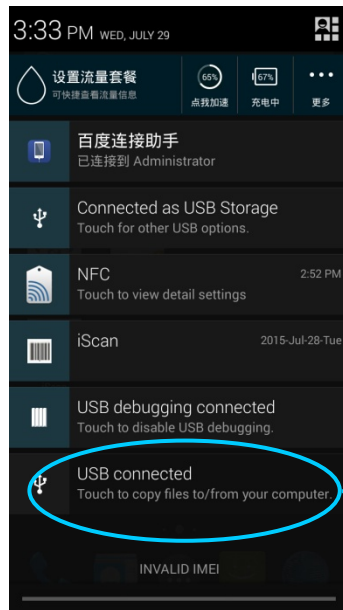

Click the option to open the USB storage device and copy files between the PC and the device

4.6 Synchronization

1. Find the following icon.



2. Select **Settings > Accounts & sync**.
3. Click **Add account** to set a new account.
4. Select **Company** or **Email**, enter the email address and password, click **Next** and wait until the connection is complete (for details about email setting, see 3.4 “Email”).
5. Click **Accounts**. On the synchronization setting page, perform setting as required.

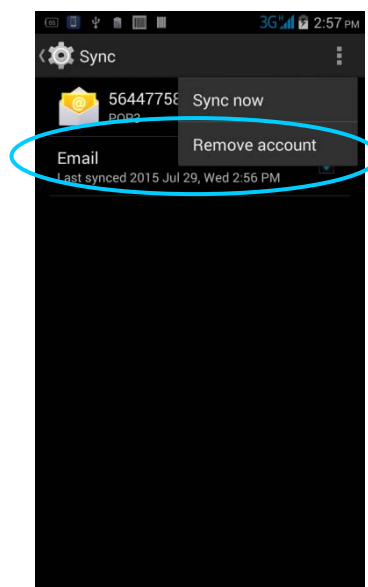

5 Enabling the Scan Function

5.1 To start the iScan program and enable scanning, do as follows:

1. Click the iScan icon on the menu page.
2. Click the blue slider on the right of Enable Barcode Scanning to enable the scanning function (if you click the slider again, the scanning function is disabled).
3. Press the yellow key to scan a barcode. When the scanning indicator becomes green from red and a beep is heard, the barcode is scanned successfully.

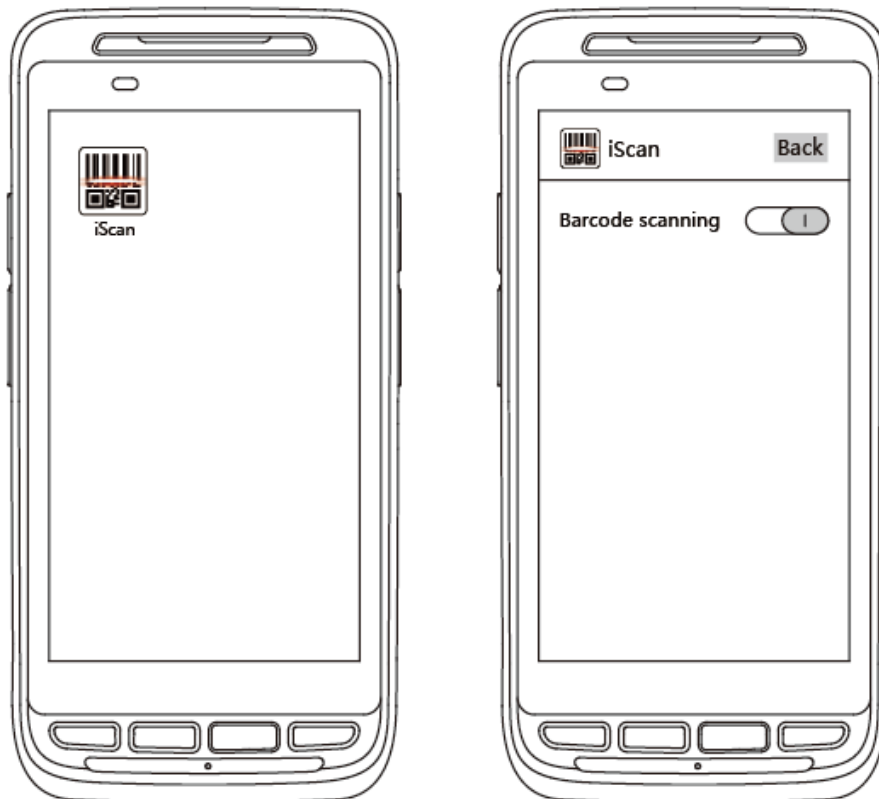

Note: iScan is used to scan barcodes. By default, iScan is installed and scanning is enabled upon delivery of the device. You can download the latest version from the following address: <http://t.cn/8k5hWCo>

6 Enabling the NFC Function

6.1 To enable the NFC function, do as follows

1. Click the Settings icon on the menu page.
2. Select WIRELESS & NETWORKS/More > NFC.
3. Click the blue slider on the right to enable NFC (if you click the blue slider again, NFC is disabled).
4. Put an NFC card close to the back of the iData 50. After a beep is heard, the card is read successfully.

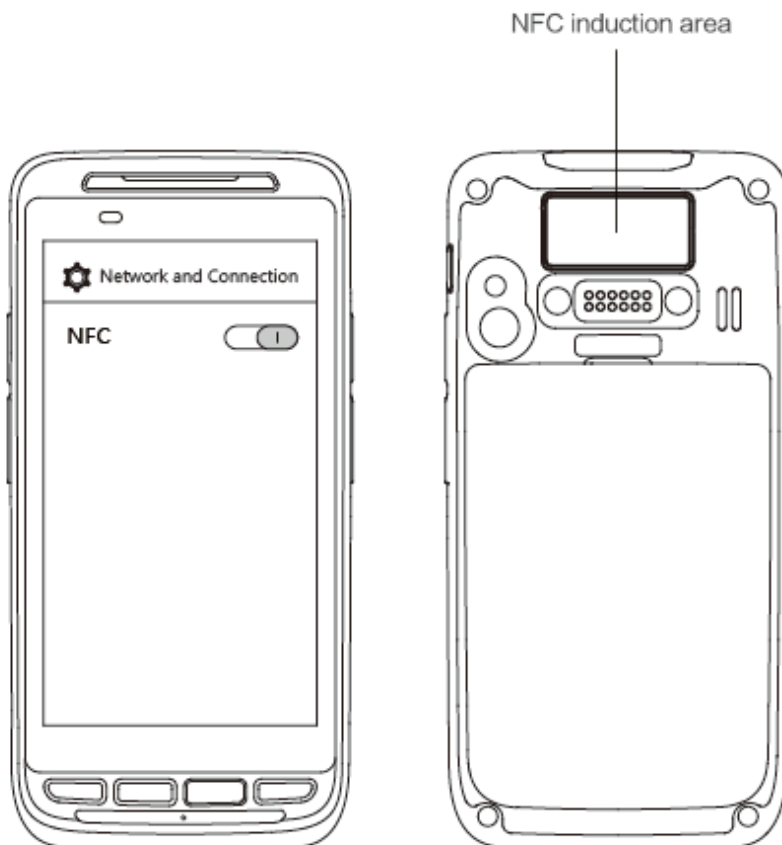

7 Managing the iData 50

7.1 Installing Applications

The iData 50 uses Google Android OS, where the suffix of Android software is apk. To install programs on the iData 50, use the following methods:

1. Download software at the online software store (Google Play) provided by Google or on the Android software download platform (HiMarket) available in China and install software. HiMarket is recommended.
2. Download software installation packages, store them on the SD card and install the software through file manager.
3. Connect the iData 50 to a PC by using a USB data cable and install software for the iData 50 on the PC. However, first of all, you need to install phone assistant software such as APK install, pea pod and phone assistant 91. In this way, programs can be installed in batches.

7.2 Uninstalling Applications

If too many programs are installed or some programs are unnecessary, uninstall programs to improve the running speed of the iData 50. To uninstall a program, do as follows:

1. Select **Settings > App**. In the application list that is displayed, select an application and click it. On the page for uninstalling the application, click **Uninstall** and then click **OK**. Wait several seconds until the application is uninstalled.
2. Click the application tray. On the application screen, find the icon of an application, press and drag the icon to the dustbin to uninstall the application.

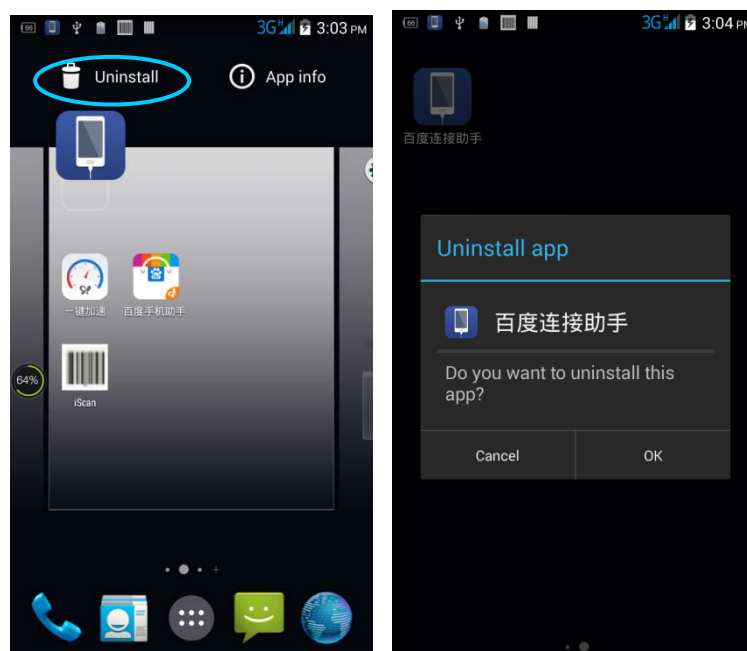

7.3 Managing Applications

Select **Settings > App**. On the application management screen, you can view application status in the options such as Downloaded, SD Card and Running, click an application, access the application information screen, and perform operations such as forcibly stopping, uninstalling and stopping an application.

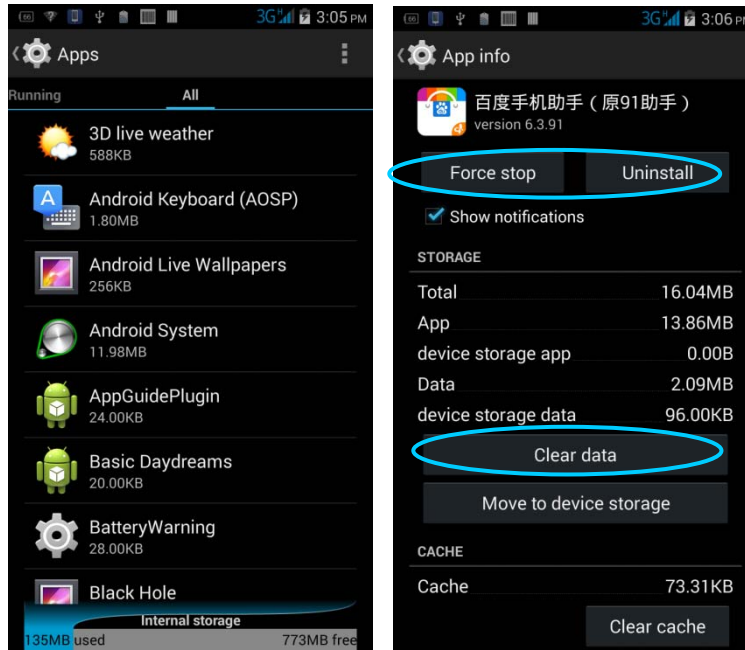

8 Precautions and Troubleshooting

8.1 Precautions

To ensure that the iData 50 does not fail, follow the following precautions during use of the iData 50:

- ♦ Put the iData 50 and its components and accessories in the places where children cannot reach.
- ♦ Keep the iData 50 dry. Rain, moisture and liquid contain acidic materials and will corrode the circuit board.
- ♦ Do not store or use the iData 50 in dusty or dirty places.
- ♦ Do not store the iData 50 in a place that is too hot. High temperature will shorten the service life of electronic components.
- ♦ Do not store the iData 50 in a place that is too cold. When the temperature inside the iData 50 rises, moisture is generated inside the iData 50, which may damage the circuit board.
- ♦ Do not try to disassemble the iData 50. Otherwise, the iData 50 may be damaged.
- ♦ Do not touch the screen surface of the iData 50 by using a pen, a pencil or other sharp articles in case the screen may be scratched.
- ♦ Do not throw, beat or violently collide the iData 50. Otherwise, the components of the iData 50 may be damaged and the iData 50 may be faulty.
- ♦ Do not use strong chemical products or strong detergent to clean the iData 50. If the iData 50 become dirty, clean the surface of the iData 50 by using a soft cloth soaked with dilute glass detergent.
- ♦ Please use the protective film to reduce wear as much as possible. The screen protective film can improve the availability and durability of the screen.

Pay attention to the following during use of the battery.

- ♦ The area where the iData 50 is charged must keep away from scraps, inflammables or chemical substances.
- ♦ When you charge the battery of a mobile device, the temperature on the battery and charger must be in the range 0°C to 40°C.
- ♦ Do not use incompatible batteries or chargers, which may cause fire, explosion, leakage or other hazards.
- ♦ Do not disassemble, press, twist, pierce or cut the battery.
- ♦ Do not make the battery short-circuited or contact the connecting terminal of the battery by using metal or other conductive objects.
- ♦ Do not insert other materials into the battery, contact the battery with water or other liquid, or expose the battery in an open fire, explosive source or other sources of danger.
- ♦ Do not put or store the battery in the environment where the temperature is too high.
- ♦ Do not put the battery in a microwave oven or a drying machine.

- ♦ Do not put the battery into a fire.
- ♦ If the battery leaks, do not let the liquid stain your skin or eyes. Otherwise, wash your skin or eyes with lots of water and go to see the doctor immediately.

Cleaning iData 50

- ♦ Shell
Clean the shell by using a cloth soaked with alcohol, including keys and space between keys.
- ♦ Display screen
You can clean the display screen by using a cloth soaked with alcohol. Do not let the liquid gather around the screen. Otherwise, dry the screen by using a soft non-woven cloth in case strip marks are left on the screen.
- ♦ Scan lens
Clean the scan lens regularly by using lens paper or other articles suitable for cleaning optical materials.

8.2 Troubleshooting

Table 8-1 iData 50 troubleshooting

Fault	Cause	Solution
After the power key is pressed, the iData 50 is not powered on.	The battery volume is too low or the battery is not charged.	Charge the battery or replace the battery.
	The battery is incorrectly installed.	Correctly install the battery.
	The system breaks down.	Restore factory settings.
The rechargeable battery can no longer be charged.	The battery fails.	Replace the battery.
	The temperature of the battery is too high or low.	Put the battery in normal temperature.
During data communication, data is not transmitted or transmitted data is incomplete.	The cable configuration is incorrect.	Consult the system administrator.
	The communication software is incorrectly installed or configured.	Install or reinstall the synchronization software to update the driver.
The relevant function is not activated after a user clicks a button or icon.	The system does not respond.	Restart the system.
No sound can be heard.	The volume is too low or is disabled.	Adjust the volume.
The iData 50 is closed.	The iData 50 is in the inactive state.	After being inactive for a period of time, the iData 50 is locked.
	The battery is used up.	Replace the battery.
The iData responds at a	Too many files are stored in	Remove unused memos and records. If

Fault	Cause	Solution
low speed.	the iData 50.	necessary, save the records on the host or increase the storage capacity by using an SD card.
	Too many applications are installed on the iData 50.	Remove applications installed on the iData 50.
The iData 50 cannot decode a barcode while reading it.	The scan application is not loaded.	Load the scan application in the iData 50.
	Reading a barcode fails.	Check that the barcode is indefective.
	The battery volume is low.	If the scanner stops sending out a light beam after you press the trigger switch, check the battery volume.

Table 8-2 Bluetooth troubleshooting

Fault	Cause	Solution
The iData 50 cannot detect any Bluetooth device nearby.	The iData 50 system is too far away from other Bluetooth devices.	Move the iData 50 close to other Bluetooth devices, making the distance between them within 10 meters.
	The Bluetooth devices nearby are not enabled.	Enable the Bluetooth devices you are searching for.
	Bluetooth devices are in a mode that cannot be detected.	Set Bluetooth devices in a mode that can be detected.
When a user attempts to connect a Bluetooth phone to the iData 50, the Bluetooth phone identifies the iData 50 as the previously paired iData 50.	The Bluetooth phone memorizes the name and address of the iData 50 paired previously over Bluetooth.	Remove the paired device and the name from the Bluetooth phone.
A Bluetooth device can be detected but cannot be connected.	The iData 50 does not support connecting a Bluetooth device without a password.	Set a password for the Bluetooth device.

Table 7-3 Cable troubleshooting

Fault	Cause	Solution
Charging fails.	The cable is in poor contact.	Replace the cable.
Connecting to the iData 50 fails.	The cable is in poor contact.	Replace the cable.

Table 7-4 Wi-Fi troubleshooting

Fault	Cause	Solution
Connecting to an AP fails.	The message "Authentication failed" is displayed.	The password for the WLAN device is incorrect.

Appendix

Table 1 Accessories of the iData 50

Component	Description
iData 50	
Standard battery	
Power adapter	Used to charge the battery.
Bottom charging cable	
Hand strap	
Package	
USB data cable	Used to communicate with the iData 50 or charge the iData 50.
Instructions	
Warranty card	
One-slot USB charging base	Optional
Silicon protective sleeve	Optional

Table 2 Technical specifications of the iData 50

Item	iData 50
System configuration	
CPU	High-performance quad-core 1.3 GHz processor
Operating System	Android 5.1
Memory	8 GB ROM+1 GB RAM
Expansion Slot	Micro SD card, up to 32 GB
Display	4.7- inch, 1280 x 720 High resolution
Touch Panel	Industrial-grade capacitive touch panel (supporting operation with gloves)
Camera (Optional)	8 MXP camera in the back side, autofocus lens, LED flash
Exit Window	Corning® Gorilla® glass
Keypad	4 front keys, 4 side keys , Power key
Battery	3.7 V 3300 mAh rechargeable lithium polymer battery
Audio	Built-in microphone /Mini USB/Headphone connector
Notification	Vibrator alerts/LED/Audio notification
Vibration Motor	Built-in programmable vibration motor
Structure parameters	
Dimensions (L x W x D)	150 mm x 73.5 mm x 16 mm (24 mm thick at the head)
Weight	230g (including battery)
Communication and transmission	
Wireless WAN (Network frequency)	North America:GSM-Quad band support (Band 5/8/3/2) UMTS/HSPA+ Primary bands 2/5. Roaming bands 8. LTE Bands 2/4/5/17 .

Item	iData 50
	Europe: GSM - Quad band support (Band 5/8/3/2) UMTS Primary bands 1/8. Roaming bands 2/5. LTE Bands 1/3/7/8/20
Wireless WAN (Data service)	GPRS/ EDGE/WCDMA/ FDD-LTE
Wireless LAN	Wi-Fi 802.11a/b/g/n (Dual-band Wi-Fi: 2.4G+5G)
Bluetooth	Bluetooth 4.0
GPS (optional)	Supporting GPS/AGPS/Glonass
Operating environment	
Development tool	Android SDK+JDK+Eclipse
Supported language	Java
Operating Temp.	-10°C ~ 50°C (14°F to 122°F)
Storage Temp.	-20°C ~ 60°C (-4°F to 140°F)
Humidity	0 to 95% (non-condensing)
Drop specification	Multiple drops to cement ground from a distance of 1.2m
Sealing standard	IP65
ESD	± 15 kV air discharge, ±8 kV direct discharge
1D laser scanning engine	
Optical resolution	≥ 4 mil
Scan depth of field	3.81 cm to 60.98 cm
Scanning angle	47±3° (standard)
Scanning speed	102±12 times per second (two-way)
1D/2D image scanning engine	
Optical resolution	≥ 3 mil
Scanning angle	Omni-directional
Scanning speed	300 times per second
NFC	
Frequency	13.56 MHz
Reading distance	Within 10 mm
Communication protocol	ISO14443A/14443B/15693,
Input/output port	
USB Port	1 (Micro USB port)
Charger Port	1 (Charging interface at the bottom)
Headset Port	1

Power Adapter:

1.Manufacturer: SHENZHEN FUJIA APPLIANCE CO.,LTD.

Model: FJ-SW1260502000UN

Input: AC 100-240V; 50/60Hz;0.4Amax

Output: DC5.0V;2000mA

2.Manufacturer: SHENZHEN FUJIA APPLIANCE CO.,LTD.

Model: FJ-SW1202000N

Input: AC 100-240V; 50/60Hz;0.6Amax

Output: DC12.0V;2000mA

Battery:

Manufacturer:WUXI IDATA TECHNOLOGY COMPANY LTD.

Model: 1ICP9/65/85

Capacity:3300 mAh 12.2Wh

Nominal Voltage:DC 3.7V

Maximum Charge Voltage:DC 2.4V

CE marking:**CAUTION**

RISK OF EXPLOSION IF BATTERY IS REPLACED BY AN INCORRECT TYPE. DISPOSE OF USED BATTERIES ACCORDING TO THE INSTRUCTIONS.



To prevent possible hearing damage, do not listen at high volume levels for long periods.

Fully understand user manual before use.

Ensure your player at low volume levels or power off before you leaving.

© 2015 Wuxi iData Technology Company Ltd. All Rights Reserved.

This document is prepared by Wuxi iData Technology Company Ltd. according to the existing information. The content in this document is subject to update without notice.

Without written approval of Wuxi iData Technology Company Ltd., no one shall copy, extract, back up, modify, spread, or translate any part of this document in any form or method or use the whole or part of this document for business purposes.

If you have any question, you are free to send an email to idata@idatachines.com.

FCC Caution.

§ 15.19 Labelling requirements.

This device complies with part 15 of the FCC Rules. Operation is subject to the condition that this device does not cause harmful interference.

§ 15.21 Information to user.

Any Changes or modifications not expressly approved by the party responsible for compliance could void the user's authority to operate the equipment.

§ 15.105 Information to the user.

Note: This equipment has been tested and found to comply with the limits for a Class B digital device, pursuant to part 15 of the FCC Rules. These limits are designed to provide reasonable protection against harmful interference in a residential installation. This equipment generates uses and can radiate radio frequency energy and, if not installed and used in accordance with the instructions, may cause harmful interference to radio communications. However, there is no guarantee that interference will not occur in a particular installation. If this equipment does cause harmful interference to radio or television reception, which can be determined by turning the equipment off and on, the user is encouraged to try to correct the interference by one or more of the following measures:

- Reorient or relocate the receiving antenna.
- Increase the separation between the equipment and receiver.
- Connect the equipment into an outlet on a circuit different from that to which the receiver is connected.
- Consult the dealer or an experienced radio/TV technician for help.

Specific Absorption Rate (SAR) information:

This **NEW MOBILE COMPUTER** meets the government's requirements for exposure to radio waves. The guidelines are based on standards that were developed by independent scientific organizations through periodic and thorough evaluation of scientific studies. The standards include a substantial safety margin designed to assure the safety of all persons regardless of age or health.

FCC RF Exposure Information and Statement The SAR limit of USA (FCC) is 1.6 W/kg averaged over one gram of tissue. Device types: **NEW MOBILE COMPUTER (FCC ID: 2ADE3IDATA50A)** has also been tested against this SAR limit. The highest SAR value reported under this standard during product certification for use at the **ear is 0.577 W/Kg** and when properly worn on the body is **1.311 W/Kg**. This device was tested for typical body-worn operations with the back of the handset kept **10mm** from the body. To maintain compliance with FCC RF exposure requirements, use accessories that maintain a **10mm** separation distance between the user's body and the back of the handset. The use of belt clips, holsters and similar accessories should not contain metallic components in its assembly. The use of accessories that do not satisfy these requirements may not comply with FCC RF exposure requirements, and should be avoided.

Body-worn Operation

This device was tested for typical body-worn operations. To comply with RF exposure requirements, a minimum separation distance of **10mm** must be maintained between the user's body and the handset, including the antenna. Third-party belt-clips, holsters, and similar accessories used by this device should not contain any metallic components. Body-worn accessories that do not meet these requirements may not comply with RF exposure requirements and should be avoided. Use only the supplied or an approved antenna.