

UB+
EUPHO E2
QUICK START GUIDE
MODEL : M5

1

CONGRATULATIONS

You are now the owner of a UB+ EUPHO E2 Speaker. The UB+ EUPHO E2 Speaker incorporates the best elements of traditional speaker design and the latest audio technology, to create a large size speaker, that is suited for wireless devices in this age of mobility.

This quick guide is meant to be a simple introduction to the usage of the speaker. The full manual can be downloaded from the UB+ website (ub-plus.com/images/Files/EUPHO_E2-User_Manual.pdf) or by scanning the QR code below.



Please contact us if you have any comments or questions.

   [ubplussg](https://www.ub-plus.com)
www.ub-plus.com



2

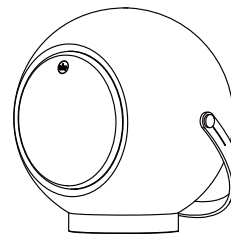

WHAT'S IN THE BOX

- UB+ EUPHO E2 Speaker
- Quick start guide
- USB cable
- Tabletop base
- Leather strap

FEDERAL COMMUNICATIONS COMMISSION REGULATORY INFORMATION (FCC)

This device complies with Part 15 of the FCC Rules. Operation is subject to the following two conditions:(1) this device may not cause harmful interference, and (2) this device must accept any interference received, including interference that may cause undesired operation.

NOTE: This equipment has been tested and found to comply with the limits for a Class B digital device, pursuant to part 15 of the FCC Rules. These limits are designed to provide reasonable protection against harmful interference in a residential installation.

3

ASSEMBLE

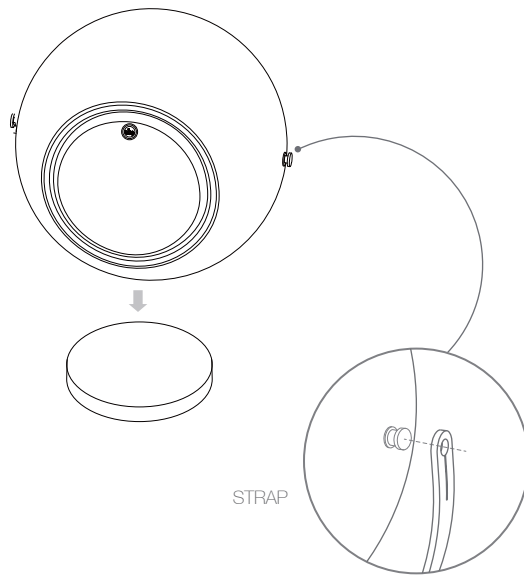

CONTROLS

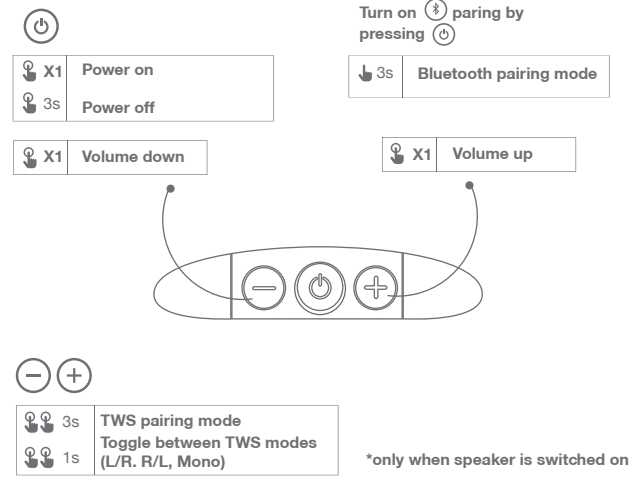

5

PORTS

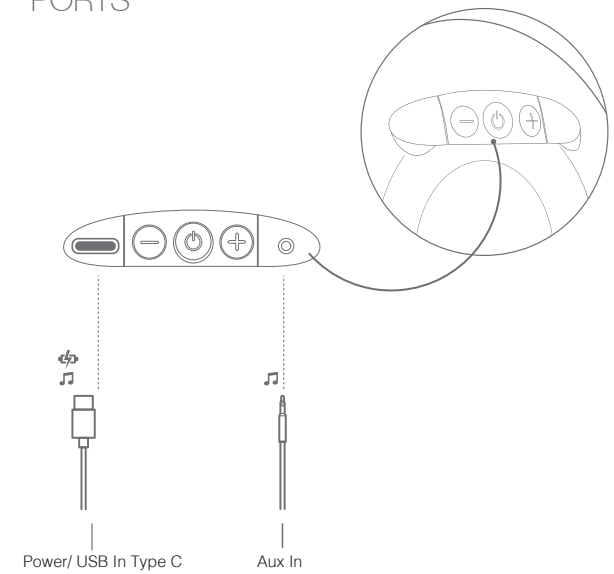

6

BASIC FUNCTIONS

SWITCHING ON AND OFF

Press the Power button  to turn the speaker on.
Press and hold the Power button to turn the speaker off.



BLUETOOTH PAIRING WITH DEVICE

Press and hold the Power button  for the speaker to enter into Bluetooth pairing mode.

There will be a sound feedback “pairing” from the speaker when pairing is successful.

Note: The last paired device will be connected to the speaker automatically if it is available, after the EUPHO E2 Lite is switched on.

TRUE WIRELESS STEREO (TWS) PAIRING BETWEEN TWO EUPHO E2 Lite SPEAKERS

1. Press and hold both the Volume down button  and the Volume up button  together and the speaker will go into TWS pairing mode.
2. The paired speakers would be paired automatically to each other if there are in proximity to each other.

IMPORTANT SAFETY INSTRUCTIONS

1. The product (including relevant accessories), DO NOT expose under direct sunlight over a long period of time.
2. Operating temperature between 0-50℃.
3. Install the product according to the instruction against hazard to your body due to fall over.
4. Pay attention to the cables between equipments against stumble hazard.
5. The product is not a toy, please keep it away from Kids.
6. Use only the external power supply provided with the product or the standard USB ports certified according to IEC60950-1 as Limited power source.
7. Product with Lithium batteries, please keep far away excessive heat such as direct sunshine, fire, heatsink or the like.
8. No user replace parts inside the product.
9. Don't open the enclosure in case of electric shock hazard.
10. Don't use wet hands to handle the product.
11. Clean the product with a soft, dry cloth only.
12. Unplug the DC power if smoke, abnormal sound, abnormal smell, excessive heat or fire occur.
13. Any abnormal phenomenon, please inform your local importer or local after sales service office.
14. Once the product out of service, please handle the waste according to the local regulations.

IMPORTANT SAFETY INSTRUCTIONS

Additional Warning for Battery (pack)

1. Lithium-ion batteries used in the product may expose fire or explosion hazards if misuse.
2. Batteries shall not be exposed to excessive heat or fire in case of explosion.
3. Don't handle leaking or damaged batteries.
4. Dispose of used batteries according to local regulation correctly.

重要安全说明

- 警告：请按照说明书要求固定和放置产品，注意不当的摆放可能会被碰倒造成砸伤危险
- 警告：请使用规定的外部直流电源，外部直流电源满足 IEC60950-1 LPS要求
- 警告：防止进水造成内部电池短路引起爆炸或起火危险
- 警告：远离火源或直射阳光；内含电池禁止将产品或电池投入明火，会引起爆炸危险
- 警告：请按照当地法规处理电子废弃物和电池
- 警告：不要给小孩子作为玩具当连接外部接线，请原理走道，防止绊倒和产品跌落造成的危险

This equipment generates uses and can radiate radio frequency energy and, if not installed and used in accordance with the instructions, may cause harmful interference to radio communications. However, there is no guarantee that interference will not occur in a particular installation.

If this equipment does cause harmful interference to radio or television reception, which can be determined by turning the equipment off and on, the user is encouraged to try to correct the interference by one or more of the following measures:

- Reorient or relocate the receiving antenna.
- Increase the separation between the equipment and receiver.
- Connect the equipment into an outlet on a circuit different from that to which the receiver is connected.
- Consult the dealer or an experienced radio/TV technician for help.

Changes or modifications not expressly approved by the party responsible for compliance could void the user's authority to operate the equipment.



ub-plus.com