FCC Test Report

Report No.: AGC01883140704FE04

FCC ID : 2ACZFHHRT4
APPLICATION PURPOSE : Original Equipment
PRODUCT DESIGNATION : evoLution
BRAND NAME : evoLution Series
MODEL NAME : HHRT4
CLIENT : Olive Bay Pty Ltd.
DATE OF ISSUE : Sep. 23, 2014
STANDARD(S) : FCC Part 15 Rules
REPORT VERSION : V1.0

Attestation of Global Compliance (Shenzhen) Co., Ltd



CAUTION:

This report shall not be reproduced except in full without the written permission of the test laboratory and shall not be quoted out of context.



Report Revise Record

Report Version	Revise Time	Issued Date	Valid Version	Notes
V1.0	/	Sep. 23, 2014	Valid	Original Report

TABLE OF CONTENTS

1. VERIFICATION OF CONFORMITY	5
2. GENERAL INFORMATION	6
2.1. PRODUCT DESCRIPTION	6
2.2. TABLE OF CARRIER FREQUENCYS	6
2.3. TEST STANDARDS	7
2.4. RELATED SUBMITTAL(S) / GRANT (S)	7
2.5. TEST METHODOLOGY	7
2.6. SPECIAL ACCESSORIES	7
2.7. EQUIPMENT MODIFICATIONS	7
3. MEASUREMENT UNCERTAINTY	8
4. DESCRIPTION OF TEST MODES	8
5. SYSTEM TEST CONFIGURATION	9
5.1. CONFIGURATION OF EUT SYSTEM	9
5.2. EQUIPMENT USED IN EUT SYSTEM	9
5.3. SUMMARY OF TEST RESULTS	9
6. TEST FACILITY	10
7. 15.203 - ANTENNA REQUIREMENT	11
7.1. STANDARD APPLICABLE	11
7.2. TEST RESULT	11
8. PEAK OUTPUT POWER	12
8.1. MEASUREMENT PROCEDURE	12
8.2. TEST SET-UP (BLOCK DIAGRAM OF CONFIGURATION)	13
8.3. LIMITS AND MEASUREMENT RESULT	14
9. 6DB BANDWIDTH	16
9.1. MEASUREMENT PROCEDURE	16
9.2. TEST SET-UP (BLOCK DIAGRAM OF CONFIGURATION)	16
9.3. LIMITS AND MEASUREMENT RESULTS	17
10. CONDUCTED SPURIOUS EMISSION	19
10.1. MEASUREMENT PROCEDURE	19
10.2. TEST SET-UP (BLOCK DIAGRAM OF CONFIGURATION)	19
10.3. MEASUREMENT EQUIPMENT USED	19
10.4. LIMITS AND MEASUREMENT RESULT	19
11. MAXIMUM CONDUCTED OUTPUT POWER SPECTRAL DENSITY	26
11.1 MEASUREMENT PROCEDURE	26

- 11.2 TEST SET-UP (BLOCK DIAGRAM OF CONFIGURATION) 26
- 11.3 MEASUREMENT EQUIPMENT USED 26
- 10.4 LIMITS AND MEASUREMENT RESULT 26
- 12. RADIATED EMISSION 29**
 - 12.1. MEASUREMENT PROCEDURE 29
 - 12.2. TEST SETUP 30
 - 12.3. LIMITS AND MEASUREMENT RESULT 31
 - 11.4. TEST RESULT 31
- 13. BAND EDGE EMISSION 44**
 - 13.1. MEASUREMENT PROCEDURE 44
 - 13.2. TEST SET-UP 44
 - 13.3. TEST RESULT 45
- 14. FCC LINE CONDUCTED EMISSION TEST 46**
 - 14.1. LIMITS OF LINE CONDUCTED EMISSION TEST 46
 - 14.2. BLOCK DIAGRAM OF LINE CONDUCTED EMISSION TEST 46
 - 14.3. PRELIMINARY PROCEDURE OF LINE CONDUCTED EMISSION TEST 47
 - 14.4. FINAL PROCEDURE OF LINE CONDUCTED EMISSION TEST 47
 - 14.5. TEST RESULT OF LINE CONDUCTED EMISSION TEST 48
- APPENDIX A: PHOTOGRAPHS OF TEST SETUP 50**
- APPENDIX B: PHOTOGRAPHS OF EUT 51**

1. VERIFICATION OF CONFORMITY

Applicant	Olive Bay Pty Ltd.
Address	PO Box 139, Chatswood, NSW, Australia, 2067
Manufacturer	Olive Bay Pty Ltd.
Address	PO Box 139, Chatswood, NSW, Australia, 2067
Product Designation	evoLution
Brand Name	evoLution Series
Test Model	HHRT4
Date of test	Sep. 09,2014 to Sep. 22,2014
Deviation	None
Condition of Test Sample	Normal
Report Template	AGCRT-US-BGN/RF (2013-03-01)

We hereby certify that:

The above equipment was tested by Attestation of Global Compliance (Shenzhen) Co., Ltd. The test data, data evaluation, test procedures, and equipment configurations shown in this report were made in accordance with the procedures given in ANSI C63.4 (2003) and the energy emitted by the sample EUT tested as described in this report is in compliance with requirement of FCC Part 15 Rules requirement.

Tested By :



Bart Xie

Sep. 23, 2014

Reviewed By :



Kidd Yang

Sep. 23, 2014

Approved By:



Solger Zhang

Sep. 23, 2014

2. GENERAL INFORMATION

2.1. PRODUCT DESCRIPTION

The EUT is designed as “repeater device”. It is designed by way of utilizing the DSSS technology to achieve the system operation.

A major technical description of EUT is described as following

Operation Frequency	2405.00-2480.00MHz, (Channel Number: 16, Channel Frequency=2405+5(K-1), K=1, 2, 3 16)
RF Output Power	14.04dBm(Max)
Channel Spacing	5MHz
Modulation	OQPSK
Number of channels	16
Hardware Version	V1.0
Software Version	N/A
Antenna Designation	Integrated Antenna
Antenna Gain	1.0dBi (Max.)
Power Supply	DC3.6V by (1/2 AA lithium Battery)

2.2. TABLE OF CARRIER FREQUENCIES

Frequency Band	Channel Number	Frequency
2400~2483.5MHZ	0	2405MHZ
	1	2410MHZ
	:	:
	8	2440 MHZ
	9	2445 MHZ
	10	2450 MHZ
	:	:
	14	2475 MHZ
	15	2480 MHZ

2.3. TEST STANDARDS

The EUT was operated in the engineering mode to fix the TX frequency that was for the purpose of the measurements.

According to FCC's request, Test Procedure KDB558074 is required to be used for this kind of FCC 15.247 digital modulation device.

The following report of is prepared on behalf of the Attestation of Global Compliance Co., Ltd. in accordance with FCC Part 15, Subpart C, and section 15.203, 15.205, 15.207, 15.209 and 15.247 of the Federal Communication Commission rules.

The objective is to determine compliance with FCC Part 15, Subpart C, and section 15.203, 15.205, 15.207, 15.209 and 15.247 of the Federal Communication Commission rules.

Maintenance of compliance is the responsibility of the manufacturer. Any modification of the product, which result in lowering the emission/immunity, should be checked to ensure compliance has been maintained.

2.4. RELATED SUBMITTAL(S) / GRANT (S)

This submittal(s) (test report) is intended for **FCC ID: 2ACZFHRT4** filing to comply with the FCC Part 15 requirements.

2.5. TEST METHODOLOGY

Both conducted and radiated testing was performed according to the procedures in ANSI C63.4 (2003).

Radiated testing was performed at an antenna to EUT distance 3 meters.

Others testing (listed at item 5.3) was performed according to the procedures in FCC Part 15.247 rules.

The equipment under test (EUT) was configured to measure its highest possible emission level. The test modes were adapted accordingly in reference to the Operating Instructions. The EUT was tested in all three orthogonal planes and the worse case was showed.

2.6. SPECIAL ACCESSORIES

Refer to section 5.2.

2.7. EQUIPMENT MODIFICATIONS

Not available for this EUT intended for grant.

Attestation of Global Compliance (Shenzhen) Co., Ltd.

2/F., Building 2, No.1-No.4, Chaxi Sanwei Technical Industrial Park, Gushu, Xixiang, Bao'an District, Shenzhen, Guangdong, China

The test site is constructed and calibrated to meet the FCC requirements in documents ANSI C63.4: 2003.

FCC register No.: 259865

3. MEASUREMENT UNCERTAINTY

Conducted measurement: +/- 2.75dB

Radiated measurement: +/- 3.2dB

4. DESCRIPTION OF TEST MODES

4. DESCRIPTION OF TEST MODES

No.	TEST MODES
1	2405MHZ TX
2	2440MHZ TX
3	2480MHZ TX
Note: Above 3 modes have performed at maximum emission conditions.3 axis have been tested and only the worst mode data recorded in the test report.	

Note:

1. The EUT has been set to operate continuously on the lowest, middle and highest operation frequency individually.
2. All modes under which configure applicable have been tested and the worst mode test data recording in the test report, if no other mode data.
3. For Radiated Emission, 3axis were chosen for testing for each applicable mode.

5. SYSTEM TEST CONFIGURATION

5.1. CONFIGURATION OF EUT SYSTEM

Configure: (Control continuous TX through PC)

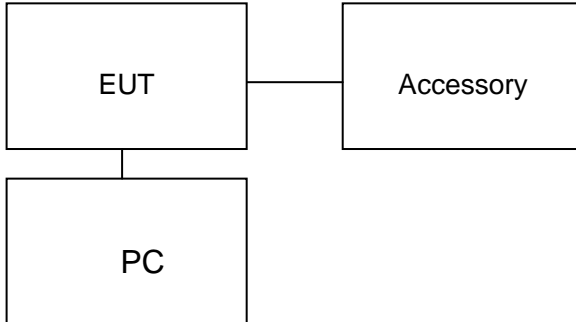

5.2. EQUIPMENT USED IN EUT SYSTEM

Item	Equipment	Model No.	ID or Specification	Remark
1	evoLution	HHRT4	HHRT4	EUT
3	Laptop	Dell	INSPIRON	A.E

Note: All the accessories have been used during the test in conduction emission test.

5.3. SUMMARY OF TEST RESULTS

FCC RULES	DESCRIPTION OF TEST	RESULT
§15.203	Antenna Requirements	Compliant
§15.247	Peak Output Power	Compliant
§15.247	6dB Bandwidth	Compliant
§15.247	Conducted Spurious Emission	Compliant
§15.247	Maximum Conducted Output Power SPECTRAL Density	Compliant
§15.209	Radiated Emission	Compliant
§15.247	Band Edges	Compliant
§15.207	Line Conduction Emission	Compliant

6. TEST FACILITY

Site	Attestation of Global Compliance (Shenzhen) Co., Ltd
Location	2/F., Building 2, No.1-No.4, Chaxi Sanwei Technical Industrial Park, Gushu, Xixiang, Bao'an District, Shenzhen, Guangdong, China
Description	The test site is constructed and calibrated to meet the FCC requirements in documents ANSI C63.4:2003.

ALL TEST EQUIPMENT LIST

Description	Manufacturer	Model	S/N	Cal. Date	Cal. Due
Power Probe	R&S	NRP-Z23	100323	07/25/2014	07/24/2015
RF attenuator	N/A	RFA20db	68	N/A	N/A
Spectrum Analyzer	Agilent	E4440A	US41421290	07/25/2014	07/24/2015
EXA Signal Analyzer	Agilent	N9020A	MY52091009	06/20/2014	06/19/2015
Amplifier	EM	EM30180	0607030	02/27/2014	02/26/2015
Horn Antenna	EM	EM-AH-10180	67	04/19/2014	04/18/2015
Horn Antenna	A.H. Systems Inc.	SAS-574	--	07/25/2014	07/24/2015
EMI Test Receiver	Rohde & Schwarz	ESCI	100694	07/25/2014	07/24/2015
Biological Antenna	A.H. Systems Inc.	SAS-521-4	26	06/07/2014	06/06/2015
Loop Antenna	A.H.	SAS-526B	264	07/14/2014	07/13/2015
LISN	R&S	ESH3-Z5	8389791009	07/25/2014	07/24/2015
Radiation Cable 1	Sat	RE1	R003	06/04/2014	06/03/2015
Radiation Cable 2	Sat	RE2	R002	06/04/2014	06/03/2015
Conduction Cable	Sat	CE1	C001	06/04/2014	06/03/2015

7. 15.203 - ANTENNA REQUIREMENT

7.1. STANDARD APPLICABLE

According to FCC 15.203, An intentional radiator shall be designed to ensure that no antenna other than that furnished by the responsible party shall be used with the device. The use of a permanently attached antenna or of an antenna that uses a unique coupling to the intentional radiator shall be considered sufficient to comply with the provisions of this Section. The manufacturer may design the unit so that a broken antenna can be replaced by the user, but the use of a standard antenna jack or electrical connector is prohibited. This requirement does not apply to carrier current devices or to devices operated under the provisions of Sections 15.211, 15.213, 15.217, 15.219, or 15.221. Further, this requirement does not apply to intentional radiators that must be professionally installed, such as perimeter protection systems and some field disturbance sensors, or to other intentional radiators which, in accordance with Section 15.31(d), must be measured at the installation site. However, the installer shall be responsible for ensuring that the proper antenna is employed so that the limits in this Part are not exceeded.

7.2. TEST RESULT

This product has a permanent antenna, fulfill the requirement of this section.

8. PEAK OUTPUT POWER

8.1. MEASUREMENT PROCEDURE

For peak power test:

1. Connect EUT RF output port to the Spectrum Analyzer through an RF attenuator
2. Set the EUT Work on the top, middle and the bottom operation frequency individually.
3. Use the following spectrum analyzer settings:
 - Set the RBW \geq DTS bandwidth.
 - Set the VBW $\geq 3 \times$ RBW
 - Set the span $\geq 3 \times$ RBW
 - Detector = peak
 - Sweep time = auto couple
 - Trace mode = max hold
4. Allow the trace to stabilize. Use the instrument's band/channel power measurement function with the band limits set equal to the DTS bandwidth edges.
5. Record the result form the Spectrum Analyzer.

For average power test:

1. Connect EUT RF output port to power probe through an RF attenuator.
2. Connect the power probe to the PC.
3. Set the EUT Work on the top, the middle and the bottom operation frequency individually.
4. Record the maximum power from the software.
5. The maximum peak power shall be less 1 Watt (30dBm).

Note : The EUT was tested according to KDB 558074 for compliance to FCC 47CFR 15.247 requirements.

8.2. TEST SET-UP (BLOCK DIAGRAM OF CONFIGURATION)

PEAK POWER TEST SETUP

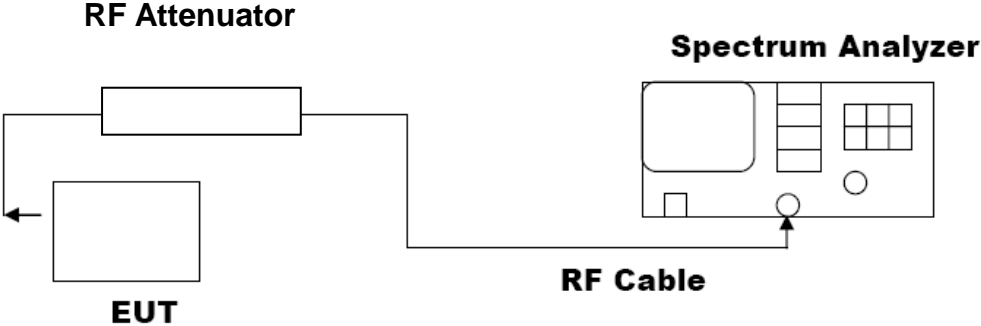

AVERAGE POWER SETUP

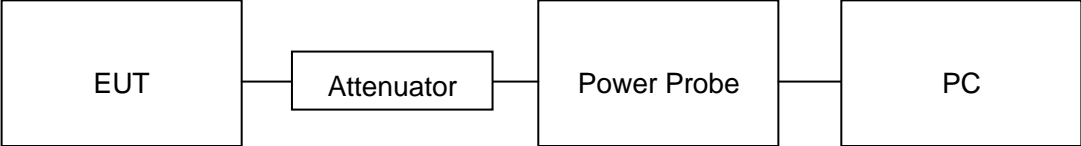

8.3. LIMITS AND MEASUREMENT RESULT

TEST ITEM	PEAK POWER
-----------	------------

LIMITS AND MEASUREMENT RESULT				
Frequency (GHz)	Average Power (dBm)	Peak Power (dBm)	Applicable Limits (dBm)	Pass or Fail
2.405	10.96	14.29	30	Pass
2.440	10.34	13.33	30	Pass
2.480	10.27	13.21	30	Pass

CH1

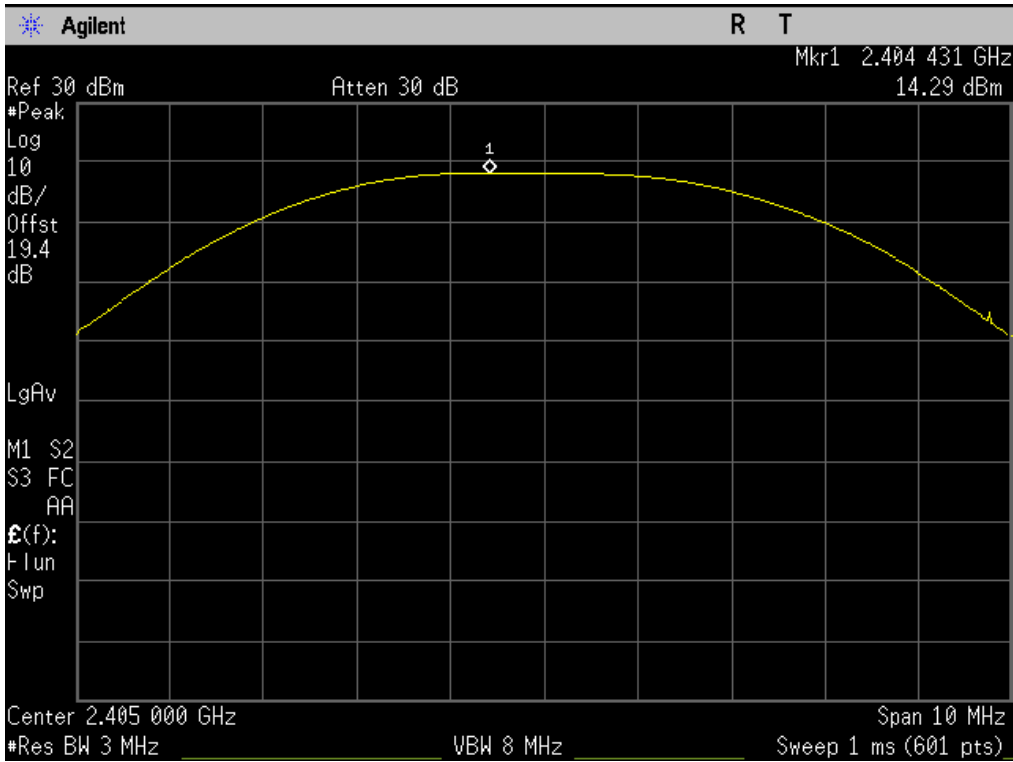

CH8

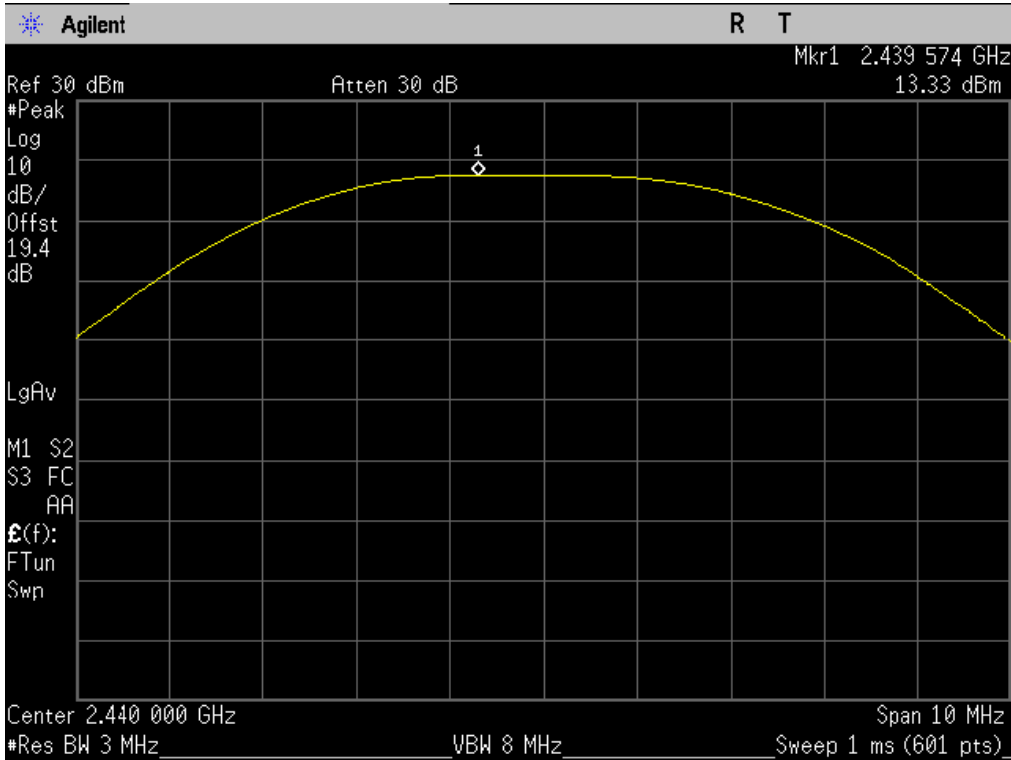

CH16

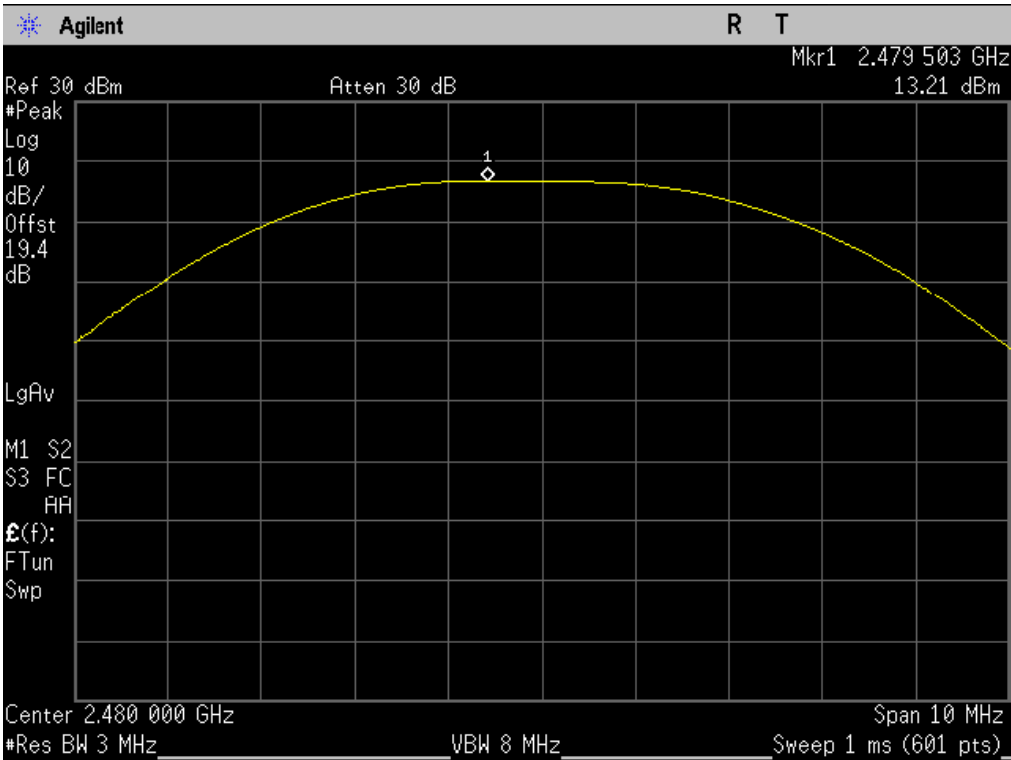

9. 6DB BANDWIDTH

9.1. MEASUREMENT PROCEDURE

1. The EUT was placed on a table which is 0.8m above ground plane.
2. Connect EUT RF output port to the Spectrum Analyzer through an RF attenuator
3. Set the EUT Work on the top, the middle and the bottom operation frequency individually.
4. Set SPA Centre Frequency = Operation Frequency, RBW= 100 KHz, VBW \geq RBW.
5. Set SPA Trace 1 Max hold, then View.

Note: The EUT was tested according to KDB 558074 for compliance to FCC 47CFR 15.247 requirements.

9.2. TEST SET-UP (BLOCK DIAGRAM OF CONFIGURATION)

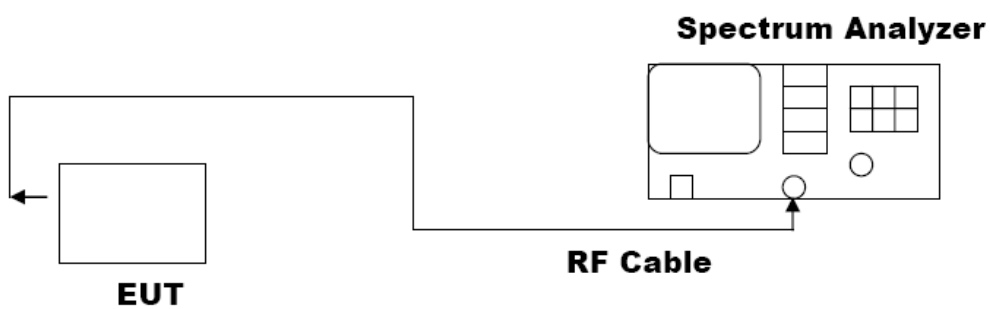

9.3. LIMITS AND MEASUREMENT RESULTS

TEST ITEM	6DB BANDWIDTH
-----------	---------------

LIMITS AND MEASUREMENT RESULT			
Applicable Limits	Applicable Limits		
	Test Data (MHz)		Criteria
>500KHZ	Low Channel	1.579	PASS
	Middle Channel	1.599	PASS
	High Channel	1.577	PASS

TEST PLOT OF BANDWIDTH FOR LOW CHANNEL



TEST PLOT OF BANDWIDTH FOR MIDDLE CHANNEL

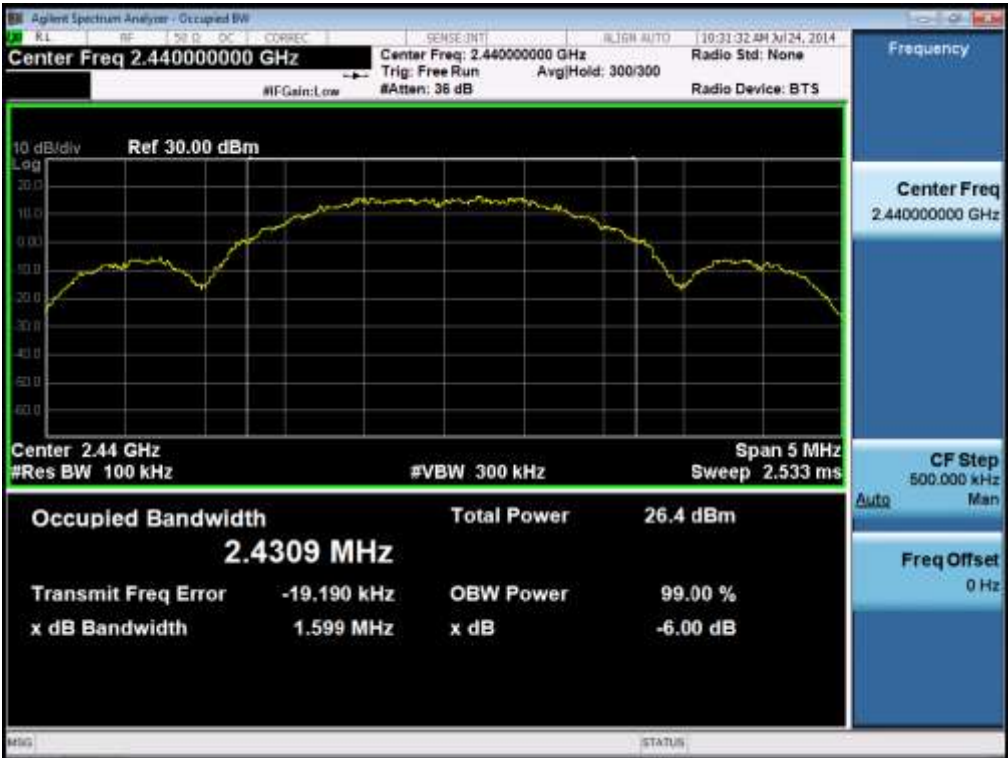

TEST PLOT OF BANDWIDTH FOR HIGH CHANNEL



10. CONDUCTED SPURIOUS EMISSION

10.1. MEASUREMENT PROCEDURE

1. The EUT was placed on a turn table which is 0.8m above ground plane.
2. Connect EUT RF output port to the Spectrum Analyzer through an RF attenuator
- 3, Set the EUT Work on the top, the middle and the bottom operation frequency individually.
4. Set SPA Trace 1 Max hold, then View.

Note: The EUT was tested according to KDB 558074 for compliance to FCC 47CFR 15.247 requirements. Owing to satisfy the requirements of the number of measurement points, we set the RBW=1MHz, VBW > RBW, scan up through 10th harmonic, and consider the tested results as the worst case, if the tested results conform to the requirement, we can deem that the real tested results(set the RBW=100KHz, VBW > RBW) are conform to the requirement.

10.2. TEST SET-UP (BLOCK DIAGRAM OF CONFIGURATION)

The same as described in section 8.2.

10.3. MEASUREMENT EQUIPMENT USED

The same as described in section 6.

10.4. LIMITS AND MEASUREMENT RESULT

LIMITS AND MEASUREMENT RESULT		
Applicable Limits	Measurement Result	
	Test Data	Criteria
In any 100 KHz Bandwidth Outside the frequency band in which the spread spectrum intentional radiator is operating, the radio frequency power that is produce by the intentional radiator shall be at least 20 dB below that in 100KHz bandwidth within the band that contains the highest level of the desired power. In addition, radiation emissions which fall in the restricted bands, as defined in §15.205(a), must also comply with the radiated emission limits specified in§15.209(a)	At least -20dBc than the limit Specified on the BOTTOM Channel	PASS
	At least -20dBc than the limit Specified on the TOP Channel	PASS

TEST PLOT OF OUT OF BAND EMISSIONS
 LOW CHANNEL

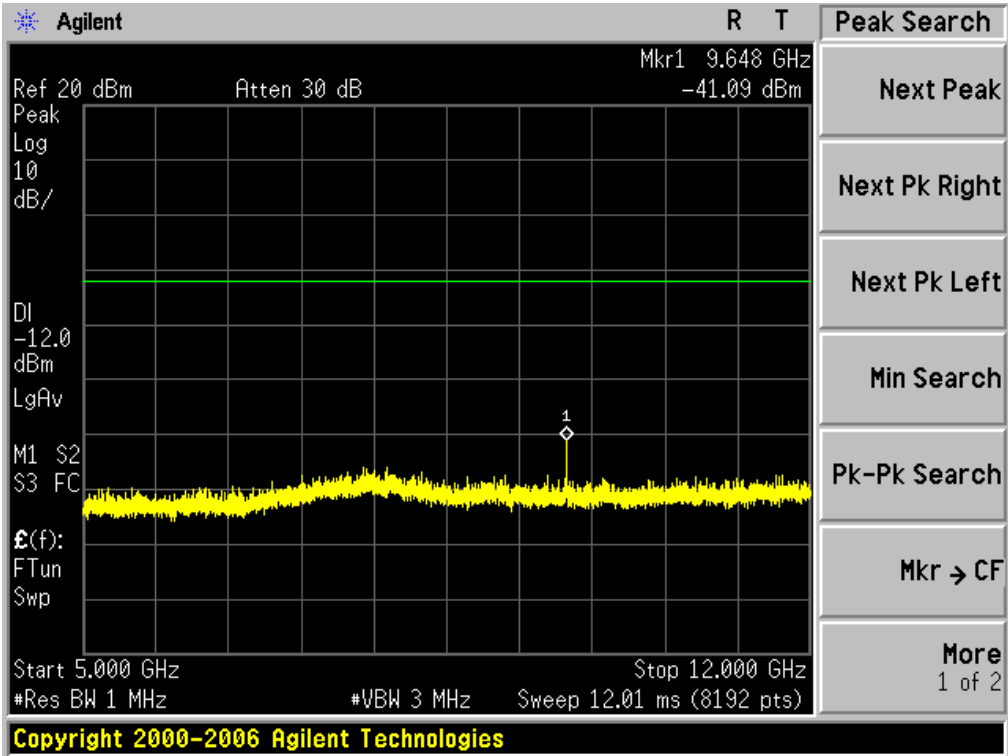
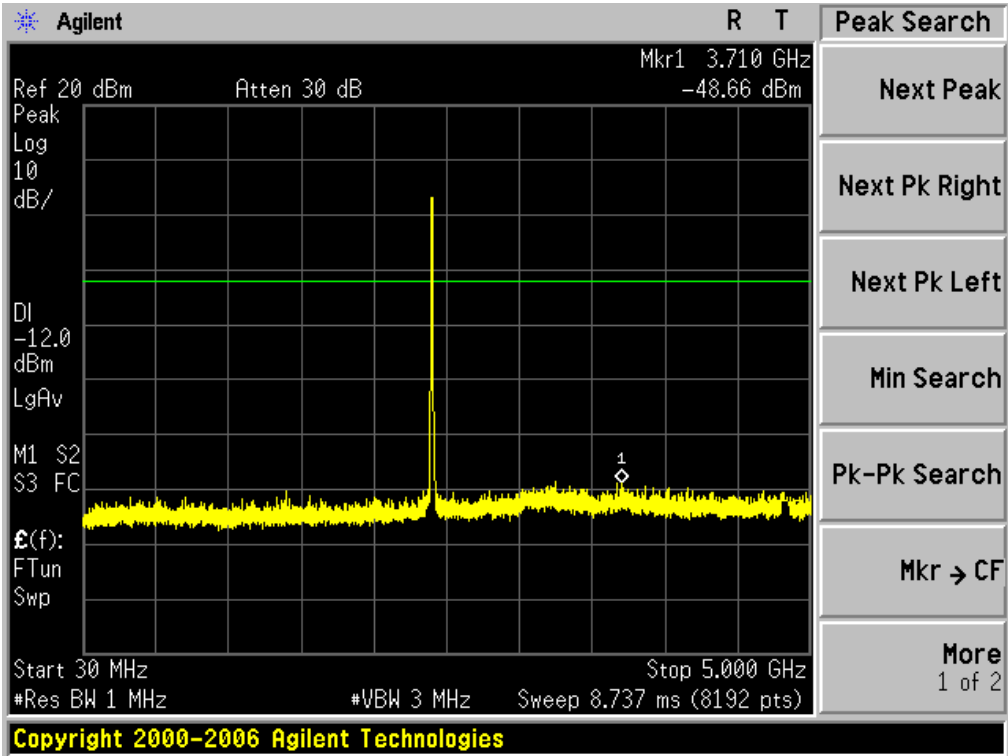

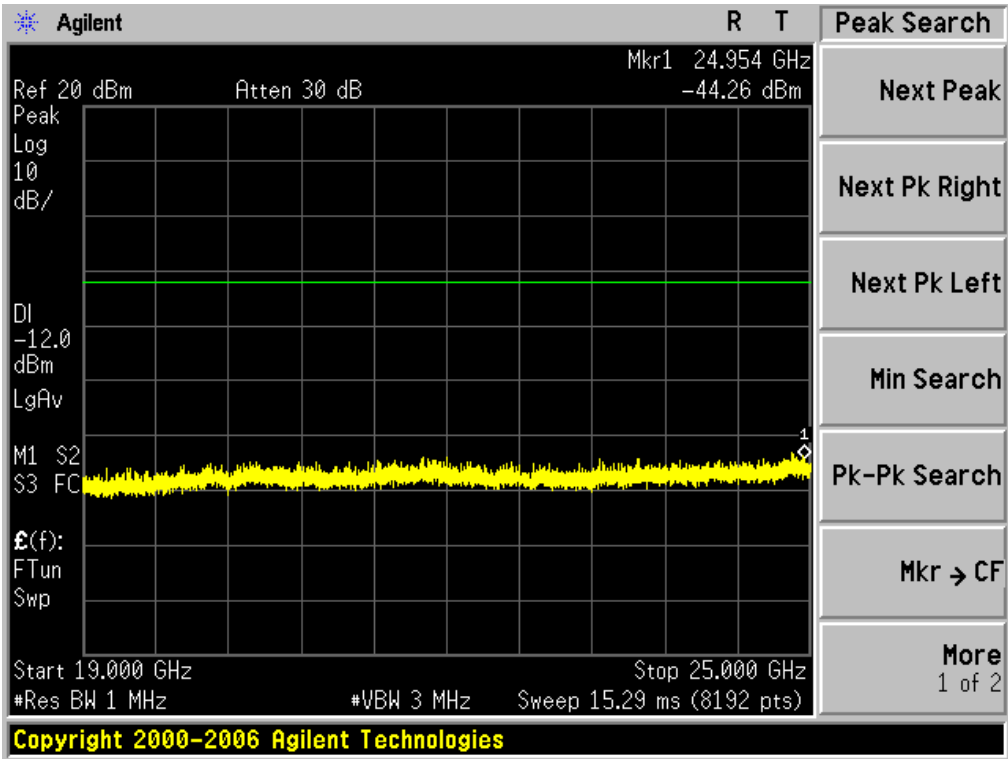
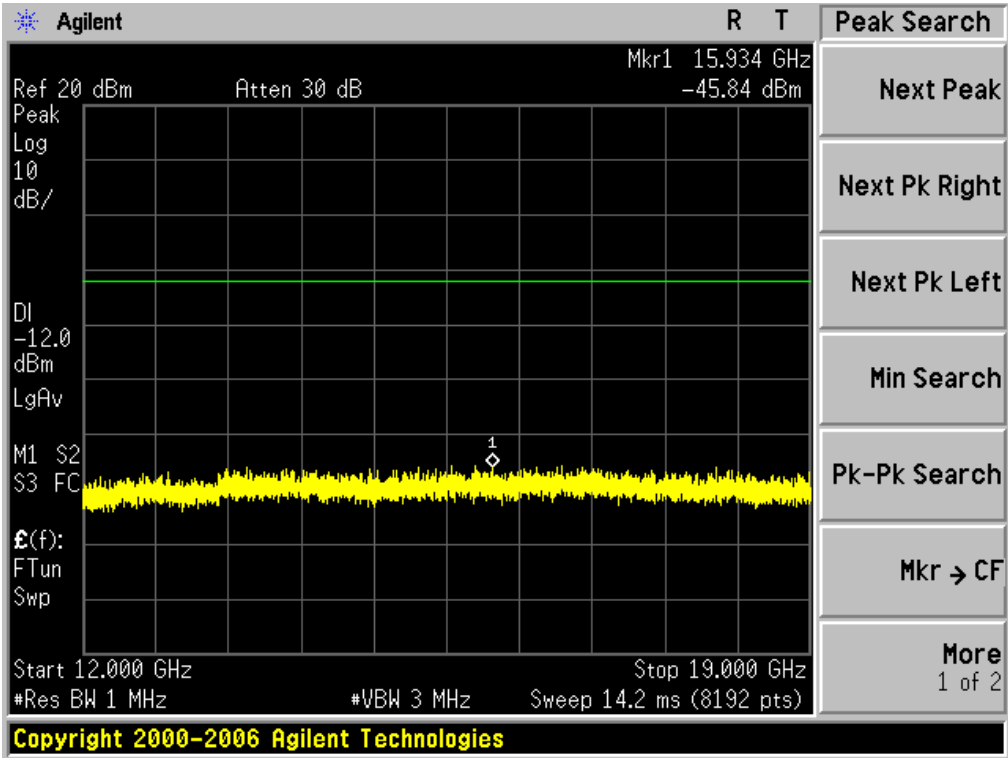

TEST PLOT OF OUT OF BAND EMISSIONS
 MODULATION IN MIDDLE CHANNEL

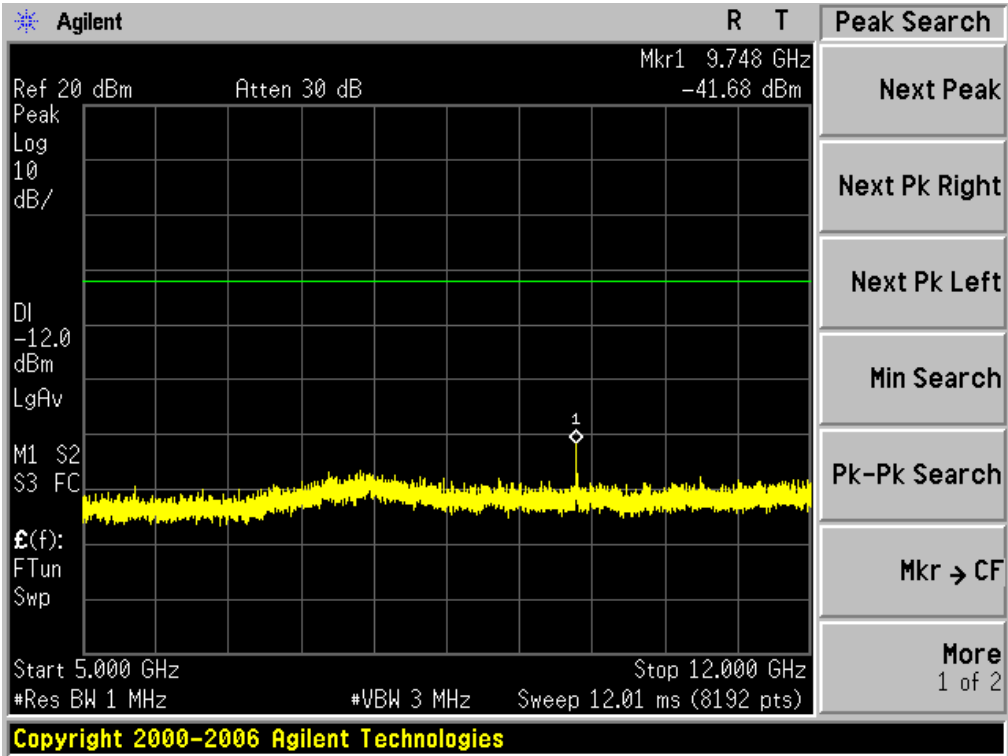
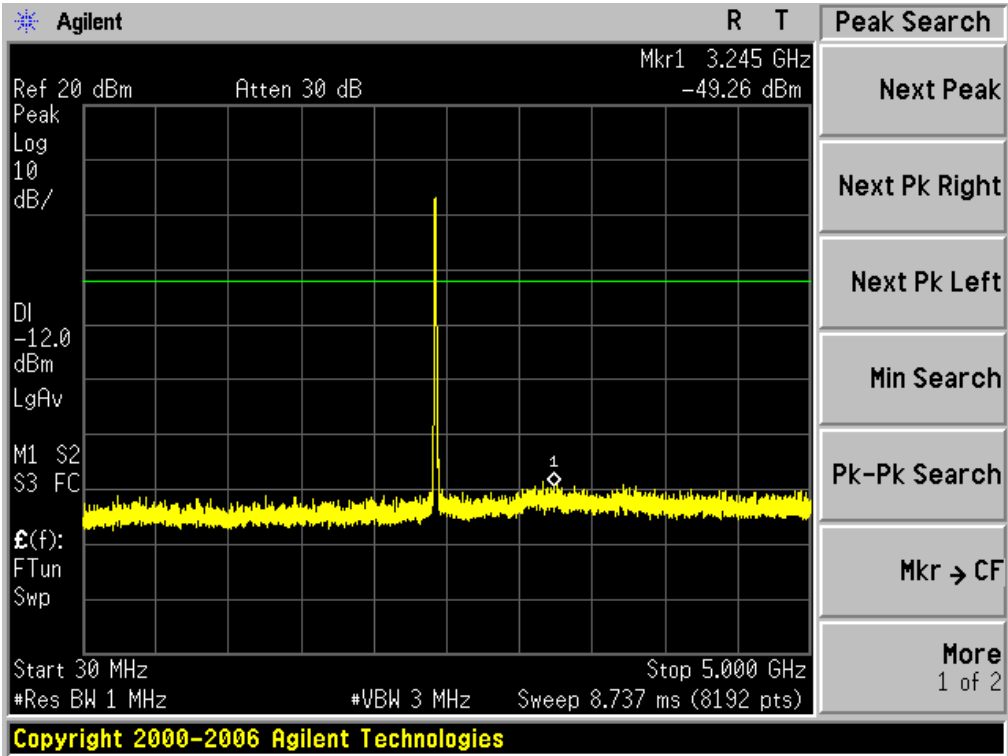

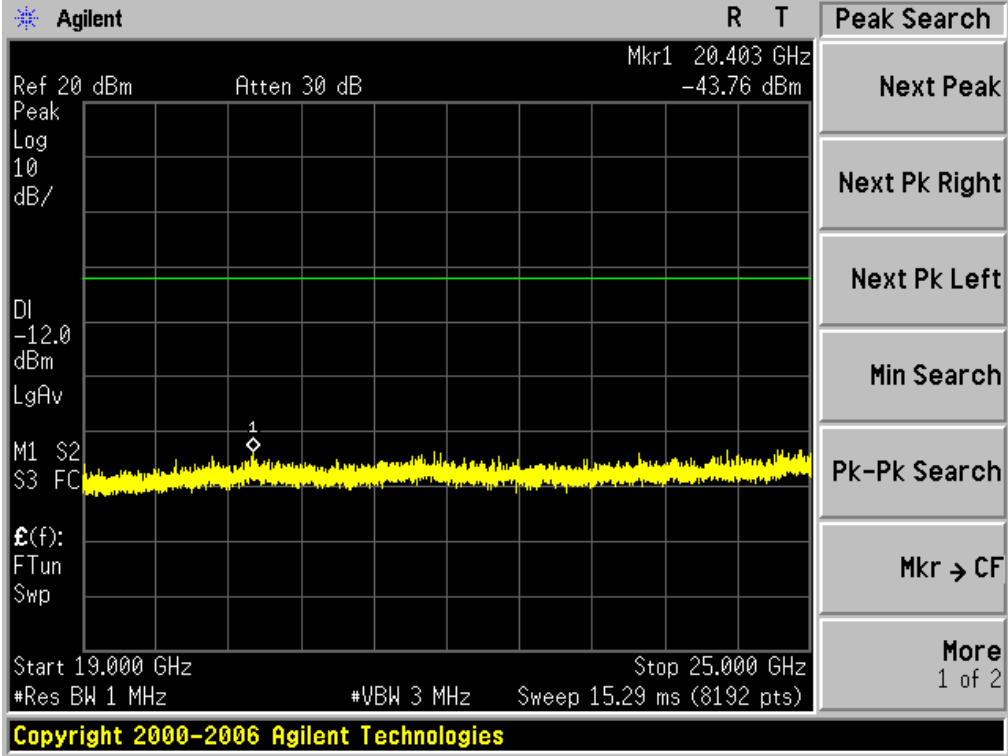
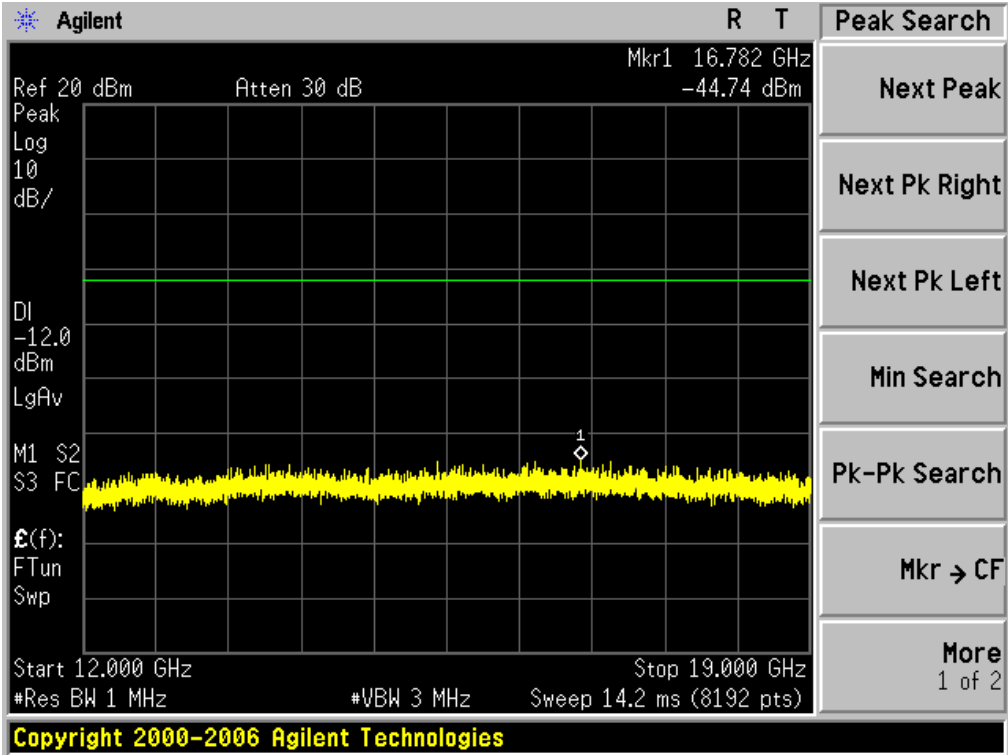

TEST PLOT OF OUT OF BAND EMISSIONS
MODULATION IN HIGH CHANNEL

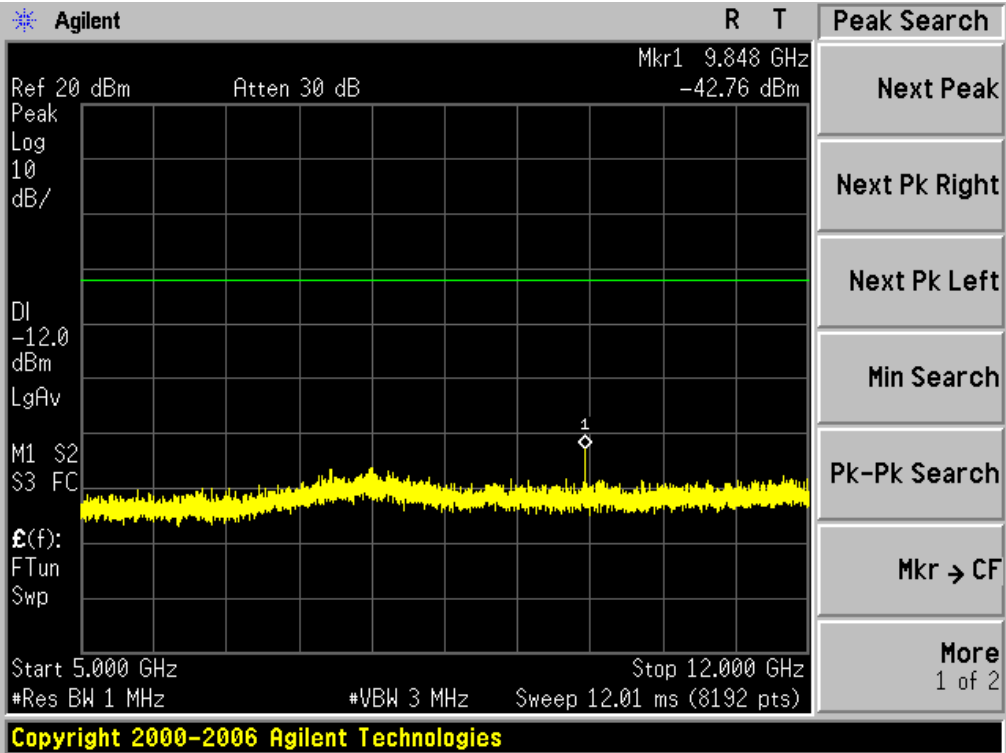
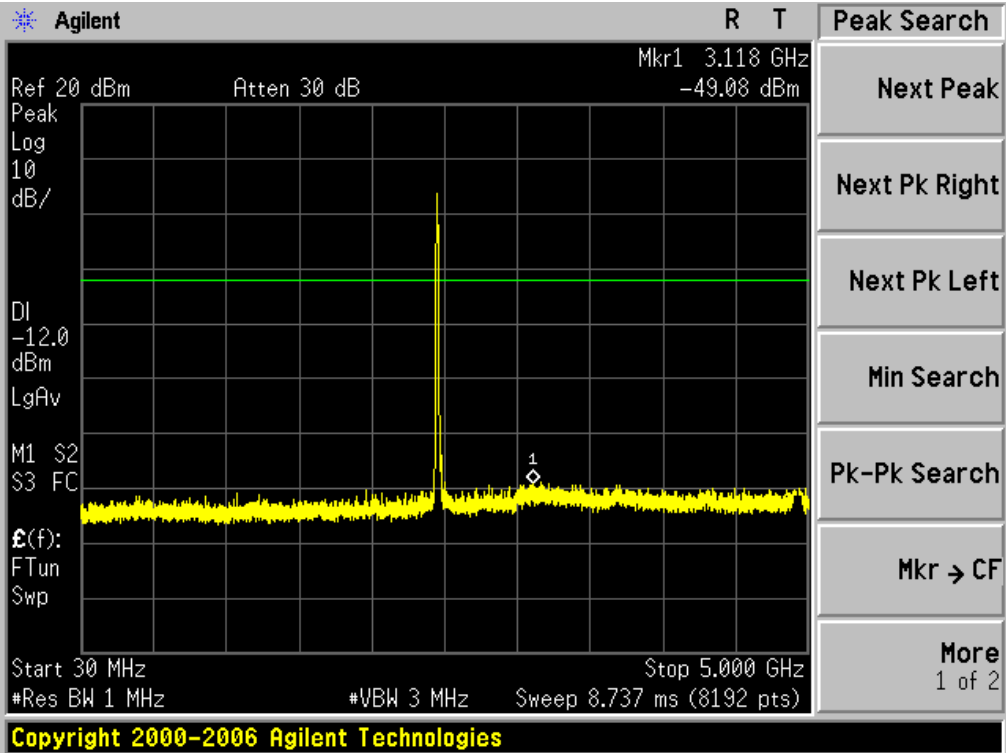

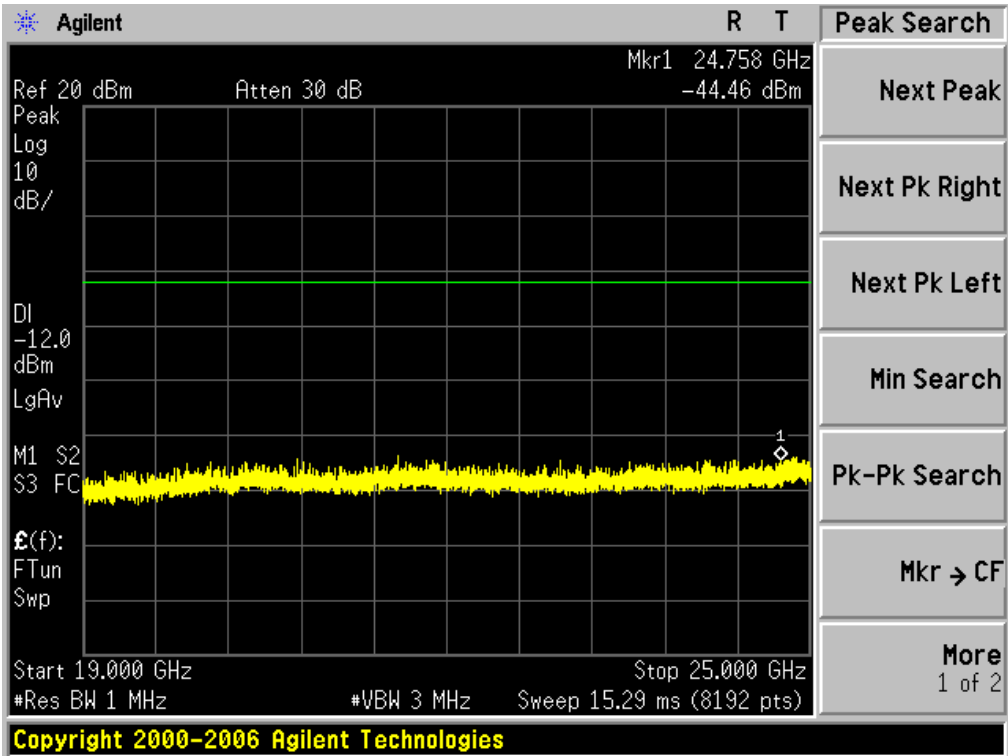
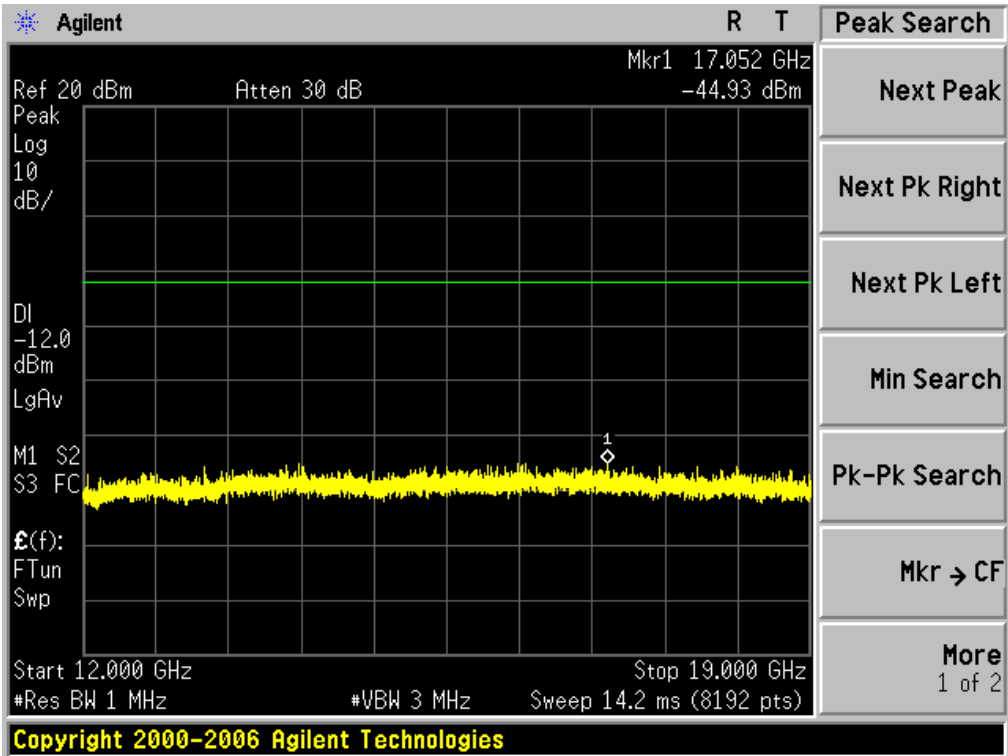

11. MAXIMUM CONDUCTED OUTPUT POWER SPECTRAL DENSITY

11.1 MEASUREMENT PROCEDURE

- (1). The EUT was placed on a turn table which is 0.8m above ground plane.
- (2). Connect EUT RF output port to the Spectrum Analyzer through an RF attenuator
- (3). Set the EUT Work on the top, the middle and the bottom operation frequency individually.
- (4). Set SPA Trace 1 Max hold, then View.

Note: The method of PKPSD in the KDB 558074 item 10.2 was used in this testing.

11.2 TEST SET-UP (BLOCK DIAGRAM OF CONFIGURATION)

Refer To Section 8.2.

11.3 MEASUREMENT EQUIPMENT USED

Refer To Section 6.

10.4 LIMITS AND MEASUREMENT RESULT

TEST ITEM	POWER PECTRAL DENSITY
TEST MODE	802.11b with data rate 1

Channel No.	PSD (dBm)	Limit (dBm)	Result
Low Channel	5.328	8	Pass
Middle Channel	5.705	8	Pass
High Channel	5.769	8	Pass

TEST RESULT

TEST PLOT OF SPECTRAL DENSITY FOR LOW CHANNEL



TEST PLOT OF SPECTRAL DENSITY FOR MIDDLE CHANNEL



TEST PLOT OF SPECTRAL DENSITY FOR HIGH CHANNEL



12. RADIATED EMISSION

12.1. MEASUREMENT PROCEDURE

1. Configure the EUT according to ANSI C63.4. The EUT was placed on the top of the turntable 0.8 meter above ground. The phase center of the receiving antenna mounted on the top of a height-variable antenna tower was placed 3 meters far away from the turntable.
2. Power on the EUT and all the supporting units. The turntable was rotated by 360 degrees to determine the position of the highest radiation.
3. The height of the broadband receiving antenna was varied between one meter and four meters above ground to find the maximum emissions field strength of both horizontal and vertical polarization.
4. For each suspected emissions, the antenna tower was scan (from 1 M to 4 M) and then the turntable was rotated (from 0 degree to 360 degrees) to find the maximum reading.
5. Set the test-receiver system to Peak or CISPR quasi-peak Detect Function with specified bandwidth under Maximum Hold Mode.
6. For emissions above 1GHz, use 1MHz VBW and RBW for peak reading. Then 1MHz RBW and 10Hz VBW for average reading in spectrum analyzer.
7. When the radiated emissions limits are expressed in terms of the average value of the emissions, and pulsed operation is employed, the measurement field strength shall be determined by averaging over one complete pulse train, including blanking intervals, as long as the pulse train does not exceed 0.1 seconds. As an alternative (provided the transmitter operates for longer than 0.1 seconds) or in cases where the pulse train exceeds 0.1 seconds, the measured field strength shall be determined from the average absolute voltage during a 0.1 second interval during which the field strength is at its maximum values.
8. If the emissions level of the EUT in peak mode was 3 dB lower than the average limit specified, then testing will be stopped and peak values of EUT will be reported, otherwise, the emissions which do not have 3 dB margin will be repeated one by one using the quasi-peak method for below 1GHz.
9. For testing above 1GHz, the emissions level of the EUT in peak mode was lower than average limit (that means the emissions level in peak mode also complies with the limit in average mode), then testing will be stopped and peak values of EUT will be reported, otherwise, the emissions will be measured in average mode again and reported.
10. In case the emission is lower than 30MHz, loop antenna has to be used for measurement and the recorded data should be QP measured by receiver. High - Low scan is not required in this case.

12.2. TEST SETUP

RADIATED EMISSION TEST SETUP 30MHz-1000MHz

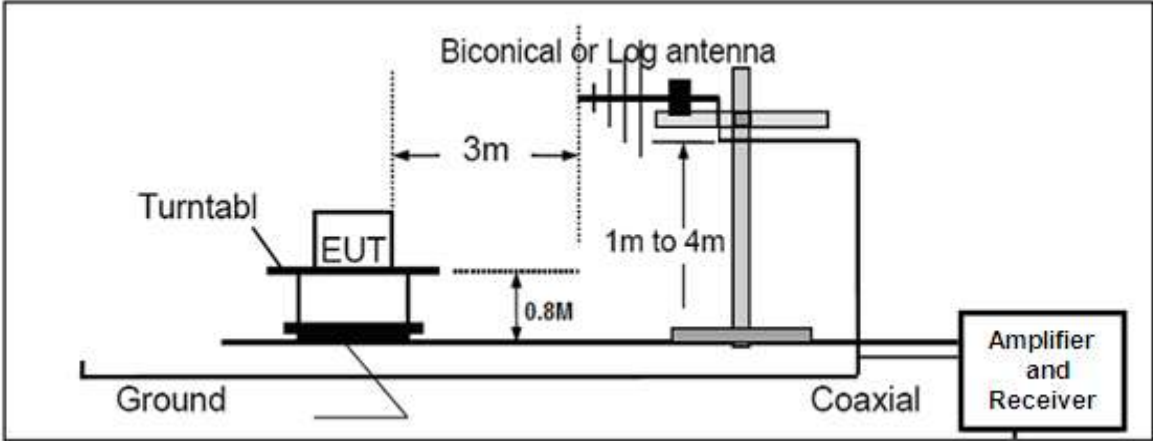

RADIATED EMISSION TEST SETUP ABOVE 1000MHz

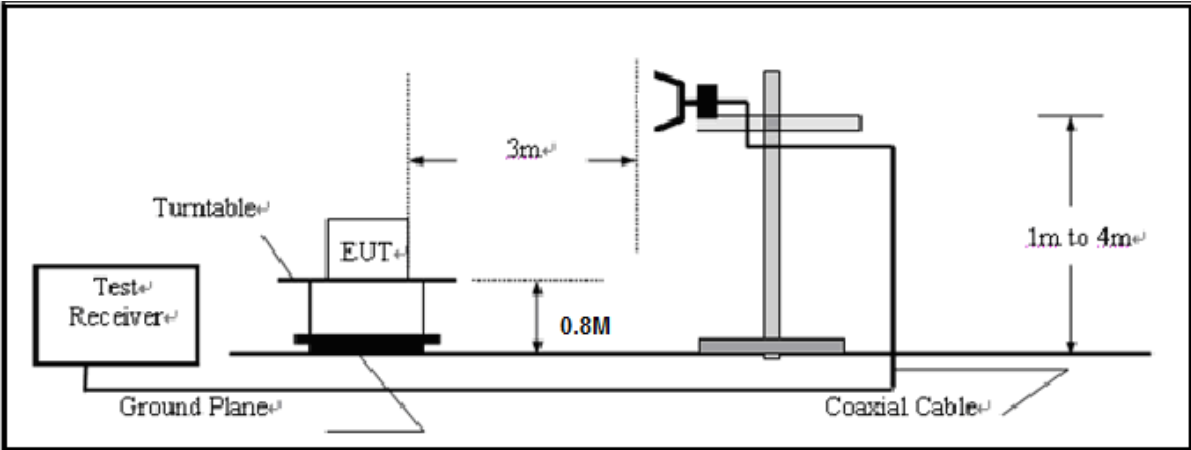

12.3. LIMITS AND MEASUREMENT RESULT

15.209(a) Limit in the below table has to be followed

Frequencies (MHz)	Field Strength (micorvolts/meter)	Measurement Distance (meters)
0.009~0.490	2400/F(KHz)	300
0.490~1.705	24000/F(KHz)	30
1.705~30.0	30	30
30~88	100	3
88~216	150	3
216~960	200	3
Above 960	500	3

Note: All modes were tested For restricted band radiated emission,
the test records reported below are the worst result compared to other modes.

11.4. TEST RESULT

RADIATED EMISSION BELOW 30MHZ

No emission found between lowest internal used/generated frequencies to 30MHz.

RADIATED EMISSION BELOW 1GHZ

EUT	evoLution	Model Name	HHRT4
Temperature	25°C	Relative Humidity	55.4%
Pressure	960hPa	Test Voltage	Normal Voltage
Test Mode	2405MHZ	Antenna	Horizontal

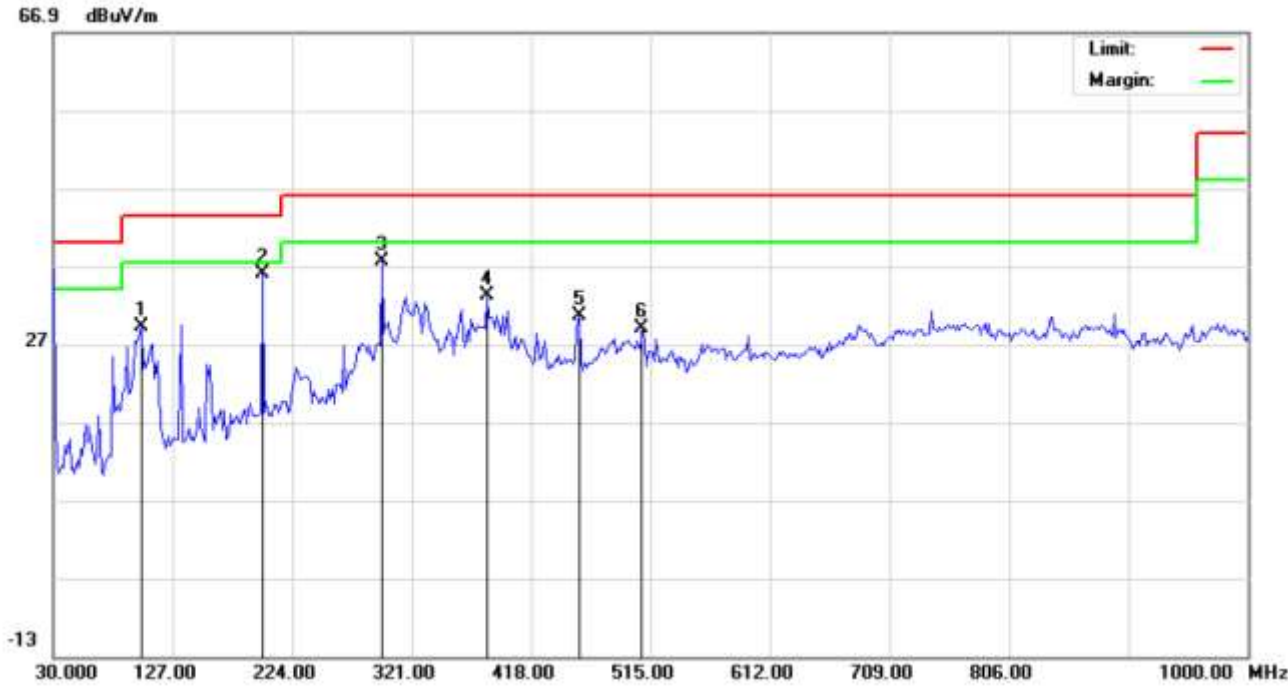

Site: site #1	Polarization: <i>Horizontal</i>	Temperature: 26
Limit: FCC Class B 3M Radiation	Power:	Humidity: 60 %
EUT: evoLution	Distance: 3m	
M/N: HHRT4		
Mode: Low Channel TX		
Note:		

No.	Mk	Freq.	Reading	Factor	Measurement	Limit	Over	Detector	Antenna Height	Table Degree	Comment
		MHz	dBuV	dB/m	dBuV/m	dBuV/m	dB		cm	degree	
1		101.1333	21.09	8.16	29.25	43.50	-14.25	peak			
2	*	199.7500	29.71	6.36	36.07	43.50	-7.43	peak			
3		296.7500	20.01	17.63	37.64	46.00	-8.36	peak			
4		382.4331	13.96	19.20	33.16	46.00	-12.84	peak			
5		456.8000	8.98	21.61	30.59	46.00	-15.41	peak			
6		508.5332	7.43	21.51	28.94	46.00	-17.06	peak			

RESULT: PASS

EUT	evoLution	Model Name	HHRT4
Temperature	25°C	Relative Humidity	55.4%
Pressure	960hPa	Test Voltage	Normal Voltage
Test Mode	2405MHZ	Antenna	Vertical

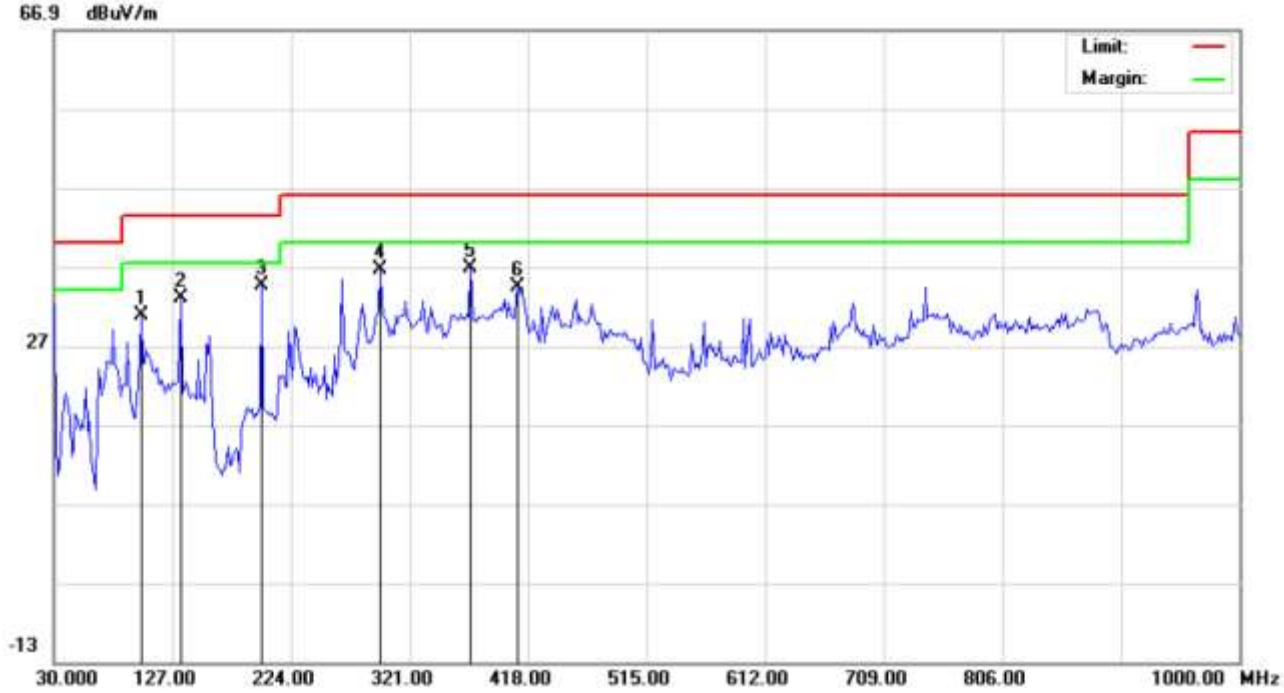

Site: site #1
 Limit: FCC Class B 3M Radiation
 EUT: evoLution
 M/N: HHRT4
 Mode: Low Channel TX
 Note:

Polarization: *Vertical*
 Power:
 Distance: 3m

Temperature: 26
 Humidity: 60 %

No.	Mk	Freq.	Reading	Factor	Measurement	Limit	Over	Detector	Antenna Height	Table Degree	Comment
		MHz	dBuV	dB/m	dBuV/m	dBuV/m	dB		cm	degree	
1		101.1333	26.62	4.20	30.82	43.50	-12.68	peak			
2		133.4667	30.94	2.00	32.94	43.50	-10.56	peak			
3	*	199.7500	27.24	7.38	34.62	43.50	-8.88	peak			
4		296.7500	19.01	17.63	36.64	46.00	-9.36	peak			
5		371.1166	16.92	19.98	36.90	46.00	-9.10	peak			
6		409.9166	14.30	20.08	34.38	46.00	-11.62	peak			

RESULT: PASS

EUT	evoLution	Model Name	HHRT4
Temperature	25°C	Relative Humidity	55.4%
Pressure	960hPa	Test Voltage	Normal Voltage
Test Mode	2440MHZ	Antenna	Horizontal



Site: site #1
 Limit: FCC Class B 3M Radiation
 EUT: evoLution
 M/N: HHRT4
 Mode: Middle Channel TX
 Note:

Polarization: *Horizontal*
 Power:
 Distance: 3m

Temperature: 26
 Humidity: 60 %

No.	Mk	Freq.	Reading	Factor	Measurement	Limit	Over	Detector	Antenna Height	Table Degree	Comment
		MHz	dBuV	dB/m	dBuV/m	dBuV/m	dB		cm	degree	
1		101.1333	22.80	8.16	30.96	43.50	-12.54	peak			
2	*	133.4667	32.59	5.47	38.06	43.50	-5.44	peak			
3		154.4832	18.96	7.15	26.11	43.50	-17.39	peak			
4		199.7500	28.44	6.36	34.80	43.50	-8.70	peak			
5		296.7500	18.25	17.63	35.88	46.00	-10.12	peak			
6		398.6000	17.65	16.28	33.93	46.00	-12.07	peak			

RESULT: PASS

EUT	evoLution	Model Name	HHRT4
Temperature	25°C	Relative Humidity	55.4%
Pressure	960hPa	Test Voltage	Normal Voltage
Test Mode	2440MHZ	Antenna	Vertical

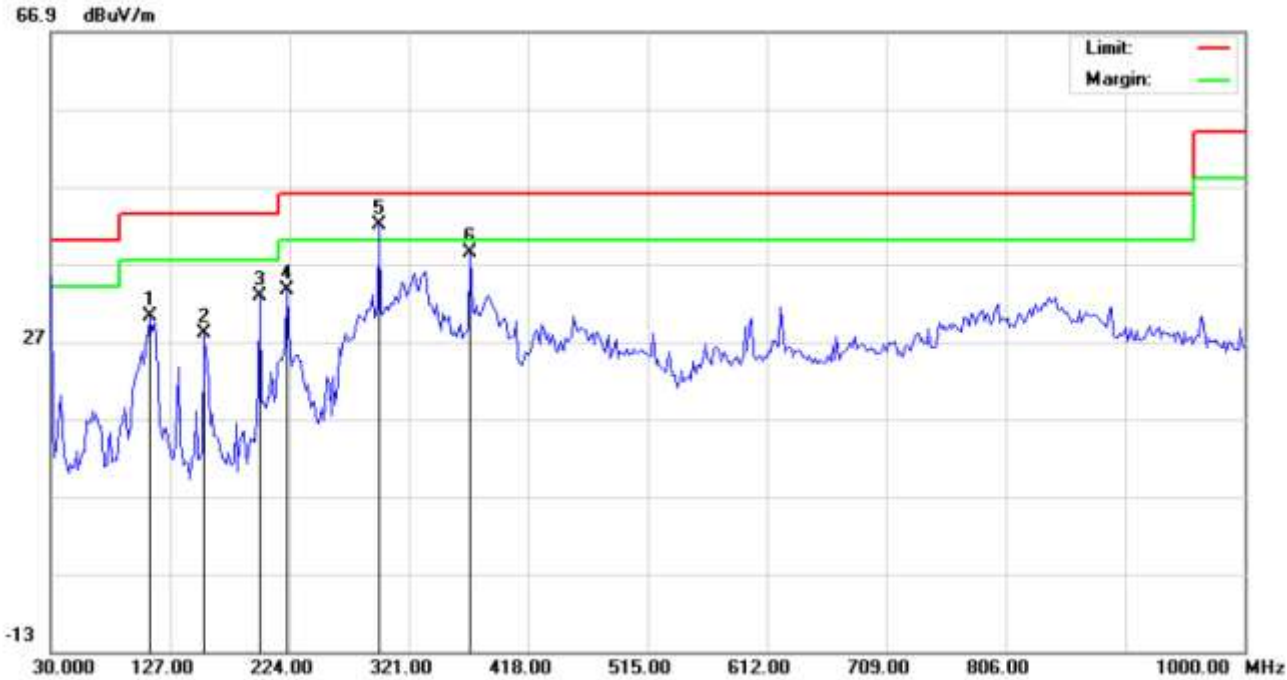

Site: site #1
 Limit: FCC Class B 3M Radiation
 EUT: evoLution
 M/N: HHRT4
 Mode: Middle Channel TX
 Note:

Polarization: *Vertical*
 Power:
 Distance: 3m

Temperature: 26
 Humidity: 60 %

No.	Mk	Freq.	Reading	Factor	Measurement	Limit	Over	Detector	Antenna Height	Table Degree	Comment
		MHz	dBuV	dB/m	dBuV/m	dBuV/m	dB		cm	degree	
1		110.8332	23.04	7.15	30.19	43.50	-13.31	peak			
2		154.4832	20.81	7.15	27.96	43.50	-15.54	peak			
3		199.7500	26.40	6.36	32.76	43.50	-10.74	peak			
4		222.3832	20.84	12.71	33.55	46.00	-12.45	peak			
5	*	296.7500	24.40	17.63	42.03	46.00	-3.97	peak			
6		371.1166	18.44	19.98	38.42	46.00	-7.58	peak			

RESULT: PASS

EUT	evoLution	Model Name	HHRT4
Temperature	25°C	Relative Humidity	55.4%
Pressure	960hPa	Test Voltage	Normal Voltage
Test Mode	2480MHZ	Antenna	Horizontal

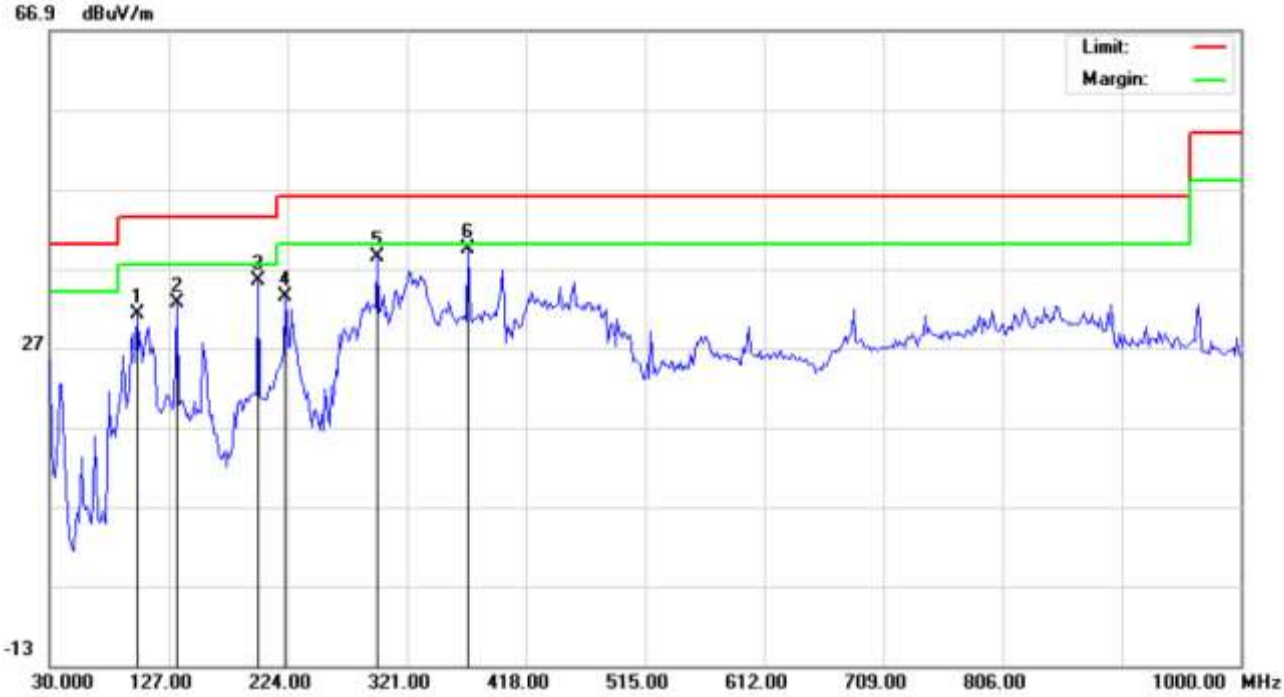

Site: site #1
 Limit: FCC Class B 3M Radiation
 EUT: evoLution
 M/N: HHRT4
 Mode: High Channel TX
 Note:

Polarization: *Horizontal*
 Power:
 Distance: 3m

Temperature: 26
 Humidity: 60 %

No.	Mk	Freq.	Reading	Factor	Measurement	Limit	Over	Detector	Antenna Height	Table Degree	Comment
		MHz	dBuV	dB/m	dBuV/m	dBuV/m	dB		cm	degree	
1		101.1333	23.13	8.16	31.29	43.50	-12.21	peak			
2		133.4667	27.19	5.47	32.66	43.50	-10.84	peak			
3		199.7500	28.95	6.36	35.31	43.50	-8.19	peak			
4		222.3832	20.69	12.71	33.40	46.00	-12.60	peak			
5		296.7500	20.82	17.63	38.45	46.00	-7.55	peak			
6	*	371.1166	19.38	19.98	39.36	46.00	-6.64	peak			

RESULT: PASS

EUT	evoLution	Model Name	HHRT4
Temperature	25°C	Relative Humidity	55.4%
Pressure	960hPa	Test Voltage	Normal Voltage
Test Mode	2480MHZ	Antenna	Vertical

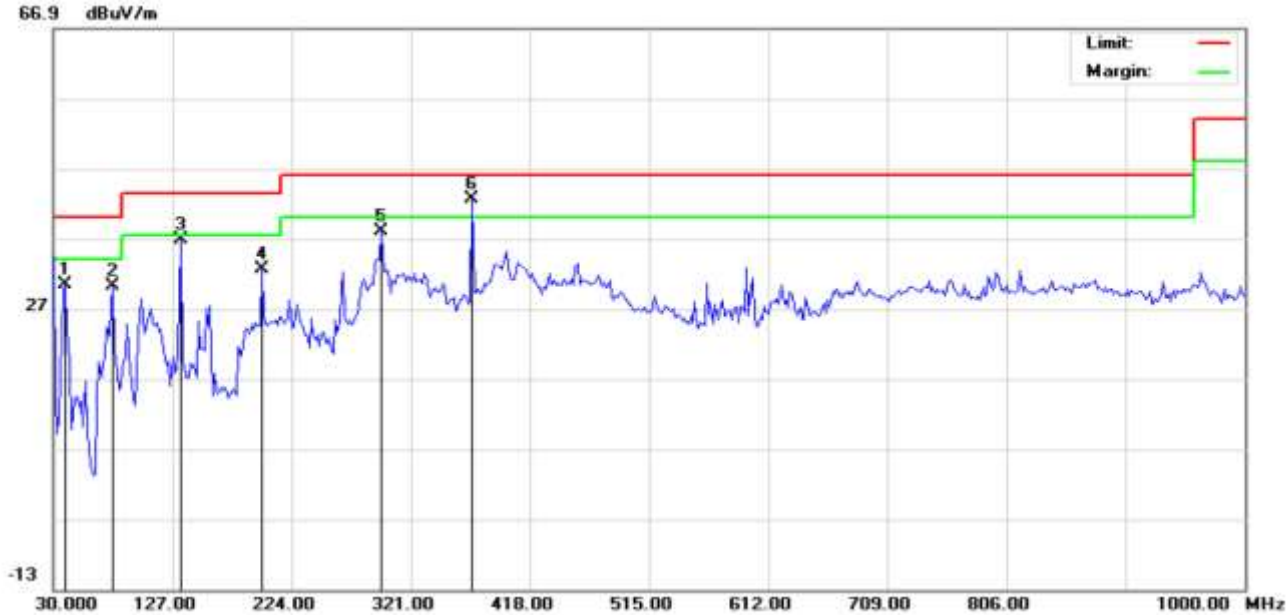

Site: site #1
 Limit: FCC Class B 3M Radiation
 EUT: evoLution
 M/N: HHRT4
 Mode: High Channel TX
 Note:

Polarization: *Vertical*
 Power:
 Distance: 3m

Temperature: 26
 Humidity: 60 %

No.	Mk	Freq.	Reading	Factor	Measurement	Limit	Over	Detector	Antenna Height	Table Degree	Comment
		MHz	dBuV	dB/m	dBuV/m	dBuV/m	dB		cm	degree	
1		39.7000	22.82	7.64	30.46	40.00	-9.54	peak			
2		78.5000	24.87	5.41	30.28	40.00	-9.72	peak			
3		133.4667	34.71	2.00	36.71	43.50	-6.79	peak			
4		199.7500	25.32	7.38	32.70	43.50	-10.80	peak			
5		296.7500	20.31	17.63	37.94	46.00	-8.06	peak			
6	*	371.1166	22.69	19.98	42.67	46.00	-3.33	peak			

RESULT: PASS

Note: 1. Factor=Antenna Factor + Cable loss, Margin=Measurement-Limit.

2. The "Factor" value can be calculated automatically by software of measurement system.

RADIATED EMISSION ABOVE 1GHZ

EUT	evoLution	Model Name	HHRT4
Temperature	25°C	Relative Humidity	55.4%
Pressure	960hPa	Test Voltage	Normal Voltage
Test Mode	2405MHZ	Antenna	Horizontal

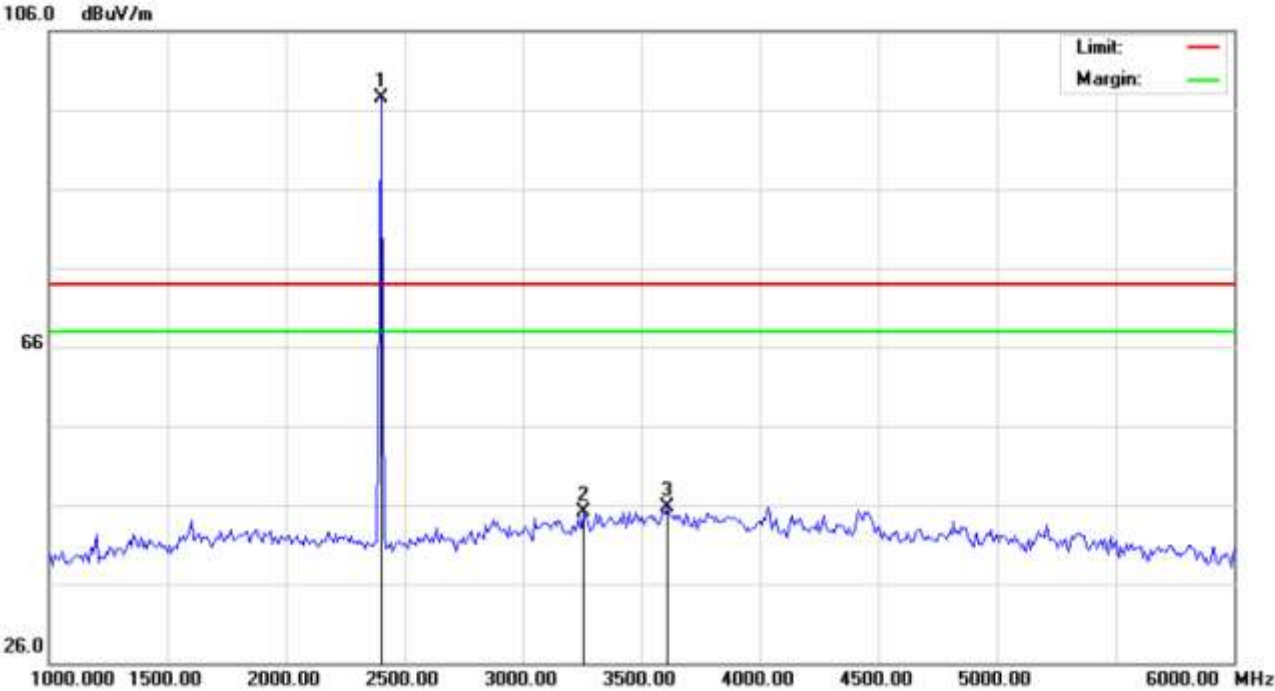

Site: site #1
 Limit: FCC Class B 3M Radiation above 1GHZ(PK)
 EUT: evoLution
 M/N: HHRT4
 Mode: Low Channel TX
 Note:

Polarization: *Horizontal*
 Power:
 Distance:

Temperature: 26
 Humidity: 60 %

No.	Mk	Freq.	Reading	Factor	Measurement	Limit	Over	Detector	Antenna Height	Table Degree	Comment
		MHz	dBuV	dB/m	dBuV/m	dBuV/m	dB		cm	degree	
1	*	2405.000	87.10	10.33	97.43	74.00	23.43	peak			
2		3258.333	33.21	11.88	45.09	74.00	-28.91	peak			
3		3608.333	33.00	12.78	45.78	74.00	-28.22	peak			

EUT	evoLution	Model Name	HHRT4
Temperature	25°C	Relative Humidity	55.4%
Pressure	960hPa	Test Voltage	Normal Voltage
Test Mode	2440MHZ	Antenna	Vertical

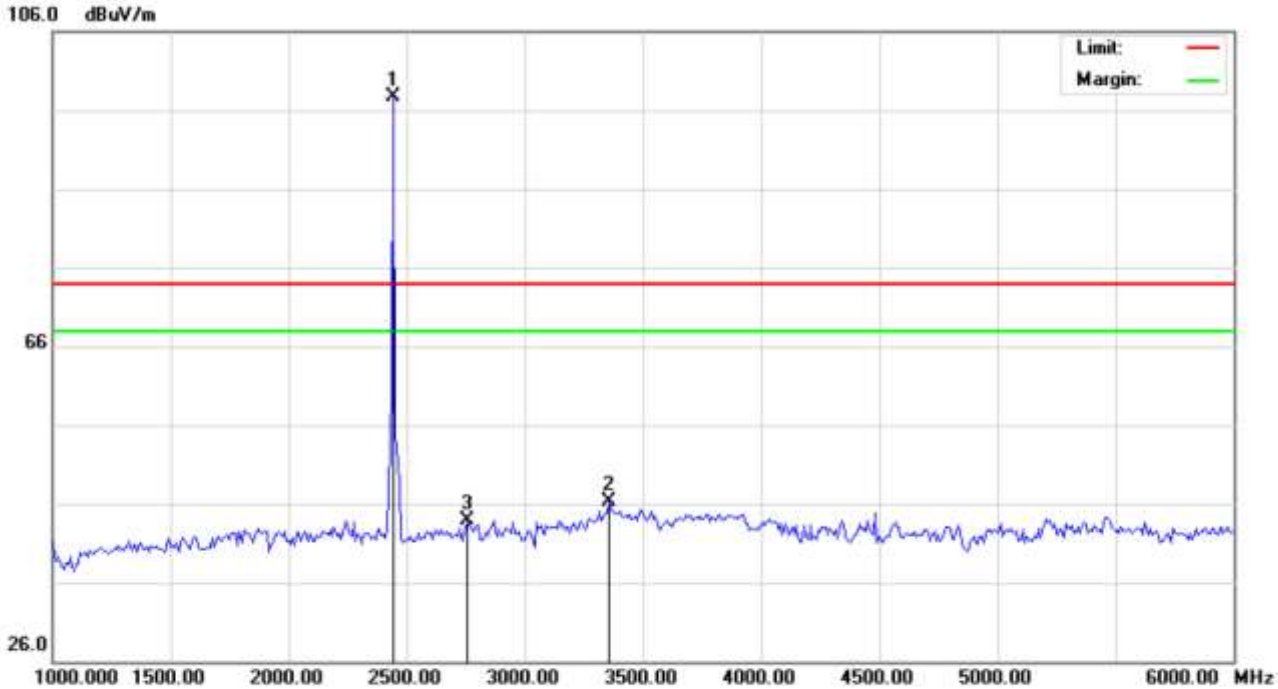

Site: site #1
Limit: FCC Class B 3M Radiation above 1GHZ(PK)
EUT: evoLution
M/N: HHRT4
Mode: Middle Channel TX
Note:

Polarization: *Vertical*
Power:
Distance:

Temperature: 26
Humidity: 60 %

No.	Mk	Freq.	Reading	Factor	Measurement	Limit	Over	Detector	Antenna Height	Table Degree	Comment
		MHz	dBuV	dB/m	dBuV/m	dBuV/m	dB		cm	degree	
1	*	2440.667	87.39	10.36	97.75	74.00	23.75	peak			
2		3358.333	34.27	11.98	46.25	74.00	-27.75	peak			
3		2758.333	32.82	11.06	43.88	74.00	-30.12	peak			

EUT	evoLution	Model Name	HHRT4
Temperature	25°C	Relative Humidity	55.4%
Pressure	960hPa	Test Voltage	Normal Voltage
Test Mode	2480MHZ	Antenna	Horizontal

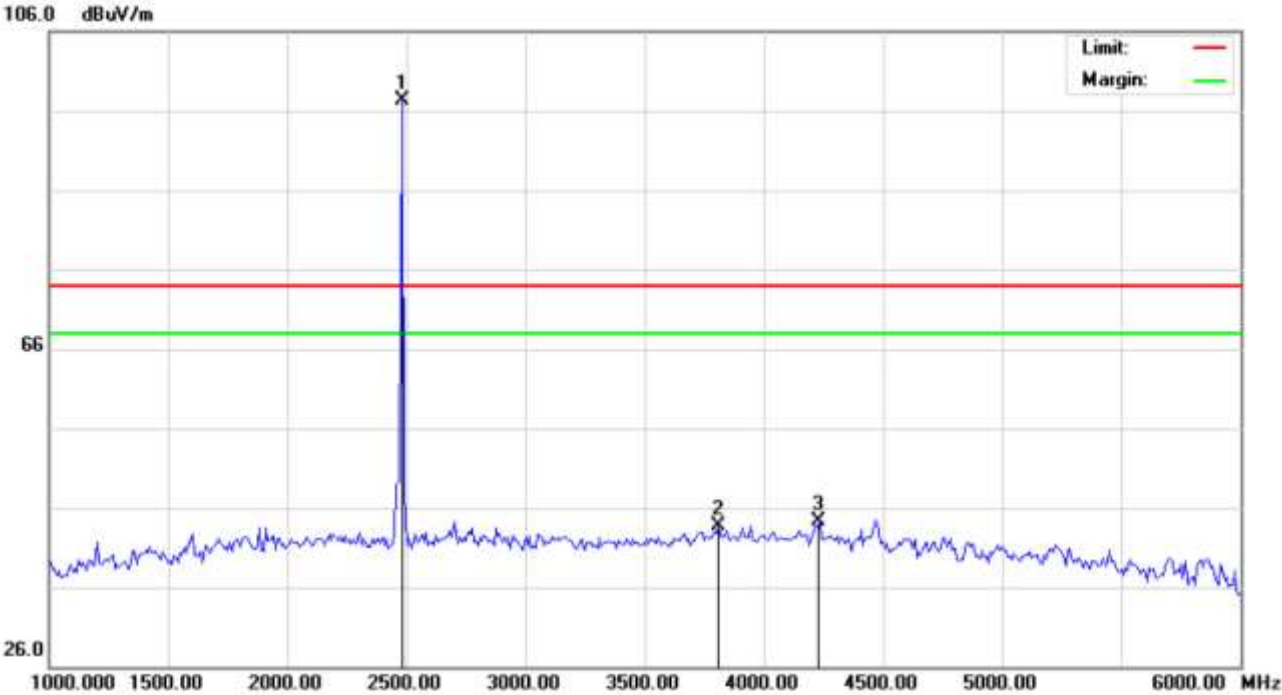

Site: site #1 Polarization: *Horizontal* Temperature: 26
 Limit: FCC Class B 3M Radiation above 1GHZ(PK) Power: Humidity: 60 %
 EUT: evoLution Distance:
 M/N: HHRT4
 Mode: High Channel TX
 Note:

No.	Mk	Freq.	Reading	Factor	Measurement	Limit	Over	Detector	Antenna Height	Table Degree	Comment
		MHz	dBuV	dB/m	dBuV/m	dBuV/m	dB		cm	degree	
1	*	2480.333	86.93	10.41	97.34	74.00	23.34	peak			
2		3808.333	29.63	14.01	43.64	74.00	-30.36	peak			
3		4233.333	32.92	11.32	44.24	74.00	-29.76	peak			

EUT	evoLution	Model Name	HHRT4
Temperature	25°C	Relative Humidity	55.4%
Pressure	960hPa	Test Voltage	Normal Voltage
Test Mode	2480MHZ	Antenna	Vertical

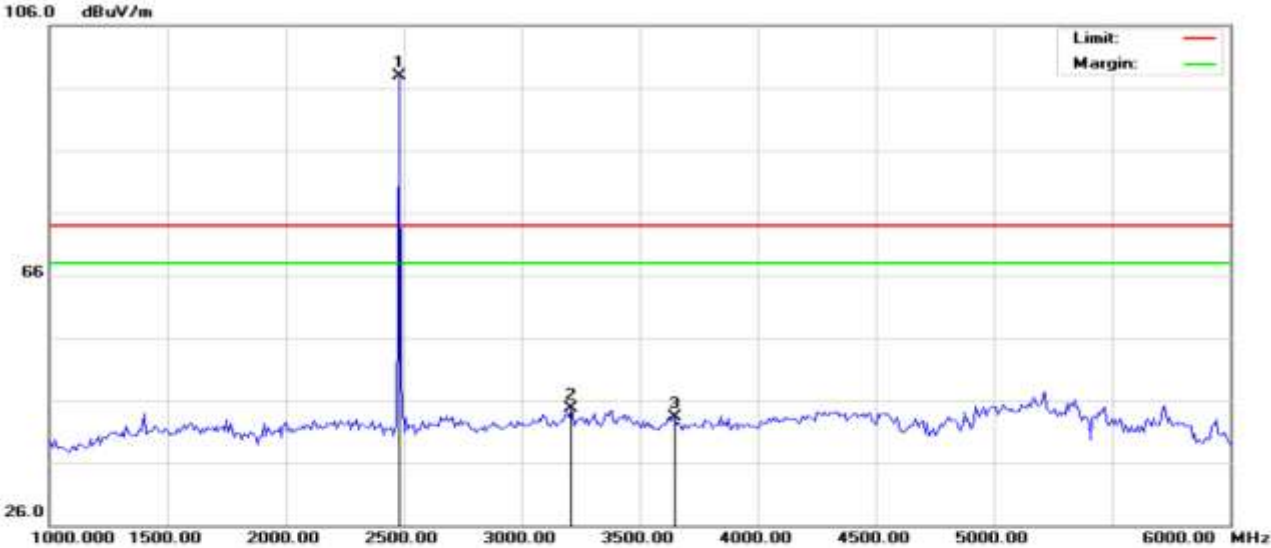

Site: site #1
Limit: FCC Class B 3M Radiation above 1GHZ(PK)
EUT: evoLution
M/N: HHRT4
Mode: High Channel TX
Note:

Polarization: **Vertical**
Power:
Distance:

Temperature: 26
Humidity: 60 %

No.	Mk	Freq.	Reading	Factor	Measurement	Limit	Over	Detector	Antenna Height	Table Degree	Comment
		MHz	dBuV	dB/m	dBuV/m	dBuV/m	dB		cm	degree	
1	*	2480.333	87.47	10.41	97.88	74.00	23.88	peak			
2		3208.755	32.86	11.84	44.70	74.00	-29.30	peak			
3		3650.000	30.34	13.03	43.37	74.00	-30.63	peak			

Notes:

1. Measuring frequencies from 9k~10th harmonic (ex. 26GHz), No emission found between lowest internal used/generated frequency to 30 MHz.
2. Radiated emissions measured in frequency range from 9k~10th harmonic (ex. 26GHz) were made with an instrument using Peak detector mode.
3. Data of measurement within this frequency range shown " --- " in the table above means the reading of emissions are attenuated more than 20dB below the permissible limits or the field strength is too small to be measured.

13. BAND EDGE EMISSION

13.1. MEASUREMENT PROCEDURE

1. Set the EUT Work on the top, the bottom operation frequency individually.
2. Set SPA Start or Stop Frequency = Operation Frequency, $RBW \geq 1\% \text{span}$, $VBW \geq RBW$
3. The band edges was measured and recorded.

13.2. TEST SET-UP

Radiated same as 11.2

13.3. TEST RESULT

(Radiated) Channel 1 Tx-2405

Freq. MHz	Reading Level dBuV	Ant Fac. dB/m	Pre. Fac. dB	Cab. Loss dB	Measured dBuV/m	Limit dBuV/m	Margin dB	Remark	Pol.
2368.85	51.79	32.89	35.16	3.51	53.03	74	-20.97	Peak	Horizontal
2368.77	38.68	32.9	35.16	3.51	39.93	54	-14.07	Average	Horizontal
2399.72	45.37	32.92	35.16	3.54	46.67	74	-27.33	Peak	Horizontal
2399.59	34.81	32.92	35.16	3.54	36.11	54	-17.89	Average	Horizontal
2369.48	52.44	32.89	35.16	3.51	53.68	74	-20.32	Peak	Vertical
2369.35	41.26	32.9	35.16	3.51	42.51	54	-11.49	Average	Vertical
2399.72	44.52	32.92	35.16	3.54	45.82	74	-28.18	Peak	Vertical
2399.53	37.28	32.92	35.16	3.54	38.58	54	-15.42	Average	Vertical

Channel 16 Tx-2480

Freq. MHz	Reading Level dBuV	Ant Fac. dB/m	Pre. Fac. dB	Cab. Loss dB	Measured dBuV/m	Limit dBuV/m	Margin dB	Remark	Pol.
2483.58	44.45	33.06	35.18	3.6	45.93	74	-28.07	Peak	Horizontal
2483.55	35.15	33.08	35.18	3.6	36.65	54	-17.35	Average	Horizontal
2480.15	45.33	33.08	35.18	3.62	46.85	74	-27.15	Peak	Horizontal
2480.27	37.27	33.08	35.18	3.62	38.79	54	-15.21	Average	Horizontal
2484.82	46.64	33.08	35.18	3.6	48.14	74	-25.86	Peak	Vertical
2483.51	36.17	33.08	35.18	3.6	37.67	54	-16.33	Average	Vertical
2480.18	48.36	33.08	35.18	3.62	49.88	74	-24.12	Peak	Vertical
2480.53	37.51	33.08	35.18	3.62	39.03	54	-14.97	Average	Vertical

RESULT: PASS

14. FCC LINE CONDUCTED EMISSION TEST

14.1. LIMITS OF LINE CONDUCTED EMISSION TEST

Frequency	Maximum RF Line Voltage	
	Q.P.(dBuV)	Average(dBuV)
150kHz~500kHz	66-56	56-46
500kHz~5MHz	56	46
5MHz~30MHz	60	50

Note:

1. The lower limit shall apply at the transition frequency.
2. The limit decreases linearly with the logarithm of the frequency in the range 0.15 MHz to 0.50 MHz.

14.2. BLOCK DIAGRAM OF LINE CONDUCTED EMISSION TEST

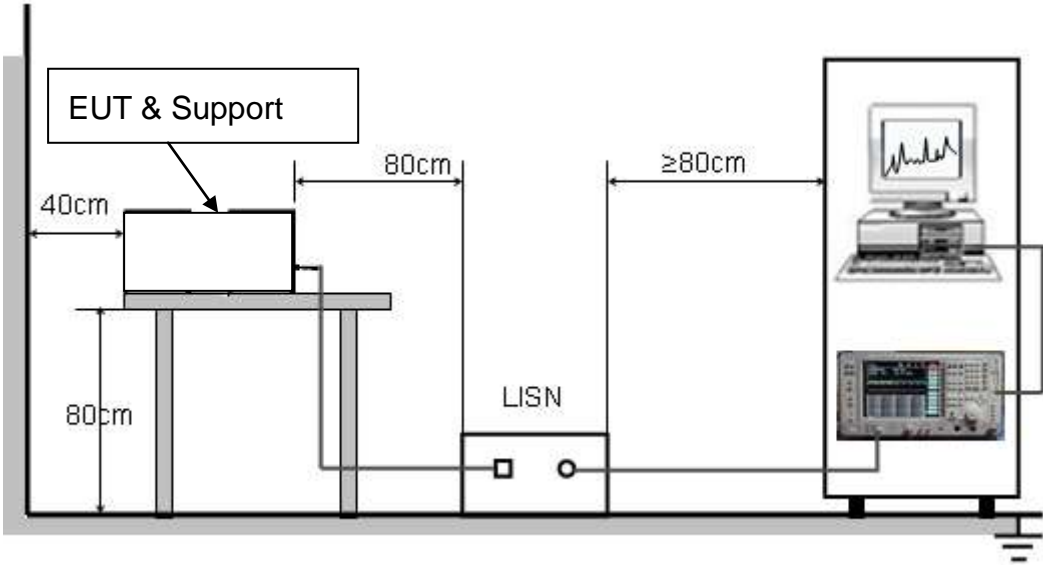

14.3. PRELIMINARY PROCEDURE OF LINE CONDUCTED EMISSION TEST

1. The equipment was set up as per the test configuration to simulate typical actual usage per the user's manual. When the EUT is a tabletop system, a wooden table with a height of 0.8 meters is used and is placed on the ground plane as per ANSI C63.4 (see Test Facility for the dimensions of the ground plane used). When the EUT is a floor-standing equipment, it is placed on the ground plane which has a 3-12 mm non-conductive covering to insulate the EUT from the ground plane.
2. Support equipment, if needed, was placed as per ANSI C63.4.
3. All I/O cables were positioned to simulate typical actual usage as per ANSI C63.4.
4. All support equipments received AC120V/60Hz power from a LISN, if any.
5. The EUT received charging voltage by adapter which received 120V/60Hz power by a LISN..
6. The test program was started. Emissions were measured on each current carrying line of the EUT using a spectrum Analyzer / Receiver connected to the LISN powering the EUT. The LISN has two monitoring points: Line 1 (Hot Side) and Line 2 (Neutral Side). Two scans were taken: one with Line 1 connected to Analyzer / Receiver and Line 2 connected to a 50 ohm load; the second scan had Line 1 connected to a 50 ohm load and Line 2 connected to the Analyzer / Receiver.
7. Analyzer / Receiver scanned from 150 kHz to 30MHz for emissions in each of the test modes.
8. During the above scans, the emissions were maximized by cable manipulation.
9. The test mode(s) were scanned during the preliminary test.

Then, the EUT configuration and cable configuration of the above highest emission level were recorded for reference of final testing.

14.4. FINAL PROCEDURE OF LINE CONDUCTED EMISSION TEST

1. EUT and support equipment was set up on the test bench as per step 2 of the preliminary test.
2. A scan was taken on both power lines, Line 1 and Line 2, recording at least the six highest emissions. Emission frequency and amplitude were recorded into a computer in which correction factors were used to calculate the emission level and compare reading to the applicable limit. If EUT emission level was less -2dB to the A.V. limit in Peak mode, then the emission signal was re-checked using Q.P and Average detector.
3. The test data of the worst case condition(s) was reported on the Summary Data page.

The test modes were carried out for all operation modes

The worst test data (test mode) was showed as the follow:

14.5. TEST RESULT OF LINE CONDUCTED EMISSION TEST

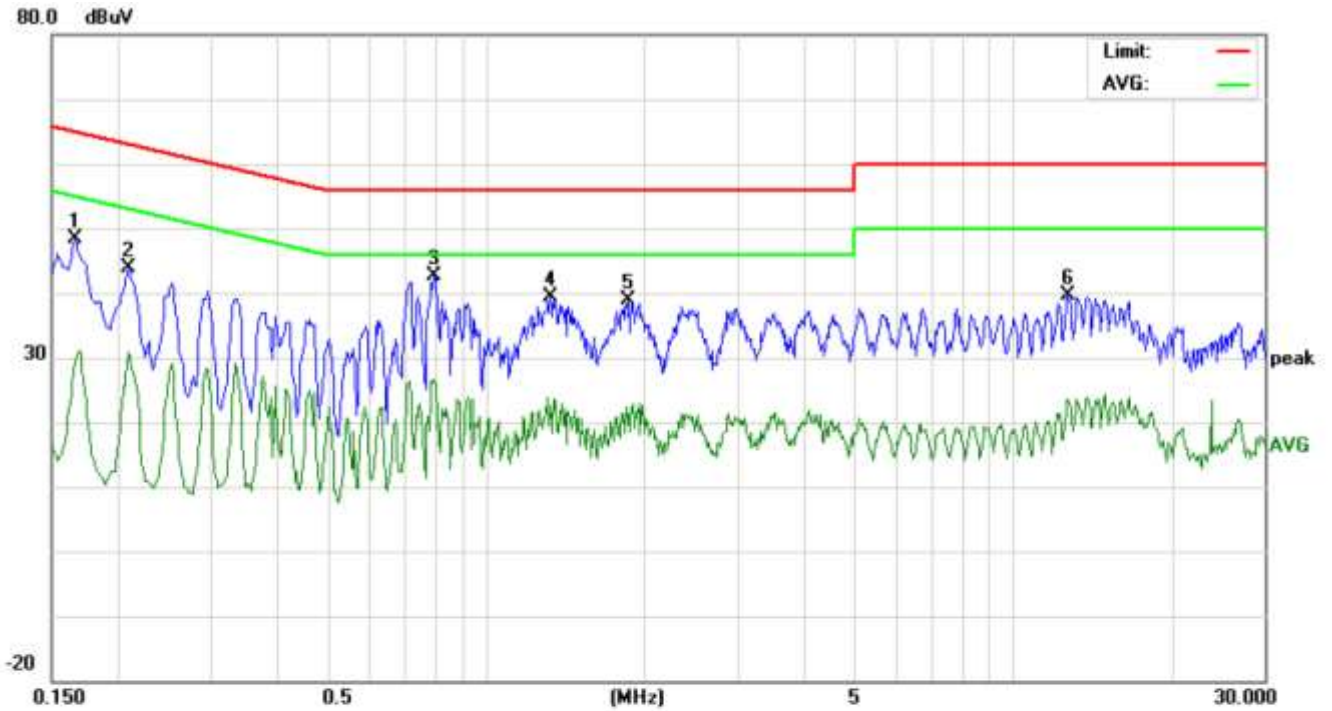

Site: Conduction Phase: **L1** Temperature: 26
 Limit: FCC Class B Conduction(QP) Power: Humidity: 60 %
 EUT: evoLution
 M/N: HHRT4
 Mode: Mode 1
 Note:

No.	Freq. (MHz)	Reading_Level (dBuV)			Correct Factor (dB)	Measurement (dBuV)			Limit (dBuV)		Margin (dB)		P/F	Comment
		Peak	QP	AVG		Peak	QP	AVG	QP	AVG	QP	AVG		
1	0.1660	38.31		19.39	10.18	48.49		29.57	65.15	55.15	-16.66	-25.58	P	
2	0.2100	33.55		20.56	10.23	43.78		30.79	63.20	53.20	-19.42	-22.41	P	
3	0.7980	32.46		16.28	10.28	42.74		26.56	56.00	46.00	-13.26	-19.44	P	
4	1.3260	29.08		12.28	10.38	39.46		22.66	56.00	46.00	-16.54	-23.34	P	
5	1.8620	28.73		10.31	10.26	38.99		20.57	56.00	46.00	-17.01	-25.43	P	
6	12.7700	29.58		13.47	10.14	39.72		23.61	60.00	50.00	-20.28	-26.39	P	

APPENDIX A: PHOTOGRAPHS OF TEST SETUP
CONDUCTED EMISSION TEST SETUP



FCC RADIATED EMISSION TEST SETUP

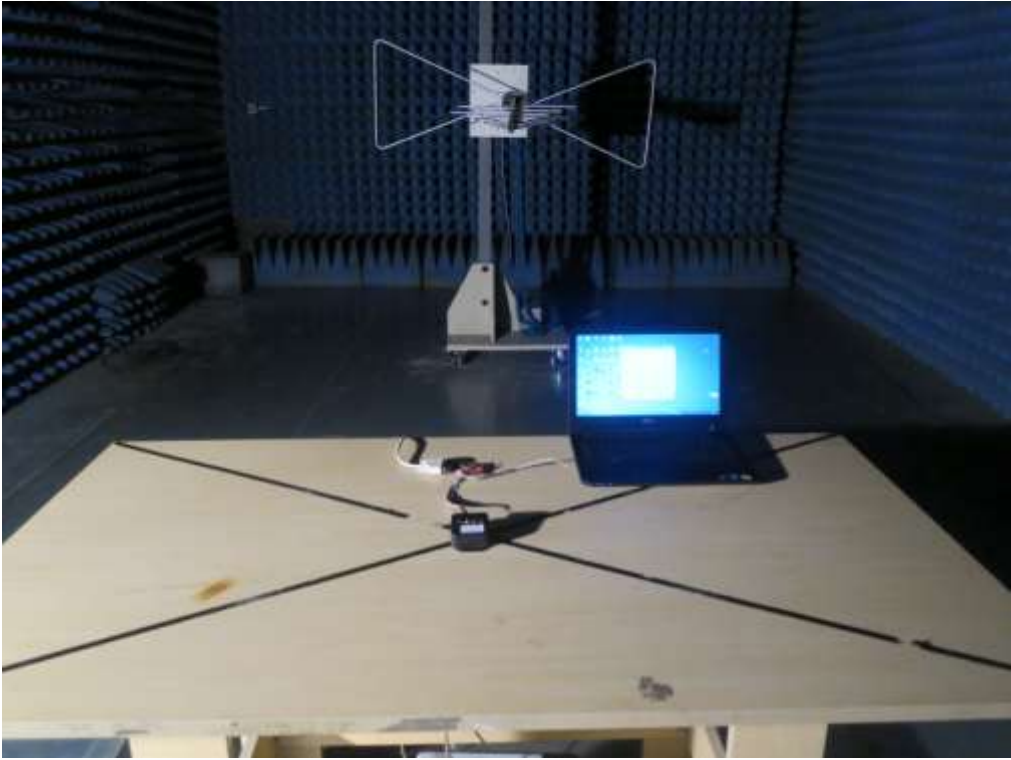

APPENDIX B: PHOTOGRAPHS OF EUT
TOP VIEW OF EUT



BOTTOM VIEW OF EUT

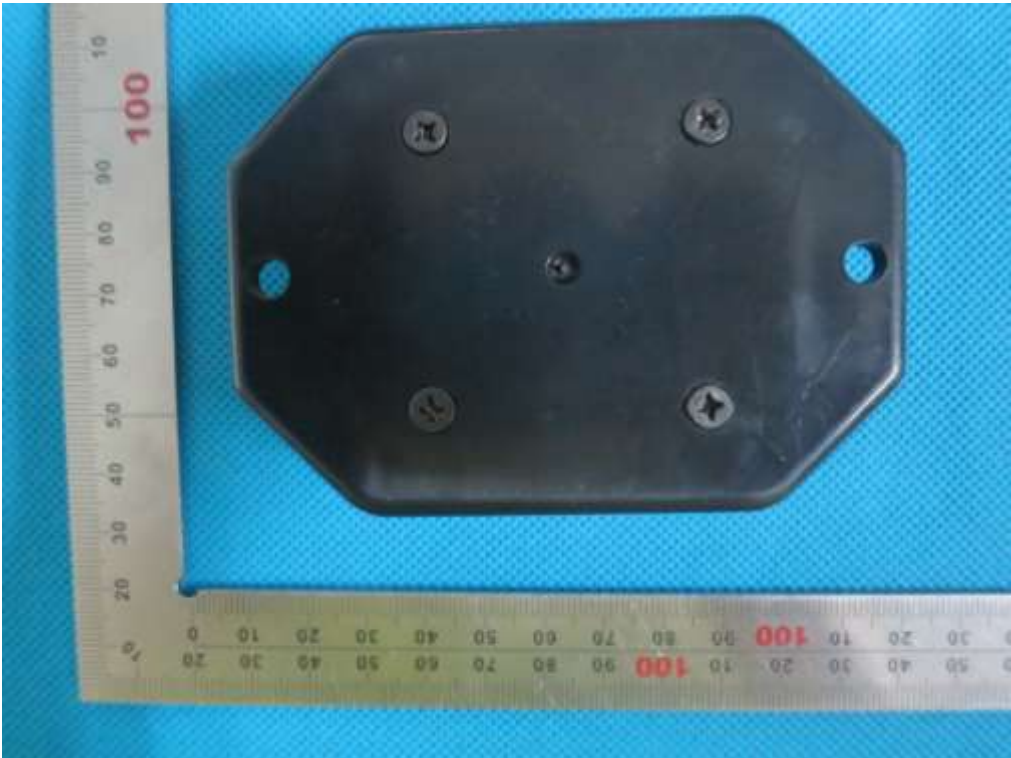

FRONT VIEW OF EUT



BACK VIEW OF EUT



LEFT VIEW OF EUT



RIGHT VIEW OF EUT



OPEN VIEW OF EUT-1



OPEN VIEW OF EUT-2

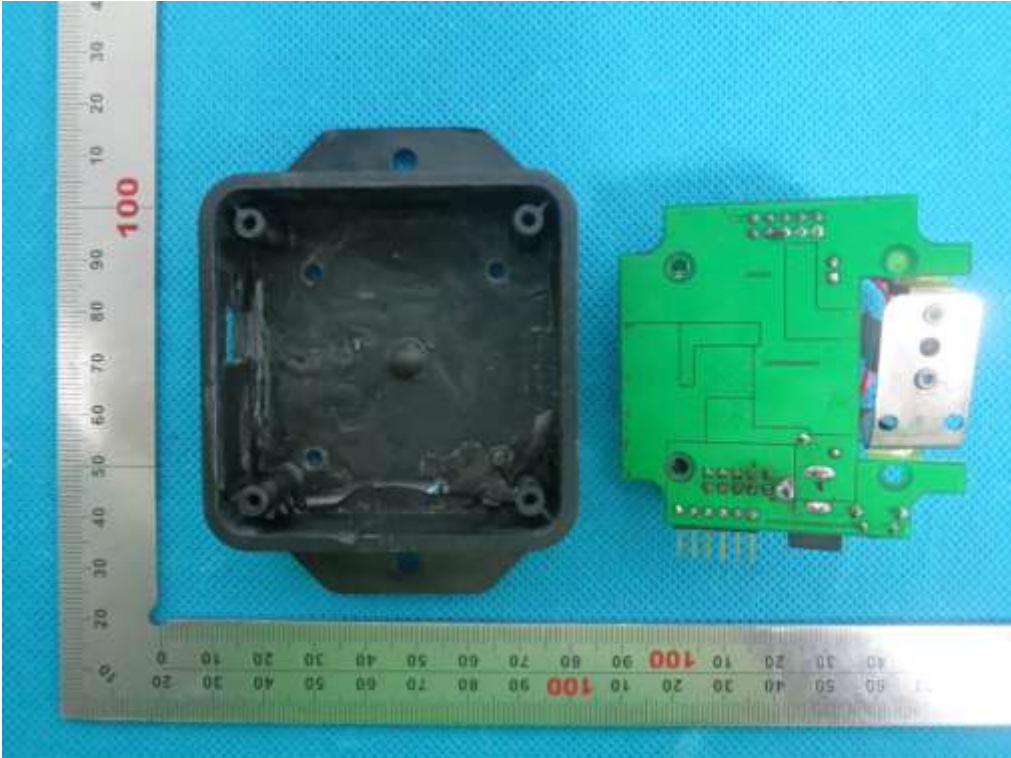

INTERNAL VIEW OF EUT-1

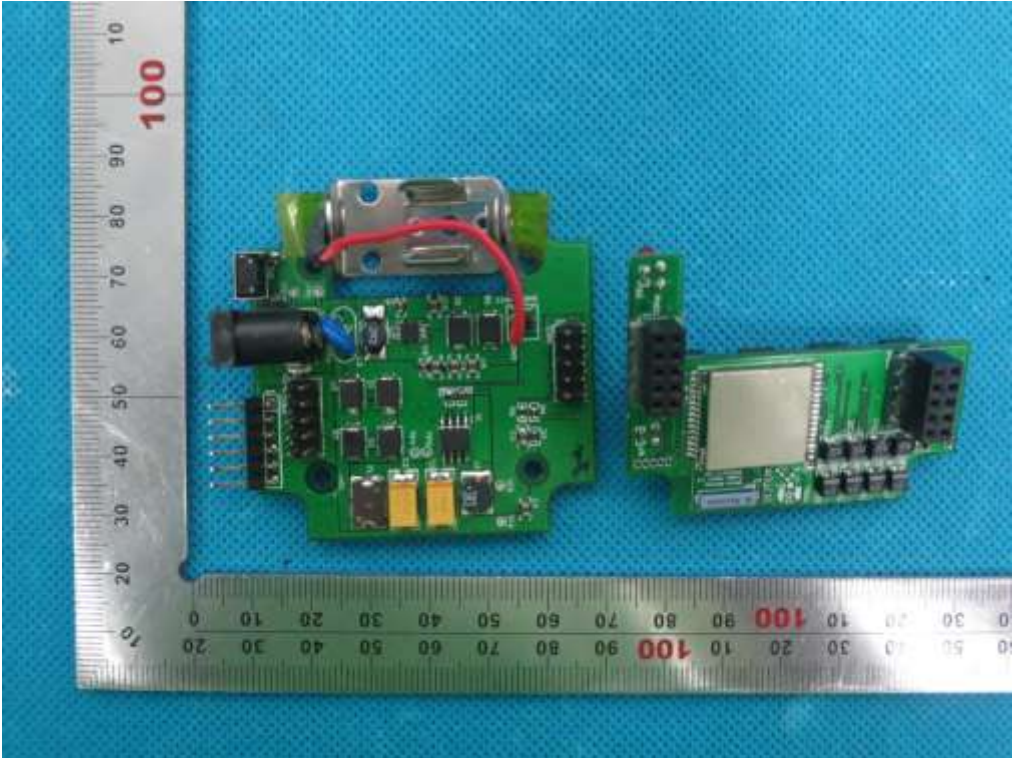

INTERNAL VIEW OF EUT-2

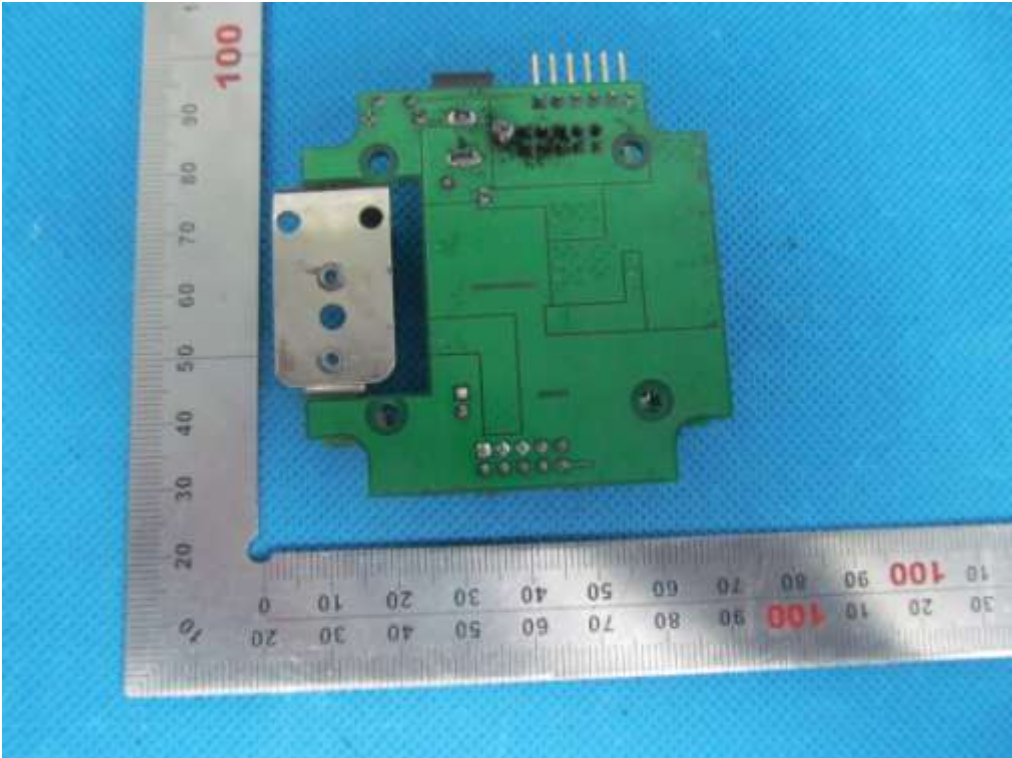

INTERNAL VIEW OF EUT-3

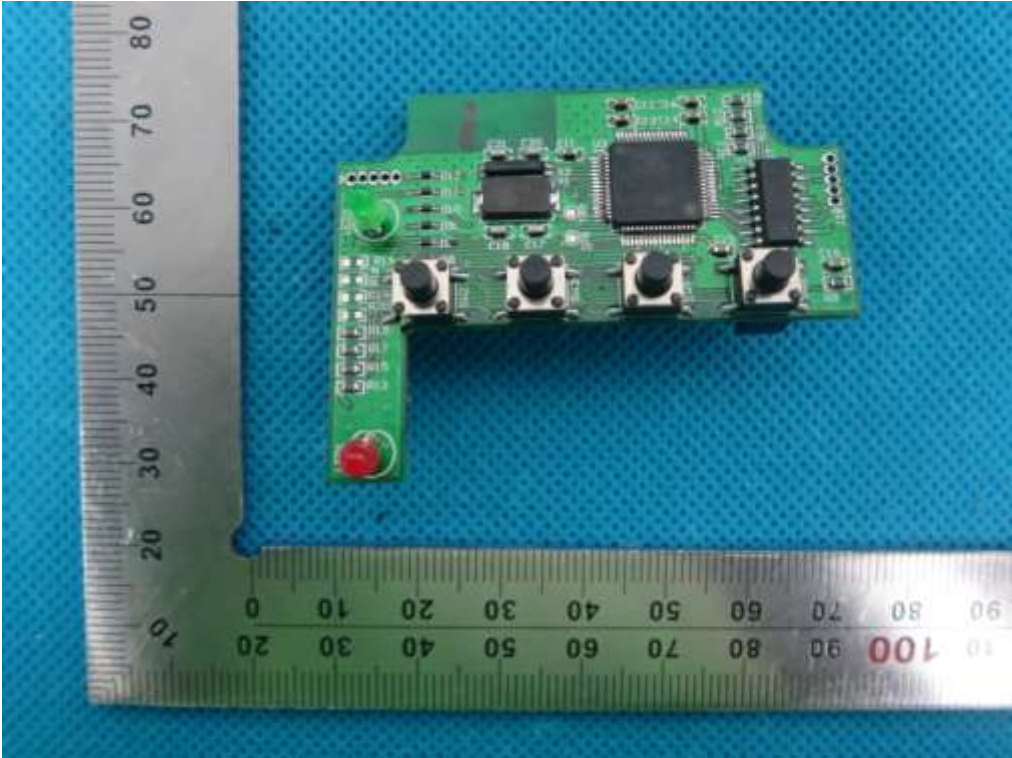

INTERNAL VIEW OF EUT-4

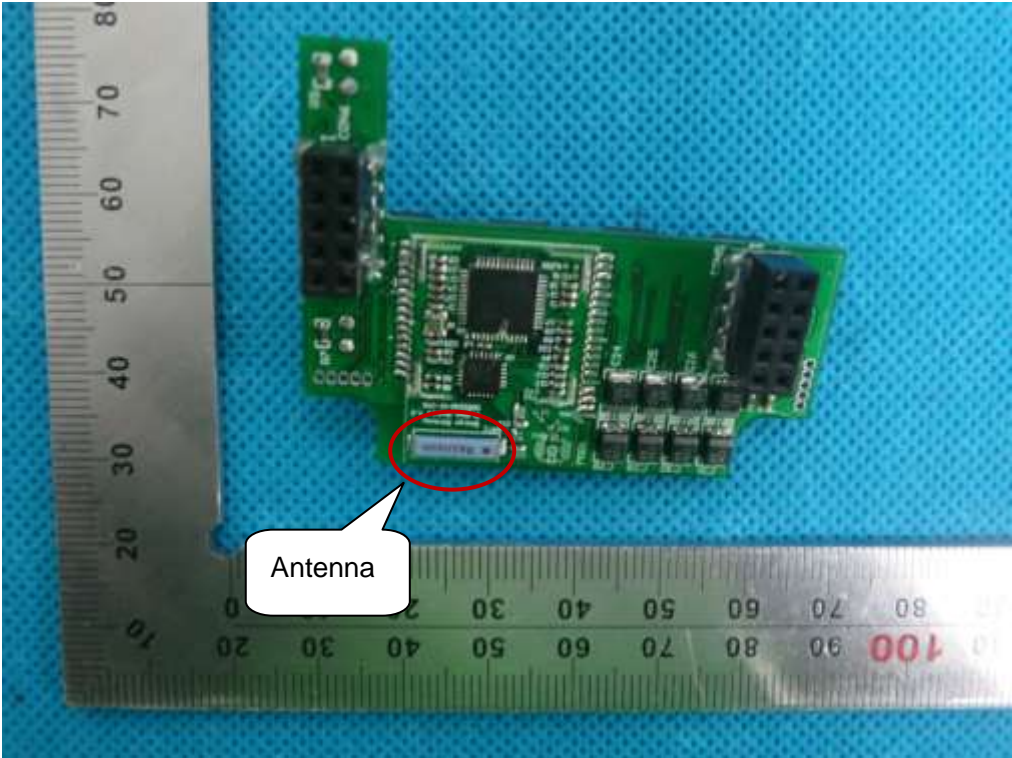

----END OF REPORT----