

FCC

SAR

TEST REPORT

ISSUED BY
Shenzhen BALUN Technology Co., Ltd.



FOR
Smart Phone

ISSUED TO
Shenzhen Huadoo Bright Group Limited

Room 13E, jinsong Buiding, Tai ran 4th Rood, chegong miao, Futian
Distrct, Shenzhen, GuangDong, China.

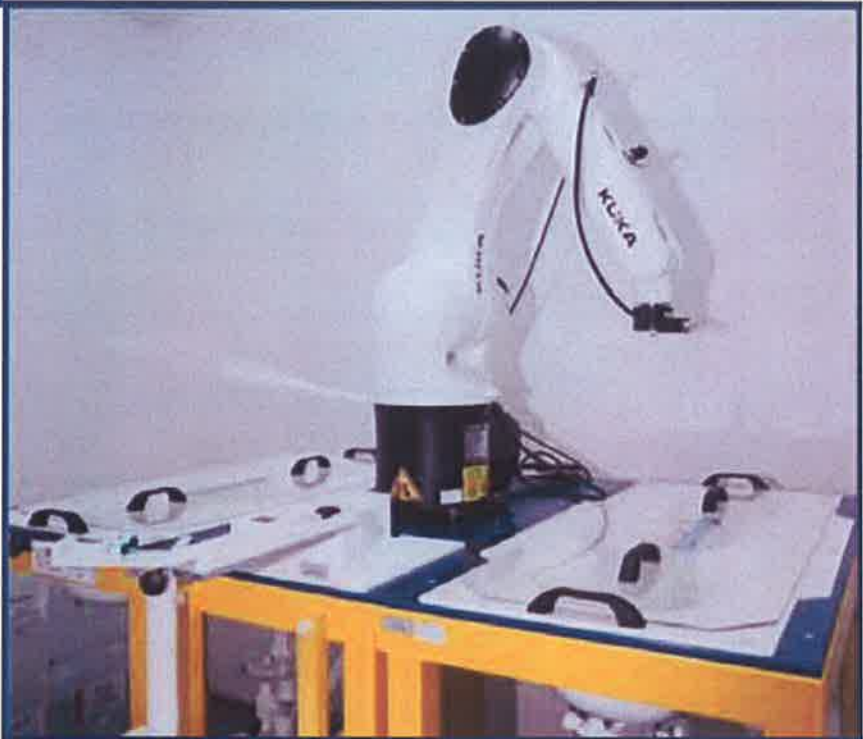

Prepared by:



Hu Jianping

(Reporting Specialist)

Date Oct 28, 2014

Approved by:

(Chief Engineer)

Date Oct 28, 2014

Report No.: BL-SZ1480032-701

EUT Type: Smart Phone

Model Name: Huadoo V3

Brand Name: Huadoo

FCC ID: 2ACXS-V3

Test Standard: FCC 47 CFR Part 2.1093

ANSI C95.1: 1992

IEEE 1528: 2013

Maximum SAR: Head: 0.707 W/Kg

Body: 1.164 W/kg

Test Conclusion: PASS

Test Date: Sep 4, 2014 ~ Sep 6, 2014

Date of Issue: Oct 28, 2014

NOTE: This test report can be duplicated completely for the legal use with the approval of the applicant; it shall not be reproduced except in full, without the written approval of Shenzhen BALUN Technology Co., Ltd. BALUN Laboratory. Any objections should be raised within thirty days from the date of issue. To validate the report, please visit BALUN website.

Block B, 1st FL, Baisha Science and Technology Park, Shahe Xi Road, Nanshan District, Shenzhen, Guangdong, P. R. China 518055

TEL: +86-755-66850100

FAX: +86-755-61824271

www.baluntek.com

Revision History

<u>Version</u>	<u>Issue Date</u>	<u>Revisions</u>
<u>Rev. 01</u>	<u>Oct 22, 2014</u>	<u>Initial Issue</u>
<u>Rev. 01</u>	<u>Oct 28, 2014</u>	<u>Update KDB 941225 published version</u>

TABLE OF CONTENTS

1 GENERAL INFORMATION 4

 1.1 Identification of the Testing Laboratory 4

 1.2 Identification of the Responsible Testing Location 4

 1.3 Test Environment Condition 4

 1.4 Announce 4

2 PRODUCT INFORMATION 6

 2.1 Applicant 6

 2.2 Manufacturer 6

 2.3 General Description for Equipment under Test (EUT) 6

 2.4 Technical Information 6

 2.5 Ancillary Equipment 7

3 SUMMARY OF TEST RESULTS 8

 3.1 Test Standards 8

 3.2 Summary Of SAR Value 9

 3.3 Device Category And SAR Limit 10

 3.4 SAR Test Uncertainty 11

4 SAR MEASUREMENT SYSTEM 12

 4.1 Definition of Specific Absorption Rate (SAR) 12

 4.2 SATIMO SAR System 12

5 SYSTEM VERIFICATION 20

 5.1 Antenna Port Test Requirement 20

 5.2 Purpose of System Check 20

 5.3 System Check Setup 20

 5.4 System Verification Results 21

6 EUT TEST POSITION CONFIGURATIONS 22

 6.1 Head Exposure Conditions 22

 6.2 Body-worn Position Conditions 23

6.3	Hotspot Mode Exposure Position Conditions	24
7	SAR MEASUREMENT PROCEDURES	25
7.1	SAR Measurement Process Diagram	25
7.2	SAR Scan General Requirements	26
7.3	SAR Measurement Procedure	27
7.4	Area & Zoom Scan Procedures	27
8	CONDUCTED RF OUPUT POWER.....	28
9	EUT ANTENNA LOCATION SKETCH	30
9.1	SAR Test Exclusion Consider Table	31
9.2	10-g Extremity Exposure Consider	32
10	SAR TEST RESULTS.....	33
10.1	Head SAR.....	33
10.2	Body SAR (10mm separation)	34
10.3	SAR Measurement Variability.....	35
11	SIMULTANEOUS TRANSMISSION	36
11.1	Simultaneous Transmission Mode Consider	36
11.2	Estimated SAR Calculation.....	36
11.3	Sum SAR of Simultaneous Transmission	37
12	TEST EQUIPMENTS LIST	38
13	REFERENCES	39
ANNEX A	SAR TEST RESULT OF SYSTEM VERIFICAION.....	40
ANNEX B	SAR TEST SETUP PHOTOS.....	52
ANNEX C	SAR MEASUREMENT RESULT	57
ANNEX D	CALIBRATION FOR PROBE AND DIPOLE	114

1 GENERAL INFORMATION

1.1 Identification of the Testing Laboratory

Company Name	Shenzhen BALUN Technology Co., Ltd.
Address	Block B, 1st FL, Baisha Science and Technology Park, Shahe Xi Road, Nanshan District, Shenzhen, Guangdong Province, P. R. China
Phone Number	+86 755 6683 3402
Fax Number	+86 755 6182 4271

1.2 Identification of the Responsible Testing Location

Test Location	Shenzhen BALUN Technology Co., Ltd.
Address	Block B, 1st FL, Baisha Science and Technology Park, Shahe Xi Road, Nanshan District, Shenzhen, Guangdong Province, P. R. China
Accreditation Certificate	<p>The laboratory has been listed by Industry Canada to perform electromagnetic emission measurements. The recognition numbers of test site are 11524A-1.</p> <p>The laboratory has been listed by US Federal Communications Commission to perform electromagnetic emission measurements. The recognition numbers of test site are 832625.</p> <p>The laboratory has met the requirements of the IAS Accreditation Criteria for Testing Laboratories (AC89), has demonstrated compliance with ISO/IEC Standard 17025:2005. The accreditation certificate number is TL-588.</p> <p>The laboratory is a testing organization accredited by China National Accreditation Service for Conformity Assessment (CNAS) according to ISO/IEC 17025. The accreditation certificate number is L6791.</p>
Description	All measurement facilities used to collect the measurement data are located at Block B, FL 1, Baisha Science and Technology Park, Shahe Xi Road, Nanshan District, Shenzhen, Guangdong Province, P. R. China 518055

1.3 Test Environment Condition

Ambient Temperature	20 to 23 °C
Ambient Relative Humidity	30 to 60 %
Ambient Pressure	86 to 106 kPa

1.4 Announce

- (1) The test report is invalid if not marked with the signatures of the persons responsible for preparing and approving the test report.
- (2) The test report is invalid if there is any evidence and/or falsification.
- (3) The results documented in this report apply only to the tested sample, under the conditions and modes of

operation as described herein.

- (4) This document may not be altered or revised in any way unless done so by BALUN and all revisions are duly noted in the revisions section.
- (5) Content of the test report, in part or in full, cannot be used for publicity and/or promotional purposes without prior written approval from the laboratory.

2 PRODUCT INFORMATION

2.1 Applicant

Applicant	Shenzhen Huadoo Bright Group Limited
Address	Room 13E,jinsong Buiding,Tai ran 4th Rood,chengong miao,Futian Distrct,Shenzhen, GuangDong, China

2.2 Manufacturer

Manufacturer	Shenzhen Huadoo Bright Group Limited
Address	Room 13E,jinsong Buiding,Tai ran 4th Rood,chengong miao,Futian Distrct,Shenzhen, GuangDong, China

2.3 General Description for Equipment under Test (EUT)

EUT Type	Smart phone
Model Under the test	Huadoo V3
Series Model Name	N/A
Difference description	N/A
Hardware Version	N/A
Software Version	N/A
Dimensions	140×75×16 mm
Diagonal dimension	159 mm
Weight	230 g
Network and Wireless connectivity	2G Network GSM 850 / 1900 3G Network WCDMA 850 / 1700 WLAN, Bluetooth,
Display	TFT-LCD
Chipset	N/A

2.4 Technical Information

The requirement for the following technical information of the EUT was tested in this report:

Operating Mode	GSM: GSM Voice; GPRS Class 12; WCDMA: RMC/HSDPA/HSUPA Release 6; WLAN: 802.11 b/g/n(HT20); Bluetooth: 3.0+EDR; 4.0 Dual-mode
Frequency Range	GSM 850: 824.2 MHz ~ 848.8 MHz; GSM 1900: 1850.2 MHz ~ 1909.8 MHz; WCDMA 850: 826.4 MHz ~ 846.6 MHz; WCDMA 1700: 1712.4 MHz ~ 1752.6 MHz; WLAN 802.11b/g/n(HT20): 2412 MHz ~ 2462 MHz; WLAN 802.11n(HT40): 2422 MHz ~ 2462 MHz; Bluetooth: 2402 MHz ~ 2480 MHz
Antenna Type	WWAN: PIFA Antenna

	WLAN: PIFA Antenna Bluetooth: PIFA Antenna
Dual-SIM	Only supported dual standby; the dual SIM card share same RF circuit and NV parameter.
DTM	Not Support
Hotspot Function	Support
Environment	Uncontrolled
EUT Stage	Portable Device

2.5 Ancillary Equipment

Ancillary Equipment 1	Battery	
	Brand Name	N/A
	Model No	V3
	Serial No	N/A
	Capacitance	2800 mAh
	Rated Voltage	3.7 V
	Extreme Voltage	Low: 3.5 V / High:4.2 V
Ancillary Equipment 2	AC Adapter (Charger for Battery)	
	Brand Name	N/A
	Model No	HJ-0501000
	Serial No	(n.a. marked #1 by test site)
	Rated Input	~ 100~240V,150 mA,50/60 Hz
	Rated Output	⎓ 5 V, 1000 mA
Ancillary Equipment 3	Stereo Headset	
Ancillary Equipment 4	USB Data Cable	

3 SUMMARY OF TEST RESULTS

3.1 Test Standards

No.	Identity	Document Title
1	47 CFR Part 2	Frequency Allocations and Radio Treaty Matters; General Rules and Regulations
2	ANSI/IEEE Std. C95.1-1992	IEEE Standard for Safety Levels with Respect to Human Exposure to Radio Frequency Electromagnetic Fields, 3 kHz to 300 GHz
3	IEEE Std. 1528-2013	Recommended Practice for Determining the Peak Spatial-Average Specific Absorption Rate (SAR) in the Human Head from Wireless Communications Devices: Measurement Techniques
4	FCC KDB 447498 D01 v05r02	Mobile and Portable Device RF Exposure Procedures and Equipment Authorization Policies
5	FCC KDB 865664 D01 v01r03	SAR Measurement 100 MHz to 6 GHz
6	FCC KDB 865664 D02 v01r01	RF Exposure Reporting

3.2 Summary Of SAR Value

Highest SAR

Position	Band	Maximum Measurement SAR (W/kg)	Maximum Report SAR (W/kg)
Head	GSM 850	0.707	0.707
	GSM 1900	0.196	
	WCDMA 850	0.580	
	WCDMA 1700	0.071	
	WLAN	0.064	
Body-worn	GSM 850	1.048	1.048
	GSM 1900	0.387	
	WCDMA 850	0.568	
	WCDMA 1700	0.083	
	WLAN	0.053	
Hotspot Mode	GSM 850	1.164	1.164
	GSM 1900	0.417	
	WCDMA 850	0.568	
	WCDMA 1700	0.083	
	WLAN	0.053	

Highest Simultaneous SAR

Position	Simultaneous Configuration	Maximum Sum. 1-g Report SAR (W/kg)
Head	GSM + BT	0.816
Body-worn	GSM + BT	1.102
Hotspot Mode	GSM + BT	1.218

3.3 Device Category And SAR Limit

This device belongs to portable device category because its radiating structure is allowed to be used within 20 centimeters of the body of the user. Limit for General Population/Uncontrolled exposure should be applied for this device, it is 1.6 W/kg as averaged over any 1 gram of tissue.

Table Of Exposure Limits:

	SAR Value (W/Kg)	
	General Population/Uncontrolled Exposure	Occupational/Controlled Exposure
Whole-Body SAR (averaged over the entire body)	0.08	0.4
partial-body SAR (averaged over any 1 gram of tissue)	1.60	8.0
SAR for hands, wrists, feet and ankles (averaged over any 10 grams of tissue)	4.0	20.0

NOTE:

General Population/Uncontrolled: Locations where there is the exposure of individuals who have no knowledge or control of their exposure. General population/uncontrolled exposure limits are applicable to situations in which the general public may be exposed or in which persons who are exposed as a consequence of their employment may not be made fully aware of the potential for exposure or cannot exercise control over their exposure. Members of the general public would come under this category when exposure is not employment-related; for example, in the case of a wireless transmitter that exposes persons in its vicinity.

Occupational/Controlled: Locations where there is exposure that may be incurred by persons who are aware of the potential for exposure, In general, occupational/controlled exposure limits are applicable to situations in which persons are exposed as a consequence of their employment, who have been made fully aware of the potential for exposure and can exercise control over their exposure. This exposure category is also applicable when the exposure is of a transient nature due to incidental passage through a location where the exposure levels may be higher than the general population/uncontrolled limits, but the exposed person is fully aware of the potential for exposure and can exercise control over his or her exposure by leaving the area or by some other appropriate means.

3.4 SAR Test Uncertainty

The following measurement uncertainty levels have been estimated for tests performed on the EUT as specified in IEEE 1528: 2013. This uncertainty represents an expanded uncertainty expressed at approximately the 95% confidence level using a coverage factor of $k=2$. The system measurement uncertainty frequency range is from 300MHz to 3GHz.

Uncertainty Component	Tol (+-%)	Prob. Dist.	Div.	Ci (1g)	Ci (10g)	1g Ui (+-%)	10g Ui (+-%)	V _i
Measurement System								
Probe calibration	5.8	N	1	1	1	5.80	5.80	
Axial Isotropy	3.5	R	$\sqrt{3}$	0.7	0.7	1.41	1.41	
Hemispherical Isotropy	5.9	R	$\sqrt{3}$	0.7	0.7	2.38	2.38	
Boundary effect	1.0	R	$\sqrt{3}$	1	1	0.58	0.58	
Linearity	4.7	R	$\sqrt{3}$	1	1	2.71	2.71	
System detection limits	1.0	R	$\sqrt{3}$	1	1	0.58	0.58	
Readout Electronics	0.5	N	1	1	1	0.50	0.50	
Reponse Time	0.0	R	$\sqrt{3}$	1	1	0.00	0.00	
Integration Time	1.4	R	$\sqrt{3}$	1	1	0.81	0.81	
RF ambient Conditions - Noise	3.0	R	$\sqrt{3}$	1	1	1.73	1.73	
RF ambient Conditions - Reflections	3.0	R	$\sqrt{3}$	1	1	1.73	1.73	
Probe positioner Mechanical Tolerance	1.4	R	$\sqrt{3}$	1	1	0.81	0.81	
Probe positioning with respect to Phantom Shell	1.4	R	$\sqrt{3}$	1	1	0.81	0.81	
Extrapolation, interpolation and integration Algorithms for Max. SAR Evaluation	2.3	R	$\sqrt{3}$	1	1	1.33	1.33	
Test sample Related								
Test sample positioning	2.6	N	1	1	1	2.60	2.60	N-1
Device Holder Uncertainty	1.0	N	1	1	1	1.00	1.00	N-1
Output power Variation - SAR drift measurement	5.0	R	$\sqrt{3}$	1	1	2.89	2.89	
SAR scaling	2.00	R	$\sqrt{3}$	1	1	1.15	1.15	
Phantom and Tissue Parameters								
Phantom Uncertainty (Shape and thickness tolerances)	4.0	R	$\sqrt{3}$	1	1	2.31	2.31	
Liquid conductivity (deviation from target values)	2.5	N	$\sqrt{3}$	0.64	0.43	0.92	0.62	
Liquid conductivity - measurement uncertainty	5.0	N	1	0.64	0.43	3.20	2.15	M
Liquid permittivity (deviation from target values)	2.5	N	$\sqrt{3}$	0.60	0.49	0.87	0.71	
Liquid permittivity - measurement uncertainty	5.0	N	1	0.60	0.49	3.00	2.45	M
Combined Standard Uncertainty		RSS				10.14	9.67	
Expanded Uncertainty (95% Confidence interval)		k				20.29	19.35	

4 SAR MEASUREMENT SYSTEM

4.1 Definition of Specific Absorption Rate (SAR)

SAR is related to the rate at which energy is absorbed per unit mass in an object exposed to a radio field. The SAR distribution in a biological body is complicated and is usually carried out by experimental techniques or numerical modeling. The standard recommends limits for two tiers of groups, occupational/controlled and general population/uncontrolled, based on a person's awareness and ability to exercise control over his or her exposure. In general, occupational / controlled exposure limits are higher than the limits for general population /uncontrolled.

The SAR definition is the time derivative (rate) of the incremental energy (dW) absorbed by (dissipated in) an incremental mass (dm) contained in a volume element (dv) of a given density (ρ). The equation description is as below:

$$\text{SAR} = \frac{d}{dt} \left(\frac{dW}{dm} \right) = \frac{d}{dt} \left(\frac{dW}{\rho dv} \right)$$

SAR is expressed in units of Watts per kilogram (W/kg) SAR measurement can be related to the electrical field in the tissue by

$$\text{SAR} = \frac{\sigma E^2}{\rho}$$

Where: σ is the conductivity of the tissue,

ρ is the mass density of the tissue and E is the RMS electrical field strength.

4.2 SATIMO SAR System

SATIMO SAR System Diagram:

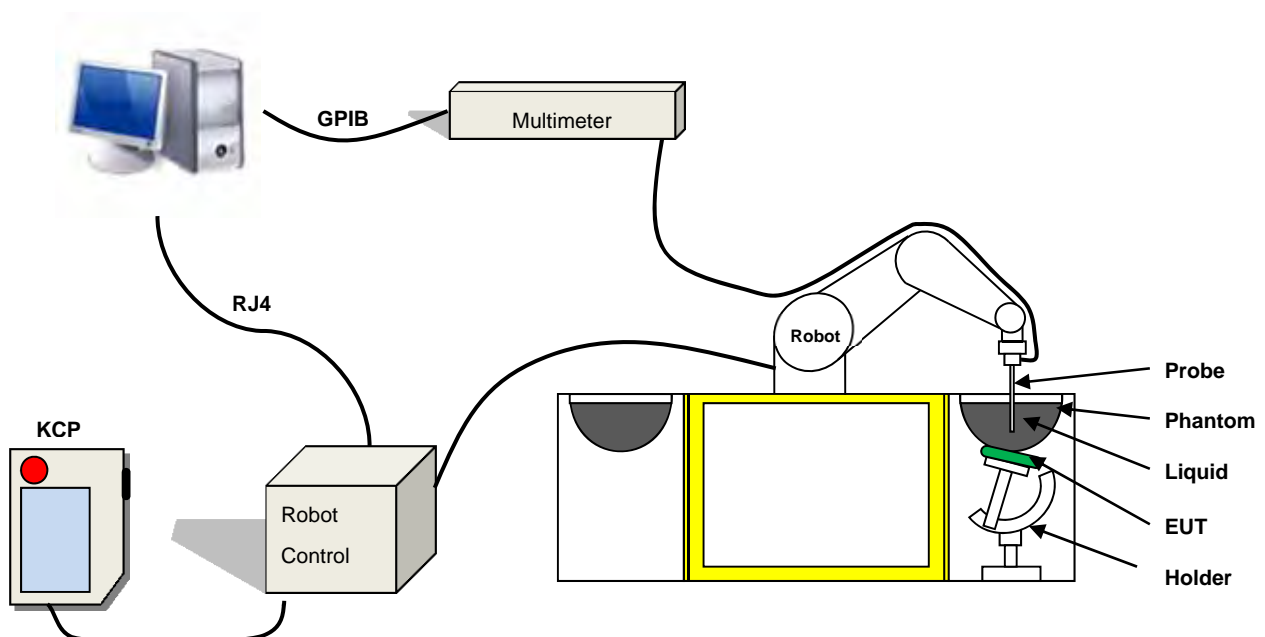

These measurements were performed with the automated near-field scanning system OPENSAR from SATIMO. The system is based on a high precision robot (working range: 850 mm), which positions the probes with a positional repeatability of better than ± 0.02 mm. Special E- and H-field probes have been developed for measurements close to material discontinuity, the sensors of which are directly loaded with a Schottky diode and connected via highly resistive lines to the data acquisition unit.

The SAR measurements were conducted with dosimetric probe (manufactured by SATIMO), designed in the classical triangular configuration and optimized for dosimetric evaluation. The probe has been calibrated according to the procedure described in SAR standard with accuracy of better than $\pm 10\%$. The spherical isotropy was evaluated with the procedure described in SAR standard and found to be better than ± 0.25 dB. The phantom used was the SAM Phantom as described in FCC supplement C, IEEE P1528 and CENELEC EN62209-1/-2.

4.2.1 Robot

The SATIMO SAR system uses the high precision robots from KUKA. For the 6-axis controller system, the robot controller version (KUKA) from KUKA is used. The KUKA robot series have many features that are important for our application:



- High precision (repeatability ± 0.035 mm)
- High reliability (industrial design)
- Jerk-free straight movements
- Low ELF interference (the closed metallic construction shields against motor control fields)

4.2.2 E-Field Probe

For the measurements the Specific Dosimetric E-Field Probe SN 17/13 EPG177 with following specifications is used

- Dynamic range: 0.01-100 W/kg
 - Tip Diameter : 2.5 mm
 - Distance between probe tip and sensor center: 1.0mm
 - Distance between sensor center and the inner phantom surface: 4 mm
- (repeatability better than ± 1 mm)

- Probe linearity: +/- 0.06 dB
 - Axial Isotropy: < 0.15 dB
 - Spherical Isotropy: < 0.15 dB
 - Calibration range: 450MHz to 5800MHz for head & body simulating liquid.
- Angle between probe axis (evaluation axis) and surface normal line: less than 30 °



E-Field Probe Calibration Process

Probe calibration is realized, in compliance with CENELEC EN 62209-1/-2 and IEEE 1528 std, with CALISAR, Antennessa proprietary calibration system. The calibration is performed with the EN 62209-1/2 annexe technique using reference guide at the five frequencies.

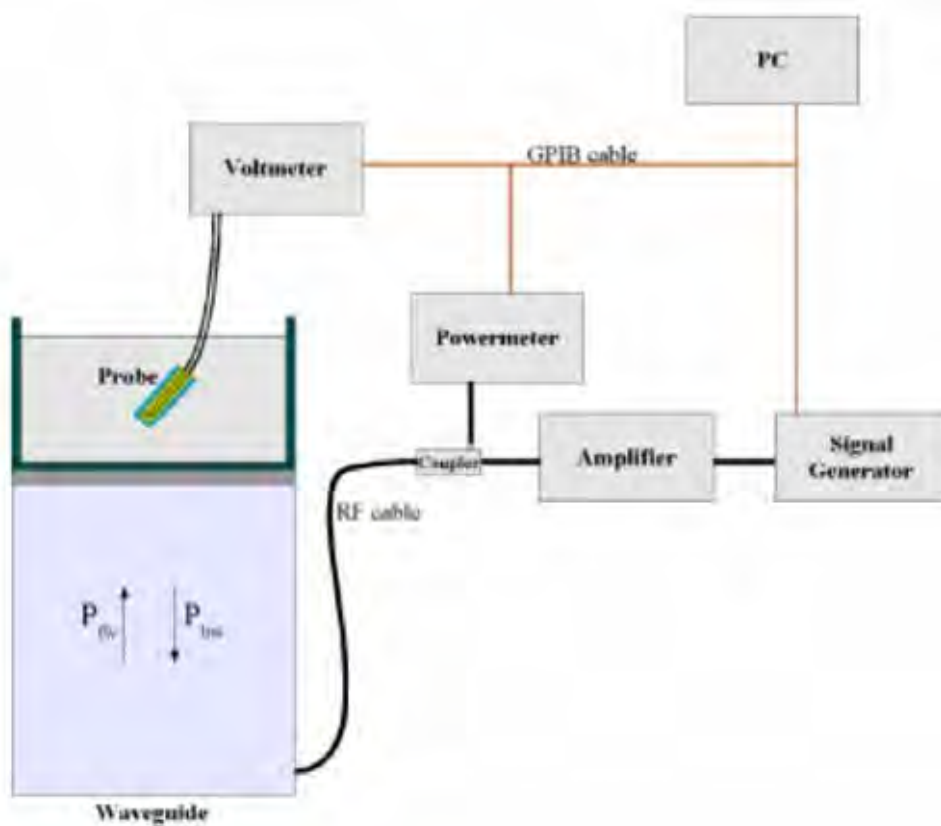

$$SAR = \frac{4(P_{fw} - P_{bw})}{ab\sigma} \cos^2 \left(\pi \frac{y}{a} \right) c^{(2\pi/\sigma)}$$

Where :

P_{fw} = Forward Power

P_{bw} = Backward Power

a and b = Waveguide dimensions

σ = Skin depth

Keithley configuration:

Rate = Medium; Filter =ON; RDGS=10; FILTER TYPE =MOVING AVERAGE; RANGE AUTO After each calibration, a SAR measurement is performed on a validation dipole and compared with a NPL calibrated probe, to verify it.

The calibration factors, $CF(N)$, for the 3 sensors corresponding to dipole 1, dipole 2 and dipole 3 are:

$$CF(N)=SAR(N)/V_{lin}(N) \quad (N=1,2,3)$$

The linearised output voltage $V_{lin}(N)$ is obtained from the displayed output voltage $V(N)$ using

$$V_{lin}(N)=V(N)*(1+V(N)/DCP(N)) \quad (N=1,2,3)$$

Where the DCP is the diode compression point in mV.

4.2.3 Phantoms

For the measurements the Specific Anthropomorphic Mannequin (SAM) defined by the IEEE SCC-34/SC2 group is used. The phantom is a polyurethane shell integrated in a wooden table. The thickness of the phantom amounts to 2mm +/- 0.2mm. It enables the dosimetric evaluation of left and right phone usage and includes an additional flat phantom part for the simplified performance check. The phantom set-up includes a cover, which prevents the evaporation of the liquid.

Photo of Phantom SN 30/13 SAM103



Photo of Phantom SN 30/13 SAM104



Serial Number	Positioner Material	Permittivity	Loss Tangent
SN 30/13 SAM103	Gelcoat with fiberglass	3.4	0.02
SN 30/13 SAM104	Gelcoat with fiberglass	3.4	0.02

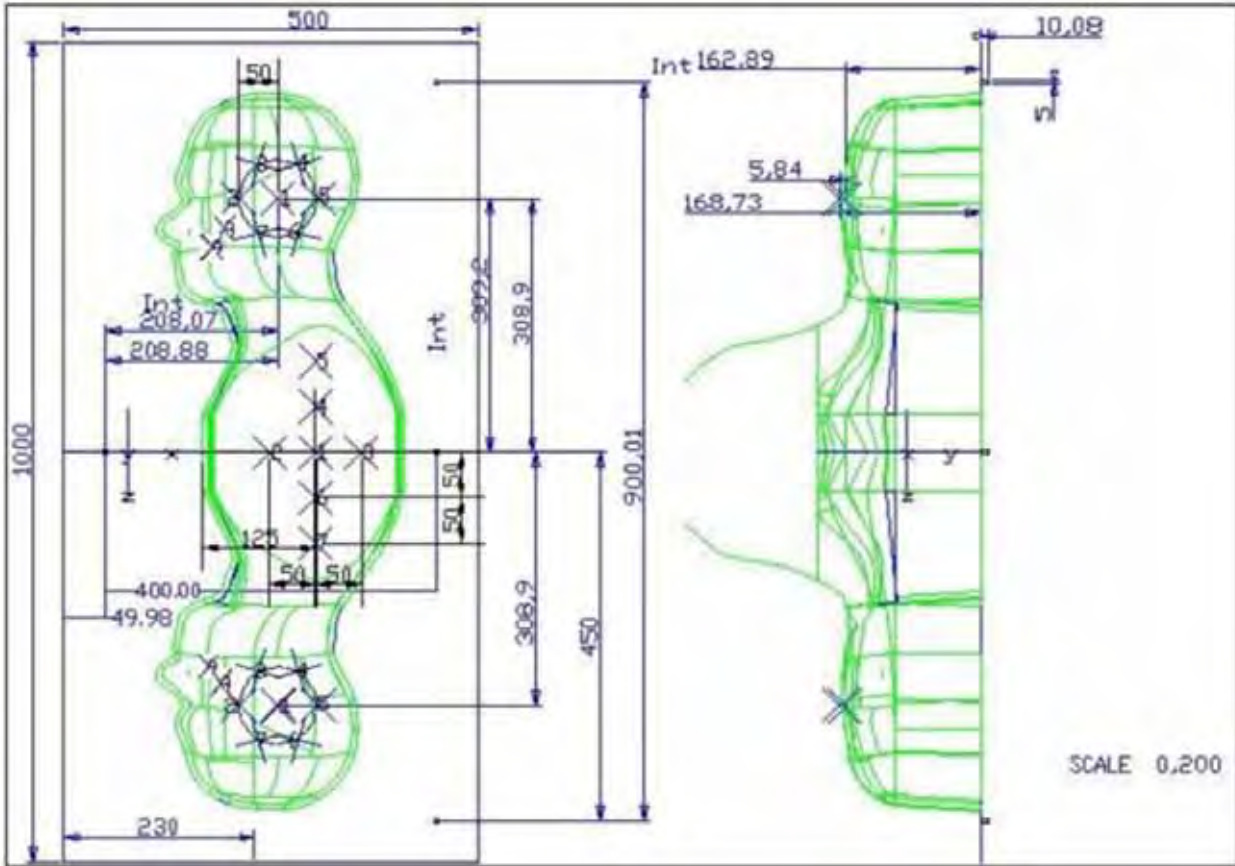

Serial Number	Left Head		Right Head		Flat Part	
SN 30/13 SAM103	2	2.00	2	2.03	1	2.09
	3	2.02	3	2.05	2	2.10
	4	2.04	4	2.04	3	2.09
	5	2.04	5	2.07	4	2.11
	6	2.02	6	2.07	5	2.11
	7	2.01	7	2.09	6	2.09
	8	2.04	8	2.10	7	2.11
	9	2.02	9	2.09	-	-
	SN 30/13 SAM104	2	2.05	2	2.06	1
3		2.08	3	2.03	2	2.03
4		2.05	4	2.03	3	2.01
5		2.06	5	2.02	4	2.03
6		2.08	6	2.02	5	2.03
7		2.06	7	2.04	6	2.00
8		2.07	8	2.04	7	1.98
9		2.07	9	2.05	-	-

4.2.4 Device Holder

The SAR in the phantom is approximately inversely proportional to the square of the distance between the source and the liquid surface. For a source at 5 mm distance, a positioning uncertainty of ± 0.5 mm would produce a SAR uncertainty of ± 20 %. Accurate positioning is therefore crucial for accurate and repeatable measurements. The positions in which the devices must be measured are defined by the standards.



Serial Number	Holder Material	Permittivity	Loss Tangent
SN 25/13 MSH87	Deirin	3.7	0.005
SN 25/13 MSH88	Deirin	3.7	0.005

The positioning system allows obtaining cheek and tilting position with a very good accuracy. In compliance with CENELEC, the tilt angle uncertainty is lower than 1° .

4.2.5 Simulating Liquid

For SAR measurement of the field distribution inside the phantom, the phantom must be filled with homogeneous tissue simulating liquid to a depth of at least 15 cm. For head SAR testing, the liquid height from the ear reference point (ERP) of the phantom to the liquid top surface is larger than 15 cm. For body SAR testing, the liquid height from the center of the flat phantom to the liquid top surface is larger than 15 cm. The nominal dielectric values of the tissue simulating liquids in the phantom and the tolerance of 5%.

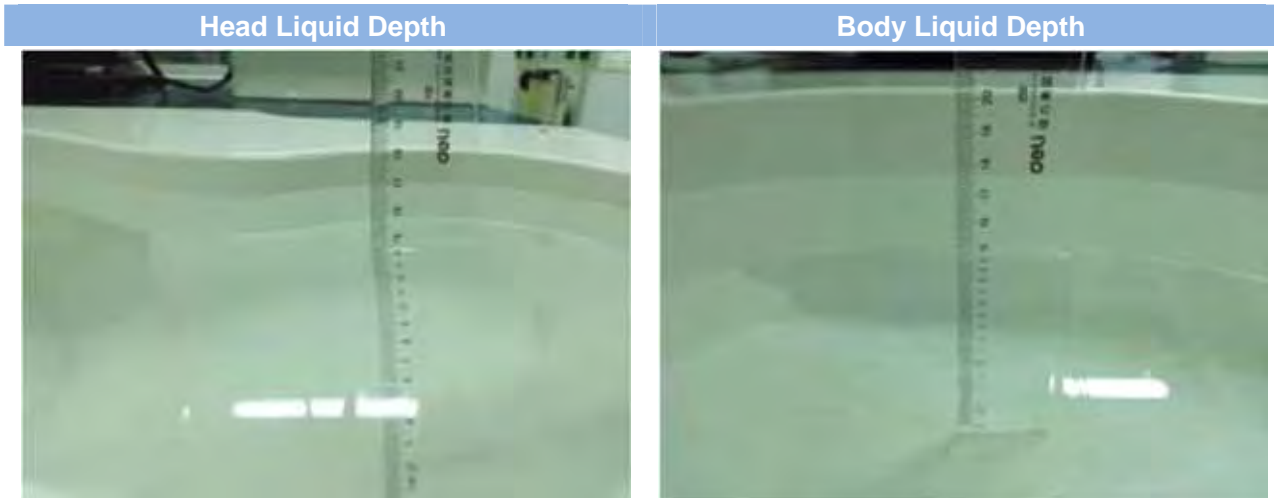

The following table gives the recipes for tissue simulating liquid.

Frequency (MHz)	Water	Sugar	Cellulose	Salt	Preventol	DGBE	Conductivity	Permittivity
	%	%	%	%	%	%	σ	ϵ
Head								
750	41.1	57.0	0.2	1.4	0.2	0	0.89	41.9
835	40.3	57.9	0.2	1.4	0.2	0	0.90	41.5
900	40.3	57.9	0.2	1.4	0.2	0	0.97	41.5
1800, 1900, 2000	55.2	0	0	0.3	0	44.5	1.4	40.0
2450	55.0	0	0	0	0	45.0	1.80	39.2
Body								
750	51.7	47.2	0	0.9	0.1	0	0.96	55.5
835	50.8	48.2	0	0.9	0.1	0	0.97	55.2
900	50.8	48.2	0	0.9	0.1	0	1.05	55.0
1800, 1900, 2000	70.2	0	0	0.4	0	29.4	1.52	53.3
2450	68.6	0	0	0	0	31.4	1.95	52.7

4.2.6 Simulating Liquid Validation

The dielectric parameters of the liquids were verified prior to the SAR evaluation using an SATIMO SCLMP Dielectric Probe Kit and an RS Network Analyzer.

Date	Liquid Type	Freq. (MHz)	Temp. ()	Meas. Conductivity (σ)	Meas. Permittivity (ϵ)	Target conductivity (σ)	Target Permittivity (ϵ)	Conductivity tolerance (%)	Permittivity tolerance (%)
2014. 9. 4	Head	835	22.3	0.92	40.40	0.90	41.50	2.22	-2.65
2014. 9. 5	Body	835	22.3	0.99	55.26	0.97	55.20	2.06	0.11
2014. 9. 4	Head	1900	22.3	1.42	41.00	1.40	40.00	1.43	2.50
2014. 9. 5	Body	1900	22.3	1.55	54.20	1.52	53.30	1.97	1.69
2014. 9. 4	Head	2450	22.3	1.79	39.31	1.80	39.20	-0.56	0.28
2014. 9. 6	Body	2450	22.3	1.97	53.12	1.95	52.70	1.03	0.80

Note:

1. The tolerance limit of Conductivity and Permittivity is $\pm 5\%$.

5 SYSTEM VERIFICATION

5.1 Antenna Port Test Requirement

The SATIMO SAR system is equipped with one or more system validation kits. These units together with the predefined measurement procedures within the SATIMO software enable the user to conduct the system performance check and system validation. System validation kit includes a dipole, tripod holder to fix it underneath the flat phantom and a corresponding distance holder.

5.2 Purpose of System Check

The system performance check verifies that the system operates within its specifications. System and operator errors can be detected and corrected. It is recommended that the system performance check be performed prior to any usage of the system in order to guarantee reproducible results. The system performance check uses normal SAR measurements in a simplified setup with a well characterized source. This setup was selected to give a high sensitivity to all parameters that might fail or vary over time. The system check does not intend to replace the calibration of the components, but indicates situations where the system uncertainty is exceeded due to drift or failure.

5.3 System Check Setup

In the simplified setup for system evaluation, the EUT is replaced by a calibrated dipole and the power source is replaced by a continuous wave that comes from a signal generator. The calibrated dipole must be placed beneath the flat phantom section of the SAM twin phantom with the correct distance holder. The distance holder should touch the phantom surface with a light pressure at the reference marking and be oriented parallel to the long side of the phantom. The equipment setup is shown below:

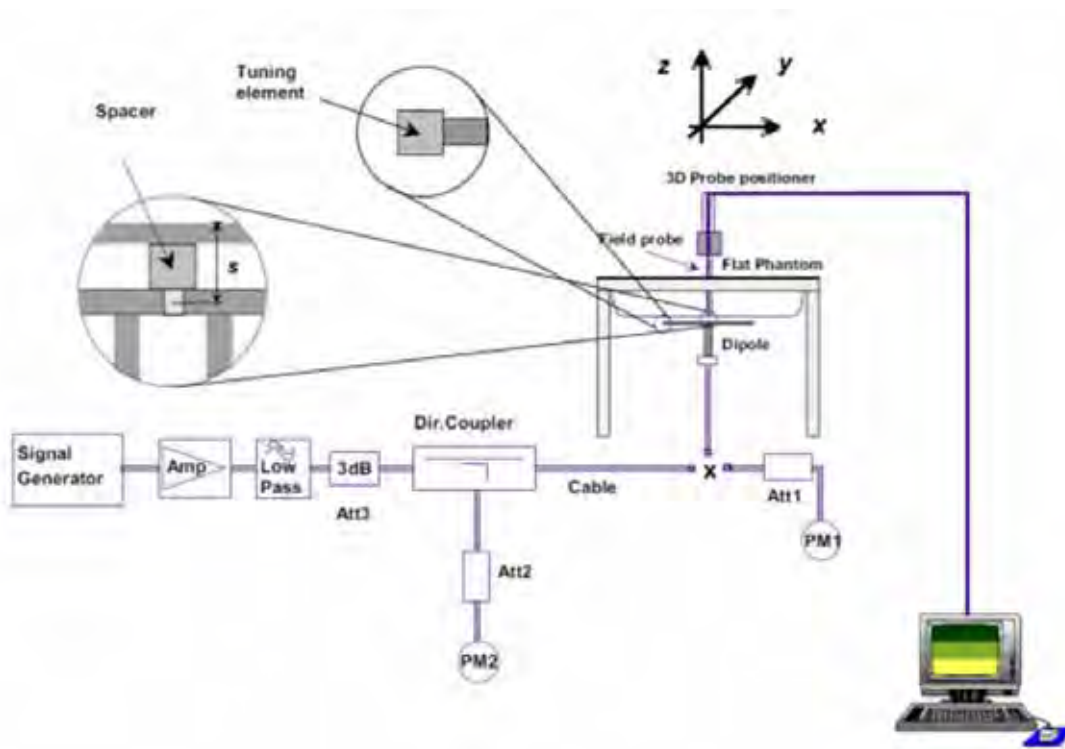

5.4 System Verification Results

Comparing to the original SAR value provided by SATIMO, the validation data should be within its specification of 10 %.

Date	Liquid Type	Freq. (MHz)	Power (mW)	Measured SAR (W/kg)	Normalized SAR (W/kg)	Dipole SAR (W/kg)	Tolerance (%)	Targeted SAR(W/kg)	Tolerance (%)
2014. 9. 4	Head	835	100	0.937	9.37	9.71	-3.50	9.50	-1.37
2014. 9. 5	Body	835	100	1.008	10.08	10.19	4.81	9.56	5.44
2014. 9. 4	Head	1900	100	3.774	37.74	40.01	-5.67	39.70	-4.94
2014. 9. 5	Body	1900	100	4.142	41.42	40.32	2.73	39.70	4.33
2014. 9. 4	Head	2450	100	5.393	53.93	53.96	-0.06	52.40	2.92
2014. 9. 6	Body	2450	100	5.123	51.23	52.37	-2.18	52.40	-2.23

Note:

1. The tolerance limit of System validation $\pm 10\%$.

6 EUT TEST POSITION CONFIGURATIONS

According to KDB 648474 D04 Handset v01r02, handsets are tested for SAR compliance in head, body-worn accessory and other use configurations described in the following subsections.

6.1 Head Exposure Conditions

Head exposure is limited to next to the ear voice mode operations. Head SAR compliance is tested according to the test positions defined in IEEE Std 1528-2013 using the SAM phantom illustrated as below.

6.1.1 Define two imaginary lines on the handset

- The vertical centerline passes through two points on the front side of the handset - the midpoint of the width w_t of the handset at the level of the acoustic output, and the midpoint of the width w_b of the bottom of the handset.
- The horizontal line is perpendicular to the vertical centerline and passes through the center of the acoustic output. The horizontal line is also tangential to the face of the handset at point A.
- The two lines intersect at point A. Note that for many handsets, point A coincides with the center of the acoustic output; however, the acoustic output may be located elsewhere on the horizontal line. Also note that the vertical centerline is not necessarily parallel to the front face of the handset, especially for clamshell handsets, handsets with flip covers, and other irregularly shaped handsets.

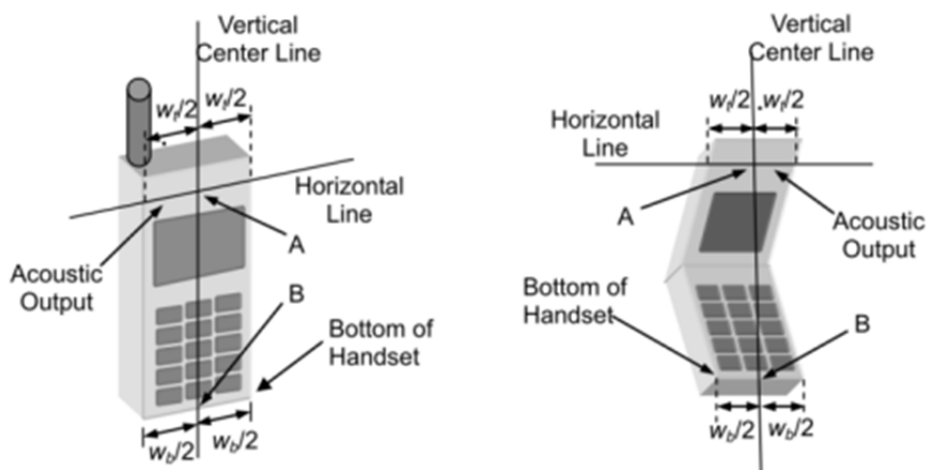

6.1.2 Cheek Position

- To position the device with the vertical center line of the body of the device and the horizontal line crossing the center piece in a plane parallel to the sagittal plane of the phantom. While maintaining the device in this plane, align the vertical center line with the reference plane containing the three ear and mouth reference point (M: Mouth, RE: Right Ear, and LE: Left Ear) and align the center of the ear piece with the line RE-LE.
- To move the device towards the phantom with the ear piece aligned with the line LE-RE until the phone touched the ear. While maintaining the device in the reference plane and maintaining the phone contact with the ear, move the bottom of the phone until any point on the front side is in contact with the cheek of the phantom or until contact with the ear is lost.

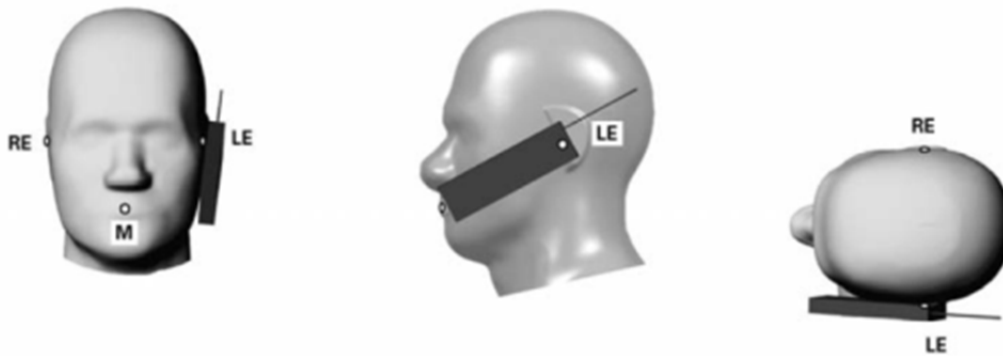

6.1.3 Tilted Position

- (a) To position the device in the “cheek” position described above.
- (b) While maintaining the device the reference plane described above and pivoting against the ear, moves it outward away from the mouth by an angle of 15 degrees or until contact with the ear is lost.

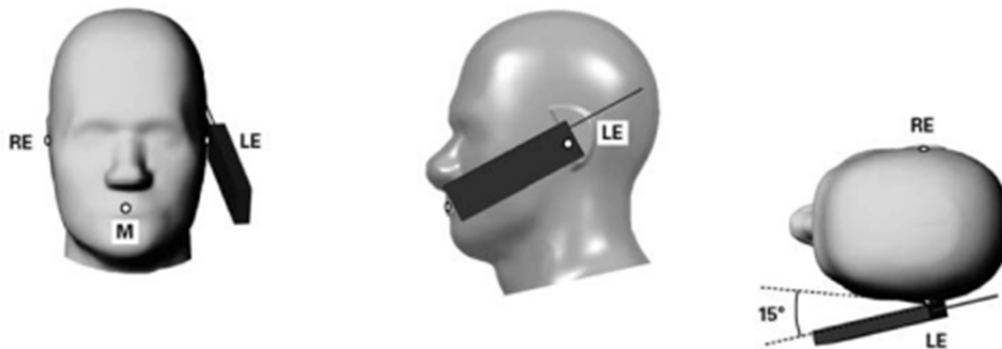

6.2 Body-worn Position Conditions

Body-worn accessory exposure is typically related to voice mode operations when handsets are carried in body-worn accessories. The body-worn accessory procedures in KDB 447498 are used to test for body-worn accessory SAR compliance, without a headset connected to it. This enables the test results for such configuration to be compatible with that required for hotspot mode when the body-worn accessory test separation distance is greater than or equal to that required for hotspot mode. When the reported SAR for a body-worn accessory, measured without a headset connected to the handset, is > 1.2 W/kg, the highest reported SAR configuration for that wireless mode and frequency band should be repeated for that body-worn accessory with a headset attached to the handset.

Body-worn accessories that do not contain metallic or conductive components may be tested according to worst-case exposure configurations, typically according to the smallest test separation distance required for the group of body-worn accessories with similar operating and exposure characteristics. All body-worn accessories containing metallic components are tested in conjunction with the host device.

Body-worn accessory SAR compliance is based on a single minimum test separation distance for all wireless and operating modes applicable to each body-worn accessory used by the host, and according to the relevant voice and/or data mode transmissions and operations. If a body-worn accessory supports voice only operations in its normal and expected use conditions, testing of data mode for body-worn compliance is not required. A conservative minimum test separation distance for supporting off-the-shelf body-worn accessories that may be

acquired by users of consumer handsets is used to test for body-worn accessory SAR compliance. This distance is determined by the handset manufacturer, according to the requirements of Supplement C 01-01. Devices that are designed to operate on the body of users using lanyards and straps, or without requiring additional body-worn accessories, will be tested using a conservative minimum test separation distance ≤ 5 mm to support compliance.

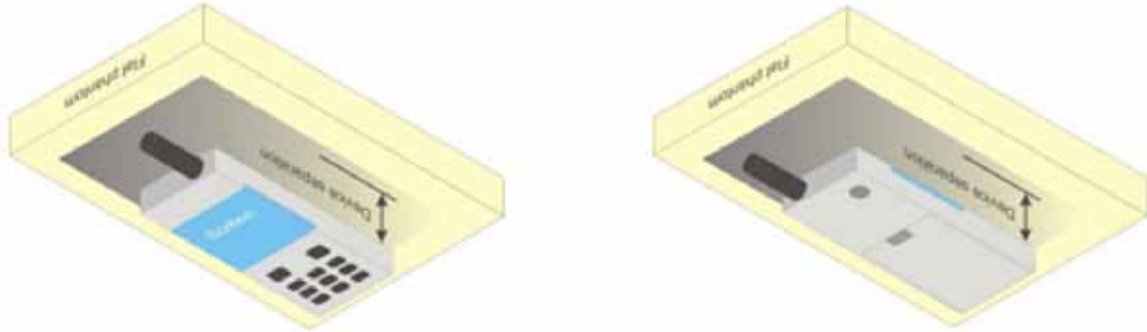

6.3 Hotspot Mode Exposure Position Conditions

For handsets that support hotspot mode operations, with wireless router capabilities and various web browsing functions, the relevant hand and body exposure conditions are tested according to the hotspot SAR procedures in KDB 941225. A test separation distance of 10 mm is required between the phantom and all surfaces and edges with a transmitting antenna located within 25 mm from that surface or edge. When the form factor of a handset is smaller than 9 cm x 5 cm, a test separation distance of 5 mm (instead of 10 mm) is required for testing hotspot mode. When the separation distance required for body-worn accessory testing is larger than or equal to that tested for hotspot mode, in the same wireless mode and for the same surface of the phone, the hotspot mode SAR data may be used to support body-worn accessory SAR compliance for that particular configuration (surface).

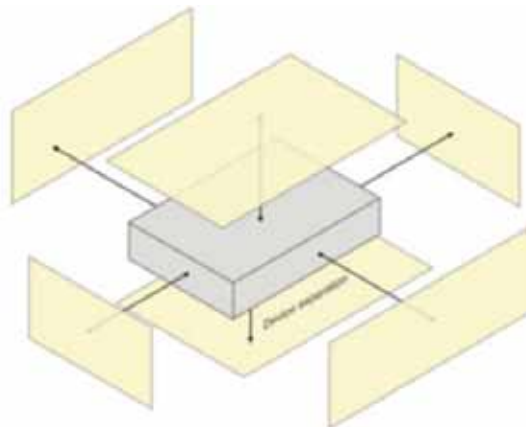

7 SAR MEASUREMENT PROCEDURES

7.1 SAR Measurement Process Diagram

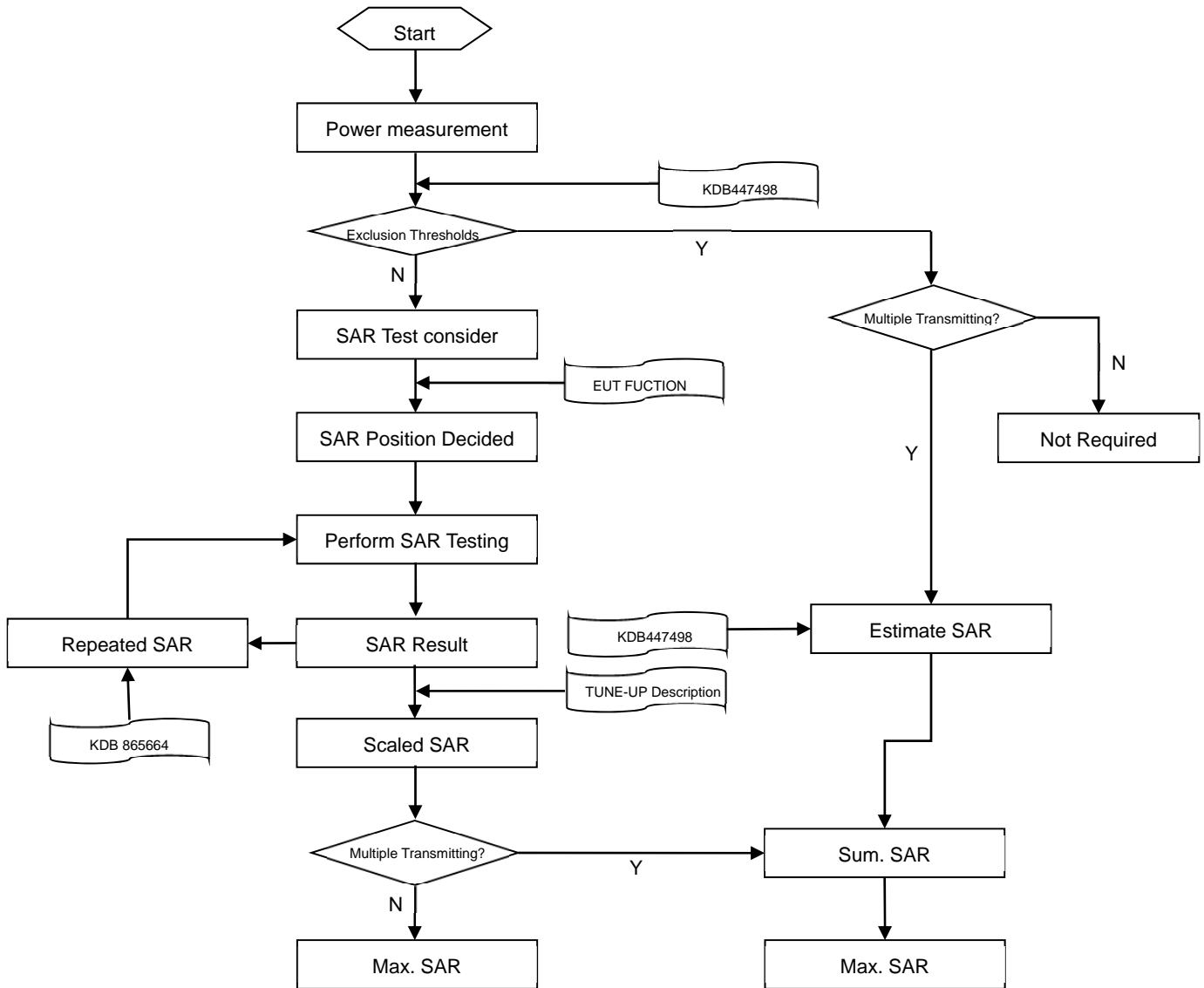

7.2 SAR Scan General Requirements

Probe boundary effect error compensation is required for measurements with the probe tip closer than half a probe tip diameter to the phantom surface. Both the probe tip diameter and sensor offset distance must satisfy measurement protocols; to ensure probe boundary effect errors are minimized and the higher fields closest to the phantom surface can be correctly measured and extrapolated to the phantom surface for computing 1-g SAR. Tolerances of the post-processing algorithms must be verified by the test laboratory for the scan resolutions used in the SAR measurements, according to the reference distribution functions specified in IEEE Std 1528-2003.

			≤3GHz	>3GHz
Maximum distance from closest measurement point (geometric center of probe sensors) to phantom surface			5±1 mm	$\frac{1}{2} \cdot \delta \cdot \ln(2) \pm 0.5$ mm
Maximum probe angle from probe axis to phantom surface normal at the measurement location			30°±1°	20°±1°
Maximum area scan spatial resolution: Δx Area , Δy Area			≤ 2 GHz: ≤ 15 mm 2 – 3 GHz: ≤ 12 mm	3–4 GHz: ≤ 12 mm 4 – 6 GHz: ≤ 10 mm
			When the x or y dimension of the test device, in the measurement plane orientation, is smaller than the above, the measurement resolution must be the corresponding x or y dimension of the test device with at least one measurement point on the test device.	
Maximum zoom scan spatial resolution: Δx Zoom , Δy Zoom			≤ 2 GHz: ≤ 8 mm 2–3 GHz: ≤ 5 mm*	3–4 GHz: ≤ 5 mm* 4 – 6 GHz: ≤ 4 mm*
Maximum zoom scan spatial resolution, normal to phantom surface	uniform grid: Δz Zoom (n)		≤ 5 mm	3–4 GHz: ≤ 4 mm
				4–5 GHz: ≤ 3 mm
				5–6 GHz: ≤ 2 mm
	graded grid	z Zoom (1): between 1st two points closest to phantom surface	≤ 4 mm	3–4 GHz: ≤ 3 mm
		4–5 GHz: ≤ 2.5 mm		
	z Zoom (n>1): between subsequent points	≤ 1.5·Δz Zoom (n-1)		
Minimum zoom scan volume	x, y, z		≥30 mm	3–4 GHz: ≥ 28 mm
				4–5 GHz: ≥ 25 mm
				5–6 GHz: ≥ 22 mm
Note: <ol style="list-style-type: none"> is the penetration depth of a plane-wave at normal incidence to the tissue medium; see draft standard IEEE P1528-2011 for details. * When zoom scan is required and the reported SAR from the area scan based 1-g SAR estimation procedures of KDB 447498 is 1.4 W/kg, 8 mm, 7 mm and 5 mm zoom scan resolution may be applied, respectively, for 2 GHz to 3GHz, 3 GHz to 4 GHz and 4 GHz to 6 GHz. 				

7.3 SAR Measurement Procedure

The following steps are used for each test position

- Establish a call with the maximum output power with a base station simulator. The connection between the mobile and the base station simulator is established via air interface
- Measurement of the local E-field value at a fixed location. This value serves as a reference value for calculating a possible power drift.
- Measurement of the SAR distribution with a grid of 8 to 16mm * 8 to 16 mm and a constant distance to the inner surface of the phantom. Since the sensors cannot directly measure at the inner phantom surface, the values between the sensors and the inner phantom surface are extrapolated. With these values the area of the maximum SAR is calculated by an interpolation scheme.
- Around this point, a cube of 30 * 30 * 30 mm or 32 * 32 * 32 mm is assessed by measuring 5 or 8 * 5 or 8*4 or 5 mm. With these data, the peak spatial-average SAR value can be calculated.
-

7.4 Area & Zoom Scan Procedures

First Area Scan is used to locate the approximate location(s) of the local peak SAR value(s). The measurement grid within an Area Scan is defined by the grid extent, grid step size and grid offset. Next, in order to determine the EM field distribution in a three-dimensional spatial extension, Zoom Scan is required. The Zoom Scan is performed around the highest E-field value to determine the averaged SAR-distribution over 10 g. Area scan and zoom scan resolution setting follows KDB 865664 D01v01r03 quoted below.

When the 1-g SAR of the highest peak is within 2 dB of the SAR limit, additional zoom scans are required for other peaks within 2 dB of the highest peak that have not been included in any zoom scan to ensure there is no increase in SAR.

8 CONDUCTED RF OUPUT POWER

The GSM mode measurement conducted power as following:

GSM850 Band	Burst Average Power (dBm)			Fram- Average Power (dBm)		
Channel	128	190	251	128	190	251
Frequency (MHz)	824.2	836.6	848.8	824.2	836.6	848.8
GSM (GMSK, 1-Slot)	33.45	33.47	33.42	24.45	24.47	24.42
GPRS (GSMK, 1-Slot)	33.49	33.49	33.42	24.49	24.49	24.42
GPRS (GSMK, 2-Slot)	32.79	32.74	32.71	26.79	26.74	26.71
GPRS (GSMK, 3-Slot)	30.99	30.98	30.95	26.73	26.72	26.69
GPRS (GSMK, 4-Slot)	29.95	29.91	29.88	26.95	26.91	26.88
EGPRS (GMSK, 1-Slot)	30.49	30.16	29.98	21.49	21.16	20.98
EGPRS (GMSK, 2-Slot)	29.41	29.11	28.64	23.41	23.11	22.64
EGPRS (GMSK, 3-Slot)	27.58	26.50	26.76	23.32	22.24	22.50
EGPRS (GMSK, 4-Slot)	25.51	25.59	25.30	22.51	22.59	22.30
GSM1900 Band	Burst Average Power (dBm)			Fram- Average Power (dBm)		
Channel	512	661	810	512	661	810
Frequency (MHz)	1850.2	1880.0	1909.8	1850.2	1880.0	1909.8
GSM (GMSK, 1-Slot)	29.67	29.67	29.64	20.67	20.67	20.64
GPRS (GSMK, 1-Slot)	29.52	29.54	29.51	20.52	20.54	20.51
GPRS (GSMK, 2-Slot)	28.86	28.88	28.74	22.86	22.88	22.74
GPRS (GSMK, 3-Slot)	27.66	27.41	27.01	23.40	23.15	22.75
GPRS (GSMK, 4-Slot)	26.69	26.33	25.86	23.69	23.33	22.86
EGPRS (GMSK, 1-Slot)	27.58	27.41	27.14	18.58	18.41	18.14
EGPRS (GMSK, 2-Slot)	25.45	25.36	25.93	19.45	19.36	19.93
EGPRS (GMSK, 3-Slot)	23.18	23.06	22.02	18.92	18.80	17.76
EGPRS (GMSK, 4-Slot)	20.95	20.58	20.31	17.95	17.58	17.31

Note:

- SAR testing was performed on the maximum frame-averaged power mode.
- The frame-averaged power is linearly proportion to the slot number configured and it is linearly scaled the maximum burst-averaged power based on time slots. The calculated method is shown as below:

Frame-averaged power = Burst averaged power (1 Tx Slot) - 9 dB

Frame-averaged power = Burst averaged power (2 Tx Slots) - 6 dB

Frame-averaged power = Burst averaged power (3 Tx Slots) - 4.26 dB

Frame-averaged power = Burst averaged power (4 Tx Slots) - 3 dB

The WCDMA mode measurement conducted power as:

Band	WCDMA 850			WCDMA 1700		
Channel	4132	4182	4233	1312	1413	1513
Frequency (MHz)	826.4	836.6	846.6	1712.4	1732.6	1752.6
RMC 12.2Kbps	23.35	23.41	23.03	24.42	24.46	24.23
HSDPA Subtest-1	22.41	22.44	22.07	23.38	23.41	23.14
HSDPA Subtest-2	21.91	21.93	21.59	22.84	22.96	22.61
HSDPA Subtest-3	21.92	21.96	21.65	22.89	22.98	22.63
HSDPA Subtest-4	21.92	21.94	21.61	22.82	22.94	21.55
HSUPA Subtest-1	20.15	20.19	19.84	21.15	21.21	21.21
HSUPA Subtest-2	20.62	20.65	20.25	21.62	21.67	21.74
HSUPA Subtest-3	21.17	21.10	20.79	21.20	22.13	22.15
HSUPA Subtest-4	20.19	20.16	19.82	21.22	21.21	21.23
HSUPA Subtest-5	18.22	17.70	17.40	15.41	18.37	17.36

WLAN 2.4G mode:

Mode	802.11b			802.11g		
Channel	1	6	11	1	6	11
Frequency (MHz)	2412	2437	2462	2412	2437	2462
Average Power (dBm)	14.97	14.99	15.01	11.13	11.88	11.12
Mode	802.11n(HT-20)			802.11n(HT-40)		
Channel	1	6	11	3	6	9
Frequency (MHz)	2412	2437	2462	2422	2437	2452
Average Power (dBm)	11.08	11.87	11.16	9.04	12.06	9.12

Bluetooth mode:

Mode	GFSK			$\pi/4$ -DQPSK		
Channel	1	39	79	1	39	79
Frequency (MHz)	2402	2441	2480	2402	2441	2480
Peak Power (dBm)	3.99	4.16	4.07	3.45	3.62	3.49
Mode	8-DPSK			BLE		
Channel	1	39	79	1	19	40
Frequency (MHz)	2402	2441	2480	2402	2441	2480
Peak Power (dBm)	3.46	3.59	3.37	-3.53	-3.78	-4.24

9 EUT ANTENNA LOCATION SKETCH

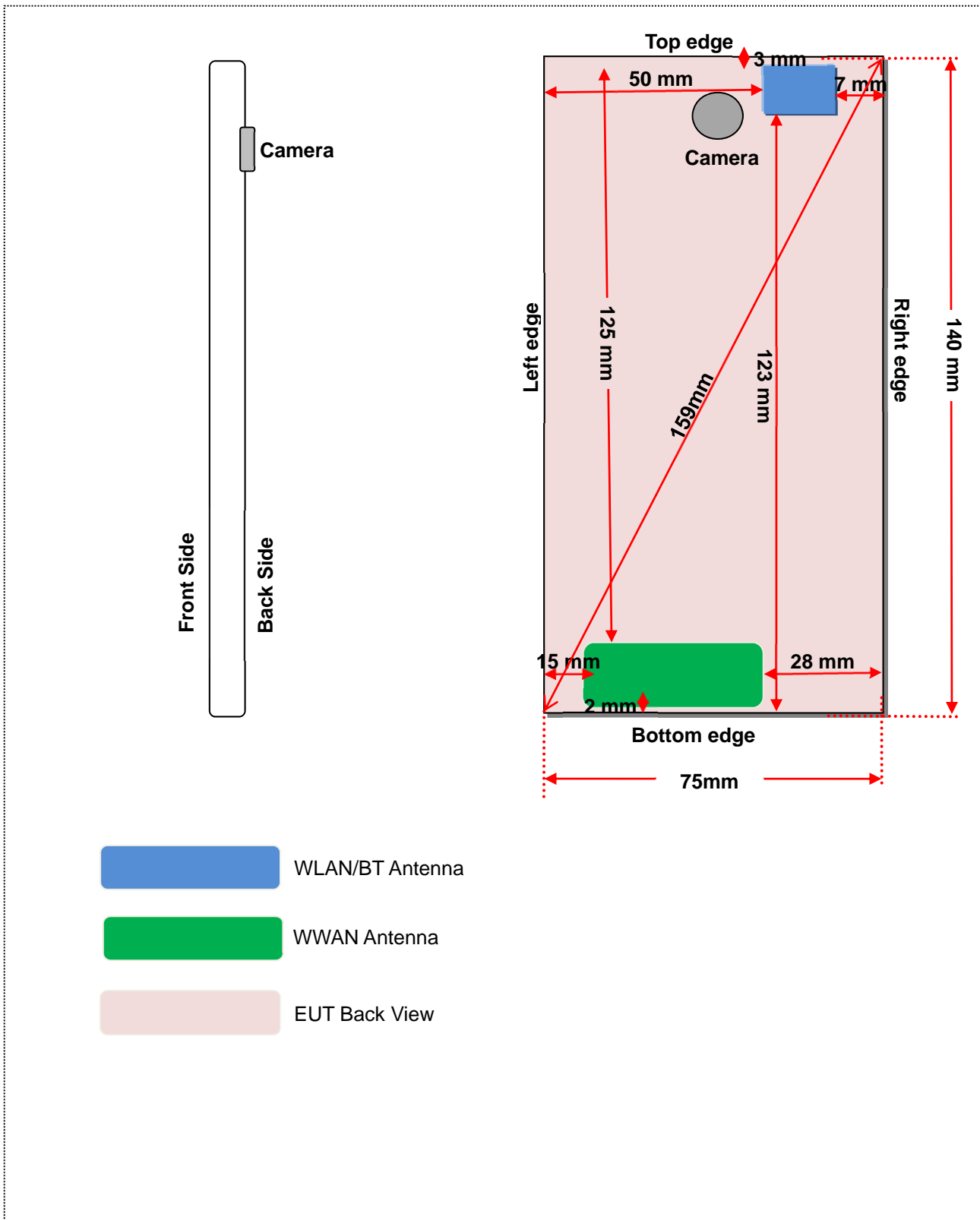

9.1 SAR Test Exclusion Consider Table

According with FCC KDB 447498 D01v05r02, Appendix A, <SAR Test Exclusion Thresholds for 100 MHz – 6 GHz and 50 mm> Table, this Device SAR test configurations consider as following :

Band	Mode	Max. Peak Power		Test Position Configurations					
				Head	Front/Back	Left Edge	Right Edge	Top Edge	Bottom Edge
		dBm	mW						
GSM 850	Distance to User			<5mm	<5mm	15mm	28mm	125mm	<5mm
	Voice	33.47	2223.31	Yes	Yes	Yes	No	No	Yes
	Data			Yes	Yes	Yes	No	No	Yes
GSM 1900	Distance to User			<5mm	<5mm	15mm	28mm	125mm	<5mm
	Voice	29.67	926.83	Yes	Yes	Yes	No	No	Yes
	Data			Yes	Yes	Yes	No	No	Yes
WCDMA Band 5	Distance to User			<5mm	<5mm	15mm	28mm	125mm	<5mm
	RMC	23.41	219.28	Yes	Yes	Yes	No	No	Yes
WCDMA Band 4	Distance to User			<5mm	<5mm	15mm	28mm	125mm	<5mm
	RMC	24.46	279.25	Yes	Yes	Yes	No	No	Yes
WLAN 2.4 G	Distance to User			<5mm	<5mm	50mm	7mm	<5mm	123mm
	802.11b	15.01	31.70	Yes	Yes	No	Yes	Yes	No
	802.11g	11.88	15.42	No	No	No	No	No	No
	802.11n(HT20)	11.87	15.38	No	No	No	No	No	No
	802.11n(HT40)	12.06	16.07	No	No	No	No	No	No
Bluetooth	Distance to User			<5mm	<5mm	50mm	7mm	<5mm	123mm
	BT	4.16	2.61	No	No	No	No	No	No

Note:

- Maximum power is the source-based time-average power and represents the maximum RF output power among production units
- Per KDB 447498 D01v05r02, for larger devices, the test separation distance of adjacent edge configuration is determined by the closest separation between the antenna and the user.
- Per KDB 447498 D01v05r02, standalone SAR test exclusion threshold is applied; If the distance of the antenna to the user is < 5mm, 5mm is used to determine SAR exclusion threshold
- Per KDB 447498 D01v05r02, the 1-g and 10-g SAR test exclusion thresholds for 100 MHz to 6 GHz at test separation distances 50 mm are determined by:

$$\left[\frac{\text{max. power of channel, including tune-up tolerance, mW}}{\text{(min. test separation distance, mm)}} \cdot [f(\text{GHz})] \right] \cdot 3.0 \text{ for 1-g SAR and } 7.5 \text{ for 10-g extremity SAR}$$

f(GHz) is the RF channel transmit frequency in GHz
 Power and distance are rounded to the nearest mW and mm before calculation
 The result is rounded to one decimal place for comparison
 For < 50 mm distance, we just calculate mW of the exclusion threshold value (3.0) to do compare.
 This formula is $3.0 / [f(\text{GHz})] \cdot [(\text{min. test separation distance, mm})] = \text{exclusion threshold of mW}$.
- Per KDB 447498 D01v05r02, at 100 MHz to 6 GHz and for test separation distances > 50 mm, the SAR test exclusion threshold is determined according to the following
 - [Threshold at 50 mm in step 1) + (test separation distance - 50 mm) · (f(MHz)/150)] mW, at 100 MHz to 1500 MHz
 - [Threshold at 50 mm in step 1) + (test separation distance - 50 mm) · 10] mW at > 1500 MHz and 6 GHz
- Per KDB 941225 D01v03, RMC 12.2kbps setting is used to evaluate SAR. If HSDPA /HSUPA /DC-HSDPA output power is

< 0.25dB higher than RMC12.2Kbps, or reported SAR with RMC 12.2kbps setting is 1.2W/kg,
HSDPA/HSUPA/DC-HSDPA SAR evaluation can be excluded.

7. Per KDB 248227 D01 v01r02, choose the highest output power channel to test SAR and determine further SAR exclusion.
8. For each frequency band, testing at higher data rates and higher order modulations is not required when the maximum average output power for each of these configurations is less than 1/4dB higher than those measured at the lowest data rate
9. Apply the test exclusion rule in KDB 248227 D01 v01r02 11g, 11n-HT20 and HT40 output power is less than 1/4dB higher than 11b mode, thus the SAR can be excluded.

9.2 10-g Extremity Exposure Consider

According with FCC KDB 648474 D04 v01r02, for smart phones with a display diagonal dimension > 15.0 cm or an overall diagonal dimension > 16.0 cm that provide similar mobile web access and multimedia support found in mini-tablets or UMPC mini-tablets that support voice calls next to the ear, unless it is confirmed otherwise through KDB inquiries, the following phablet procedures should be applied to evaluate SAR compliance for each applicable wireless modes and frequency band. Devices marketed as phablets, regardless of form factors and operating characteristics must be tested as a phablet to determine SAR compliance;

The UMPC mini-tablet procedures must also be applied to test the SAR of all surfaces and edges with an antenna located at 25 mm from that surface or edge, in direct contact with a flat phantom, for 10-g extremity SAR according to the body-equivalent tissue dielectric parameters in KDB 865664 to address interactive hand use exposure conditions. The UMPC mini-tablet 1-g SAR at 5 mm is not required. When hotspot mode applies, 10-g extremity SAR is required only for the surfaces and edges with hotspot mode 1-g reported SAR > 1.2 W/kg.

Conclusion:

1. The diagonal dimension is 15.9 cm, which is less than 16 cm.
2. The hotspot mode Max. 1-g SAR is 1.164W/Kg, which is less than 1.2W/Kg;
10-g extremity SAR is not required.

10 SAR TEST RESULTS

10.1 Head SAR

Band	Mode	Position	Ch.	Freq. (MHz)	Power Drift	Meas. SAR(W/Kg)	Meas. Power(dBm)	Max. tune-up Power(dBm)	Scaling Factor	Scaled SAR(W/Kg)	Meas. No.
GSM 850	Voice	Left cheek	190	836.6	-0.8	0.653	33.47	33.80	1.079	0.705	1#
		Left Tilted	190	836.6	-3.96	0.339	33.47	33.80	1.079	0.366	2#
		Rightcheek	190	836.6	1.58	0.655	33.47	33.80	1.079	0.707	3#
		Right Tilted	190	836.6	1.85	0.416	33.47	33.80	1.079	0.449	4#
GSM 1900	Voice	Left Cheek	661	1880.0	2.97	0.186	29.67	29.90	1.054	0.196	19#
		Left Tilted	661	1880.0	-1.6	0.125	29.67	29.90	1.054	0.132	20#
		Rightcheek	661	1880.0	0.43	0.185	29.67	29.90	1.054	0.195	21#
		Right Tilted	661	1880.0	0.18	0.091	29.67	29.90	1.054	0.096	22#
WCDM A850	RMC	Left Cheek	4182	836.6	-0.33	0.506	23.41	23.80	1.094	0.554	31#
		Left Tilted	4182	836.6	-0.53	0.251	23.41	23.80	1.094	0.275	32#
		Rightcheek	4182	836.6	-1.85	0.530	23.41	23.80	1.094	0.580	33#
		Right Tilted	4182	836.6	-0.72	0.259	23.41	23.80	1.094	0.283	34#
WCDM A1700	RMC	Left Cheek	1413	1732.6	-1.21	0.037	24.46	24.70	1.057	0.039	39#
		Left Tilted	1413	1732.6	-1.27	0.023	24.46	24.70	1.057	0.024	40#
		Rightcheek	1413	1732.6	-1.63	0.067	24.46	24.70	1.057	0.071	41#
		Right Tilted	1413	1732.6	-0.91	0.020	24.46	24.70	1.057	0.021	42#
802.11b	DATA	Left cheek	11	2462.0	-2.29	0.030	15.01	15.20	1.045	0.031	47#
		Left Tilted	11	2462.0	-1.61	0.028	15.01	15.20	1.045	0.029	48#
		Rightcheek	11	2462.0	-1.41	0.061	15.01	15.20	1.045	0.064	49#
		Right Tilted	11	2462.0	0.39	0.052	15.01	15.20	1.045	0.054	50#

10.2 Body SAR (10mm separation)

Band	Mode	Position	Ch.	Freq. (MHz)	Power Drift	Meas. SAR(W/Kg)	Meas. Power(dBm)	Max. tune-up Power(dBm)	Scaling Factor	Scaled SAR(W/Kg)	Meas. No.
GSM 850	Voice	Back Side	251	848.8	0.39	0.908	33.42	33.80	1.091	0.991	5#
		Back Side	128	824.2	1.75	0.870	33.45	33.80	1.084	0.943	6#
		BottomEdge	190	836.6	-2.11	0.071	33.47	33.80	1.079	0.077	7#
		Left Edge	190	836.6	-1.06	0.272	33.47	33.80	1.079	0.293	8#
		Back Side	190	836.6	-0.61	0.971	33.47	33.80	1.079	1.048	9#
		Front side	190	836.6	1.2	0.701	33.47	33.80	1.079	0.756	10#
	GPRS Data (Hotspot)	Front side	128	824.2	0.35	0.892	29.95	30.20	1.059	0.945	11#
		Front side	190	836.6	-2.35	0.903	29.91	30.20	1.069	0.965	12#
		Front side	251	848.8	0.54	0.845	29.88	30.20	1.076	0.910	13#
		Back Side	128	824.2	-0.83	1.023	29.95	30.20	1.059	1.084	14#
		Back Side	190	836.6	-1.87	1.089	29.91	30.20	1.069	1.164	15#
		Back Side	251	848.8	-0.09	1.066	29.88	30.20	1.076	1.148	16#
		Left Edge	190	836.6	-2.95	0.464	29.95	30.20	1.059	0.491	17#
		BottomEdge	190	836.6	-1.2	0.082	29.95	30.20	1.059	0.087	18#
GSM 1900	Voice	Front side	661	1880.0	3.57	0.187	29.67	29.90	1.054	0.197	23#
		Back Side	661	1880.0	1.52	0.367	29.67	29.90	1.054	0.387	24#
		Left Edge	661	1880.0	0.60	0.100	29.67	29.90	1.054	0.105	25#
		BottomEdge	661	1880.0	1.35	0.341	29.67	29.90	1.054	0.360	26#
	GPRS Data (Hotspot)	Front side	512	1850.2	-0.35	0.209	26.69	27.00	1.074	0.224	27#
		Back Side	512	1850.2	0.31	0.388	26.69	27.00	1.074	0.417	28#
		Left Edge	512	1850.2	-1.23	0.126	26.69	27.00	1.074	0.135	29#
		BottomEdge	512	1850.2	0.71	0.337	26.69	27.00	1.074	0.362	30#
WCDM A850	RMC (Body -Worn and hotspot)	Front side	4182	836.6	-0.40	0.362	23.41	23.80	1.094	0.396	35#
		Back Side	4182	836.6	-2.00	0.519	23.41	23.80	1.094	0.568	36#
		Left Edge	4182	836.6	-0.53	0.136	23.41	23.80	1.094	0.149	37#
		BottomEdge	4182	836.6	-0.81	0.027	23.41	23.80	1.094	0.030	38#
WCDM A1700	RMC (Body -Worn and hotspot)	Front side	1413	1732.6	0.14	0.062	24.46	24.70	1.057	0.066	43#
		Back Side	1413	1732.6	0.89	0.074	24.46	24.70	1.057	0.078	44#
		Left Edge	1413	1732.6	4.87	0.013	24.46	24.70	1.057	0.014	45#
		BottomEdge	1413	1732.6	0.17	0.079	24.46	24.70	1.057	0.083	46#
802.11b	DATA (Hotspot)	Front side	11	2462.0	-1.85	0.030	15.01	15.20	1.045	0.031	51#
		Back Side	11	2462.0	-0.66	0.051	15.01	15.20	1.045	0.053	52#
		Right Edge	11	2462.0	0.47	0.012	15.01	15.20	1.045	0.013	53#
		Top Edge	11	2462.0	-2.57	0.026	15.01	15.20	1.045	0.027	54#

10.3 SAR Measurement Variability

According to KDB 865664 D01 v01r03, SAR measurement variability was assessed for each frequency band, which is determined by the SAR probe calibration point and tissue-equivalent medium used for the device measurements. When both head and body tissue-equivalent media are required for SAR measurements in a frequency band, the variability measurement procedures should be applied to the tissue medium with the highest measured SAR, using the highest measured SAR configuration for that tissue-equivalent medium. Alternatively, if the highest measured SAR for both head and body tissue-equivalent media are ≤ 1.45 W/kg and the ratio of these highest SAR values, i.e., largest divided by smallest value, is ≤ 1.10 , the highest SAR configuration for either head or body tissue-equivalent medium may be used to perform the repeated measurement. These additional measurements are repeated after the completion of all measurements requiring the same head or body tissue-equivalent medium in a frequency band. The test device should be returned to ambient conditions (normal room temperature) with the battery fully charged before it is re-mounted on the device holder for the repeated measurement(s) to minimize any unexpected variations in the repeated results.

SAR repeated measurement procedure:

1. When the highest measured SAR is < 0.80 W/kg, repeated measurement is not required.
2. When the highest measured SAR is ≥ 0.80 W/kg, repeat that measurement once.
3. If the ratio of largest to smallest SAR for the original and first repeated measurements is > 1.20 , or when the original or repeated measurement is ≥ 1.45 W/kg, perform a second repeated measurement.
4. If the ratio of largest to smallest SAR for the original, first and second repeated measurements is > 1.20 , and the original, first or second repeated measurement is ≥ 1.5 W/kg, perform a third repeated measurement.

SAR Repeated Measurement

Band	Mode	Position	Ch.	Freq.	Original	first repeated	ratio	second repeated	ratio	Third repeated	ratio
GSM850	Body-worn	Back Side	128	824.2	0.870	0.869	1.001	-	-	-	-
			190	836.6	0.971	0.975	1.004	-	-	-	-
			251	848.8	0.908	0.902	1.007	-	-	-	-
	GPRS	Front Side	128	824.2	0.892	0.894	1.002	-	-	-	-
			190	836.6	0.903	0.899	1.004	-	-	-	-
			251	848.8	0.845	0.842	1.004	-	-	-	-
		Back Side	128	824.2	1.023	1.130	1.105	-	-	-	-
			190	836.6	1.089	1.095	1.006	-	-	-	-
			251	848.8	1.066	1.045	1.020	-	-	-	-

Note:

1. The ratio of largest to smallest SAR for the original and first repeated measurements is < 1.20 , the second repeated measurement is not necessary.

11 SIMULTANEOUS TRANSMISSION

11.1 Simultaneous Transmission Mode Consider

Simultaneous Transmitting (Yes/NO)	BT	WLAN	WCDMA RMC	GSM Data	GSM Voice
GSM Voice	Yes	Yes	NO	NO	-
GSM Data	Yes	Yes	NO	-	-
WCDMA RMC	Yes	Yes	-	-	-
WLAN	NO	-	-	-	-
BT	-	-	-	-	-

Note: The BT and WLAN share the same PIFA antenna, cannot transmitting together.

11.2 Estimated SAR Calculation

According to KDB 447498 D01v05r02, when standalone SAR test exclusion applies to an antenna that transmits simultaneously with other antennas, the standalone SAR was estimated according to following formula to result in substantially conservative SAR values of ≤ 0.4 W/kg to determine simultaneous transmission SAR test exclusion.

$$\text{Estimated SAR} = \frac{\text{Max. Tune Up Power}_{(mW)}}{\text{Min. Test Separation Distance}_{(mm)}} * \frac{\sqrt{f_{\text{GHz}}}}{7.5}$$

If the minimum test separation distance is < 5 mm, a distance of 5 mm is used for estimated SAR calculation. When the test separation distance is > 50 mm, the 0.4 W/kg is used for SAR-1g.

Band	Mode	Position	Antenna To user (mm)	SAR Testing	Max. Tune-up Power (dBm)	Max. Tune-up Power (mW)	Frequency (GHz)	Calculation Distance/Gap (mm)	Estimated SAR (W/kg)
Bluetooth	GFSK	Right Cheek	5	NO	4.16	33.11	2.441	5	0.109
		Left Cheek	5	NO	4.16	33.11	2.441	5	0.109
		Front side	10	NO	4.16	33.11	2.441	10	0.054
		Back Side	10	NO	4.16	33.11	2.441	10	0.054
		Right Edge	10	NO	4.16	33.11	2.441	10	0.054
		Top Edge	10	NO	4.16	33.11	2.441	10	0.054

11.3 Sum SAR of Simultaneous Transmission

Simultaneous Mode	Position	Mode	Max. 1-g SAR (W/kg)	1-g Sum SAR (W/kg)
GSM Voice + BT	Head	GSM Voice	0.707	0.816
		BT	0.109	
	Body-worn	GSM Voice	1.048	1.102
		BT	0.054	
GSM DATA + BT	Hotspot Mode	GSM DATA	1.164	1.192
		BT	0.054	
GSM Voice + WLAN	Head	GSM Voice	0.707	0.771
		WLAN	0.064	
	Body-worn	GSM Voice	1.048	1.101
		WLAN	0.053	
GSM DATA + WLAN	Hotspot Mode	GSM DATA	1.164	1.217
		WLAN	0.053	
WCDMA RMC + BT	Head	WCDMA RMC	0.580	0.689
		BT	0.109	
	Body-worn Hotspot	WCDMA RMC	0.568	0.622
		BT	0.054	
WCDMA RMC + WLAN	Head	WCDMA RMC	0.580	0.644
		WLAN	0.064	
	Body-worn Hotspot	WCDMA RMC	0.568	0.621
		WLAN	0.053	

Simultaneous transmission SAR test exclusion is determined for each operating configuration and exposure condition according to the reported standalone SAR of each applicable simultaneous transmitting antenna. When the sum of SAR 1g of all simultaneously transmitting antennas in an operating mode and exposure condition combination is within the SAR limit (SAR 1g 1.6 W/kg), the simultaneous transmission SAR is not required. When the sum of SAR 1g is greater than the SAR limit (SAR 1g 1.6 W/kg), SAR test exclusion is determined by the SPLSR.

12 TEST EQUIPMENTS LIST

Description	Manufacturer	Model	Serial No.	Cal. Date	Cal. Due
PC	Dell	N/A	N/A	N/A	N/A
900MHz Dipole	SATIMO	SID900	S/N 25/13 DIP 0G900-247	2014/08/17	2015/08/16
1800MHz Dipole	SATIMO	SID1800	S/N 25/13 DIP 1G800-248	2014/08/17	2015/08/16
1900MHz Dipole	SATIMO	SID1800	S/N 25/13 DIP 1G900-249	2014/08/17	2015/08/16
2450MHz Dipole	SATIMO	SID2450	S/N 25/13 DIP 2G450-251	2014/08/17	2015/08/16
E-Field Probe	SATIMO	SSE2	SN 17/14 EPG 210	2014/05/16	2015/05/15
Antenna	SATIMO	ANTA3	SN 17/13 ZNTA45	N/A	N/A
Phantom1	SATIMO	SAM	SN 30/13 SAM013	N/A	N/A
Phantom2	SATIMO	SAM	SN 30/13 SAM014	N/A	N/A
Dielectric Probe Kit	SATIMO	SCLMP	SN 25/13 OCPG56	2014/08/17	2015/08/16
MultiMeter	Keithley	MultiMeter 2000	4024022	2014/02/13	2015/02/12
Signal Generator	R&S	SMF100A	1167.0000k02/104260	2014/02/17	2015/02/16
Power Meter	Agilent	5738A	11290	2013/10/22	2014/10/21
Power Sensor	R&S	NRP-Z21	103971	2013/12/12	2014/12/11
Power Amplifier	SATIMO	6552B	22374	2014/08/17	2015/08/16
Wireless Communication Test Set	Agilent	8960-E5515C	MY50260493	2014/01/22	2015/01/21
Network Analyzer	RS	5071C	EMY46103472	2013/12/12	2014/12/11
Attenuator	COM-MW	ZA-S1-31	1305003187	N/A	N/A
Directional coupler	AA-MCS	AAMCS-UDC	000272	N/A	N/A

13 REFERENCES

- 1 FCC 47 CFR Part 2 “Frequency Allocations and Radio Treaty Matters; General Rules and Regulations”
- 2 ANSI/IEEE Std. C95.1-1992, “IEEE Standard for Safety Levels with Respect to Human Exposure to Radio Frequency Electromagnetic Fields, 3 kHz to 300 GHz”, September 1992
- 3 IEEE Std. 1528-2003, “Recommended Practice for Determining the Peak Spatial-Average Specific Absorption Rate (SAR) in the Human Head from Wireless Communications Devices: Measurement Techniques”, December 2003
- 4 FCC KDB 248227 D01 v01r02, “SAR Measurement Procedures for 802.11 a/b/g Transmitters”, May 2007
- 5 FCC KDB 447498 D01 v05r02, “Mobile and Portable Device RF Exposure Procedures and Equipment Authorization Policies”, May 2013
- 6 FCC KDB 648474 D04 v01r02, “SAR Evaluation Considerations for Wireless Handsets”, May 2013
- 7 FCC KDB 941225 D01 v03, “3G SAR MEAUREMENT PROCEDURES”, October 2014
- 8 FCC KDB 616217 D04 v01r01, “SAR Evaluation Considerations for Laptop, Notebook, Netbook and Tablet Computers”, May 2013
- 9 FCC KDB 865664 D01 v01r03, "SAR Measurement Requirements for 100 MHz to 6 GHz", May 2013.
- 10 FCC KDB 865664 D02 v01r01, “RF Exposure Compliance Reporting and Documentation Considerations”, May 2013
- 11 SATIMO COMOSAR_V4
- 12 SATIMO OPENSAR_V4

ANNEX A SAR TEST RESULT OF SYSTEM VERIFICATION

System Performance Check Data(835MHz Head)

Type: Phone measurement (Complete)
 Area scan resolution: dx=8mm,dy=8mm
 Zoom scan resolution: dx=8mm, dy=8mm, dz=5mm
 Date of measurement: 2014.9.4
 Measurement duration: 14 minutes 22 seconds

Experimental conditions.

Phantom File	surf_sam_plan.txt
Phantom	Validation plane
Position	-
Band	835MHz
Channels	-
Signal	CW
Frequency (MHz)	835MHz
Relative permittivity (real part)	40.402635
Relative permittivity	18.717500
Conductivity (S/m)	0.924284
Power drift (%)	0.450000
Ambient Temperature:	22.7°C
Liquid Temperature:	22.3°C
ConvF:	23.67
Crest factor:	1:1

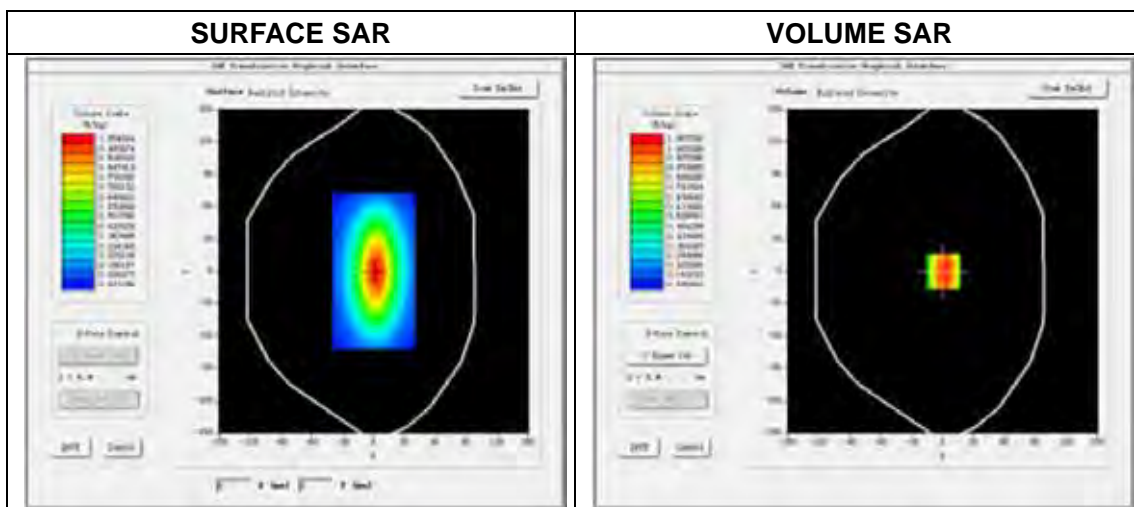

Maximum location: X=1.00, Y=0.00

SAR Peak: 1.46 W/kg

SAR 10g (W/Kg)	0.608155
SAR 1g (W/Kg)	0.937160

Z Axis Scan

Z (mm)	0.00	4.00	9.00	14.00	19.00	24.00	29.00
SAR (W/Kg)	1.34720	0.97891	0.66265	0.5042	0.3512	0.2505	0.11794

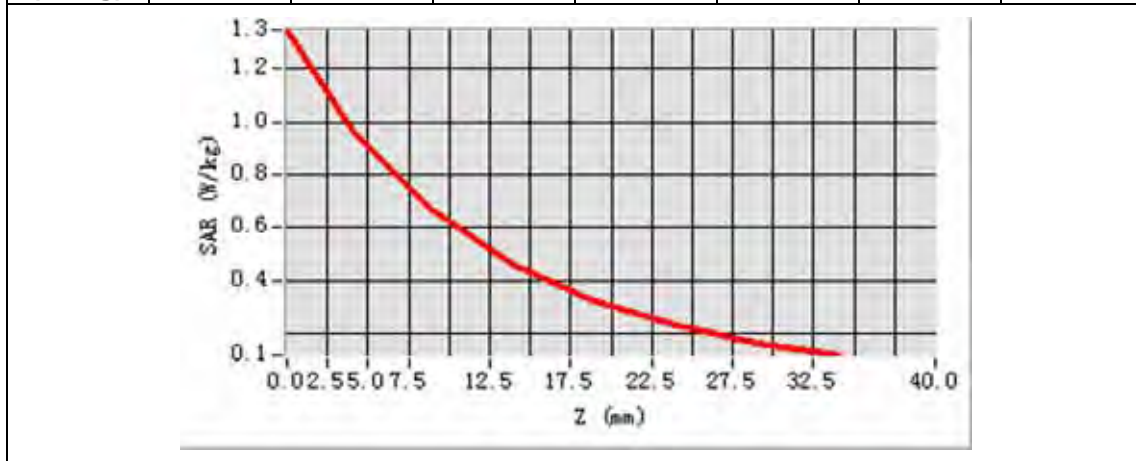

3D scen shot	Hot spot position
<p>A 3D perspective view of a grey device. A small rectangular area on the front face is highlighted with a color-coded heatmap, showing a red center (high SAR) transitioning to yellow and green towards the edges.</p>	<p>A 2D heatmap showing the spatial distribution of the SAR hot spot. The center is a bright red oval, surrounded by concentric rings of yellow, green, and cyan, indicating the decay of SAR intensity away from the center.</p>

System Performance Check Data(835MHz Body)

Type: Phone measurement (Complete)
 Area scan resolution: dx=8mm,dy=8mm
 Zoom scan resolution: dx=8mm, dy=8mm, dz=5mm
 Date of measurement: 2014.9.5
 Measurement duration: 14 minutes 13 seconds

Experimental conditions.

Phantom File	surf_sam_plan.txt
Phantom	Validation plane
Position	-
Band	835MHz
Channels	-
Signal	CW
Frequency (MHz)	835MHz
Relative permittivity (real part)	55.262077
Relative permittivity	21.408187
Conductivity (S/m)	0.9918883
Power drift (%)	0.090000
Ambient Temperature:	22.7°C
Liquid Temperature:	22.3°C
ConvF:	24.58
Crest factor:	1:1

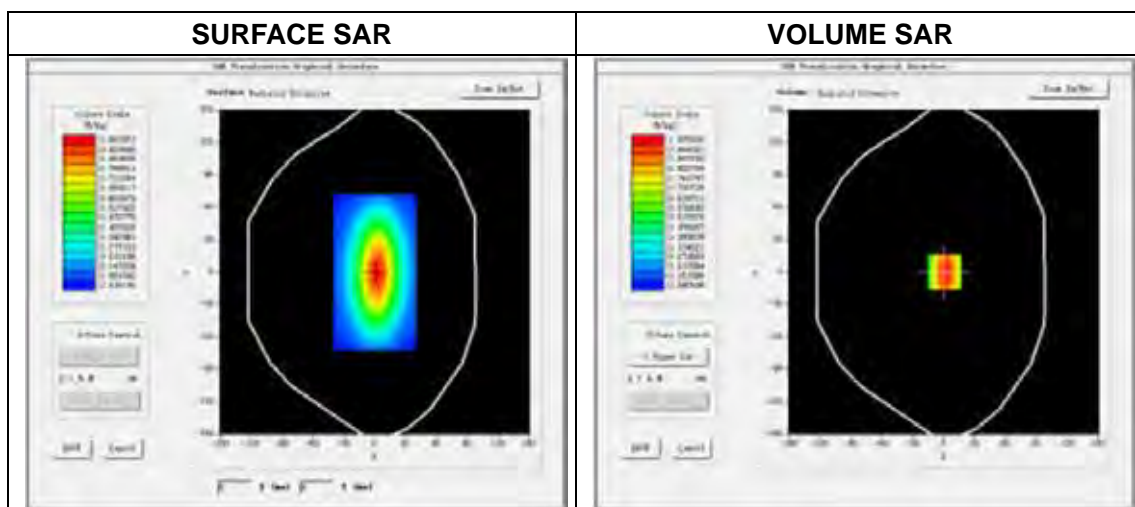

Maximum location: X=1.00, Y=0.00
 SAR Peak: 1.48 W/kg

SAR 10g (W/Kg)	0.693221
SAR 1g (W/Kg)	1.008439

Z Axis Scan

Z (mm)	0.00	4.00	9.00	14.00	19.00	24.00	29.00
SAR (W/Kg)	1.3725	1.0058	0.6838	0.4755	0.3314	0.2365	0.1688

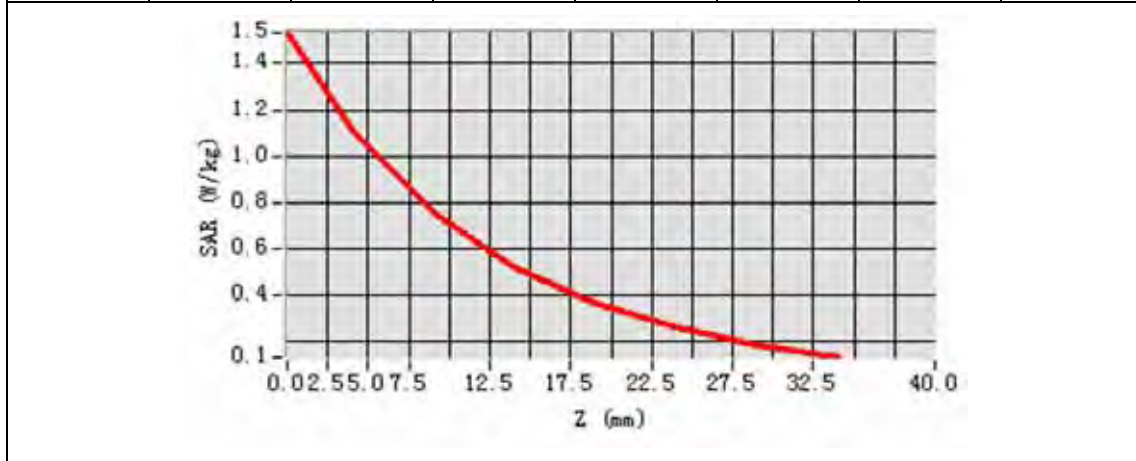

<p>3D scen shot</p>	<p>Hot spot position</p>

System Performance Check Data(1900MHz Head)

Type: Phone measurement (Complete)
 Area scan resolution: dx=8mm,dy=8mm
 Zoom scan resolution: dx=8mm, dy=8mm, dz=5mm
 Date of measurement: 2014.9.4
 Measurement duration: 14 minutes 12 seconds

Experimental conditions.

Phantom File	surf_sam_plan.txt
Phantom	Validation plane
Position	-
Band	1900MHz
Channels	-
Signal	CW
Frequency (MHz)	1900MHz
Relative permittivity (real part)	41.001245
Relative permittivity	13.260000
Conductivity (S/m)	1.423667
Power drift (%)	0.470000
Ambient Temperature:	22.7°C
Liquid Temperature:	22.3°C
ConvF:	26.70
Crest factor:	1:1

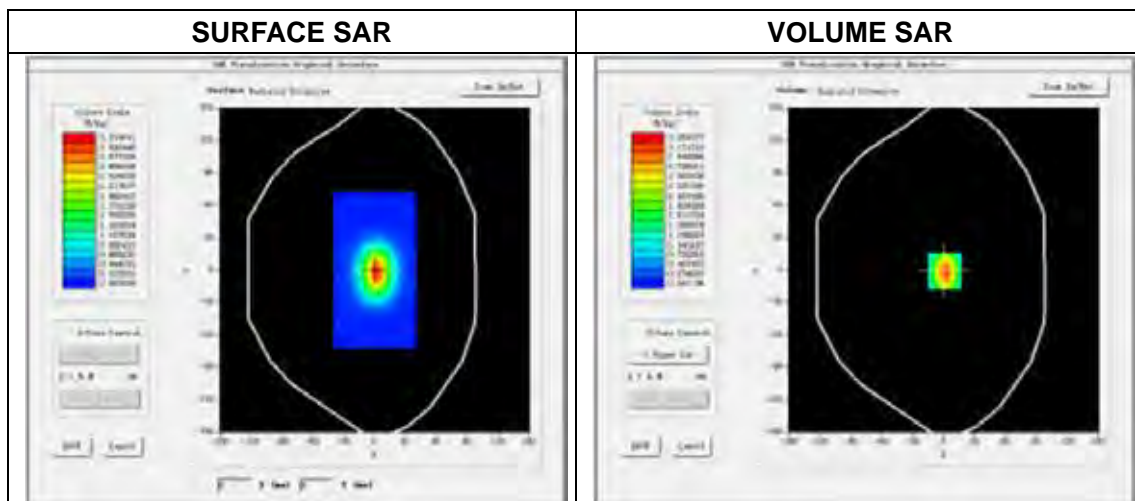

Maximum location: X=1.00, Y=-1.00
 SAR Peak: 5.39 W/kg

SAR 10g (W/Kg)	1.977525
SAR 1g (W/Kg)	3.774170

Z Axis Scan

Z (mm)	0.00	4.00	9.00	14.00	19.00	24.00	29.00
SAR (W/Kg)	6.5296	4.1946	2.3311	1.3187	0.5733	0.3288	0.1617

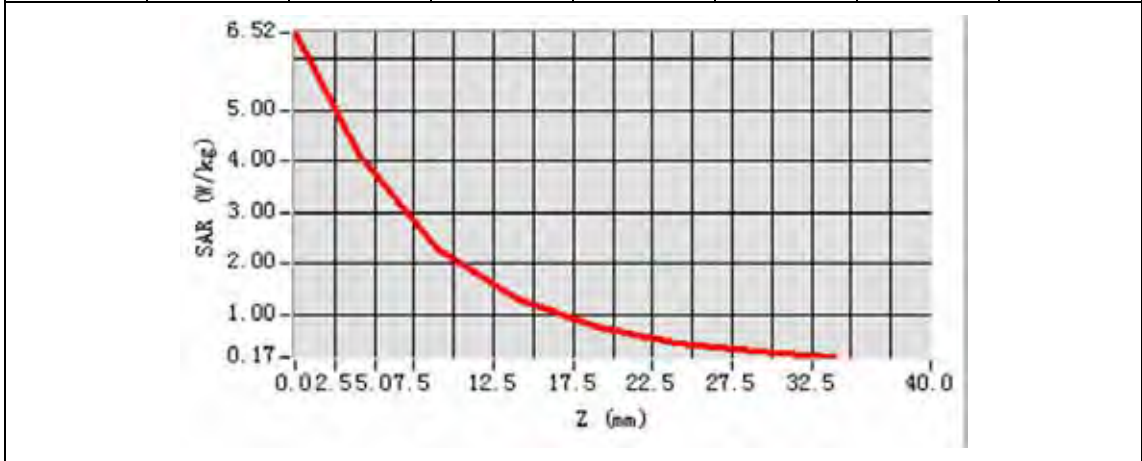

<p>3D scen shot</p>	<p>Hot spot position</p>
<p>A 3D perspective view of a grey, L-shaped device. A small rectangular area on the horizontal part of the device is highlighted with a color gradient from blue to red, indicating the location of the maximum SAR exposure.</p>	<p>A 2D heatmap showing a circular region of high intensity (red) in the center, surrounded by concentric rings of decreasing intensity (yellow, green, cyan, blue). The background is dark blue.</p>

System Performance Check Data(1900MHz Body)

Type: Phone measurement (Complete)
 Area scan resolution: dx=8mm,dy=8mm
 Zoom scan resolution: dx=8mm, dy=8mm, dz=5mm
 Date of measurement: 2014.9.5
 Measurement duration: 14 minutes 46 seconds

Experimental conditions.

Phantom File	surf_sam_plan.txt
Phantom	Validation plane
Position	-
Band	1900MHz
Channels	-
Signal	CW
Frequency (MHz)	1900.000000
Relative permittivity (real part)	54.200142
Relative permittivity	12.875310
Conductivity (S/m)	1.550123
Power drift (%)	0.370000
Ambient Temperature:	22.7°C
Liquid Temperature:	22.3°C
ConvF:	27.47
Crest factor:	1:1

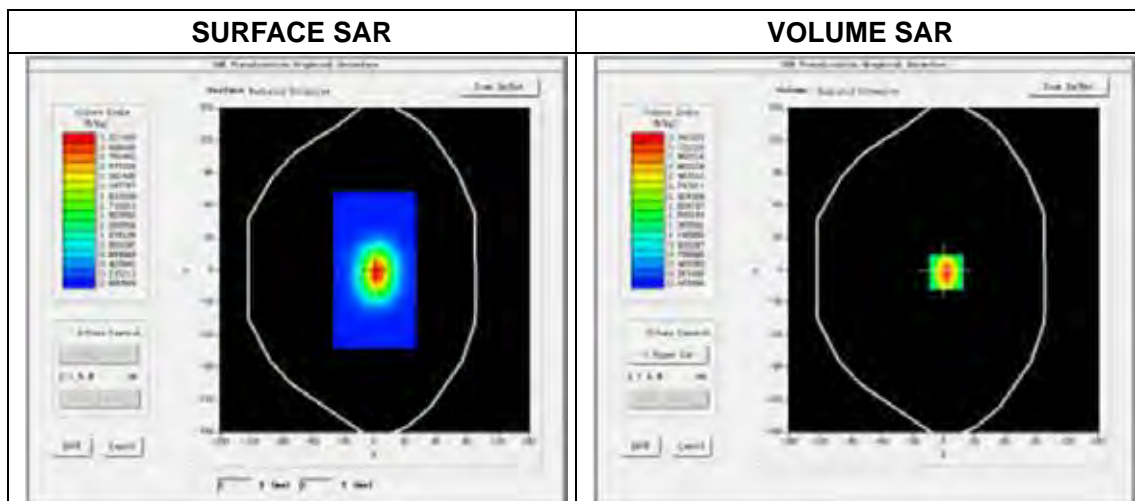

Maximum location: X=2.00, Y=-2.00
 SAR Peak: 5.27 W/kg

SAR 10g (W/Kg)	2.124122
SAR 1g (W/Kg)	4.141824

Z Axis Scan

Z (mm)	0.00	4.00	9.00	14.00	19.00	24.00	29.00
SAR (W/Kg)	5.3196	3.3419	1.8167	1.0186	0.5752	0.3285	0.1898

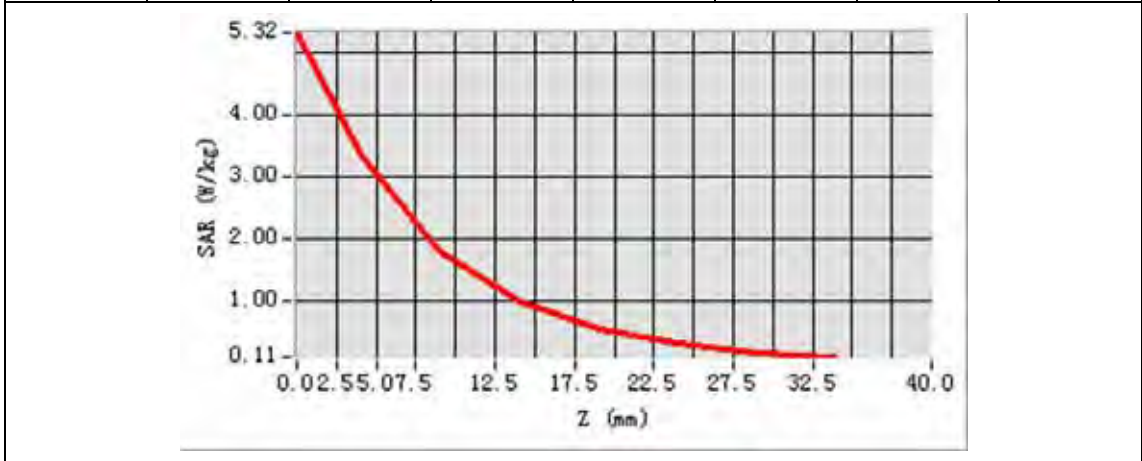

<p>3D scene shot</p>	<p>Hot spot position</p>

System Performance Check Data(2450MHz Head)

Type: Phone measurement (Complete)
 Area scan resolution: dx=8mm,dy=8mm
 Zoom scan resolution: dx=8mm, dy=8mm, dz=5mm
 Date of measurement: 2014.9.4
 Measurement duration: 12 minutes 38 seconds

Experimental conditions.

Phantom File	surf_sam_plan.txt
Phantom	Validation plane
Position	-
Band	24500MHz
Channels	-
Signal	CW
Frequency (MHz)	2450.000000
Relative permittivity (real part)	39.326002
Relative permittivity	13.207000
Conductivity (S/m)	1.788081
Power drift (%)	-1.200000
Ambient Temperature:	22.7°C
Liquid Temperature:	22.3°C
ConvF:	25.25
Crest factor:	1:1

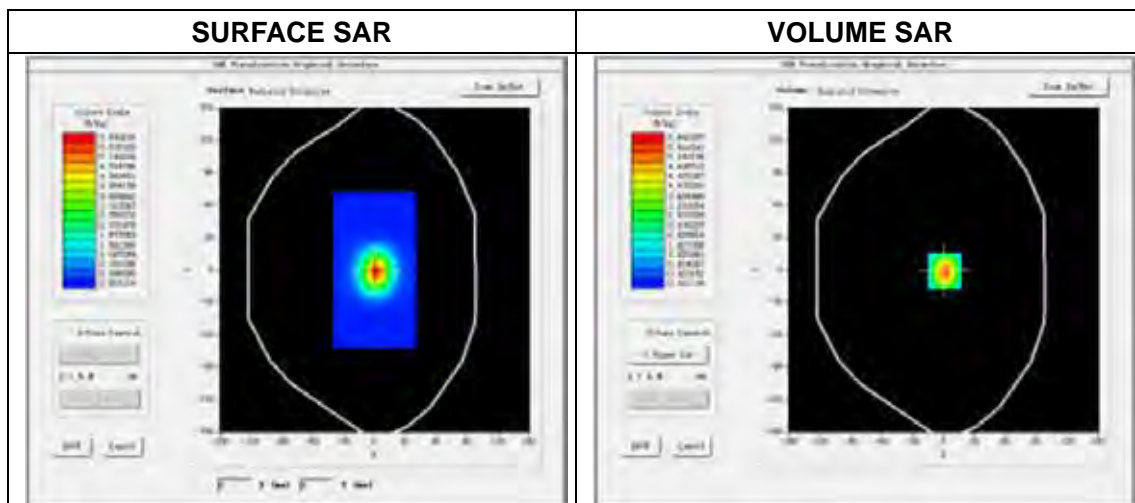

Maximum location: X=1.00, Y=-1.00

SAR Peak: 10.40 W/kg

SAR 10g (W/Kg)	2.563006
SAR 1g (W/Kg)	5.392723

Z Axis Scan

Z (mm)	0.00	4.00	9.00	14.00	19.00	24.00	29.00
SAR (W/Kg)	10.7621	7.9862	3.6672	1.9872	0.5979	0.2875	0.1721

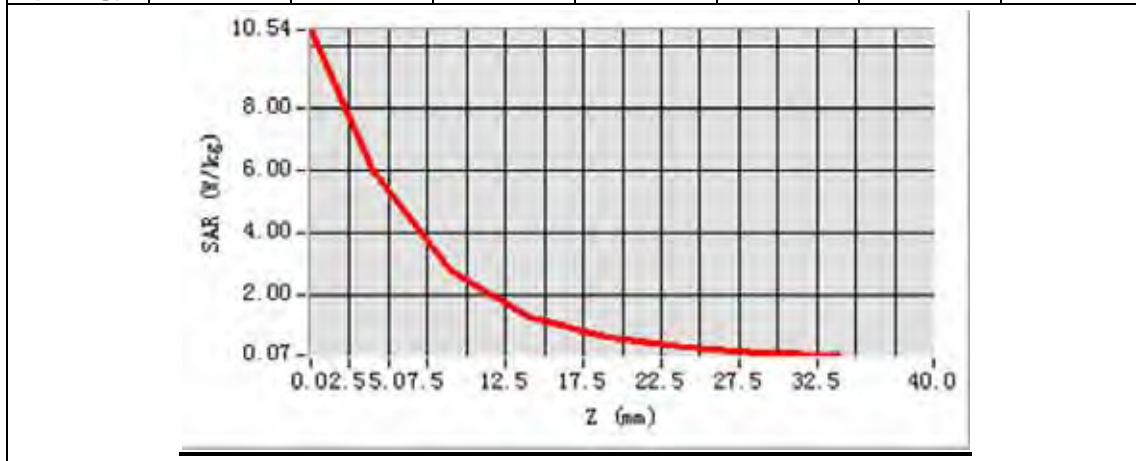

3D scen shot	Hot spot position

System Performance Check Data(2450MHz Body)

Type: Phone measurement (Complete)
 Area scan resolution: dx=8mm,dy=8mm
 Zoom scan resolution: dx=8mm, dy=8mm, dz=5mm
 Date of measurement: 2014.9.6
 Measurement duration: 14 minutes 46 seconds

Experimental conditions.

Phantom File	surf_sam_plan.txt
Phantom	Validation plane
Position	-
Band	2450MHz
Channels	-
Signal	CW
Frequency (MHz)	2450.000000
Relative permittivity (real part)	53.124014
Relative permittivity	11.9733281
Conductivity (S/m)	1.9701124
Power drift (%)	0.370000
Ambient Temperature:	22.7°C
Liquid Temperature:	22.3°C
ConvF:	26.09
Crest factor:	1:1

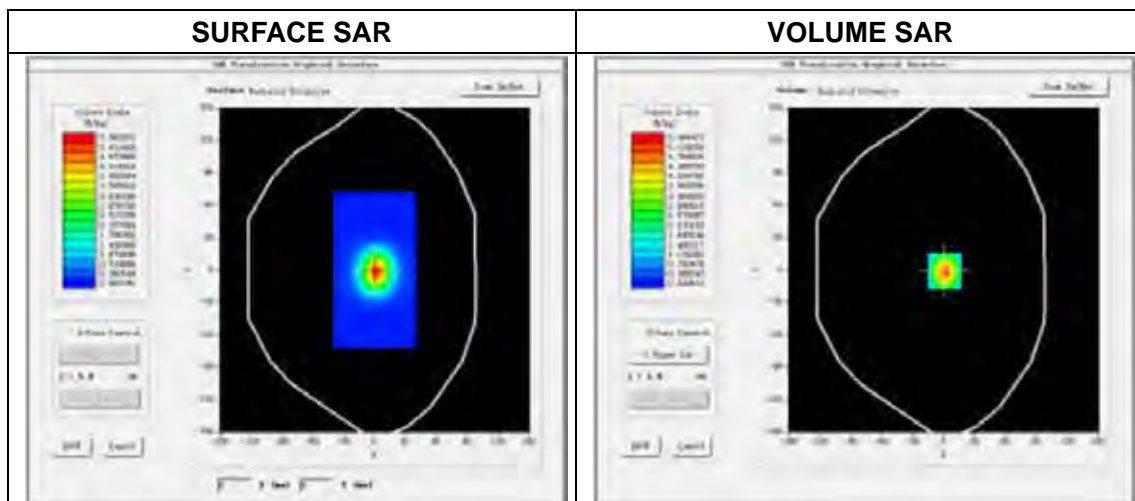

Maximum location: X=1.00, Y=-1.00

SAR Peak: 9.46 W/kg

SAR 10g (W/Kg)	2.294654
SAR 1g (W/Kg)	5.122832

Z Axis Scan

Z (mm)	0.00	4.00	9.00	14.00	19.00	24.00	29.00
SAR (W/Kg)	9.7552	7.4847	2.8567	1.7823	0.4983	0.1763	0.1091

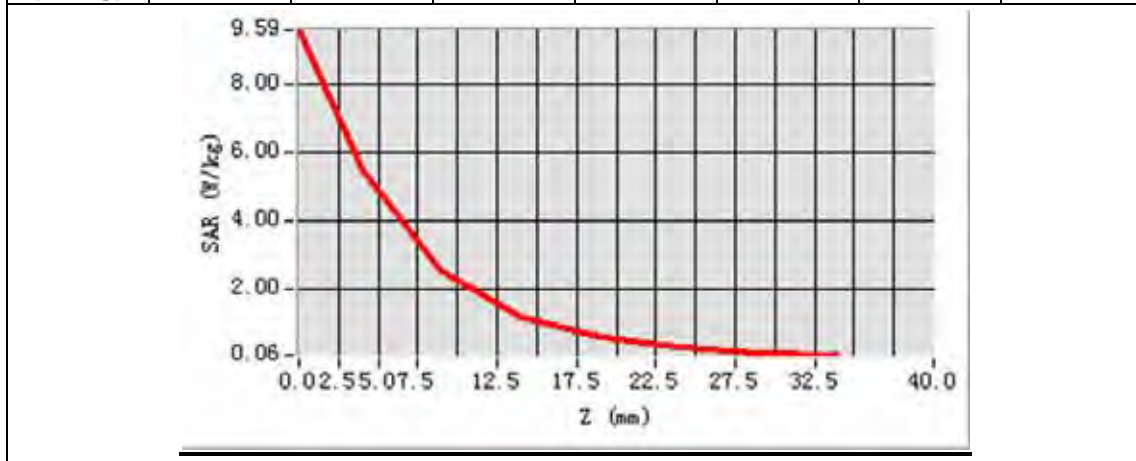

3D scen shot	Hot spot position

ANNEX B SAR TEST SETUP PHOTOS

Right Head Cheek



Right Head Title



Left Head Cheek



Left Head Tilt



Back Side (10mm separation)



Front Side (10mm separation)

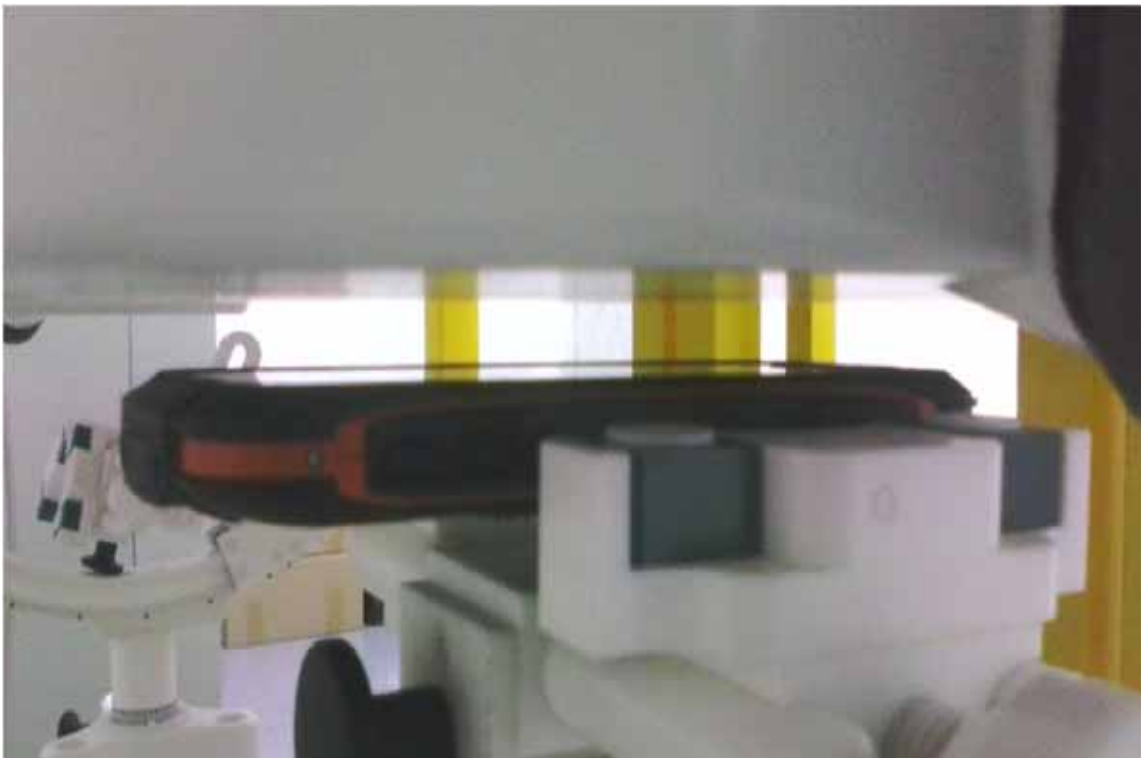

Bottom Edge (10mm separation)



Top Edge (10mm separation)



Left Edge (10mm separation)



Right Edge (10mm separation)



ANNEX C SAR MEASUREMENT RESULT

TABLE OF MEASUREMENT RESULT LIST

<u>Band</u>	<u>POSITION</u>	<u>PARAMETERS</u>
GSM850	HEAD	<u>MEAS. 1:</u> Left Head with Cheek device position on Middle Channel in GSM mode
GSM850	HEAD	<u>MEAS. 2:</u> Left Head with Tilt device position on Middle Channel in GSM mode
GSM850	HEAD	<u>MEAS. 3:</u> Right Head with Cheek device position on Middle Channel in GSM mode
GSM850	HEAD	<u>MEAS. 4:</u> Right Head with Tilt device position on Middle Channel in GSM mode
GSM850	BODY	<u>MEAS. 5:</u> Body Plane with Body device position on High Channel in GSM mode
GSM850	BODY	<u>MEAS. 6:</u> Body Plane with Body device position on Low Channel in GSM mode
GSM850	BODY	<u>MEAS. 7:</u> Body Plane with Body device position on Middle Channel in GSM mode
GSM850	BODY	<u>MEAS. 8:</u> Body Plane with Body device position on Middle Channel in GSM mode
GSM850	BODY	<u>MEAS. 9:</u> Body Plane with Body device position on Middle Channel in GSM mode
GSM850	BODY	<u>MEAS. 10:</u> Body Plane with Body device position on Middle Channel in GSM mode
GPRS850	BODY	<u>MEAS. 11:</u> Body Plane with Body device position on Low Channel in GPRS850-12 mode
GPRS850	BODY	<u>MEAS. 12:</u> Body Plane with Body device position on Middle Channel in GPRS850-12 mode
GPRS850	BODY	<u>MEAS. 13:</u> Body Plane with Body device position on High Channel in GPRS850-12 mode
GPRS850	BODY	<u>MEAS. 14:</u> Body Plane with Body device position on Low Channel in GPRS850-12 mode
GPRS850	BODY	<u>MEAS. 15:</u> Body Plane with Body device position on Middle Channel in GPRS850-12 mode
GPRS850	BODY	<u>MEAS. 16:</u> Body Plane with Body device position on High Channel in GPRS850-12 mode
GPRS850	BODY	<u>MEAS. 17:</u> Body Plane with Body device position on Middle Channel in GPRS850-12 mode
GPRS850	BODY	<u>MEAS. 18:</u> Body Plane with Body device position on Middle Channel in GPRS850-12 mode
GSM1900	HEAD	<u>MEAS. 19:</u> Left Head with Cheek device position on Middle Channel in GSM mode
GSM1900	HEAD	<u>MEAS. 20:</u> Left Head with Tilt device position on Middle Channel in GSM mode
GSM1900	HEAD	<u>MEAS. 21:</u> Right Head with Cheek device position on Middle Channel in GSM mode

<u>Band</u>	<u>POSITION</u>	<u>PARAMETERS</u>
GSM1900	HEAD	<u>MEAS. 22:</u> Right Head with Tilt device position on Middle Channel in GSM mode
GSM1900	BODY	<u>MEAS. 23:</u> Body Plane with Body device position on Middle Channel in GSM mode
GSM1900	BODY	<u>MEAS. 24:</u> Body Plane with Body device position on Middle Channel in GSM mode
GSM1900	BODY	<u>MEAS. 25:</u> Body Plane with Body device position on Middle Channel in GSM mode
GSM1900	BODY	<u>MEAS. 26:</u> Body Plane with Body device position on Middle Channel in GSM mode
GPRS1900	BODY	<u>MEAS. 27:</u> Body Plane with Body device position on Middle Channel in GPRS1900-12 mode
GPRS1900	BODY	<u>MEAS. 28:</u> Body Plane with Body device position on Middle Channel in GPRS1900-12 mode
GPRS1900	BODY	<u>MEAS. 29:</u> Body Plane with Body device position on Middle Channel in GPRS1900-12 mode
GPRS1900	BODY	<u>MEAS. 30:</u> Body Plane with Body device position on Middle Channel in GPRS1900-12 mode
Band5_WCDMA8 50	HEAD	<u>MEAS. 31:</u> Left Head with Cheek device position on Middle Channel in WCDMA mode
Band5_WCDMA8 50	HEAD	<u>MEAS. 32:</u> Left Head with Tilt device position on Middle Channel in WCDMA mode
Band5_WCDMA8 50	HEAD	<u>MEAS. 33:</u> Right Head with Cheek device position on Middle Channel in WCDMA mode
Band5_WCDMA8 50	HEAD	<u>MEAS. 34:</u> Right Head with Tilt device position on Middle Channel in WCDMA mode
Band5_WCDMA8 50	BODY	<u>MEAS. 35:</u> Body Plane with Body device position on Middle Channel in WCDMA mode
Band5_WCDMA8 50	BODY	<u>MEAS. 36:</u> Body Plane with Body device position on Middle Channel in WCDMA mode
Band5_WCDMA8 50	BODY	<u>MEAS. 37:</u> Body Plane with Body device position on Middle Channel in WCDMA mode
Band5_WCDMA8 50	BODY	<u>MEAS. 38:</u> Body Plane with Body device position on Middle Channel in WCDMA mode
Band4_WCDMA1 700	HEAD	<u>MEAS. 39:</u> Left Head with Cheek device position on Middle Channel in WCDMA mode
Band4_WCDMA1 700	HEAD	<u>MEAS. 40:</u> Left Head with Tilt device position on Middle Channel in WCDMA mode
Band4_WCDMA1 700	HEAD	<u>MEAS. 41:</u> Right Head with Cheek device position on Middle Channel in WCDMA mode
Band4_WCDMA1 700	HEAD	<u>MEAS. 42:</u> Right Head with Tilt device position on Middle Channel in WCDMA mode
Band4_WCDMA1 700	BODY	<u>MEAS. 43:</u> Body Plane with Body device position on Middle Channel in WCDMA mode

<u>Band</u>	<u>POSITION</u>	<u>PARAMETERS</u>
Band4_WCDMA1 700	BODY	<u>MEAS. 44:</u> Body Plane with Body device position on Middle Channel in WCDMA mode
Band4_WCDMA1 700	BODY	<u>MEAS. 45:</u> Body Plane with Body device position on Middle Channel in WCDMA mode
Band4_WCDMA1 700	BODY	<u>MEAS. 46:</u> Body Plane with Body device position on Middle Channel in WCDMA mode
WLAN 802.11b	HEAD	<u>MEAS. 47:</u> Left Head with Cheek device position on Middle Channel in WLAN 802.11b mode
WLAN 802.11b	HEAD	<u>MEAS. 48:</u> Left Head with Tilt device position on Middle Channel in WLAN 802.11b mode
WLAN 802.11b	HEAD	<u>MEAS. 49:</u> Right Head with Cheek device position on Middle Channel in WLAN 802.11b mode
WLAN 802.11b	HEAD	<u>MEAS. 50:</u> Right Head with Tilt device position on Middle Channel in WLAN 802.11b mode
WLAN 802.11b	BODY	<u>MEAS. 51:</u> Body Plane with Body device position on Middle Channel in WLAN 802.11b mode
WLAN 802.11b	BODY	<u>MEAS. 52:</u> Body Plane with Body device position on Middle Channel in WLAN 802.11b mode
WLAN 802.11b	BODY	<u>MEAS. 53:</u> Body Plane with Body device position on Middle Channel in WLAN 802.11b mode
WLAN 802.11b	BODY	<u>MEAS. 54:</u> Body Plane with Body device position on Middle Channel in WLAN 802.11b mode

MEAS. 1 Left Head with Cheek device position on Middle Channel in GSM850

mode

Test Date: 4/9/2014
Signal: GSM, f=836.4 MHz, Duty Cycle: 1:8.3
Liquid Parameters: Permittivity: 41.40; Conductivity: 0.92 S/m
Test condition: Ambient Temperature: 22.6°C, Liquid Temperature: 22.0°C
Probe: EPG 210, ConvF: 23.67
Area Scan: sam_direct_droit2_surf8mm.txt, h= 5.00 mm
Zoom Scan: 5x5x7,dx=8mm, dy=8mm, dz=5mm,Complete
Maximum location: X=-48.000000, Y=-32.000000
SAR 10g (W/Kg): 0.450227
SAR 1g (W/Kg): 0.652666
Power drift (%): -0.80
3D screen shot

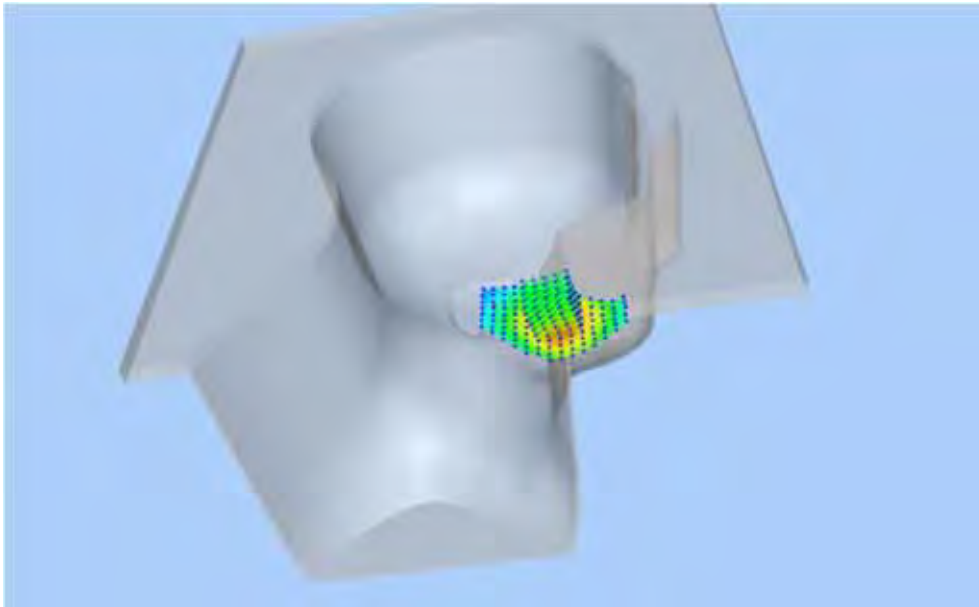

Z Axis Scan

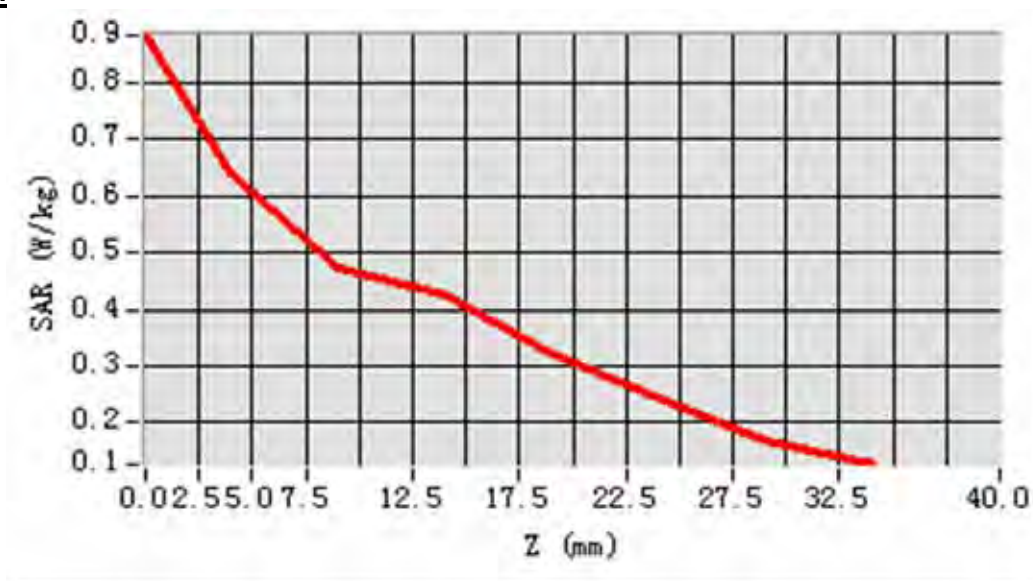

MEAS. 2 Left Head with Tilt device position on Middle Channel in GSM850

mode

Test Date: 4/9/2014
Signal: GSM, f=836.4 MHz, Duty Cycle: 1:8.3
Liquid Parameters: Permittivity: 41.40; Conductivity: 0.92 S/m
Test condition: Ambient Temperature: 22.6°C, Liquid Temperature: 22.0°C
Probe: EPG 210, ConvF: 23.67
Area Scan: sam_direct_droit2_surf8mm.txt, h= 5.00 mm
Zoom Scan: 5x5x7,dx=8mm, dy=8mm, dz=5mm,Complete
Maximum location: X=-32.000000, Y=-16.000000
SAR 10g (W/Kg): 0.240094
SAR 1g (W/Kg): 0.338826
Power drift (%): -3.96
3D screen shot

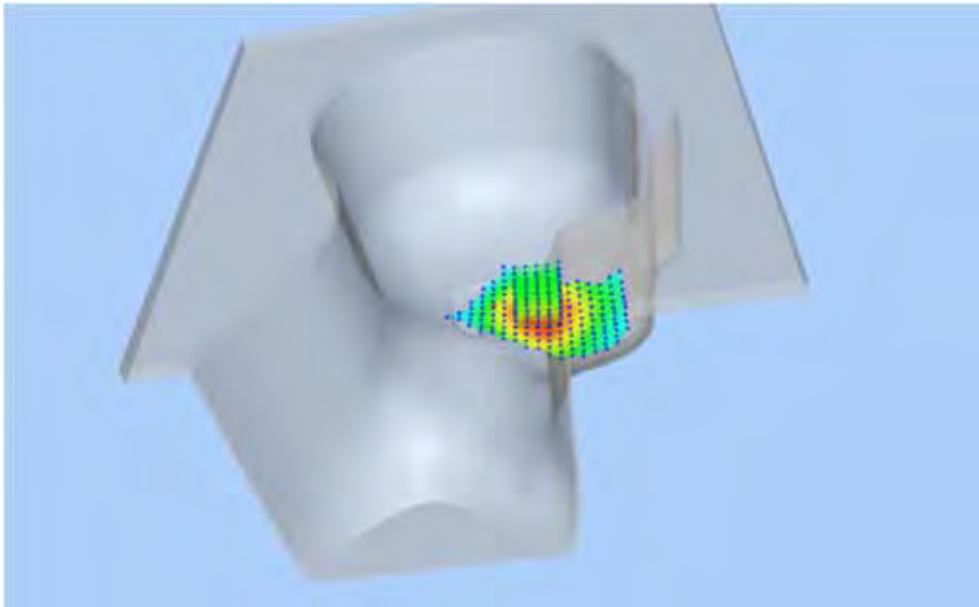

Z Axis Scan

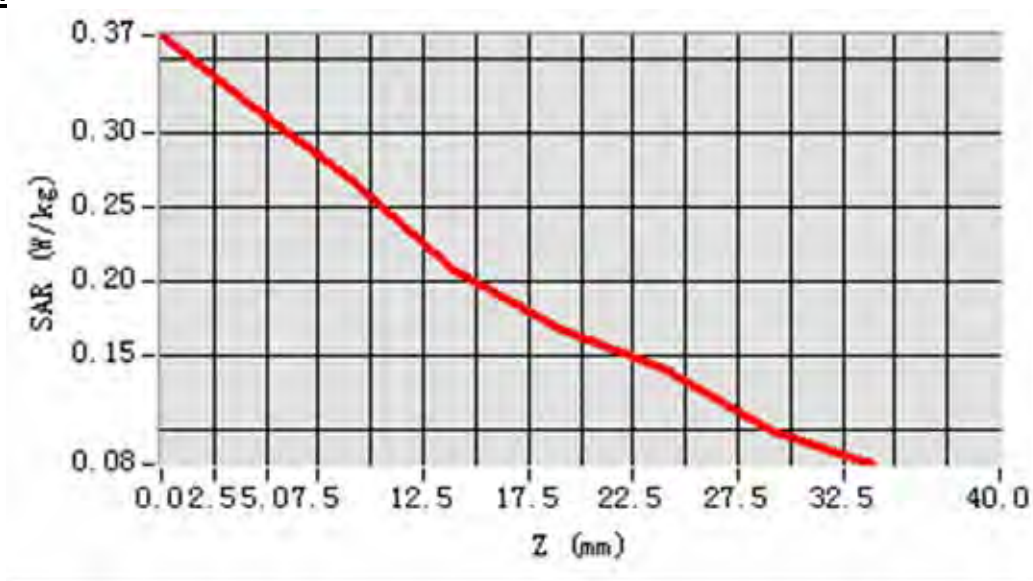

MEAS. 3 Right Head with Cheek device position on Middle Channel in

GSM850 mode

Test Date: 4/9/2014
Signal: GSM, f=836.4 MHz, Duty Cycle: 1:8.3
Liquid Parameters: Permittivity: 41.40; Conductivity: 0.92 S/m
Test condition: Ambient Temperature: 22.6°C, Liquid Temperature: 22.0°C
Probe: EPG 210, ConvF: 23.67
Area Scan: sam_direct_droit2_surf8mm.txt, h= 5.00 mm
Zoom Scan: 5x5x7,dx=8mm, dy=8mm, dz=5mm,Complete
Maximum location: X=-48.000000, Y=-32.000000
SAR 10g (W/Kg): 0.456566
SAR 1g (W/Kg): 0.655356
Power drift (%): 1.58
3D screen shot

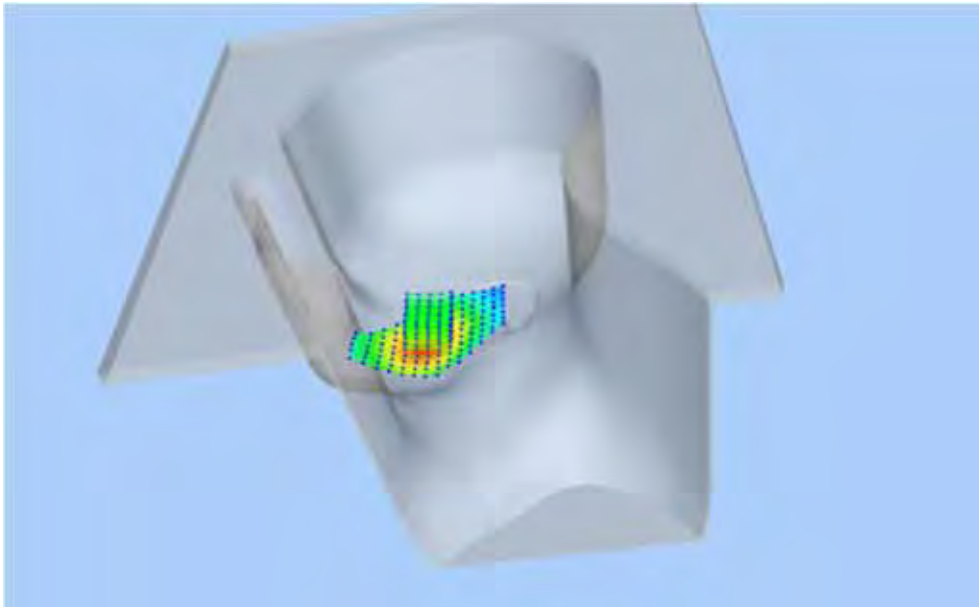

Z Axis Scan

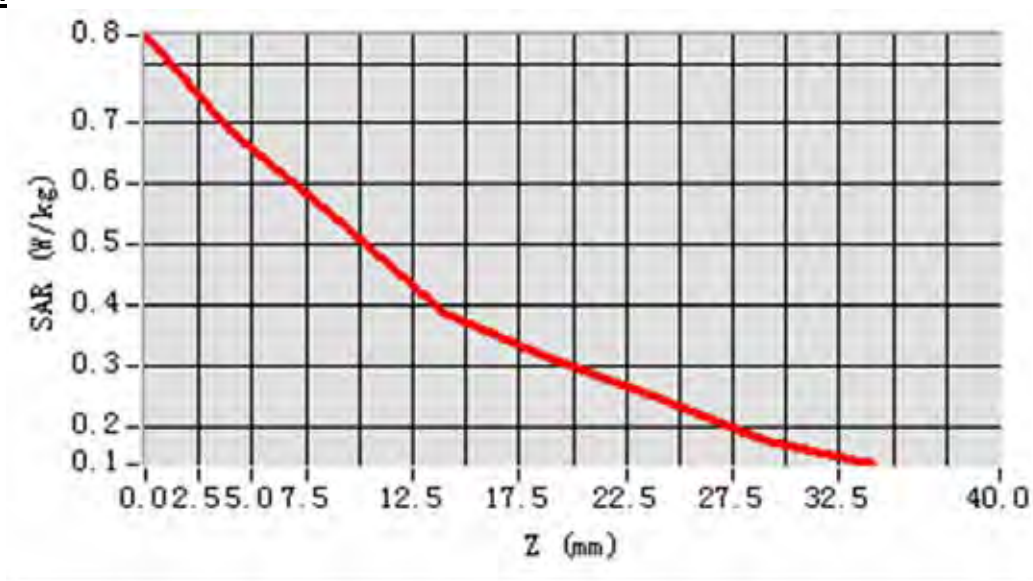

MEAS. 4 Right Head with Tilt device position on Middle Channel in GSM850

mode

Test Date: 4/9/2014
Signal: GSM, f=836.4 MHz, Duty Cycle: 1:8.3
Liquid Parameters: Permittivity: 41.40; Conductivity: 0.92 S/m
Test condition: Ambient Temperature: 22.6°C, Liquid Temperature: 22.0°C
Probe: EPG 210, ConvF: 23.67
Area Scan: sam_direct_droit2_surf8mm.txt, h= 5.00 mm
Zoom Scan: 5x5x7,dx=8mm, dy=8mm, dz=5mm,Complete
Maximum location: X=-32.000000, Y=-16.000000
SAR 10g (W/Kg): 0.292870
SAR 1g (W/Kg): 0.416187
Power drift (%): 1.85
3D screen shot

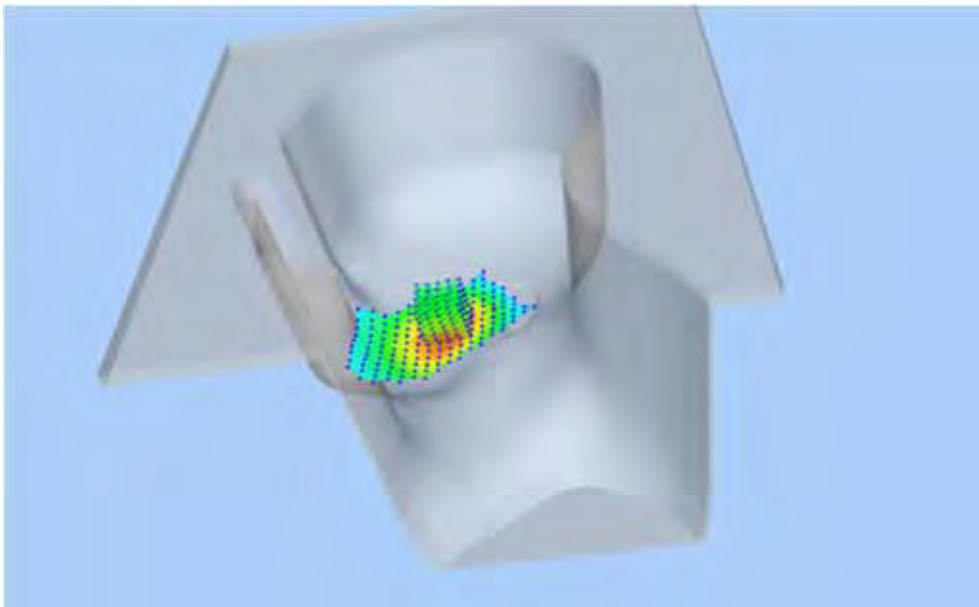

Z Axis Scan

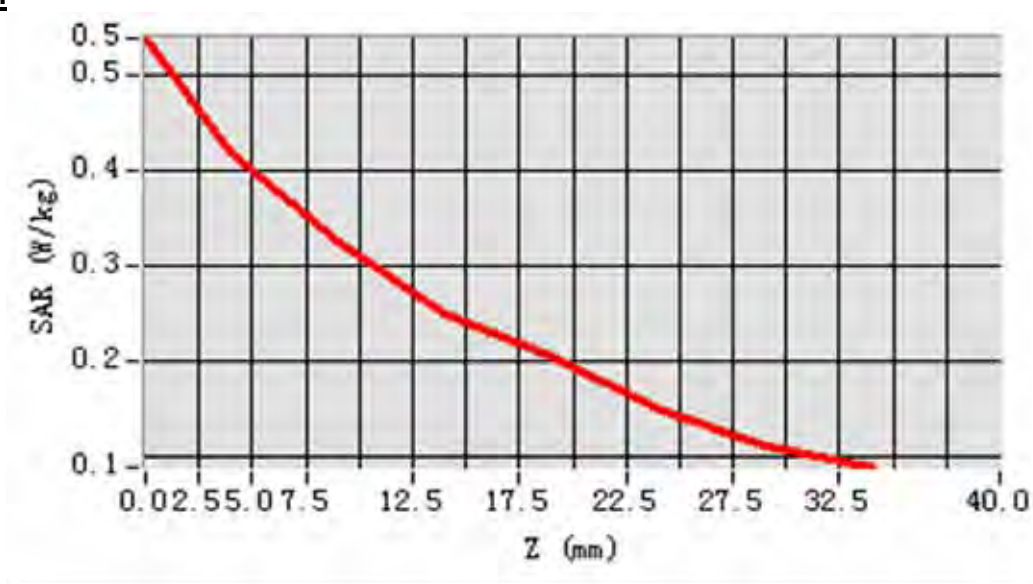

MEAS. 5 Body Plane with Body device position on High Channel in GSM850

mode

Test Date: 5/9/2014
Signal: GSM, f=848.8 MHz, Duty Cycle: 1:8.3
Liquid Parameters: Permittivity: 55.26; Conductivity: 0.99 S/m
Test condition: Ambient Temperature: 22.6°C, Liquid Temperature: 22.0°C
Probe: EPG 210, ConvF: 24.58
Area Scan: sam_direct_droit2_surf8mm.txt, h= 5.00 mm
Zoom Scan: 5x5x7,dx=8mm, dy=8mm, dz=5mm,Complete
Maximum location:
SAR 10g (W/Kg): 0.626640
SAR 1g (W/Kg): 0.928387
Power drift (%): 0.39
3D screen shot

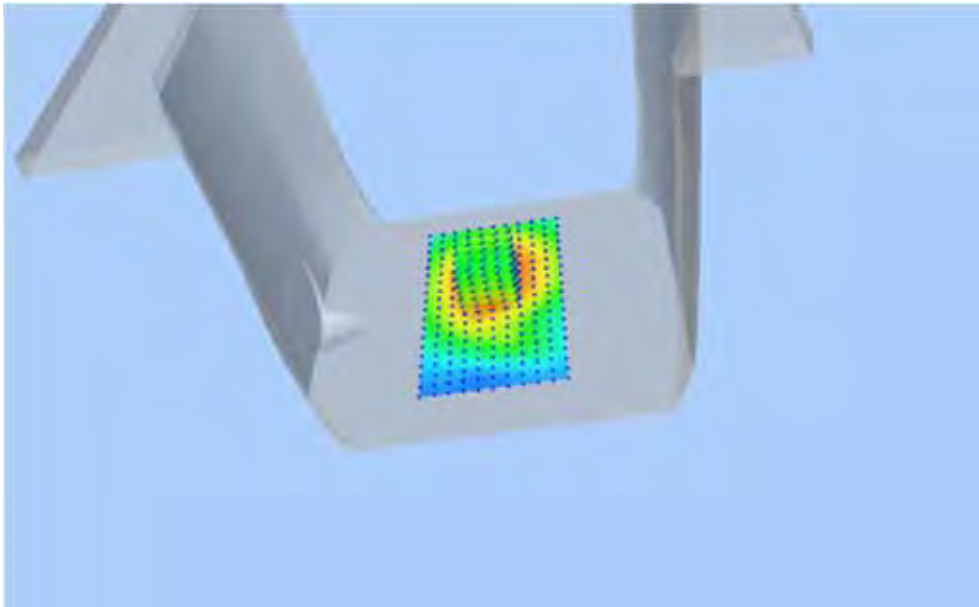

Z Axis Scan

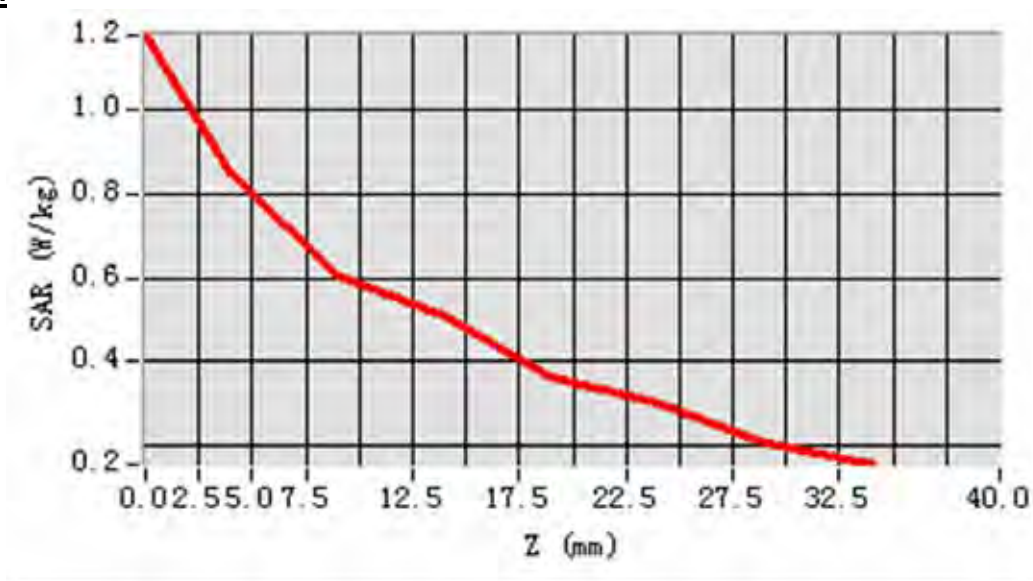

MEAS. 6 Body Plane with Body position on Low Channel in GSM850 mode

Test Date: 5/9/2014
Signal: GSM, f=824.2 MHz, Duty Cycle: 1:8.3
Liquid Parameters: Permittivity: 55.26; Conductivity: 0.99 S/m
Test condition: Ambient Temperature: 22.6°C, Liquid Temperature: 22.0°C
Probe: EPG 210, ConvF: 24.58
Area Scan: sam_direct_droit2_surf8mm.txt, h= 5.00 mm
Zoom Scan: 5x5x7,dx=8mm, dy=8mm, dz=5mm,Complete
Maximum location:
SAR 10g (W/Kg): 0.616206
SAR 1g (W/Kg): 0.870078
Power drift (%): 1.75
3D screen shot

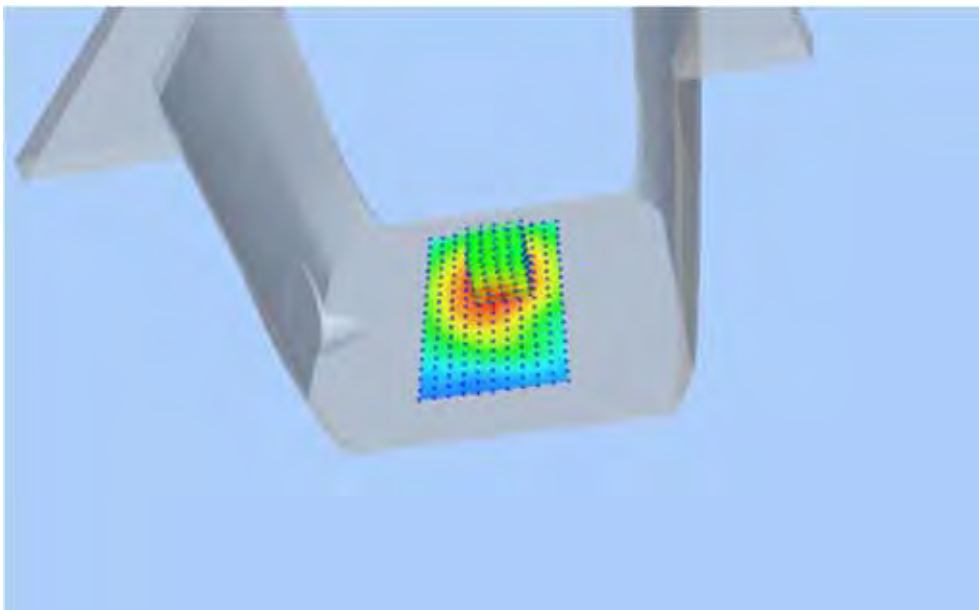

Z Axis Scan

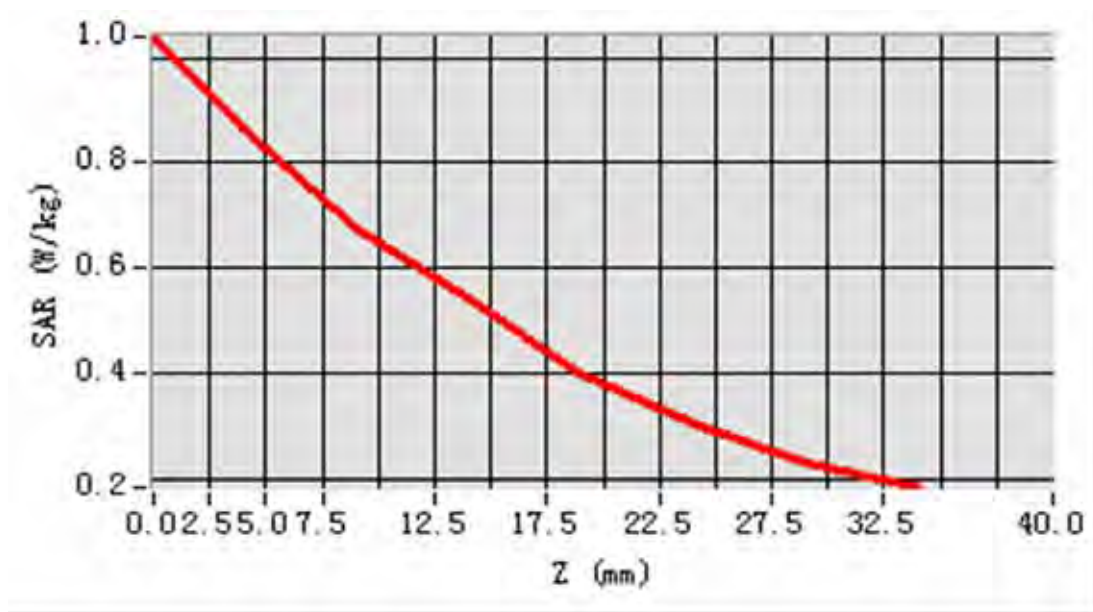

MEAS. 7 Body Plane with Body device position on Middle Channel in GSM850

mode

Test Date: 10/9/2014
Signal: GSM, f=836.4 MHz, Duty Cycle: 1:8.3
Liquid Parameters: Permittivity: 55.26; Conductivity: 0.99 S/m
Test condition: Ambient Temperature: 22.6°C, Liquid Temperature: 22.0°C
Probe: EPG 210, ConvF: 24.58
Area Scan: sam_direct_droit2_surf8mm.txt, h= 5.00 mm
Zoom Scan: 5x5x7,dx=8mm, dy=8mm, dz=5mm,Complete
Maximum location: X=16.000000, Y=-24.000000
SAR 10g (W/Kg): 0.045278
SAR 1g (W/Kg): 0.070511
Power drift (%): -2.11
3D screen shot

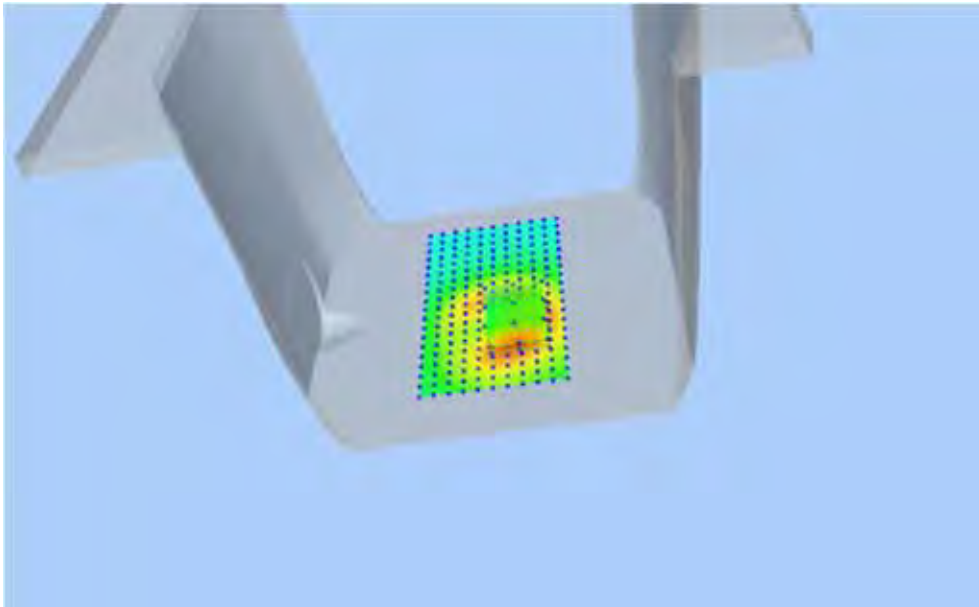

Z Axis Scan

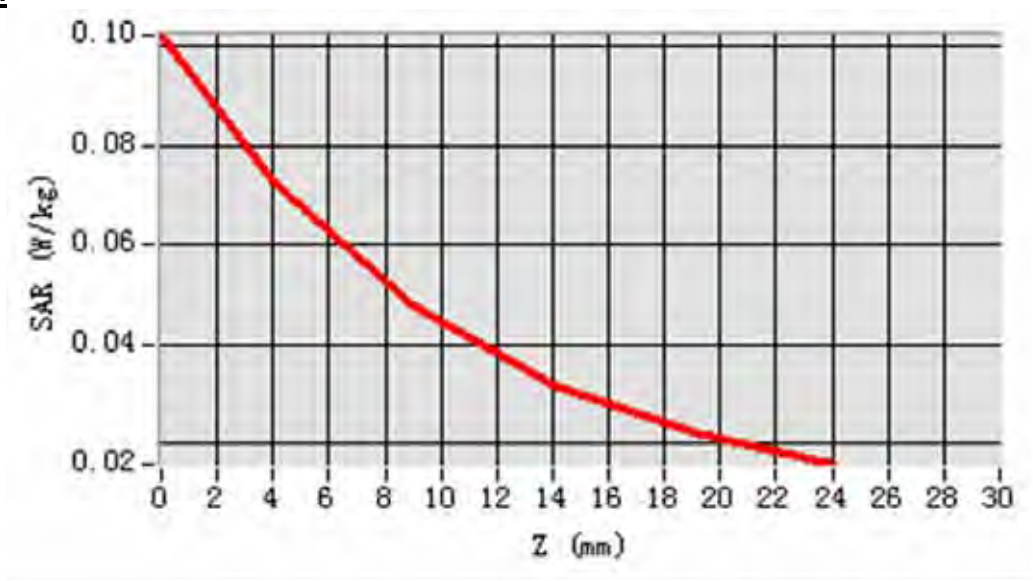

MEAS. 8 Body Plane with Body device position on Middle Channel in GSM850

mode

Test Date: 5/9/2014
Signal: GSM, f=836.4 MHz, Duty Cycle: 1:8.3
Liquid Parameters: Permittivity: 55.26; Conductivity: 0.99 S/m
Test condition: Ambient Temperature: 22.6°C, Liquid Temperature: 22.0°C
Probe: EPG 210, ConvF: 24.58
Area Scan: sam_direct_droit2_surf8mm.txt, h= 5.00 mm
Zoom Scan: 5x5x7,dx=8mm, dy=8mm, dz=5mm,Complete
Maximum location: X=0.000000, Y=64.000000
SAR 10g (W/Kg): 0.196032
SAR 1g (W/Kg): 0.271914
Power drift (%): -1.06
3D screen shot

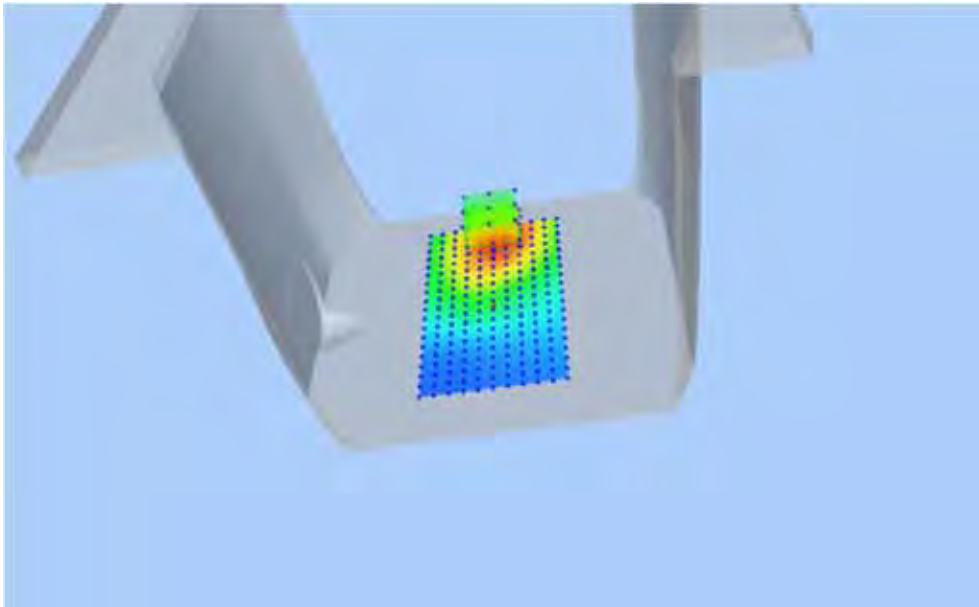

Z Axis Scan

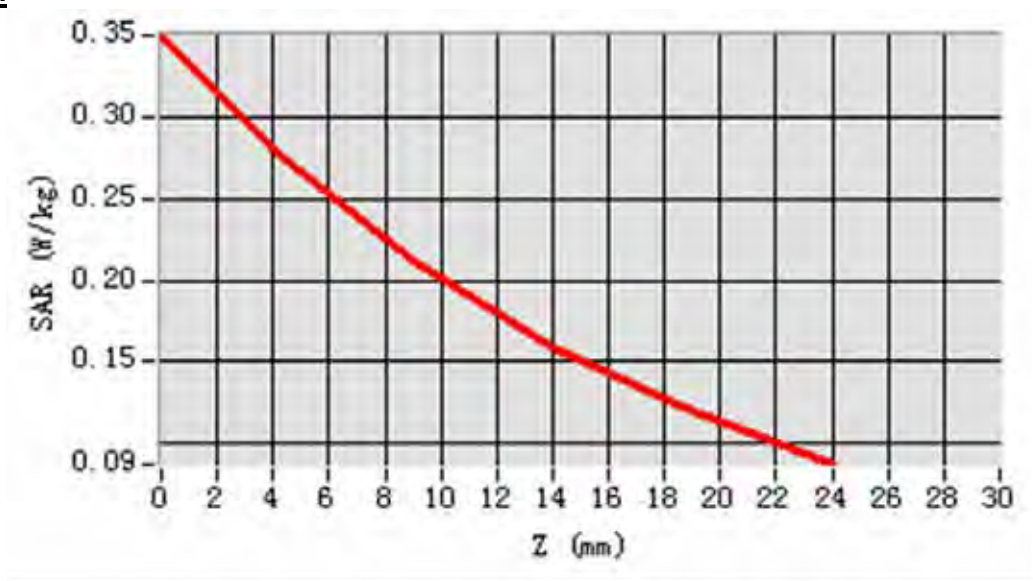

MEAS. 9 Body Plane with Body device position on Middle Channel in GSM850

mode

Test Date: 5/9/2014
Signal: GSM, f=836.4 MHz, Duty Cycle: 1:8.3
Liquid Parameters: Permittivity: 55.26; Conductivity: 0.99 S/m
Test condition: Ambient Temperature: 22.6°C, Liquid Temperature: 22.0°C
Probe: EPG 210, ConvF: 24.58
Area Scan: sam_direct_droit2_surf8mm.txt, h= 5.00 mm
Zoom Scan: 5x5x7,dx=8mm, dy=8mm, dz=5mm,Complete
Maximum location: X=0.000000, Y=56.000000
SAR 10g (W/Kg): 0.683365
SAR 1g (W/Kg): 0.991175
Power drift (%): -0.61
3D screen shot

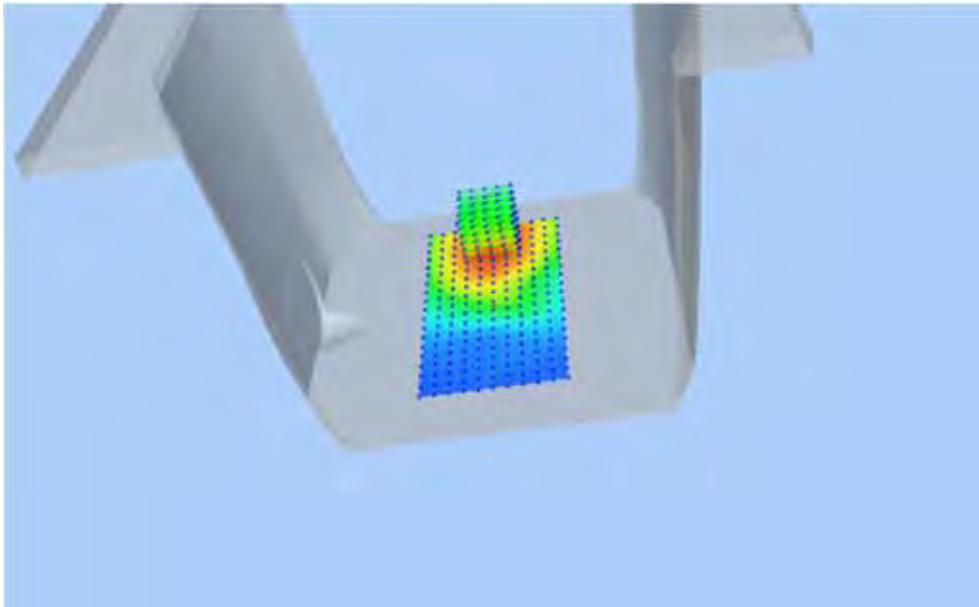

Z Axis Scan

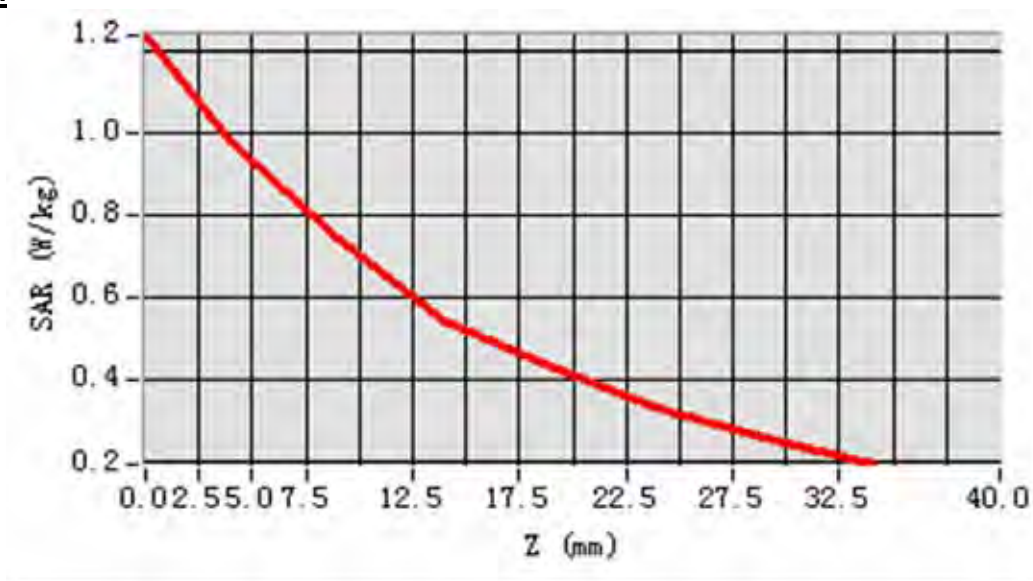

MEAS. 10 Body Plane with Body device position on Middle Channel in

GSM850 mode

Test Date: 5/9/2014
Signal: GSM, f=836.4 MHz, Duty Cycle: 1:8.3
Liquid Parameters: Permittivity: 55.26; Conductivity: 0.99 S/m
Test condition: Ambient Temperature: 22.6°C, Liquid Temperature: 22.0°C
Probe: EPG 210, ConvF: 24.58
Area Scan: sam_direct_droit2_surf8mm.txt, h= 5.00 mm
Zoom Scan: 5x5x7,dx=8mm, dy=8mm, dz=5mm,Complete
Maximum location: X=0.000000, Y=24.000000
SAR 10g (W/Kg): 0.488204
SAR 1g (W/Kg): 0.700515
Power drift (%): 1.20
3D screen shot

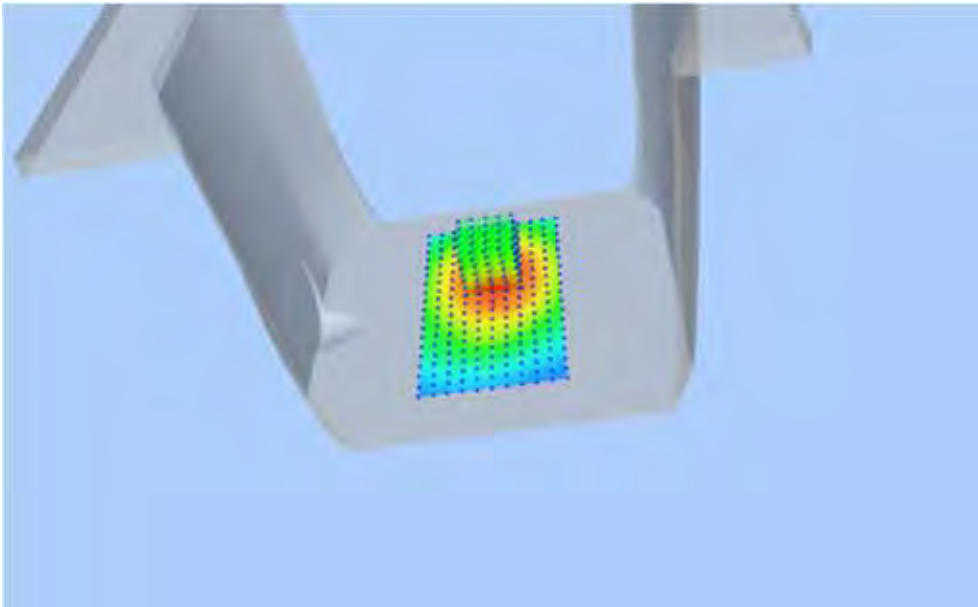

Z Axis Scan

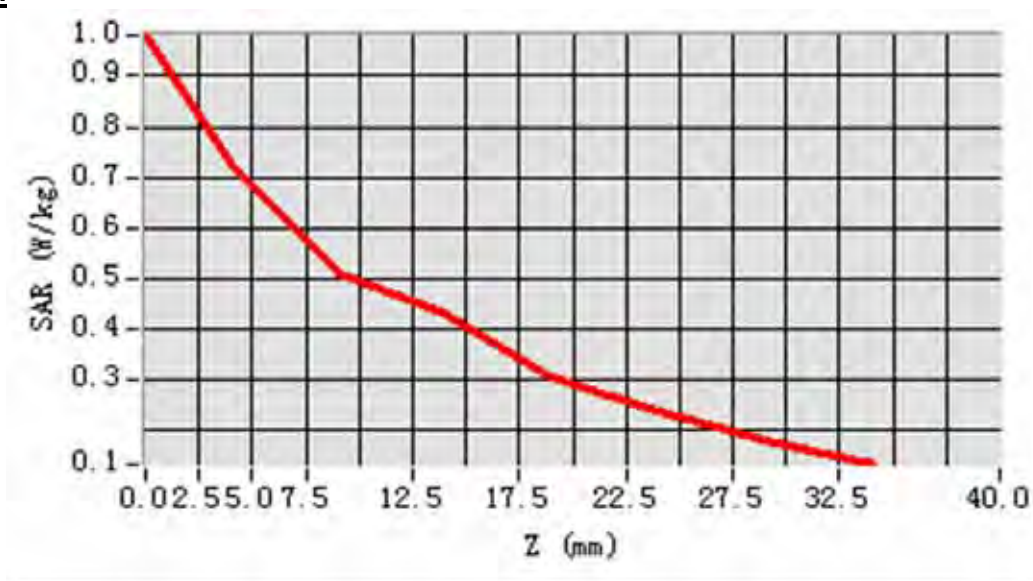

MEAS. 11 Body Plane with Body device position on Low Channel in

GPRS850-12 mode

Test Date: 5/9/2014
Signal: GPRS, f=824.2 MHz, Duty Cycle: 1:2.0
Liquid Parameters: Permittivity: 55.26; Conductivity: 0.99 S/m
Test condition: Ambient Temperature: 22.6°C, Liquid Temperature: 22.0°C
Probe: EPG 210, ConvF: 24.58
Area Scan: sam_direct_droit2_surf8mm.txt, h= 5.00 mm
Zoom Scan: 5x5x7,dx=8mm, dy=8mm, dz=5mm,Complete
Maximum location:
SAR 10g (W/Kg): 0.512384
SAR 1g (W/Kg): 0.892170
Power drift (%): 0.35
3D screen shot

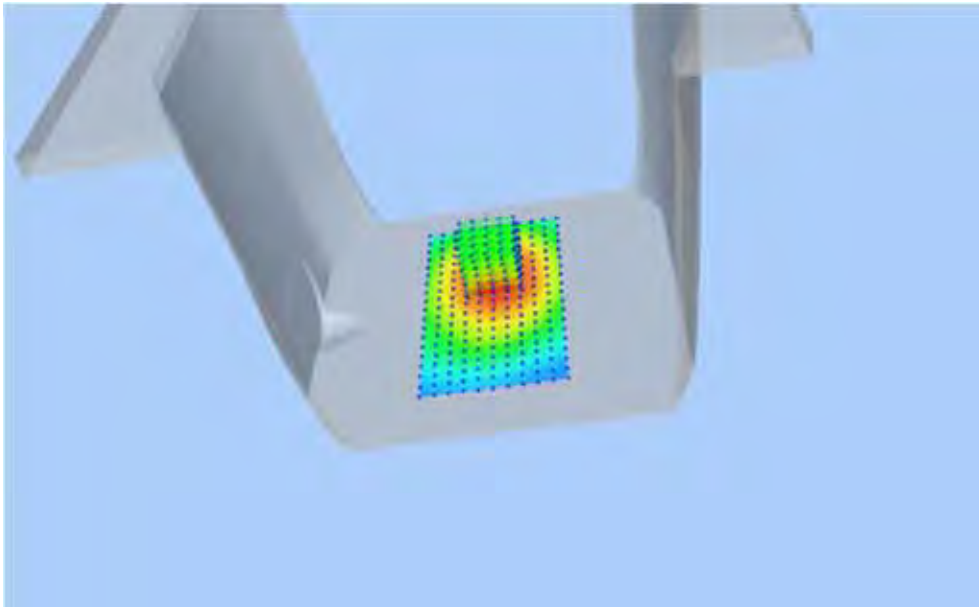

Z Axis Scan

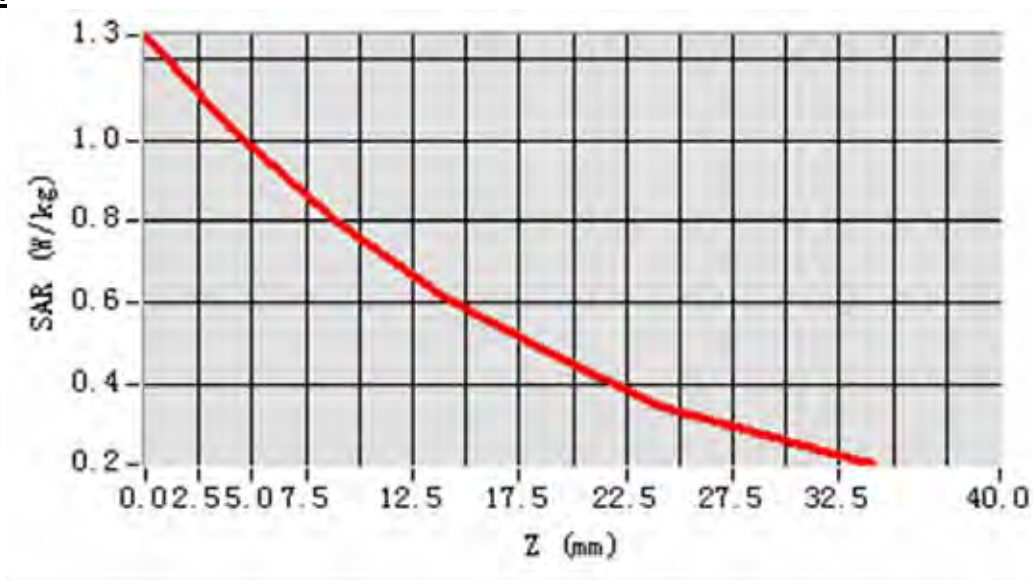

MEAS. 12 Body Plane with Body device position on Middle Channel in

GPRS850-12 mode

Test Date: 5/9/2014
Signal: GPRS, f=836.6 MHz, Duty Cycle: 1:2.0
Liquid Parameters: Permittivity: 55.26; Conductivity: 0.99 S/m
Test condition: Ambient Temperature: 22.6°C, Liquid Temperature: 22.0°C
Probe: EPG 210, ConvF: 24.58
Area Scan: sam_direct_droit2_surf8mm.txt, h= 5.00 mm
Zoom Scan: 5x5x7,dx=8mm, dy=8mm, dz=5mm,Complete
Maximum location: X=0.000000, Y=16.000000
SAR 10g (W/Kg): 0.632629
SAR 1g (W/Kg): 0.923911
Power drift (%): -2.35
3D screen shot

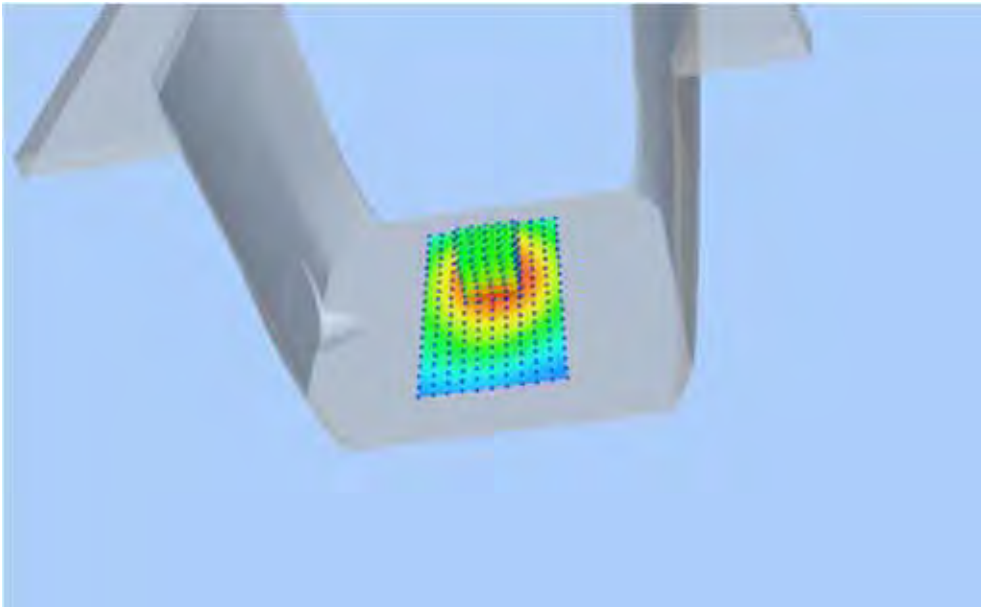

Z Axis Scan

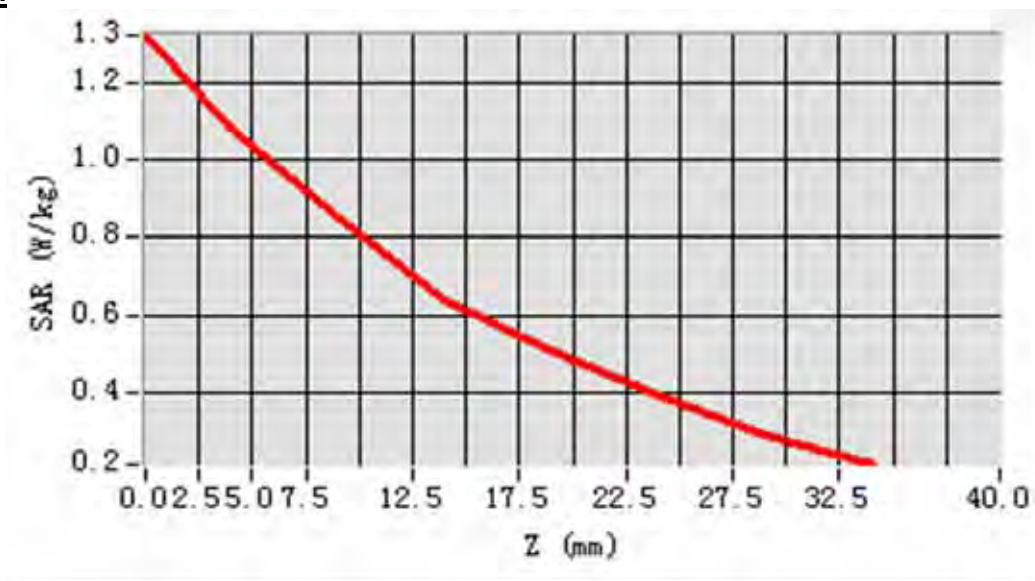

MEAS. 13 Body Plane with Body device position on High Channel in GPRS850-12 mode

Test Date: 5/9/2014
Signal: GPRS, f=848.8 MHz, Duty Cycle: 1:2.0
Liquid Parameters: Permittivity: 55.26; Conductivity: 0.99 S/m
Test condition: Ambient Temperature: 22.6°C, Liquid Temperature: 22.0°C
Probe: EPG 210, ConvF: 24.58
Area Scan: sam_direct_droit2_surf8mm.txt, h= 5.00 mm
Zoom Scan: 5x5x7,dx=8mm, dy=8mm, dz=5mm,Complete
Maximum location:
SAR 10g (W/Kg): 0.562690
SAR 1g (W/Kg): 0.845867
Power drift (%): 0.54
3D screen shot

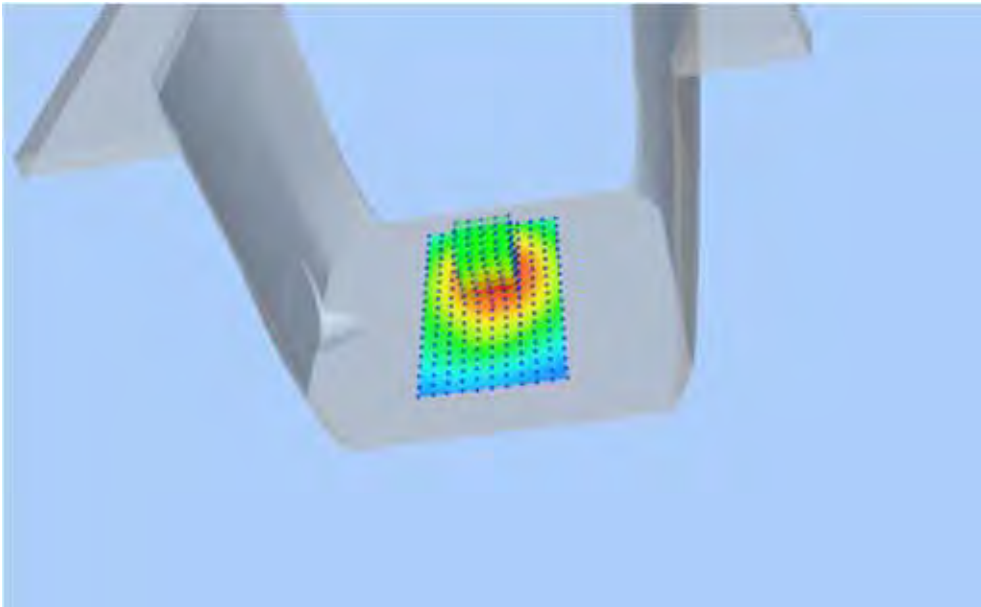

Z Axis Scan

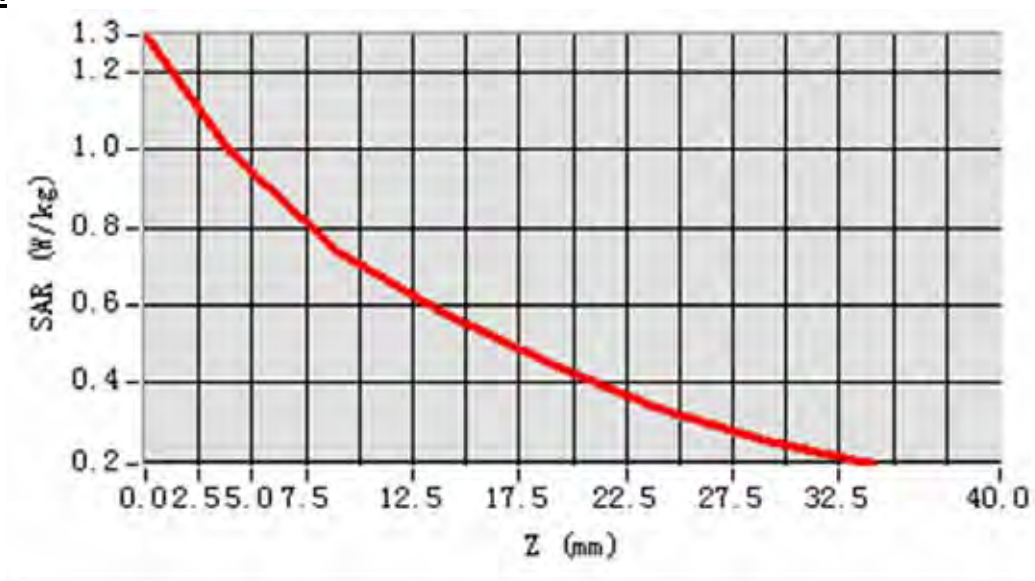

MEAS. 14 Body Plane with Body device position on Low Channel in

GPRS850-12 mode

Test Date: 5/9/2014
Signal: GPRS, f=824.2 MHz, Duty Cycle: 1:2.0
Liquid Parameters: Permittivity: 55.26; Conductivity: 0.99 S/m
Test condition: Ambient Temperature: 22.6°C, Liquid Temperature: 22.0°C
Probe: EPG 210, ConvF: 24.58
Area Scan: sam_direct_droit2_surf8mm.txt, h= 5.00 mm
Zoom Scan: 5x5x7,dx=8mm, dy=8mm, dz=5mm,Complete
Maximum location:
SAR 10g (W/Kg): 0.7321540
SAR 1g (W/Kg): 1.023100
Power drift (%): -0.83
3D screen shot

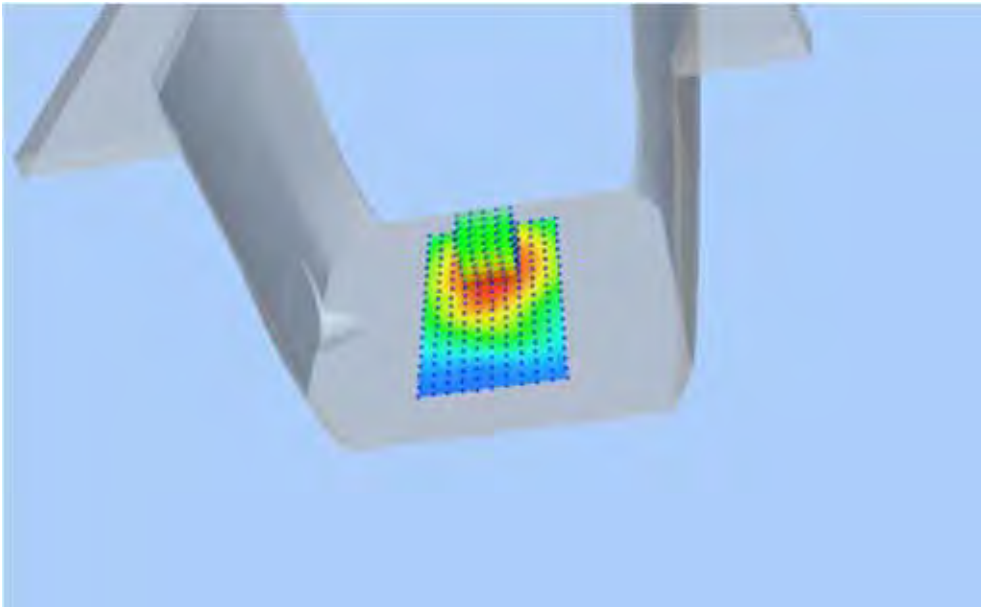

Z Axis Scan

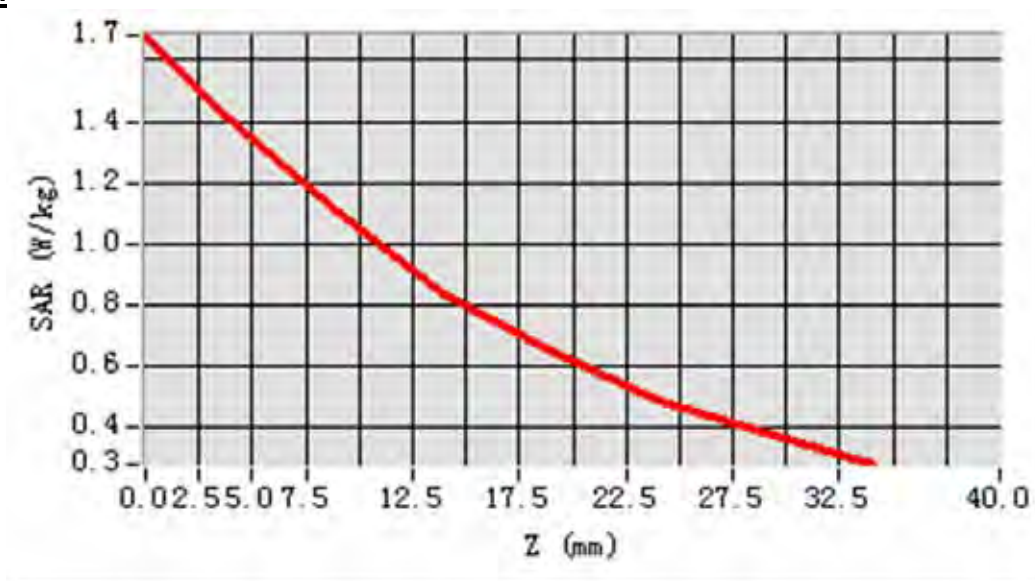

MEAS. 15 Body Plane with Body device position on Middle Channel in

GPRS850-12 mode

Test Date: 5/9/2014
Signal: GPRS, f=836.6 MHz, Duty Cycle: 1:2.0
Liquid Parameters: Permittivity: 55.26; Conductivity: 0.99 S/m
Test condition: Ambient Temperature: 22.6°C, Liquid Temperature: 22.0°C
Probe: EPG 210, ConvF: 24.58
Area Scan: sam_direct_droit2_surf8mm.txt, h= 5.00 mm
Zoom Scan: 5x5x7,dx=8mm, dy=8mm, dz=5mm,Complete
Maximum location: X=0.000000, Y=40.000000
SAR 10g (W/Kg): 0.602646
SAR 1g (W/Kg): 1.089585
Power drift (%): -1.87
3D screen shot

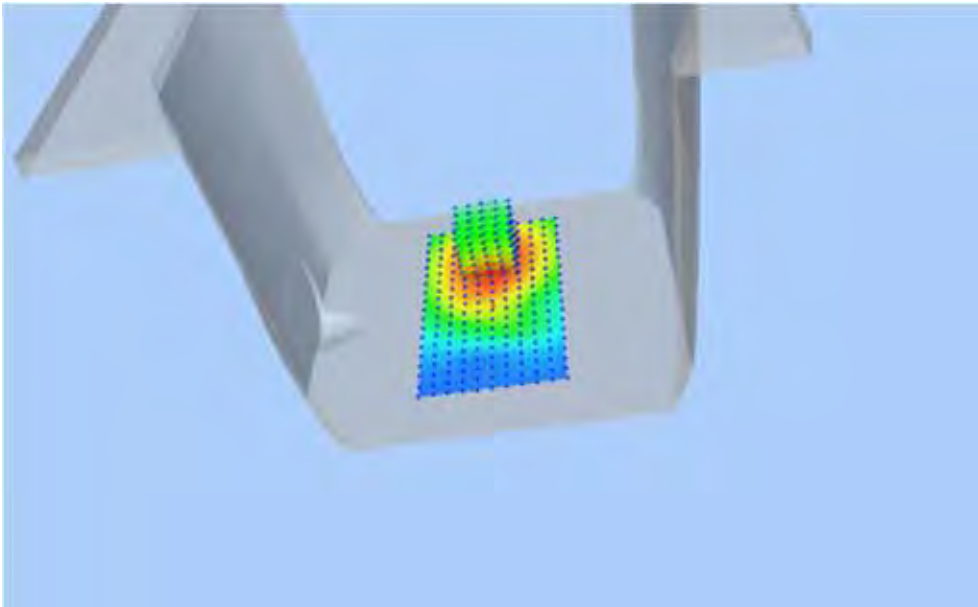

Z Axis Scan

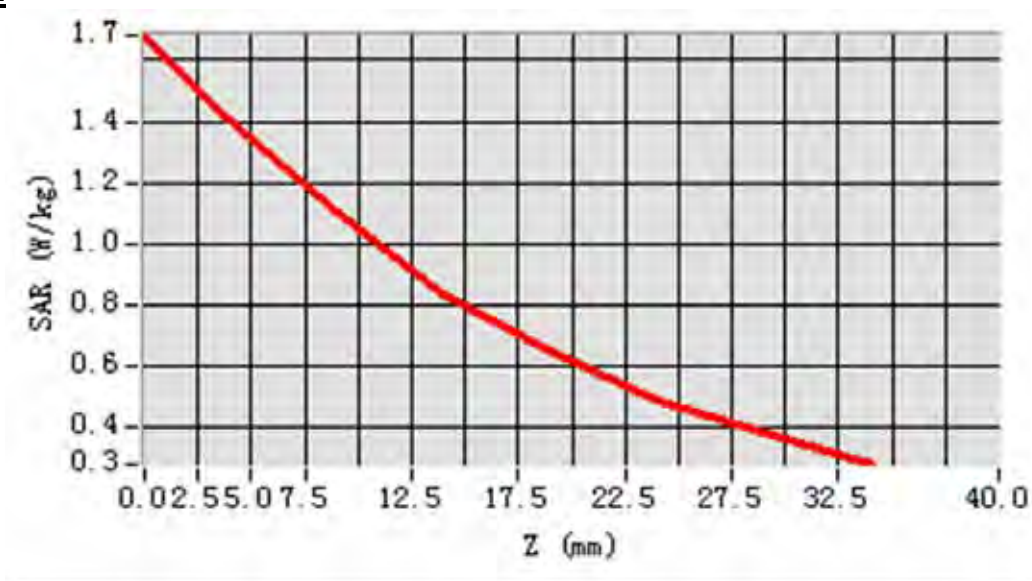

MEAS. 16 Body Plane with Body device position on High Channel in

GPRS850-12 mode

Test Date: 5/9/2014
Signal: GPRS, f=848.8 MHz, Duty Cycle: 1:2.0
Liquid Parameters: Permittivity: 55.26; Conductivity: 0.99 S/m
Test condition: Ambient Temperature: 22.6°C, Liquid Temperature: 22.0°C
Probe: EPG 210, ConvF: 24.58
Area Scan: sam_direct_droit2_surf8mm.txt, h= 5.00 mm
Zoom Scan: 5x5x7,dx=8mm, dy=8mm, dz=5mm,Complete
Maximum location:
SAR 10g (W/Kg): 0.712833
SAR 1g (W/Kg): 1.066447
Power drift (%): -0.09
3D screen shot

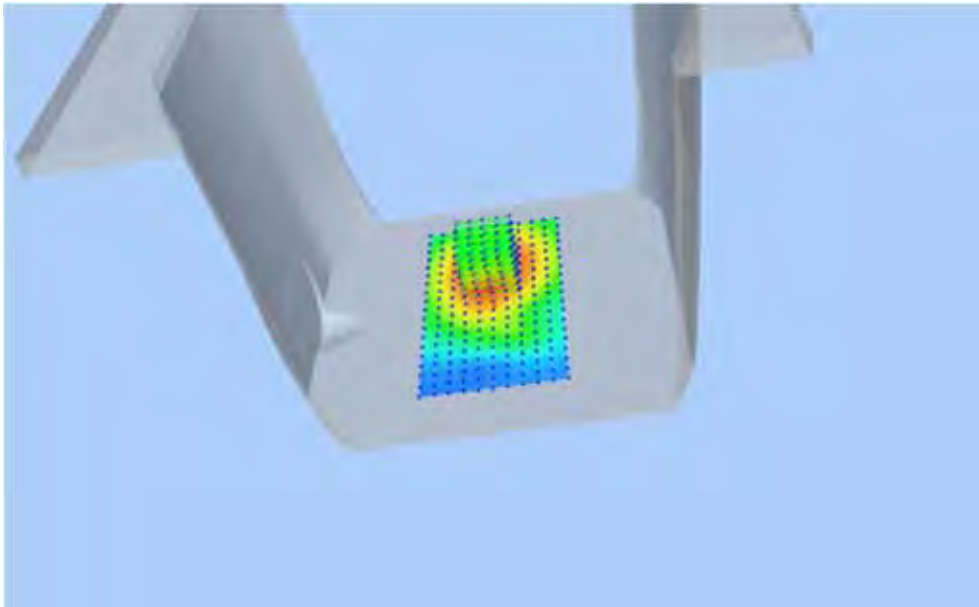

Z Axis Scan

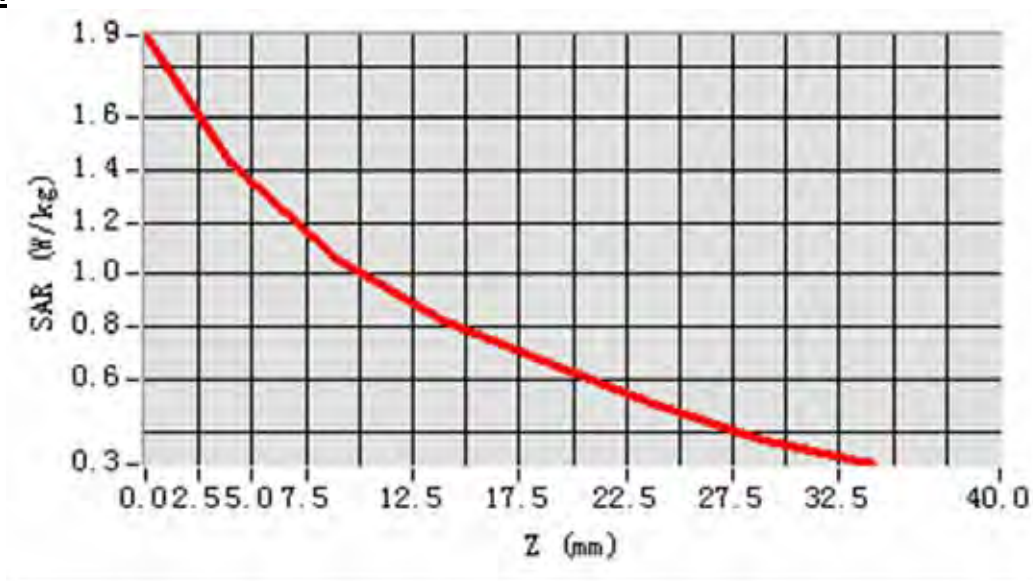

MEAS. 17 Body Plane with Body device position on Low Channel in

GPRS850-12 mode

Test Date: 5/9/2014
Signal: GPRS, f=824.2 MHz, Duty Cycle: 1:2.0
Liquid Parameters: Permittivity: 55.26; Conductivity: 0.99 S/m
Test condition: Ambient Temperature: 22.6°C, Liquid Temperature: 22.0°C
Probe: EPG 210, ConvF: 24.58
Area Scan: sam_direct_droit2_surf8mm.txt, h= 5.00 mm
Zoom Scan: 5x5x7,dx=8mm, dy=8mm, dz=5mm,Complete
Maximum location: X=8.000000, Y=48.000000
SAR 10g (W/Kg): 0.319845
SAR 1g (W/Kg): 0.464227
Power drift (%): -2.95
3D screen shot

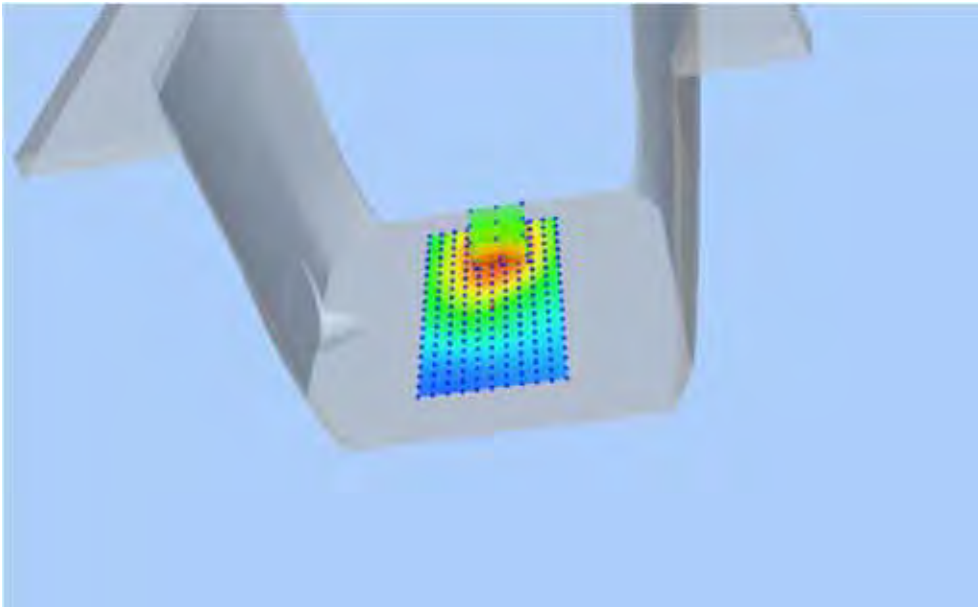

Z Axis Scan

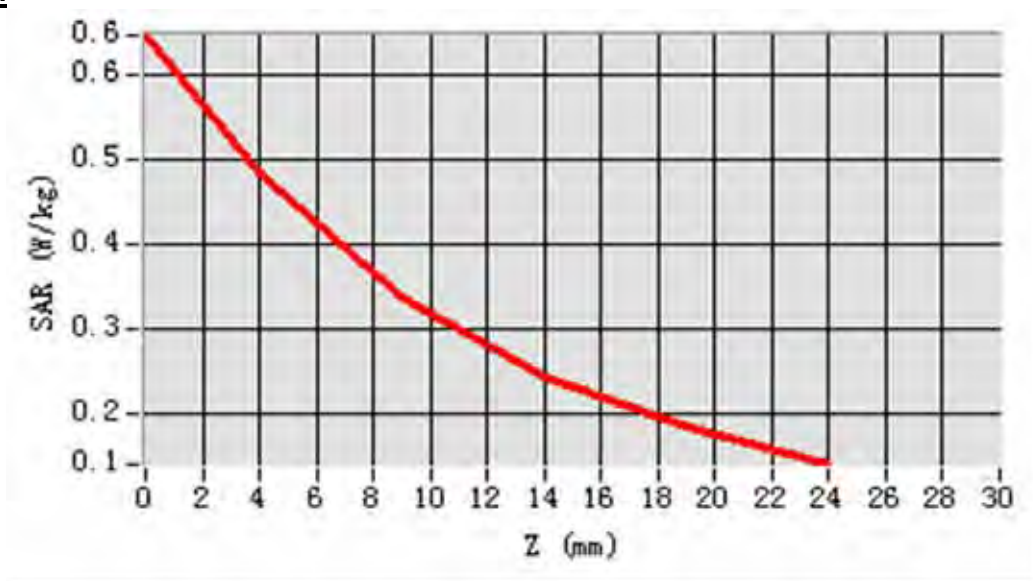

MEAS. 18 Body Plane with Body device position on Low Channel in

GPRS850-12 mode

Test Date: 5/9/2014
Signal: GPRS, f=824.2 MHz, Duty Cycle: 1:2.0
Liquid Parameters: Permittivity: 55.26; Conductivity: 0.99 S/m
Test condition: Ambient Temperature: 22.6°C, Liquid Temperature: 22.0°C
Probe: EPG 210, ConvF: 24.58
Area Scan: sam_direct_droit2_surf8mm.txt, h= 5.00 mm
Zoom Scan: 5x5x7,dx=8mm, dy=8mm, dz=5mm,Complete
Maximum location: X=-16.000000, Y=24.000000
SAR 10g (W/Kg): 0.055266
SAR 1g (W/Kg): 0.082409
Power drift (%): -1.20
3D screen shot

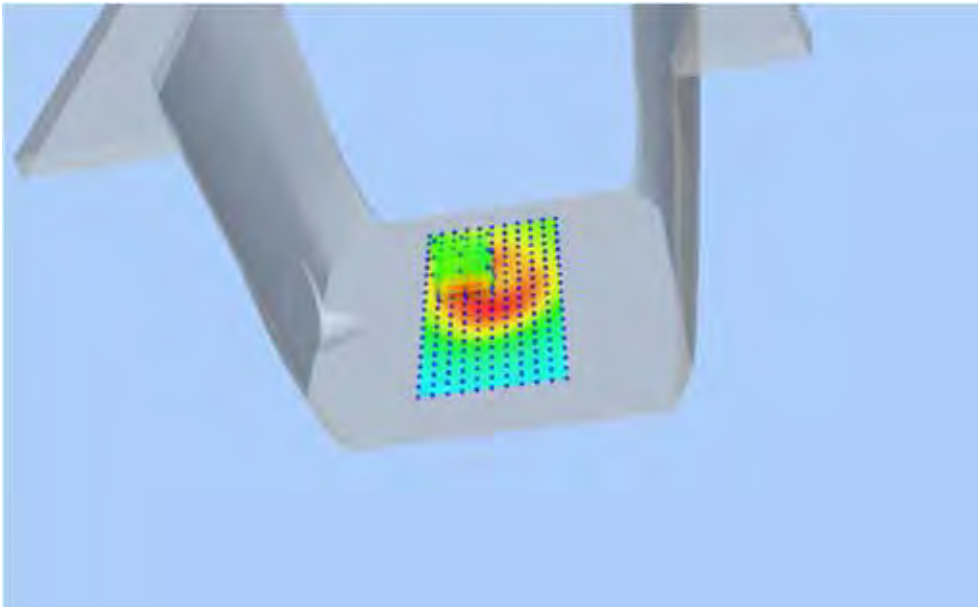

Z Axis Scan

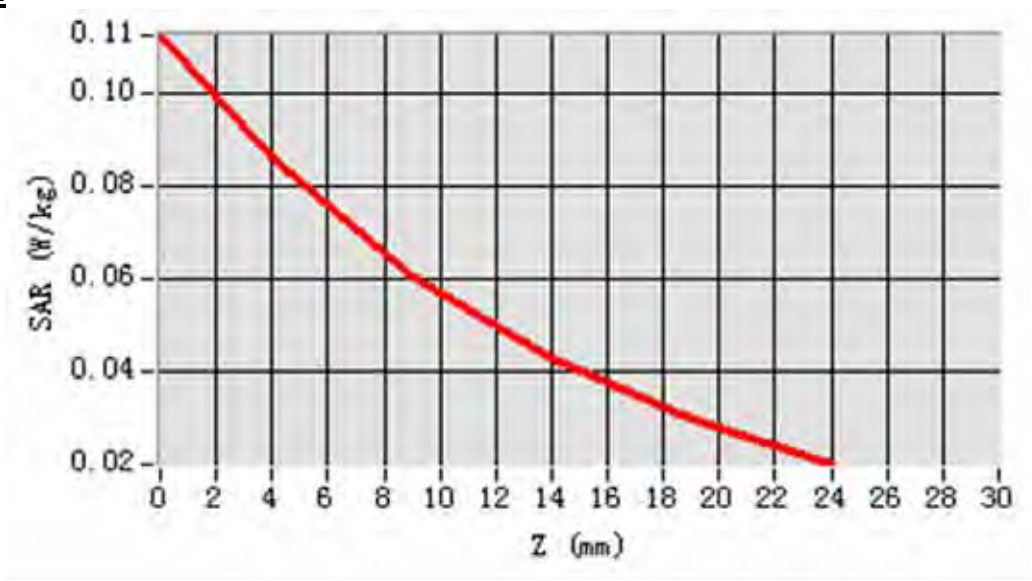

MEAS. 19 Left Head with Cheek device position on Middle Channel in

GSM1900 mode

Test Date: 4/9/2014
Signal: GSM, f=1880.0 MHz, Duty Cycle: 1:8.3
Liquid Parameters: Permittivity: 41.00; Conductivity: 1.42 S/m
Test condition: Ambient Temperature: 22.6°C, Liquid Temperature: 22.0°C
Probe: EPG 210, ConvF: 26.70
Area Scan: sam_direct_droit2_surf8mm.txt, h= 5.00 mm
Zoom Scan: 5x5x7,dx=8mm, dy=8mm, dz=5mm,Complete
Maximum location: X=-48.000000, Y=-56.000000
SAR 10g (W/Kg): 0.104311
SAR 1g (W/Kg): 0.186155
Power drift (%): 2.97
3D screen shot

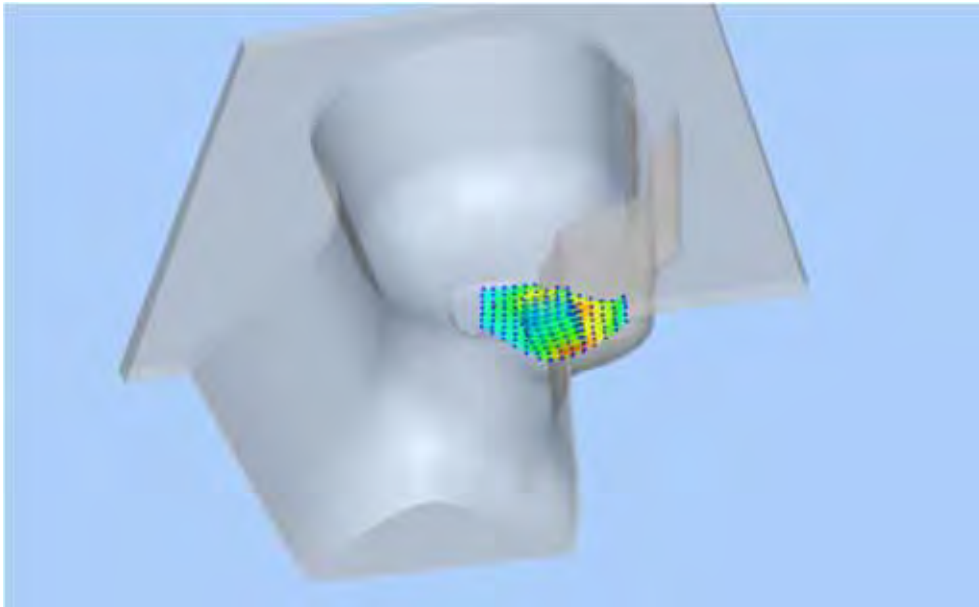

Z Axis Scan

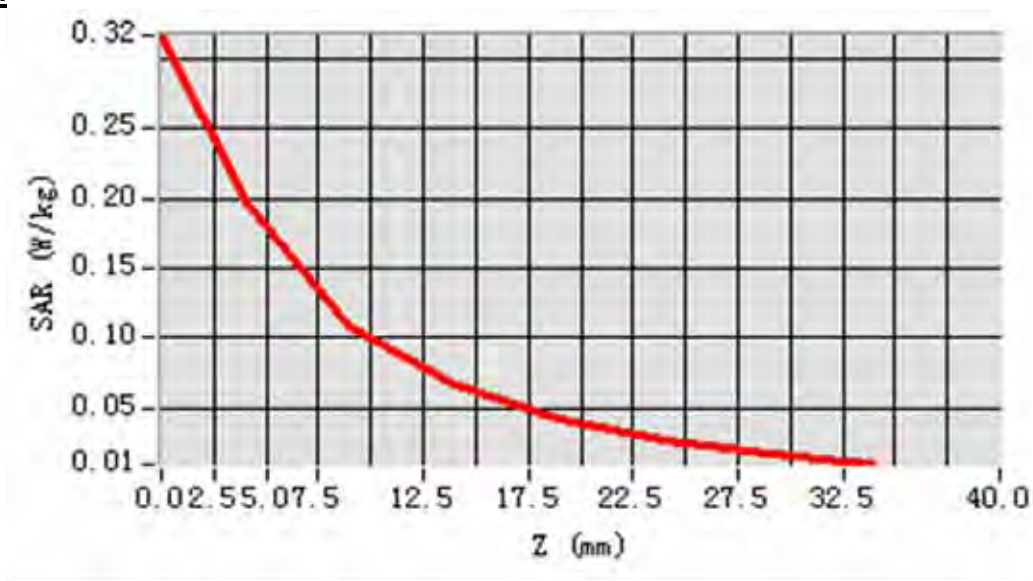

MEAS. 20 Left Head with Tilt device position on Middle Channel in GSM1900

mode

Test Date: 4/9/2014
Signal: GSM, f=1880.0 MHz, Duty Cycle: 1:8.3
Liquid Parameters: Permittivity: 41.00; Conductivity: 1.42 S/m
Test condition: Ambient Temperature: 22.6°C, Liquid Temperature: 22.0°C
Probe: EPG 210, ConvF: 26.70
Area Scan: sam_direct_droit2_surf8mm.txt, h= 5.00 mm
Zoom Scan: 5x5x7,dx=8mm, dy=8mm, dz=5mm,Complete
Maximum location: X=-24.000000, Y=8.000000
SAR 10g (W/Kg): 0.070144
SAR 1g (W/Kg): 0.124600
Power drift (%): -1.60
3D screen shot

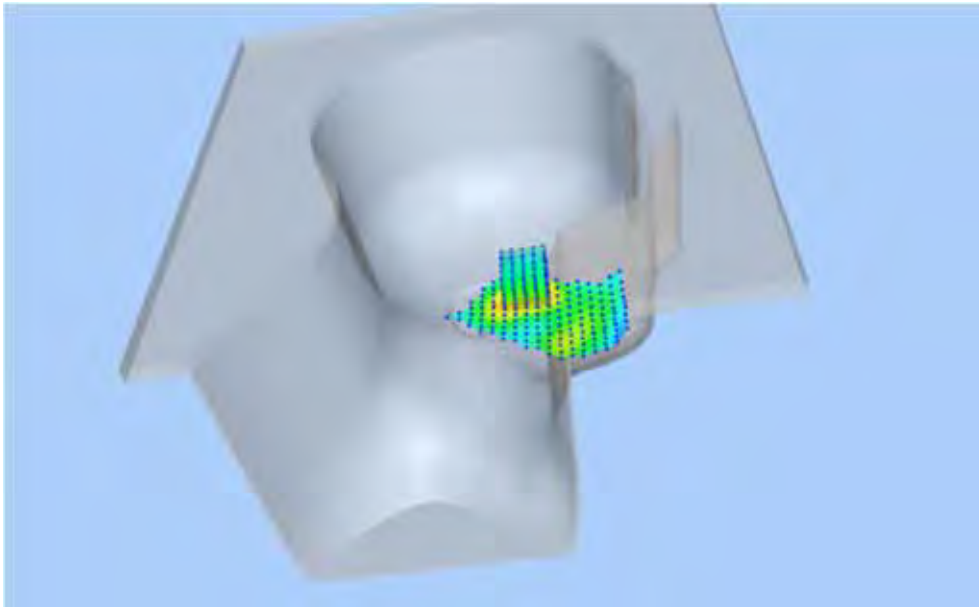

Z Axis Scan

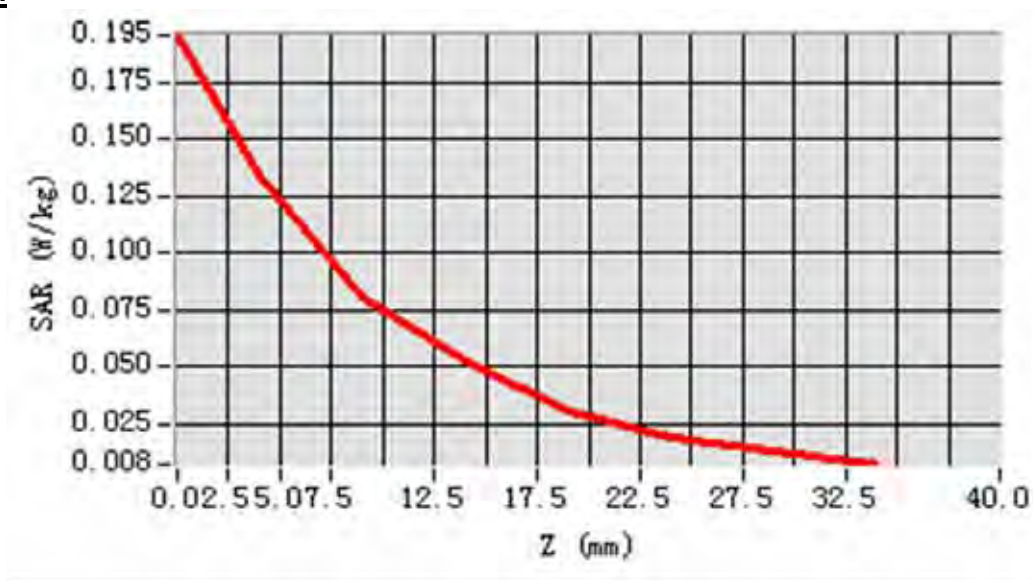

MEAS. 21 Right Head with Cheek device position on Middle Channel in

GSM1900 mode

Test Date: 4/9/2014
Signal: GSM, f=1880.0 MHz, Duty Cycle: 1:8.3
Liquid Parameters: Permittivity: 41.00; Conductivity: 1.42 S/m
Test condition: Ambient Temperature: 22.6°C, Liquid Temperature: 22.0°C
Probe: EPG 210, ConvF: 26.70
Area Scan: sam_direct_droit2_surf8mm.txt, h= 5.00 mm
Zoom Scan: 5x5x7,dx=8mm, dy=8mm, dz=5mm,Complete
Maximum location: X=-56.000000, Y=-48.000000
SAR 10g (W/Kg): 0.104485
SAR 1g (W/Kg): 0.184697
Power drift (%): 0.43
3D screen shot

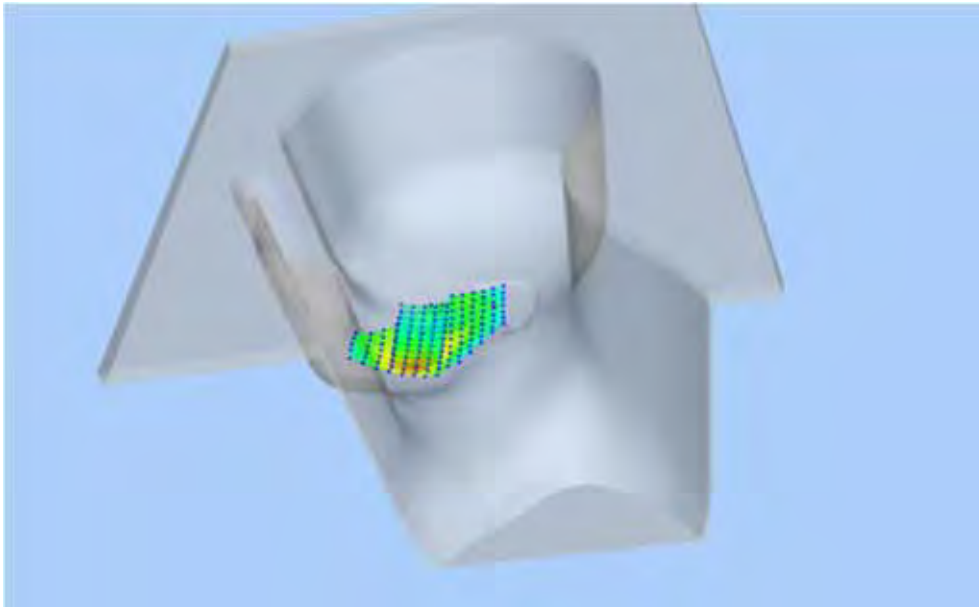

Z Axis Scan

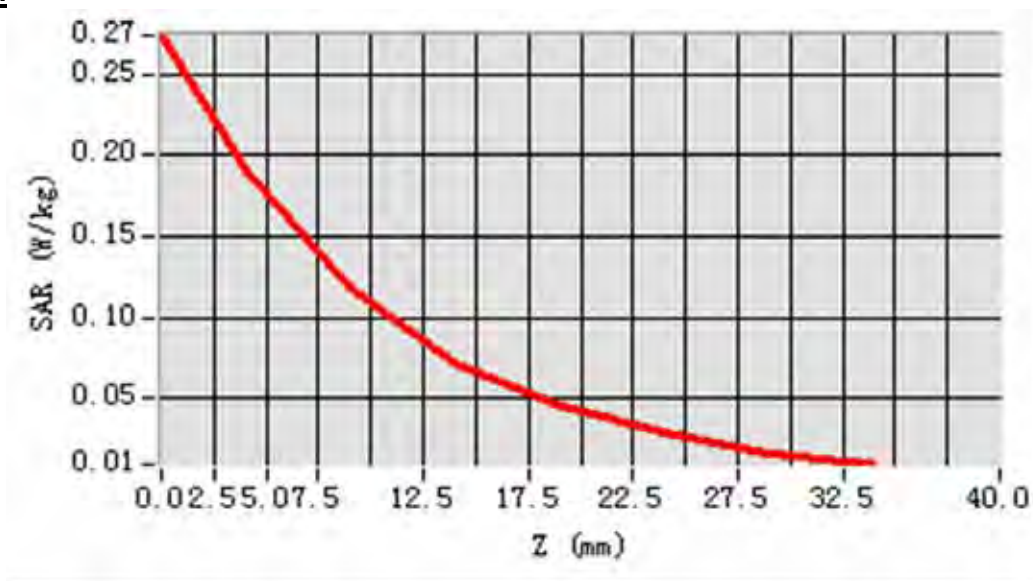

MEAS. 22 Right Head with Tilt device position on Middle Channel in GSM1900

mode

Test Date: 4/9/2014
Signal: GSM, f=1880.0 MHz, Duty Cycle: 1:8.3
Liquid Parameters: Permittivity: 41.00; Conductivity: 1.42 S/m
Test condition: Ambient Temperature: 22.6°C, Liquid Temperature: 22.0°C
Probe: EPG 210, ConvF: 26.70
Area Scan: sam_direct_droit2_surf8mm.txt, h= 5.00 mm
Zoom Scan: 5x5x7,dx=8mm, dy=8mm, dz=5mm,Complete
Maximum location: X=-16.000000, Y=0.000000
SAR 10g (W/Kg): 0.052235
SAR 1g (W/Kg): 0.090533
Power drift (%): 0.18
3D screen shot

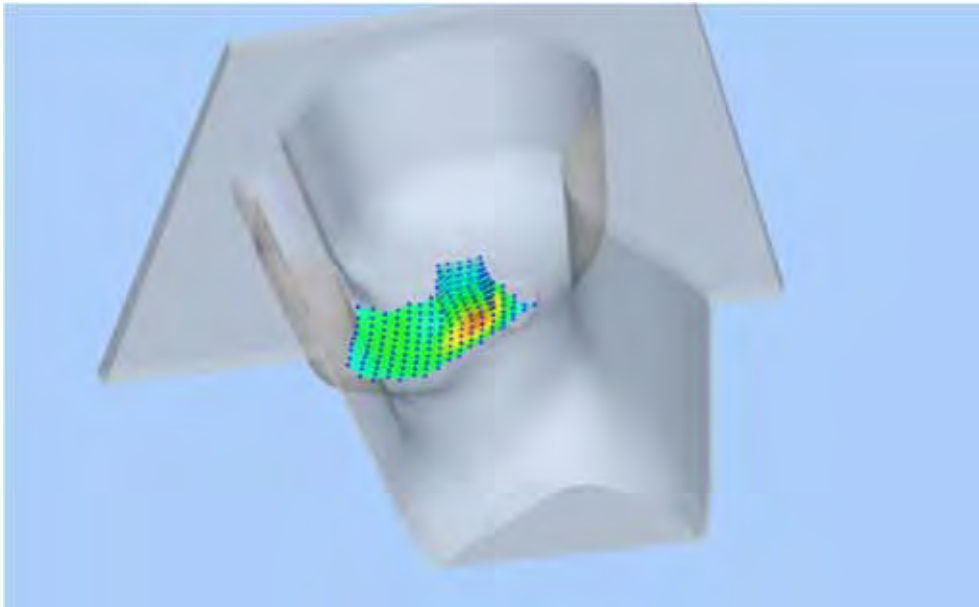

Z Axis Scan

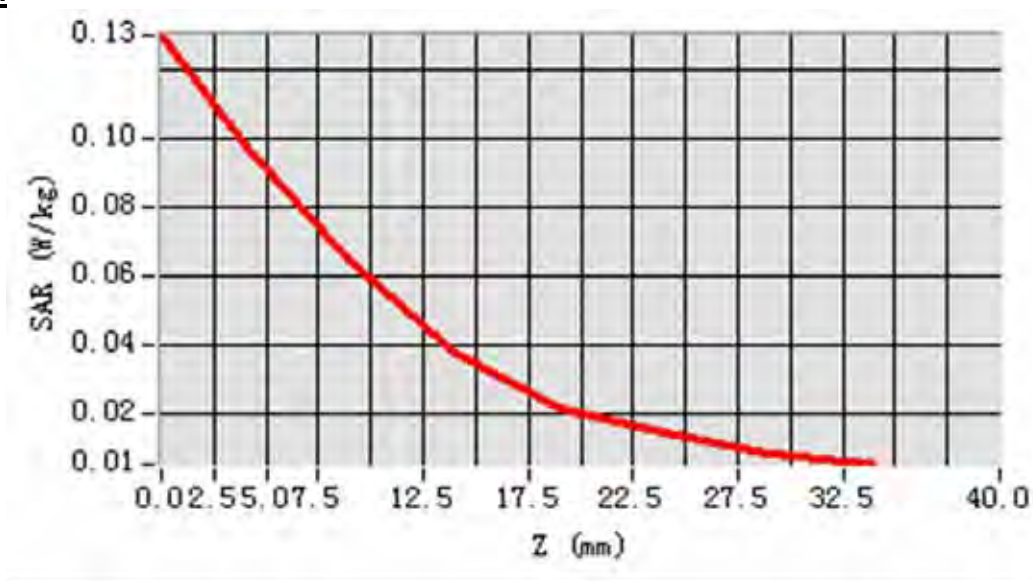

MEAS. 23 Body Plane with Body device position on Middle Channel in

GSM1900 mode

Test Date: 5/9/2014
Signal: GSM, f=1880.0 MHz, Duty Cycle: 1:8.3
Liquid Parameters: Permittivity: 54.20; Conductivity: 1.55 S/m
Test condition: Ambient Temperature: 22.6°C, Liquid Temperature: 22.0°C
Probe: EPG 210, ConvF: 27.47
Area Scan: sam_direct_droit2_surf8mm.txt, h= 5.00 mm
Zoom Scan: 5x5x7,dx=8mm, dy=8mm, dz=5mm,Complete
Maximum location: X=8.000000, Y=8.000000
SAR 10g (W/Kg): 0.115958
SAR 1g (W/Kg): 0.186681
Power drift (%): 3.57
3D screen shot

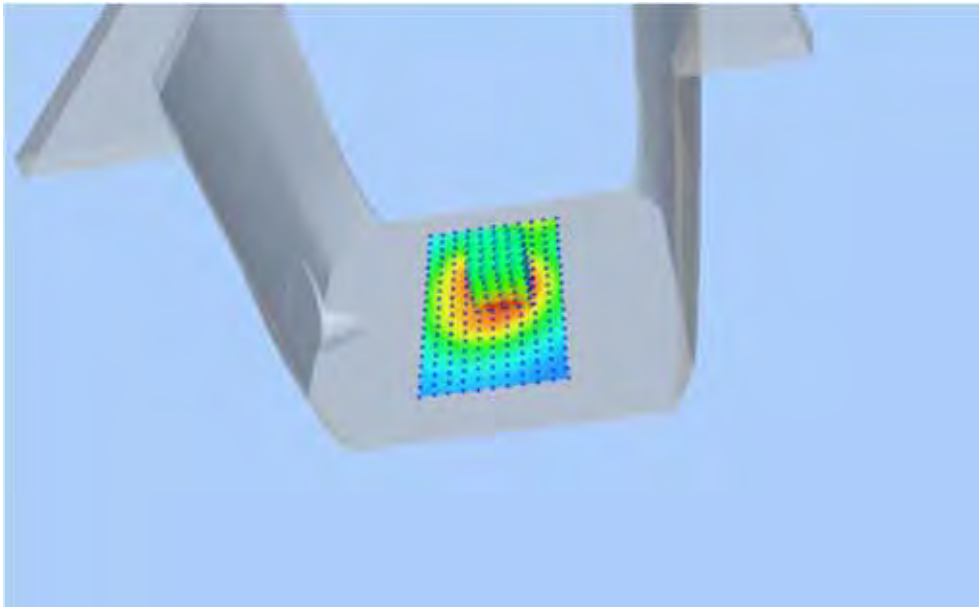

Z Axis Scan

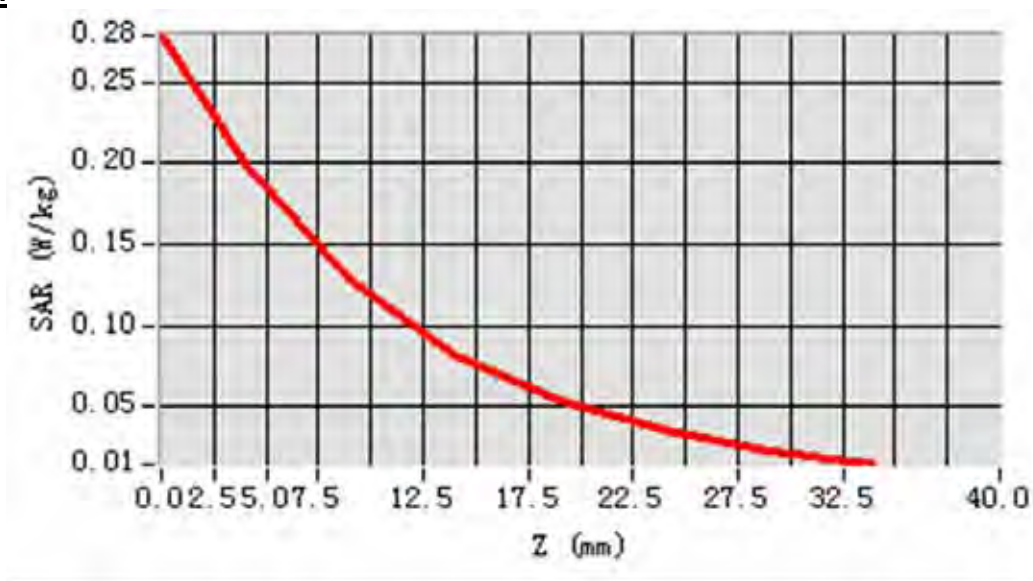

MEAS. 24 Body Plane with Body device position on Middle Channel in

GSM1900 mode

Test Date: 5/9/2014
Signal: GSM, f=1880.0 MHz, Duty Cycle: 1:8.3
Liquid Parameters: Permittivity: 54.20; Conductivity: 1.55 S/m
Test condition: Ambient Temperature: 22.6°C, Liquid Temperature: 22.0°C
Probe: EPG 210, ConvF: 27.47
Area Scan: sam_direct_droit2_surf8mm.txt, h= 5.00 mm
Zoom Scan: 5x5x7,dx=8mm, dy=8mm, dz=5mm,Complete
Maximum location: X=8.000000, Y=-16.000000
SAR 10g (W/Kg): 0.212723
SAR 1g (W/Kg): 0.367193
Power drift (%): 1.55
3D screen shot

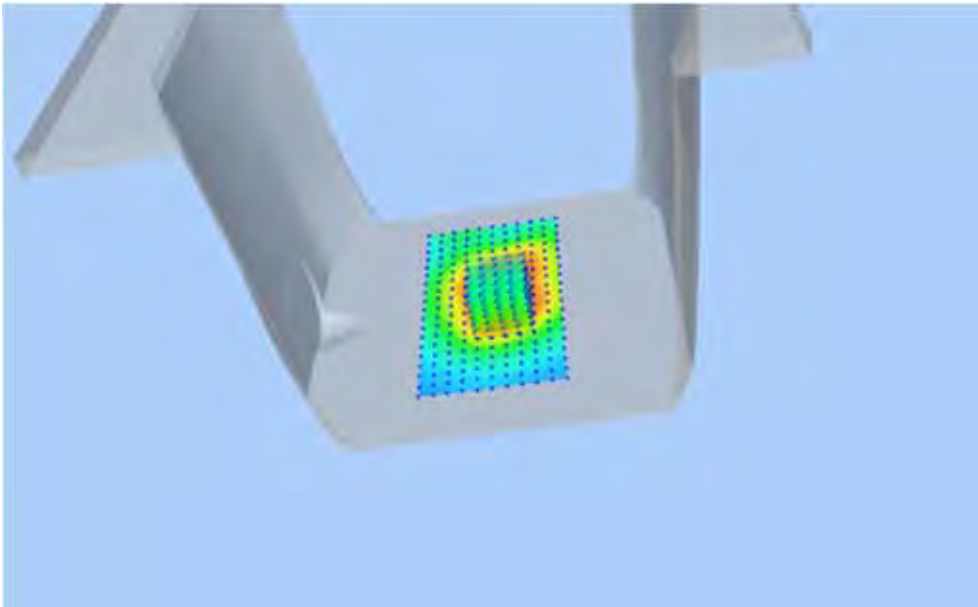

Z Axis Scan

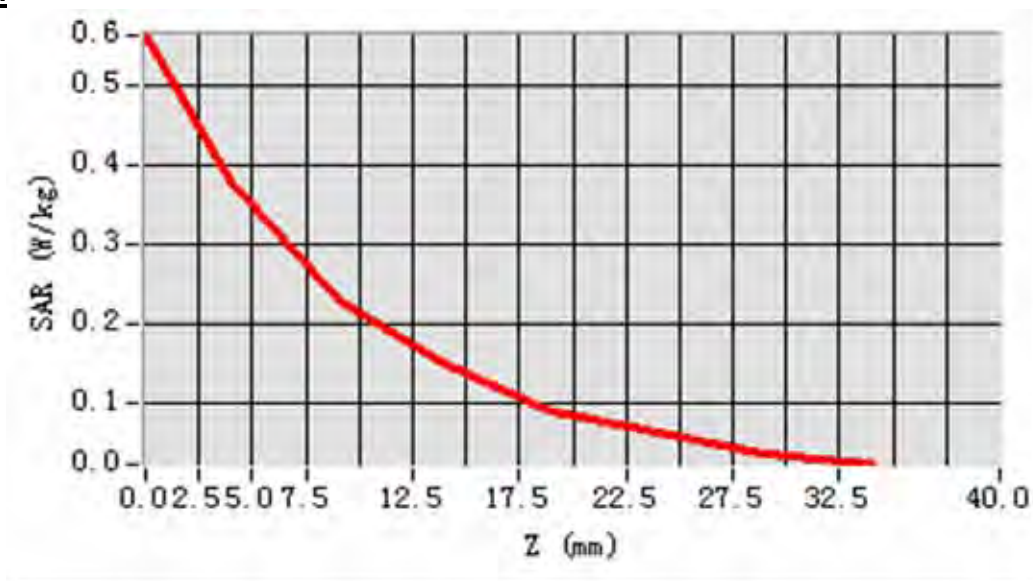

MEAS. 25 Body Plane with Body device position on Middle Channel in

GSM1900 mode

Test Date: 5/9/2014
Signal: GSM, f=1880.0 MHz, Duty Cycle: 1:8.3
Liquid Parameters: Permittivity: 54.20; Conductivity: 1.55 S/m
Test condition: Ambient Temperature: 22.6°C, Liquid Temperature: 22.0°C
Probe: EPG 210, ConvF: 27.47
Area Scan: sam_direct_droit2_surf8mm.txt, h= 5.00 mm
Zoom Scan: 5x5x7,dx=8mm, dy=8mm, dz=5mm,Complete
Maximum location: X=8.000000, Y=32.000000
SAR 10g (W/Kg): 0.061621
SAR 1g (W/Kg): 0.100296
Power drift (%): 0.60
3D screen shot

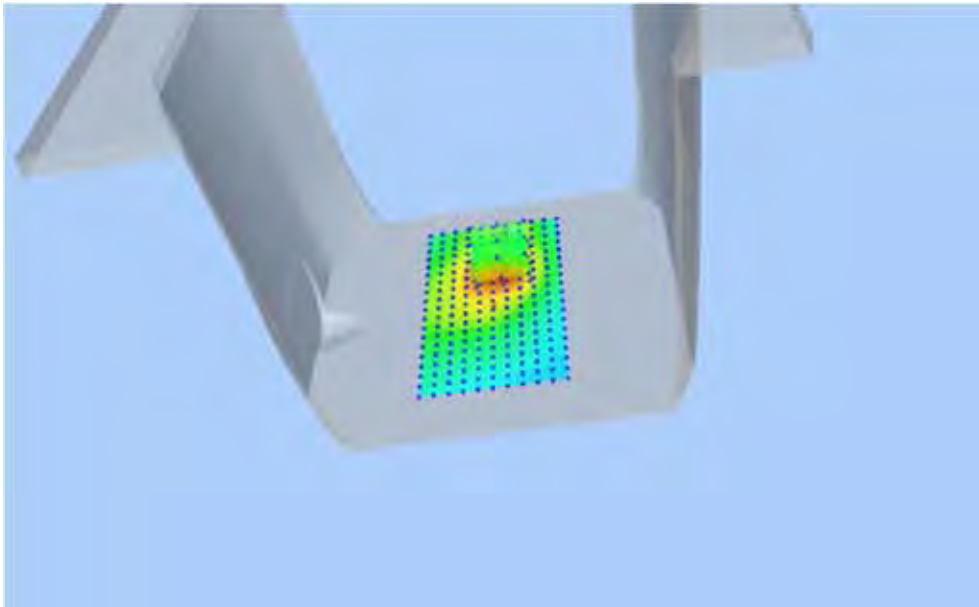

Z Axis Scan

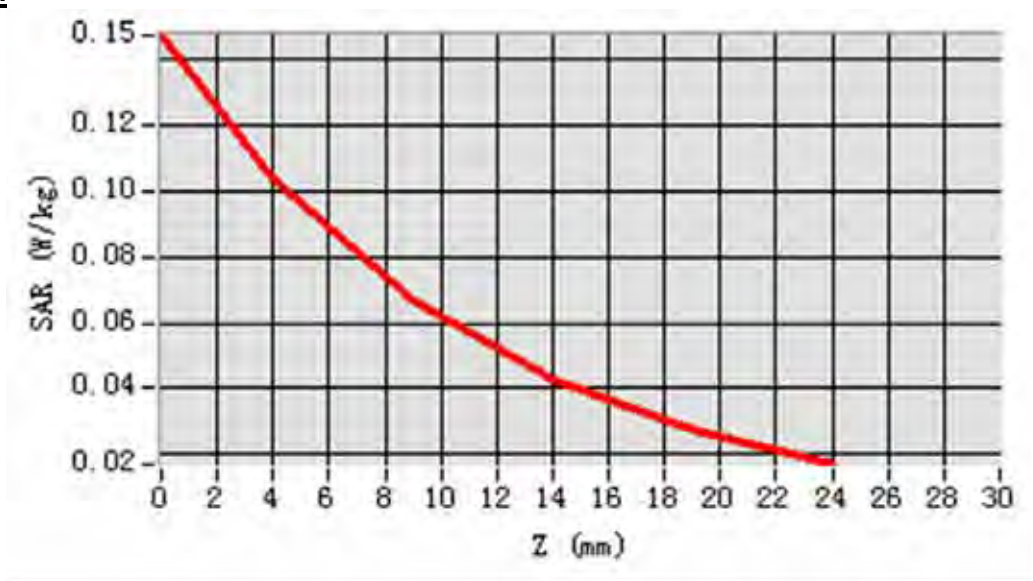

MEAS. 26 Body Plane with Body device position on Middle Channel in

GSM1900 mode

Test Date: 5/9/2014
Signal: GSM, f=1880.0 MHz, Duty Cycle: 1:8.3
Liquid Parameters: Permittivity: 54.20; Conductivity: 1.55 S/m
Test condition: Ambient Temperature: 22.6°C, Liquid Temperature: 22.0°C
Probe: EPG 210, ConvF: 27.47
Area Scan: sam_direct_droit2_surf8mm.txt, h= 5.00 mm
Zoom Scan: 5x5x7,dx=8mm, dy=8mm, dz=5mm,Complete
Maximum location: X=0.000000, Y=-24.000000
SAR 10g (W/Kg): 0.198921
SAR 1g (W/Kg): 0.340611
Power drift (%): 1.35
3D screen shot

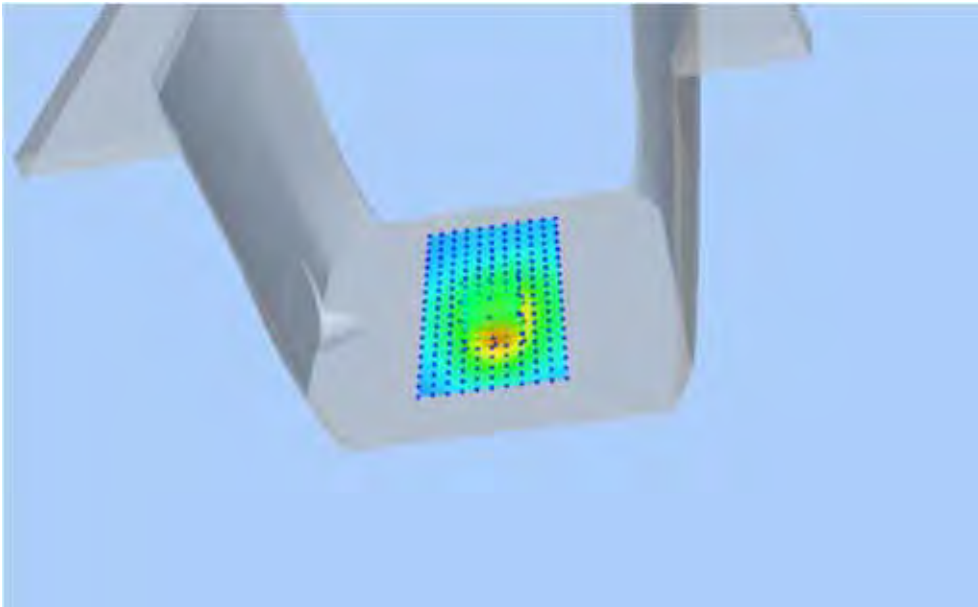

Z Axis Scan

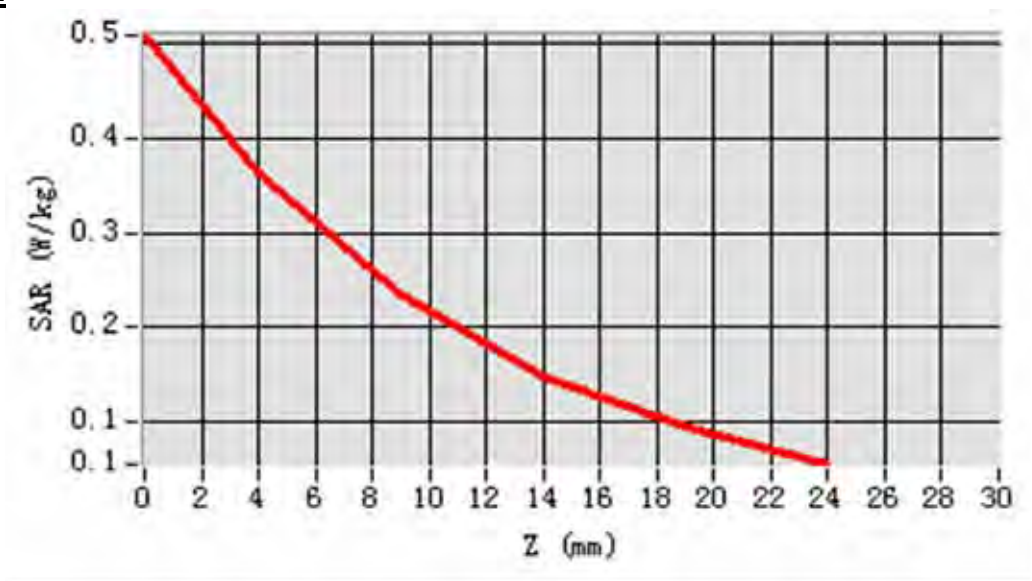

MEAS. 27 Body Plane with Body device position on Low Channel in

GPRS1900-12 mode

Test Date: 5/9/2014
Signal: GPRS, f=1850.2 MHz, Duty Cycle: 1:2.0
Liquid Parameters: Permittivity: 54.20; Conductivity: 1.42 S/m
Test condition: Ambient Temperature: 22.6°C, Liquid Temperature: 22.0°C
Probe: EPG 210, ConvF: 27.47
Area Scan: sam_direct_droit2_surf8mm.txt, h= 5.00 mm
Zoom Scan: 5x5x7,dx=8mm, dy=8mm, dz=5mm,Complete
Maximum location: X=8.000000, Y=8.000000
SAR 10g (W/Kg): 0.132871
SAR 1g (W/Kg): 0.209235
Power drift (%): -0.35
3D screen shot

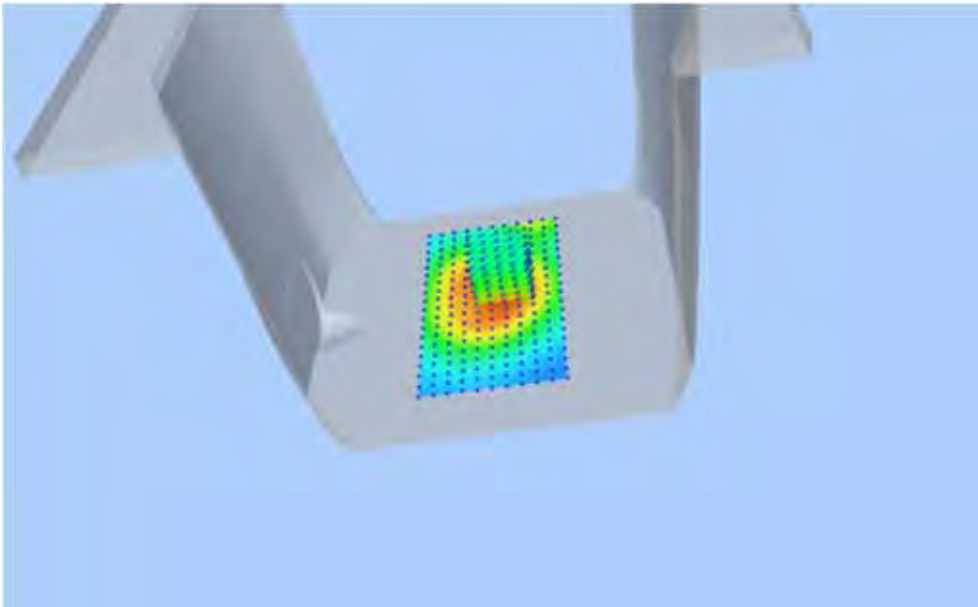

Z Axis Scan

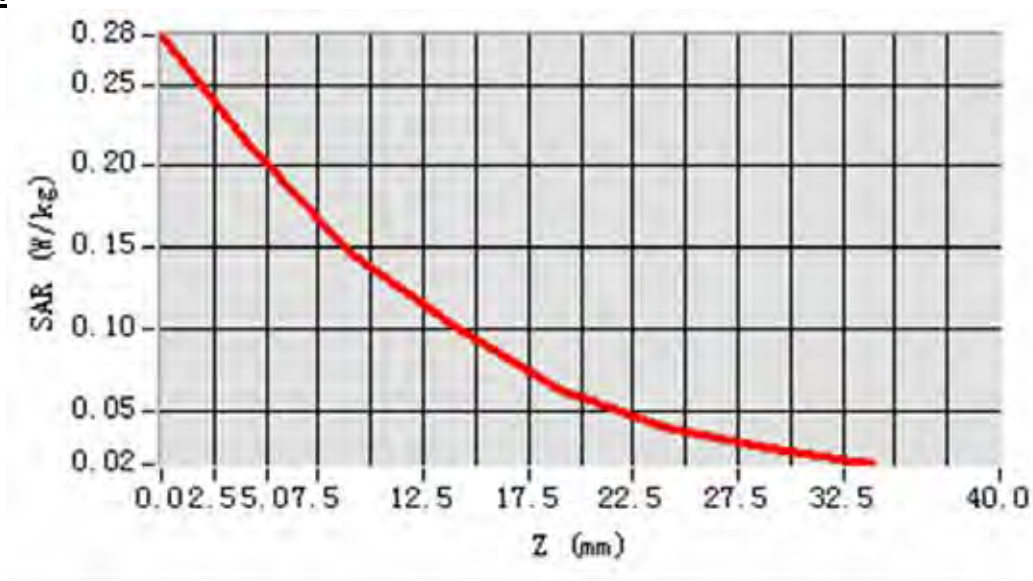

MEAS. 28 Body Plane with Body device position on Low Channel in

GPRS1900-12 mode

Test Date: 5/9/2014
Signal: GPRS, f=1850.2 MHz, Duty Cycle: 1:2.0
Liquid Parameters: Permittivity: 54.20; Conductivity: 1.42 S/m
Test condition: Ambient Temperature: 22.6°C, Liquid Temperature: 22.0°C
Probe: EPG 210, ConvF: 27.47
Area Scan: sam_direct_droit2_surf8mm.txt, h= 5.00 mm
Zoom Scan: 5x5x7,dx=8mm, dy=8mm, dz=5mm,Complete
Maximum location: X=0.000000, Y=-16.000000
SAR 10g (W/Kg): 0.232212
SAR 1g (W/Kg): 0.387596
Power drift (%): 0.31
3D screen shot

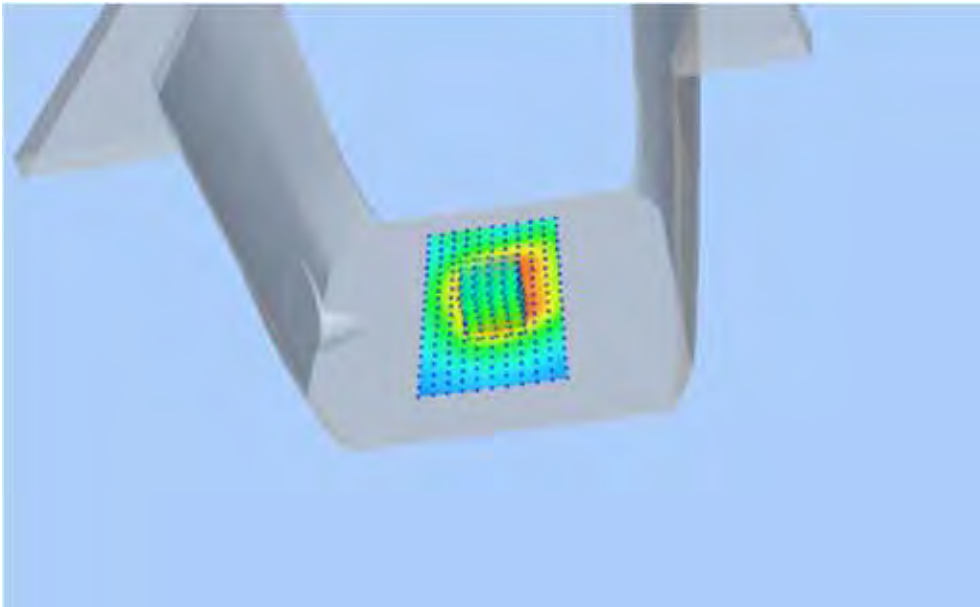

Z Axis Scan

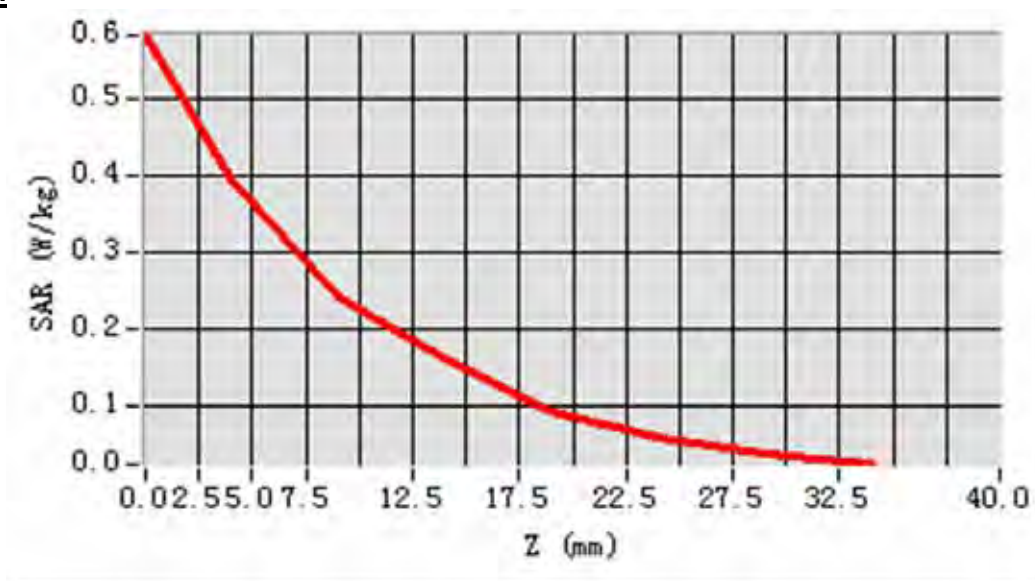

MEAS. 29 Body Plane with Body device position on Low Channel in

GPRS1900-12 mode

Test Date: 5/9/2014
Signal: GPRS, f=1850.2 MHz, Duty Cycle: 1:2.0
Liquid Parameters: Permittivity: 54.20; Conductivity: 1.42 S/m
Test condition: Ambient Temperature: 22.6°C, Liquid Temperature: 22.0°C
Probe: EPG 210, ConvF: 27.47
Area Scan: sam_direct_droit2_surf8mm.txt, h= 5.00 mm
Zoom Scan: 5x5x7,dx=8mm, dy=8mm, dz=5mm,Complete
Maximum location: X=8.000000, Y=24.000000
SAR 10g (W/Kg): 0.071756
SAR 1g (W/Kg): 0.125787
Power drift (%): -1.23
3D screen shot

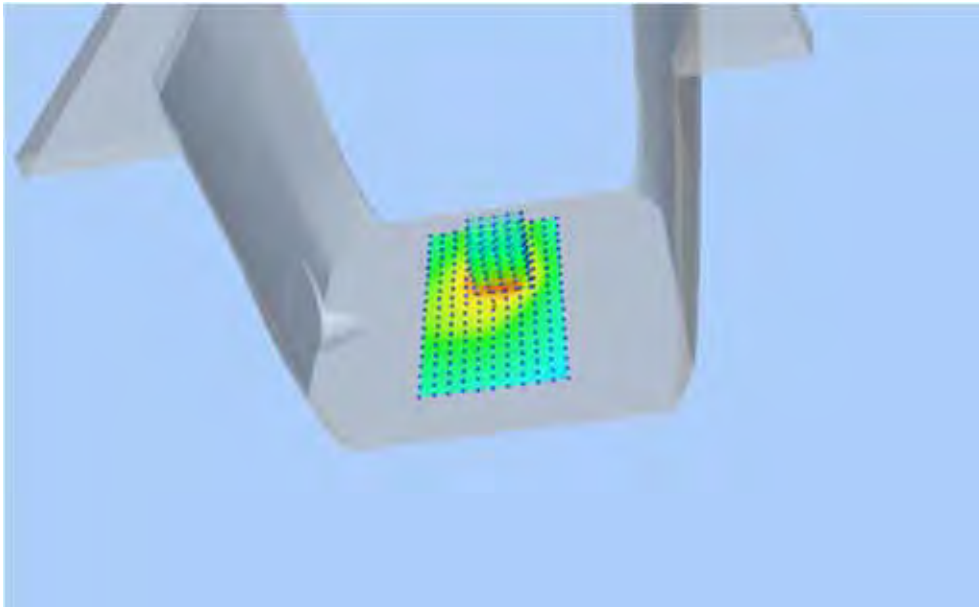

Z Axis Scan

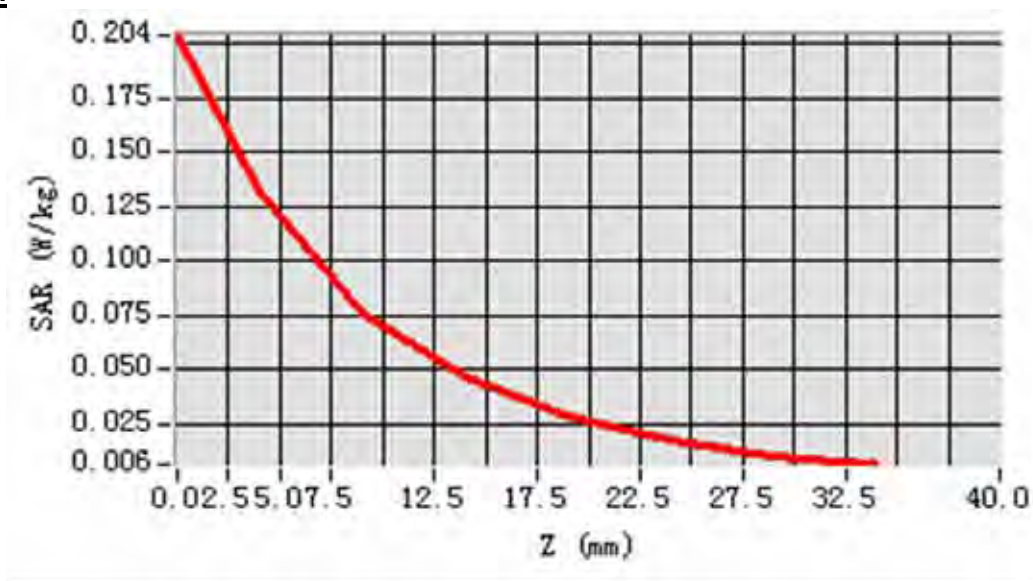

MEAS. 30 Body Plane with Body device position on Low Channel in

GPRS1900-12 mode

Test Date: 5/9/2014
Signal: GPRS, f=1850.2 MHz, Duty Cycle: 1:2.0
Liquid Parameters: Permittivity: 54.20; Conductivity: 1.42 S/m
Test condition: Ambient Temperature: 22.6°C, Liquid Temperature: 22.0°C
Probe: EPG 210, ConvF: 27.47
Area Scan: sam_direct_droit2_surf8mm.txt, h= 5.00 mm
Zoom Scan: 5x5x7,dx=8mm, dy=8mm, dz=5mm,Complete
Maximum location: X=0.000000, Y=0.000000
SAR 10g (W/Kg): 0.187853
SAR 1g (W/Kg): 0.336915
Power drift (%): 0.71
3D screen shot

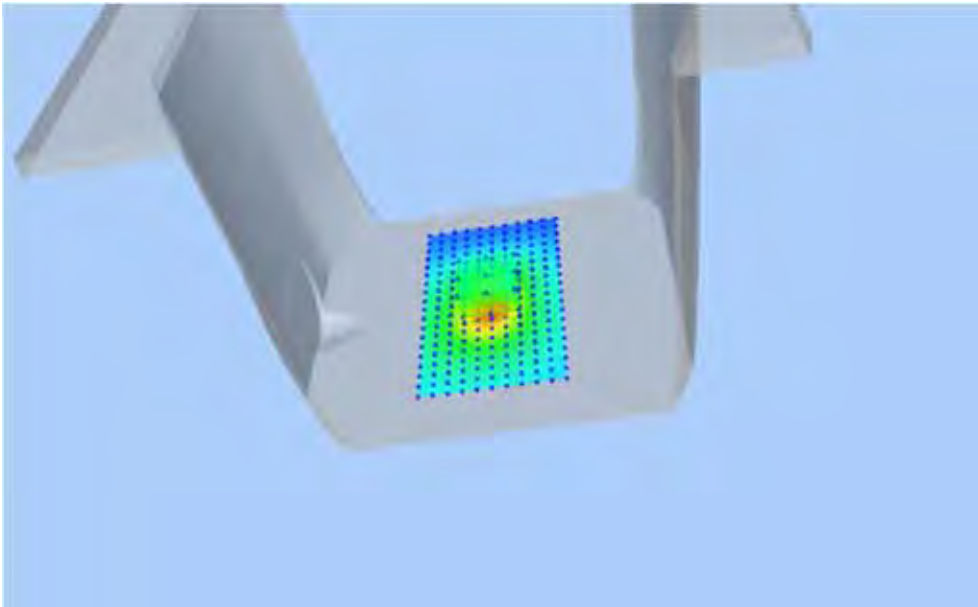

Z Axis Scan

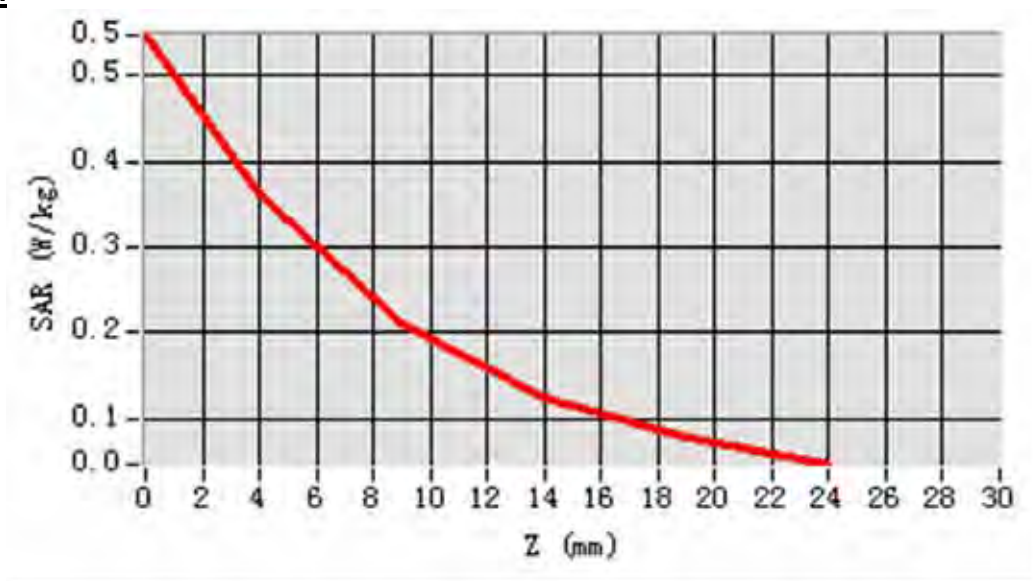

MEAS. 31 Left Head with Cheek device position on Middle Channel in

WCDMA850 mode

Test Date: 4/9/2014
Signal: WCDMA, f=836.4 MHz, Duty Cycle: 1:1.0
Liquid Parameters: Permittivity: 40.40; Conductivity: 0.92 S/m
Test condition: Ambient Temperature: 22.6°C, Liquid Temperature: 22.0°C
Probe: EPG 210, ConvF: 23.67
Area Scan: sam_direct_droit2_surf8mm.txt, h= 5.00 mm
Zoom Scan: 5x5x7,dx=8mm, dy=8mm, dz=5mm,Complete
Maximum location: X=-24.000000, Y=-8.000000
SAR 10g (W/Kg): 0.353542
SAR 1g (W/Kg): 0.505914
Power drift (%): -0.33
3D screen shot

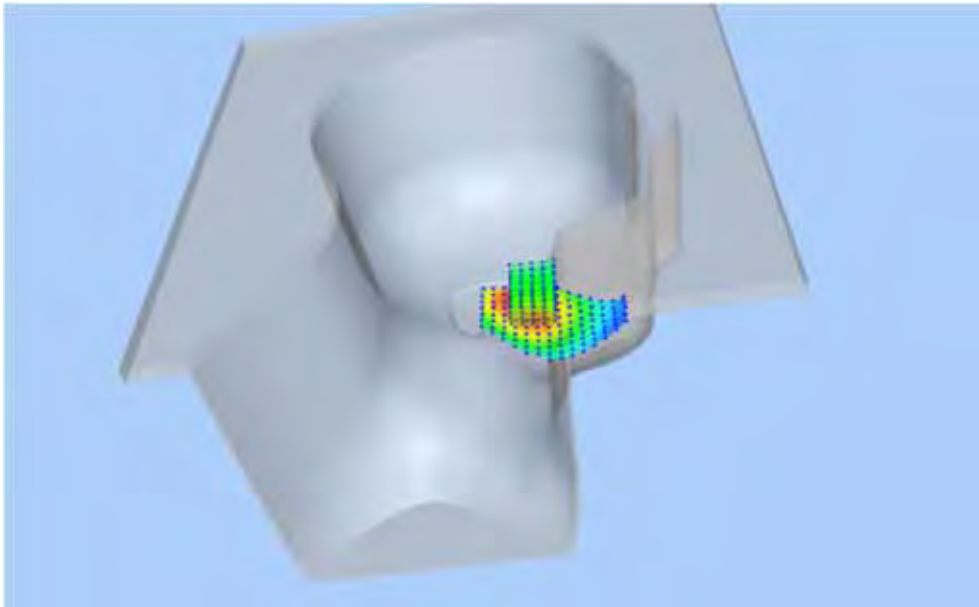

Z Axis Scan

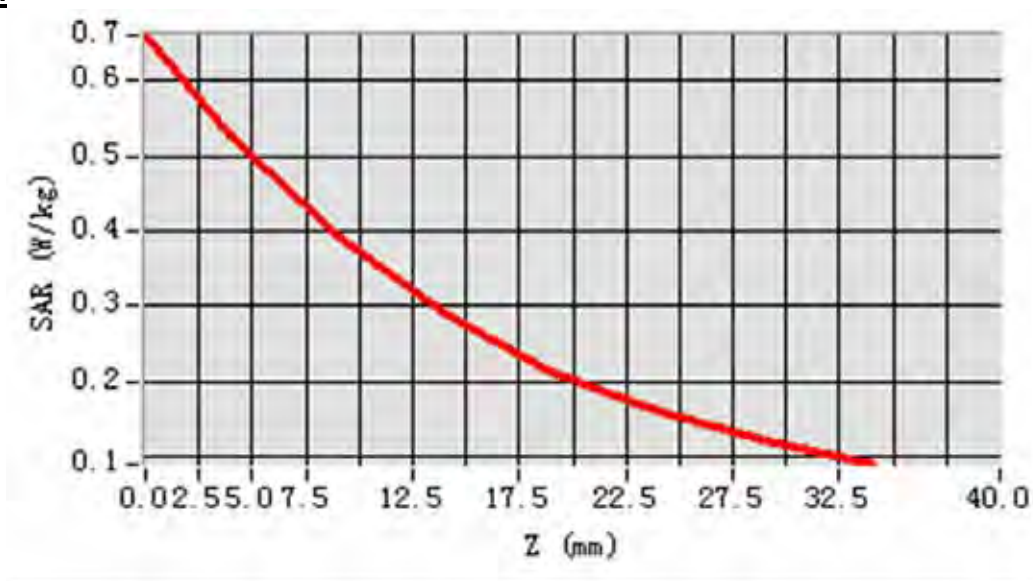

MEAS. 32 Left Head with Tilt device position on Middle Channel in

WCDMA850 mode

Test Date: 4/9/2014
Signal: WCDMA, f=836.4 MHz, Duty Cycle: 1:1.0
Liquid Parameters: Permittivity: 40.40; Conductivity: 0.92 S/m
Test condition: Ambient Temperature: 22.6°C, Liquid Temperature: 22.0°C
Probe: EPG 210, ConvF: 23.67
Area Scan: sam_direct_droit2_surf8mm.txt, h= 5.00 mm
Zoom Scan: 5x5x7,dx=8mm, dy=8mm, dz=5mm,Complete
Maximum location: X=-8.000000, Y=8.000000
SAR 10g (W/Kg): 0.169798
SAR 1g (W/Kg): 0.251107
Power drift (%): -0.53
3D screen shot

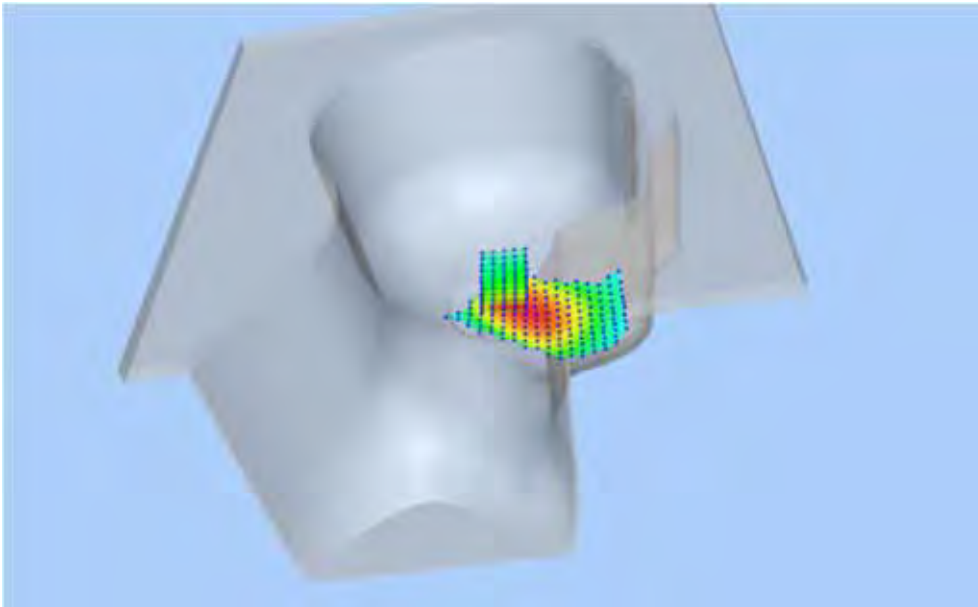

Z Axis Scan

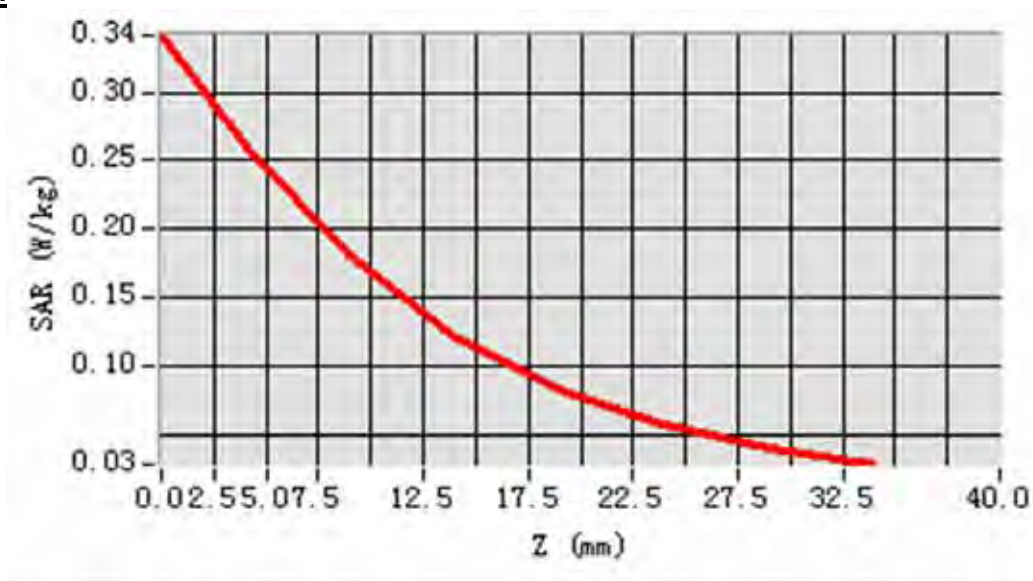

MEAS. 33 Right Head with Cheek device position on Middle Channel in

WCDMA850 mode

Test Date: 4/9/2014
Signal: WCDMA, f=836.4 MHz, Duty Cycle: 1:1.0
Liquid Parameters: Permittivity: 40.40; Conductivity: 0.92 S/m
Test condition: Ambient Temperature: 22.6°C, Liquid Temperature: 22.0°C
Probe: EPG 210, ConvF: 23.67
Area Scan: sam_direct_droit2_surf8mm.txt, h= 5.00 mm
Zoom Scan: 5x5x7,dx=8mm, dy=8mm, dz=5mm,Complete
Maximum location: X=-32.000000, Y=-8.000000
SAR 10g (W/Kg): 0.373676
SAR 1g (W/Kg): 0.529740
Power drift (%): -1.85
3D screen shot

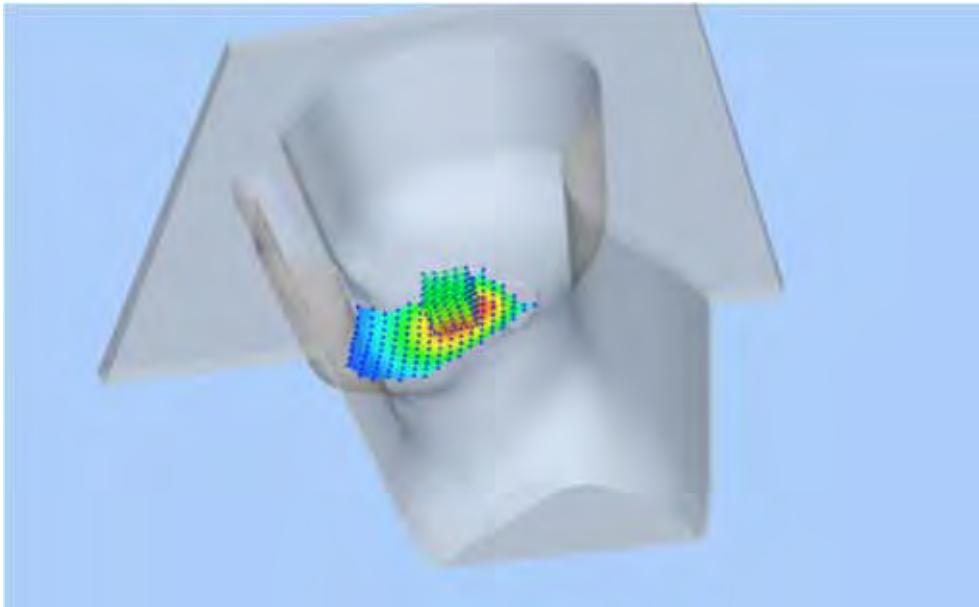

Z Axis Scan

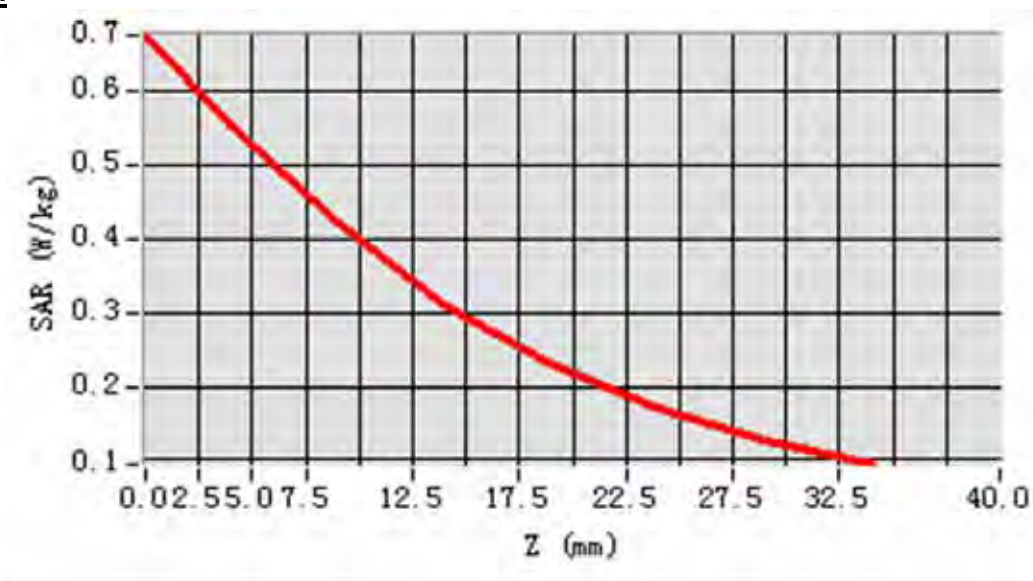

MEAS. 34 Right Head with Tilt device position on Middle Channel in

WCDMA850 mode

Test Date: 4/9/2014
Signal: WCDMA, f=836.4 MHz, Duty Cycle: 1:1.0
Liquid Parameters: Permittivity: 40.40; Conductivity: 0.92 S/m
Test condition: Ambient Temperature: 22.6°C, Liquid Temperature: 22.0°C
Probe: EPG 210, ConvF: 23.67
Area Scan: sam_direct_droit2_surf8mm.txt, h= 5.00 mm
Zoom Scan: 5x5x7,dx=8mm, dy=8mm, dz=5mm,Complete
Maximum location: X=-8.000000, Y=0.000000
SAR 10g (W/Kg): 0.179155
SAR 1g (W/Kg): 0.258696
Power drift (%): -0.72
3D screen shot

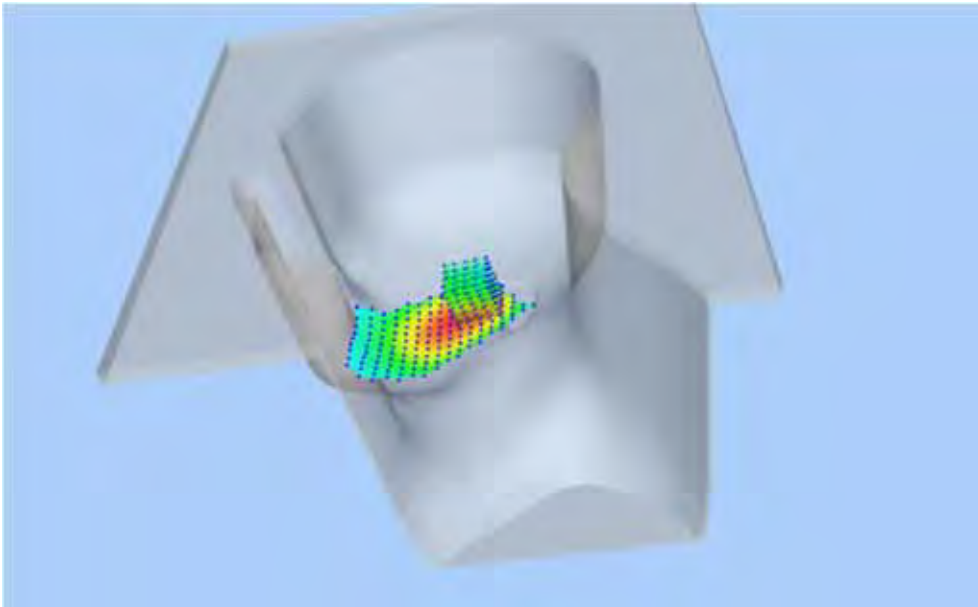

Z Axis Scan

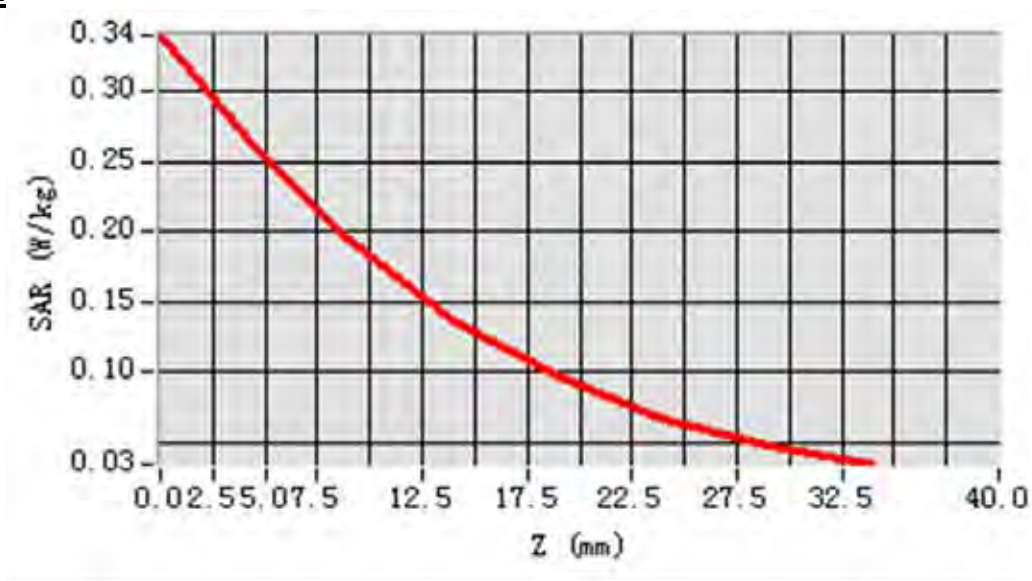

MEAS. 35 Body Plane with Body device position on Middle Channel in

WCDMA850 mode

Test Date: 5/9/2014
Signal: WCDMA, f=836.4 MHz, Duty Cycle: 1:1.0
Liquid Parameters: Permittivity: 55.26; Conductivity: 0.99 S/m
Test condition: Ambient Temperature: 22.6°C, Liquid Temperature: 22.0°C
Probe: EPG 210, ConvF: 24.58
Area Scan: sam_direct_droit2_surf8mm.txt, h= 5.00 mm
Zoom Scan: 5x5x7,dx=8mm, dy=8mm, dz=5mm,Complete
Maximum location: X=0.000000, Y=32.000000
SAR 10g (W/Kg): 0.265915
SAR 1g (W/Kg): 0.362446
Power drift (%): -0.40
3D screen shot

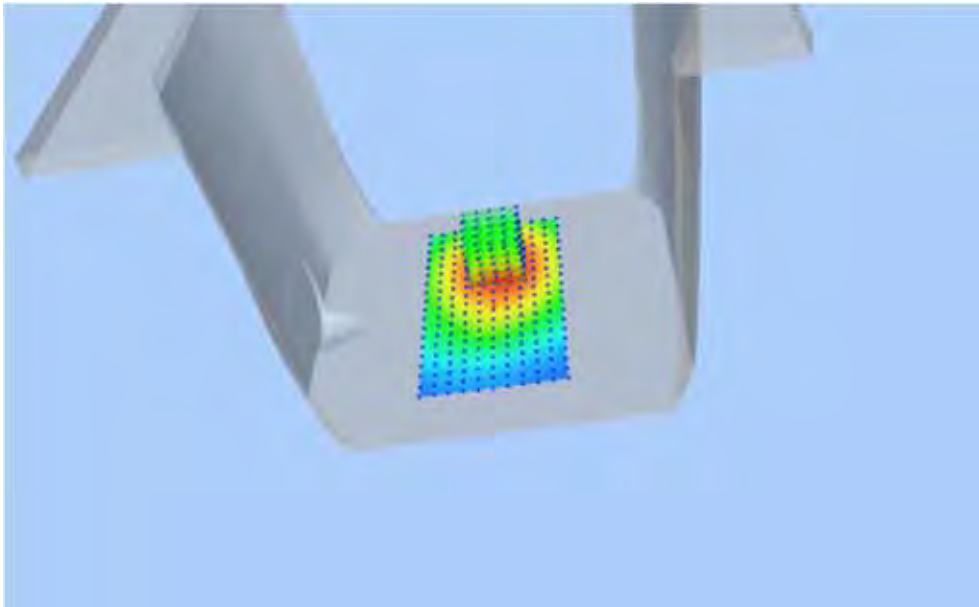

Z Axis Scan

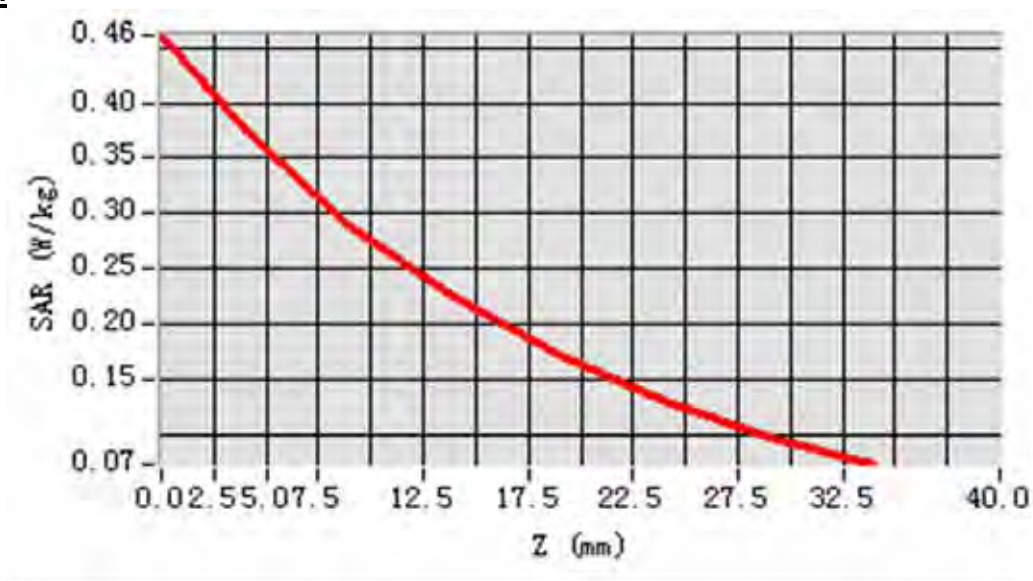

MEAS. 36 Body Plane with Body device position on Middle Channel in

WCDMA850 mode

Test Date: 5/9/2014
Signal: WCDMA, f=836.4 MHz, Duty Cycle: 1:1.0
Liquid Parameters: Permittivity: 55.26; Conductivity: 0.99 S/m
Test condition: Ambient Temperature: 22.6°C, Liquid Temperature: 22.0°C
Probe: EPG 210, ConvF: 24.58
Area Scan: sam_direct_droit2_surf8mm.txt, h= 5.00 mm
Zoom Scan: 5x5x7,dx=8mm, dy=8mm, dz=5mm,Complete
Maximum location: X=0.000000, Y=32.000000
SAR 10g (W/Kg): 0.380901
SAR 1g (W/Kg): 0.519363
Power drift (%): -2.00
3D screen shot

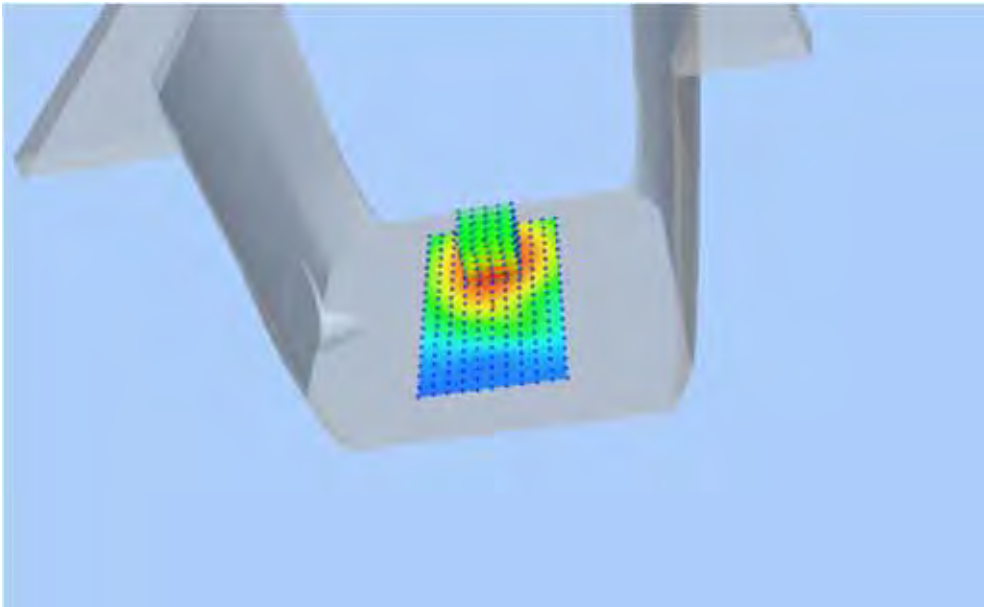

Z Axis Scan

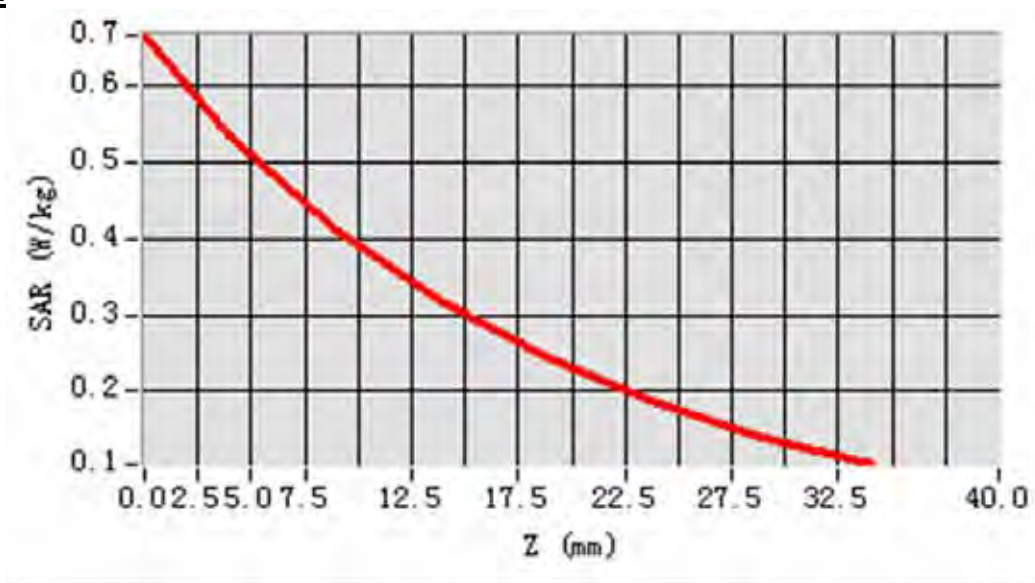

MEAS. 37 Body Plane with Body device position on Middle Channel in

WCDMA850 mode

Test Date: 5/9/2014
Signal: WCDMA, f=836.4 MHz, Duty Cycle: 1:1.0
Liquid Parameters: Permittivity: 55.26; Conductivity: 0.99 S/m
Test condition: Ambient Temperature: 22.6°C, Liquid Temperature: 22.0°C
Probe: EPG 210, ConvF: 24.58
Area Scan: sam_direct_droit2_surf8mm.txt, h= 5.00 mm
Zoom Scan: 5x5x7,dx=8mm, dy=8mm, dz=5mm,Complete
Maximum location: X=0.000000, Y=56.000000
SAR 10g (W/Kg): 0.094756
SAR 1g (W/Kg): 0.136113
Power drift (%): -0.53
3D screen shot

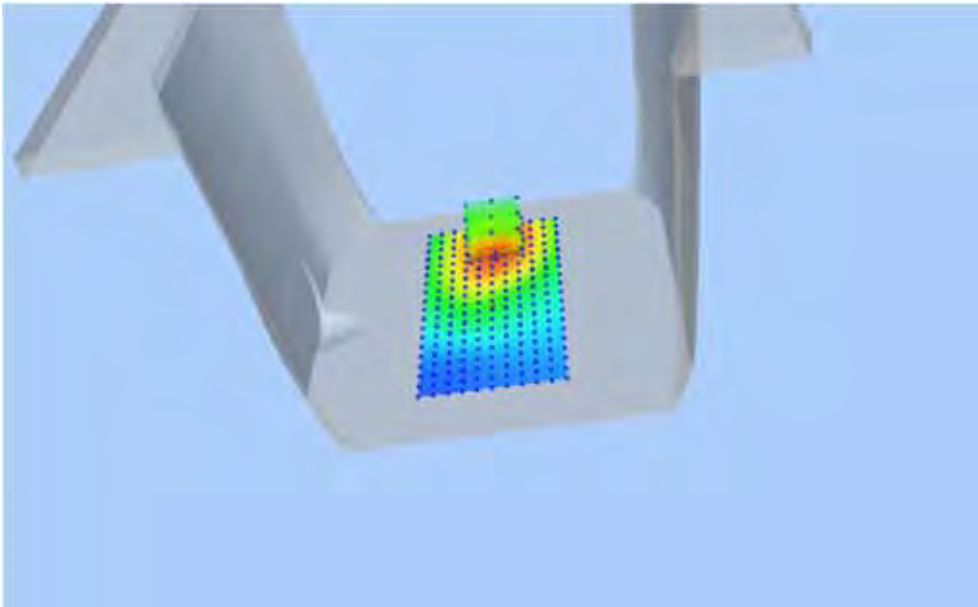

Z Axis Scan

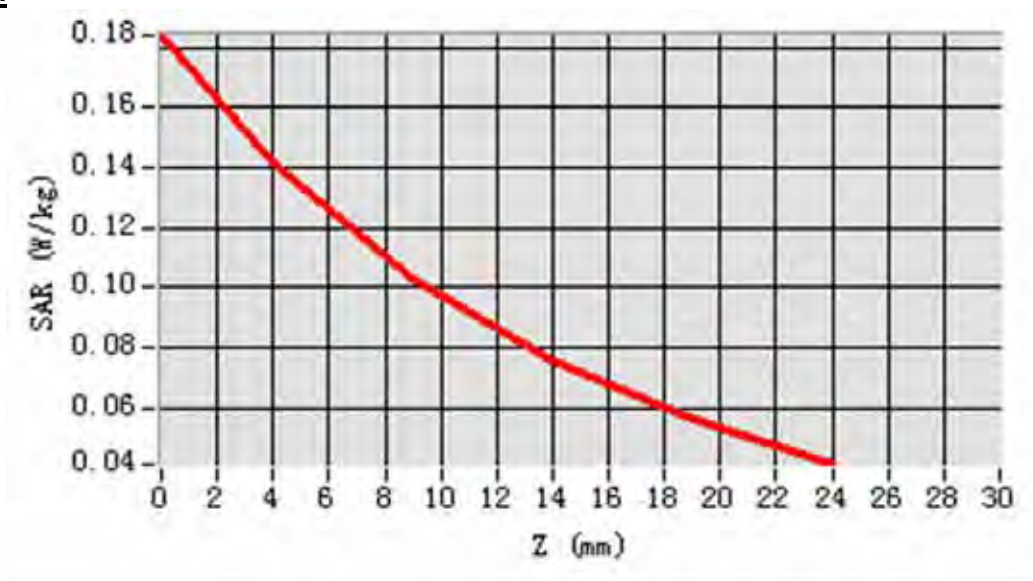

MEAS. 38 Body Plane with Body device position on Middle Channel in

WCDMA850 mode

Test Date: 5/9/2014
Signal: WCDMA, f=836.4 MHz, Duty Cycle: 1:1.0
Liquid Parameters: Permittivity: 55.26; Conductivity: 0.99 S/m
Test condition: Ambient Temperature: 22.6°C, Liquid Temperature: 22.0°C
Probe: EPG 210, ConvF: 24.58
Area Scan: sam_direct_droit2_surf8mm.txt, h= 5.00 mm
Zoom Scan: 5x5x7,dx=8mm, dy=8mm, dz=5mm,Complete
Maximum location: X=-16.000000, Y=-8.000000
SAR 10g (W/Kg): 0.017826
SAR 1g (W/Kg): 0.027109
Power drift (%): -0.81
3D screen shot

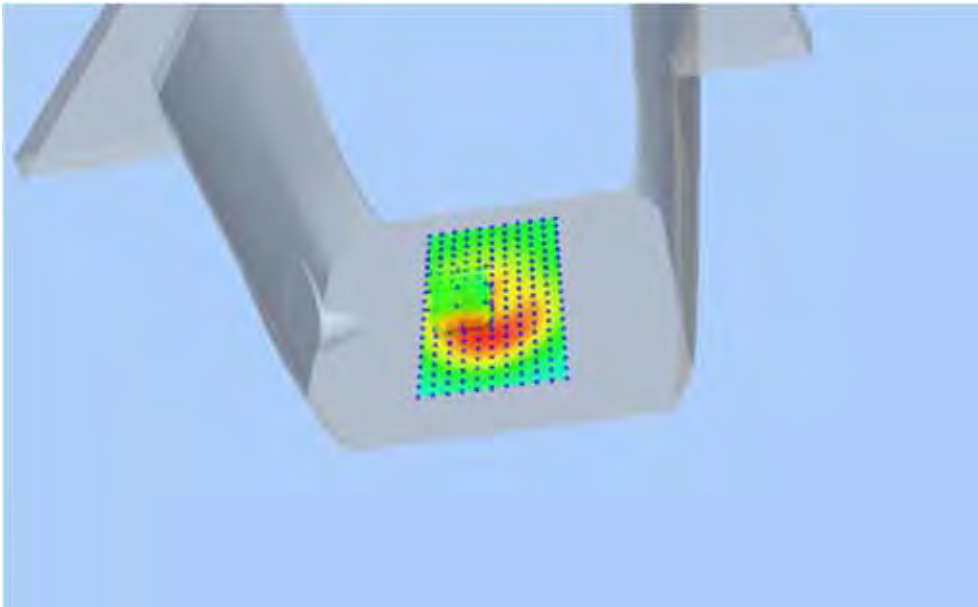

Z Axis Scan

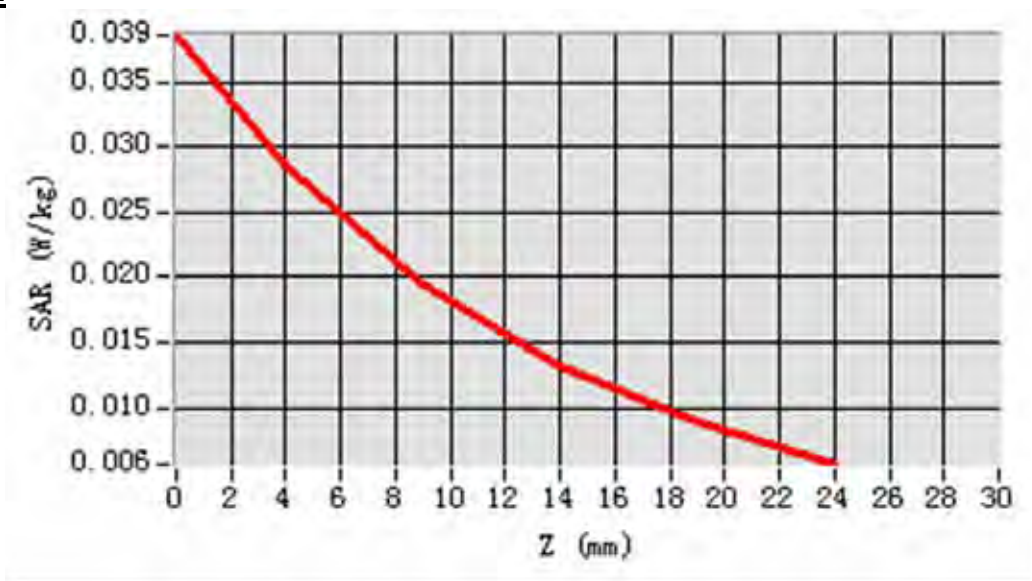

MEAS. 39 Left Head with Cheek device position on Middle Channel in

WCDMA1700 mode

Test Date: 4/9/2014
Signal: WCDMA, f=1732.0 MHz, Duty Cycle: 1:1.0
Liquid Parameters: Permittivity: 41.00; Conductivity: 1.42 S/m
Test condition: Ambient Temperature: 22.6°C, Liquid Temperature: 22.0°C
Probe: EPG 210, ConvF: 26.70
Area Scan: sam_direct_droit2_surf8mm.txt, h= 5.00 mm
Zoom Scan: 5x5x7,dx=8mm, dy=8mm, dz=5mm,Complete
Maximum location: X=-64.000000, Y=-32.000000
SAR 10g (W/Kg): 0.023176
SAR 1g (W/Kg): 0.036818
Power drift (%): -1.21
3D screen shot

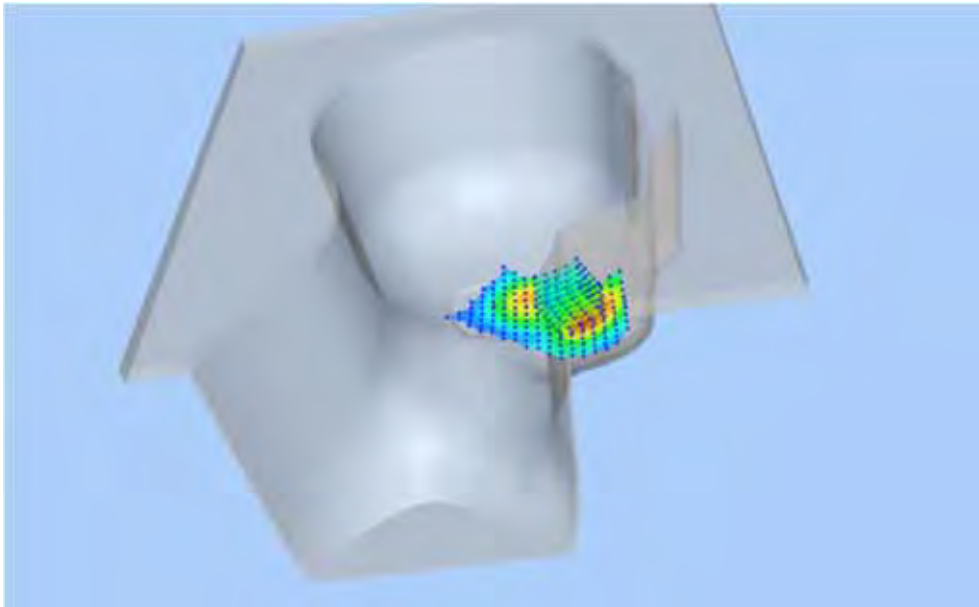

Z Axis Scan

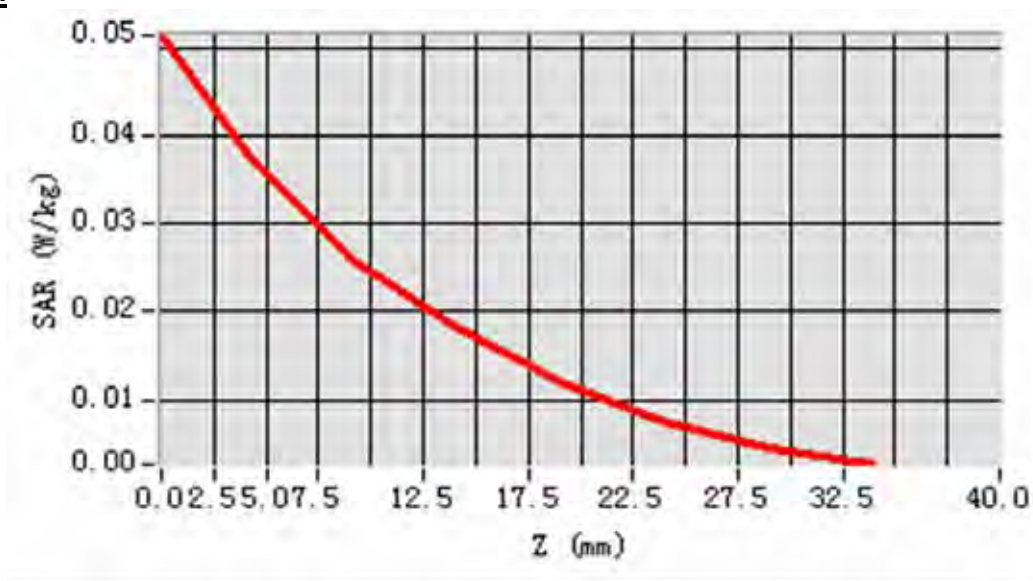

MEAS. 40 Left Head with Tilt device position on Middle Channel in

WCDMA1700 mode

Test Date:	4/9/2014
Signal:	WCDMA, f=1732.0 MHz, Duty Cycle: 1:1.0
Liquid Parameters:	Permittivity: 41.00; Conductivity: 1.42 S/m
Test condition:	Ambient Temperature: 22.6°C, Liquid Temperature: 22.0°C
Probe:	EPG 210, ConvF: 26.70
Area Scan:	sam_direct_droit2_surf8mm.txt, h= 5.00 mm
Zoom Scan:	5x5x7,dx=8mm, dy=8mm, dz=5mm,Complete
Maximum location:	X=-16.000000, Y=0.000000
SAR 10g (W/Kg):	0.013374
SAR 1g (W/Kg):	0.023027
Power drift (%):	-1.27
3D screen shot	

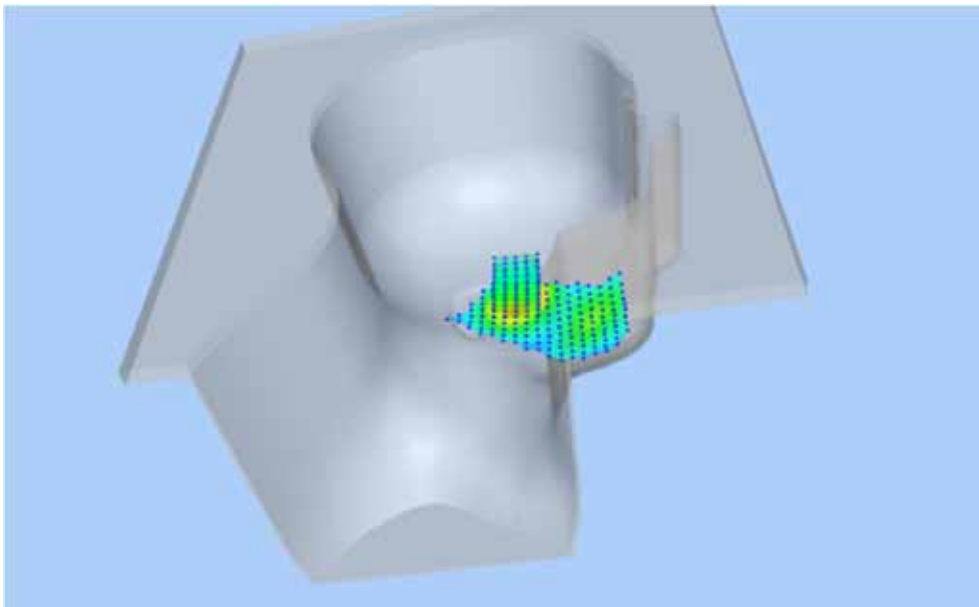

Z Axis Scan

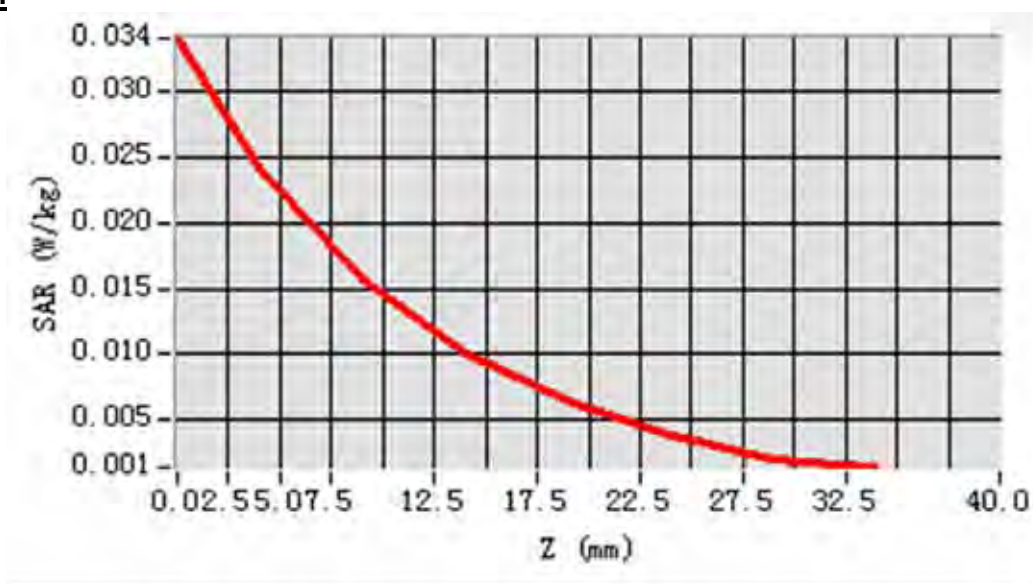

MEAS. 41 Right Head with Cheek device position on Middle Channel in

WCDMA1700 mode

Test Date: 4/9/2014
Signal: WCDMA, f=1732.0 MHz, Duty Cycle: 1:1.0
Liquid Parameters: Permittivity: 41.00; Conductivity: 1.42 S/m
Test condition: Ambient Temperature: 22.6°C, Liquid Temperature: 22.0°C
Probe: EPG 210, ConvF: 26.70
Area Scan: sam_direct_droit2_surf8mm.txt, h= 5.00 mm
Zoom Scan: 5x5x7,dx=8mm, dy=8mm, dz=5mm,Complete
Maximum location: X=-56.000000, Y=-48.000000
SAR 10g (W/Kg): 0.039568
SAR 1g (W/Kg): 0.067008
Power drift (%): -1.63
3D screen shot

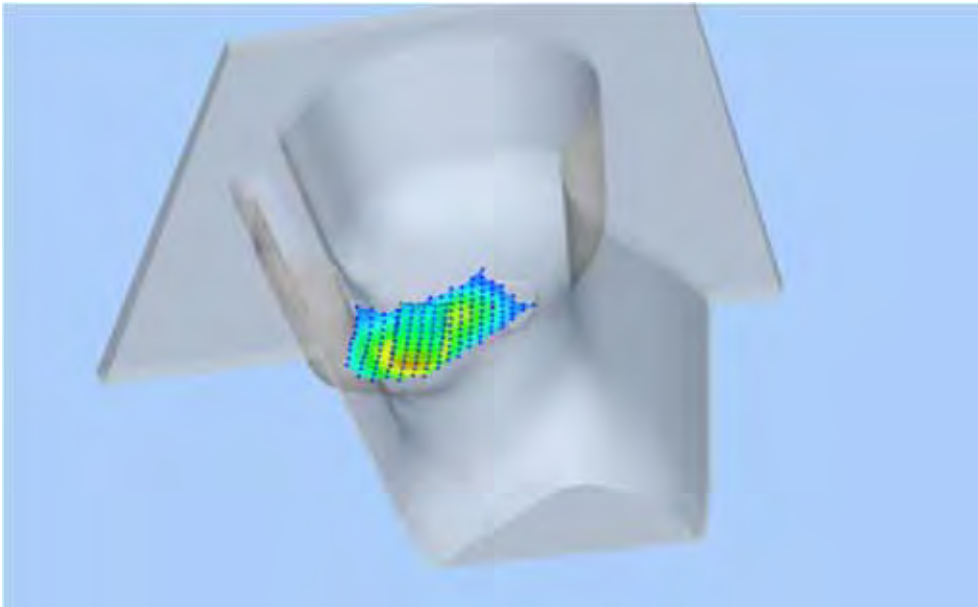

Z Axis Scan

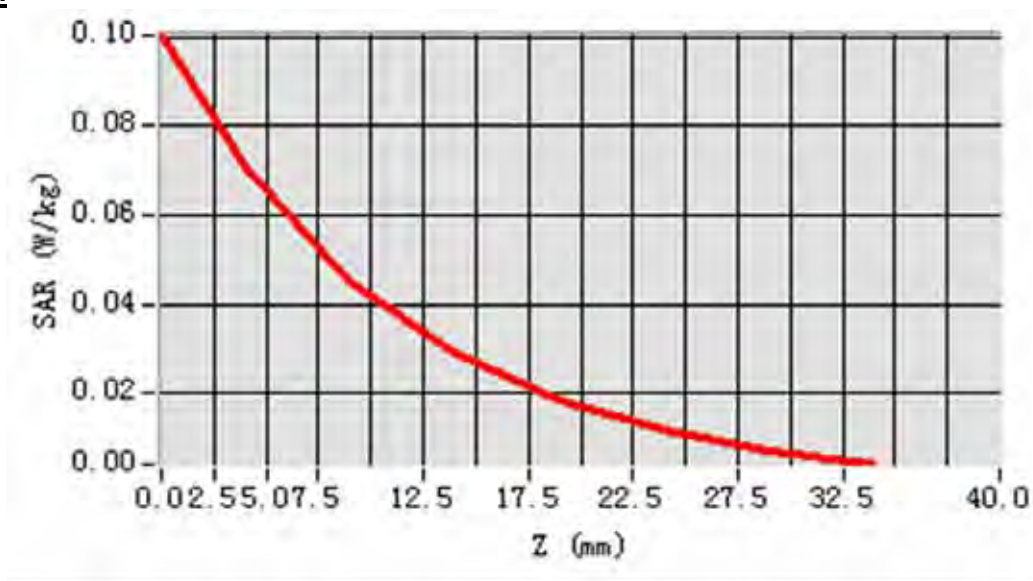

MEAS. 42 Right Head with Tilt device position on Middle Channel in

WCDMA1700 mode

Test Date: 4/9/2014
Signal: WCDMA, f=1732.0 MHz, Duty Cycle: 1:1.0
Liquid Parameters: Permittivity: 41.00; Conductivity: 1.42 S/m
Test condition: Ambient Temperature: 22.6°C, Liquid Temperature: 22.0°C
Probe: EPG 210, ConvF: 26.70
Area Scan: sam_direct_droit2_surf8mm.txt, h= 5.00 mm
Zoom Scan: 5x5x7,dx=8mm, dy=8mm, dz=5mm,Complete
Maximum location: X=-16.000000, Y=-8.000000
SAR 10g (W/Kg): 0.012005
SAR 1g (W/Kg): 0.020365
Power drift (%): -0.91
3D screen shot

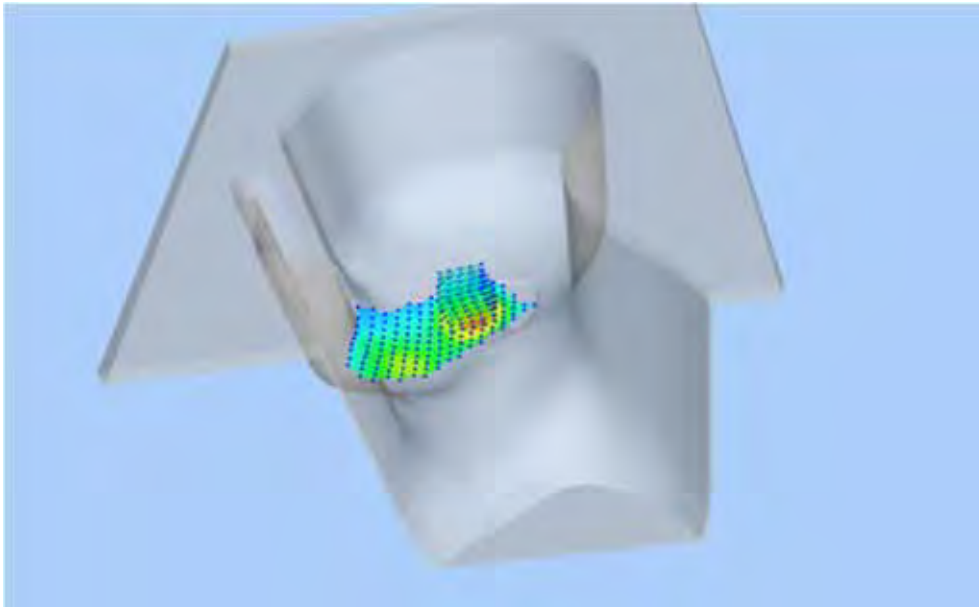

Z Axis Scan

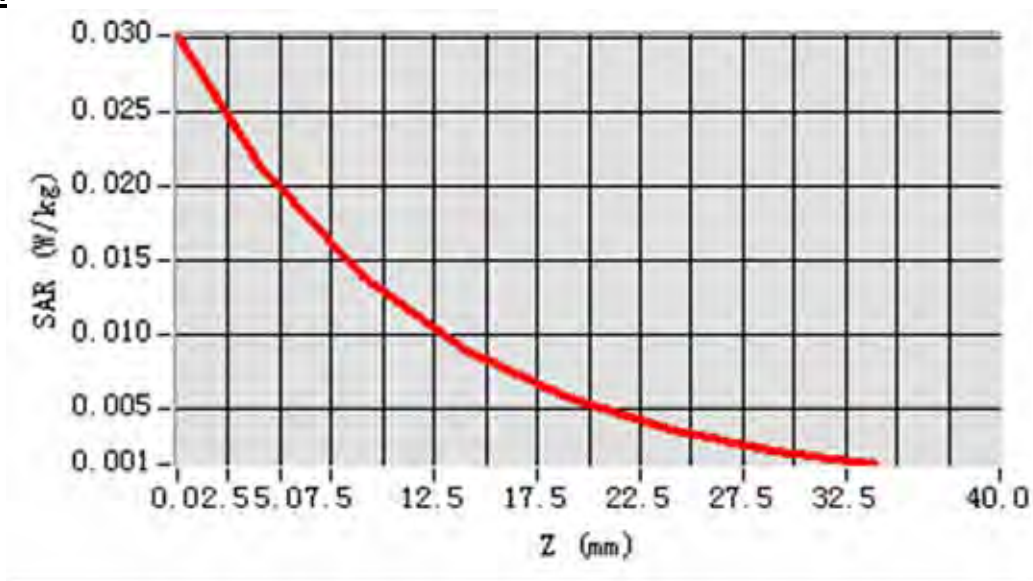

MEAS. 43 Body Plane with Body device position on Middle Channel in

WCDMA1700 mode

Test Date: 5/9/2014
Signal: WCDMA, f=1732.0 MHz, Duty Cycle: 1:1.0
Liquid Parameters: Permittivity: 54.20; Conductivity: 1.55 S/m
Test condition: Ambient Temperature: 22.6°C, Liquid Temperature: 22.0°C
Probe: EPG 210, ConvF: 27.47
Area Scan: sam_direct_droit2_surf8mm.txt, h= 5.00 mm
Zoom Scan: 5x5x7,dx=8mm, dy=8mm, dz=5mm,Complete
Maximum location: X=8.000000, Y=0.000000
SAR 10g (W/Kg): 0.037519
SAR 1g (W/Kg): 0.062496
Power drift (%): 0.14
3D screen shot

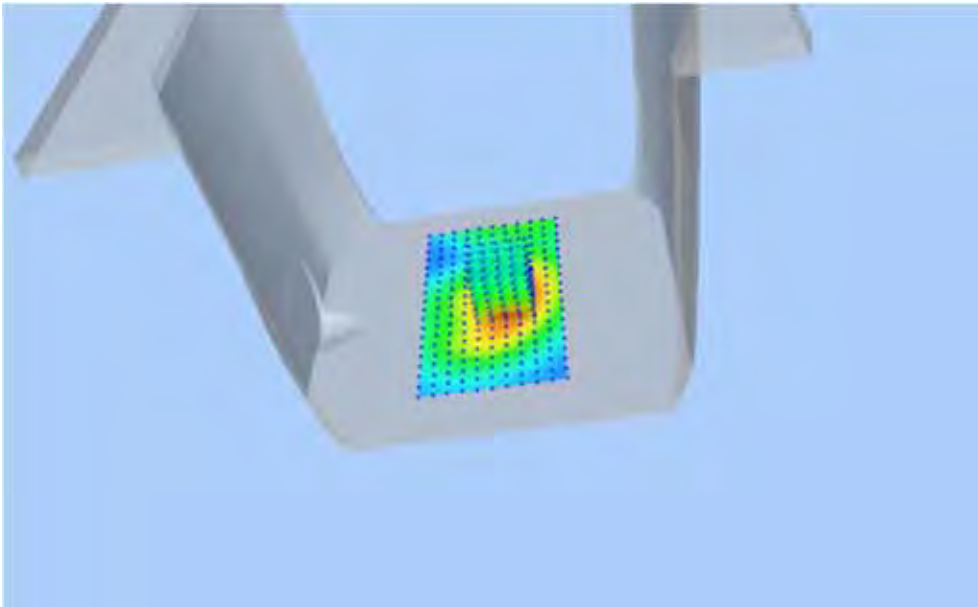

Z Axis Scan

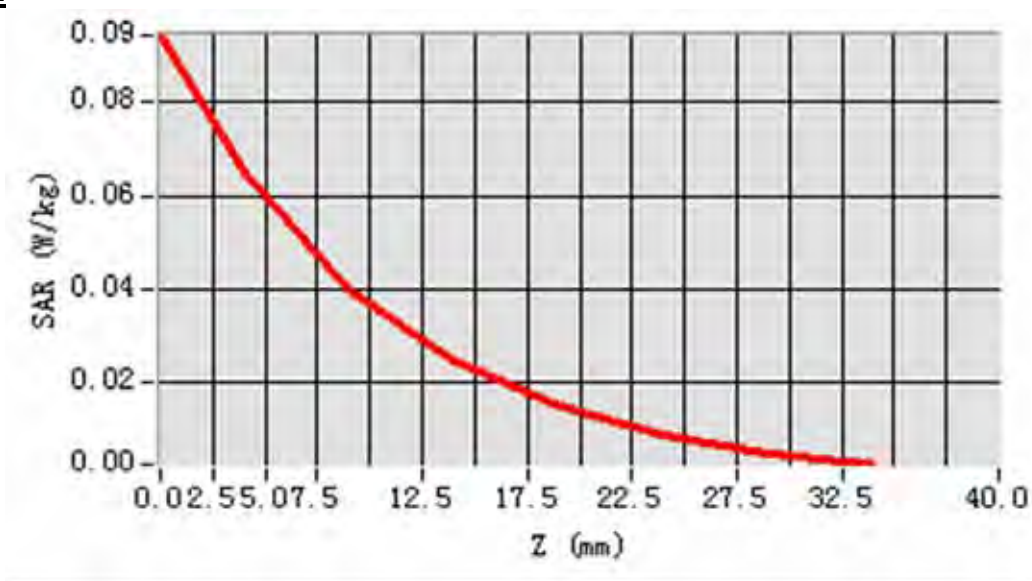

MEAS. 44 Body Plane with Body device position on Middle Channel in

WCDMA1700 mode

Test Date: 5/9/2014
Signal: WCDMA, f=1732.0 MHz, Duty Cycle: 1:1.0
Liquid Parameters: Permittivity: 54.20; Conductivity: 1.55 S/m
Test condition: Ambient Temperature: 22.6°C, Liquid Temperature: 22.0°C
Probe: EPG 210, ConvF: 27.47
Area Scan: sam_direct_droit2_surf8mm.txt, h= 5.00 mm
Zoom Scan: 5x5x7,dx=8mm, dy=8mm, dz=5mm,Complete
Maximum location: X=-8.000000, Y=-32.000000
SAR 10g (W/Kg): 0.040014
SAR 1g (W/Kg): 0.073834
Power drift (%): 0.89
3D screen shot

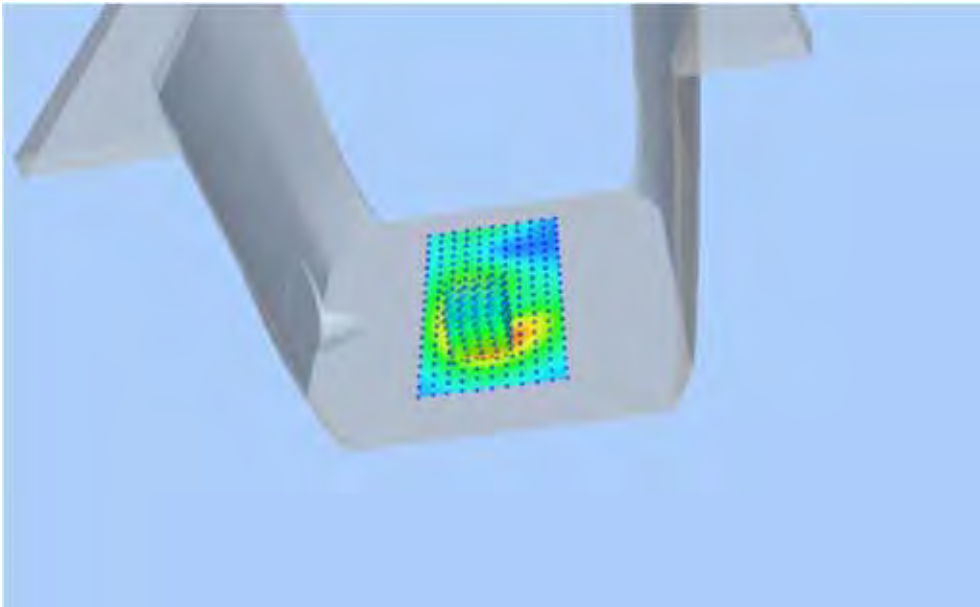

Z Axis Scan

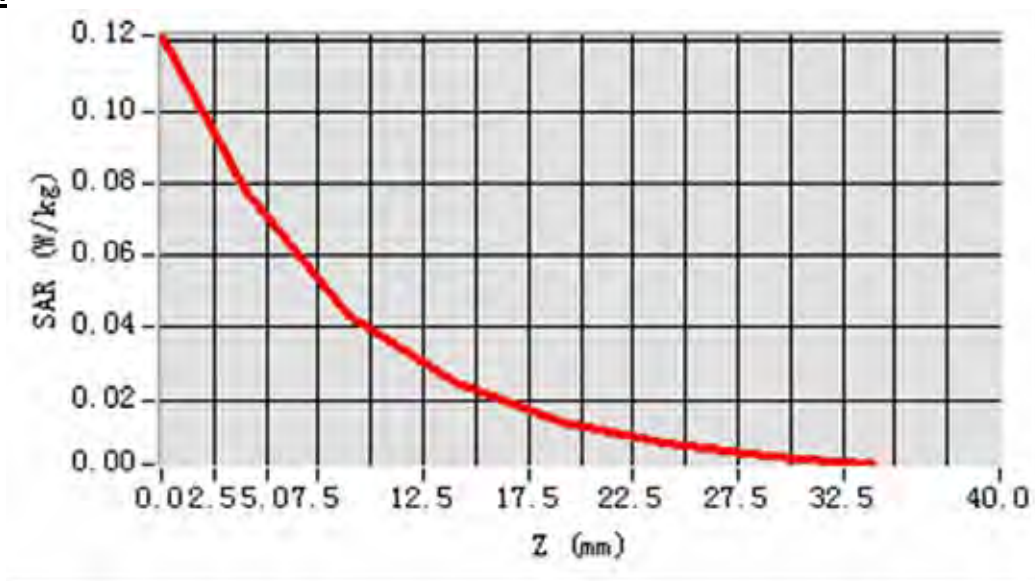

MEAS. 45 Body Plane with Body device position on Middle Channel in

WCDMA1700 mode

Test Date: 5/9/2014
Signal: WCDMA, f=1732.0 MHz, Duty Cycle: 1:1.0
Liquid Parameters: Permittivity: 54.20; Conductivity: 1.55 S/m
Test condition: Ambient Temperature: 22.6°C, Liquid Temperature: 22.0°C
Probe: EPG 210, ConvF: 27.47
Area Scan: sam_direct_droit2_surf8mm.txt, h= 5.00 mm
Zoom Scan: 5x5x7,dx=8mm, dy=8mm, dz=5mm,Complete
Maximum location: X=-8.000000, Y=-32.000000
SAR 10g (W/Kg): 0.007096
SAR 1g (W/Kg): 0.012618
Power drift (%): 4.87
3D screen shot

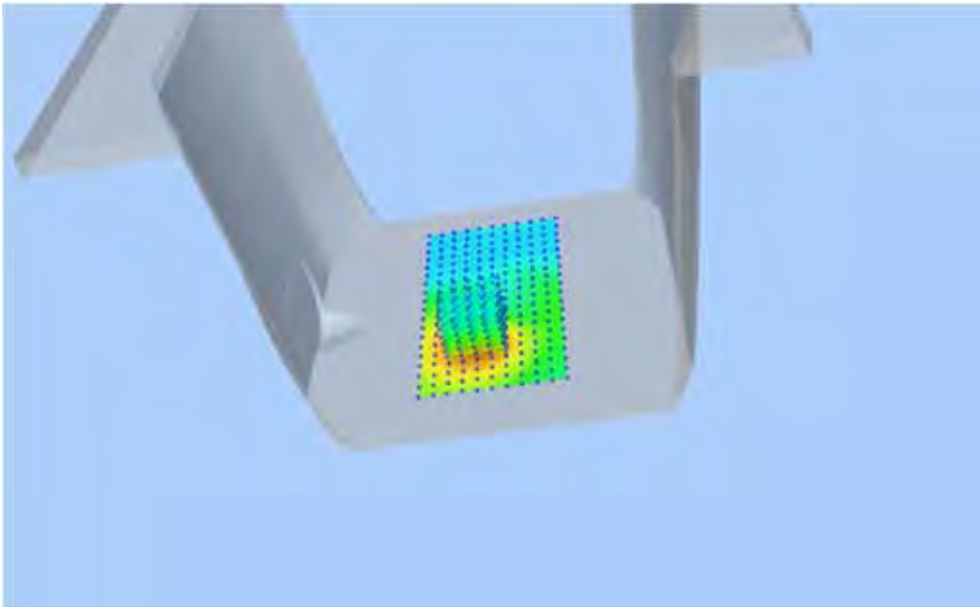

Z Axis Scan

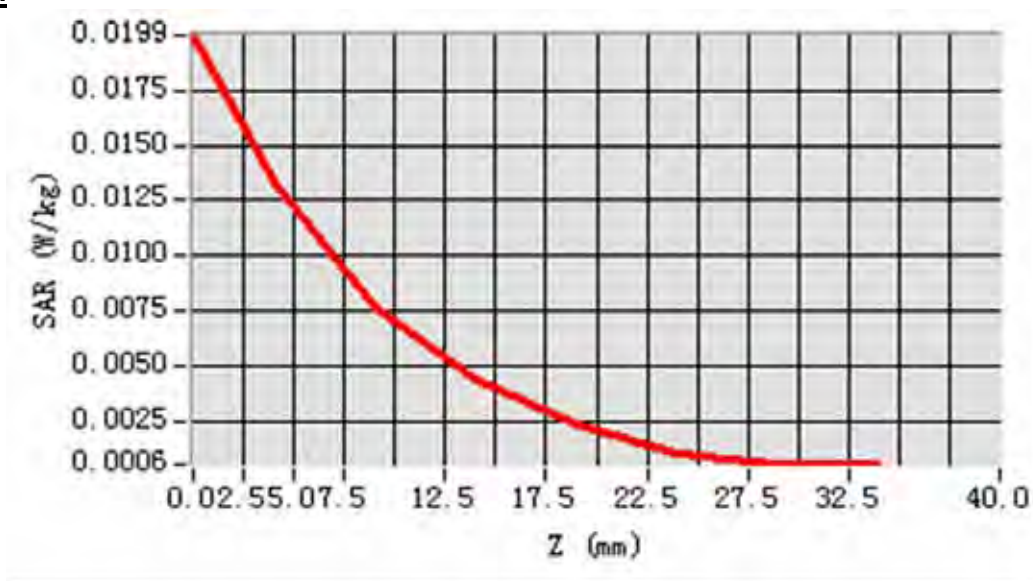

MEAS. 46 Body Plane with Body device position on Middle Channel in

WCDMA1700 mode

Test Date: 5/9/2014
Signal: WCDMA, f=1732.0 MHz, Duty Cycle: 1:1.0
Liquid Parameters: Permittivity: 54.20; Conductivity: 1.55 S/m
Test condition: Ambient Temperature: 22.6°C, Liquid Temperature: 22.0°C
Probe: EPG 210, ConvF: 27.47
Area Scan: sam_direct_droit2_surf8mm.txt, h= 5.00 mm
Zoom Scan: 5x5x7,dx=8mm, dy=8mm, dz=5mm,Complete
Maximum location: X=8.000000, Y=0.000000
SAR 10g (W/Kg): 0.041996
SAR 1g (W/Kg): 0.078839
Power drift (%): 0.17
3D screen shot

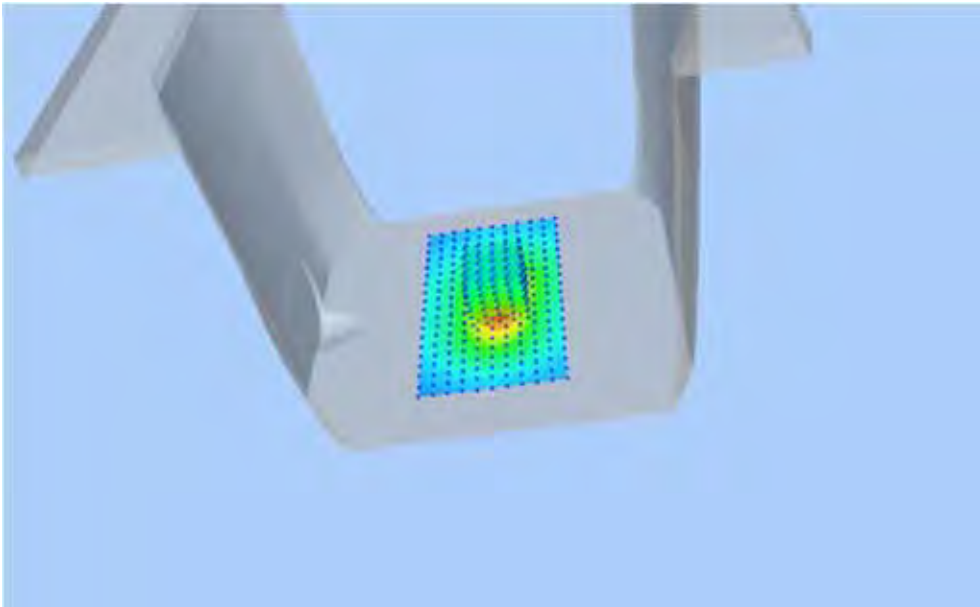

Z Axis Scan

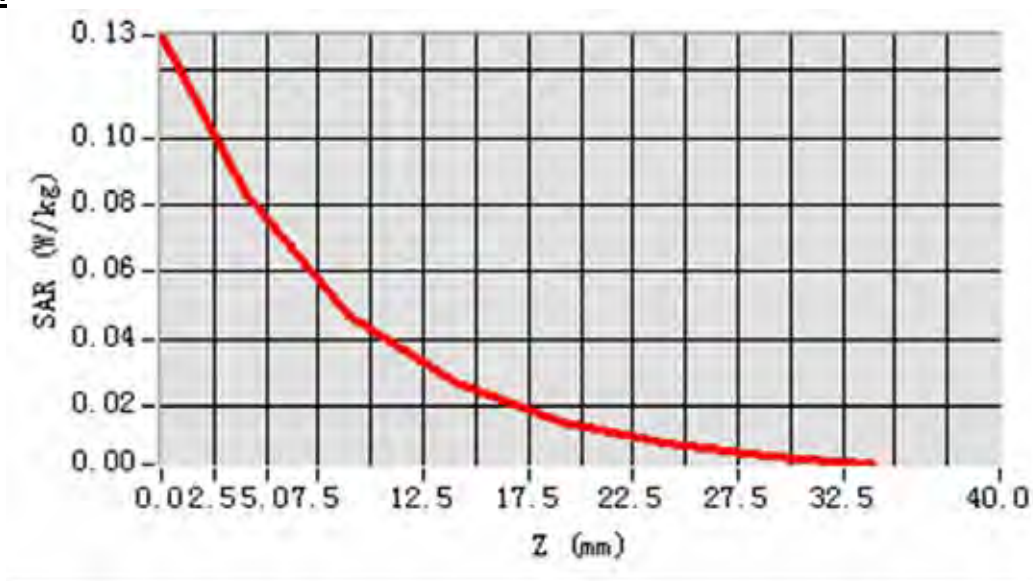

MEAS. 47 Left Head with Cheek device position on High Channel in WLAN

802.11b mode

Test Date: 4/9/2014
Signal: WLAN, f=2437.0 MHz, Duty Cycle: 1:1.0
Liquid Parameters: Permittivity: 39.31; Conductivity: 1.79 S/m
Test condition: Ambient Temperature: 22.6°C, Liquid Temperature: 22.0°C
Probe: EPG 210, ConvF: 25.25
Area Scan: sam_direct_droit2_surf8mm.txt, h= 5.00 mm
Zoom Scan: 5x5x7,dx=8mm, dy=8mm, dz=5mm,Complete
Maximum location: X=-8.000000, Y=-8.000000
SAR 10g (W/Kg): 0.014930
SAR 1g (W/Kg): 0.030124
Power drift (%): -2.29
3D screen shot

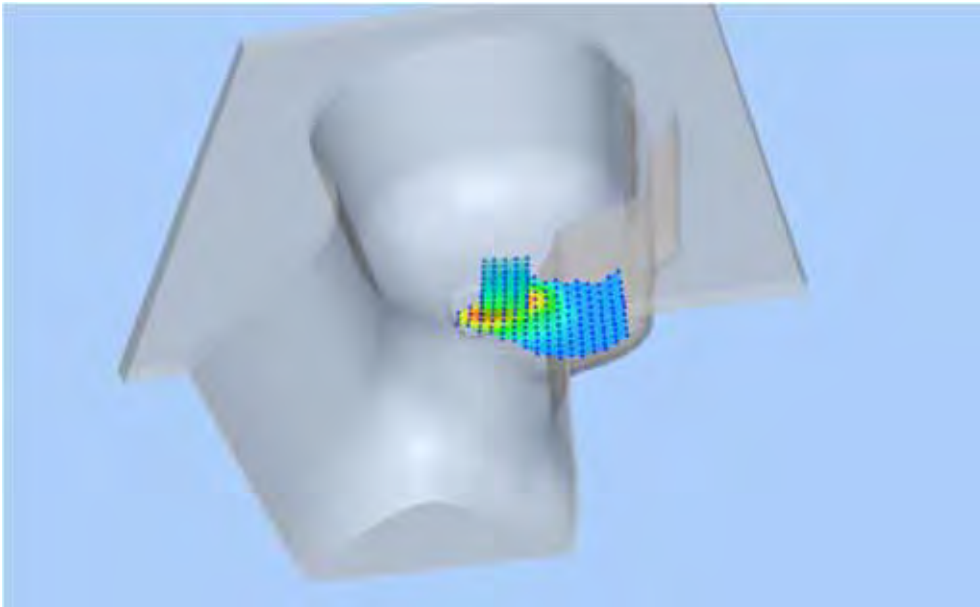

Z Axis Scan

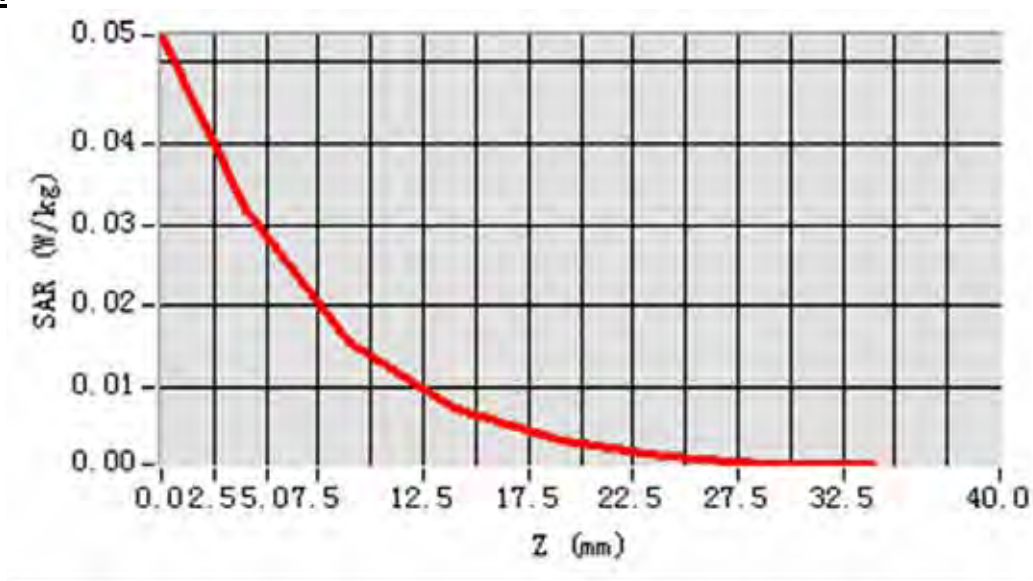

MEAS. 48 Left Head with Tilt device position on High Channel in WLAN

802.11b mode

Test Date: 4/9/2014
Signal: WLAN, f=2437.0 MHz, Duty Cycle: 1:1.0
Liquid Parameters: Permittivity: 39.31; Conductivity: 1.79 S/m
Test condition: Ambient Temperature: 22.6°C, Liquid Temperature: 22.0°C
Probe: EPG 210, ConvF: 25.25
Area Scan: sam_direct_droit2_surf8mm.txt, h= 5.00 mm
Zoom Scan: 5x5x7,dx=8mm, dy=8mm, dz=5mm,Complete
Maximum location: X=-8.000000, Y=0.000000
SAR 10g (W/Kg): 0.013780
SAR 1g (W/Kg): 0.028121
Power drift (%): -1.61
3D screen shot

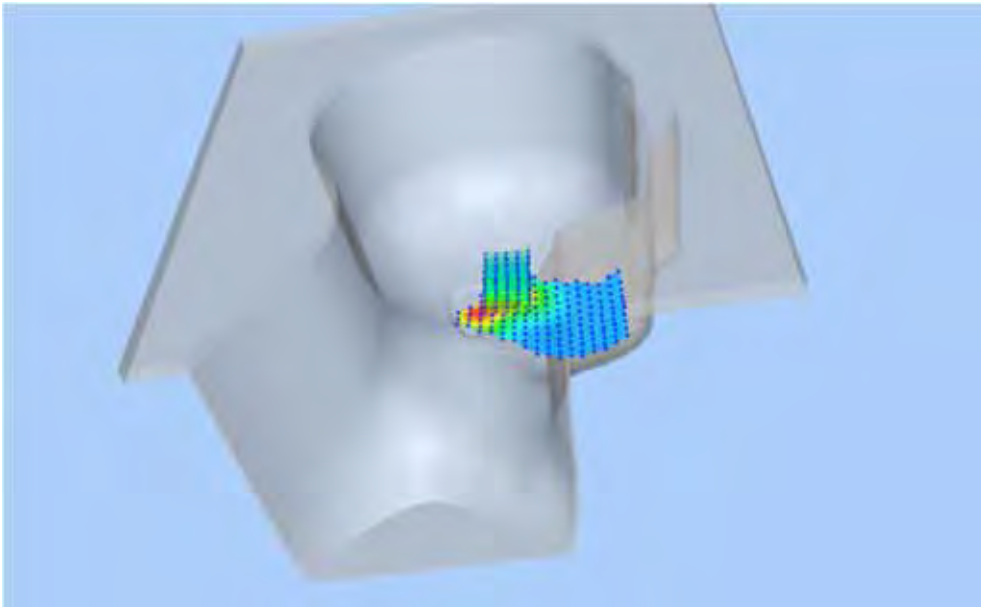

Z Axis Scan

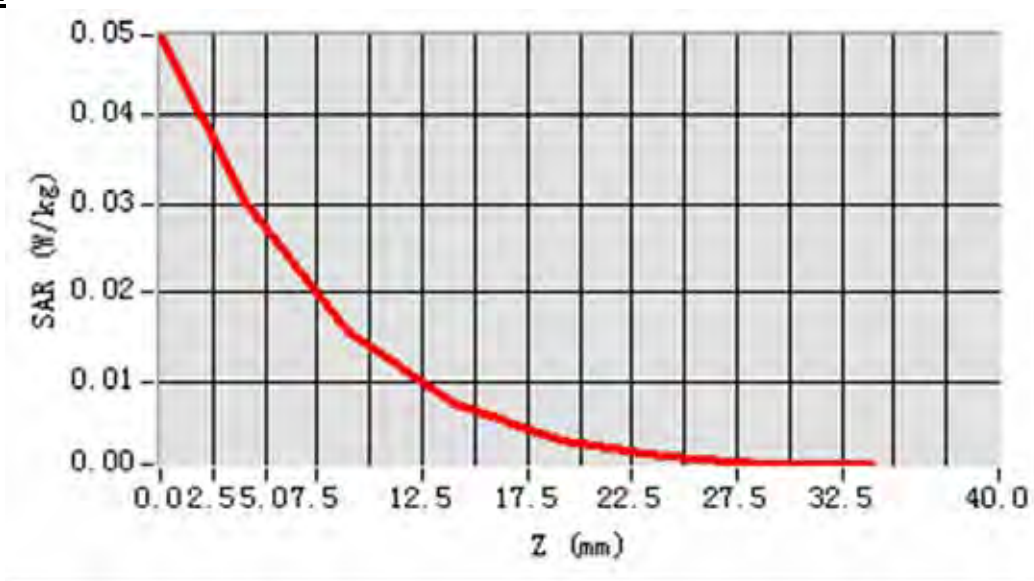

MEAS. 49 Right Head with Cheek device position on High Channel in WLAN

802.11b mode

Test Date: 4/9/2014
Signal: WLAN, f=2437.0 MHz, Duty Cycle: 1:1.0
Liquid Parameters: Permittivity: 39.31; Conductivity: 1.79 S/m
Test condition: Ambient Temperature: 22.6°C, Liquid Temperature: 22.0°C
Probe: EPG 210, ConvF: 25.25
Area Scan: sam_direct_droit2_surf8mm.txt, h= 5.00 mm
Zoom Scan: 5x5x7,dx=8mm, dy=8mm, dz=5mm,Complete
Maximum location: X=-8.000000, Y=16.000000
SAR 10g (W/Kg): 0.027222
SAR 1g (W/Kg): 0.061075
Power drift (%): -1.41
3D screen shot

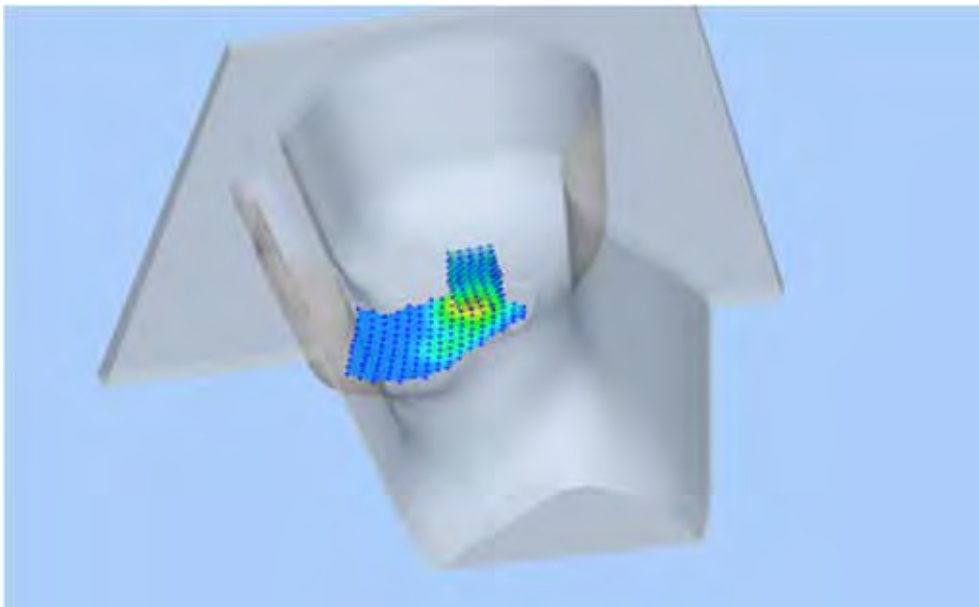

Z Axis Scan

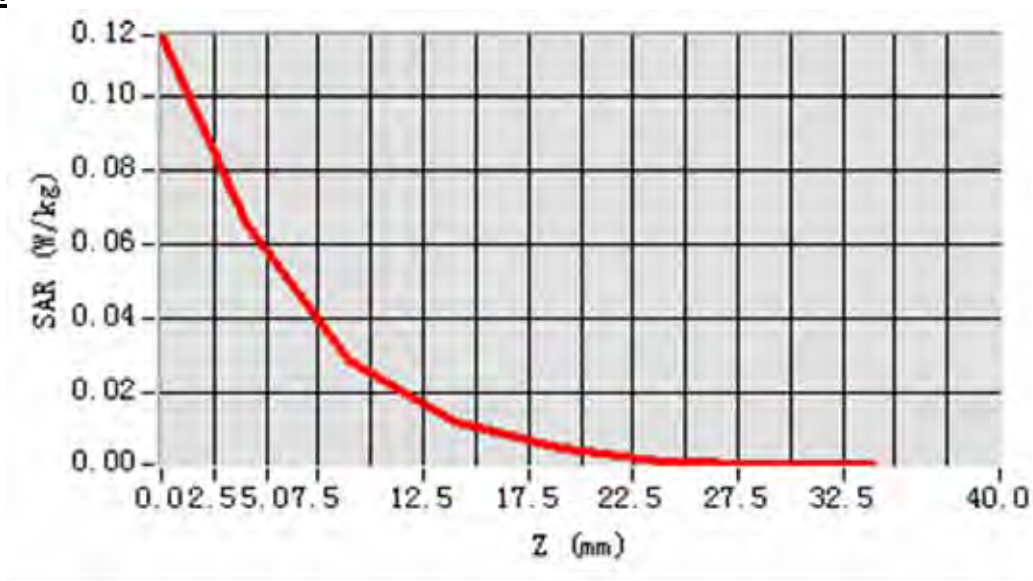

MEAS. 50 Right Head with Tilt device position on High Channel in WLAN

802.11b mode

Test Date: 4/9/2014
Signal: WLAN, f=2437.0 MHz, Duty Cycle: 1:1.0
Liquid Parameters: Permittivity: 39.31; Conductivity: 1.79 S/m
Test condition: Ambient Temperature: 22.6°C, Liquid Temperature: 22.0°C
Probe: EPG 210, ConvF: 25.25
Area Scan: sam_direct_droit2_surf8mm.txt, h= 5.00 mm
Zoom Scan: 5x5x7,dx=8mm, dy=8mm, dz=5mm,Complete
Maximum location: X=-8.000000, Y=16.000000
SAR 10g (W/Kg): 0.022686
SAR 1g (W/Kg): 0.052284
Power drift (%): 0.39
3D screen shot

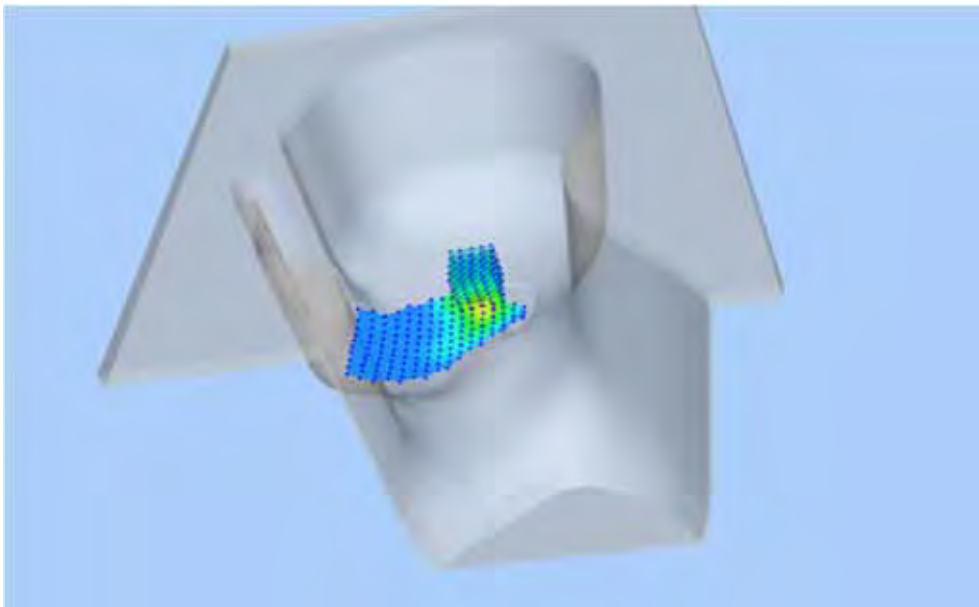

Z Axis Scan

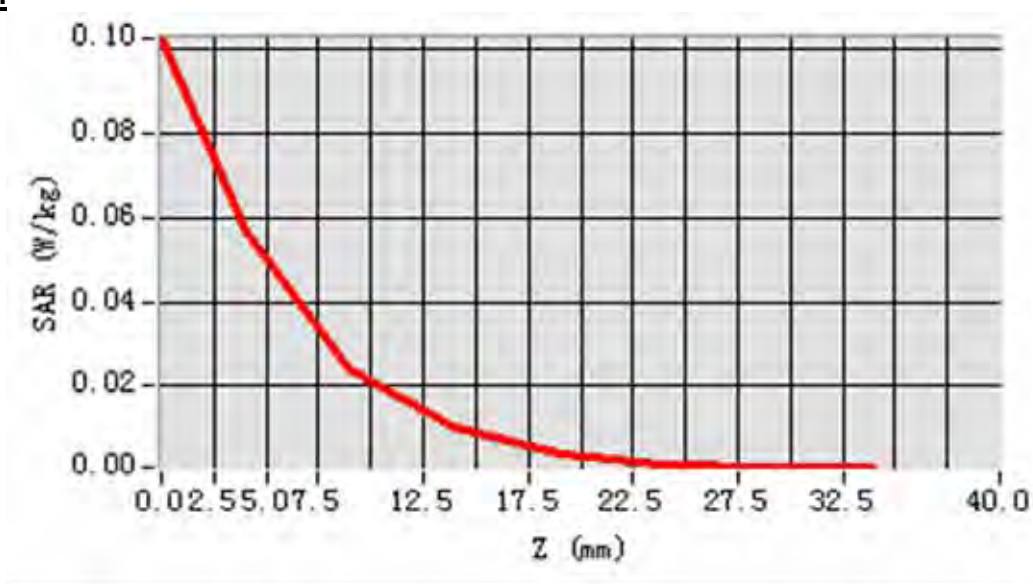

MEAS. 51 Body Plane with Body device position on High Channel in WLAN

802.11b mode

Test Date: 5/9/2014
Signal: WLAN, f=2437.0 MHz, Duty Cycle: 1:1.0
Liquid Parameters: Permittivity: 53.12; Conductivity: 1.97 S/m
Test condition: Ambient Temperature: 22.6°C, Liquid Temperature: 22.0°C
Probe: EPG 210, ConvF: 26.09
Area Scan: sam_direct_droit2_surf8mm.txt, h= 5.00 mm
Zoom Scan: 5x5x7,dx=8mm, dy=8mm, dz=5mm,Complete
Maximum location: X=0.000000, Y=-8.000000
SAR 10g (W/Kg): 0.015541
SAR 1g (W/Kg): 0.029592
Power drift (%): -1.85
3D screen shot

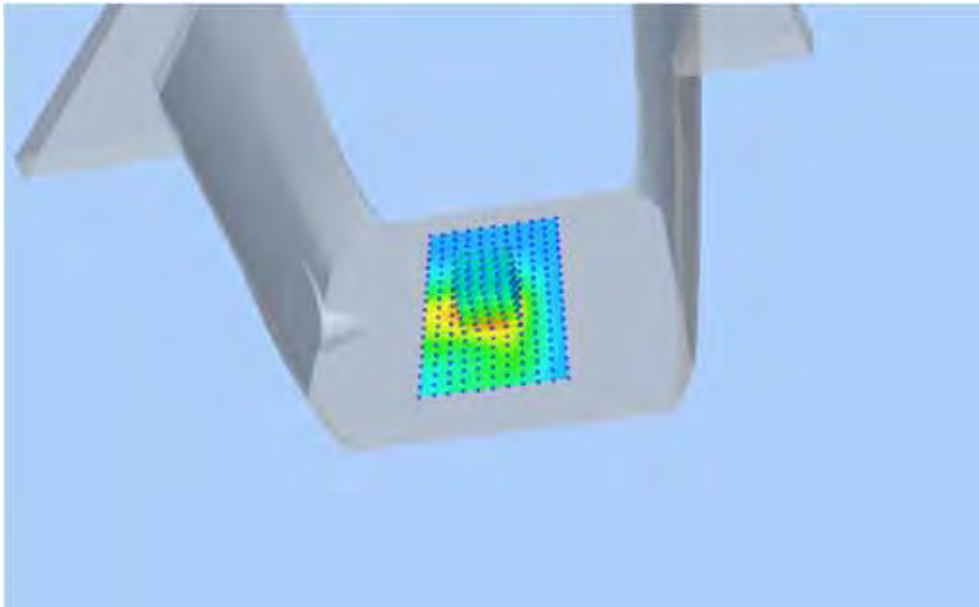

Z Axis Scan

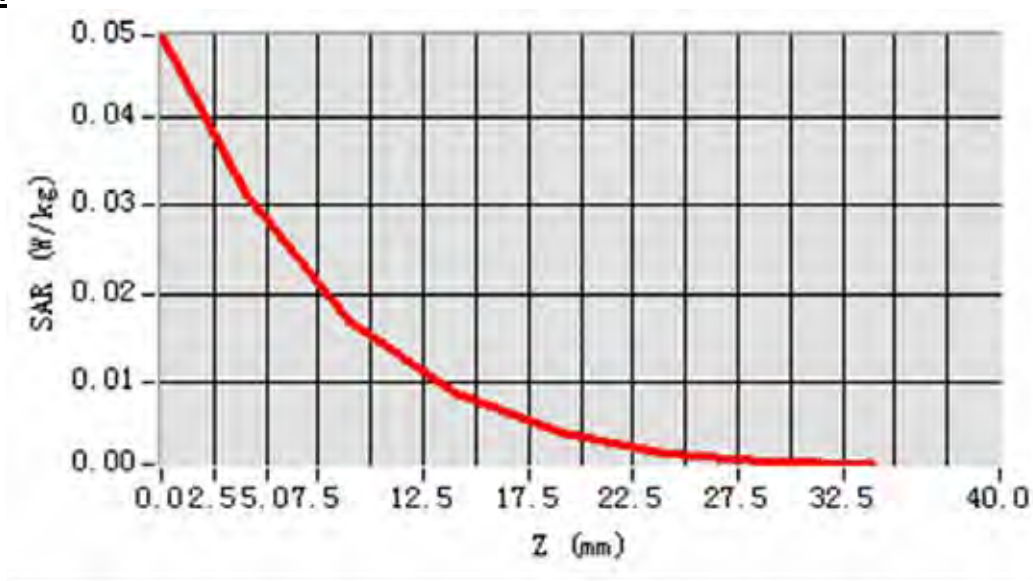

MEAS. 52 Body Plane with Body device position on High Channel in WLAN

802.11b mode

Test Date: 5/9/2014
Signal: WLAN, f=2437.0 MHz, Duty Cycle: 1:1.0
Liquid Parameters: Permittivity: 53.12; Conductivity: 1.97 S/m
Test condition: Ambient Temperature: 22.6°C, Liquid Temperature: 22.0°C
Probe: EPG 210, ConvF: 26.09
Area Scan: sam_direct_droit2_surf8mm.txt, h= 5.00 mm
Zoom Scan: 5x5x7,dx=8mm, dy=8mm, dz=5mm,Complete
Maximum location: X=-16.000000, Y=0.000000
SAR 10g (W/Kg): 0.025897
SAR 1g (W/Kg): 0.050888
Power drift (%): -0.66
3D screen shot

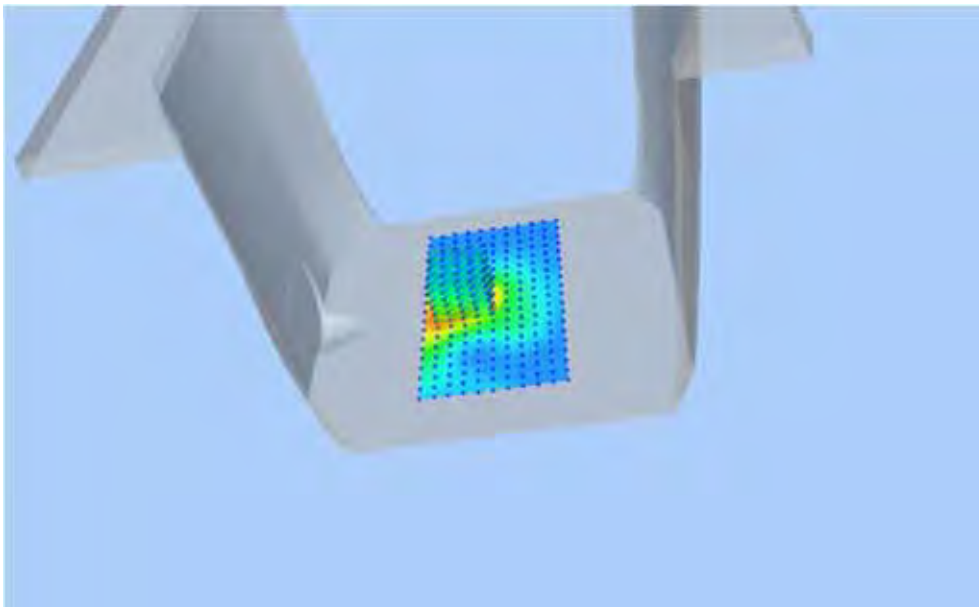

Z Axis Scan

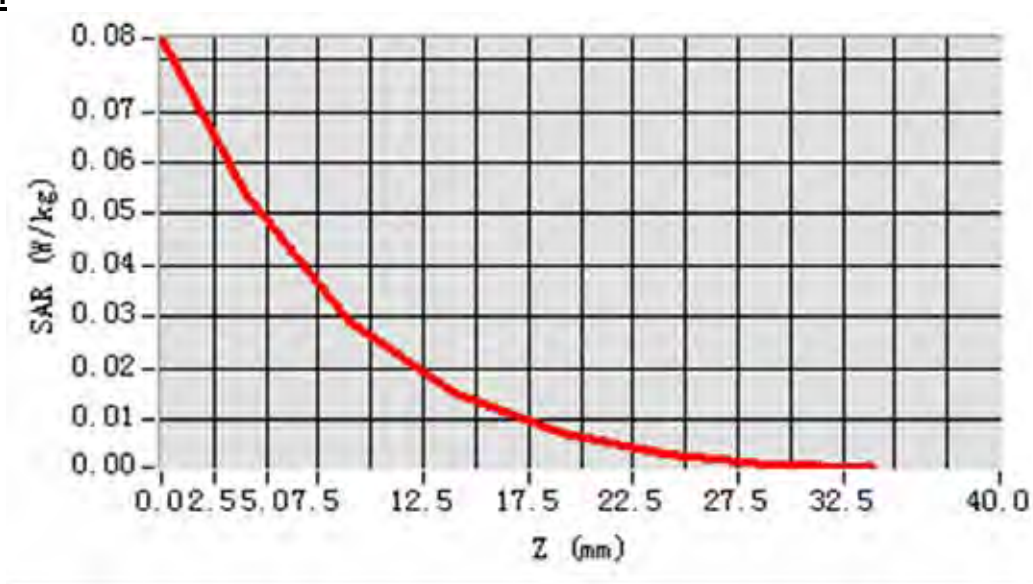

MEAS. 53 Body Plane with Body device position on High Channel in WLAN

802.11b mode

Test Date: 5/9/2014
Signal: WLAN, f=2437.0 MHz, Duty Cycle: 1:1.0
Liquid Parameters: Permittivity: 53.12; Conductivity: 1.97 S/m
Test condition: Ambient Temperature: 22.6°C, Liquid Temperature: 22.0°C
Probe: EPG 210, ConvF: 26.09
Area Scan: sam_direct_droit2_surf8mm.txt, h= 5.00 mm
Zoom Scan: 5x5x7,dx=8mm, dy=8mm, dz=5mm,Complete
Maximum location: X=8.000000, Y=-8.000000
SAR 10g (W/Kg): 0.005673
SAR 1g (W/Kg): 0.011715
Power drift (%): 0.47
3D screen shot

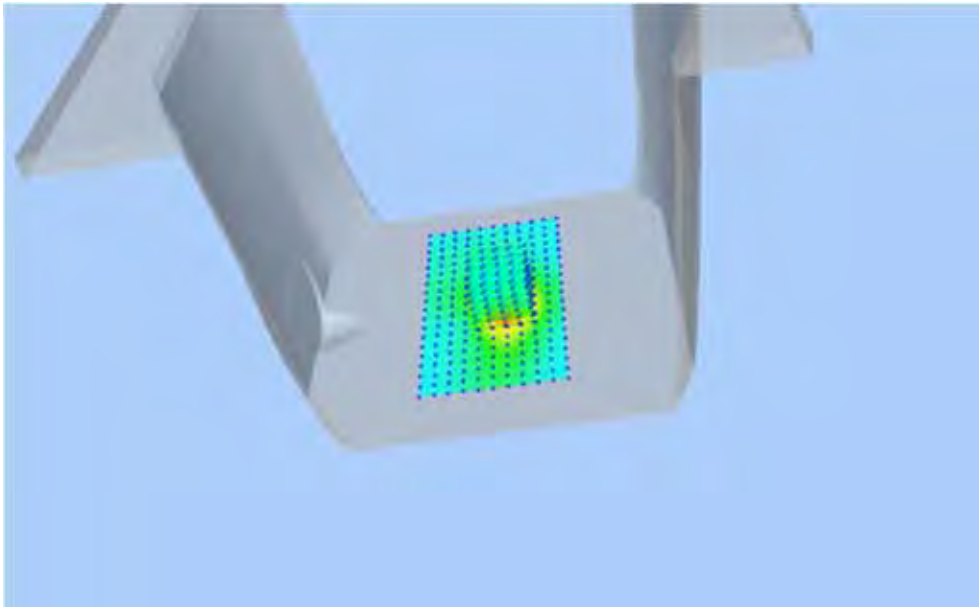

Z Axis Scan

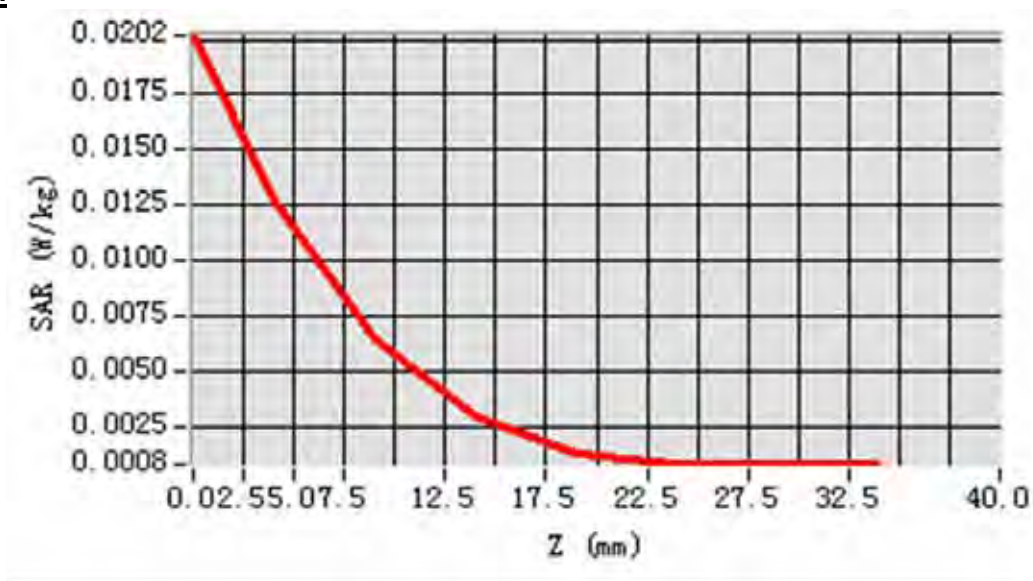

MEAS. 54 Body Plane with Body device position on High Channel in WLAN

802.11b mode

Test Date: 5/9/2014
Signal: WLAN, f=2437.0 MHz, Duty Cycle: 1:1.0
Liquid Parameters: Permittivity: 53.12; Conductivity: 1.97 S/m
Test condition: Ambient Temperature: 22.6°C, Liquid Temperature: 22.0°C
Probe: EPG 210, ConvF: 26.09
Area Scan: sam_direct_droit2_surf8mm.txt, h= 5.00 mm
Zoom Scan: 5x5x7,dx=8mm, dy=8mm, dz=5mm,Complete
Maximum location: X=0.000000, Y=-8.000000
SAR 10g (W/Kg): 0.013850
SAR 1g (W/Kg): 0.025810
Power drift (%): -2.57
3D screen shot

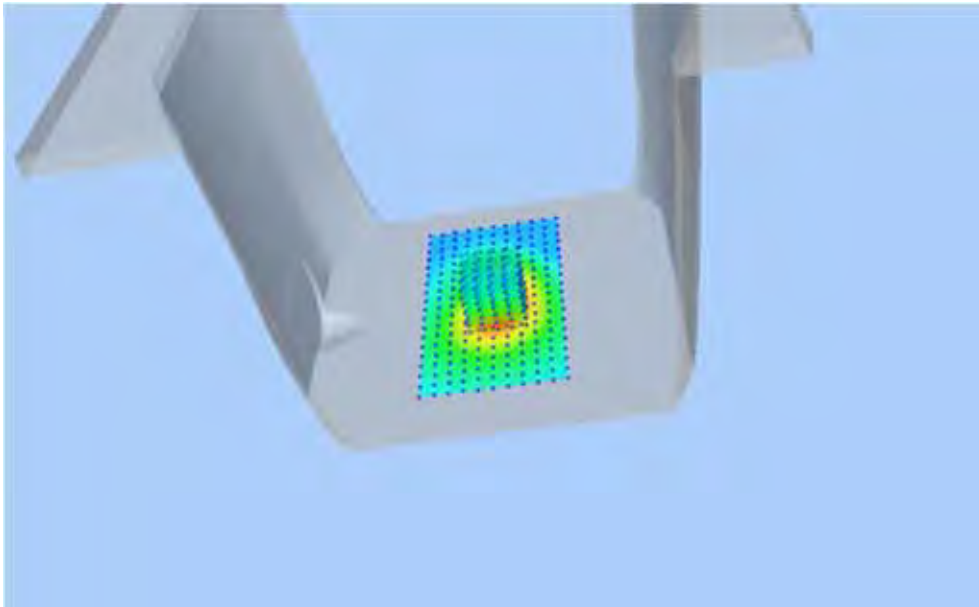

Z Axis Scan

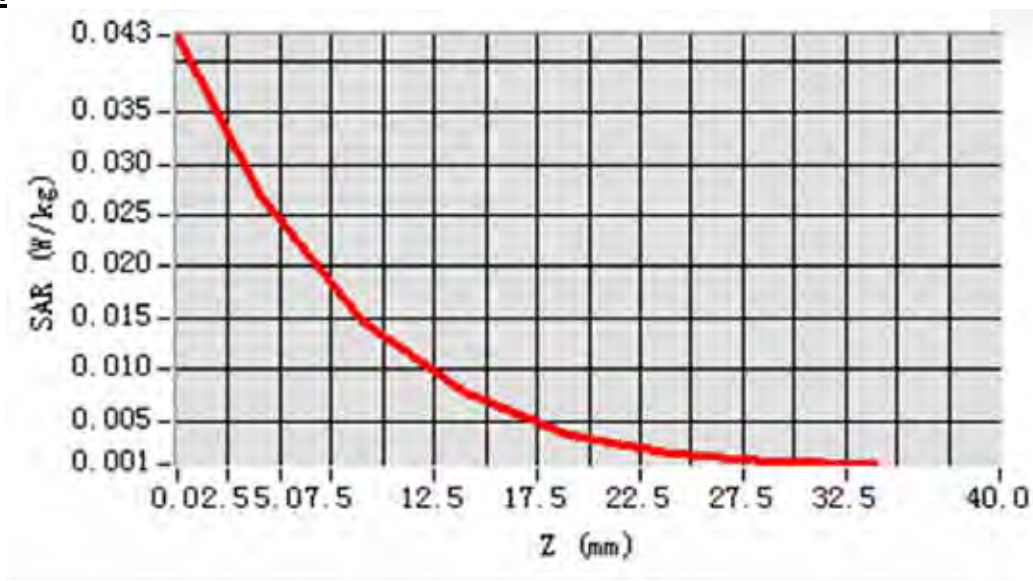

ANNEX D CALIBRATION FOR PROBE AND DIPOLE



COMOSAR E-Field Probe Calibration Report

Ref: ACR.155.1.14.SATU.A

SHENZHEN BALUN TECHNOLOGY Co.,Ltd.
BLOCK B, FL 1, BAISHA SCIENCE AND TECHNOLOGY
PARK, SHAHE XI ROAD,
NANSHAN DISTRICT, SHENZHEN, GUANGDONG
PROVINCE, P.R. CHINA 518055
SATIMO COMOSAR DOSIMETRIC E-FIELD PROBE
SERIAL NO.: SN 27/14 EPG210

Calibrated at SATIMO US
2105 Barrett Park Dr. - Kennesaw, GA 30144



05/16/2014

Summary:

This document presents the method and results from an accredited COMOSAR Dosimetric E-Field Probe calibration performed in SATIMO USA using the CALISAR / CALIBAIR test bench, for use with a SATIMO COMOSAR system only. All calibration results are traceable to national metrology institutions.



COMOSAR E-FIELD PROBE CALIBRATION REPORT

Ref: ACR135.114SAT0.A

	<i>Name</i>	<i>Function</i>	<i>Date</i>	<i>Signature</i>
<i>Prepared by :</i>	Jérôme LUC	Product Manager	6/4/2014	<i>JB</i>
<i>Checked by :</i>	Jérôme LUC	Product Manager	6/4/2014	<i>JB</i>
<i>Approved by :</i>	Kim RUTKOWSKI	Quality Manager	6/4/2014	<i>Kim RUTKOWSKI</i>

	<i>Customer Name</i>
<i>Distribution :</i>	ChangNing (Shenzhen) Electronics Co., Ltd.

<i>Issue</i>	<i>Date</i>	<i>Modifications</i>
A	6/4/2014	Initial release

Page: 2/10

*This document shall not be reproduced, except in full or in part, without the written approval of SATIMO.
The information contained herein is to be used only for the purpose for which it is submitted and is not to be released in whole or part without written approval of SATIMO.*



TABLE OF CONTENTS

1	Device Under Test	4
2	Product Description	4
2.1	General Information	4
3	Measurement Method	4
3.1	Linearity	4
3.2	Sensitivity	5
3.3	Lower Detection Limit	5
3.4	Isotropy	5
3.5	Boundary Effect	5
4	Measurement Uncertainty	5
5	Calibration Measurement Results	6
5.1	Sensitivity in air	6
5.2	Linearity	7
5.3	Sensitivity in liquid	7
5.4	Isotropy	8
6	List of Equipment	10

1 DEVICE UNDER TEST

Device Under Test	
Device Type	COMOSAR DOSIMETRIC E FIELD PROBE
Manufacturer	Satimo
Model	SSE2
Serial Number	SN 27/14 EPG210
Product Condition (new / used)	New
Frequency Range of Probe	0.3 GHz-6GHz
Resistance of Three Dipoles at Connector	Dipole 1: R1=0.197 MΩ Dipole 2: R2=0.220 MΩ Dipole 3: R3=0.241 MΩ

A yearly calibration interval is recommended.

2 PRODUCT DESCRIPTION

2.1 GENERAL INFORMATION

Satimo's COMOSAR E field Probes are built in accordance to the IEEE 1528, OET 65 Bulletin C and CEI/IEC 62209 standards.



Figure 1 – Satimo COMOSAR Dosimetric E field Dipole

Probe Length	330 mm
Length of Individual Dipoles	2 mm
Maximum external diameter	8 mm
Probe Tip External Diameter	2.5 mm
Distance between dipoles / probe extremity	1 mm

3 MEASUREMENT METHOD

The IEEE 1528, OET 65 Bulletin C, CENELEC EN50361 and CEI/IEC 62209 standards provide recommended practices for the probe calibrations, including the performance characteristics of interest and methods by which to assess their affect. All calibrations / measurements performed meet the fore mentioned standards.

3.1 LINEARITY

The evaluation of the linearity was done in free space using the waveguide, performing a power sweep to cover the SAR range 0.01W/kg to 100W/kg.

Page: 4/10

*This document shall not be reproduced, except in full or in part, without the written approval of SATIMO.
The information contained herein is to be used only for the purpose for which it is submitted and is not to be retained in whole or part without written approval of SATIMO.*

3.2 SENSITIVITY

The sensitivity factors of the three dipoles were determined using a two step calibration method (air and tissue simulating liquid) using waveguides as outlined in the standards.

3.3 LOWER DETECTION LIMIT

The lower detection limit was assessed using the same measurement set up as used for the linearity measurement. The required lower detection limit is 10 mW/kg.

3.4 ISOTROPY

The axial isotropy was evaluated by exposing the probe to a reference wave from a standard dipole with the dipole mounted under the flat phantom in the test configuration suggested for system validations and checks. The probe was rotated along its main axis from 0 - 360 degrees in 15 degree steps. The hemispherical isotropy is determined by inserting the probe in a thin plastic box filled with tissue-equivalent liquid, with the plastic box illuminated with the fields from a half wave dipole. The dipole is rotated about its axis (0°-180°) in 15° increments. At each step the probe is rotated about its axis (0°-360°).

3.5 BOUNDARY EFFECT

The boundary effect is defined as the deviation between the SAR measured data and the expected exponential decay in the liquid when the probe is oriented normal to the interface. To evaluate this effect, the liquid filled flat phantom is exposed to fields from either a reference dipole or waveguide. With the probe normal to the phantom surface, the peak spatial average SAR is measured and compared to the analytical value at the surface.

4 MEASUREMENT UNCERTAINTY

The guidelines outlined in the IEEE 1528, OET 65 Bulletin C, CENELEC EN50361 and CEI/IEC 62209 standards were followed to generate the measurement uncertainty associated with an E-field probe calibration using the waveguide technique. All uncertainties listed below represent an expanded uncertainty expressed at approximately the 95% confidence level using a coverage factor of $k=2$, traceable to the Internationally Accepted Guides to Measurement Uncertainty.

Uncertainty analysis of the probe calibration in waveguide					
ERROR SOURCES	Uncertainty value (%)	Probability Distribution	Divisor	ci	Standard Uncertainty (%)
Incident or forward power	3.00%	Rectangular	$\sqrt{3}$	1	1.732%
Reflected power	3.00%	Rectangular	$\sqrt{3}$	1	1.732%
Liquid conductivity	5.00%	Rectangular	$\sqrt{3}$	1	2.887%
Liquid permittivity	4.00%	Rectangular	$\sqrt{3}$	1	2.309%
Field homogeneity	3.00%	Rectangular	$\sqrt{3}$	1	1.732%
Field probe positioning	5.00%	Rectangular	$\sqrt{3}$	1	2.887%
Field probe linearity	3.00%	Rectangular	$\sqrt{3}$	1	1.732%

Page: 3/10

*This document shall not be reproduced, except in full or in part, without the written approval of SATIMO.
The information contained herein is to be used only for the purpose for which it is submitted and is not to be retained in whole or part without written approval of SATIMO.*



COMOSAR E-FIELD PROBE CALIBRATION REPORT

Ref: ACR135.1-14 SATU A

Combined standard uncertainty					5.831%
Expanded uncertainty 95 % confidence level k = 2					12.0%

5 CALIBRATION MEASUREMENT RESULTS

Calibration Parameters	
Liquid Temperature	21 °C
Lab Temperature	21 °C
Lab Humidity	45 %

5.1 SENSITIVITY IN AIR

Normx dipole 1 (μV/(V/m) ²)	Normy dipole 2 (μV/(V/m) ²)	Normz dipole 3 (μV/(V/m) ²)
0.44	0.54	0.52

DCP dipole 1 (mV)	DCP dipole 2 (mV)	DCP dipole 3 (mV)
90	90	90

Calibration curves $e_i=f(V)$ ($i=1,2,3$) allow to obtain H-field value using the formula:

$$E = \sqrt{E_1^2 + E_2^2 + E_3^2}$$

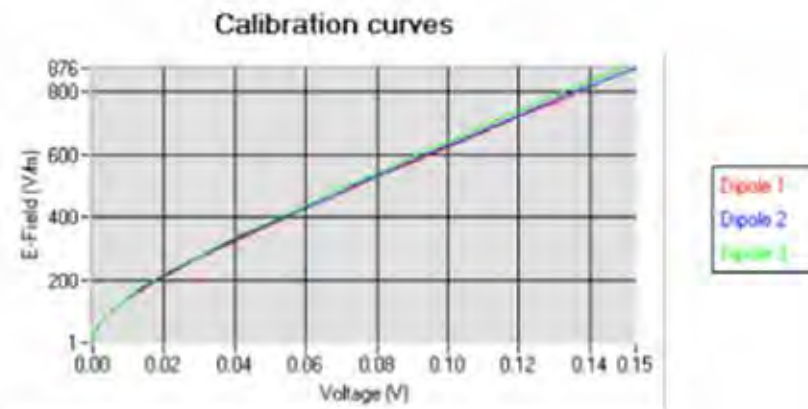

Page: 6/10

*This document shall not be reproduced, except in full or in part, without the written approval of SATIMO.
The information contained herein is to be used only for the purpose for which it is submitted and is not to
be released in whole or part without written approval of SATIMO.*

5.2 LINEARITY

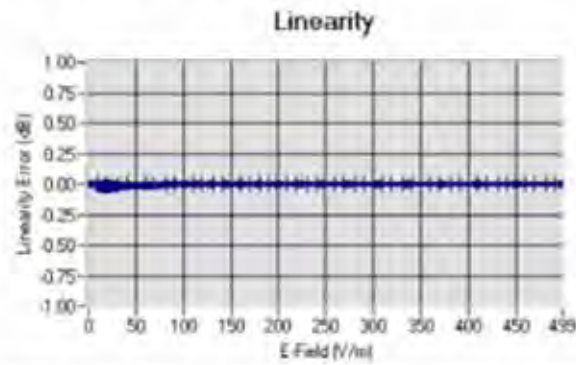

Linearity $(\pm 1.25\% (\pm 0.05\text{dB}))$

5.3 SENSITIVITY IN LIQUID

Liquid	Frequency (MHz $\pm 100\text{MHz}$)	Permittivity	Epsilon (S/m)	ConvE
HL450	450	43.02	0.85	30.15
BL450	450	57.52	0.96	31.02
HL750	750	42.10	0.88	22.51
BL750	750	54.79	0.96	23.36
HL850	835	43.03	0.87	23.67
BL850	835	53.35	0.96	24.58
HL900	900	42.29	0.96	23.35
BL900	900	56.82	1.06	24.10
HL1800	1800	40.93	1.36	23.21
BL1800	1800	52.57	1.47	23.69
HL1900	1900	40.92	1.45	26.70
BL1900	1900	53.60	1.52	27.47
HL2000	2000	39.36	1.44	25.28
BL2000	2000	52.17	1.53	26.28
HL2450	2450	39.12	1.78	25.25
BL2450	2450	52.17	1.90	26.09
HL2600	2600	38.46	1.92	25.94
BL2600	2600	51.76	2.19	26.66
HL5200	5200	36.47	4.91	22.36
BL5200	5200	51.18	4.84	22.88
HL5400	5400	36.83	5.02	25.63
BL5400	5400	48.35	5.81	26.47
HL5600	5600	35.39	5.49	24.82
BL5600	5600	49.03	6.17	25.66
HL5800	5800	34.91	5.76	22.60
BL5800	5800	47.18	6.32	23.20

LOWER DETECTION LIMIT: 7mW/kg

Page: 5/10

This document shall not be reproduced, except in full or in part, without the written approval of SATIMO. The information contained herein is to be used only for the purpose for which it is submitted and is not to be retained in whole or part without written approval of SATIMO.



5.4 ISOTROPY

HL900 MHz

- Axial isotropy: 0.04 dB
- Hemispherical isotropy: 0.07 dB

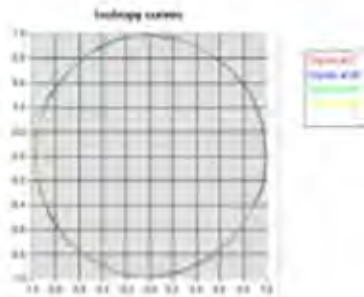

HL1800 MHz

- Axial isotropy: 0.04 dB
- Hemispherical isotropy: 0.08 dB

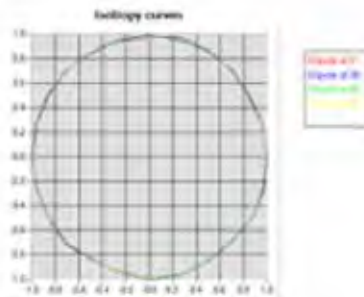



COMOSAR E-FIELD PROBE CALIBRATION REPORT

Ref: ACR.155.1.14.SATU.A

HLS400 MHz

- Axial isotropy: 0.05 dB
- Hemispherical isotropy: 0.10 dB

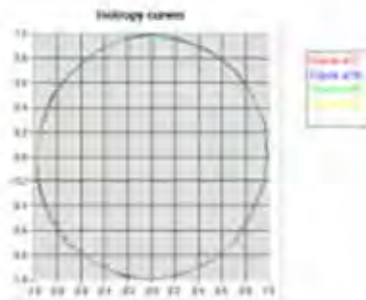

Page: 9/10

*This document shall not be reproduced, except in full or in part, without the written approval of SATIMO.
The information contained herein is to be used only for the purpose for which it is submitted and is not to be released in whole or part without written approval of SATIMO.*

6 LIST OF EQUIPMENT

Equipment Summary Sheet				
Equipment Description	Manufacturer / Model	Identification No.	Current Calibration Date	Next Calibration Date
Flat Phantom	Satimo	SN-20/09-SAM71	Validated. No cal required.	Validated. No cal required.
COMOSAR Test Bench	Version 3	NA	Validated. No cal required.	Validated. No cal required.
Network Analyzer	Rhode & Schwarz ZVA	SN100132	02/2013	02/2016
Reference Probs	Satimo	EP 94 SN 37/08	Characterized prior to test. No cal required.	Characterized prior to test. No cal required.
Multimeter	Keithley 2000	1188656	12/2013	12/2016
Signal Generator	Agilent E4438C	MY49070581	12/2013	12/2016
Amplifier	Aethercomm	SN 046	Characterized prior to test. No cal required.	Characterized prior to test. No cal required.
Power Meter	HP E4418A	US38261498	12/2013	12/2016
Power Sensor	HP ECP-E26A	US37181460	12/2013	12/2016
Directional Coupler	Narda 4216-20	01386	Characterized prior to test. No cal required.	Characterized prior to test. No cal required.
Waveguide	Mega Industries	069Y7-158-13-712	Validated. No cal required.	Validated. No cal required.
Waveguide Transition	Mega Industries	069Y7-158-13-701	Validated. No cal required.	Validated. No cal required.
Waveguide Termination	Mega Industries	069Y7-158-13-701	Validated. No cal required.	Validated. No cal required.
Temperature / Humidity Sensor	Control Company	11-661-9	8/2012	8/2015

Page: 10/10

*This document shall not be reproduced, stored in full or in part, without the written approval of SATIMO.
The information contained herein is to be used only for the purpose for which it is submitted and is not to be released in whole or part without written approval of SATIMO.*



SAR Reference Dipole Calibration Report

Ref : ACR.219.4.13.SATU.A

SHENZHEN BALUN TECHNOLOGY CO., LTD.
BLOCK B, FL 1, BAISHA SCIENCE AND TECHNOLOGY
PARK, SHAHE XI ROAD, NANSHAN DISTRICT,
SHENZHEN, GUANGDONG PROVINCE, 518055 P. R. CHINA
SATIMO COMOSAR REFERENCE DIPOLE
FREQUENCY: 835 MHZ
SERIAL NO.: SN 25/13 DIP 0G835-246

Calibrated at SATIMO US
2105 Barrett Park Dr. - Kennesaw, GA 30144



8/17/2014

Summary:

This document presents the method and results from an accredited SAR reference dipole calibration performed in SATIMO USA using the COMOSAR test bench. All calibration results are traceable to national metrology institutions.



SAR REFERENCE DIPOLE CALIBRATION REPORT

R/C: ACR219.A11.SATIM.A

	<i>Name</i>	<i>Function</i>	<i>Date</i>	<i>Signature</i>
<i>Prepared by :</i>	Jérôme LUC	Product Manager	8/17/2014	<i>[Signature]</i>
<i>Checked by :</i>	Jérôme LUC	Product Manager	8/17/2014	<i>[Signature]</i>
<i>Approved by :</i>	Kim RUTKOWSKI	Quality Manager	8/17/2014	<i>[Signature]</i>

<i>Distribution :</i>	<i>Customer Name</i> Shenzhen Balun Technology Co.,Ltd.
-----------------------	--

<i>Issue</i>	<i>Date</i>	<i>Modifications</i>
A	8/17/2014	Initial release

TABLE OF CONTENTS

1	Introduction.....	4
2	Device Under Test	4
3	Product Description	4
3.1	General Information	4
4	Measurement Method	5
4.1	Return Loss Requirements	5
4.2	Mechanical Requirements	5
5	Measurement Uncertainty.....	5
5.1	Return Loss	5
5.2	Dimension Measurement	5
5.3	Validation Measurement	5
6	Calibration Measurement Results	6
6.1	Return Loss	6
6.2	Mechanical Dimensions	6
7	Validation measurement	7
7.1	Measurement Condition	7
7.2	Head Liquid Measurement	7
7.3	Measurement Result	8
7.4	Body Measurement Result	9
8	List of Equipment	10

Page: 3/10

*This document shall not be reproduced, except in full or in part, without the written approval of SATIMO.
The information contained herein is to be used only for the purpose for which it is submitted and is not to
be released in whole or part without written approval of SATIMO.*

1 INTRODUCTION

This document contains a summary of the requirements set forth by the IEEE 1528, OET 65 Bulletin C and CEI/IEC 62209 standards for reference dipoles used for SAR measurement system validations and the measurements that were performed to verify that the product complies with the fore-mentioned standards.

2 DEVICE UNDER TEST

Device Under Test	
Device Type	COMOSAR 835 MHz REFERENCE DIPOLE
Manufacturer	Satimo
Model	SID835
Serial Number	SN 25/13 DIP 0G835-246
Product Condition (new / used)	New

A yearly calibration interval is recommended.

3 PRODUCT DESCRIPTION

3.1 GENERAL INFORMATION

Satimo's COMOSAR Validation Dipoles are built in accordance to the IEEE 1528, OET 65 Bulletin C and CEI/IEC 62209 standards. The product is designed for use with the COMOSAR test bench only.



Figure 1 – Satimo COMOSAR Validation Dipole

Page: 4/10

This document shall not be reproduced, except in full or in part, without the written approval of SATIMO. The information contained herein is to be used only for the purpose for which it is submitted and is not to be released in whole or part without written approval of SATIMO.



4 MEASUREMENT METHOD

The IEEE 1528, OET 65 Bulletin C and CEI/IEC 62209 standards provide requirements for reference dipoles used for system validation measurements. The following measurements were performed to verify that the product complies with the fore mentioned standards.

4.1 RETURN LOSS REQUIREMENTS

The dipole used for SAR system validation measurements and checks must have a return loss of -20 dB or better. The return loss measurement shall be performed against a liquid filled flat phantom, with the phantom constructed as outlined in the fore mentioned standards.

4.2 MECHANICAL REQUIREMENTS

The IEEE Std. 1528 and CEI/IEC 62209 standards specify the mechanical components and dimensions of the validation dipoles, with the dimensions frequency and phantom shell thickness dependent. The COMOSAR test bench employs a 2 mm phantom shell thickness therefore the dipoles sold for use with the COMOSAR test bench comply with the requirements set forth for a 2 mm phantom shell thickness.

5 MEASUREMENT UNCERTAINTY

All uncertainties listed below represent an expanded uncertainty expressed at approximately the 95% confidence level using a coverage factor of $k=2$, traceable to the Internationally Accepted Guides to Measurement Uncertainty.

5.1 RETURN LOSS

The following uncertainties apply to the return loss measurement:

Frequency band	Expanded Uncertainty on Return Loss
400-6000MHz	0.1 dB

5.2 DIMENSION MEASUREMENT

The following uncertainties apply to the dimension measurements:

Length (mm)	Expanded Uncertainty on Length
3 - 300	0.05 mm

5.3 VALIDATION MEASUREMENT

The guidelines outlined in the IEEE 1528, OET 65 Bulletin C, CENELEC EN50361 and CEI/IEC 62209 standards were followed to generate the measurement uncertainty for validation measurements.

Scan Volume	Expanded Uncertainty
1 g	20.3 %
10 g	20.1 %

Page: 3/10

*This document shall not be reproduced, except in full or in part, without the written approval of SATIMO.
The information contained therein is to be used only for the purpose for which it is submitted and is not to be released in whole or part without written approval of SATIMO.*

6 CALIBRATION MEASUREMENT RESULTS

6.1 RETURN LOSS

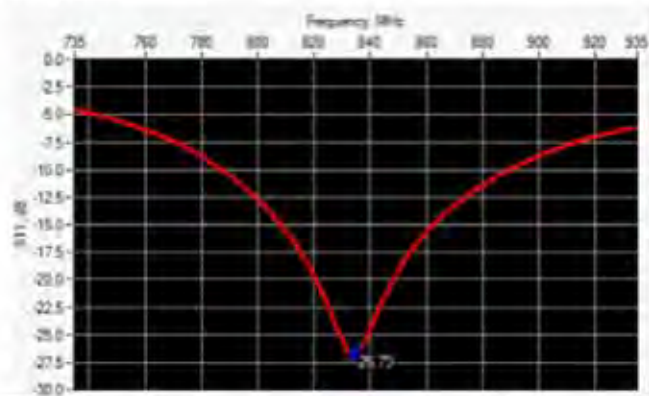

Frequency (MHz)	Return Loss (dB)	Requirement (dB)
835	-26.73	-20

6.2 MECHANICAL DIMENSIONS

Frequency MHz	L mm		h mm		d mm	
	required	measured	required	measured	required	measured
300	420.0 ±1 %		250.0 ±1 %		6.35 ±1 %	
450	290.0 ±1 %		166.7 ±1 %		6.35 ±1 %	
750	176.0 ±1 %		100.0 ±1 %		6.35 ±1 %	
835	161.0 ±1 %	PASS	89.8 ±1 %	PASS	3.6 ±1 %	PASS
900	149.0 ±1 %		83.3 ±1 %		3.6 ±1 %	
1450	89.1 ±1 %		51.7 ±1 %		3.6 ±1 %	
1500	80.5 ±1 %		50.0 ±1 %		3.6 ±1 %	
1640	79.0 ±1 %		45.7 ±1 %		3.6 ±1 %	
1750	75.2 ±1 %		42.9 ±1 %		3.6 ±1 %	
1800	72.0 ±1 %		41.7 ±1 %		3.6 ±1 %	
1900	68.0 ±1 %		39.5 ±1 %		3.6 ±1 %	
1950	66.3 ±1 %		38.5 ±1 %		3.6 ±1 %	
2000	64.5 ±1 %		37.5 ±1 %		3.6 ±1 %	
2100	61.0 ±1 %		35.7 ±1 %		3.6 ±1 %	
2300	55.5 ±1 %		32.6 ±1 %		3.6 ±1 %	
2450	51.5 ±1 %		30.4 ±1 %		3.6 ±1 %	
2600	48.5 ±1 %		28.8 ±1 %		3.6 ±1 %	
3000	41.5 ±1 %		25.0 ±1 %		3.6 ±1 %	
3500	37.0 ±1 %		26.4 ±1 %		3.6 ±1 %	
3700	34.7 ±1 %		26.4 ±1 %		3.6 ±1 %	

Page: 6/10

*This document shall not be reproduced, except in full or in part, without the written approval of SATIMO.
The information contained herein is to be used only for the purpose for which it is submitted and is not to be released in whole or part without written approval of SATIMO.*

7 VALIDATION MEASUREMENT

The IEEE Std. 1528, OET 65 Bulletin C and CEI/IEC 62209 standards state that the system validation measurements must be performed using a reference dipole meeting the fore mentioned return loss and mechanical dimension requirements. The validation measurement must be performed against a liquid filled flat phantom, with the phantom constructed as outlined in the fore mentioned standards. Per the standards, the dipole shall be positioned below the bottom of the phantom, with the dipole length centered and parallel to the longest dimension of the flat phantom, with the top surface of the dipole at the described distance from the bottom surface of the phantom.

7.1 MEASUREMENT CONDITION

Software	OPENSAR V4
Phantom	SN 20/09 SAM71
Probe	SN 18/11 EPG122
Liquid	Head Liquid Values: $\epsilon_{\text{eff}} = 42.6$ $\sigma = 0.88$
Distance between dipole center and liquid	15.0 mm
Area scan resolution	$dx=8\text{mm}/dy=8\text{mm}$
Zoon Scan Resolution	$dx=8\text{mm}/dy=8\text{mm}/dz=5\text{mm}$
Frequency	835 MHz
Input power	20 dBm
Liquid Temperature	21 °C
Lab Temperature	21 °C
Lab Humidity	45 %

7.2 HEAD LIQUID MEASUREMENT

Frequency MHz	Relative permittivity (ϵ_r)		Conductivity (σ) S/m	
	required	measured	required	measured
300	45.3 ±5 %		0.87 ±5 %	
450	43.5 ±5 %		0.87 ±5 %	
750	41.9 ±5 %		0.89 ±5 %	
835	41.5 ±5 %	PASS	0.90 ±5 %	PASS
900	41.5 ±5 %		0.97 ±5 %	
1450	40.5 ±5 %		1.20 ±5 %	
1500	40.4 ±5 %		1.23 ±5 %	
1640	40.2 ±5 %		1.31 ±5 %	
1750	40.1 ±5 %		1.37 ±5 %	
1800	40.0 ±5 %		1.40 ±5 %	
1900	40.0 ±5 %		1.40 ±5 %	
1950	40.0 ±5 %		1.40 ±5 %	
2000	40.0 ±5 %		1.40 ±5 %	
2100	39.8 ±5 %		1.49 ±5 %	
2300	39.5 ±5 %		1.67 ±5 %	
2450	39.2 ±5 %		1.80 ±5 %	
2600	39.0 ±5 %		1.96 ±5 %	
3000	38.5 ±5 %		2.40 ±5 %	
3500	37.9 ±5 %		2.91 ±5 %	

Page: 7/10

*This document shall not be reproduced, except in full or in part, without the written approval of SATIMO.
The information contained herein is to be used only for the purpose for which it is submitted and is not to be released in whole or part without written approval of SATIMO.*

7.3 MEASUREMENT RESULT

The IEEE Std. 1528 and CEI/IEC 62209 standards state that the system validation measurements should produce the SAR values shown below (for phantom thickness of 2 mm), within the uncertainty for the system validation. All SAR values are normalized to 1 W forward power. In bracket, the measured SAR is given with the used input power.

Frequency MHz	1 g SAR (W/kg/W)		10 g SAR (W/kg/W)	
	required	measured	required	measured
300	2.85		1.94	
450	4.58		3.06	
750	8.49		5.55	
835	9.56	9.71 (0.97)	6.22	6.21 (0.62)
900	10.9		6.99	
1450	29		16	
1500	30.5		16.8	
1640	34.2		18.4	
1750	36.4		19.3	
1800	38.4		20.1	
1900	39.7		20.5	
1950	40.5		20.9	
2000	41.1		21.1	
2100	43.6		21.3	
2300	48.7		23.3	
2450	52.4		24	
2600	55.3		24.6	
3000	63.8		25.7	
3500	67.1		25	

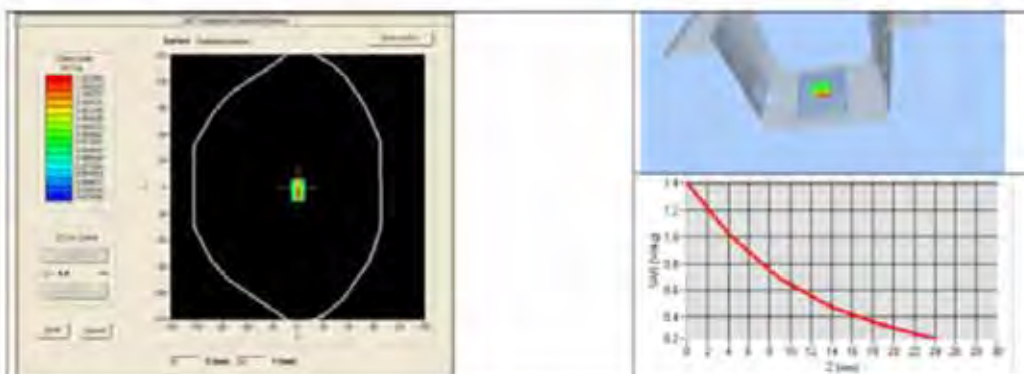

Page: 8/10

*This document shall not be reproduced, except in full or in part, without the written approval of SATIMO.
The information contained herein is to be used only for the purpose for which it is submitted and is not to be released in whole or part without written approval of SATIMO.*

7.4 BODY MEASUREMENT RESULT

Software	OPENSAR V4
Phantom	SN 20/09 SAM71
Probe	SN 18/11 EPG122
Liquid	Body Liquid Values: eps' : 55.3 sigma : 0.96
Distance between dipole center and liquid	15.0 mm
Area scan resolution	dx=8mm/dy=8mm
Zoon Scan Resolution	dx=8mm/dy=8mm/dz=5mm
Frequency	835 MHz
Input power	20 dBm
Liquid Temperature	21 °C
Lab Temperature	21 °C
Lab Humidity	45 %

Frequency MHz	1 g SAR (W/kg/W)	10 g SAR (W/kg/W)
	measured	measured
835	10.19 [1.02]	6.61 [0.66]

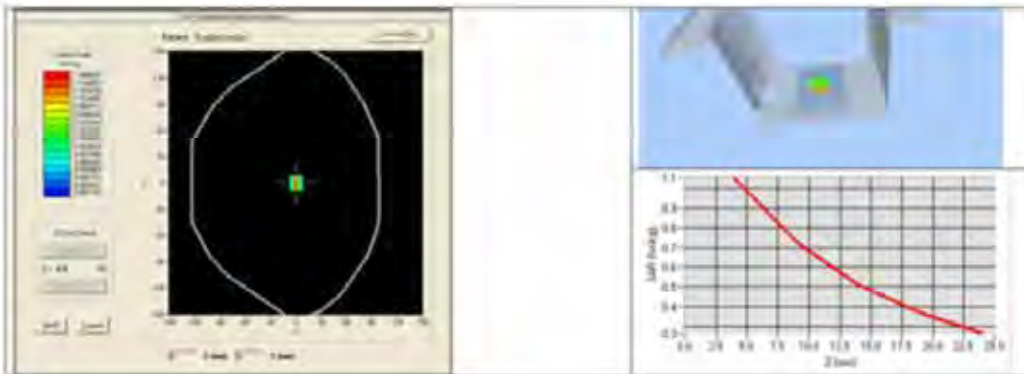

8 LIST OF EQUIPMENT

Equipment Summary Sheet				
Equipment Description	Manufacturer / Model	Identification No.	Current Calibration Date	Next Calibration Date
SAM Phantom	Satimo	SN-20/09-SAM71	Validated. No cal required.	Validated. No cal required.
COMOSAR Test Bench	Version 3	NA	Validated. No cal required.	Validated. No cal required.
Network Analyzer	Rhode & Schwarz ZVA	SN100132	02/2013	02/2016
Calipers	Carrera	CALIPER-01	12/2012	12/2015
Reference Probe	Satimo	EPG122 SN 18/11	Characterized prior to test. No cal required.	Characterized prior to test. No cal required.
Multimeter	Keithley 2000	1188656	11/2012	11/2015
Signal Generator	Agilent E4438C	MY49070581	12/2012	12/2015
Amplifier	Aethercomm	SN 046	Characterized prior to test. No cal required.	Characterized prior to test. No cal required.
Power Meter	HP E4418A	US38261498	11/2012	11/2015
Power Sensor	HP ECP-E26A	US37181460	11/2012	11/2015
Directional Coupler	Narda 4216-20	01386	Characterized prior to test. No cal required.	Characterized prior to test. No cal required.
Temperature and Humidity Sensor	Control Company	11-861-9	3/2013	3/2015

Page: 10/10

*This document shall not be reproduced, except in full or in part, without the written approval of SATIMO.
The information contained herein is to be used only for the purpose for which it is submitted and is not to be released in whole or part without written approval of SATIMO.*



SAR Reference Dipole Calibration Report

Ref: ACR.219.7.13.SATU.A

SHENZHEN BALUN TECHNOLOGY CO., LTD.
BLOCK B, FL 1, BAISHA SCIENCE AND TECHNOLOGY
PARK, SHAHE XI ROAD, NANSHAN DISTRICT,
SHENZHEN, GUANGDONG PROVINCE, 518055 P. R. CHINA
SATIMO COMOSAR REFERENCE DIPOLE
FREQUENCY: 1900 MHZ
SERIAL NO.: SN 25/13 DIP 1G900-249

Calibrated at SATIMO US
2105 Barrett Park Dr. - Kennesaw, GA 30144



17/08/2014



Summary:

This document presents the method and results from an accredited SAR reference dipole calibration performed in SATIMO USA using the COMOSAR test bench. All calibration results are traceable to national metrology institutions.



SAR REFERENCE DIPOLE CALIBRATION REPORT

RfC ACR.2107.11.SATIM.A

	<i>Name</i>	<i>Function</i>	<i>Date</i>	<i>Signature</i>
<i>Prepared by :</i>	Jérôme LUC	Product Manager	8/17/2014	
<i>Checked by :</i>	Jérôme LUC	Product Manager	8/17/2014	
<i>Approved by :</i>	Kim RUTKOWSKI	Quality Manager	8/17/2014	

<i>Distribution :</i>	<i>Customer Name</i> Shenzhen Balun Technology Co.,Ltd.
-----------------------	--

<i>Issue</i>	<i>Date</i>	<i>Modifications</i>
A	8/17/2014	Initial release

Page: 2/10

*This document shall not be reproduced, except in full or in part, without the written approval of SATIMO.
The information contained herein is to be used only for the purpose for which it is submitted and is not to be released in whole or part without written approval of SATIMO.*

TABLE OF CONTENTS

1	Introduction.....	4
2	Device Under Test	4
3	Product Description	4
3.1	General Information	4
4	Measurement Method	5
4.1	Return Loss Requirements	5
4.2	Mechanical Requirements	5
5	Measurement Uncertainty	5
5.1	Return Loss	5
5.2	Dimension Measurement	5
5.3	Validation Measurement	5
6	Calibration Measurement Results	6
6.1	Return Loss	6
6.2	Mechanical Dimensions	6
7	Validation measurement	7
7.1	Measurement Condition	7
7.2	Head Liquid Measurement	7
7.3	Measurement Result	8
7.4	Body Measurement Result	9
8	List of Equipment	10

Page: 3/10

*This document shall not be reproduced, except in full or in part, without the written approval of SATIMO.
The information contained herein is to be used only for the purpose for which it is submitted and is not to
be released in whole or part without written approval of SATIMO.*

1 INTRODUCTION

This document contains a summary of the requirements set forth by the IEEE 1528, OET 65 Bulletin C and CEI/IEC 62209 standards for reference dipoles used for SAR measurement system validations and the measurements that were performed to verify that the product complies with the fore mentioned standards.

2 DEVICE UNDER TEST

Device Under Test	
Device Type	COMOSAR 1900 MHz REFERENCE DIPOLE
Manufacturer	Satimo
Model	SID1900
Serial Number	SN 25/13 DIP 1G900-249
Product Condition (new / used)	New

A yearly calibration interval is recommended.

3 PRODUCT DESCRIPTION

3.1 GENERAL INFORMATION

Satimo's COMOSAR Validation Dipoles are built in accordance to the IEEE 1528, OET 65 Bulletin C and CEI/IEC 62209 standards. The product is designed for use with the COMOSAR test bench only.



Figure 1 – Satimo COMOSAR Validation Dipole

Page: 4/10

*This document shall not be reproduced, except in full or in part, without the written approval of SATIMO.
The information contained herein is to be used only for the purpose for which it is submitted and is not to be released in whole or part without written approval of SATIMO.*

4 MEASUREMENT METHOD

The IEEE 1528, OET 65 Bulletin C and CEI/IEC 62209 standards provide requirements for reference dipoles used for system validation measurements. The following measurements were performed to verify that the product complies with the fore mentioned standards.

4.1 RETURN LOSS REQUIREMENTS

The dipole used for SAR system validation measurements and checks must have a return loss of -20 dB or better. The return loss measurement shall be performed against a liquid filled flat phantom, with the phantom constructed as outlined in the fore mentioned standards.

4.2 MECHANICAL REQUIREMENTS

The IEEE Std. 1528 and CEI/IEC 62209 standards specify the mechanical components and dimensions of the validation dipoles, with the dimensions frequency and phantom shell thickness dependent. The COMOSAR test bench employs a 2 mm phantom shell thickness therefore the dipoles sold for use with the COMOSAR test bench comply with the requirements set forth for a 2 mm phantom shell thickness.

5 MEASUREMENT UNCERTAINTY

All uncertainties listed below represent an expanded uncertainty expressed at approximately the 95% confidence level using a coverage factor of $k=2$, traceable to the Internationally Accepted Guides to Measurement Uncertainty.

5.1 RETURN LOSS

The following uncertainties apply to the return loss measurement:

Frequency band	Expanded Uncertainty on Return Loss
400-6000MHz	0.1 dB

5.2 DIMENSION MEASUREMENT

The following uncertainties apply to the dimension measurements:

Length (mm)	Expanded Uncertainty on Length
3 - 300	0.05 mm

5.3 VALIDATION MEASUREMENT

The guidelines outlined in the IEEE 1528, OET 65 Bulletin C, CENELEC EN50361 and CEI/IEC 62209 standards were followed to generate the measurement uncertainty for validation measurements.

Scan Volume	Expanded Uncertainty
1 g	20.3 %
10 g	20.1 %

Page: 3/10

*This document shall not be reproduced, stored in full or in part, without the written approval of SATIMO.
The information contained herein is to be used only for the purpose for which it is submitted and is not to be released in whole or part without written approval of SATIMO.*



6 CALIBRATION MEASUREMENT RESULTS

6.1 RETURN LOSS

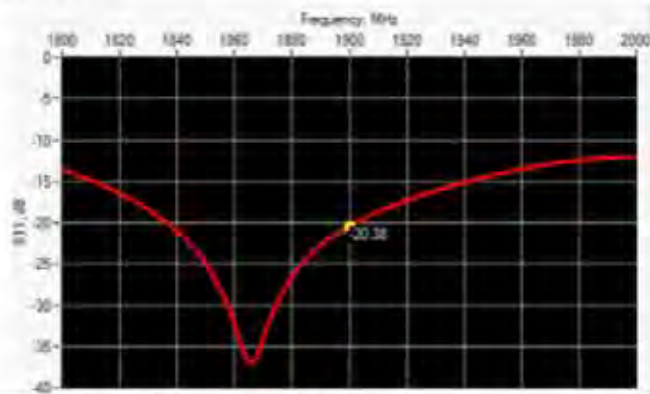

Frequency (MHz)	Return Loss (dB)	Requirement (dB)
1900	-20.38	-20

6.2 MECHANICAL DIMENSIONS

Frequency MHz	L mm		h mm		d mm	
	required	measured	required	measured	required	measured
300	420.0 ±1 %		250.0 ±1 %		6.35 ±1 %	
450	290.0 ±1 %		166.7 ±1 %		6.35 ±1 %	
750	176.0 ±1 %		100.0 ±1 %		6.35 ±1 %	
835	161.0 ±1 %		89.8 ±1 %		3.6 ±1 %	
900	149.0 ±1 %		83.3 ±1 %		3.6 ±1 %	
1450	89.1 ±1 %		51.7 ±1 %		3.6 ±1 %	
1500	80.5 ±1 %		50.0 ±1 %		3.6 ±1 %	
1640	79.0 ±1 %		45.7 ±1 %		3.6 ±1 %	
1750	75.2 ±1 %		42.9 ±1 %		3.6 ±1 %	
1800	72.0 ±1 %		41.7 ±1 %		3.6 ±1 %	
1900	68.0 ±1 %	PASS	39.5 ±1 %	PASS	3.6 ±1 %	PASS
1950	66.3 ±1 %		38.5 ±1 %		3.6 ±1 %	
2000	64.5 ±1 %		37.5 ±1 %		3.6 ±1 %	
2100	61.0 ±1 %		35.7 ±1 %		3.6 ±1 %	
2300	55.5 ±1 %		32.6 ±1 %		3.6 ±1 %	
2450	51.5 ±1 %		30.4 ±1 %		3.6 ±1 %	
2600	48.5 ±1 %		28.8 ±1 %		3.6 ±1 %	
3000	41.5 ±1 %		25.0 ±1 %		3.6 ±1 %	
3500	37.0 ±1 %		26.4 ±1 %		3.6 ±1 %	
3700	34.7 ±1 %		26.4 ±1 %		3.6 ±1 %	

7 VALIDATION MEASUREMENT

The IEEE Std. 1528, OET 65 Bulletin C and CEI/IEC 62209 standards state that the system validation measurements must be performed using a reference dipole meeting the fore mentioned return loss and mechanical dimension requirements. The validation measurement must be performed against a liquid filled flat phantom, with the phantom constructed as outlined in the fore mentioned standards. Per the standards, the dipole shall be positioned below the bottom of the phantom, with the dipole length centered and parallel to the longest dimension of the flat phantom, with the top surface of the dipole at the described distance from the bottom surface of the phantom.

7.1 MEASUREMENT CONDITION

Software	OPENSAR V4
Phantom	SN 20-09 SAM71
Probe	SN 18/11 EPG122
Liquid	Head Liquid Values: $\epsilon_p^* : 39.8$ $\sigma : 1.43$
Distance between dipole center and liquid	10.0 mm
Area scan resolution	$dx=8mm$ $dy=8mm$
Zoon Scan Resolution	$dx=8mm$ $dy=8mm$ $dz=5mm$
Frequency	1900 MHz
Input power	20 dBm
Liquid Temperature	21 °C
Lab Temperature	21 °C
Lab Humidity	45 %

7.2 HEAD LIQUID MEASUREMENT

Frequency MHz	Relative permittivity (ϵ_r^*)		Conductivity (σ) S/m	
	required	measured	required	measured
300	45.3 \pm 5 %		0.87 \pm 5 %	
450	43.5 \pm 5 %		0.87 \pm 5 %	
750	41.9 \pm 5 %		0.89 \pm 5 %	
835	41.5 \pm 5 %		0.90 \pm 5 %	
900	41.5 \pm 5 %		0.97 \pm 5 %	
1450	40.5 \pm 5 %		1.20 \pm 5 %	
1500	40.4 \pm 5 %		1.23 \pm 5 %	
1640	40.2 \pm 5 %		1.31 \pm 5 %	
1750	40.1 \pm 5 %		1.37 \pm 5 %	
1800	40.0 \pm 5 %		1.40 \pm 5 %	
1900	40.0 \pm 5 %	PASS	1.40 \pm 5 %	PASS
1950	40.0 \pm 5 %		1.40 \pm 5 %	
2000	40.0 \pm 5 %		1.40 \pm 5 %	
2100	39.8 \pm 5 %		1.49 \pm 5 %	
2300	39.5 \pm 5 %		1.67 \pm 5 %	
2450	39.2 \pm 5 %		1.80 \pm 5 %	
2600	39.0 \pm 5 %		1.96 \pm 5 %	
3000	38.5 \pm 5 %		2.40 \pm 5 %	
3500	37.9 \pm 5 %		2.91 \pm 5 %	

Page: 7/10

*This document shall not be reproduced, except in full or in part, without the written approval of SATIMO.
The information contained herein is to be used only for the purpose for which it is submitted and is not to be released in whole or part without written approval of SATIMO.*

7.3 MEASUREMENT RESULT

The IEEE Std. 1528 and CEI/IEC 62209 standards state that the system validation measurements should produce the SAR values shown below (for phantom thickness of 2 mm), within the uncertainty for the system validation. All SAR values are normalized to 1 W forward power. In bracket, the measured SAR is given with the used input power.

Frequency MHz	1 g SAR (W/kg/W)		10 g SAR (W/kg/W)	
	required	measured	required	measured
300	2.85		1.94	
450	4.58		3.06	
750	8.49		5.55	
835	9.56		6.22	
900	10.9		6.99	
1450	29		16	
1500	30.5		16.8	
1640	34.2		18.4	
1750	36.4		19.3	
1800	38.4		20.1	
1900	39.7	40.01 (4.00)	20.5	20.42 (2.04)
1950	40.5		20.9	
2000	41.1		21.1	
2100	43.6		21.8	
2300	48.7		23.3	
2450	52.4		24	
2600	55.3		24.6	
3000	63.8		25.7	
3500	67.1		25	

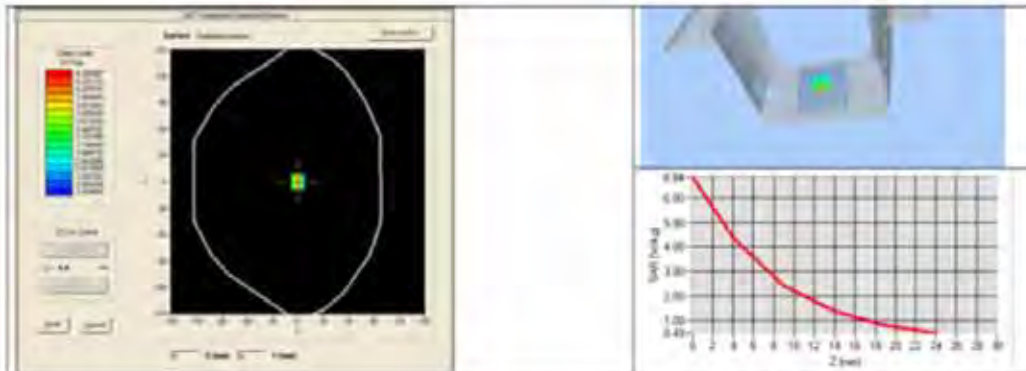

7.4 BODY MEASUREMENT RESULT

Software	OPENSAR V4
Phantom	SN 20/09 SAM71
Probe	SN 18/11 EPG122
Liquid	Body Liquid Values: $\epsilon_{ps}^* : 52.5$ $\sigma : 1.50$
Distance between dipole center and liquid	10.0 mm
Area scan resolution	$dx=8mm/dy=8mm$
Zoon Scan Resolution	$dx=8mm/dy=8mm/dz=5mm$
Frequency	1900 MHz
Input power	20 dBm
Liquid Temperature	21 °C
Lab Temperature	21 °C
Lab Humidity	45 %

Frequency MHz	1 g SAR (W/kg/W)	10 g SAR (W/kg/W)
	measured	measured
1900	40.32 (4.03)	21.15 (2.11)

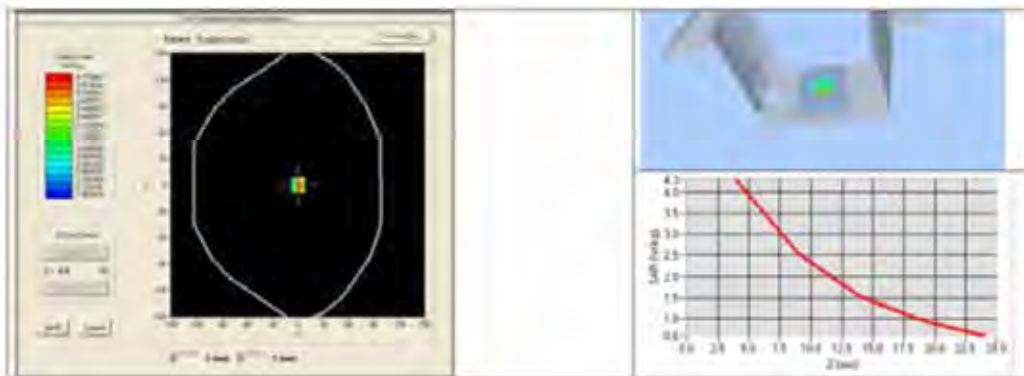

Page: 9/10

*This document shall not be reproduced, except in full or in part, without the written approval of SATIMO.
The information contained herein is to be used only for the purpose for which it is submitted and is not to be released in whole or part without written approval of SATIMO.*

8 LIST OF EQUIPMENT

Equipment Summary Sheet				
Equipment Description	Manufacturer / Model	Identification No.	Current Calibration Date	Next Calibration Date
SAM Phantom	Satimo	SN-20/09-SAM71	Validated. No cal required.	Validated. No cal required.
COMOSAR Test Bench	Version 3	NA	Validated. No cal required.	Validated. No cal required.
Network Analyzer	Rhode & Schwarz ZVA	SN100132	02/2013	02/2016
Calipers	Carrera	CALIPER-01	12/2012	12/2015
Reference Probe	Satimo	EPG122 SN 18/11	Characterized prior to test. No cal required.	Characterized prior to test. No cal required.
Multimeter	Keithley 2000	1188656	11/2012	11/2015
Signal Generator	Agilent E4438C	MY49070581	12/2012	12/2015
Amplifier	Aethercomm	SN 046	Characterized prior to test. No cal required.	Characterized prior to test. No cal required.
Power Meter	HP E4418A	US38261498	11/2012	11/2015
Power Sensor	HP ECP-E26A	US37181460	11/2012	11/2015
Directional Coupler	Narda 4216-20	01386	Characterized prior to test. No cal required.	Characterized prior to test. No cal required.
Temperature and Humidity Sensor	Control Company	11-881-9	3/2013	3/2015



SAR Reference Dipole Calibration Report

Ref: ACR.219.9.13.SATU.A

SHENZHEN BALUN TECHNOLOGY CO., LTD.
BLOCK B, FL 1, BAISHA SCIENCE AND TECHNOLOGY
PARK, SHAHE XI ROAD, NANSHAN DISTRICT,
SHENZHEN, GUANGDONG PROVINCE, 518055 P. R. CHINA
SATIMO COMOSAR REFERENCE DIPOLE
FREQUENCY: 2450 MHZ
SERIAL NO.: SN 25/13 DIP 2G450-251

Calibrated at SATIMO US
2105 Barrett Park Dr. - Kennesaw, GA 30144



17/08/2014



Summary:

This document presents the method and results from an accredited SAR reference dipole calibration performed in SATIMO USA using the COMOSAR test bench. All calibration results are traceable to national metrology institutions.



SAR REFERENCE DIPOLE CALIBRATION REPORT

Rpt ACR.2119.13.SATIM.A

	<i>Name</i>	<i>Function</i>	<i>Date</i>	<i>Signature</i>
<i>Prepared by :</i>	Jérôme LUC	Product Manager	8/17/2014	
<i>Checked by :</i>	Jérôme LUC	Product Manager	8/17/2014	
<i>Approved by :</i>	Kim RUTKOWSKI	Quality Manager	8/17/2014	

	<i>Customer Name</i>
<i>Distribution :</i>	Shenzhen Balun Technology Co.,Ltd.

<i>Issue</i>	<i>Date</i>	<i>Modifications</i>
A	8/17/2014	Initial release

Page: 2/10

*This document shall not be reproduced, except in full or in part, without the written approval of SATIMO.
The information contained herein is to be used only for the purpose for which it is submitted and is not to be released in whole or part without written approval of SATIMO.*



TABLE OF CONTENTS

1	Introduction.....	4
2	Device Under Test	4
3	Product Description	4
3.1	General Information	4
4	Measurement Method	5
4.1	Return Loss Requirements	5
4.2	Mechanical Requirements	5
5	Measurement Uncertainty	5
5.1	Return Loss	5
5.2	Dimension Measurement	5
5.3	Validation Measurement	5
6	Calibration Measurement Results	6
6.1	Return Loss	6
6.2	Mechanical Dimensions	6
7	Validation measurement	7
7.1	Measurement Condition	7
7.2	Head Liquid Measurement	7
7.3	Measurement Result	8
7.4	Body Measurement Result	9
8	List of Equipment	10

Page: 3/10

*This document shall not be reproduced, except in full or in part, without the written approval of SATIMO.
The information contained herein is to be used only for the purpose for which it is submitted and is not to
be released in whole or part without written approval of SATIMO.*



1 INTRODUCTION

This document contains a summary of the requirements set forth by the IEEE 1528, OET 65 Bulletin C and CEI/IEC 62209 standards for reference dipoles used for SAR measurement system validations and the measurements that were performed to verify that the product complies with the fore mentioned standards.

2 DEVICE UNDER TEST

Device Under Test	
Device Type	COMOSAR 2450 MHz REFERENCE DIPOLE
Manufacturer	Satimo
Model	SID2450
Serial Number	SN 25/13 DIP 2G450-251
Product Condition (new / used)	New

A yearly calibration interval is recommended.

3 PRODUCT DESCRIPTION

3.1 GENERAL INFORMATION

Satimo’s COMOSAR Validation Dipoles are built in accordance to the IEEE 1528, OET 65 Bulletin C and CEI/IEC 62209 standards. The product is designed for use with the COMOSAR test bench only.



Figure 1 – Satimo COMOSAR Validation Dipole

4 MEASUREMENT METHOD

The IEEE 1528, OET 65 Bulletin C and CEI/IEC 62209 standards provide requirements for reference dipoles used for system validation measurements. The following measurements were performed to verify that the product complies with the fore mentioned standards.

4.1 RETURN LOSS REQUIREMENTS

The dipole used for SAR system validation measurements and checks must have a return loss of -20 dB or better. The return loss measurement shall be performed against a liquid filled flat phantom, with the phantom constructed as outlined in the fore mentioned standards.

4.2 MECHANICAL REQUIREMENTS

The IEEE Std. 1528 and CEI/IEC 62209 standards specify the mechanical components and dimensions of the validation dipoles, with the dimensions frequency and phantom shell thickness dependent. The COMOSAR test bench employs a 2 mm phantom shell thickness therefore the dipoles sold for use with the COMOSAR test bench comply with the requirements set forth for a 2 mm phantom shell thickness.

5 MEASUREMENT UNCERTAINTY

All uncertainties listed below represent an expanded uncertainty expressed at approximately the 95% confidence level using a coverage factor of $k=2$, traceable to the Internationally Accepted Guides to Measurement Uncertainty.

5.1 RETURN LOSS

The following uncertainties apply to the return loss measurement:

Frequency band	Expanded Uncertainty on Return Loss
400-6000MHz	0,1 dB

5.2 DIMENSION MEASUREMENT

The following uncertainties apply to the dimension measurements:

Length (mm)	Expanded Uncertainty on Length
3 - 300	0,05 mm

5.3 VALIDATION MEASUREMENT

The guidelines outlined in the IEEE 1528, OET 65 Bulletin C, CENELEC EN50361 and CEI/IEC 62209 standards were followed to generate the measurement uncertainty for validation measurements.

Scan Volume	Expanded Uncertainty
1 g	20,3 %
10 g	20,1 %

Page: 3/10

*This document shall not be reproduced, except in full or in part, without the written approval of SATIMO.
The information contained herein is to be used only for the purpose for which it is submitted and is not to be released in whole or part without written approval of SATIMO.*



6 CALIBRATION MEASUREMENT RESULTS

6.1 RETURN LOSS

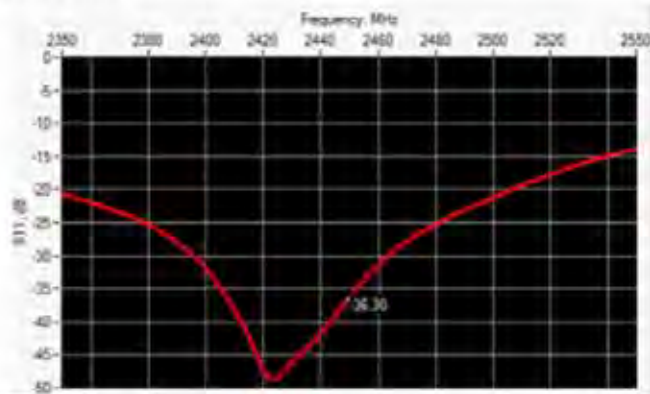

Frequency (MHz)	Return Loss (dB)	Requirement (dB)
2450	-36.30	-20

6.2 MECHANICAL DIMENSIONS

Frequency MHz	l mm		h mm		d mm	
	required	measured	required	measured	required	measured
300	420.0 ±1 %		250.0 ±1 %		6.35 ±1 %	
450	290.0 ±1 %		166.7 ±1 %		6.35 ±1 %	
750	176.0 ±1 %		100.0 ±1 %		6.35 ±1 %	
835	161.0 ±1 %		89.8 ±1 %		3.6 ±1 %	
900	149.0 ±1 %		83.3 ±1 %		3.6 ±1 %	
1450	89.1 ±1 %		51.7 ±1 %		3.6 ±1 %	
1500	80.5 ±1 %		50.0 ±1 %		3.6 ±1 %	
1640	79.0 ±1 %		45.7 ±1 %		3.6 ±1 %	
1750	75.2 ±1 %		42.9 ±1 %		3.6 ±1 %	
1800	72.0 ±1 %		41.7 ±1 %		3.6 ±1 %	
1900	68.0 ±1 %		39.5 ±1 %		3.6 ±1 %	
1950	66.3 ±1 %		38.5 ±1 %		3.6 ±1 %	
2000	64.5 ±1 %		37.5 ±1 %		3.6 ±1 %	
2100	61.0 ±1 %		35.7 ±1 %		3.6 ±1 %	
2300	55.5 ±1 %		32.6 ±1 %		3.6 ±1 %	
2450	51.5 ±1 %	PASS	30.4 ±1 %	PASS	3.6 ±1 %	PASS
2600	48.5 ±1 %		28.8 ±1 %		3.6 ±1 %	
3000	41.5 ±1 %		25.0 ±1 %		3.6 ±1 %	
3500	37.0 ±1 %		26.4 ±1 %		3.6 ±1 %	
3700	34.7 ±1 %		26.4 ±1 %		3.6 ±1 %	

7 VALIDATION MEASUREMENT

The IEEE Std. 1528, OET 65 Bulletin C and CEI/IEC 62209 standards state that the system validation measurements must be performed using a reference dipole meeting the fore mentioned return loss and mechanical dimension requirements. The validation measurement must be performed against a liquid filled flat phantom, with the phantom constructed as outlined in the fore mentioned standards. Per the standards, the dipole shall be positioned below the bottom of the phantom, with the dipole length centered and parallel to the longest dimension of the flat phantom, with the top surface of the dipole at the described distance from the bottom surface of the phantom.

7.1 MEASUREMENT CONDITION

Software	OPENSAR V4
Phantom	SN 20/09 SAM71
Probe	SN 18/11 EPG122
Liquid	Head Liquid Values: $\epsilon_{p\prime}$: 38.6 σ : 1.82
Distance between dipole center and liquid	10.0 mm
Area scan resolution	$dx=8mm/dy=8mm$
Zoon Scan Resolution	$dx=8mm/dy=8m/dz=5mm$
Frequency	2450 MHz
Input power	20 dBm
Liquid Temperature	21 °C
Lab Temperature	21 °C
Lab Humidity	45 %

7.2 HEAD LIQUID MEASUREMENT

Frequency MHz	Relative permittivity (ϵ_r)		Conductivity (σ) S/m	
	required	measured	required	measured
300	45.3 ±5 %		0.87 ±5 %	
450	43.5 ±5 %		0.87 ±5 %	
750	41.9 ±5 %		0.89 ±5 %	
835	41.5 ±5 %		0.90 ±5 %	
900	41.5 ±5 %		0.97 ±5 %	
1450	40.5 ±5 %		1.20 ±5 %	
1500	40.4 ±5 %		1.23 ±5 %	
1640	40.2 ±5 %		1.31 ±5 %	
1750	40.1 ±5 %		1.37 ±5 %	
1800	40.0 ±5 %		1.40 ±5 %	
1900	40.0 ±5 %		1.40 ±5 %	
1950	40.0 ±5 %		1.40 ±5 %	
2000	40.0 ±5 %		1.40 ±5 %	
2100	39.8 ±5 %		1.49 ±5 %	
2300	39.5 ±5 %		1.67 ±5 %	
2450	39.2 ±5 %	PASS	1.80 ±5 %	PASS
2500	39.0 ±5 %		1.96 ±5 %	
3000	38.5 ±5 %		2.40 ±5 %	
3500	37.9 ±5 %		2.91 ±5 %	

Page: 7/10

*This document shall not be reproduced, except in full or in part, without the written approval of SATIMO.
The information contained herein is to be used only for the purpose for which it is submitted and is not to be released in whole or part without written approval of SATIMO.*

7.3 MEASUREMENT RESULT

The IEEE Std. 1528 and CEI/IEC 62209 standards state that the system validation measurements should produce the SAR values shown below (for phantom thickness of 2 mm), within the uncertainty for the system validation. All SAR values are normalized to 1 W forward power. In bracket, the measured SAR is given with the used input power.

Frequency MHz	1 g SAR (W/kg/W)		10 g SAR (W/kg/W)	
	required	measured	required	measured
300	2.85		1.94	
450	4.58		3.06	
750	8.49		5.55	
835	9.56		6.22	
900	10.9		6.99	
1450	29		16	
1500	30.5		16.8	
1640	34.2		18.4	
1750	36.4		19.8	
1800	38.4		20.1	
1900	39.7		20.5	
1950	40.5		20.9	
2000	41.1		21.1	
2100	43.6		21.8	
2300	48.7		23.3	
2450	52.4	53.96 (5.40)	24	23.92 (2.39)
2600	55.3		24.6	
3000	63.8		25.7	
3500	67.1		25	

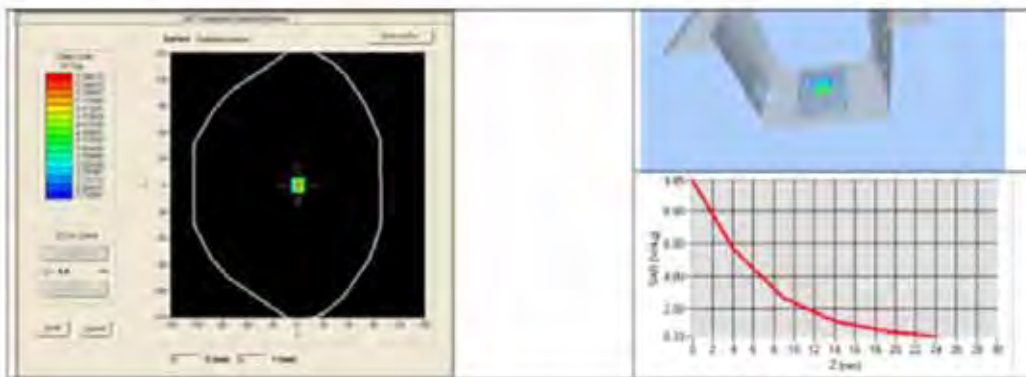



7.4 BODY MEASUREMENT RESULT

Software	OPENSAR V4
Phantom	SN 20/09 SAM71
Probe	SN 18/11 EPG122
Liquid	Body Liquid Values: $\epsilon_{ps} = 52.0$ $\sigma = 1.94$
Distance between dipole center and liquid	10.0 mm
Area scan resolution	$dx=8mm/dy=8mm$
Zoon Scan Resolution	$dx=8mm/dy=8m/dz=5mm$
Frequency	2450 MHz
Input power	20 dBm
Liquid Temperature	21 °C
Lab Temperature	21 °C
Lab Humidity	45 %

Frequency MHz	1 g SAR (W/kg/W)	10 g SAR (W/kg/W)
	measured	measured
2450	52.37 (5.24)	24.26 (2.43)

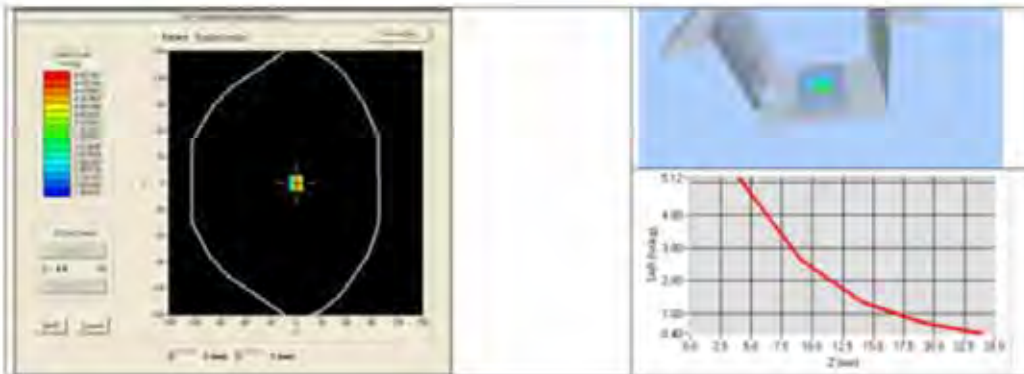

8 LIST OF EQUIPMENT

Equipment Summary Sheet				
Equipment Description	Manufacturer / Model	Identification No.	Current Calibration Date	Next Calibration Date
SAM Phantom	Satimo	SN-20/09-SAM71	Validated. No cal required.	Validated. No cal required.
COMOSAR Test Bench	Version 3	NA	Validated. No cal required.	Validated. No cal required.
Network Analyzer	Rhode & Schwarz ZVA	SN100132	02/2013	02/2016
Calipers	Carrera	CALIPER-01	12/2012	12/2015
Reference Probe	Satimo	EPG122 SN 18/11	Characterized prior to test. No cal required.	Characterized prior to test. No cal required.
Multimeter	Keithley 2000	1188656	11/2012	11/2015
Signal Generator	Agilent E4438C	MY49070581	12/2012	12/2015
Amplifier	Aethercomm	SN 046	Characterized prior to test. No cal required.	Characterized prior to test. No cal required.
Power Meter	HP E4418A	US38261498	11/2012	11/2015
Power Sensor	HP ECP-E26A	US37181460	11/2012	11/2015
Directional Coupler	Narda 4216-20	01386	Characterized prior to test. No cal required.	Characterized prior to test. No cal required.
Temperature and Humidity Sensor	Control Company	11-661-9	3/2013	3/2015

Page: 10/10

*This document shall not be reproduced, except in full or in part, without the written approval of SATIMO.
The information contained herein is to be used only for the purpose for which it is submitted and is not to be released in whole or part without written approval of SATIMO.*

--END OF REPORT--