

FCC PART 15 SUBPART C TEST REPORT**FCC PART 15.247****Report Reference No.....: A1411096077-WLAN****FCC ID..... : 2ACWO-HC7-S**

Compiled by

(position+printed name+signature)..: File administrators Tony Li

Supervised by

(position+printed name+signature)..: Technique principal Robin Fang

Approved by

(position+printed name+signature)..: Manager James Wu

Date of issue.....: Nov,28 2014

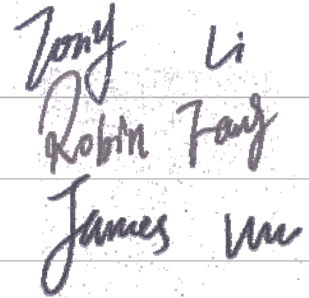

Representative Laboratory Name: Shenzhen CTL Electron Technology Co., Ltd.

Address: A0402, Block 1, Kefa Industrial District, Huanguan Nan Rd, Xintian community, Guanlan, Baoan, Shenzhen, China

Testing Laboratory Name: Dongguan Dongdian Testing Service Co.,Ltd

Address: No.17, Zongbu Road 2, Songshan Lake Sci&Tech, Industry Park, Dongguan City, Guangdong Province, China

Applicant's name.....: AURA TECHNOLOGY LIMITED

Address: FLAT/RM810, Star House, 3 Salisbury Road, Tsimshatsui, Hong Kong

Test specificationStandard: **FCC Part 15.247: Operation within the bands 902-928 MHz, 2400-2483.5 MHz and 5725-5850 MHz**

TRF Originator.....: Shenzhen CTL Electron Technology Co., Ltd.

Master TRF.....: Dated 2012-06

Shenzhen CTL Electron Technology Co., Ltd. All rights reserved.

This publication may be reproduced in whole or in part for non-commercial purposes as long as the Shenzhen CTL Electron Technology Co., Ltd. is acknowledged as copyright owner and source of the material. Shenzhen CTL Electron Technology Co., Ltd. takes no responsibility for and will not assume liability for damages resulting from the reader's interpretation of the reproduced material due to its placement and context.

Test item description: Telpad

Trade Mark: /

Model/Type reference.....: HC7

Listed Models: /

Manufacturer: **SHENZHEN KWANG SUNG ELECTRONICS CO.,LTD**

Operation Frequency.....: From 2412MHz to 2462MHz

Rating: DC3.70V/DC 5.6V Adapter from AC 120V/60Hz

Result.....: **PASS**

TEST REPORT

Test Report No. :	A1411096077-WLAN	Nov,28 2014
		Date of issue

Equipment under Test : Telpad

Model /Type : HC7

Listed Models : /

Applicant : **AURA TECHNOLOGY LIMITED**

Address : FLAT/RM810, Star House, 3 Salisbury Road, Tsimshatsui,
Hong Kong

Manufacturer : **SHENZHEN KWANG SUNG ELECTRONICS CO.,LTD**

Address : Shitoushan Industrial Zone, Shi Yan Town, Baoan District,
Shenzhen, PRC

Test Result:	PASS
---------------------	-------------

The test report merely corresponds to the test sample.

It is not permitted to copy extracts of these test result without the written permission of the test laboratory.

Contents

1.	<u>TEST STANDARDS.....</u>	4
2.	<u>SUMMARY</u>	5
2.1.	General Remarks	5
2.2.	Product Description	5
2.3.	Equipment Under Test	5
2.4.	Short description of the Equipment under Test (EUT)	5
2.5.	EUT operation mode	5
2.6.	Block Diagram of Test Setup	6
2.7.	Related Submittal(s) / Grant (s)	6
2.8.	Modifications	6
2.9.	NOTE	6
3.	<u>TEST ENVIRONMENT.....</u>	7
3.1.	Address of the test laboratory	7
3.2.	Test Facility	7
3.3.	Environmental conditions	7
3.4.	Test Description	7
3.5.	Statement of the measurement uncertainty	8
3.6.	Equipments Used during the Test	8
4.	<u>TEST CONDITIONS AND RESULTS.....</u>	10
4.1.	AC Power Conducted Emission	10
4.2.	Radiated Emission.....	13
4.3.	Maximum Peak Output Power.....	22
4.4.	Power Spectral Density	23
4.5.	6dB Bandwidth	32
4.6.	Band Edge Compliance of RF Emission	41
4.7.	Spurious RF Conducted Emission	52
4.8.	Antenna Requirement.....	77
5.	<u>TEST SETUP PHOTOS OF THE EUT</u>	78
6.	<u>EXTERNAL AND INTERNAL PHOTOS OF THE EUT</u>	79

1. TEST STANDARDS

The tests were performed according to following standards:

[FCC Rules Part 15.247](#): Frequency Hopping, Direct Spread Spectrum and Hybrid Systems that are in operation within the bands of 902-928 MHz, 2400-2483.5 MHz, and 5725-5850 MHz.

[ANSI C63.10-2009](#): American National Standard for Testing Unlicensed Wireless Devices

[KDB558074 D01 V03r02](#): Guidance for Performing Compliance Measurements on Digital Transmission Systems (DTS) Operating Under §15.247

2. SUMMARY

2.1. General Remarks

Date of receipt of test sample	:	Nov 14, 2014
Testing commenced on	:	Nov 14, 2014
Testing concluded on	:	Nov 26, 2014

2.2. Product Description

The **AURA TECHNOLOGY LIMITED**'s Model: HC7 or the "EUT" as referred to in this report; more general information as follows, for more details, refer to the user's manual of the EUT.

Name of EUT	Telpad
Model Number	HC7
FCC ID	2ACWO-HC7-S
WLAN	Supported 802.11b/802.11g/802.11n
Bluetooth	Supported BT 2.1+EDR
Antenna Type	Internal
WLAN FCC Operation frequency	IEEE 802.11b: 2412MHz—2462MHz IEEE 802.11g: 2412MHz—2462MHz IEEE 802.11n HT20: 2412MHz—2462MHz IEEE 802.11n HT40: 2422MHz—2452MHz
Bluetooth FCC Operation frequency	2402MHz-2480MHz
WLAN Modulation	IEEE 802.11b: DSSS(CCK,DQPSK,DBPSK) IEEE 802.11g: OFDM(64QAM, 16QAM, QPSK, BPSK) IEEE 802.11n HT20: OFDM (64QAM, 16QAM, QPSK,BPSK) IEEE 802.11n HT40: OFDM (64QAM, 16QAM, QPSK,BPSK)
Bluetooth Modulation	GFSK,8DPSK, π /4DQPSK
Android Version	Android 4.2.2

2.3. Equipment Under Test

Power supply system utilised

Power supply voltage	:	<input type="radio"/> 120V / 60 Hz	<input type="radio"/> 115V / 60Hz
		<input type="radio"/> 12 V DC	<input type="radio"/> 24 V DC
		<input checked="" type="radio"/> Other (specified in blank below)	

DC 3.70V/DC 5.0V Adapter from AC 120V/60Hz

2.4. Short description of the Equipment under Test (EUT)

2.4GHz (Telpad (M/N: HC7))

For more details, refer to the user's manual of the EUT.

2.5. EUT operation mode

The application provider specific test software to control sample in continuous TX and RX (Duty Cycle >98%) for testing meet KDB558074 test requirement.

IEEE 802.11b/g/n: Thirteen channels are provided to the EUT.

Channel	Frequency(MHz)	Channel	Frequency(MHz)
1	2412	8	2447
2	2417	9	2452
3	2422	10	2457
4	2427	11	2462
5	2432	12	2467
6	2437	13	2472
7	2442		

2.6. Block Diagram of Test Setup

Fig. 2-1 Configuration of Tested System

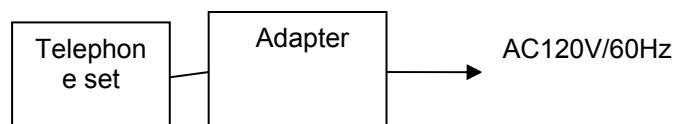

Adapter:

MODEL:SA/18PA/05FUS056300
 INPUT:100-240V~50/60Hz 0.3A
 OUTPUT: 5.6V DC 3A
 Power Cable: 180cm
 ◇ Shielded ◆ Unshielded

2.7. Related Submittal(s) / Grant (s)

This submittal(s) (test report) is intended for **FCC ID: 2ACWO-HC7-S** filing to comply with Section 15.247 of the FCC Part 15, Subpart C Rules.

2.8. Modifications

No modifications were implemented to meet testing criteria.

2.9. NOTE

1. The EUT is a Telpad with WLAN and Bluetooth function, The functions of the EUT listed as below:

	Test Standards	Reference Report
WLAN	FCC Part 15 Subpart C	A1411096077-WLAN
Bluetooth-EDR	FCC Part 15 Subpart C	A1411096077-EDR
MPE	FCC Per 47 CFR 2.1091(d)	A1411096077-MPE

2. The frequency bands used in this EUT are listed as follows:

Frequency Band(MHz)	2400-2483.5	5150-5350	5470-5725	5725-5850
802.11b	√	—	—	—
802.11g	√	—	—	—
802.11n(20MHz)	√	—	—	—
802.11n(40MHz)	√	—	—	—

3. The EUT incorporates a SISO function, Physically, the EUT provides one completed transmitter and one completed receiver.

Modulation Mode	TX Function
802.11b	1TX
802.11g	1TX
802.11n (20MHz)	1TX
802.11n (40MHz)	1TX

3. TEST ENVIRONMENT

3.1. Address of the test laboratory

Dongguan Dongdian Testing Service Co.,Ltd

No.17, Zongbu Road 2, Songshan Lake Sci&Tech, Industry Park, Dongguan City, Guangdong Province, China

The sites are constructed in conformance with the requirements of ANSI C63.7, ANSI C63.4 (2003) and CISPR Publication 22.

3.2. Test Facility

The test facility is recognized, certified, or accredited by the following organizations:

IC Registration No.: 10288A-1

The 3m alternate test site of Dongguan Dongdian Testing Service Co.,Ltd EMC Laboratory has been registered by Certification and Engineer Bureau of Industry Canada for the performance of with Registration No.: 10288A-1 on Mar, 2012.

FCC-Registration No.: 270092

Dongguan Dongdian Testing Service Co.,Ltd EMC Laboratory has been registered and fully described in a report filed with the (FCC) Federal Communications Commission. The acceptance letter from the FCC is maintained in our files. Registration 270092, Mar 06, 2012.

3.3. Environmental conditions

During the measurement the environmental conditions were within the listed ranges:

Temperature:	15-35 ° C
Humidity:	30-60 %
Atmospheric pressure:	950-1050mbar

3.4. Test Description

FCC PART 15 15.247		
FCC Part 15.207	AC Power Conducted Emission	PASS
FCC Part 15.247(a)(2)	6dB Bandwidth	PASS
FCC Part 15.247(d)	Spurious RF Conducted Emission	PASS
FCC Part 15.247(b)	Maximum Peak Output Power	PASS
FCC Part 15.247(e)	Power Spectral Density	PASS
FCC Part 15.109/ 15.205/ 15.209	Radiated Emissions	PASS
FCC Part 15.247(d)	Band Edge	PASS
FCC Part 15.203/15.247 (b)	Antenna Requirement	PASS
FCC Part1.1307 (b)	RF Exposure Evaluation	PASS

Remark: The measurement uncertainty is not included in the test result.

Preliminary tests were performed in different data rate to find the worst radiated emission. The data rate shown in the table below is the worst-case rate with respect to the specific test item. Investigation has been done on all the possible configurations for searching the worst cases. The following table is a list of the test modes shown in this test report.

Test Items	Mode	Data Rate	Channel
Maximum Peak Conducted Output Power Power Spectral Density 6dB Bandwidth Spurious RF conducted emission Radiated Emission 9kHz~1GHz& Radiated Emission 1GHz~10th Harmonic	11b/DSSS	1 Mbps	1/6/11
	11g/OFDM	6 Mbps	1/6/11
	11n(20MHz)/OFDM	6.5Mbps	1/6/11
	11n(40MHz)/OFDM	13.5Mbps	3/6/9
Band Edge	11b/DSSS	1 Mbps	1/11
	11g/OFDM	6 Mbps	1/11
	11n(20MHz)/OFDM	6.5Mbps	1/11
	11n(40MHz)/OFDM	13.5Mbps	3/9

3.5. Statement of the measurement uncertainty

The data and results referenced in this document are true and accurate. The reader is cautioned that there may be errors within the calibration limits of the equipment and facilities. The measurement uncertainty was calculated for all measurements listed in this test report acc. to CISPR 16 - 4 „Specification for radio disturbance and immunity measuring apparatus and methods – Part 4: Uncertainty in EMC Measurements“ and is documented in the Dongguan Dongdian Testing Service Co.,Ltd quality system acc. to DIN EN ISO/IEC 17025. Furthermore, component and process variability of devices similar to that tested may result in additional deviation. The manufacturer has the sole responsibility of continued compliance of the device.

Hereafter the best measurement capability for Dongguan Dongdian Testing Service Co.,Ltd laboratory is reported:

Test Items	Measurement Uncertainty	Notes
Transmitter power conducted	0.57 dB	(1)
Transmitter power Radiated	2.20 dB	(1)
Conducted spurious emission 9KHz-40 GHz	1.60 dB	(1)
Radiated spurious emission 9KHz-40 GHz	2.20 dB	(1)
Conducted Emission 9KHz-30MHz	3.39 dB	(1)
Radiated Emission 30~1000MHz	4.24 dB	(1)
Radiated Emission 1~18GHz	5.16 dB	(1)
Radiated Emission 18-40GHz	5.54 dB	(1)
Occupied Bandwidth	-----	(1)

- (1) This uncertainty represents an expanded uncertainty expressed at approximately the 95% confidence level using a coverage factor of k=2.

3.6. Equipments Used during the Test

Radiated Emission					
Item	Test Equipment	Manufacturer	Model No.	Serial No.	Last Cal.
1	Ultra-Broadband Antenna	ShwarzBeck	VULB9163	462	2014/11/01
2	EMI TEST Receiver	Rohde&Schwarz	ESU8	100316	2014/11/01
3	EMI TEST Software	Audix	E3	N/A	N/A
4	Horn Antenna	EMCO	3116	00060095	2014/11/02
5	Pre-Amplifier	Rohde&Schwarz	SCU-01	10049	2014/11/01
6	Pre-Amplifier	A.H.	PAM0-0118	360	2014/11/02
7	Pre-Amplifier	A.H.	PAM-1840VH	562	2014/11/02
8	Double Ridged Horn Antenna	Rohde&Schwarz	HF907	100265	2014/11/01
9	Active Loop Antenna	Schwarz beck	FMZB1519	0.38	2014/11/01
10	Loop Antenna	Rohde&Schwarz	HFH2-Z2	100020	2014/10/02
11	TURNTABLE	MATURO	TT2.0	---	N/A
12	ANTENNA MAST	MATURO	TAM-4.0-P	---	N/A
13	Spectrum Analyzer	R&S	FSU26	1166.1660.26	2014/11/01
14	EMI TEST Software	Rohde&Schwarz	ES-K1 V1.71	N/A	N/A

Maximum Peak Output Power / 20dB Bandwidth / Number of hopping frequency& Time of Occupancy / Band Edge Compliance of RF Emission / Spurious RF Conducted Emission/ Frequency Separation					
Item	Test Equipment	Manufacturer	Model No.	Serial No.	Last Cal.
1	Power Sensor	Rohde&Schwarz	NRP-Z81	102638	2014/11/02
2	Spectrum Analyzer	R&S	FSU26	1166.1660.26	2014/11/01
3	Spectrum Analyzer	Aglient	E4407B	MY44210775	2014/11/01

AC Power Conducted Emission					
Item	Test Equipment	Manufacturer	Model No.	Serial No.	Last Cal.
1	Artificial Mains	Rohde&Schwarz	ENV216	100316	2014/11/02
2	EMI Test Receiver	Rohde&Schwarz	ESU8	100316	2014/11/02
3	Pulse Limiter	Rohde&Schwarz	ESH3-Z2	101242	2014/11/02
4	EMI Test Software	Rohde&Schwarz	ES-K1 V1.71	N/A	N/A

The Cal.Interval was one year

4. TEST CONDITIONS AND RESULTS

4.1. AC Power Conducted Emission

TEST CONFIGURATION

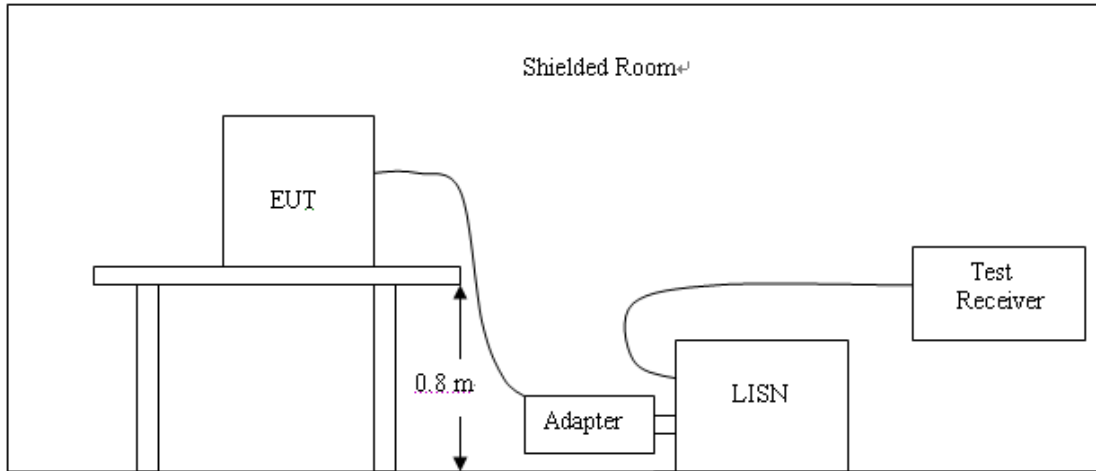

TEST PROCEDURE

- 1 The equipment was set up as per the test configuration to simulate typical actual usage per the user's manual. The EUT is a tabletop system, a wooden table with a height of 0.8 meters is used and is placed on the ground plane as per ANSI C63.10-2009.
- 2 Support equipment, if needed, was placed as per ANSI C63.10-2009
- 3 All I/O cables were positioned to simulate typical actual usage as per ANSI C63.10-2009
- 4 The EUT received DC5V power from PC, the adapter of PC received AC120V/60Hz power through a Line Impedance Stabilization Network (LISN) which supplied power source and was grounded to the ground plane.
- 5 All support equipments received AC power from a second LISN, if any.
- 6 The EUT test program was started. Emissions were measured on each current carrying line of the EUT using a spectrum Analyzer / Receiver connected to the LISN powering the EUT. The LISN has two monitoring points: Line 1 (Hot Side) and Line 2 (Neutral Side). Two scans were taken: one with Line 1 connected to Analyzer / Receiver and Line 2 connected to a 50 ohm load; the second scan had Line 1 connected to a 50 ohm load and Line 2 connected to the Analyzer / Receiver.
- 7 Analyzer / Receiver scanned from 150 KHz to 30MHz for emissions in each of the test modes.
- 8 During the above scans, the emissions were maximized by cable manipulation.

AC Power Conducted Emission Limit

For intentional device, according to § 15.207(a) AC Power Conducted Emission Limits is as following :

Frequency (MHz)	Maximum RF Line Voltage (dBµV)			
	CLASS A		CLASS B	
	Q.P.	Ave.	Q.P.	Ave.
0.15 - 0.50	79	66	66-56*	56-46*
0.50 - 5.00	73	60	56	46
5.00 - 30.0	73	60	60	50

* Decreasing linearly with the logarithm of the frequency

TEST RESULTS

The AC Power Conducted Emission measurement are performed at each test mode (b/g/n), channel (low/mid/high) and TX,RX mode, the datum recorded below (802.11b mode,the middle channel,TX mode) is the worst case for all the test modes and channels.

SCAN TABLE: "Voltage (150K-30M) FIN"

Short Description: 150K-30M Voltage

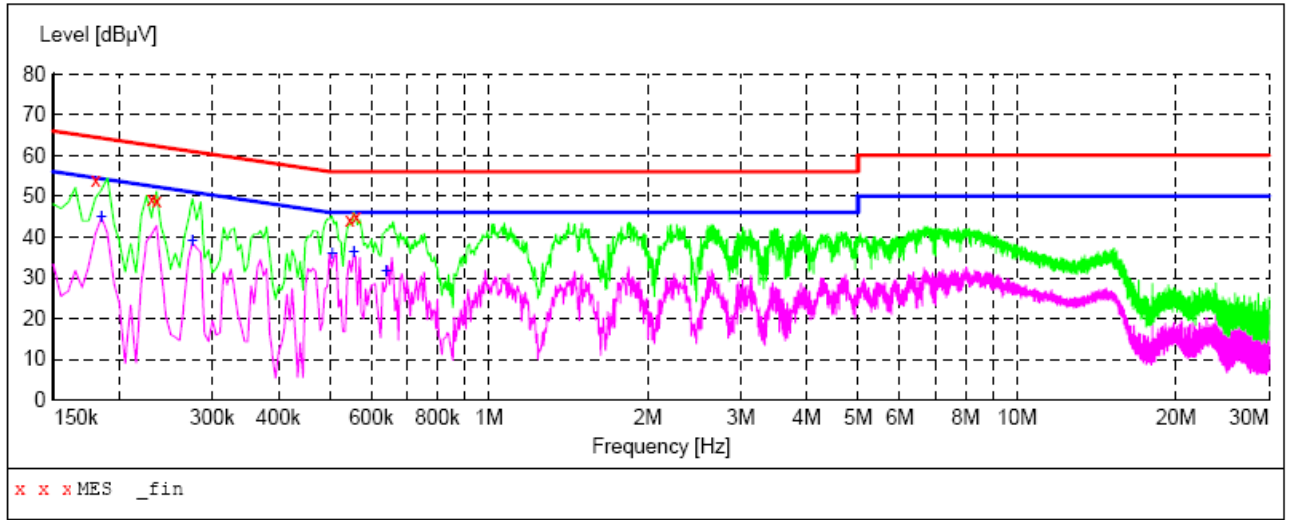

MEASUREMENT RESULT:

Frequency MHz	Level dBµV	Transd dB	Limit dBµV	Margin dB	Detector	Line	PE
0.180000	54.10	12.1	65	10.4	QP	L1	GND
0.230000	49.30	11.2	62	13.1	QP	L1	GND
0.235000	48.80	11.2	62	13.5	QP	L1	GND
0.545000	44.30	10.5	56	11.7	QP	L1	GND
0.560000	45.10	10.5	56	10.9	QP	L1	GND

MEASUREMENT RESULT:

Frequency MHz	Level dBµV	Transd dB	Limit dBµV	Margin dB	Detector	Line	PE
0.185000	44.90	11.9	54	9.4	AV	L1	GND
0.275000	39.20	11.0	51	11.8	AV	L1	GND
0.505000	35.90	10.5	46	10.1	AV	L1	GND
0.555000	36.50	10.5	46	9.5	AV	L1	GND
0.640000	31.70	10.4	46	14.3	AV	L1	GND

SCAN TABLE: "Voltage (150K-30M) FIN"

Short Description: 150K-30M Voltage

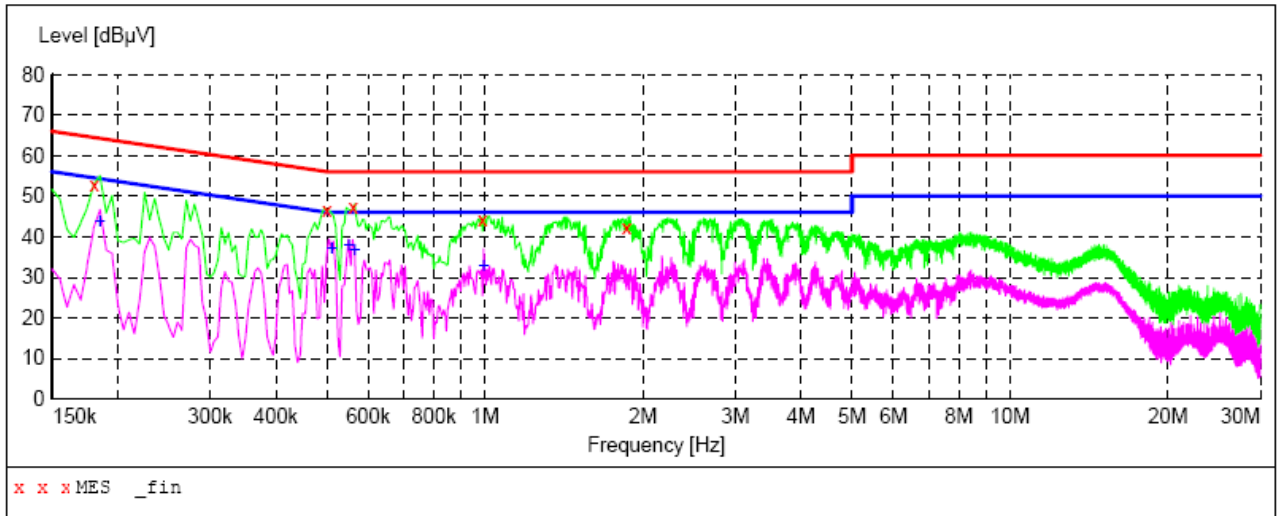

MEASUREMENT RESULT:

Frequency MHz	Level dBµV	Transd dB	Limit dBµV	Margin dB	Detector	Line	PE
0.180000	52.70	12.1	65	11.8	QP	N	GND
0.500000	46.70	10.5	56	9.3	QP	N	GND
0.560000	47.50	10.5	56	8.5	QP	N	GND
0.990000	44.10	10.5	56	11.9	QP	N	GND
1.860000	42.40	10.4	56	13.6	QP	N	GND

MEASUREMENT RESULT:

Frequency MHz	Level dBµV	Transd dB	Limit dBµV	Margin dB	Detector	Line	PE
0.185000	43.80	11.9	54	10.5	AV	N	GND
0.510000	37.30	10.5	46	8.7	AV	N	GND
0.550000	38.00	10.5	46	8.0	AV	N	GND
0.565000	37.00	10.5	46	9.0	AV	N	GND
0.995000	32.80	10.5	46	13.2	AV	N	GND

4.2. Radiated Emission

TEST CONFIGURATION

Frequency range 9KHz – 30MHz

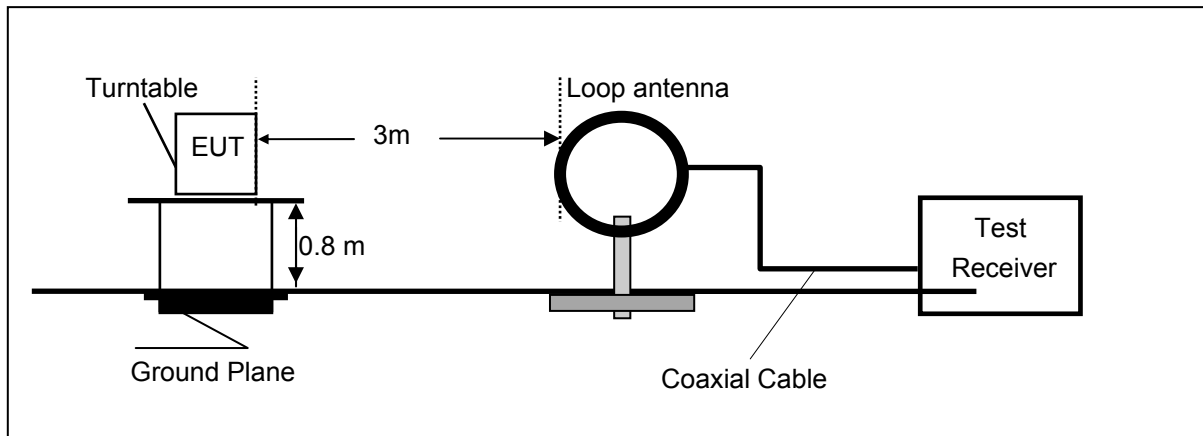

Frequency range 30MHz – 1000MHz

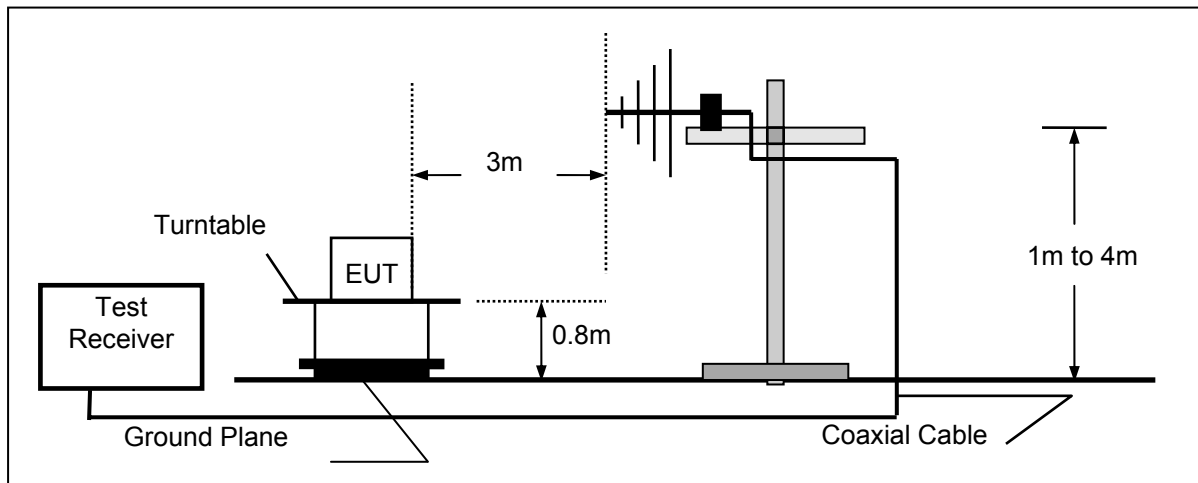

Frequency range above 1GHz-25GHz

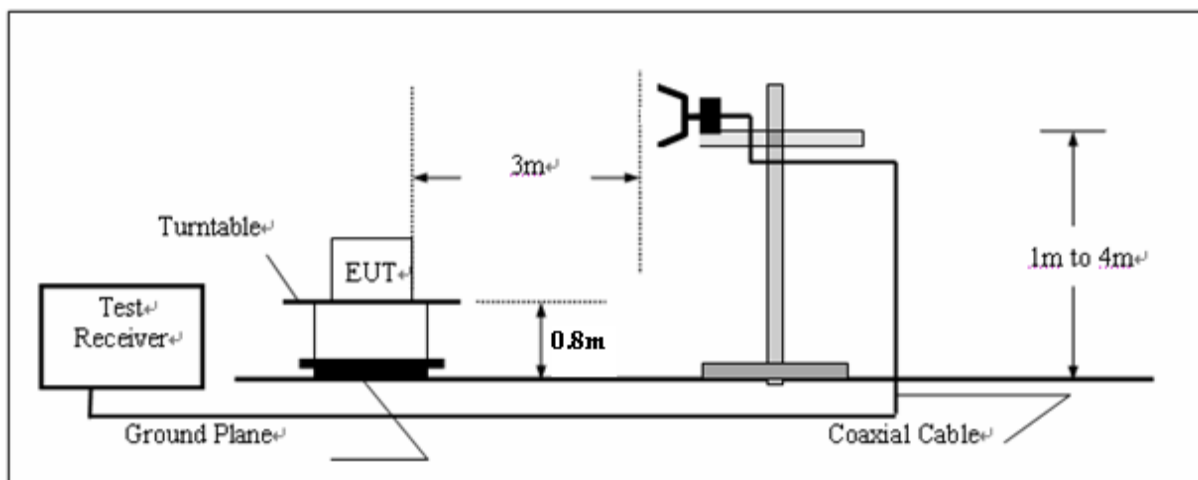

TEST PROCEDURE

1. The EUT was placed on a turn table which is 0.8m above ground plane.
2. Maximum procedure was performed by raising the receiving antenna from 1m to 4m and rotating the turn table from 0° to 360° to acquire the highest emissions from EUT
3. And also, each emission was to be maximized by changing the polarization of receiving antenna both horizontal and vertical.

4. Repeat above procedures until all frequency measurements have been completed.
5. The EUT minimum operation frequency was 32.768KHz and maximum operation frequency was 2480MHz.so radiated emission test frequency band from 9KHz to 25GHz.

Field Strength Calculation

The field strength is calculated by adding the Antenna Factor and Cable Factor and subtracting the Amplifier Gain and Duty Cycle Correction Factor(if any) from the measured reading. The basic equation with a sample calculation is as follows:

$$FS = RA + AF + CL - AG$$

Where FS = Field Strength	CL = Cable Attenuation Factor (Cable Loss)
RA = Reading Amplitude	AG = Amplifier Gain
AF = Antenna Factor	

For example

Frequency (MHz)	FS (dB μ V/m)	RA (dB μ V/m)	AF (dB)	CL (dB)	AG (dB)	Transd (dB)
300.00	40	58.1	12.2	1.6	31.90	-18.1

$$\text{Transd} = \text{AF} + \text{CL} - \text{AG}$$

RADIATION LIMIT

For intentional device, according to § 15.209(a), the general requirement of field strength of radiated emission from intentional radiators at a distance of 3 meters shall not exceed the following table. According to § 15.247(d), in any 100kHz bandwidth outside the frequency band in which the EUT is operating, the radio frequency power that is produced by the intentional radiator shall be at least 20dB below that in the 100kHz bandwidth within the band that contains the highest level of desired power.

The frequency spectrum above 1 GHz for Transmitter was investigated. All emission not reported are much lower than the prescribed limits. Set the RBW=1MHz,VBW=3MHz for Peak Detector while the RBW=1MHz,VBW=10Hz for Average Detector,Readings are both peak and average values. The pre-test have done for the EUT in three axes and found the worst emission at position shown in test setup photos.

Frequency (MHz)	Distance (Meters)	Radiated (dB μ V/m)	Radiated (μ V/m)
0.009-0.49	3	$20\log(2400/F(\text{KHz})) + 40\log(300/3)$	$2400/F(\text{KHz})$
0.49-1.705	3	$20\log(24000/F(\text{KHz})) + 40\log(30/3)$	$24000/F(\text{KHz})$
1.705-30	3	$20\log(30) + 40\log(30/3)$	30
30-88	3	40.0	100
88-216	3	43.5	150
216-960	3	46.0	200
Above 960	3	54.0	500

TEST RESULTS

Remark: 1. We tested three positions and recorded worst case.

For 9KHz to 30MHz

Frequency (MHz)	Corrected Reading (dB μ V/m)@3m	FCC Limit (dB μ V/m) @3m	Margin (dB)	Detector	Result
12.00	45.22	69.54	24.32	QP	PASS
26.00	47.91	69.54	21.63	QP	PASS

For 30MHz to 1000MHz

Vertical

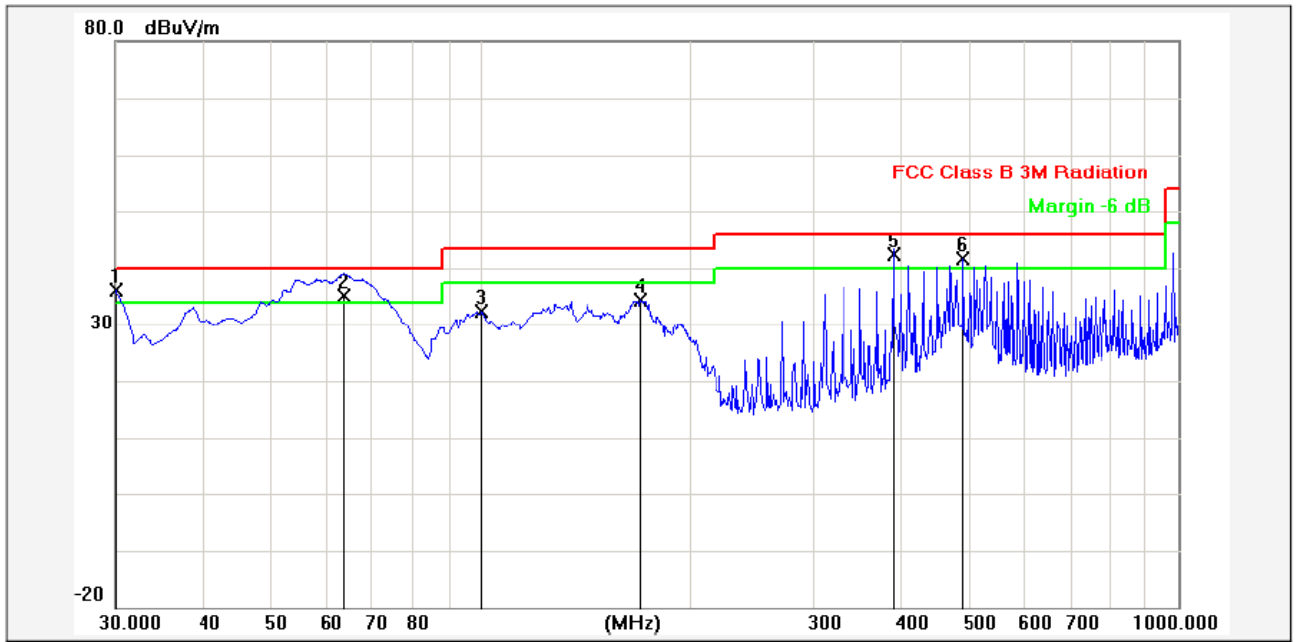

No.	Frequency (MHz)	Factor (dB/m)	Reading (dBuV)	Level (dBuV/m)	Limit (dBuV/m)	Margin (dB)	Detector	Height (cm)	Azimuth (deg.)	P/F	Remark
1	30.0000	-6.85	43.09	36.24	40.00	-3.76	QP			P	
2	63.9500	-17.10	52.30	35.20	40.00	-4.80	QP			P	
3	100.8100	-15.77	48.12	32.35	43.50	-11.15	QP			P	
4	169.6799	-16.44	50.88	34.44	43.50	-9.06	QP			P	
5	391.8100	-9.74	52.00	42.26	46.00	-3.74	QP			P	
6	491.7200	-8.77	50.50	41.73	46.00	-4.27	QP			P	

Horizontal

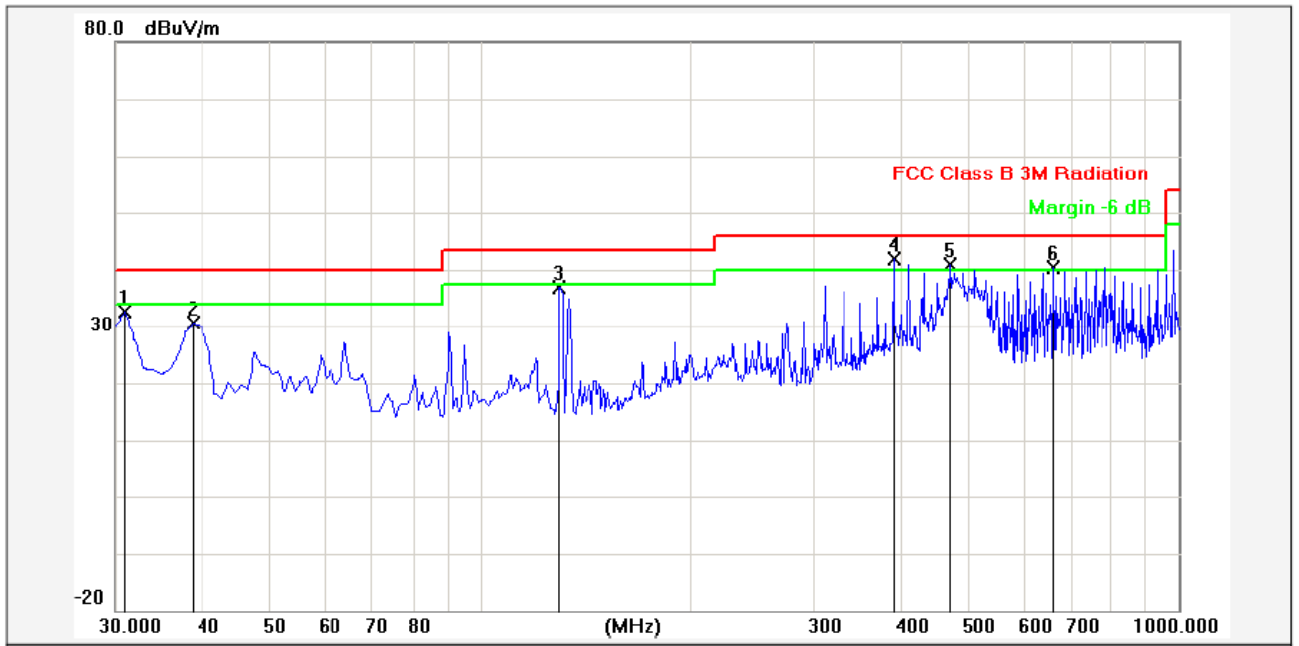

No.	Frequency (MHz)	Factor (dB/m)	Reading (dBuV)	Level (dBuV/m)	Limit (dBuV/m)	Margin (dB)	Detector	Height (cm)	Azimuth (deg.)	P/F	Remark
1	30.9700	-7.04	39.63	32.59	40.00	-7.41	QP			P	
2	38.7300	-8.54	39.15	30.61	40.00	-9.39	QP			P	
3	129.9100	-15.09	52.02	36.93	43.50	-6.57	QP			P	
4	391.8100	-9.74	51.67	41.93	46.00	-4.07	QP			P	
5	471.3500	-8.93	49.90	40.97	46.00	-5.03	QP			P	
6	663.4099	-6.33	46.83	40.50	46.00	-5.50	QP			P	

For 1GHz to 25GHz

802.11b Mode(above 1GHz)

ANTENNA POLARITY & TEST DISTANCE: HORIZONTAL AT 3 M (802.11b--2412MHz)												
No.	Frequency (MHz)	Emission Level (dBuV/m)		Limit (dBuV/m)	Margin (dB)	Antenna Height (m)	Table Angle (Degree)	Raw Value (dBuV)	Antenna Factor (dB/m)	Cable Factor (dB)	Pre-amplifier (dB)	Correction Factor (dB/m)
1	4824.00	59.08	PK	74.00	14.92	1.00	102	56.98	31.60	7.00	36.5	2.10
1	4824.00	44.67	AV	54.00	9.33	1.00	102	42.57	31.60	7.00	36.5	2.10
2	7236.00	62.55	PK	74.00	11.45	1.00	313	51.62	37.33	8.90	35.3	10.93
2	7236.00	45.98	AV	54.00	8.02	1.00	313	35.05	37.33	8.90	35.3	10.93

ANTENNA POLARITY & TEST DISTANCE: VERTICAL AT 3 M (802.11b--2412MHz)												
No.	Frequency (MHz)	Emission Level (dBuV/m)		Limit (dBuV/m)	Margin (dB)	Antenna Height (m)	Table Angle (Degree)	Raw Value (dBuV)	Antenna Factor (dB/m)	Cable Factor (dB)	Pre-amplifier (dB)	Correction Factor (dB/m)
1	4824.00	56.96	PK	74.00	17.04	1.00	155	54.86	31.60	7.00	36.5	2.10
1	4824.00	42.85	AV	54.00	11.15	1.00	155	40.75	31.60	7.00	36.5	2.10
2	7236.00	61.33	PK	74.00	12.67	1.00	108	50.40	37.33	8.90	35.3	10.93
2	7236.00	43.94	AV	54.00	10.06	1.00	108	33.01	37.33	8.90	35.3	10.93

ANTENNA POLARITY & TEST DISTANCE: HORIZONTAL AT 3 M (802.11b--2437MHz)												
No.	Frequency (MHz)	Emission Level (dBuV/m)		Limit (dBuV/m)	Margin (dB)	Antenna Height (m)	Table Angle (Degree)	Raw Value (dBuV)	Antenna Factor (dB/m)	Cable Factor (dB)	Pre-amplifier (dB)	Correction Factor (dB/m)
1	4874.00	61.88	PK	74.00	12.12	1.00	200	59.76	31.02	7.60	36.5	2.12
1	4874.00	45.44	AV	54.00	8.56	1.00	200	43.32	31.02	7.60	36.5	2.12
2	7311.00	63.62	PK	74.00	10.38	1.00	250	52.54	37.28	8.60	34.8	11.08
2	7311.00	46.01	AV	54.00	7.99	1.00	250	34.93	37.28	8.60	34.8	11.08

ANTENNA POLARITY & TEST DISTANCE: VERTICAL AT 3 M (802.11b--2437MHz)												
No.	Frequency (MHz)	Emission Level (dBuV/m)		Limit (dBuV/m)	Margin (dB)	Antenna Height (m)	Table Angle (Degree)	Raw Value (dBuV)	Antenna Factor (dB/m)	Cable Factor (dB)	Pre-amplifier (dB)	Correction Factor (dB/m)
1	4874.00	59.05	PK	74.00	14.95	1.00	150	56.93	31.02	7.60	36.5	2.12
1	4874.00	42.97	AV	54.00	11.03	1.00	150	40.85	31.02	7.60	36.5	2.12
2	7311.00	62.02	PK	74.00	11.98	1.00	128	50.94	37.28	8.60	34.8	11.08
2	7311.00	43.26	AV	54.00	10.74	1.00	128	32.18	37.28	8.60	34.8	11.08

ANTENNA POLARITY & TEST DISTANCE: HORIZONTAL AT 3 M (802.11b--2462MHz)												
No.	Frequency (MHz)	Emission Level (dBuV/m)		Limit (dBuV/m)	Margin (dB)	Antenna Height (m)	Table Angle (Degree)	Raw Value (dBuV)	Antenna Factor (dB/m)	Cable Factor (dB)	Pre-amplifier (dB)	Correction Factor (dB/m)
1	4924.00	61.61	PK	74.00	12.39	1.00	352	59.23	31.58	7.00	36.2	2.38
1	4924.00	44.73	AV	54.00	9.27	1.00	352	42.35	31.58	7.00	36.2	2.38
2	7386.00	64.64	PK	74.00	9.36	1.00	300	52.93	38.51	8.50	35.3	11.71
2	7386.00	46.08	AV	54.00	7.92	1.00	300	34.37	38.51	8.50	35.3	11.71

ANTENNA POLARITY & TEST DISTANCE: VERTICAL AT 3 M (802.11b--2462MHz)

No.	Frequency (MHz)	Emission Level (dBuV/m)		Limit (dBuV/m)	Margin (dB)	Antenna Height (m)	Table Angle (Degree)	Raw Value (dBuV)	Antenna Factor (dB/m)	Cable Factor (dB)	Pre-amplifier (dB)	Correction Factor (dB/m)
1	4924.00	57.95	PK	74.00	16.05	1.00	267	55.57	31.58	7.00	36.2	2.38
1	4924.00	41.24	AV	54.00	12.76	1.00	267	38.86	31.58	7.00	36.2	2.38
2	7386.00	62.03	PK	74.00	11.97	1.00	174	50.32	38.51	8.50	35.3	11.71
2	7386.00	44.00	AV	54.00	10.00	1.00	174	32.29	38.51	8.50	35.3	11.71

- REMARKS:**
1. Emission level (dBuV/m)=Raw Value(dBuV)+Correction Factor(dB/m)
 2. Correction Factor (dB/m) = Antenna Factor (dB/m)+Cable Factor (dB)-Pre-amplifier Factor
 3. The other emission levels were very low against the limit.
 4. Margin value = Limit value- Emission level.
 5. For Wireless 802.11b mode at 1Mbps.

802.11g Mode(above 1GHz)**ANTENNA POLARITY & TEST DISTANCE: HORIZONTAL AT 3 M (802.11g--2412MHz)**

No.	Frequency (MHz)	Emission Level (dBuV/m)		Limit (dBuV/m)	Margin (dB)	Antenna Height (m)	Table Angle (Degree)	Raw Value (dBuV)	Antenna Factor (dB/m)	Cable Factor (dB)	Pre-amplifier (dB)	Correction Factor (dB/m)
1	4824.00	58.77	PK	74.00	15.23	1.00	300	56.67	31.60	7.00	36.5	2.10
1	4824.00	44.26	AV	54.00	9.74	1.00	300	42.16	31.60	7.00	36.5	2.10
2	7236.00	62.12	PK	74.00	11.88	1.00	197	51.19	37.33	8.90	35.3	10.93
2	7236.00	45.51	AV	54.00	8.49	1.00	197	34.58	37.33	8.90	35.3	10.93

ANTENNA POLARITY & TEST DISTANCE: VERTICAL AT 3 M (802.11g--2412MHz)

No.	Frequency (MHz)	Emission Level (dBuV/m)		Limit (dBuV/m)	Margin (dB)	Antenna Height (m)	Table Angle (Degree)	Raw Value (dBuV)	Antenna Factor (dB/m)	Cable Factor (dB)	Pre-amplifier (dB)	Correction Factor (dB/m)
1	4824.00	56.37	PK	74.00	17.63	1.00	245	54.27	31.60	7.00	36.5	2.10
1	4824.00	42.26	AV	54.00	11.74	1.00	245	40.16	31.60	7.00	36.5	2.10
2	7236.00	61.02	PK	74.00	12.98	1.00	101	50.09	37.33	8.90	35.3	10.93
2	7236.00	43.44	AV	54.00	10.56	1.00	101	32.51	37.33	8.90	35.3	10.93

ANTENNA POLARITY & TEST DISTANCE: HORIZONTAL AT 3 M (802.11g--2437MHz)

No.	Frequency (MHz)	Emission Level (dBuV/m)		Limit (dBuV/m)	Margin (dB)	Antenna Height (m)	Table Angle (Degree)	Raw Value (dBuV)	Antenna Factor (dB/m)	Cable Factor (dB)	Pre-amplifier (dB)	Correction Factor (dB/m)
1	4874.00	61.37	PK	74.00	12.63	1.00	88	59.25	31.02	7.60	36.5	2.12
1	4874.00	45.01	AV	54.00	8.99	1.00	88	42.89	31.02	7.60	36.5	2.12
2	7311.00	63.13	PK	74.00	10.87	1.00	164	52.05	37.28	8.60	34.8	11.08
2	7311.00	45.77	AV	54.00	8.23	1.00	164	34.69	37.28	8.60	34.8	11.08

ANTENNA POLARITY & TEST DISTANCE: VERTICAL AT 3 M (802.11g--2437MHz)

No.	Frequency (MHz)	Emission Level (dBuV/m)		Limit (dBuV/m)	Margin (dB)	Antenna Height (m)	Table Angle (Degree)	Raw Value (dBuV)	Antenna Factor (dB/m)	Cable Factor (dB)	Pre-amplifier (dB)	Correction Factor (dB/m)
1	4874.00	58.98	PK	74.00	15.02	1.00	222	56.86	31.02	7.60	36.5	2.12
1	4874.00	42.74	AV	54.00	11.26	1.00	222	40.62	31.02	7.60	36.5	2.12
2	7311.00	61.93	PK	74.00	12.07	1.00	197	50.85	37.28	8.60	34.8	11.08
2	7311.00	43.01	AV	54.00	10.99	1.00	197	31.93	37.28	8.60	34.8	11.08

ANTENNA POLARITY & TEST DISTANCE: HORIZONTAL AT 3 M (802.11g--2462MHz)												
No.	Frequency (MHz)	Emission Level (dBuV/m)		Limit (dBuV/m)	Margin (dB)	Antenna Height (m)	Table Angle (Degree)	Raw Value (dBuV)	Antenna Factor (dB/m)	Cable Factor (dB)	Pre-amplifier (dB)	Correction Factor (dB/m)
1	4924.00	61.19	PK	74.00	12.81	1.00	303	58.81	31.58	7.00	36.2	2.38
1	4924.00	44.28	AV	54.00	9.72	1.00	303	41.90	31.58	7.00	36.2	2.38
2	7311.00	63.85	PK	74.00	10.15	1.00	123	52.14	38.51	8.50	35.3	11.71
2	7311.00	45.67	AV	54.00	8.33	1.00	123	33.96	38.51	8.50	35.3	11.71

ANTENNA POLARITY & TEST DISTANCE: VERTICAL AT 3 M (802.11g--2462MHz)												
No.	Frequency (MHz)	Emission Level (dBuV/m)		Limit (dBuV/m)	Margin (dB)	Antenna Height (m)	Table Angle (Degree)	Raw Value (dBuV)	Antenna Factor (dB/m)	Cable Factor (dB)	Pre-amplifier (dB)	Correction Factor (dB/m)
1	4924.00	57.08	PK	74.00	16.92	1.00	48	54.70	31.58	7.00	36.2	2.38
1	4924.00	40.76	AV	54.00	13.24	1.00	48	38.38	31.58	7.00	36.2	2.38
2	7386.00	61.85	PK	74.00	12.15	1.00	62	50.14	38.51	8.50	35.3	11.71
2	7386.00	43.01	AV	54.00	10.99	1.00	62	31.30	38.51	8.50	35.3	11.71

- REMARKS:**
1. Emission level (dBuV/m) = Raw Value (dBuV) + Correction Factor (dB/m)
 2. Correction Factor (dB/m) = Antenna Factor (dB/m) + Cable Factor (dB) - Pre-amplifier Factor
 3. The other emission levels were very low against the limit.
 4. Margin value = Limit value - Emission level.
 5. For Wireless 802.11g mode at 6Mbps.

802.11n(20MHz) Mode(above 1GHz)

ANTENNA POLARITY & TEST DISTANCE: HORIZONTAL AT 3 M (802.11n20--2412MHz)												
No.	Frequency (MHz)	Emission Level (dBuV/m)		Limit (dBuV/m)	Margin (dB)	Antenna Height (m)	Table Angle (Degree)	Raw Value (dBuV)	Antenna Factor (dB/m)	Cable Factor (dB)	Pre-amplifier (dB)	Correction Factor (dB/m)
1	4824.00	58.02	PK	74.00	15.98	1.00	124	55.92	31.60	7.00	36.5	2.10
1	4824.00	43.94	AV	54.00	10.06	1.00	124	41.84	31.60	7.00	36.5	2.10
2	7236.00	61.85	PK	74.00	12.15	1.00	289	50.92	37.33	8.90	35.3	10.93
2	7236.00	45.17	AV	54.00	8.83	1.00	289	34.24	37.33	8.90	35.3	10.93

ANTENNA POLARITY & TEST DISTANCE: VERTICAL AT 3 M (802.11n20--2412MHz)												
No.	Frequency (MHz)	Emission Level (dBuV/m)		Limit (dBuV/m)	Margin (dB)	Antenna Height (m)	Table Angle (Degree)	Raw Value (dBuV)	Antenna Factor (dB/m)	Cable Factor (dB)	Pre-amplifier (dB)	Correction Factor (dB/m)
1	4824.00	55.88	PK	74.00	18.12	1.00	87	53.78	31.60	7.00	36.5	2.10
1	4824.00	41.93	AV	54.00	12.07	1.00	87	39.83	31.60	7.00	36.5	2.10
2	7236.00	60.24	PK	74.00	13.76	1.00	311	49.31	37.33	8.90	35.3	10.93
2	7236.00	42.99	AV	54.00	11.01	1.00	311	32.06	37.33	8.90	35.3	10.93

ANTENNA POLARITY & TEST DISTANCE: HORIZONTAL AT 3 M (802.11n20--2437MHz)												
No.	Frequency (MHz)	Emission Level (dBuV/m)		Limit (dBuV/m)	Margin (dB)	Antenna Height (m)	Table Angle (Degree)	Raw Value (dBuV)	Antenna Factor (dB/m)	Cable Factor (dB)	Pre-amplifier (dB)	Correction Factor (dB/m)
1	4874.00	61.05	PK	74.00	12.95	1.00	300	58.93	31.02	7.60	36.5	2.12
1	4874.00	44.82	AV	54.00	9.18	1.00	300	42.70	31.02	7.60	36.5	2.12
2	7311.00	62.99	PK	74.00	11.01	1.00	199	51.91	37.28	8.60	34.8	11.08
2	7311.00	45.43	AV	54.00	8.57	1.00	199	34.35	37.28	8.60	34.8	11.08

ANTENNA POLARITY & TEST DISTANCE: VERTICAL AT 3 M (802.11n20--2437MHz)												
No.	Frequency (MHz)	Emission Level (dBuV/m)		Limit (dBuV/m)	Margin (dB)	Antenna Height (m)	Table Angle (Degree)	Raw Value (dBuV)	Antenna Factor (dB/m)	Cable Factor (dB)	Pre-amplifier (dB)	Correction Factor (dB/m)
1	4874.00	58.34	PK	74.00	15.66	1.00	246	56.22	31.02	7.60	36.5	2.12
1	4874.00	42.28	AV	54.00	11.72	1.00	246	40.16	31.02	7.60	36.5	2.12
2	7311.00	61.44	PK	74.00	12.56	1.00	310	50.36	37.28	8.60	34.8	11.08
2	7311.00	42.85	AV	54.00	11.15	1.00	310	31.77	37.28	8.60	34.8	11.08

ANTENNA POLARITY & TEST DISTANCE: HORIZONTAL AT 3 M (802.11n20--2462MHz)												
No.	Frequency (MHz)	Emission Level (dBuV/m)		Limit (dBuV/m)	Margin (dB)	Antenna Height (m)	Table Angle (Degree)	Raw Value (dBuV)	Antenna Factor (dB/m)	Cable Factor (dB)	Pre-amplifier (dB)	Correction Factor (dB/m)
1	4924.00	60.76	PK	74.00	13.24	1.00	107	58.38	31.58	7.00	36.2	2.38
1	4924.00	43.89	AV	54.00	10.11	1.00	107	41.51	31.58	7.00	36.2	2.38
2	7386.00	62.94	PK	74.00	11.06	1.00	359	51.23	38.51	8.50	35.3	11.71
2	7386.00	45.11	AV	54.00	8.89	1.00	359	33.40	38.51	8.50	35.3	11.71

ANTENNA POLARITY & TEST DISTANCE: VERTICAL AT 3 M (802.11n20--2462MHz)												
No.	Frequency (MHz)	Emission Level (dBuV/m)		Limit (dBuV/m)	Margin (dB)	Antenna Height (m)	Table Angle (Degree)	Raw Value (dBuV)	Antenna Factor (dB/m)	Cable Factor (dB)	Pre-amplifier (dB)	Correction Factor (dB/m)
1	4924.00	56.46	PK	74.00	17.54	1.00	200	54.08	31.58	7.00	36.2	2.38
1	4924.00	40.03	AV	54.00	13.97	1.00	200	37.65	31.58	7.00	36.2	2.38
2	7386.00	61.11	PK	74.00	12.89	1.00	196	49.40	38.51	8.50	35.3	11.71
2	7386.00	42.58	AV	54.00	11.42	1.00	196	30.87	38.51	8.50	35.3	11.71

- REMARKS:**
1. Emission level (dBuV/m) = Raw Value (dBuV) + Correction Factor (dB/m)
 2. Correction Factor (dB/m) = Antenna Factor (dB/m) + Cable Factor (dB) - Pre-amplifier Factor
 3. The other emission levels were very low against the limit.
 4. Margin value = Limit value - Emission level.
 5. For Wireless 802.11n (20MHz) mode at 6.5Mbps.

802.11n(40MHz) Mode(above 1GHz)

ANTENNA POLARITY & TEST DISTANCE: HORIZONTAL AT 3 M (802.11n40--2422MHz)												
No.	Frequency (MHz)	Emission Level (dBuV/m)		Limit (dBuV/m)	Margin (dB)	Antenna Height (m)	Table Angle (Degree)	Raw Value (dBuV)	Antenna Factor (dB/m)	Cable Factor (dB)	Pre-amplifier (dB)	Correction Factor (dB/m)
1	4844.00	58.15	PK	74.00	15.85	1.00	8	56.04	31.01	7.30	36.2	2.11
1	4844.00	43.99	AV	54.00	10.01	1.00	8	41.88	31.01	7.30	36.2	2.11
2	7266.00	61.94	PK	74.00	12.06	1.00	91	51.14	36.70	8.90	34.8	10.80
2	7266.00	45.23	AV	54.00	8.77	1.00	91	34.43	36.70	8.90	34.8	10.80

ANTENNA POLARITY & TEST DISTANCE: VERTICAL AT 3 M (802.11n40--2422MHz)												
No.	Frequency (MHz)	Emission Level (dBuV/m)		Limit (dBuV/m)	Margin (dB)	Antenna Height (m)	Table Angle (Degree)	Raw Value (dBuV)	Antenna Factor (dB/m)	Cable Factor (dB)	Pre-amplifier (dB)	Correction Factor (dB/m)
1	4844.00	55.99	PK	74.00	18.01	1.00	222	53.88	31.01	7.30	36.2	2.11
1	4844.00	42.07	AV	54.00	11.93	1.00	222	39.96	31.01	7.30	36.2	2.11
2	7266.00	60.85	PK	74.00	13.15	1.00	104	50.05	36.70	8.90	34.8	10.80
2	7266.00	43.11	AV	54.00	10.89	1.00	104	32.31	36.70	8.90	34.8	10.80

ANTENNA POLARITY & TEST DISTANCE: HORIZONTAL AT 3 M (802.11n40--2437MHz)												
No.	Frequency (MHz)	Emission Level (dBuV/m)		Limit (dBuV/m)	Margin (dB)	Antenna Height (m)	Table Angle (Degree)	Raw Value (dBuV)	Antenna Factor (dB/m)	Cable Factor (dB)	Pre-amplifier (dB)	Correction Factor (dB/m)
1	4874.00	59.65	PK	74.00	14.35	1.00	114	57.53	31.02	7.60	36.5	2.12
1	4874.00	43.44	AV	54.00	10.56	1.00	114	41.32	31.02	7.60	36.5	2.12
2	7311.00	61.25	PK	74.00	12.75	1.00	272	50.17	37.28	8.60	34.8	11.08
2	7311.00	44.61	AV	54.00	9.39	1.00	272	33.53	37.28	8.60	34.8	11.08

ANTENNA POLARITY & TEST DISTANCE: VERTICAL AT 3 M (802.11n40--2437MHz)												
No.	Frequency (MHz)	Emission Level (dBuV/m)		Limit (dBuV/m)	Margin (dB)	Antenna Height (m)	Table Angle (Degree)	Raw Value (dBuV)	Antenna Factor (dB/m)	Cable Factor (dB)	Pre-amplifier (dB)	Correction Factor (dB/m)
1	4874.00	57.72	PK	74.00	16.28	1.00	167	55.60	31.02	7.60	36.5	2.12
1	4874.00	41.88	AV	54.00	12.12	1.00	167	39.76	31.02	7.60	36.5	2.12
2	7311.00	60.06	PK	74.00	13.94	1.00	108	48.98	37.28	8.60	34.8	11.08
2	7311.00	42.31	AV	54.00	11.69	1.00	108	31.23	37.28	8.60	34.8	11.08

ANTENNA POLARITY & TEST DISTANCE: HORIZONTAL AT 3 M (802.11n40--2452MHz)												
No.	Frequency (MHz)	Emission Level (dBuV/m)		Limit (dBuV/m)	Margin (dB)	Antenna Height (m)	Table Angle (Degree)	Raw Value (dBuV)	Antenna Factor (dB/m)	Cable Factor (dB)	Pre-amplifier (dB)	Correction Factor (dB/m)
1	4904.00	60.22	PK	74.00	13.78	55.86	264	57.95	31.47	7.00	36.2	2.27
1	4904.00	43.24	AV	54.00	10.76	36.96	264	40.97	31.47	7.00	36.2	2.27
2	7356.00	62.17	PK	74.00	11.83	46.86	199	50.52	38.45	8.50	35.3	11.65
2	7356.00	44.65	AV	54.00	9.35	26.95	199	33.00	38.45	8.50	35.3	11.65

ANTENNA POLARITY & TEST DISTANCE: VERTICAL AT 3 M (802.11n40--2452MHz)												
No.	Frequency (MHz)	Emission Level (dBuV/m)		Limit (dBuV/m)	Margin (dB)	Antenna Height (m)	Table Angle (Degree)	Raw Value (dBuV)	Antenna Factor (dB/m)	Cable Factor (dB)	Pre-amplifier (dB)	Correction Factor (dB/m)
1	4904.00	56.07	PK	74.00	17.93	1.00	234	53.80	31.47	7.00	36.2	2.27
1	4904.00	39.97	AV	54.00	14.03	1.00	234	37.70	31.47	7.00	36.2	2.27
2	7356.00	60.76	PK	74.00	13.24	1.00	158	49.11	38.45	8.50	35.3	11.65
2	7356.00	42.21	AV	54.00	11.79	1.00	158	30.56	38.45	8.50	35.3	11.65

- REMARKS:**
1. Emission level (dBuV/m) = Raw Value (dBuV) + Correction Factor (dB/m)
 2. Correction Factor (dB/m) = Antenna Factor (dB/m) + Cable Factor (dB) - Pre-amplifier Factor
 3. The other emission levels were very low against the limit.
 4. Margin value = Limit value - Emission level.
 5. For Wireless 802.11n (40MHz) mode at 13.5Mbps.

4.3. Maximum Peak Output Power

TEST CONFIGURATION

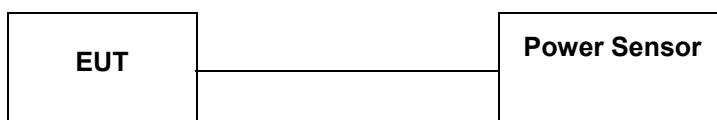

TEST PROCEDURE

According to KDB558074 D01 DTS Measurement Guidance Section 9.1 Maximum peak conducted output power,9.1.1. The maximum peak conducted output power may be measured using a broadband peak RF power meter. The power meter shall have a video bandwidth that is greater than or equal to the DTS bandwidth and shall utilize a fast-responding diode detector.

LIMIT

The Maximum Peak Output Power Measurement is 30dBm.

TEST RESULTS

Remark:We measured output power at difference data rate for each mode and recorded woest case for each mode.

4.3.1 802.11b Test Mode

A. Test Verdict

Channel	Frequency (MHz)	Measured Output Peak Power (dBm)	Limits (dBm)	Verdict
1	2412	19.20	30	PASS
6	2437	18.45	30	PASS
11	2462	18.81	30	PASS

4.3.2 802.11g Test Mode

A. Test Verdict

Channel	Frequency (MHz)	Measured Output Peak Power (dBm)	Limits (dBm)	Verdict
1	2412	20.03	30	PASS
6	2437	20.42	30	PASS
11	2462	20.36	30	PASS

4.3.3 802.11n(20MHz) Test Mode

A. Test Verdict

Channel	Frequency (MHz)	Measured Output Peak Power (dBm)	Limits (dBm)	Verdict
1	2412	22.56	30	PASS
6	2437	22.84	30	PASS
11	2462	21.97	30	PASS

4.3.4 802.11n(40MHz) Test Mode

A. Test Verdict

Channel	Frequency (MHz)	Measured Output Peak Power (dBm)	Limits (dBm)	Verdict
3	2422	18.99	30	PASS
6	2437	19.24	30	PASS
9	2452	18.55	30	PASS

4.4. Power Spectral Density

TEST CONFIGURATION

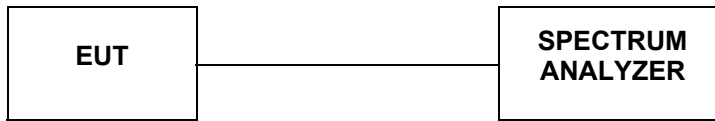

TEST PROCEDURE

According to KDB 558074 D01 V03 Method PKPSD (peak PSD) This procedure shall be used if maximum peak conducted output power was used to demonstrate compliance, and is optional if the maximum conducted (average) output power was used to demonstrate compliance.

1. Set analyzer center frequency to DTS channel center frequency.
2. Set the span to 1.5 times the DTS bandwidth.
3. Set the RBW to: $3 \text{ kHz} \leq \text{RBW} \leq 100 \text{ kHz}$.
4. Set the VBW $\geq 3 \text{ RBW}$.
5. Detector = peak.
6. Sweep time = auto couple.
7. Trace mode = max hold.
8. Allow trace to fully stabilize.
9. Use the peak marker function to determine the maximum amplitude level within the RBW.
10. If measured value exceeds limit, reduce RBW (no less than 3 kHz) and repeat.

LIMIT

For digitally modulated systems, the power spectral density conducted from the intentional radiator to the antenna shall not be greater than 8 dBm in any 3 kHz band during any time interval of continuous transmission.

TEST RESULTS

4.4.1 802.11b Test Mode

A. Test Verdict

Channel	Frequency (MHz)	Report PSD (dBm/3KHz)	Refer to Plot	Limits (dBm/3KHz)	Verdict
1	2412	-13.18	Plot 4.4.1 A	8	PASS
6	2437	-12.93	Plot 4.4.1 B	8	PASS
11	2462	-13.25	Plot 4.4.1 C	8	PASS

Note: 1. For 802.11b mode at final test to get the worst-case emission at 1Mbps.
2. The test results including the cable lose.

B. Test Plots

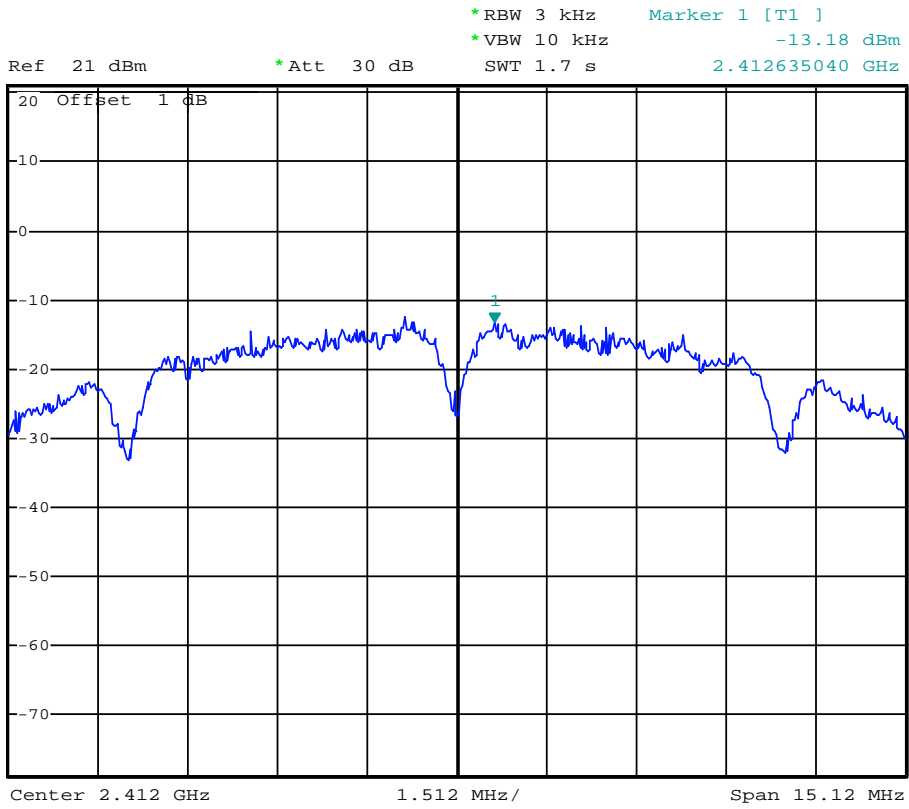

(Plot 4.4.1 A: Channel 1: 2412MHz @ 802.11b)

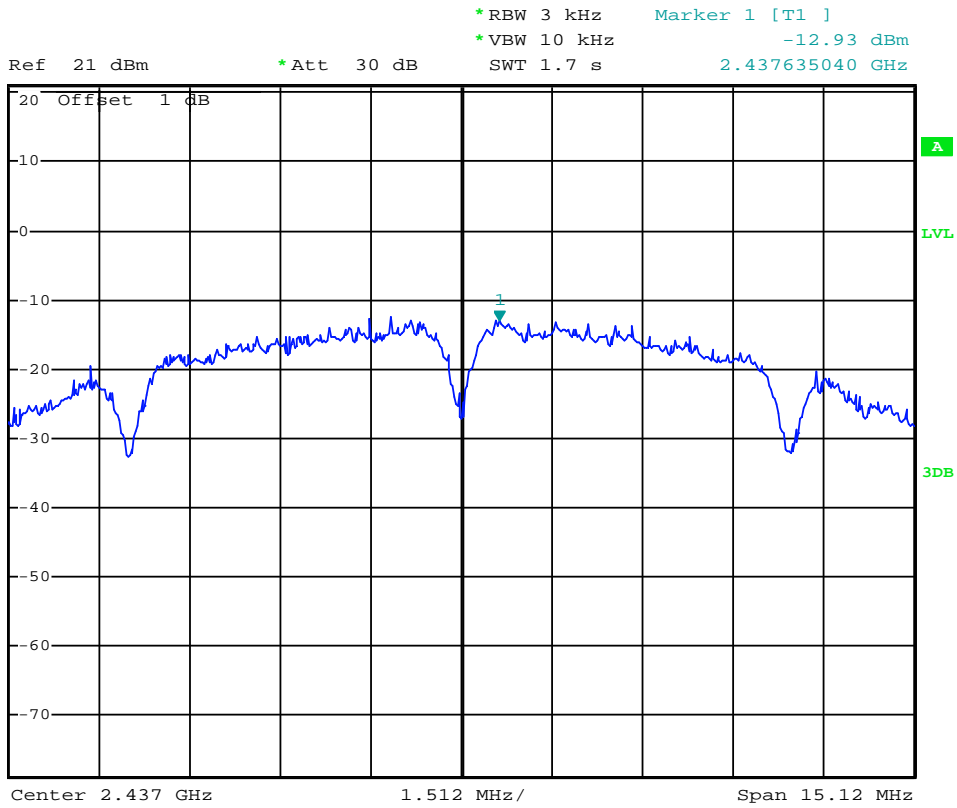

(Plot 4.4.1 B: Channel 6: 2437MHz @ 802.11b)

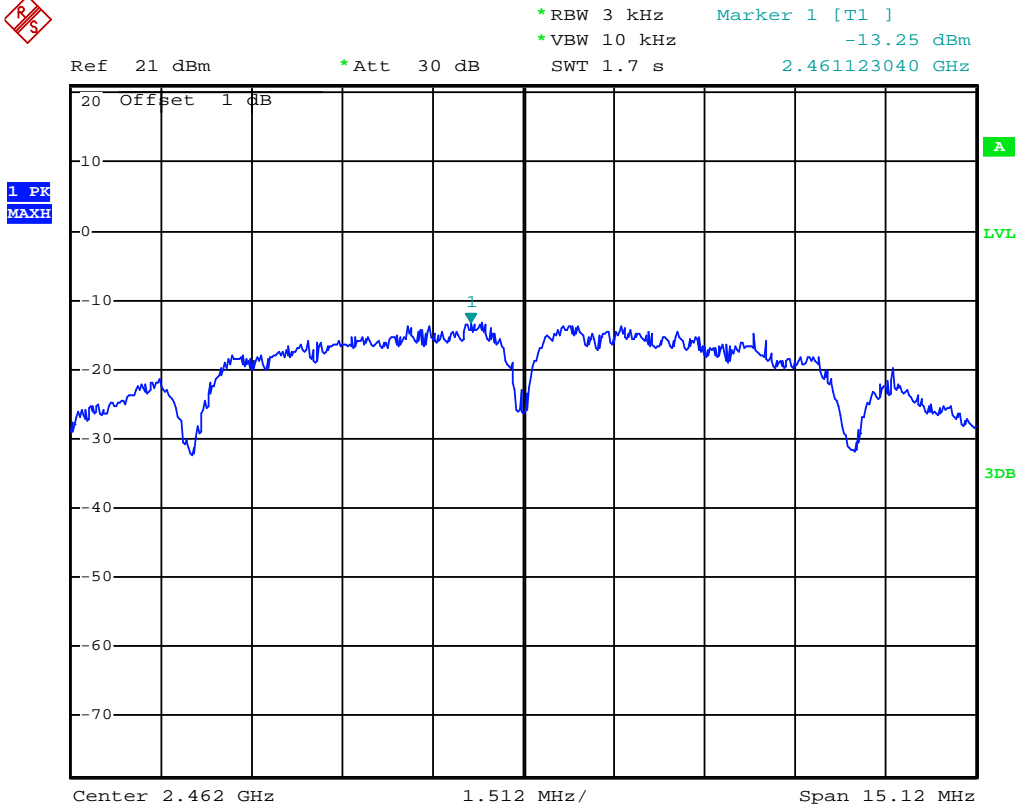

(Plot 4.4.1 C: Channel 11: 2462MHz @ 802.11b)

4.4.2 802.11g Test Mode

A. Test Verdict

Channel	Frequency (MHz)	Report PSD (dBm/3Hz)	Refer to Plot	Limits (dBm/3KHz)	Verdict
1	2412	-14.69	Plot 4.4.2 A	8	PASS
6	2437	-15.63	Plot 4.4.2 B	8	PASS
11	2462	-17.80	Plot 4.4.2 C	8	PASS

Note: 1. For 802.11g mode at final test to get the worst-case emission at 6Mbps.
 2. The test results including the cable lose.

B. Test Plots

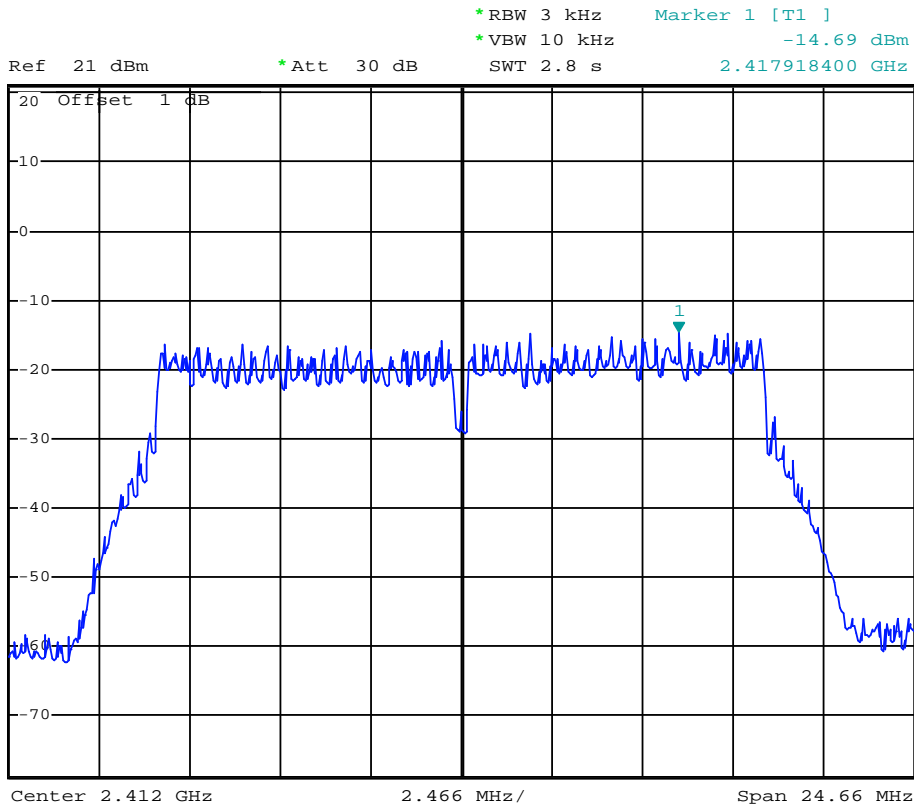

(Plot 4.4.2 A: Channel 1: 2412MHz @ 802.11g)

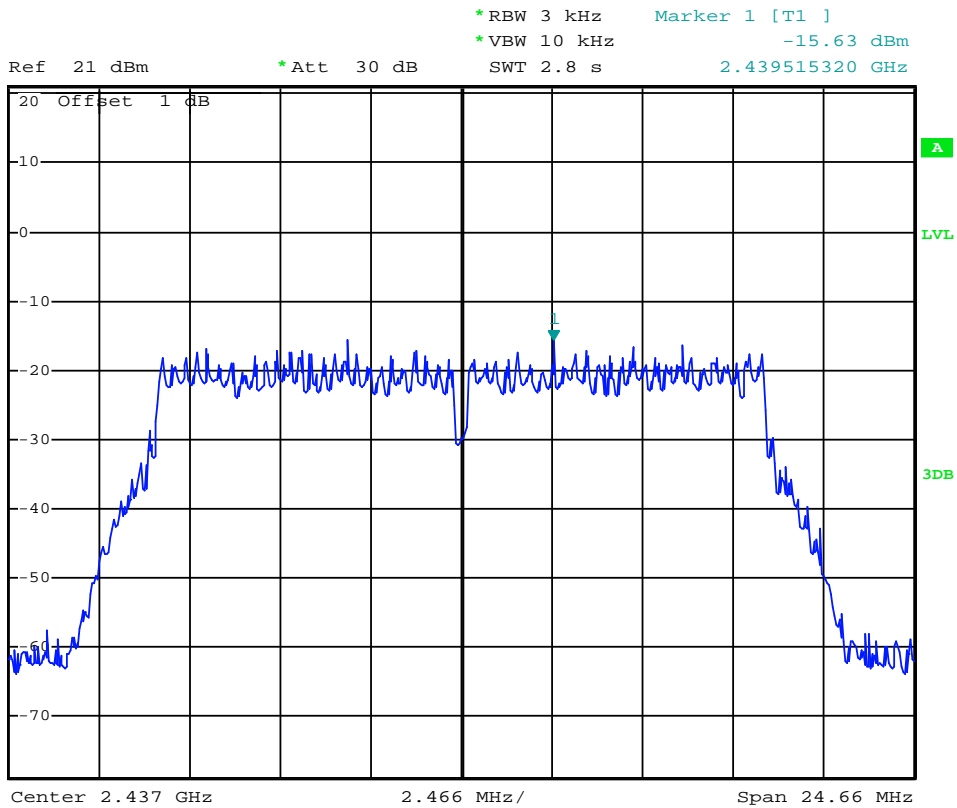

(Plot 4.4.2 B: Channel 6: 2437MHz @ 802.11g)

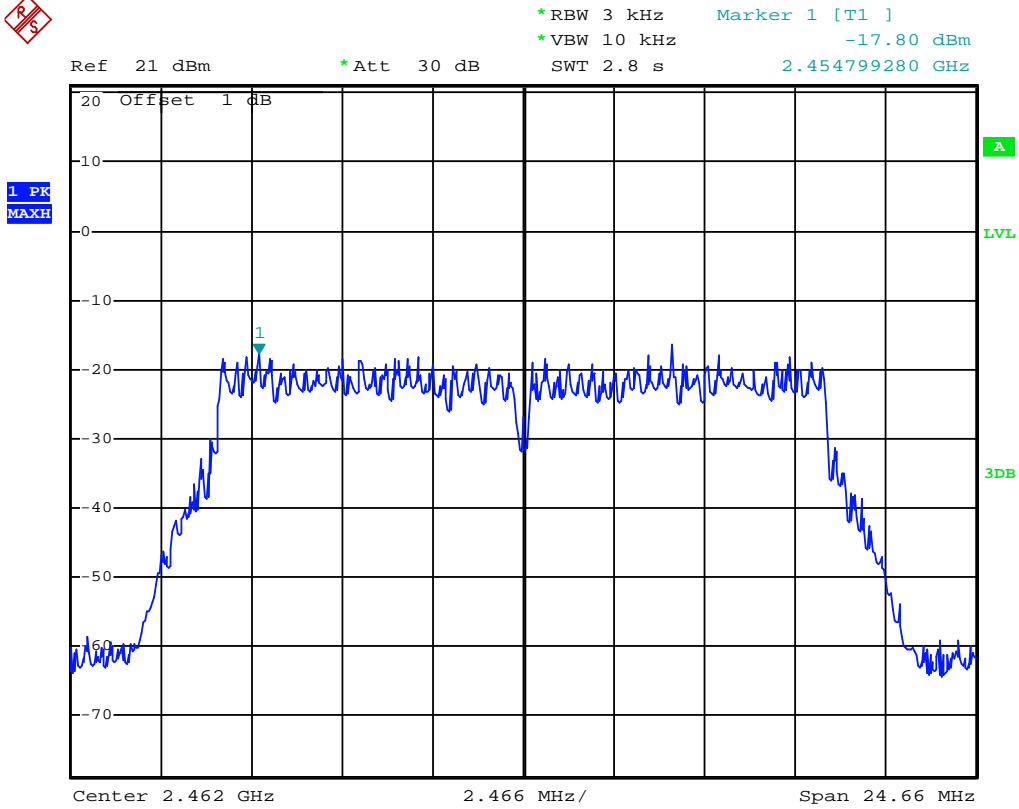

(Plot 4.4.2 C: Channel 11: 2462MHz @ 802.11g)

4.4.3 802.11n(20MHz) Test Mode

A. Test Verdict

Channel	Frequency (MHz)	Report PSD (dBm/3KHz)	Refer to Plot	Limits (dBm/3KHz)	Verdict
1	2412	-15.80	Plot 4.4.3 A	8	PASS
6	2437	-16.87	Plot 4.4.3 B	8	PASS
11	2462	-17.40	Plot 4.4.3 C	8	PASS

Note: 1. For 802.11n(20MHz) mode at final test to get the worst-case emission at 6.5Mbps.
 2. The test results including the cable loss.

B. Test Plots

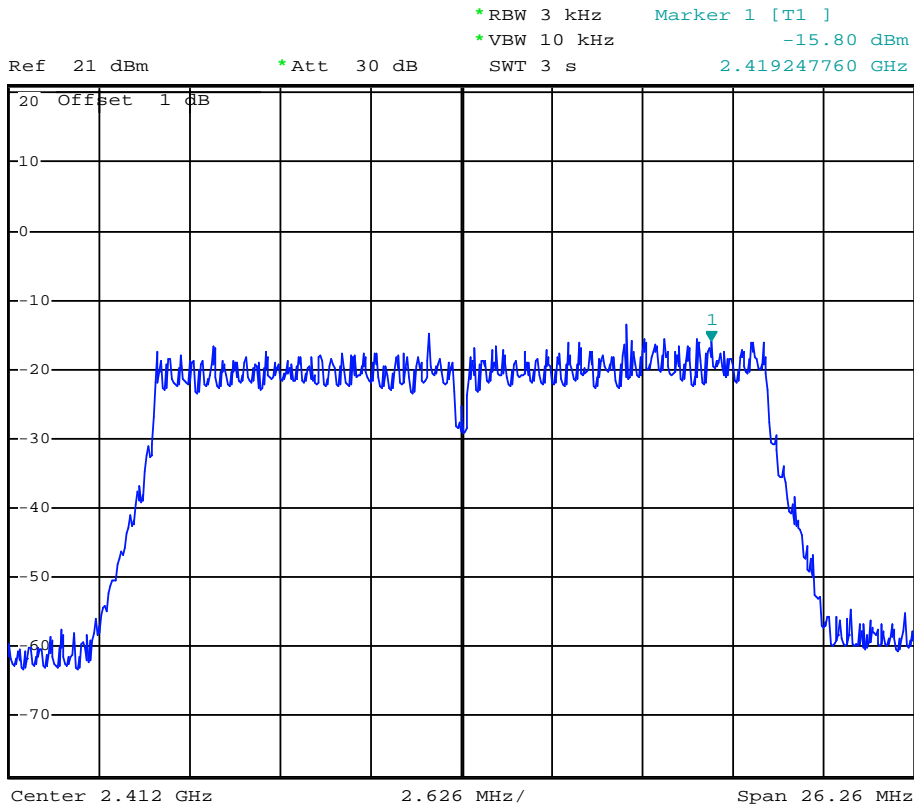

(Plot 4.4.3 A: Channel 1: 2412MHz @ 802.11n(20MHz))

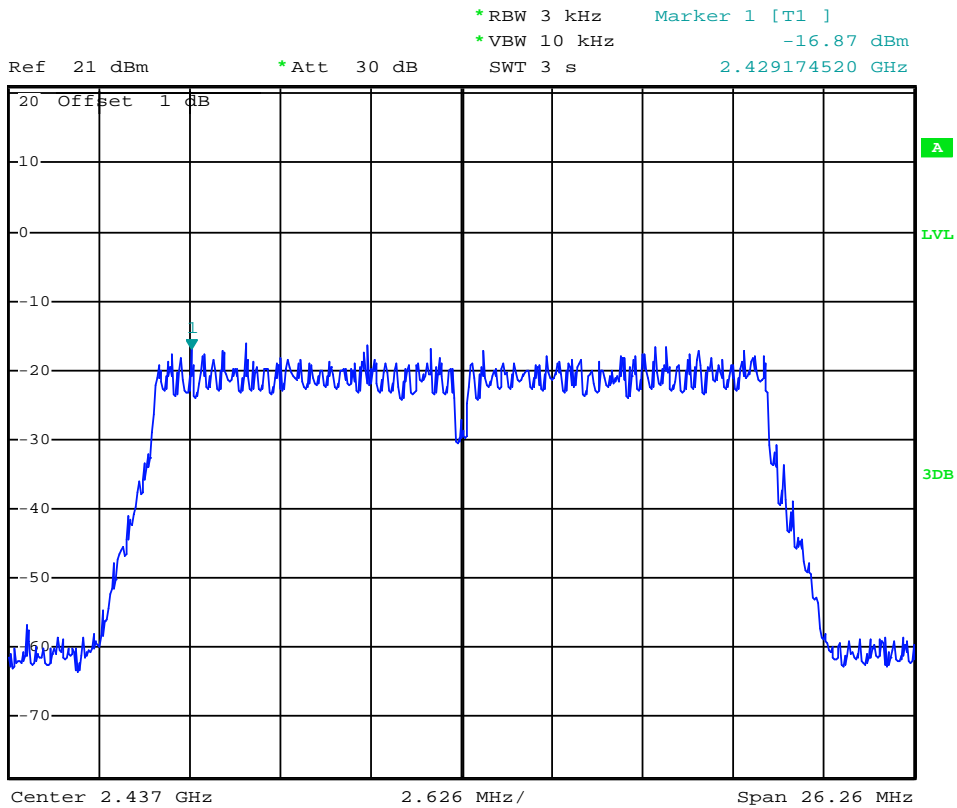

(Plot 4.4.3 B: Channel 6: 2437MHz @ 802.11n(20MHz))

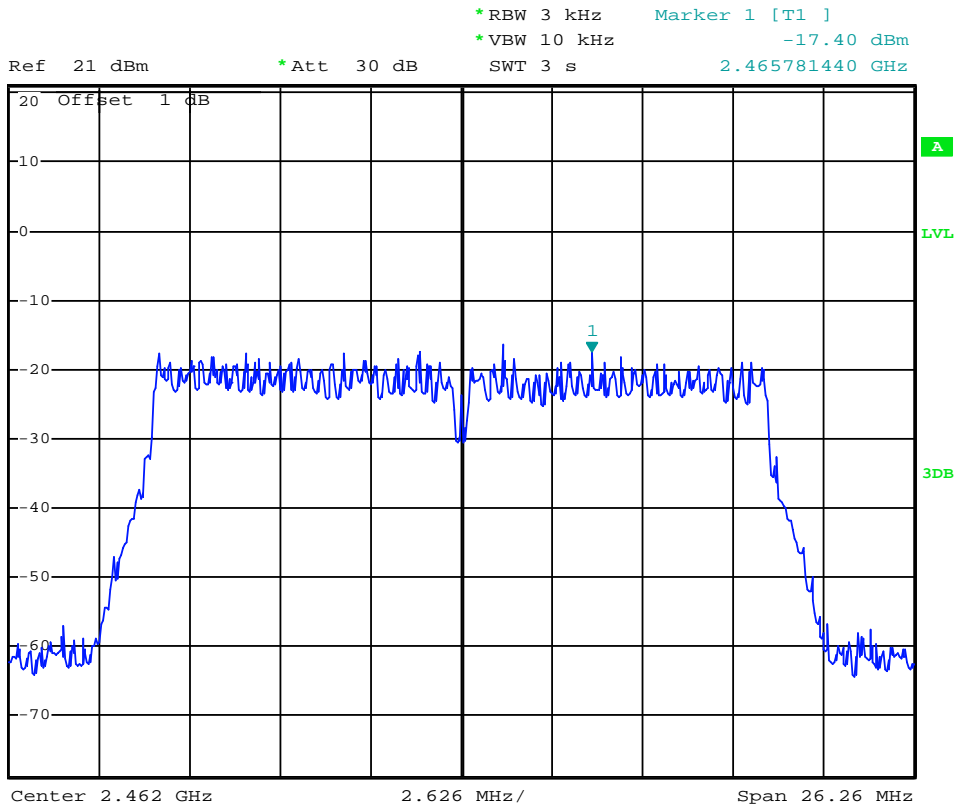

(Plot 4.4.3 C: Channel 11: 2462MHz @ 802.11n(20MHz))

4.4.4 802.11n(40MHz) Test Mode

A. Test Verdict

Channel	Frequency (MHz)	Report PSD (dBm/3KHz)	Refer to Plot	Limits (dBm/3KHz)	Verdict
1	2422	-22.91	Plot 4.4.3 A	8	PASS
6	2437	-21.75	Plot 4.4.3 B	8	PASS
11	2452	-21.51	Plot 4.4.3 C	8	PASS

Note: 1. For 802.11n(20MHz) mode at final test to get the worst-case emission at 13.5Mbps.
 2. The test results including the cable loss.

B. Test Plots

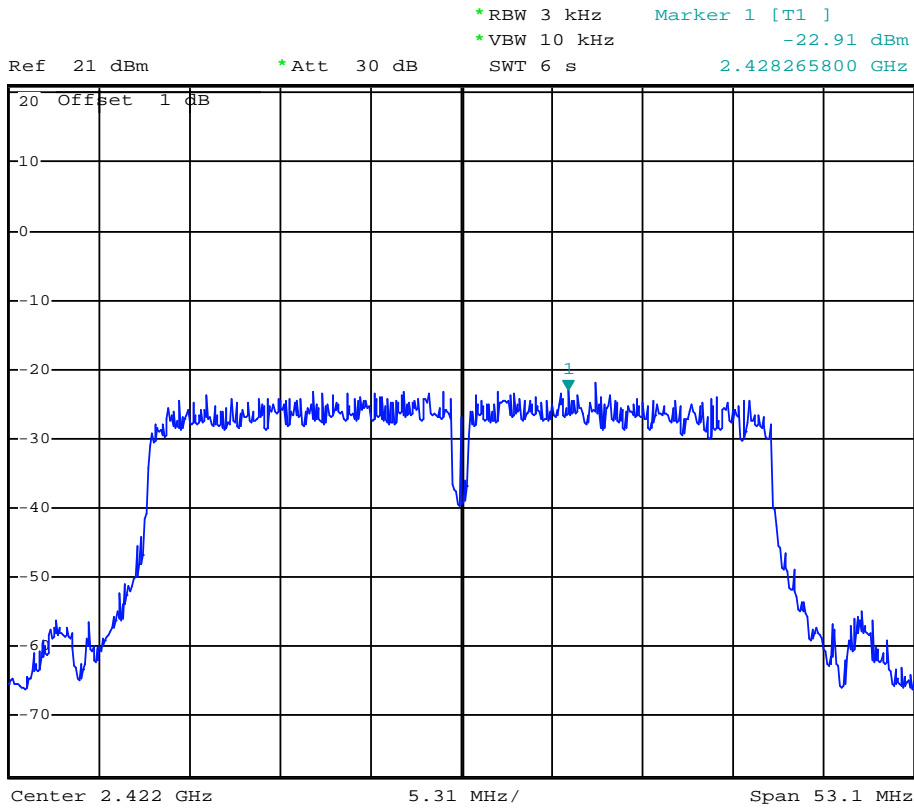

(Plot 4.4.4 A: Channel 3: 2422MHz @ 802.11n(40MHz))

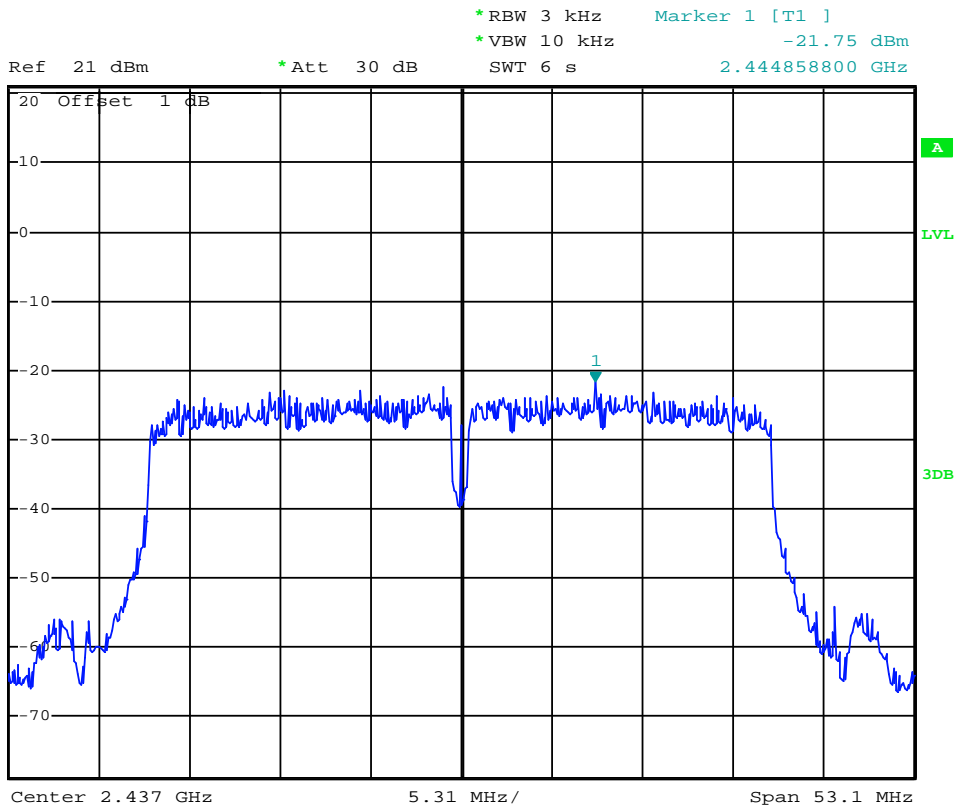

(Plot 4.4.4 B: Channel 6: 2437MHz @ 802.11n(40MHz))



*RBW 3 kHz Marker 1 [T1]
*VBW 10 kHz -21.51 dBm
SWT 6 s 2.450938000 GHz

Ref 21 dBm

*Att 30 dB

1 PK
MAXH

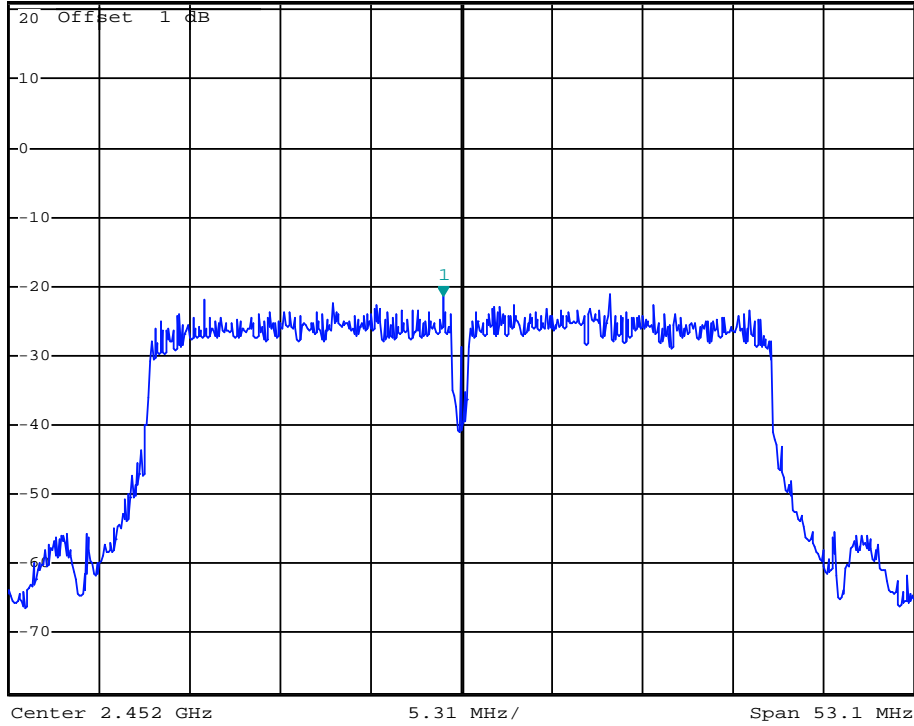

(Plot 4.4.4 C: Channel 9: 2452MHz @ 802.11n(40MHz))

4.5. 6dB Bandwidth

TEST CONFIGURATION

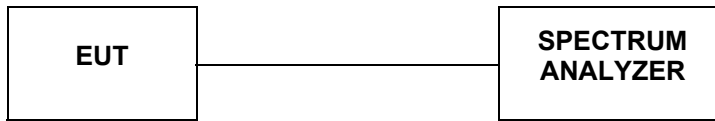

TEST PROCEDURE

The transmitter output was connected to the spectrum analyzer through an attenuator. The bandwidth of the fundamental frequency was measured by spectrum analyzer with RBW=100 KHz and VBW=300KHz. The 6dB bandwidth is defined as the total spectrum the power of which is higher than peak power minus 6dB. According to KDB558074 D01 V03 for one of the following procedures may be used to determine the modulated DTS device signal bandwidth.

1. Set RBW = 100 kHz.
2. Set the video bandwidth (VBW) \geq 3 RBW.
3. Detector = Peak.
4. Trace mode = max hold.
5. Sweep = auto couple.
6. Allow the trace to stabilize.
7. Measure the maximum width of the emission that is constrained by the frequencies associated with the two outermost amplitude points (upper and lower frequencies) that are attenuated by 6 dB relative to the maximum level measured in the fundamental emission.

LIMIT

For digital modulation systems, the minimum 6 dB bandwidth shall be at least 500 kHz

TEST RESULTS

4.7.1 801.11b Test Mode

A. Test Verdict

Channel	Frequency (MHz)	6 dB Bandwidth (MHz)	Refer to Plot	Limits (kHz)	Verdict
1	2412	10.08	Plot 4.5.1 A	\geq 500	PASS
6	2437	10.08	Plot 4.5.1 B	\geq 500	PASS
11	2462	10.14	Plot 4.5.1 C	\geq 500	PASS

Note: 1. For 802.11b mode at final test to get the worst-case emission at 1Mbps.
2.The test results including the cable lose.

B. Test Plots

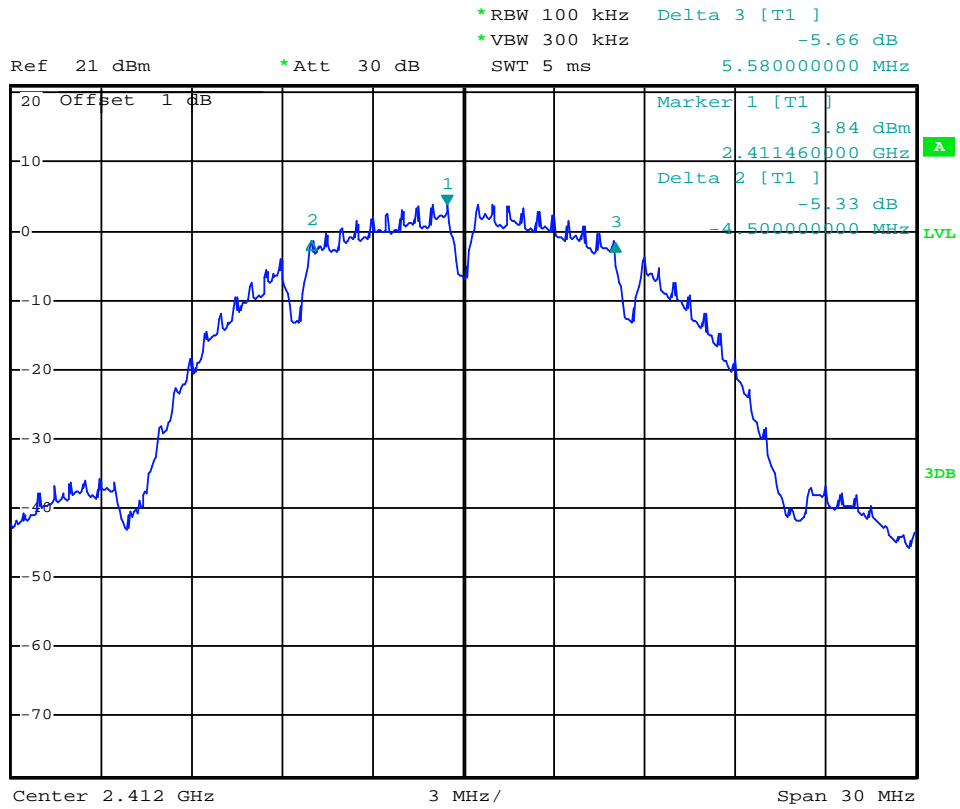

(Plot 4.5.1 A: Channel 1: 2412MHz @ 802.11b)

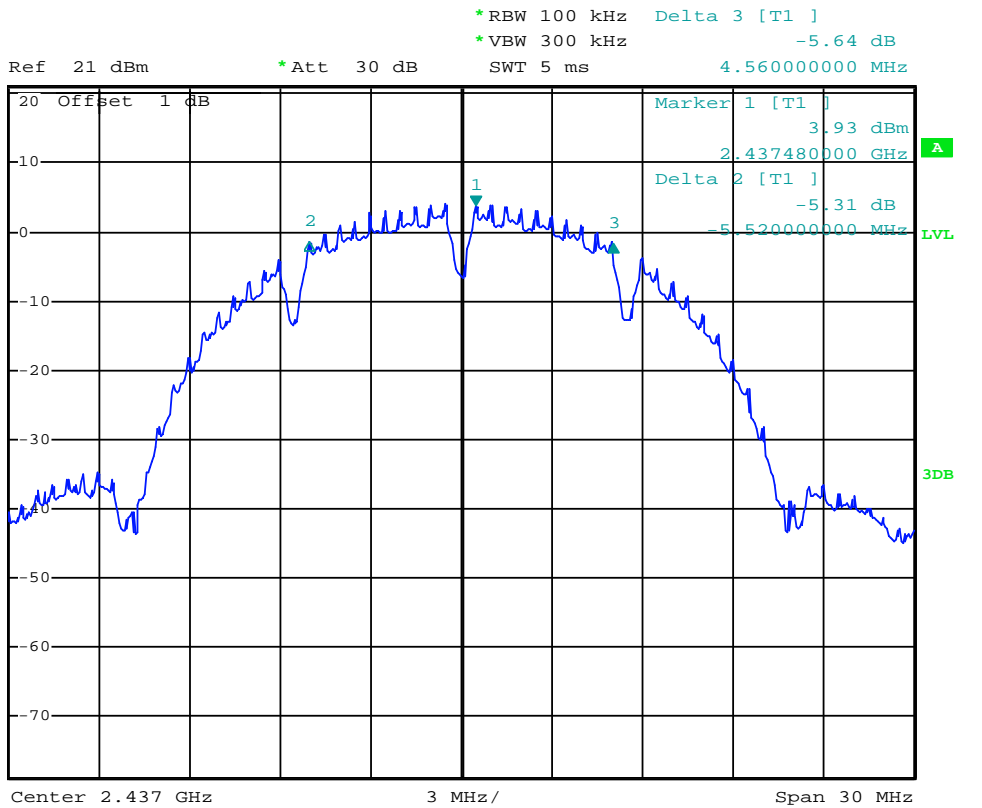

(Plot 4.5.1 B: Channel 6: 2437MHz @ 802.11b)

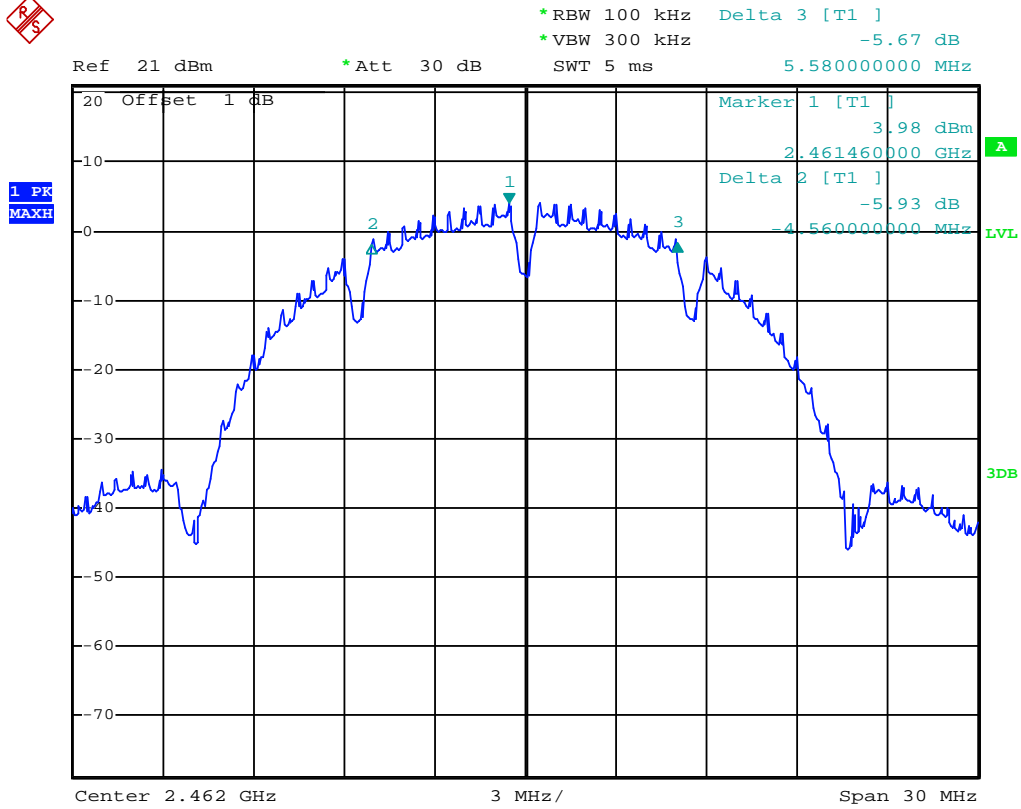

(Plot 4.5.1 C: Channel 11: 2462MHz @ 802.11b)

4.7.2 801.11g Test Mode

A. Test Verdict

Channel	Frequency (MHz)	6 dB Bandwidth (MHz)	Refer to Plot	Limits (kHz)	Verdict
1	2412	16.44	Plot 4.5.2 A	≥500	PASS
6	2437	16.44	Plot 4.5.2 B	≥500	PASS
11	2462	16.50	Plot 4.5.2 C	≥500	PASS

Note: 1. For 802.11g mode at final test to get the worst-case emission at 6Mbps.
 2. The test results including the cable lose.

B. Test Plots

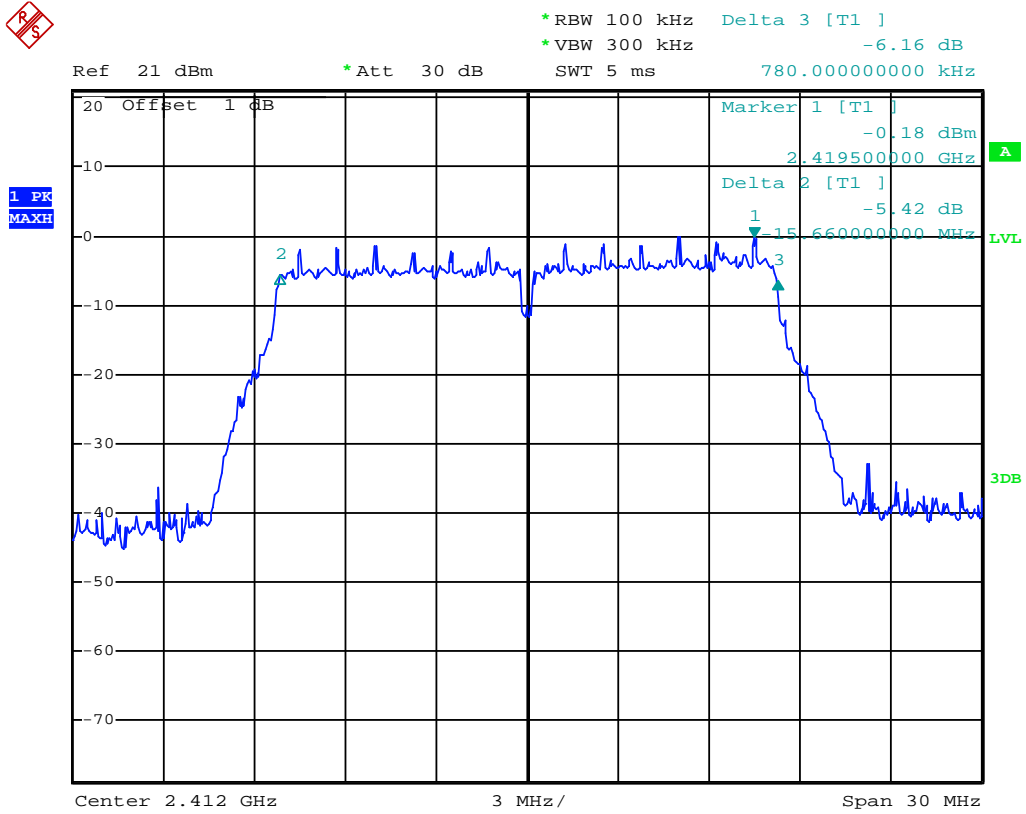

(Plot 4.5.2 A: Channel 1: 2412MHz @ 802.11g)

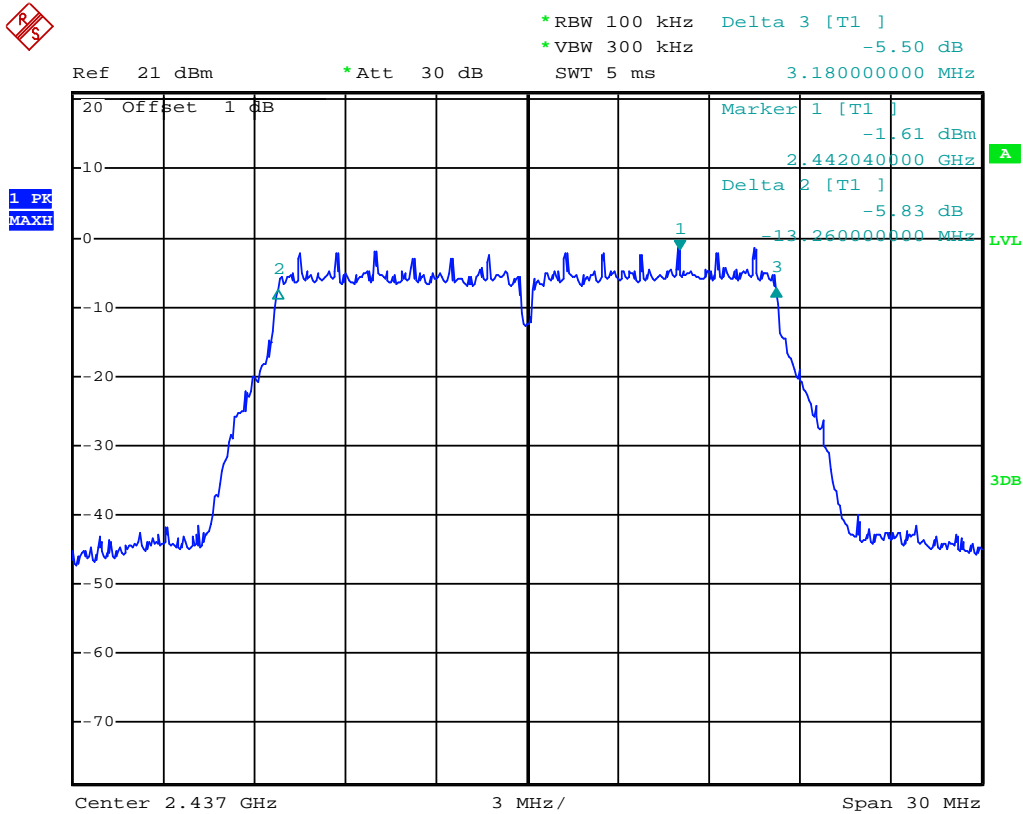

(Plot 4.5.2 B: Channel 6: 2437MHz @ 802.11g)

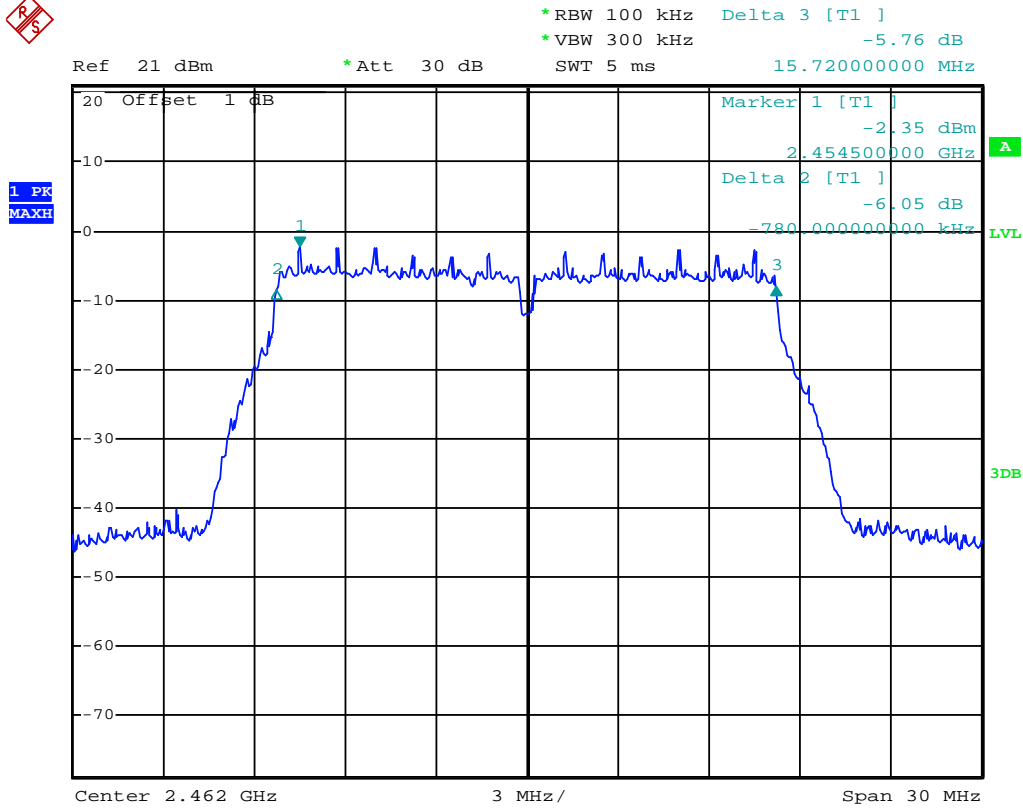

(Plot 4.5.2 C: Channel 11: 2462MHz @ 802.11g)

4.7.3 801.11n(20MHz) Test Mode

A. Test Verdict

Channel	Frequency (MHz)	6 dB Bandwidth (MHz)	Refer to Plot	Limits (kHz)	Verdict
1	2412	17.64	Plot 4.5.3 A	≥500	PASS
6	2437	17.64	Plot 4.5.3 B	≥500	PASS
11	2462	17.70	Plot 4.5.3 C	≥500	PASS

Note: 1. For 802.11n(20MHz) mode at final test to get the worst-case emission at 6.5Mbps.
 2. The test results including the cable lose.

B. Test Plots

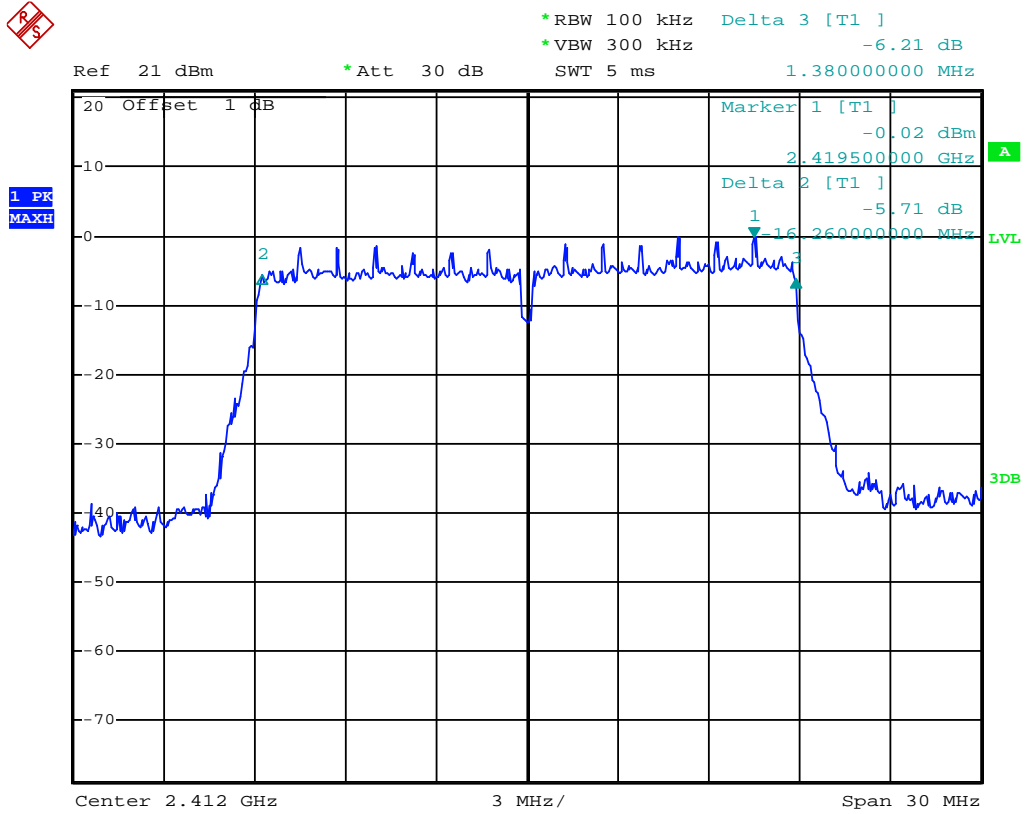

(Plot 4.5.3 A: Channel 1: 2412MHz @ 802.11n(20MHz))

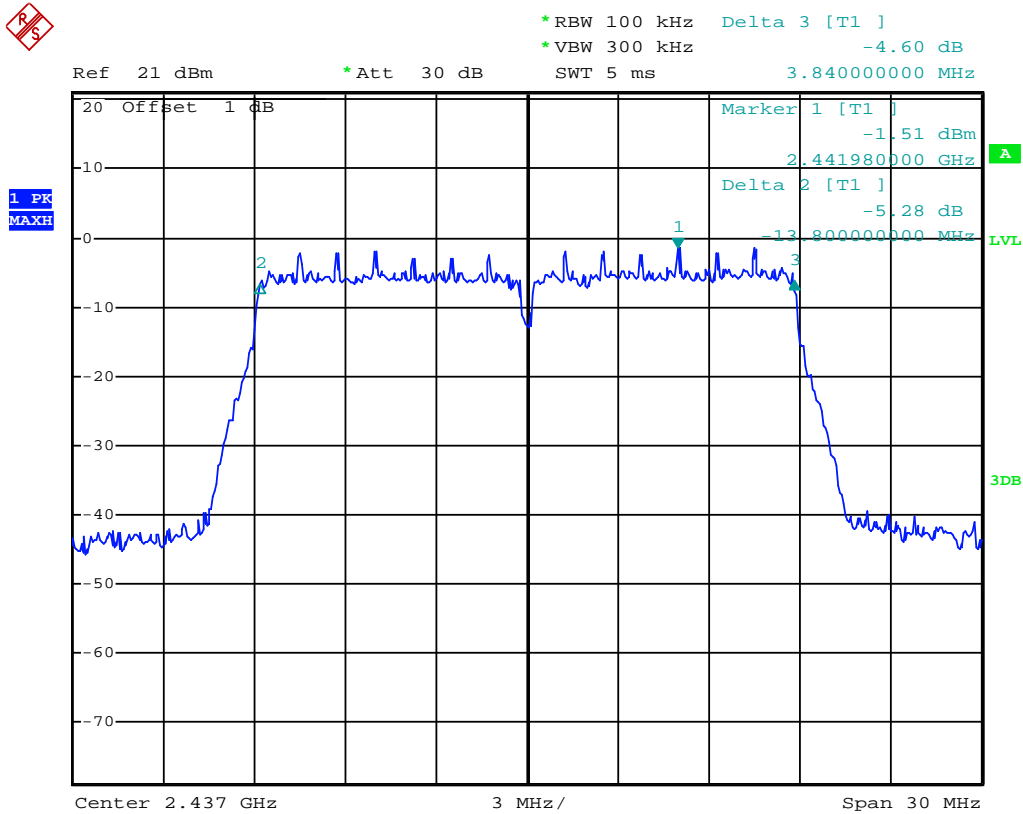

(Plot 4.5.3 B: Channel 6: 2437MHz @ 802.11n(20MHz))

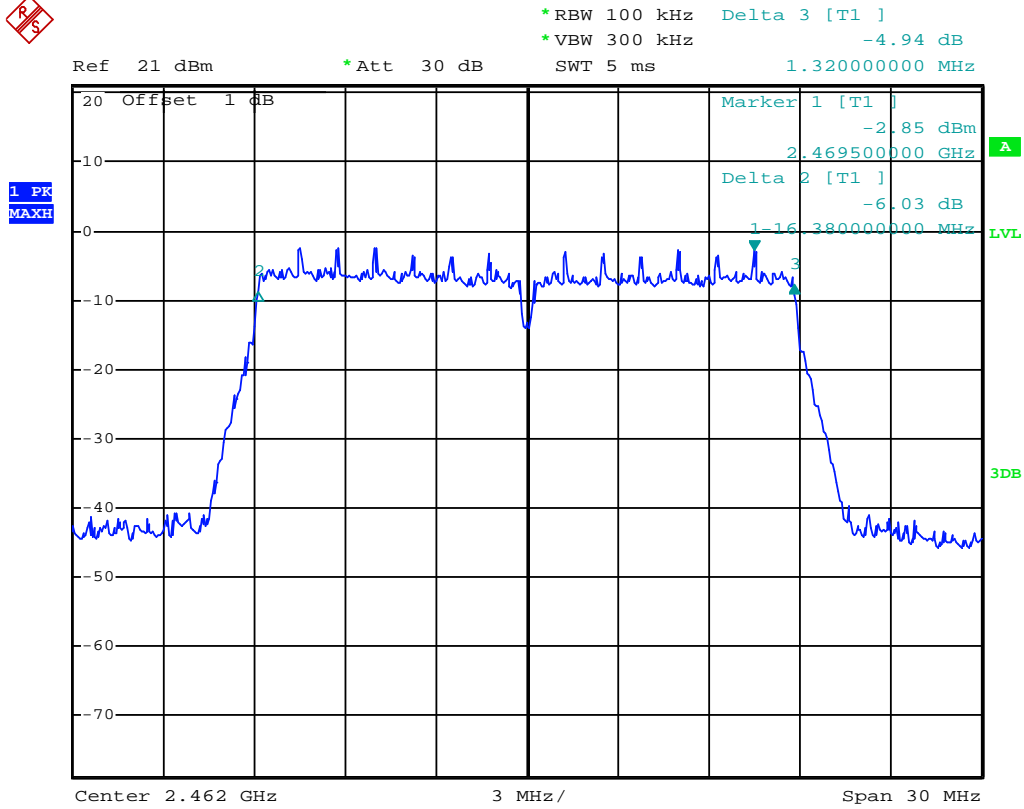

(Plot 4.5.3 C: Channel 11: 2462MHz @ 802.11n(20MHz))

4.7.4 801.11n(40MHz) Test Mode

A. Test Verdict

Channel	Frequency (MHz)	6 dB Bandwidth (MHz)	Refer to Plot	Limits (kHz)	Verdict
3	2422	35.50	Plot 4.7.3 A	≥500	PASS
6	2437	35.40	Plot 4.7.3 B	≥500	PASS
9	2452	35.50	Plot 4.7.3 C	≥500	PASS

Note: 1. For 802.11n(20MHz) mode at final test to get the worst-case emission at 13.5Mbps.
 2. The test results including the cable loss.

B. Test Plots

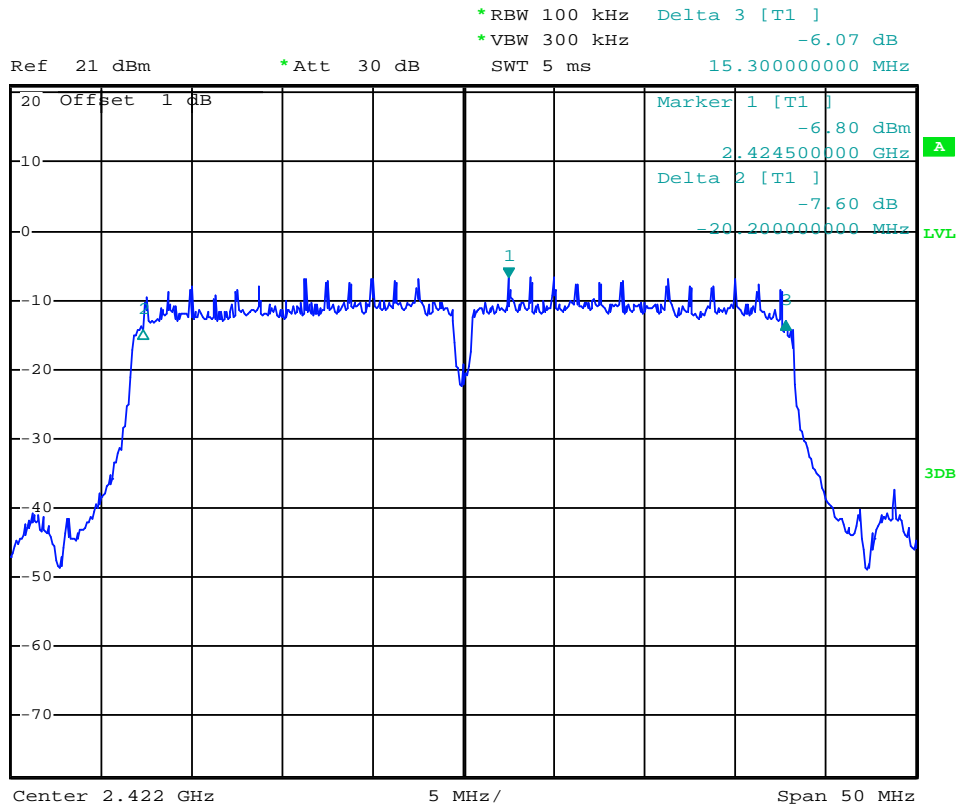

(Plot 4.5.4 A: Channel 3: 2422MHz @ 802.11n(40MHz))

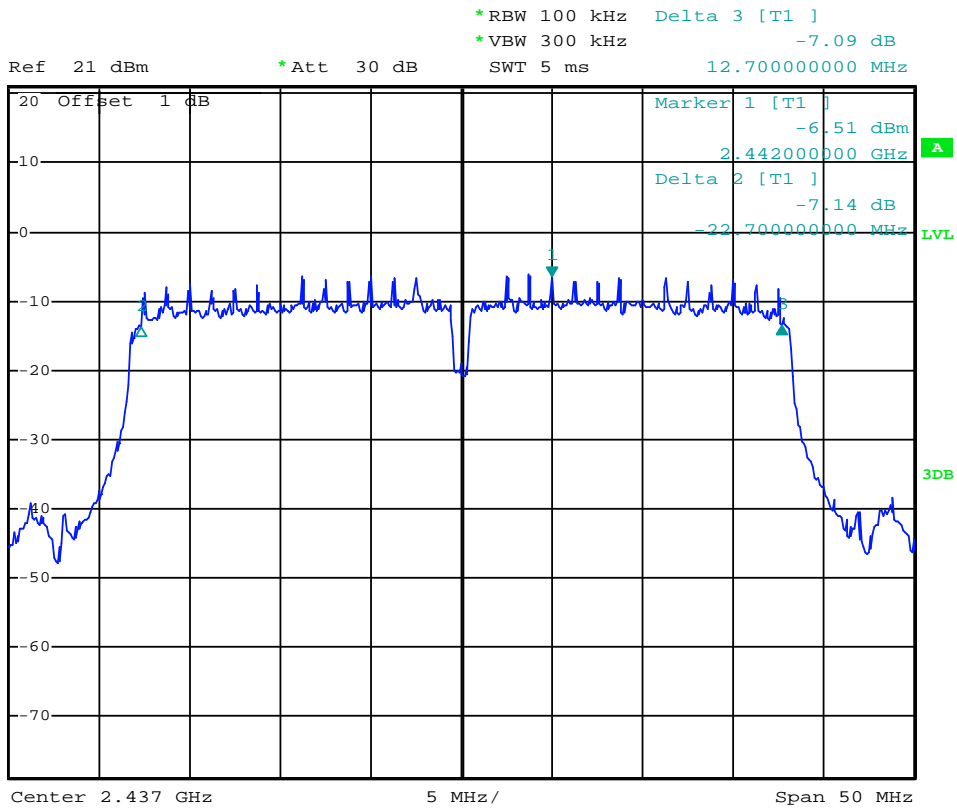

(Plot 4.5.4 B: Channel 6: 2437MHz @ 802.11n(40MHz))

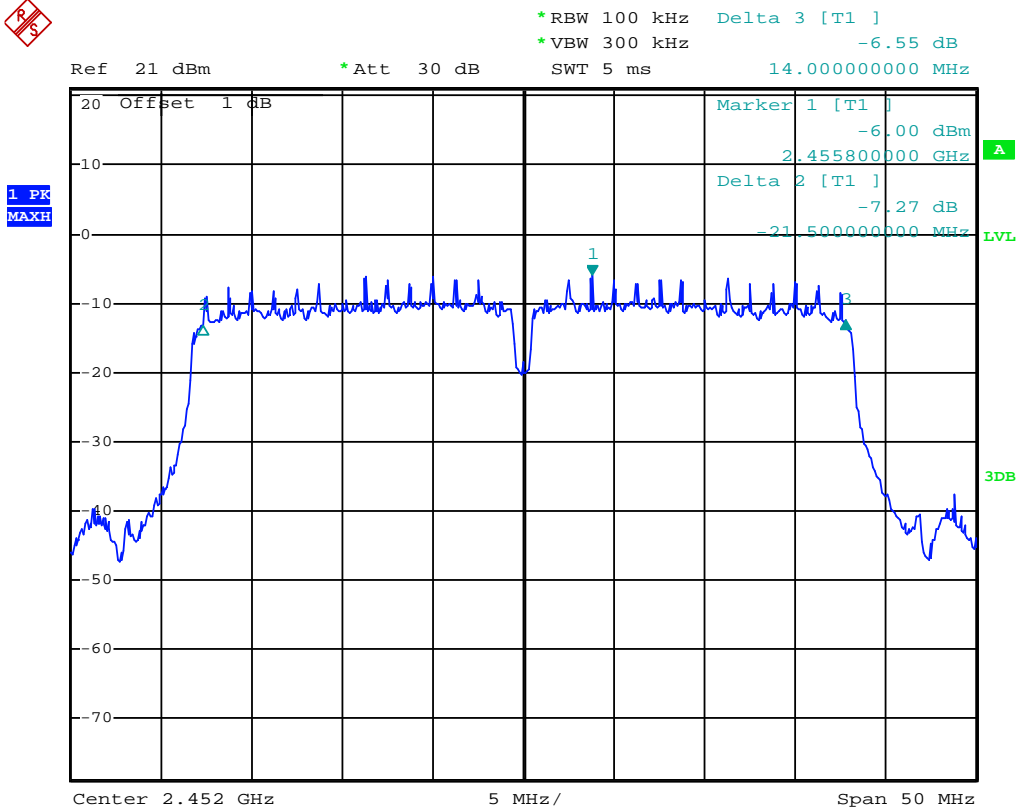

(Plot 4.5.4 C: Channel 9: 2452MHz @ 802.11n(40MHz))

4.6. Band Edge Compliance of RF Emission

TEST REQUIREMENT

In any 100 kHz bandwidth outside the frequency band in which the spread spectrum or digitally modulated intentional radiator is operating, the radio frequency power that is produced by the intentional radiator shall be at least 20 dB below that in the 100 kHz bandwidth within the band that contains the highest level of the desired power, based on either an RF conducted or a radiated measurement, provided the transmitter demonstrates compliance with the peak conducted power limits. If the transmitter complies with the conducted power limits based on the use of RMS averaging over a time interval, as permitted under paragraph (b)(3) of this section, the attenuation required under this paragraph shall be 30 dB instead of 20 dB. Attenuation below the general limits specified in §15.209(a) is not required. In addition, radiated emissions which fall in the restricted bands, as defined in §15.205(a), must also comply with the radiated emission limits specified in §15.209(a) (see §15.205(c)).

TEST PROCEDURE

According to KDB 558074 D01 V03 for Antenna-port conducted measurement. Antenna-port conducted measurements may also be used as an alternative to radiated measurements for demonstrating compliance in the restricted frequency bands. If conducted measurements are performed, then proper impedance matching must be ensured and an additional radiated test for cabinet/case spurious emissions is required.

1. Check the calibration of the measuring instrument using either an internal calibrator or a known signal from an external generator.
2. Remove the antenna from the EUT and then connect to a low loss RF cable from the antenna port to a EMI test receiver, then turn on the EUT and make it operate in transmitting mode. Then set it to Low Channel and High Channel within its operating range, and make sure the instrument is operated in its linear range.
3. Set both RBW and VBW of spectrum analyzer to 100 kHz with a convenient frequency span including 100kHz bandwidth from band edge, for Radiated emissions restricted band RBW=1MHz, VBW=3MHz for peak detector and RBW=1MHz, VBW=10Hz for average detector.
4. Measure the highest amplitude appearing on spectral display and set it as a reference level. Plot the graph with marking the highest point and edge frequency.
5. Repeat above procedures until all measured frequencies were complete.
6. Measure the conducted output power (in dBm) using the detector specified by the appropriate regulatory agency (see 12.2.2, 12.2.3, and 12.2.4 for guidance regarding measurement procedures for determining quasi-peak, peak, and average conducted output power, respectively).
7. Add the maximum transmit antenna gain (in dBi) to the measured output power level to determine the EIRP level (see 12.2.5 for guidance on determining the applicable antenna gain)
8. Add the appropriate maximum ground reflection factor to the EIRP level (6 dB for frequencies \leq 30 MHz, 4.7 dB for frequencies between 30 MHz and 1000 MHz, inclusive and 0 dB for frequencies $>$ 1000 MHz).
9. For devices with multiple antenna-ports, measure the power of each individual chain and sum the EIRP of all chains in linear terms (e.g., Watts, mW).
10. Convert the resultant EIRP level to an equivalent electric field strength using the following relationship:

$$E = \text{EIRP} - 20\log D + 104.8$$

where:

E = electric field strength in dB μ V/m,

EIRP = equivalent isotropic radiated power in dBm

D = specified measurement distance in meters.

11. Since the out-of-band characteristics of the EUT transmit antenna will often be unknown, the use of a conservative antenna gain value is necessary. Thus, when determining the EIRP based on the measured conducted power, the upper bound on antenna gain for a device with a single RF output shall be selected as the maximum in-band gain of the antenna across all operating bands, or 2 dBi, whichever is greater. However, for devices that operate in multiple frequency bands while using the same transmit antenna, the highest gain of the antenna within the operating band nearest in frequency to the restricted band emission being measured may be used in lieu of the overall highest gain when the emission is at a frequency that is within 20 percent of the nearest band edge frequency, but in no case shall a value less than 2 dBi be used.
12. Compare the resultant electric field strength level to the applicable regulatory limit.
13. Perform radiated spurious emission test dures until all measured frequencies were complete.

LIMIT

Below -20dB of the highest emission level in operating band.

Radiated emissions which fall in the restricted bands, as defined in § 15.205(a), must also comply with the radiated emission limits specified in § 15.209(a)

TEST RESULTS

4.5.1 802.11b Test Mode

A. Test Verdict

Frequency (MHz)	Conducted Power (dBm)	Antenna Gain (dBi)	Ground Reflection Factor (dB)	Covert Radiated E Level At 3m (dBuV/m)	Detector	Limit (dBuV/m)	Refer to Plot
2390.00	-45.81	2.00	0.00	51.45	Peak	74.00	Plot 4.5.1 A1
2390.00	-57.74	2.00	0.00	39.52	AV	54.00	Plot 4.5.1 A2
2413.20	7.92	2.00	0.00	105.18	Peak	---	Plot 4.5.1 A1
2411.52	1.87	2.00	0.00	99.13	AV	---	Plot 4.5.1 A2
2463.10	7.01	2.00	0.00	104.27	Peak	---	Plot 4.5.1 A3
2461.10	1.08	2.00	0.00	98.34	AV	---	Plot 4.5.1 A4
2483.50	-46.52	2.00	0.00	50.74	Peak	74.00	Plot 4.5.1 A3
2483.50	-58.35	2.00	0.00	38.91	AV	54.00	Plot 4.5.1 A4

- Note:
1. For 802.11b mode at final test to get the worst-case emission at 1Mbps.
 2. The test results including the cable lose.
 3. "----" means that the fundamental frequency not for 15.209 limits requirement.

B. Test Plots

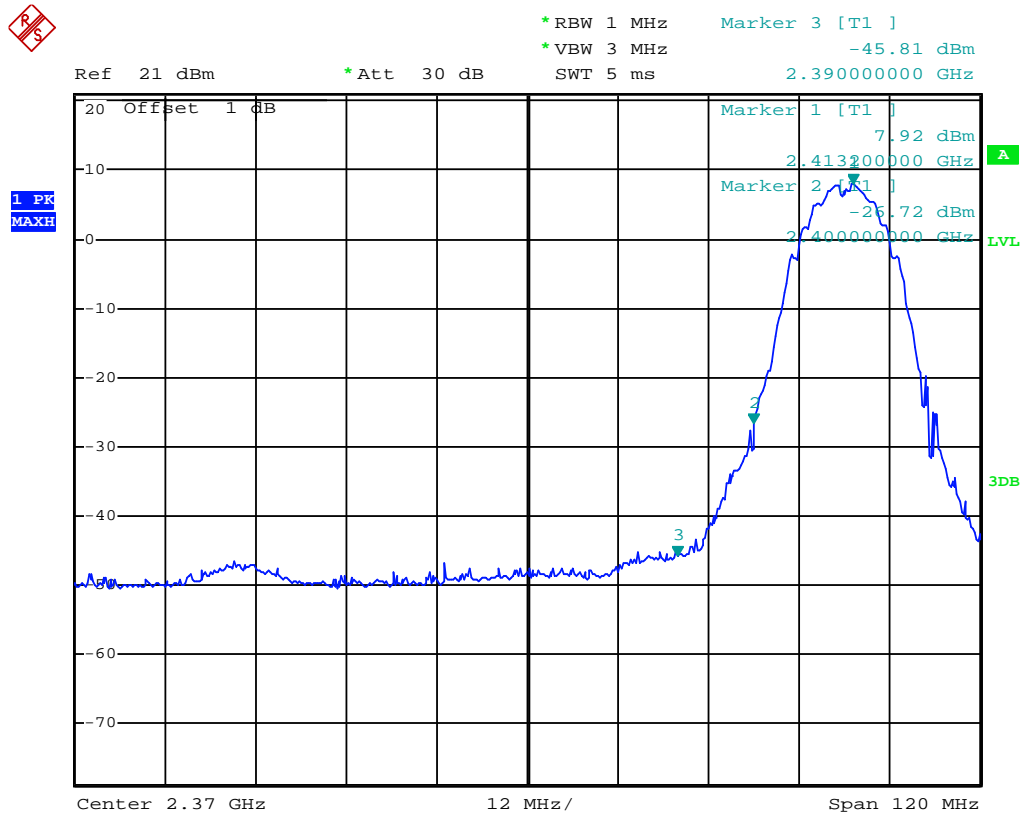

(Plot 4.5.1 A1: Channel 1: 2412MHz @ 802.11b)

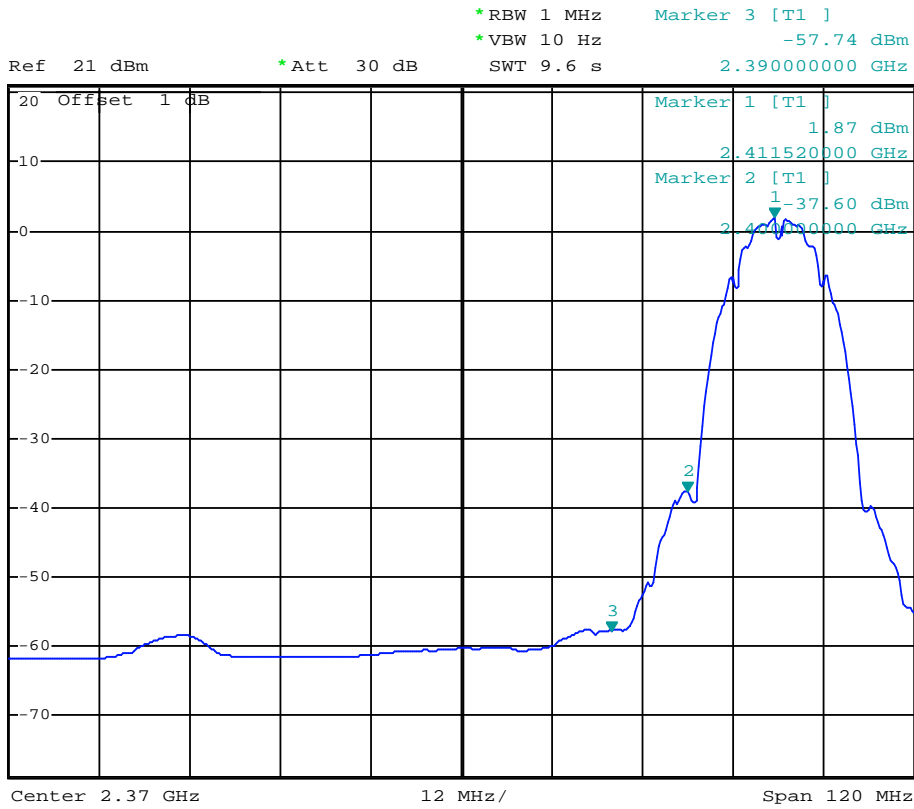

(Plot 4.5.1 A2: Channel 1: 2412MHz @ 802.11b)

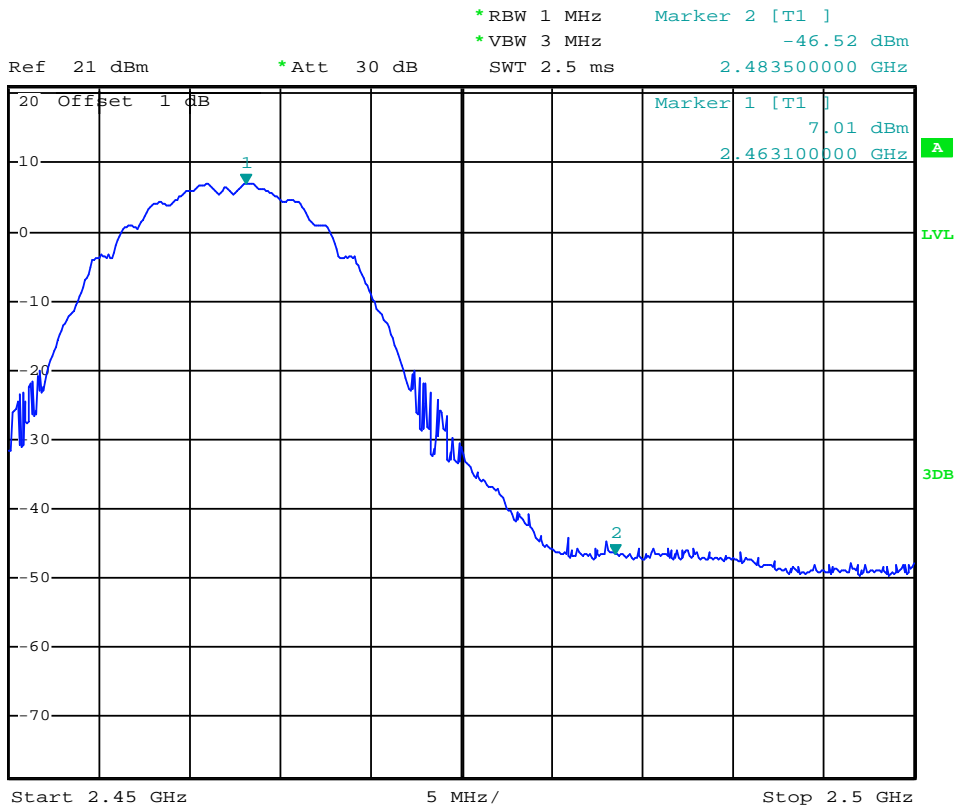

(Plot 4.5.1 A3: Channel 11: 2462MHz @ 802.11b)

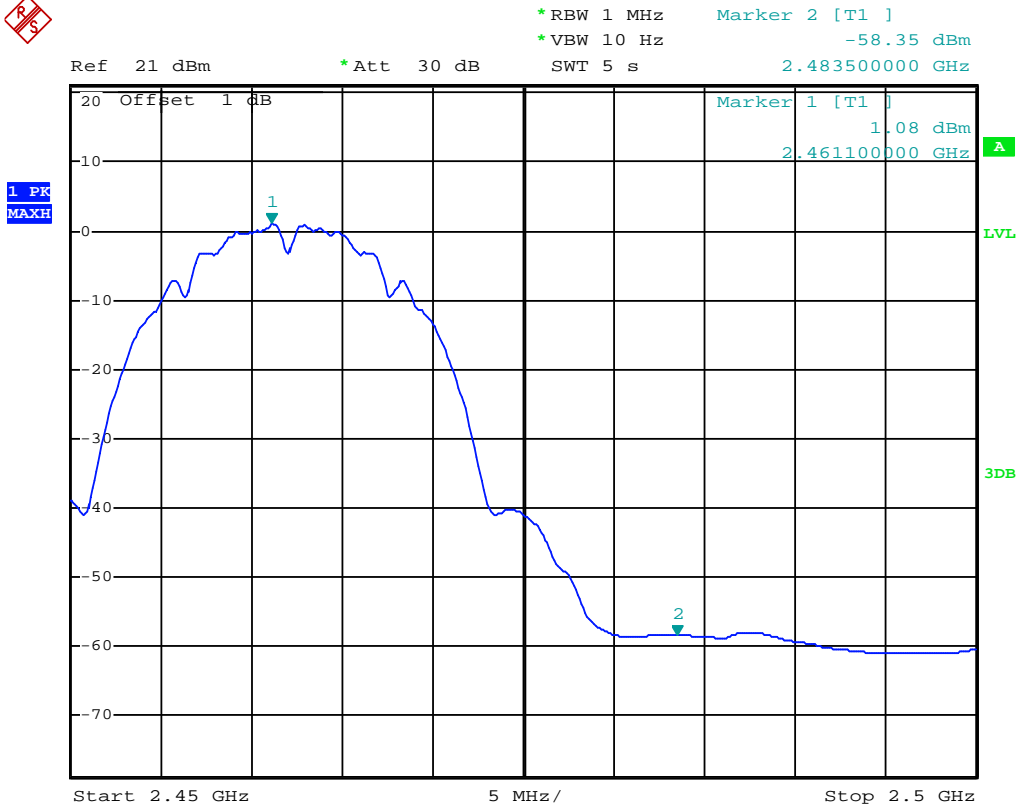

(Plot 4.5.1 A4: Channel 11: 2462MHz @ 802.11b)

4.5.2 802.11g Test Mode

A. Test Verdict

Frequency (MHz)	Conducted Power (dBm)	Antenna Gain (dBi)	Ground Reflection Factor (dB)	Covert Radiated E Level At 3m (dBuV/m)	Detector	Limit (dBuV/m)	Refer to Plot
2390.00	-46.96	2.00	0.00	50.30	Peak	74.00	Plot 4.5.2 A1
2390.00	-59.40	2.00	0.00	37.86	AV	54.00	Plot 4.5.2 A2
2406.48	3.06	2.00	0.00	100.32	Peak	---	Plot 4.5.2 A1
2408.40	-9.04	2.00	0.00	88.22	AV	---	Plot 4.5.2 A2
2458.90	2.98	2.00	0.00	100.24	Peak	---	Plot 4.5.2 A3
2466.00	-9.54	2.00	0.00	87.72	AV	---	Plot 4.5.2 A4
2483.50	-44.28	2.00	0.00	52.98	Peak	74.00	Plot 4.5.2 A3
2483.50	-59.44	2.00	0.00	37.82	AV	54.00	Plot 4.5.2 A4

- Note: 1. For 802.11g mode at final test to get the worst-case emission at 6Mbps.
 2. The test results including the cable lose.
 3. “---” means that the fundamental frequency not for 15.209 limits requirement.

B. Test Plots

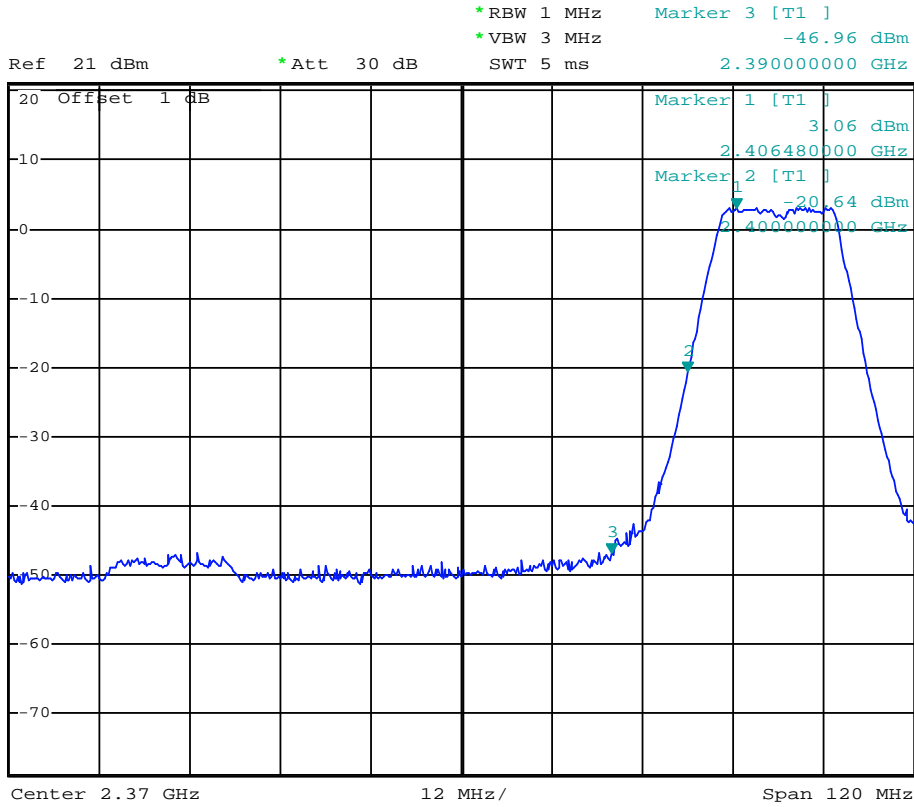

(Plot 4.5.2 A1: Channel 1: 2412MHz @ 802.11g)

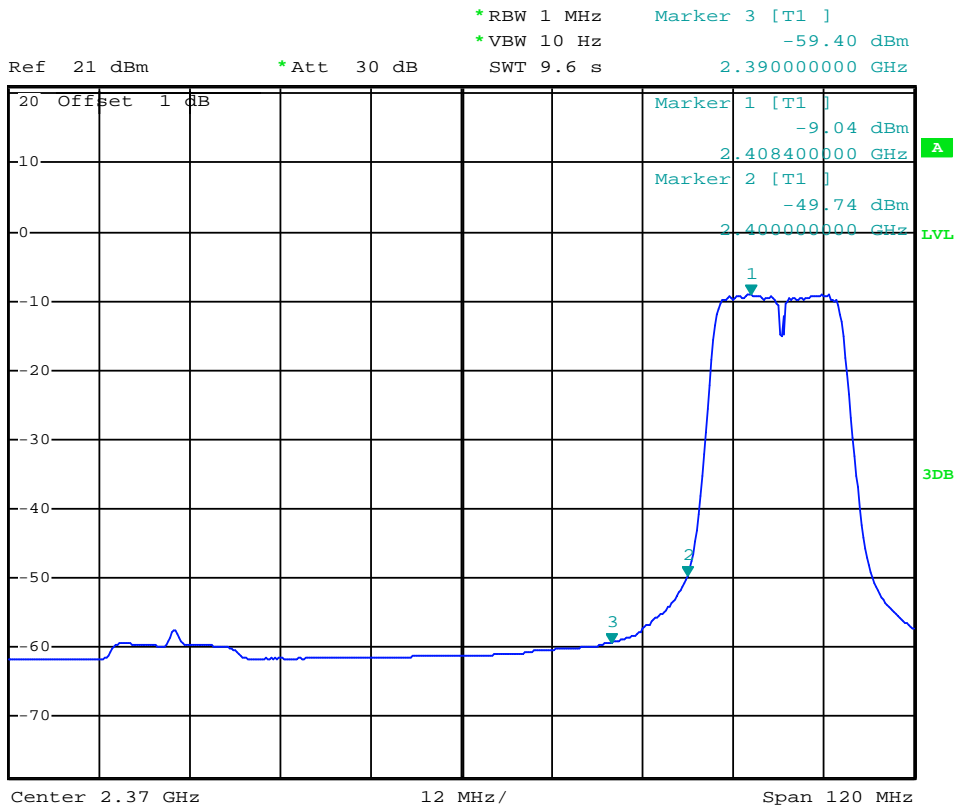

(Plot 4.5.2 A2: Channel 1: 2412MHz @ 802.11g)

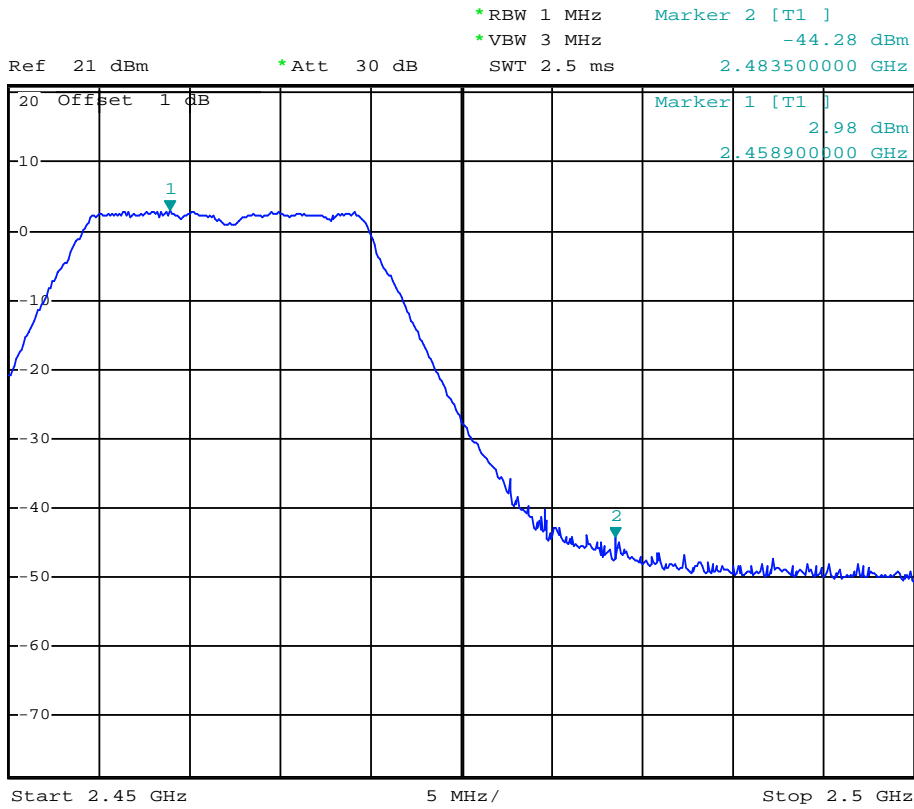

(Plot 4.5.2 A3: Channel 11: 2462MHz @ 802.11g)

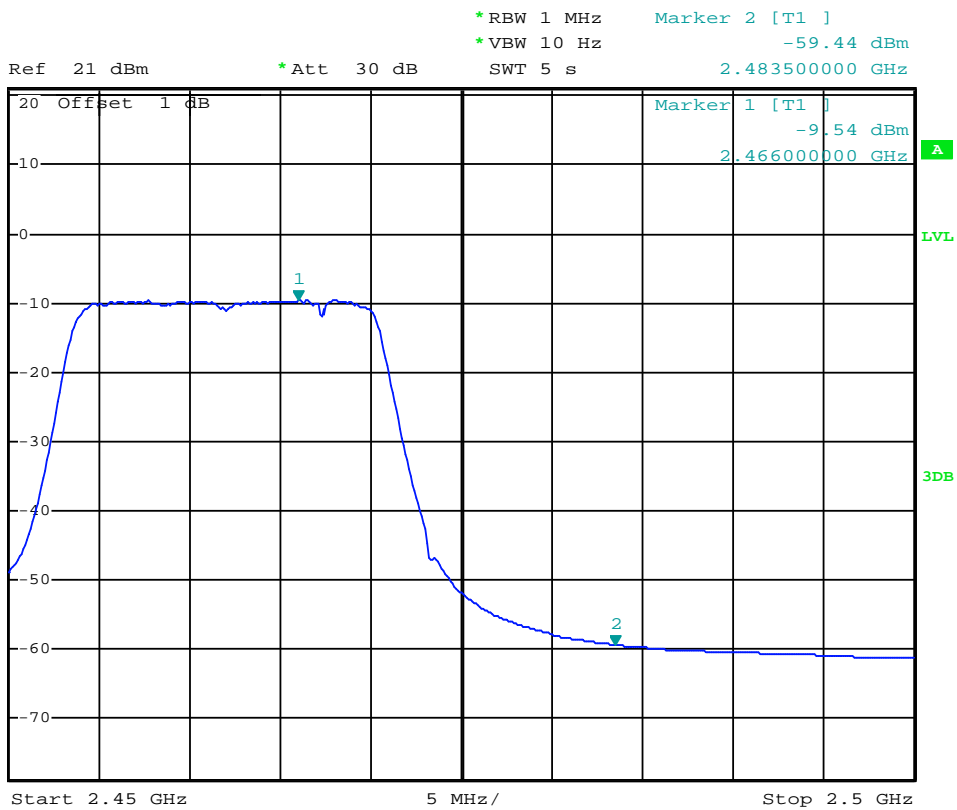

(Plot 4.5.2 A4: Channel 11: 2462MHz @ 802.11g)

4.5.3 802.11n(20MHz) Test Mode

A. Test Verdict

Frequency (MHz)	Conducted Power (dBm)	Antenna Gain (dBi)	Ground Reflection Factor (dB)	Covert Radiated E Level At 3m (dBuV/m)	Detector	Limit (dBuV/m)	Refer to Plot
2390.00	-41.21	2.00	0.00	56.05	Peak	74.00	Plot 4.5.3 A1
2390.00	-59.04	2.00	0.00	38.22	AV	54.00	Plot 4.5.3 A2
2415.60	3.28	2.00	0.00	100.54	Peak	---	Plot 4.5.3 A1
2417.76	-9.48	2.00	0.00	87.78	AV	---	Plot 4.5.3 A2
2460.40	2.08	2.00	0.00	99.34	Peak	---	Plot 4.5.3 A3
2465.20	-10.45	2.00	0.00	86.81	AV	---	Plot 4.5.3 A4
2483.50	-41.11	2.00	0.00	56.15	Peak	74.00	Plot 4.5.3 A3
2483.50	-59.40	2.00	0.00	37.86	AV	54.00	Plot 4.5.3 A4

- Note: 1. For 802.11n(20MHz) mode at final test to get the worst-case emission at 6.5Mbps.
 2. The test results including the cable lose.
 3. "----" means that the fundamental frequency not for 15.209 limits requirement.

B. Test Plots

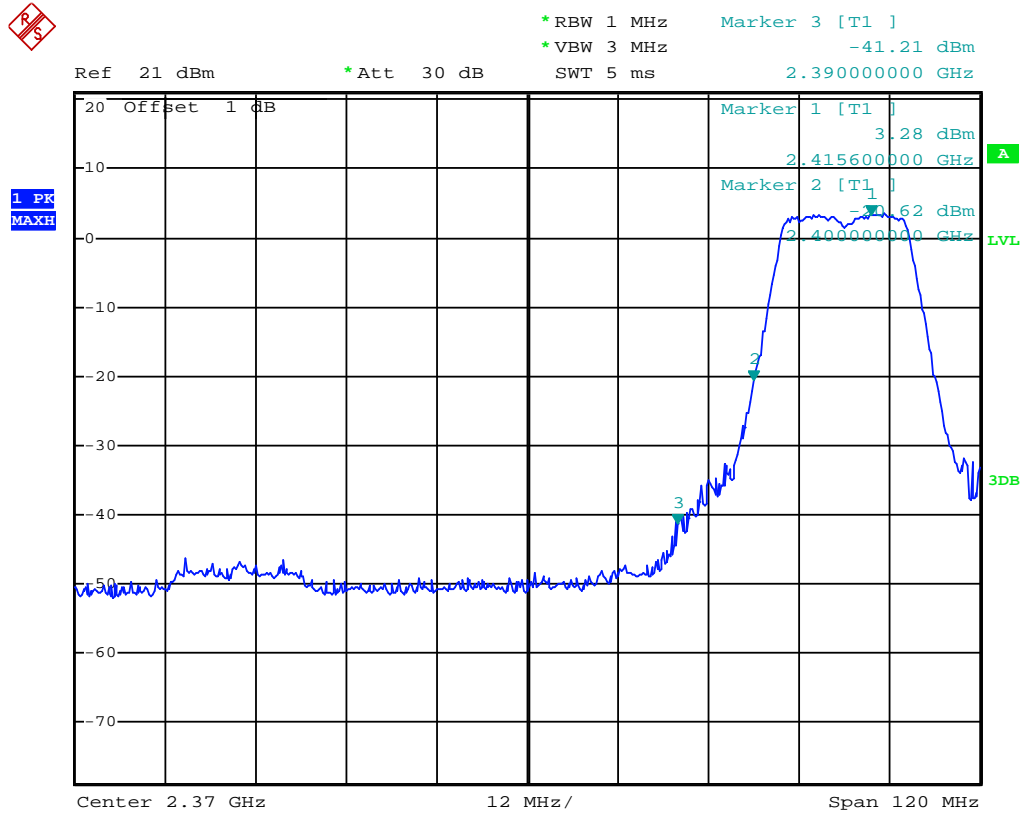

(Plot 4.5.3 A1: Channel 1: 2412MHz @ 802.11n(20MHz))

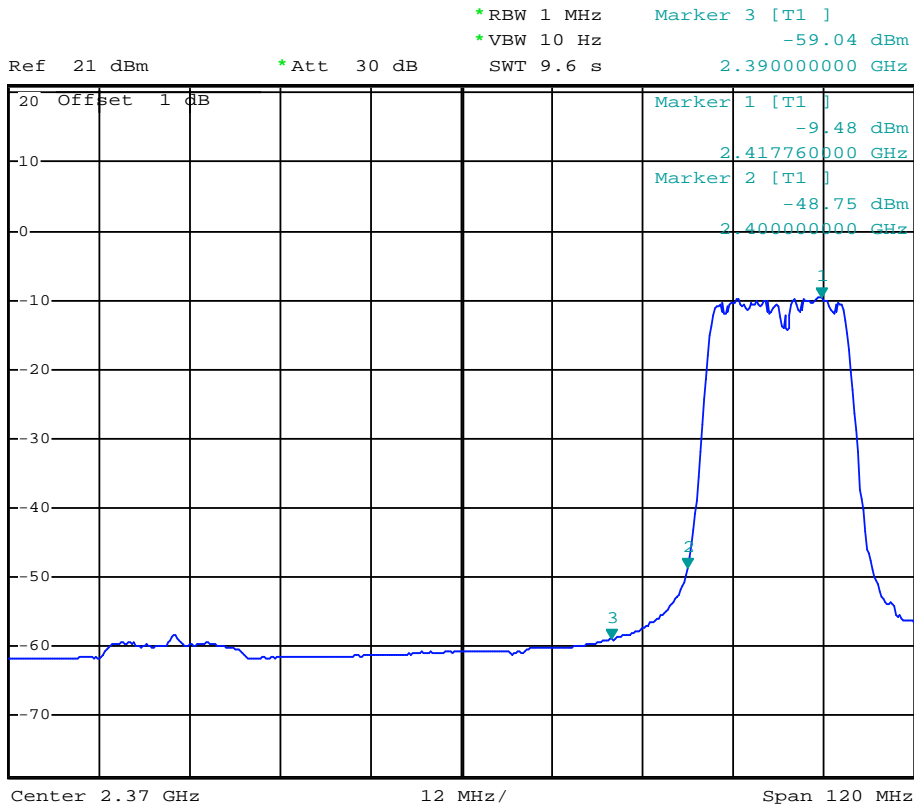

(Plot 4.5.3 A2: Channel 1: 2412MHz @ 802.11n(20MHz))

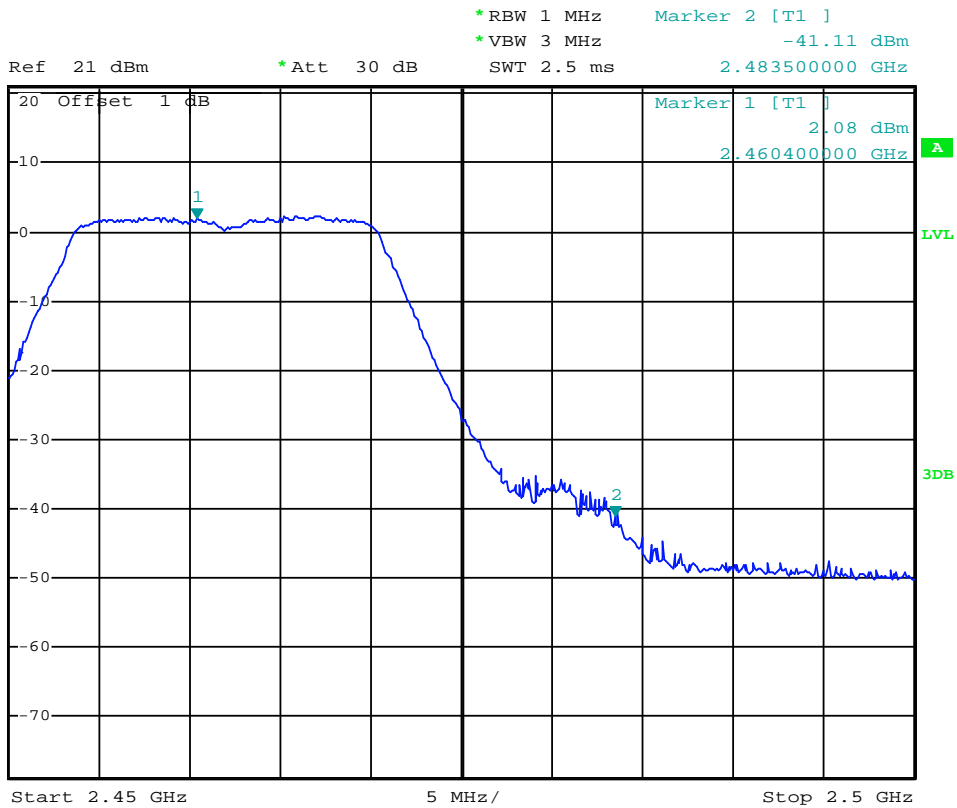

(Plot 4.5.3 A3: Channel 11: 2462MHz @ 802.11n(20MHz))

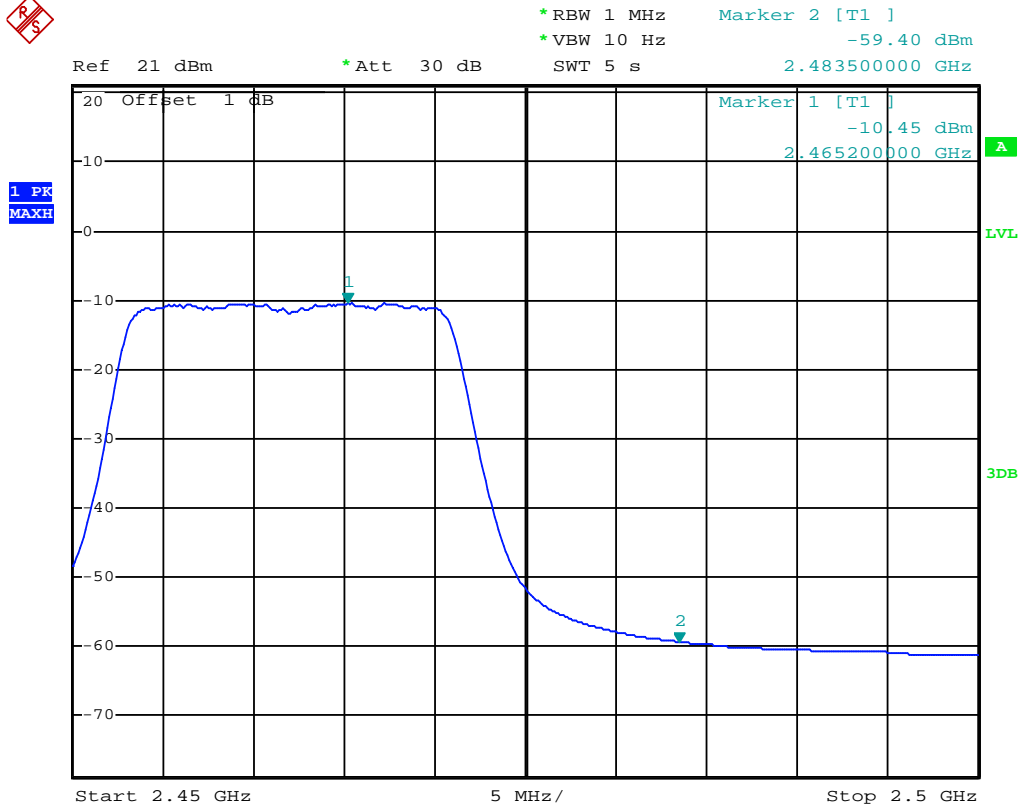

(Plot 4.5.3 A4: Channel 11: 2462MHz @ 802.11n(20MHz))

4.5.4 802.11n(40MHz) Test Mode

A. Test Verdict

Frequency (MHz)	Conducted Power (dBm)	Antenna Gain (dBi)	Ground Reflection Factor (dB)	Covert Radiated E Level At 3m (dBuV/m)	Detector	Limit (dBuV/m)	Refer to Plot
2390.00	-43.50	2.00	0.00	53.76	Peak	74.00	Plot 4.5.4 A1
2390.00	-58.61	2.00	0.00	38.65	AV	54.00	Plot 4.5.4 A2
2432.18	2.84	2.00	0.00	100.10	Peak	---	Plot 4.5.4 A1
2428.55	-15.27	2.00	0.00	81.99	AV	---	Plot 4.5.4 A2
2445.96	1.81	2.00	0.00	99.07	Peak	---	Plot 4.5.4 A3
2446.24	-16.14	2.00	0.00	81.12	AV	---	Plot 4.5.4 A4
2483.50	-42.35	2.00	0.00	54.91	Peak	74.00	Plot 4.5.4 A3
2483.50	-56.90	2.00	0.00	40.36	AV	54.00	Plot 4.5.4 A4

Note: 1. For 802.11n(40MHz) mode at final test to get the worst-case emission at 13.5Mbps.
 2. The test results including the cable loss.
 3. “---” means that the fundamental frequency not for 15.209 limits requirement.

B. Test Plots

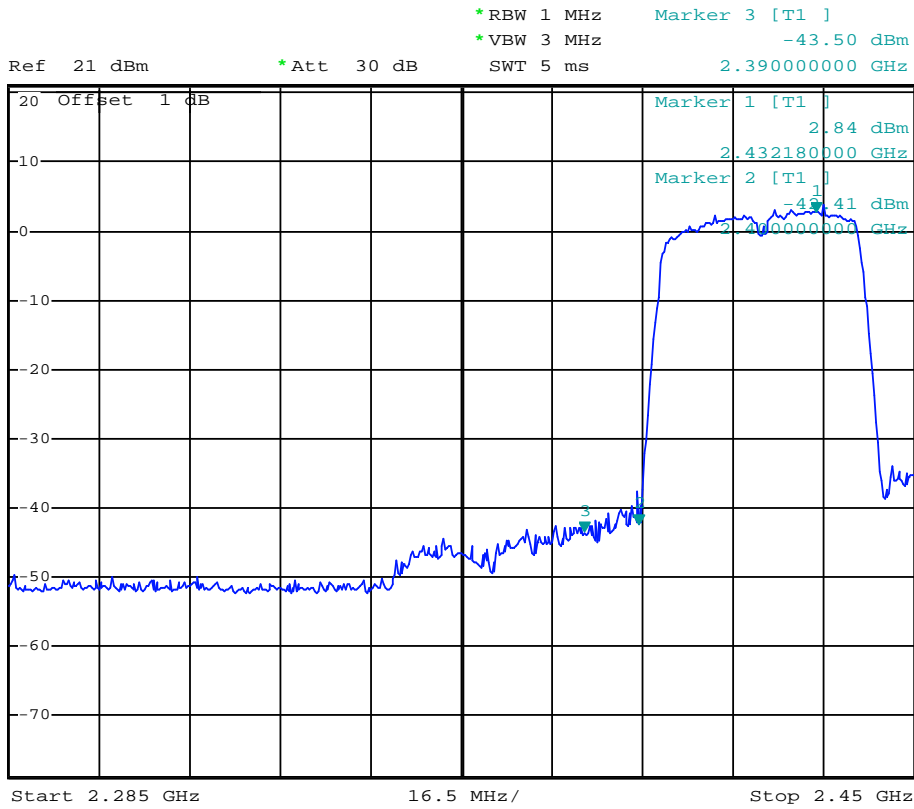

(Plot 4.5.4 A1: Channel 3: 2422MHz @ 802.11n(40MHz))

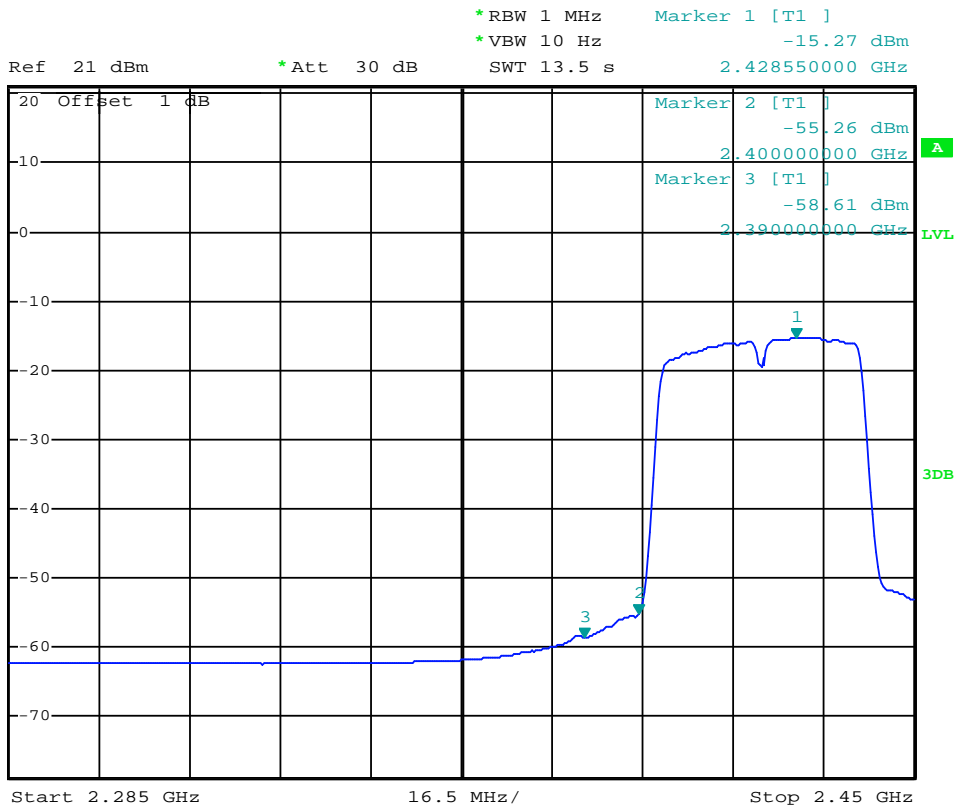

(Plot 4.5.4 A2: Channel 3: 2422MHz @ 802.11n(40MHz))

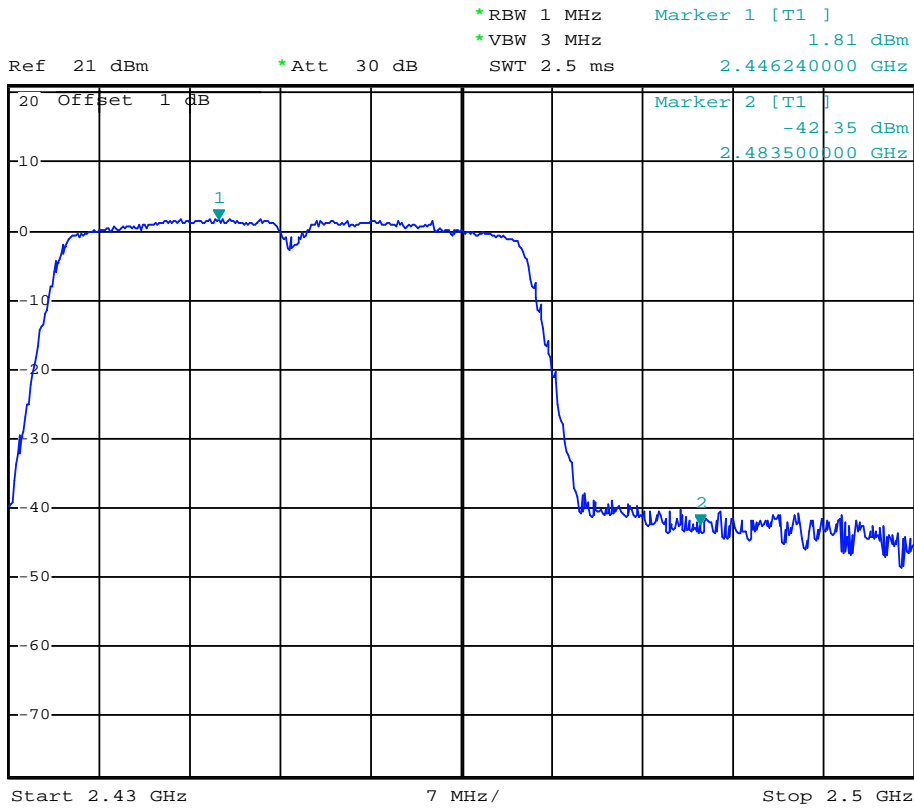

(Plot 4.5.4 A3: Channel 9: 2452MHz @ 802.11n(40MHz))

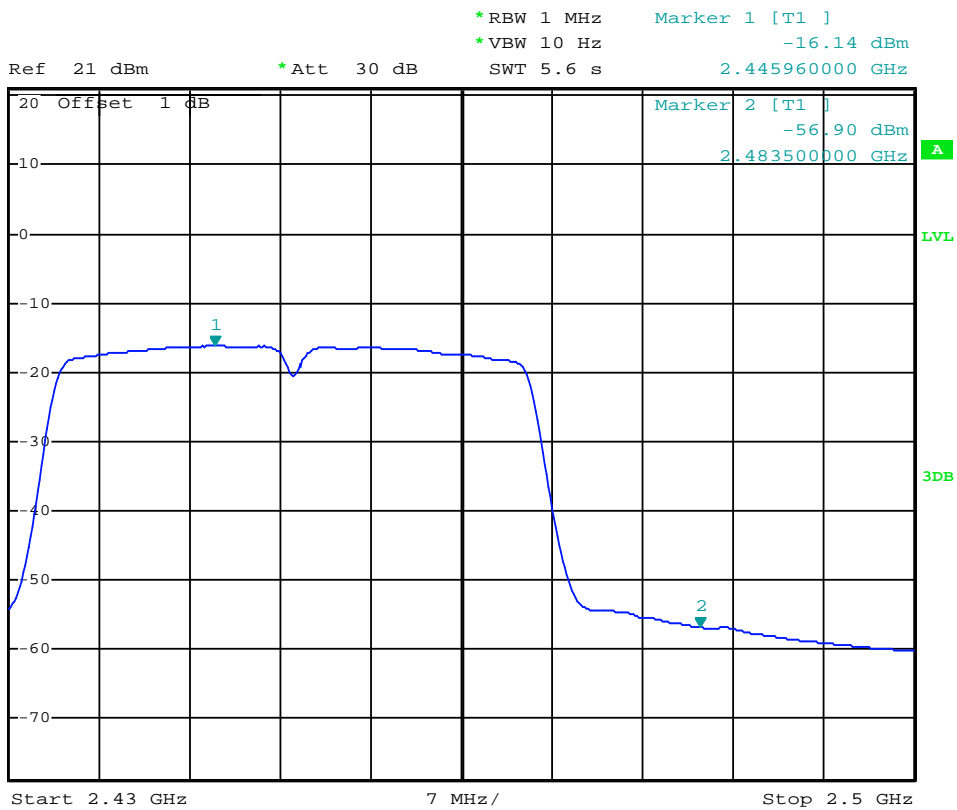

(Plot 4.5.4 A4: Channel 9: 2452MHz @ 802.11n(40MHz))

4.7. Spurious RF Conducted Emission

TEST CONFIGURATION

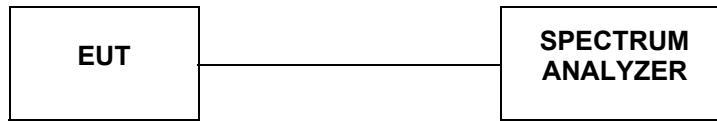

TEST PROCEDURE

The Spurious RF conducted emissions compliance of RF radiated emission should be measured by following the guidance in ANSI C63.10-2009 with respect to maximizing the emission by rotating the EUT, measuring the emission while the EUT is situated in three orthogonal planes (if appropriate), adjusting the measurement antenna height and polarization etc. Set RBW=100kHz and VBM= 300KHz to measure the peak field strength, and measure frequency range from 30MHz to 26.5GHz.

LIMIT

1. Below -20dB of the highest emission level in operating band.
2. Fall in the restricted bands listed in section 15.205. The maximum permitted average field strength is listed in section 15.209.

TEST RESULTS

Remark: The measurement frequency range is from 30MHz to the 10th harmonic of the fundamental frequency. The lowest, middle and highest channels are tested to verify the spurious emissions and bandedge measurement data.

4.6.1 802.11b Test Mode

A. Test Verdict

Channel	Frequency (MHz)	Refer to Plot	Limit (dBc)	Verdict
1	2412	Plot 4.6.1 A1/A2/A3/A4	-20	PASS
6	2437	Plot 4.6.1 B1/B2/B3	-20	PASS
11	2462	Plot 4.6.1 C1/C2/C3/C4	-20	PASS

- Note: 1. For 802.11b mode at final test to get the worst-case emission at 1Mbps.
2. The test results including the cable loss.

B. Test Plots

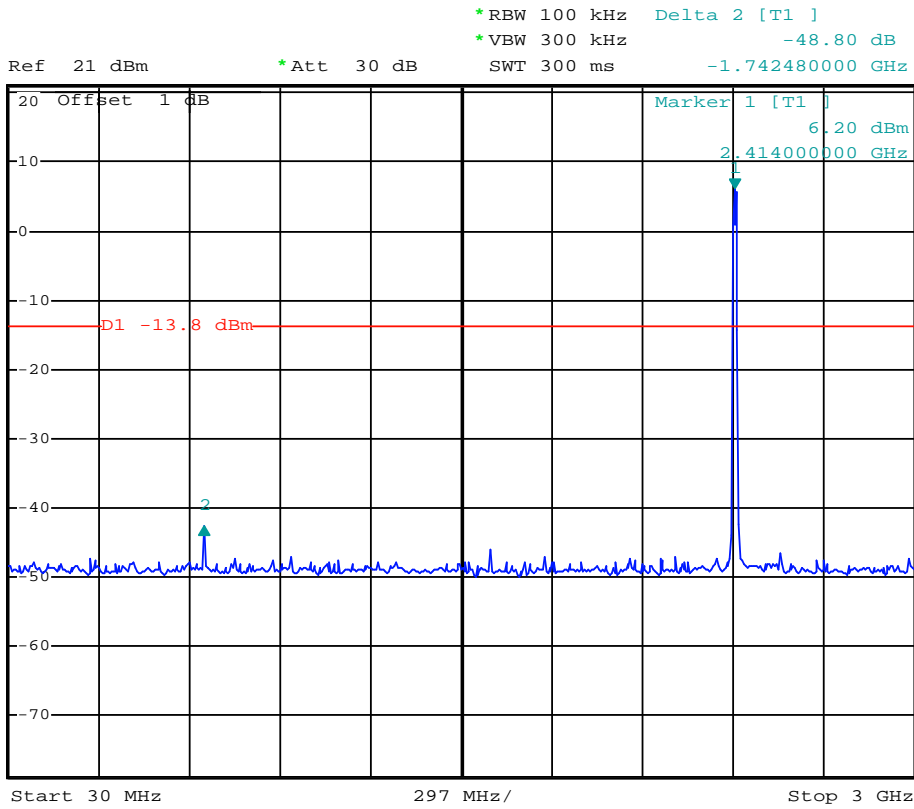

(Plot 4.6.1 A1: Channel 1: 2412MHz @ 802.11b)

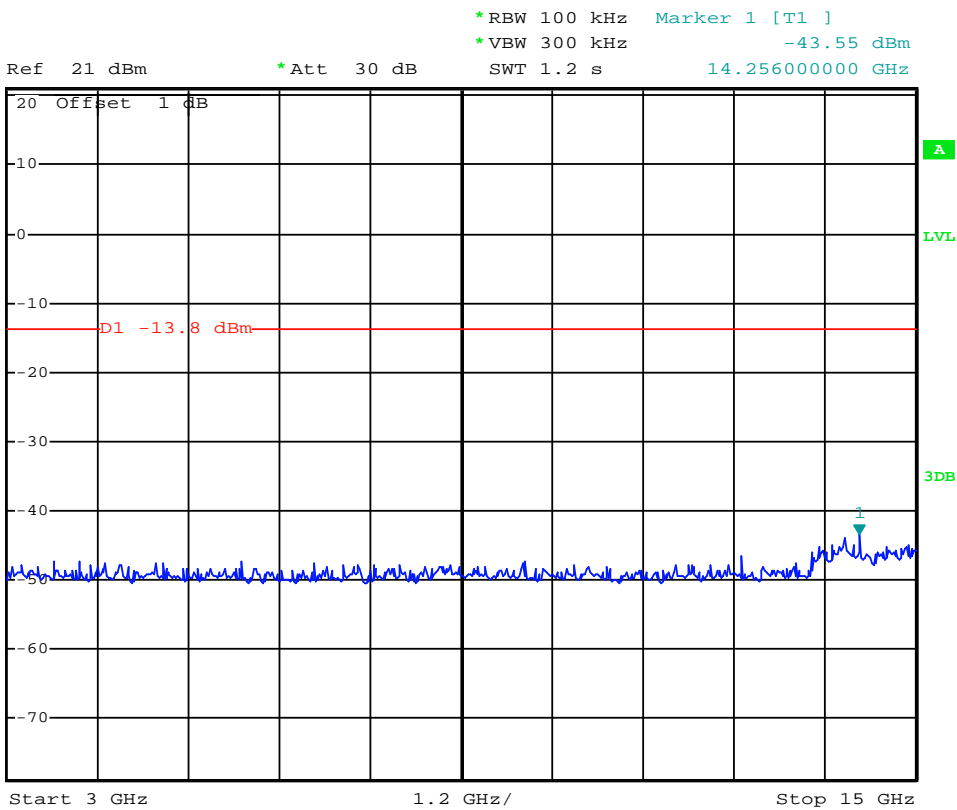

(Plot 4.6.1 A2: Channel 1: 2412MHz @ 802.11b)

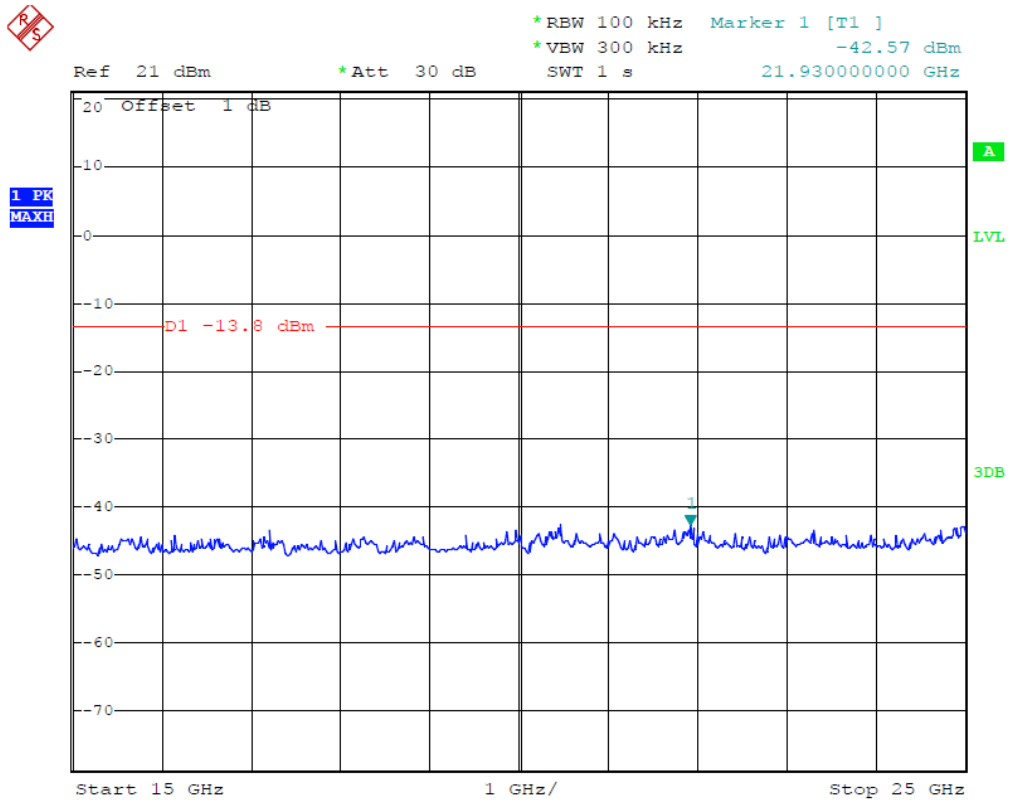

(Plot 4.6.1 A3: Channel 1: 2412MHz @ 802.11b)

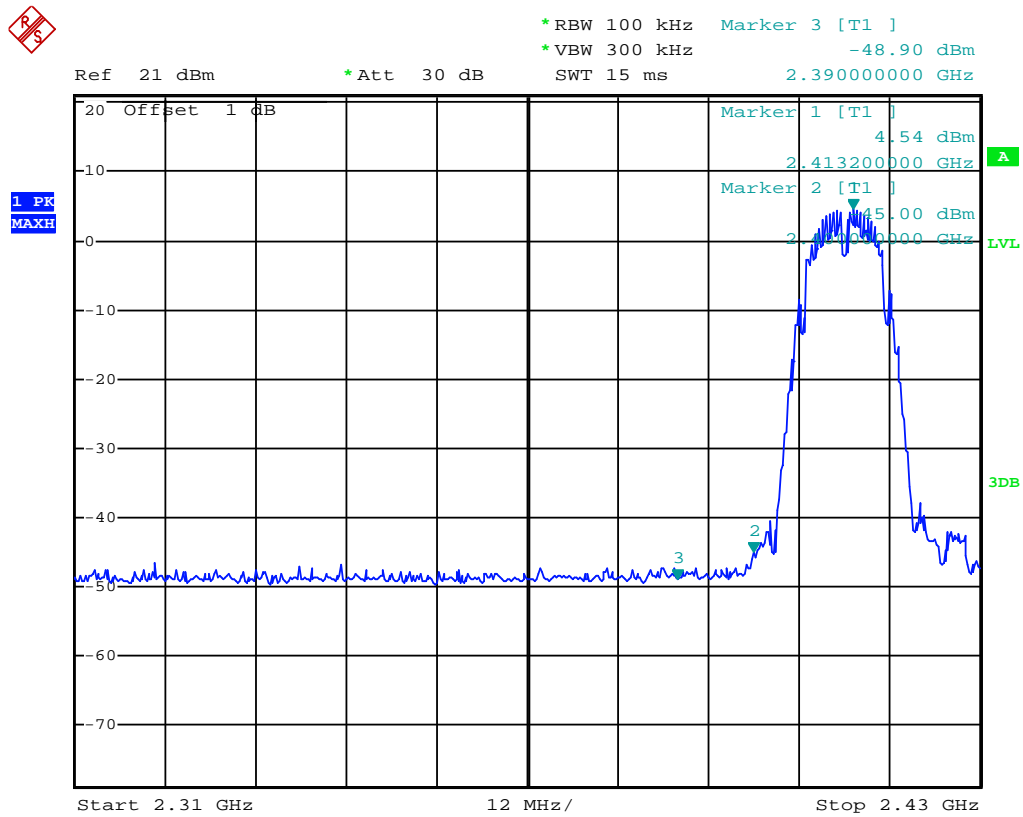

(Plot 4.6.1 A4: Channel 1: 2412MHz @ 802.11b)

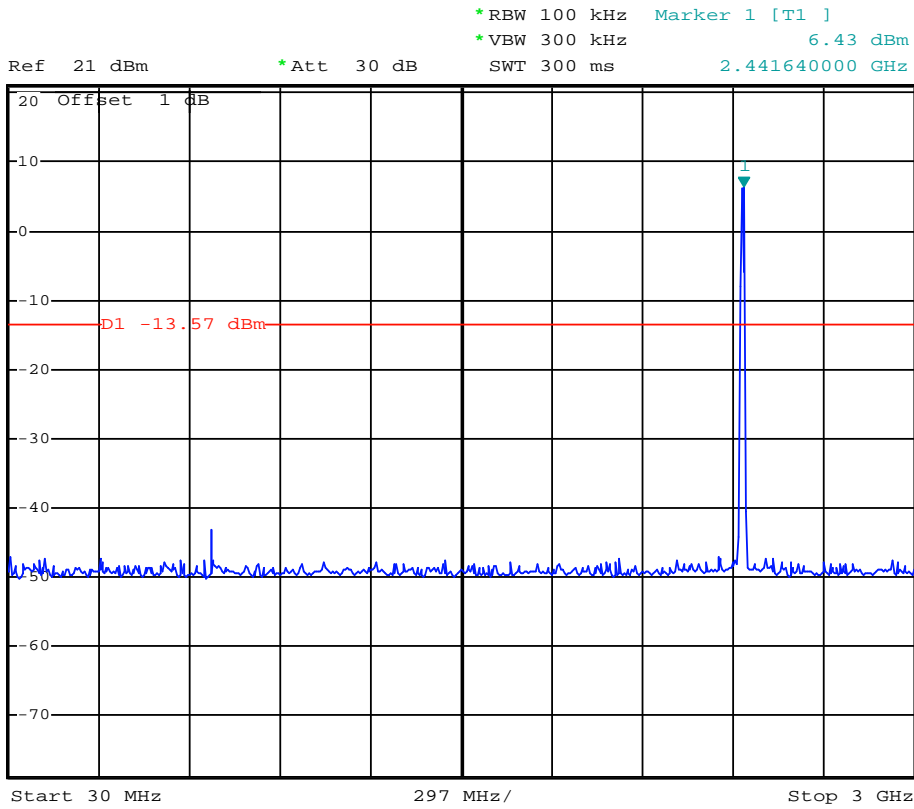

(Plot 4.6.1 B1: Channel 6: 2437MHz @ 802.11b)

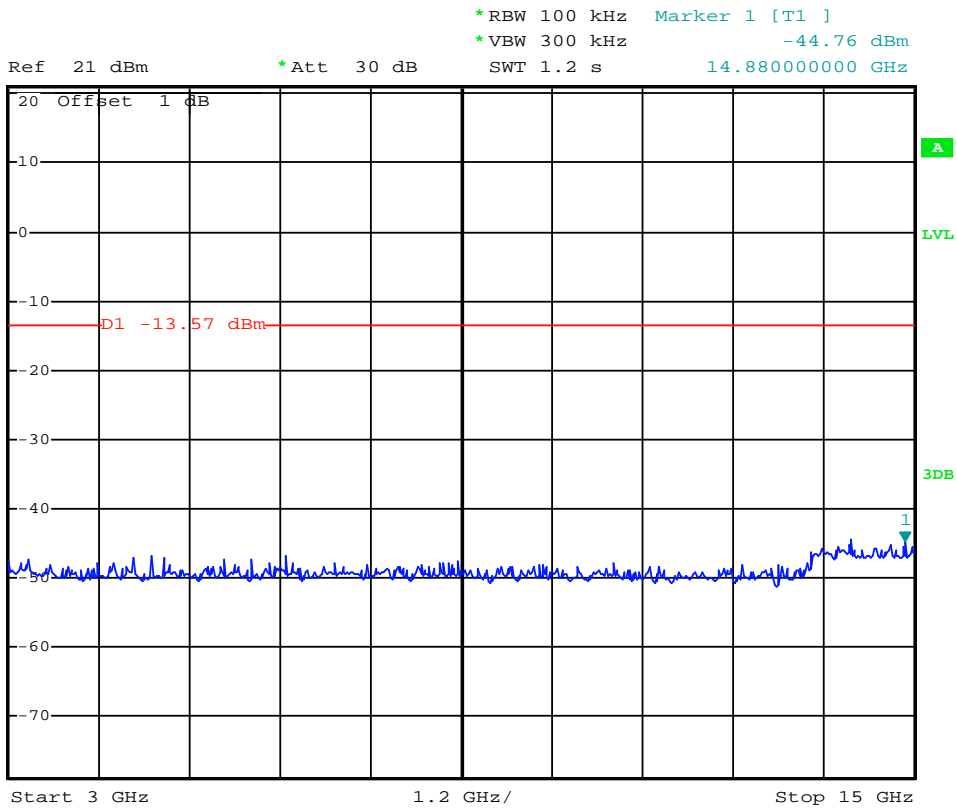

(Plot 4.6.1 B2: Channel 6: 2437MHz @ 802.11b)

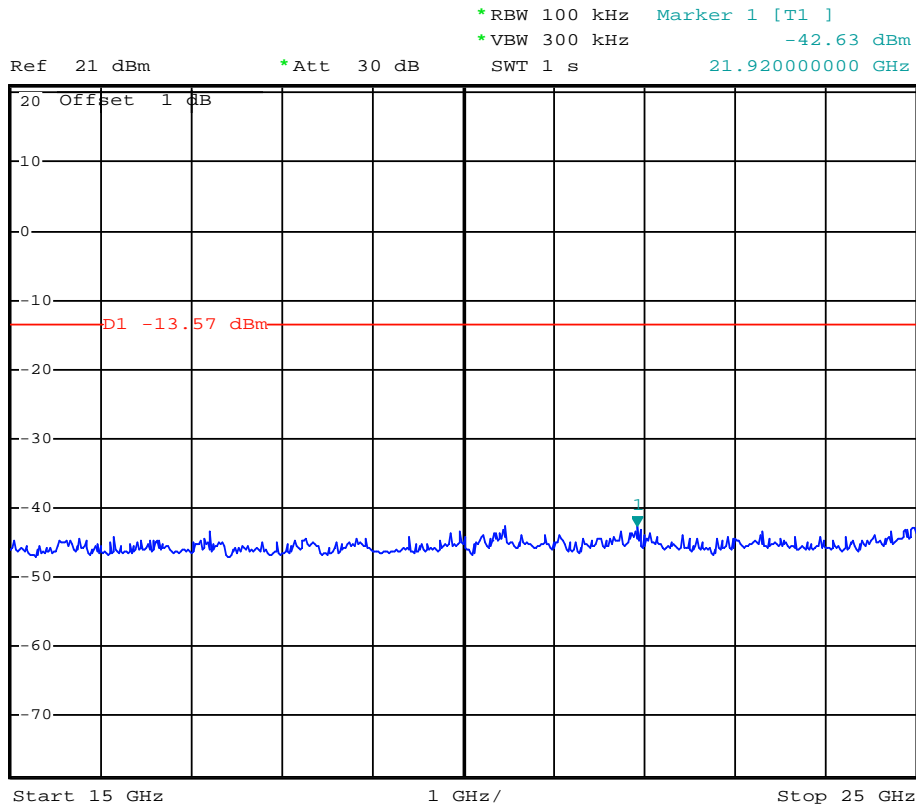

(Plot 4.6.1 B3: Channel 6: 2437MHz @ 802.11b)

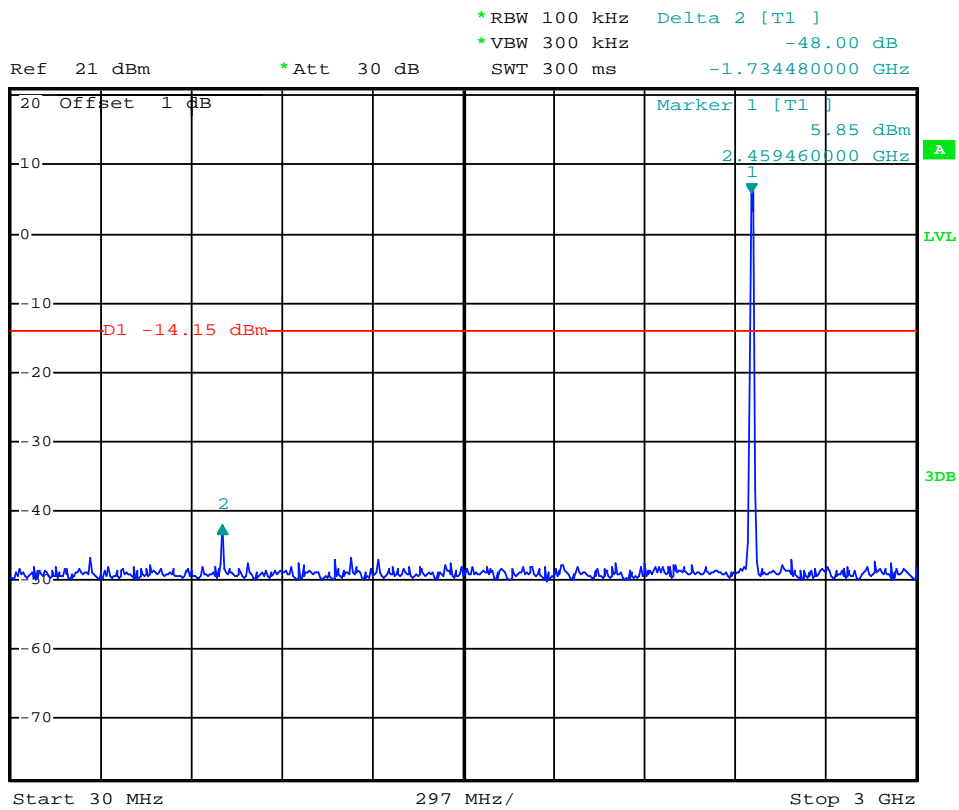

(Plot 4.6.1 C1: Channel 11: 2462MHz @ 802.11b)

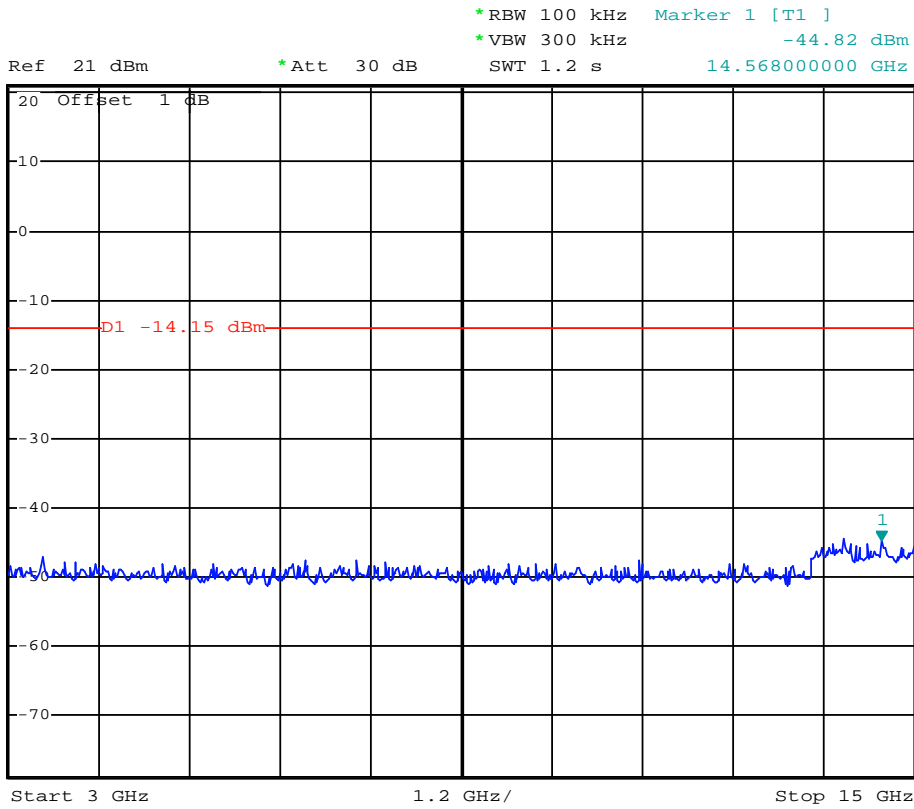

(Plot 4.6.1 C2: Channel 11: 2462MHz @ 802.11b)

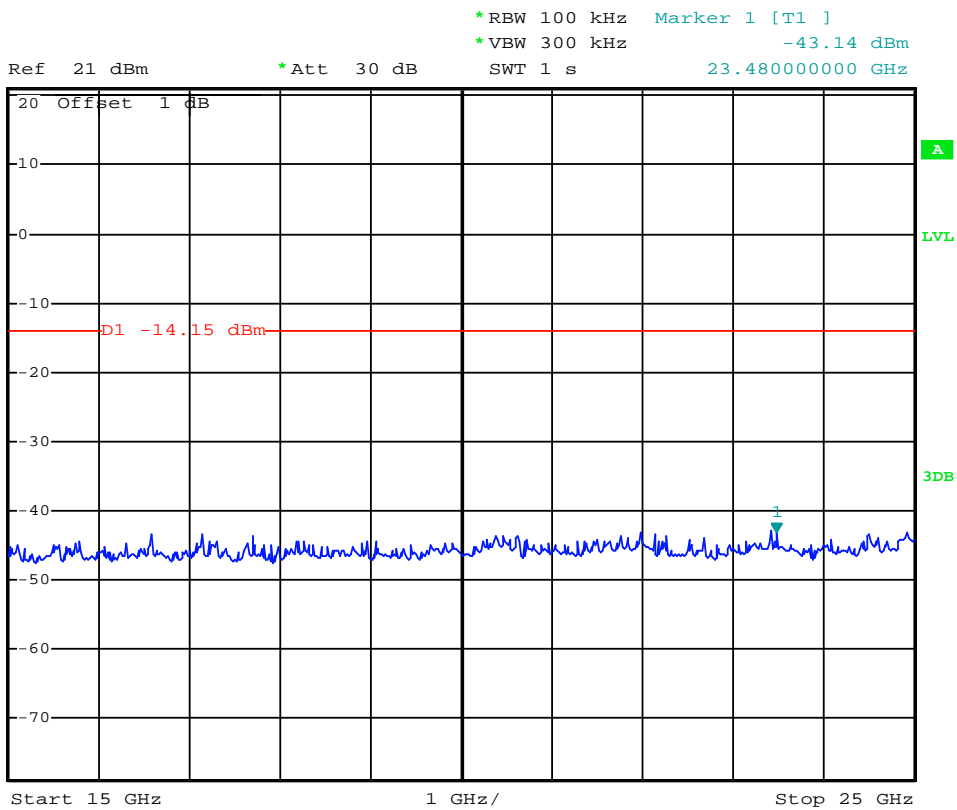

(Plot 4.6.1 C3: Channel 11: 2462MHz @ 802.11b)

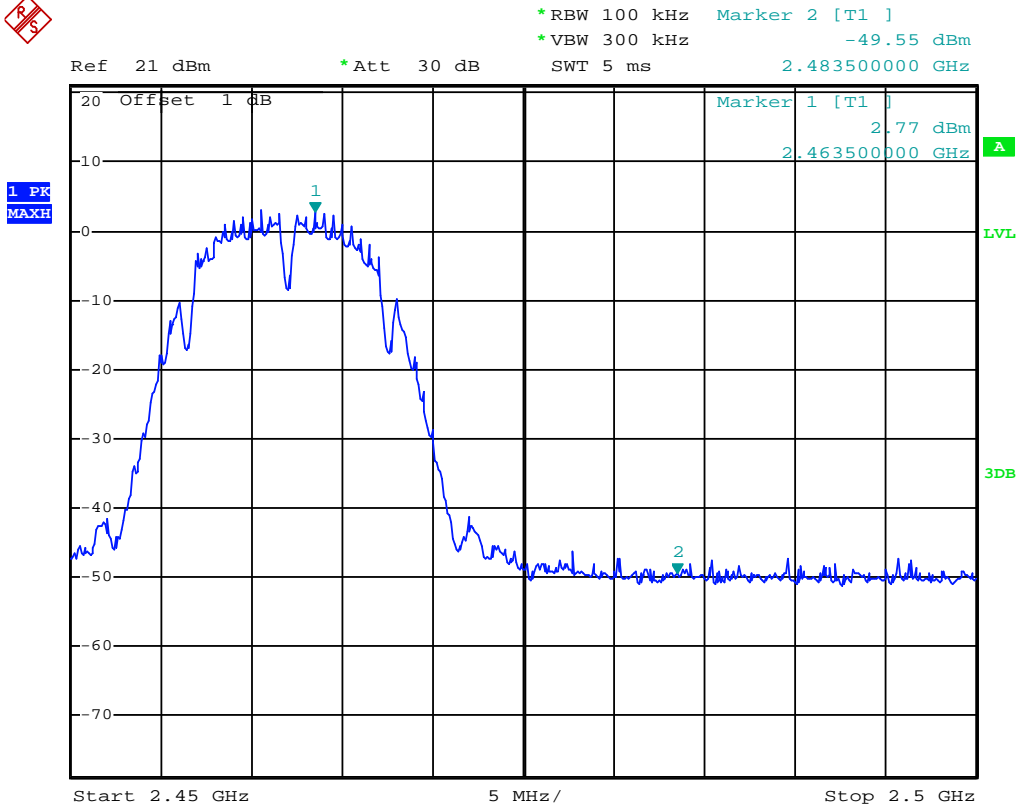

(Plot 4.6.1 C4: Channel 11: 2462MHz @ 802.11b)

4.6.2 802.11g Test Mode

A. Test Verdict

Channel	Frequency (MHz)	Refer to Plot	Limit (dBc)	Verdict
1	2412	Plot 4.6.2 A1/A2/A3/A4	-20	PASS
6	2437	Plot 4.6.2 B1/B2/B3	-20	PASS
11	2462	Plot 4.6.2 C1/C2/C3/C4	-20	PASS

Note: 1. For 802.11g mode at final test to get the worst-case emission at 6Mbps.
 2. The test results including the cable lose.

B. Test Plots

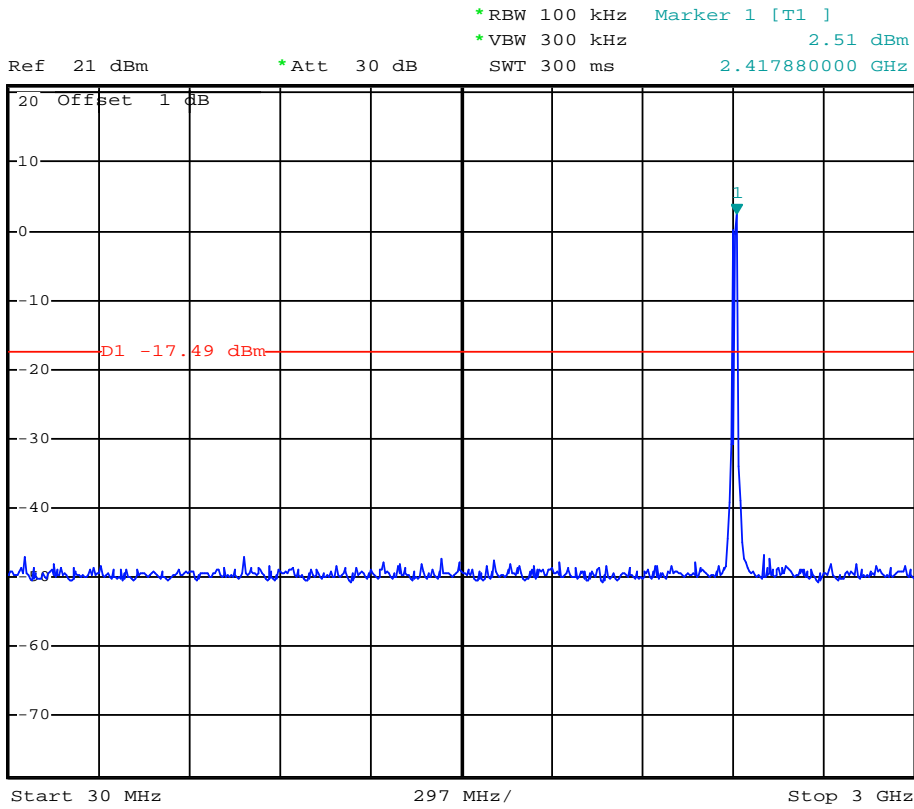

(Plot 4.6.2 A1: Channel 1: 2412MHz @ 802.11g)

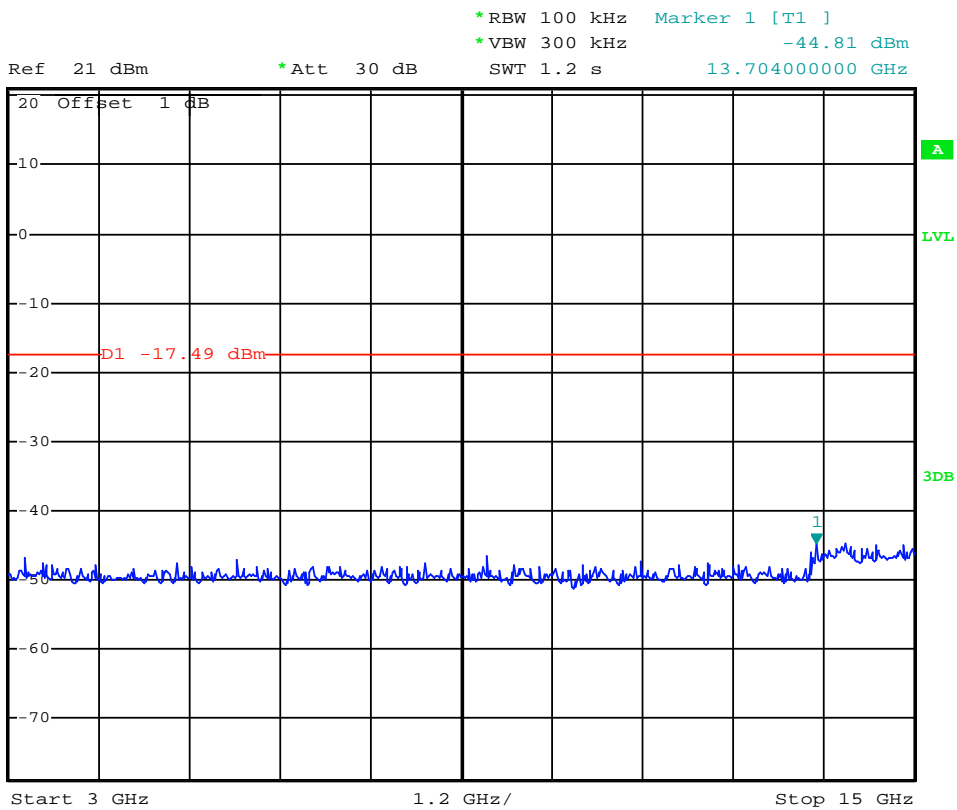

(Plot 4.6.2 A2: Channel 1: 2412MHz @ 802.11g)

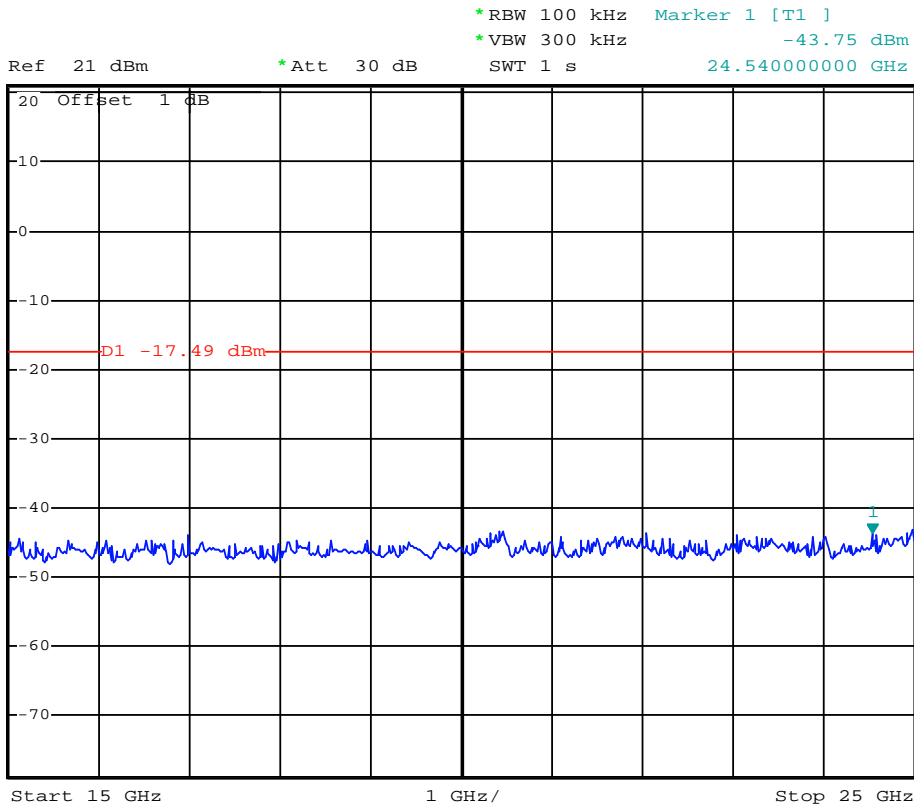

(Plot 4.6.2 A3: Channel 1: 2412MHz @ 802.11g)

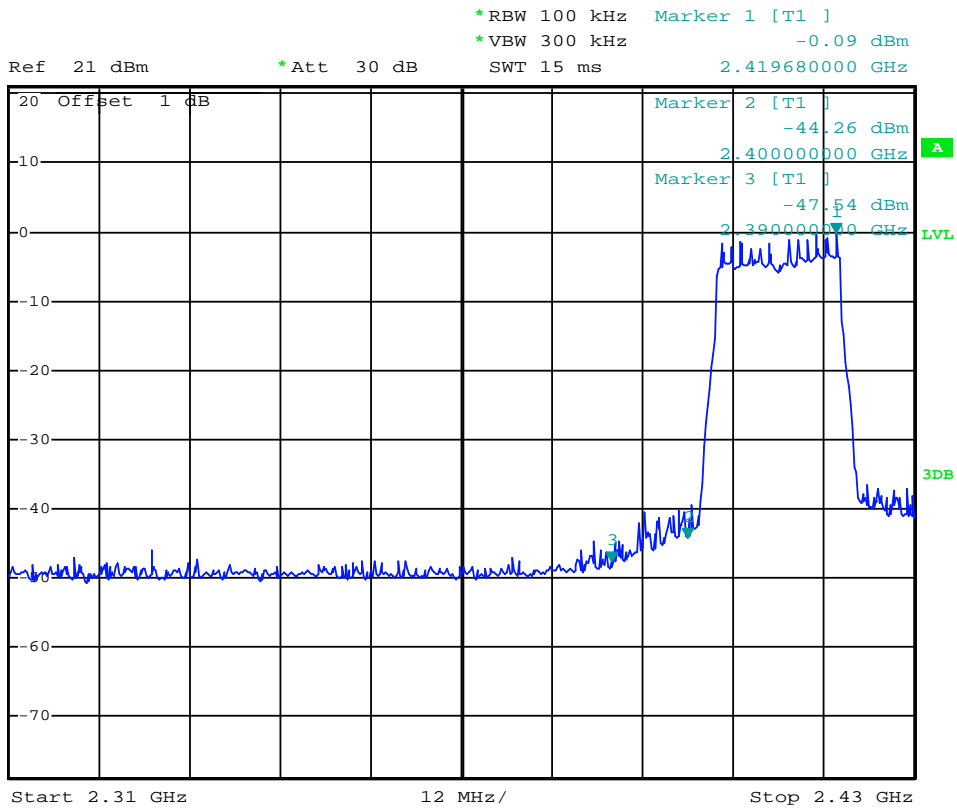

(Plot 4.6.2 A4: Channel 1: 2412MHz @ 802.11g)

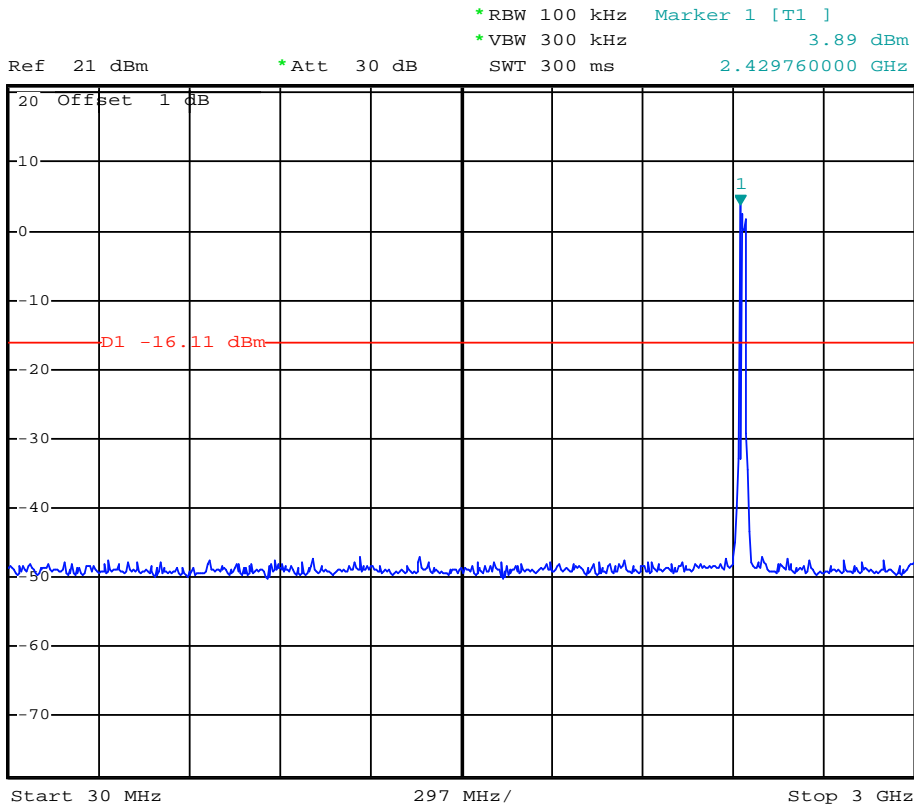

(Plot 4.6.2 B1: Channel 6: 2437MHz @ 802.11g)

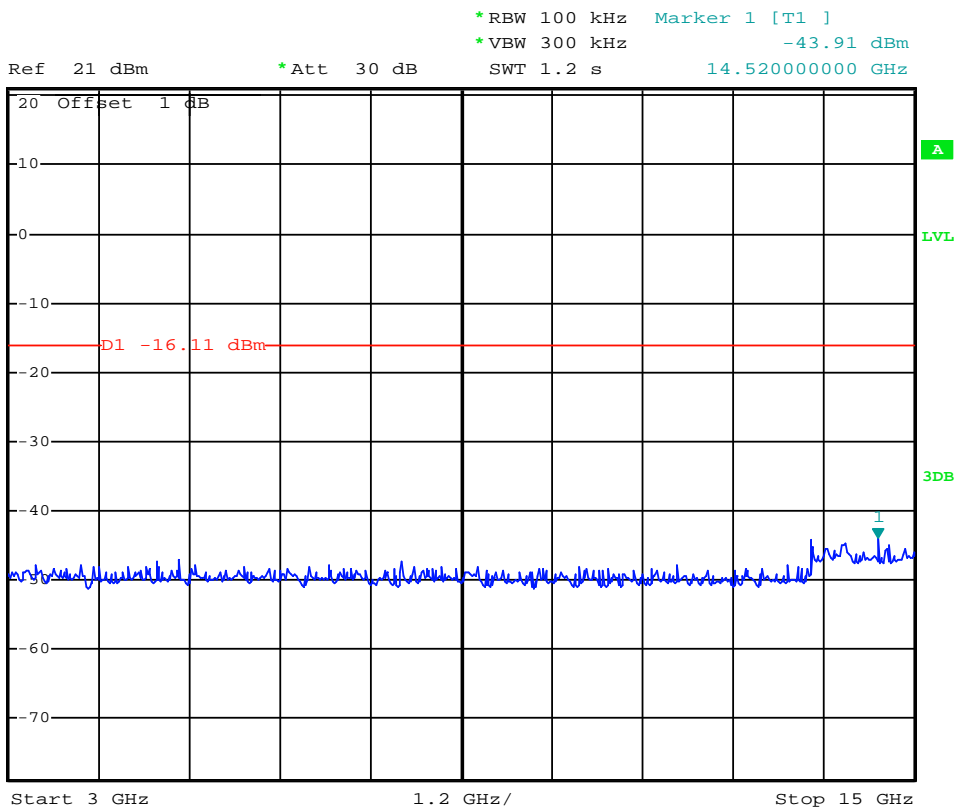

(Plot 4.6.2 B2: Channel 6: 2437MHz @ 802.11g)

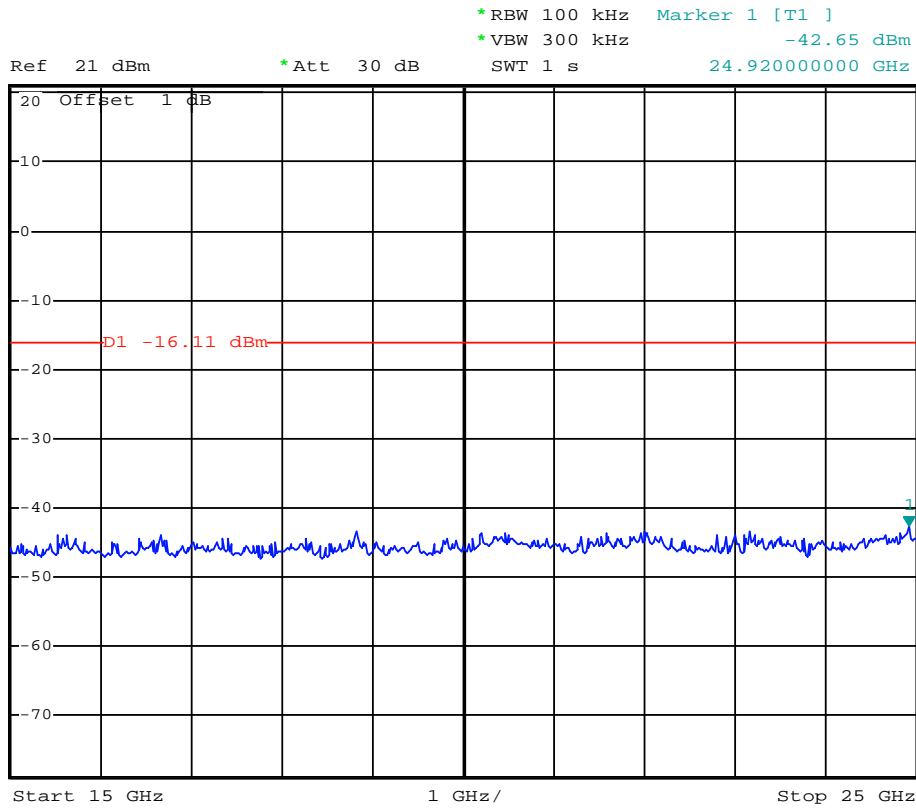

(Plot 4.6.2 B3: Channel 6: 2437MHz @ 802.11g)

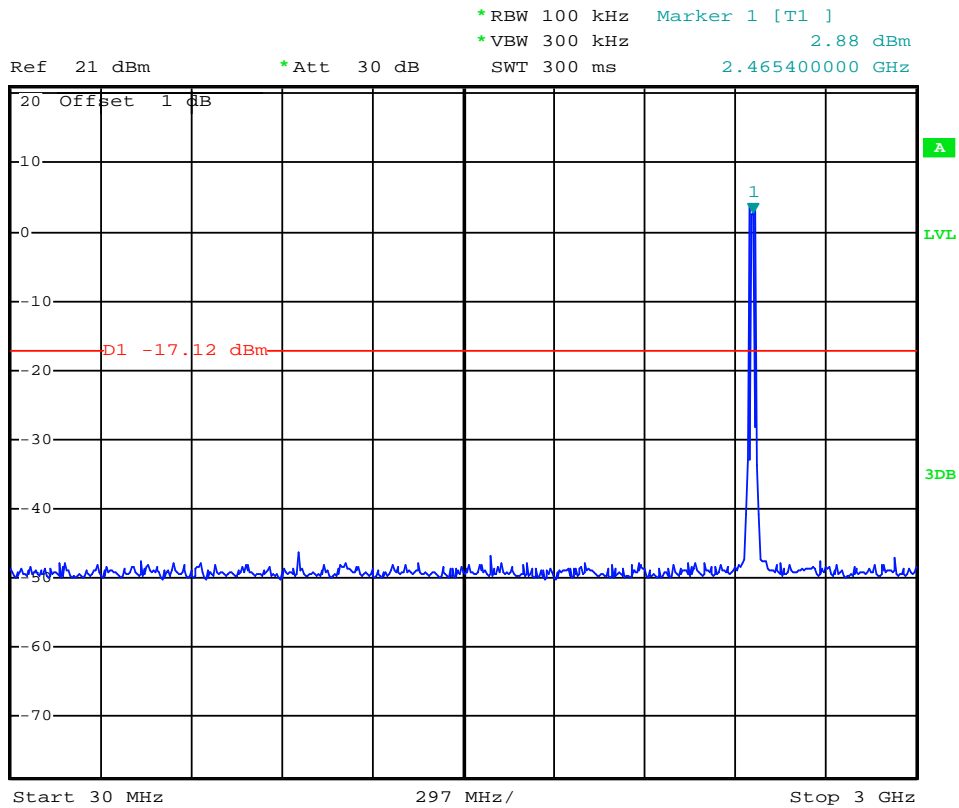

(Plot 4.6.2 C1: Channel 11: 2462MHz @ 802.11g)

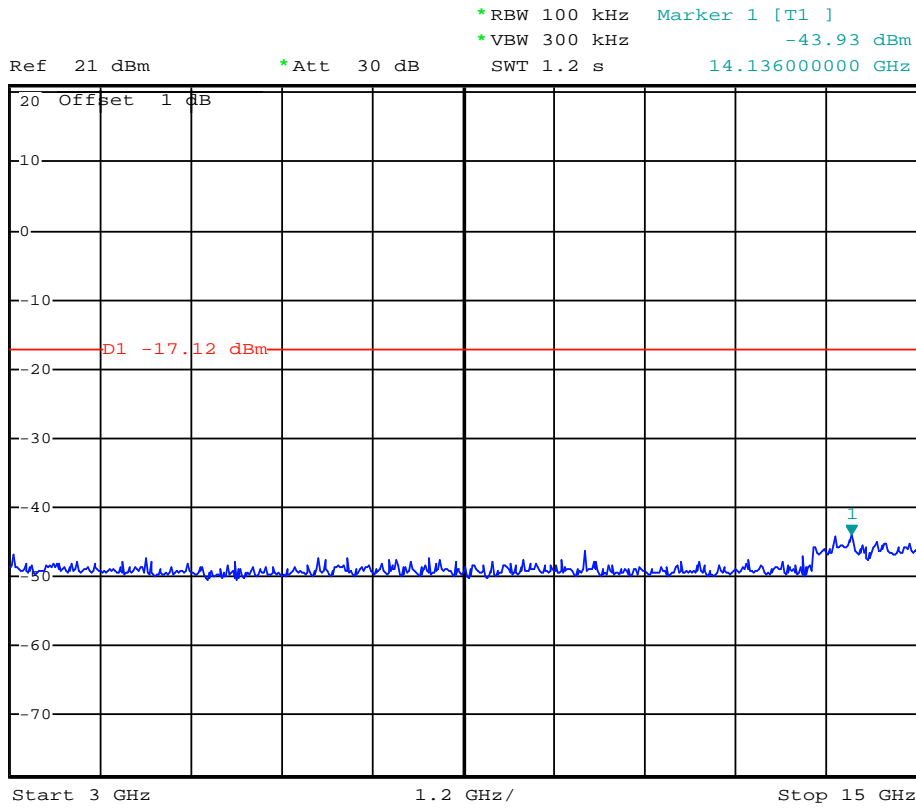

(Plot 4.6.2 C2: Channel 11: 2462MHz @ 802.11g)

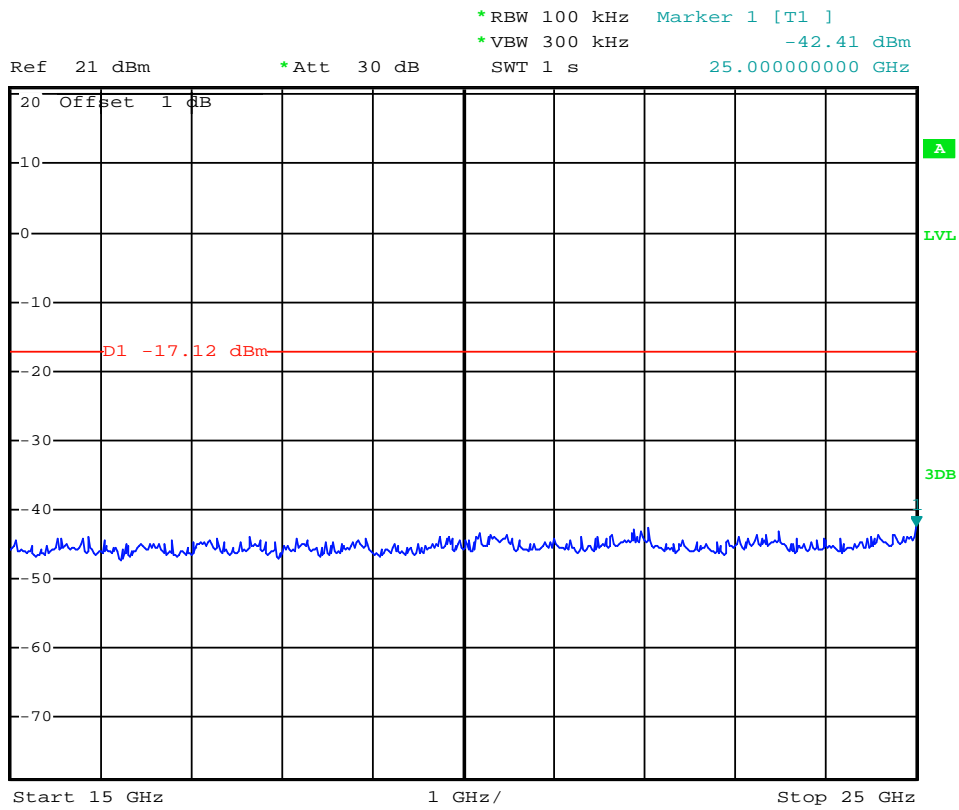

(Plot 4.6.2 C3: Channel 11: 2462MHz @ 802.11g)

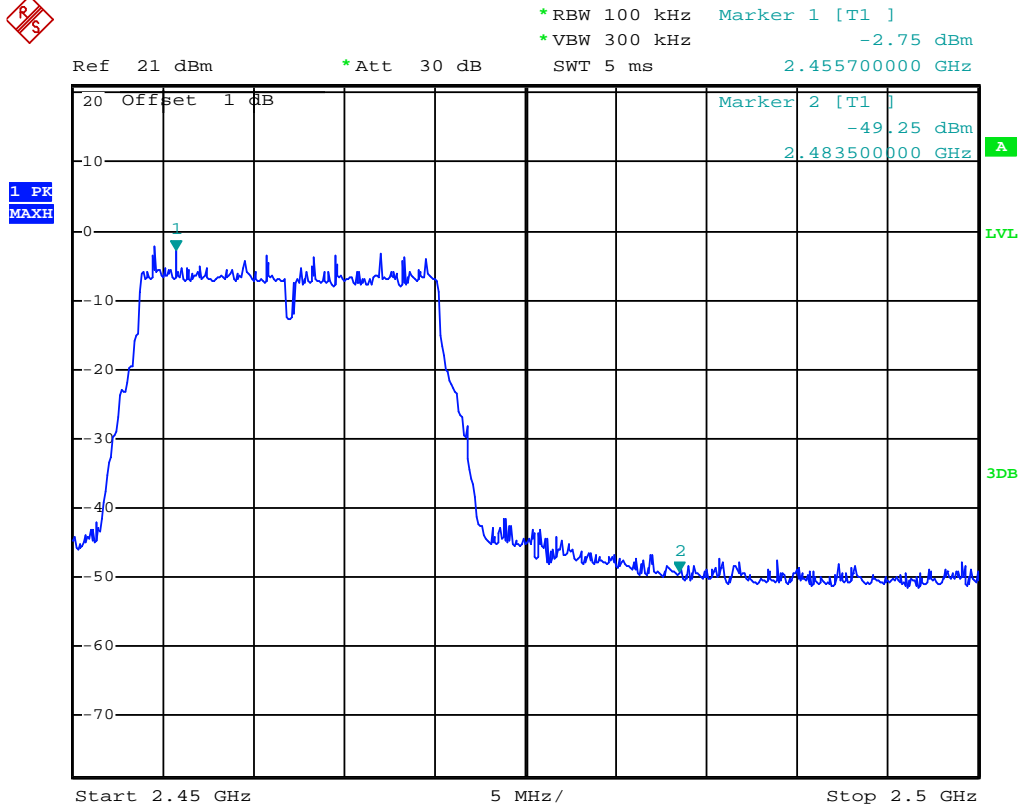

(Plot 4.6.2 C4: Channel 11: 2462MHz @ 802.11g)

4.6.3 802.11n(20MHz) Test Mode

A. Test Verdict

Channel	Frequency (MHz)	Refer to Plot	Limit (dBc)	Verdict
1	2412	Plot 4.6.3 A1/A2/A3/A4	-20	PASS
6	2437	Plot 4.6.3 B1/B2/B3	-20	PASS
11	2462	Plot 4.6.3 C1/C2/C3/C4	-20	PASS

Note: 1. For 802.11n(20MHz) mode at final test to get the worst-case emission at 6.5Mbps.
 2. The test results including the cable loss.

B. Test Plots

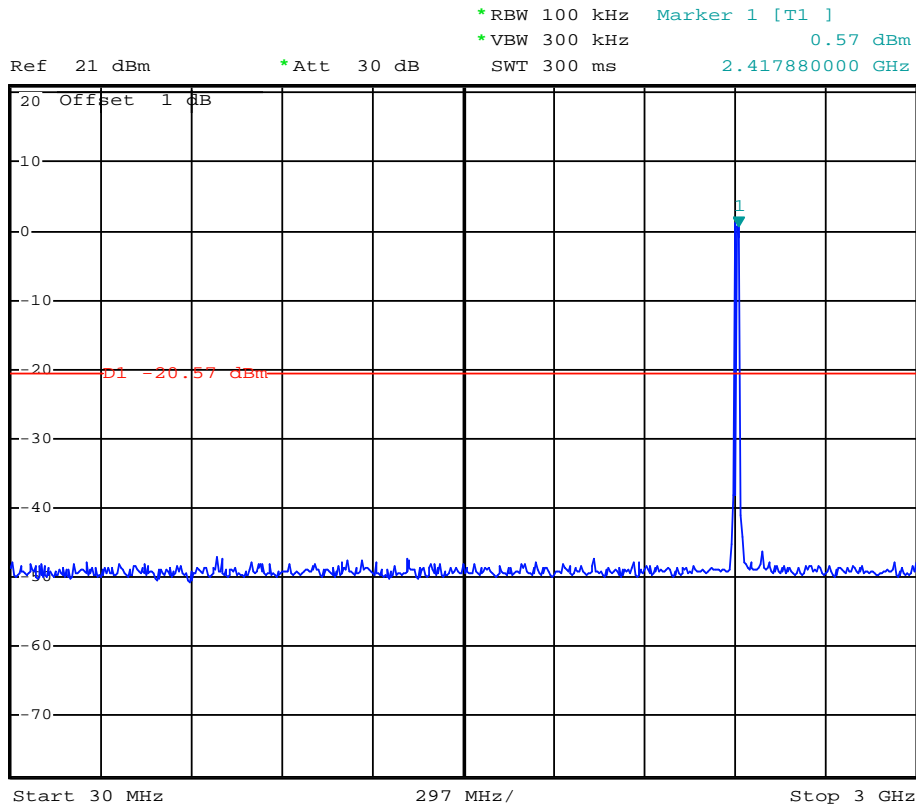

(Plot 4.6.3 A1: Channel 1: 2412MHz @ 802.11n(20MHz))

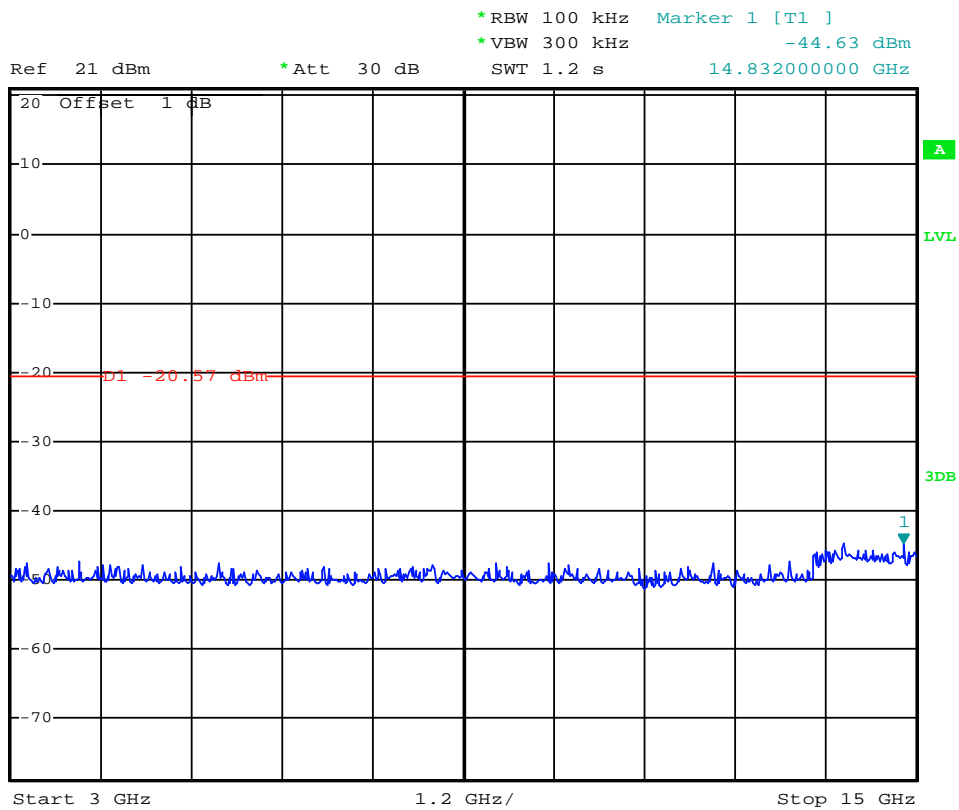

(Plot 4.6.3 A2: Channel 1: 2412MHz @ 802.11N(20MHz))

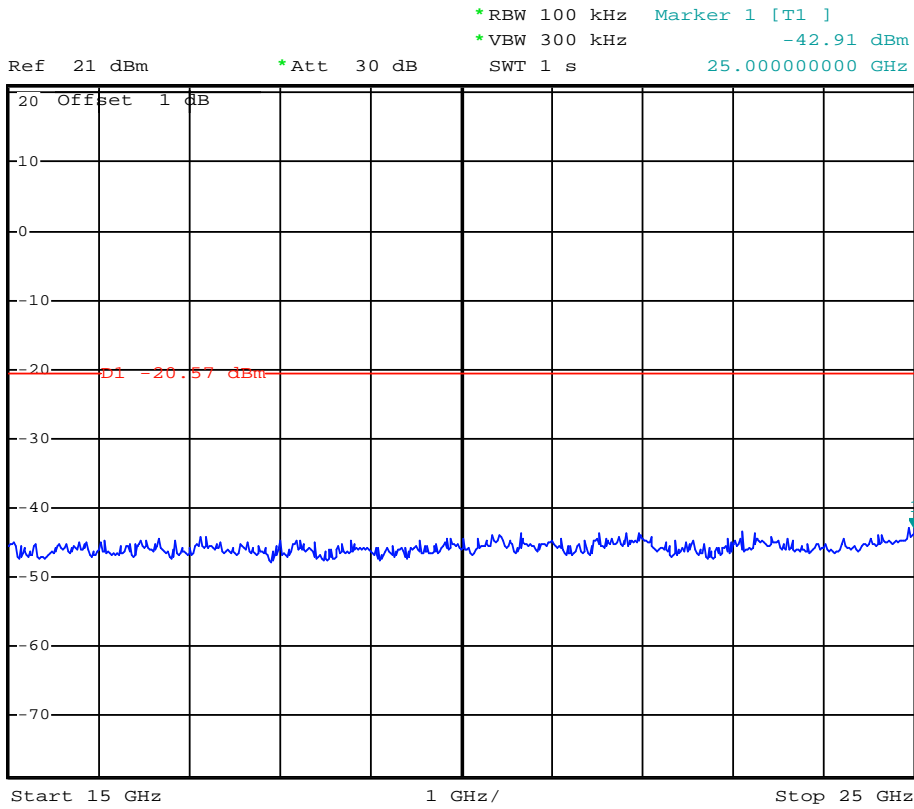

(Plot 4.6.3 A3: Channel 1: 2412MHz @ 802.11N(20MHz))

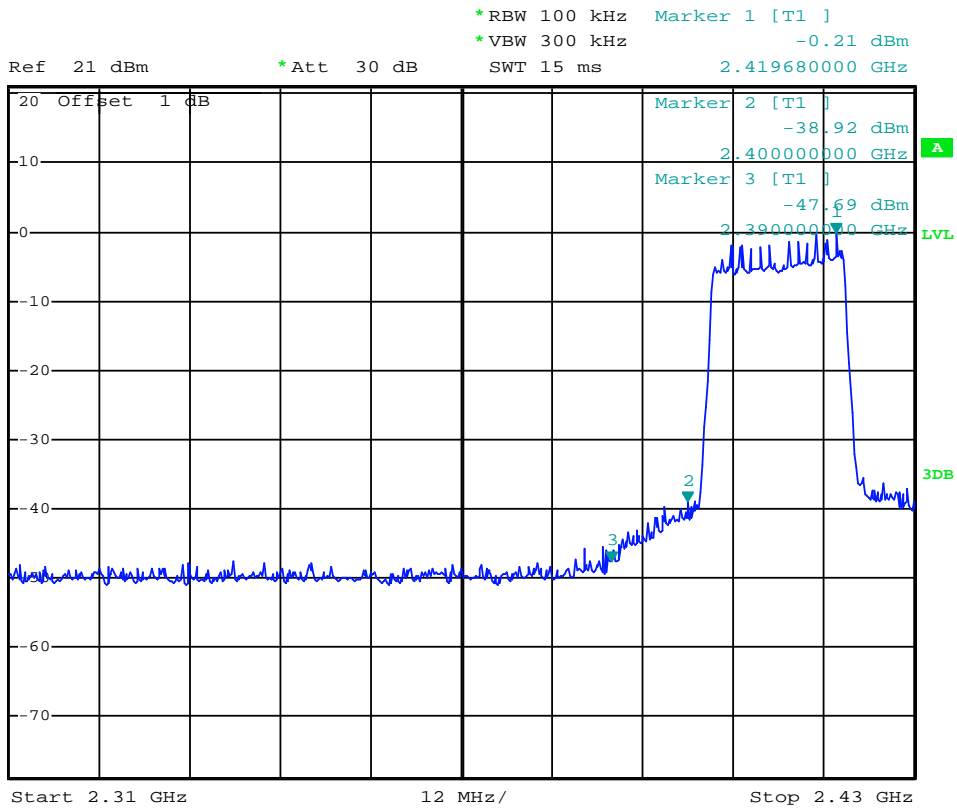

(Plot 4.6.3 A4: Channel 1: 2412MHz @ 802.11N(20MHz))

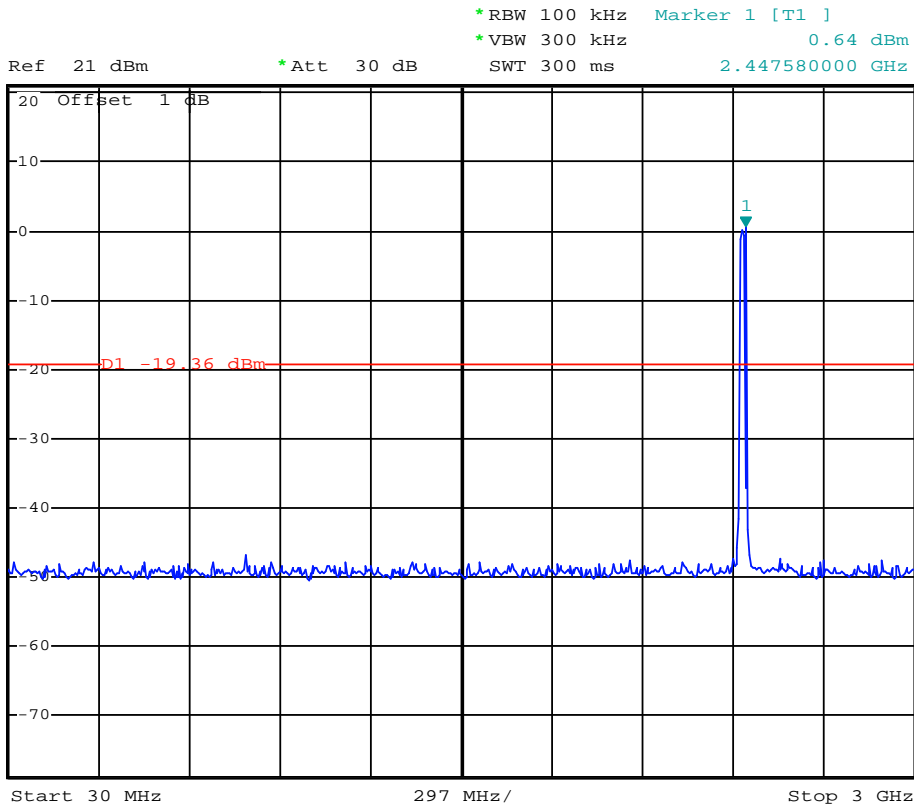

(Plot 4.6.3 B1: Channel 6: 2437MHz @ 802.11n(20MHz))

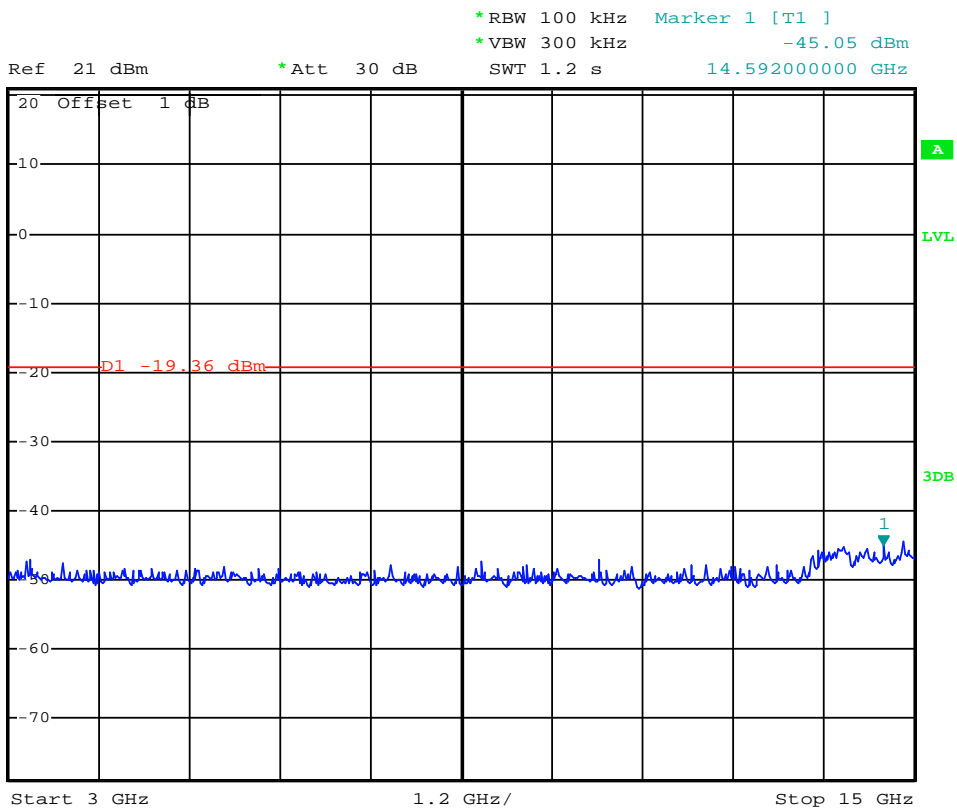

(Plot 4.6.3 B2: Channel 6: 2437MHz @ 802.11N(20MHz))

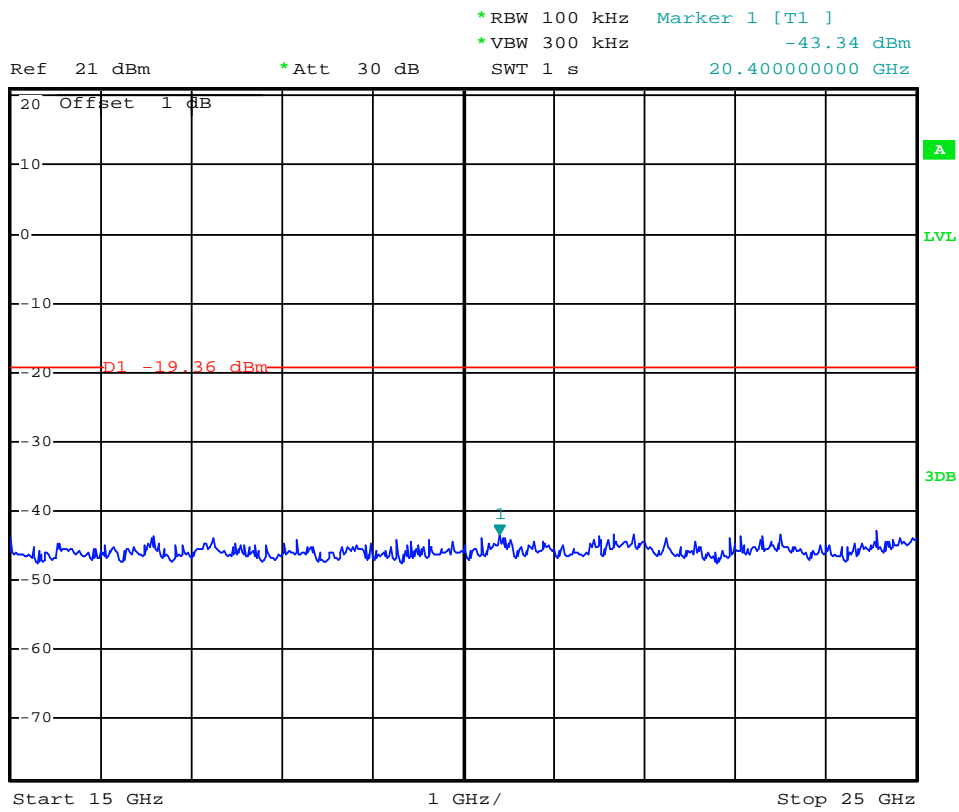

(Plot 4.6.3 B3: Channel 6: 2437MHz @ 802.11N(20MHz))

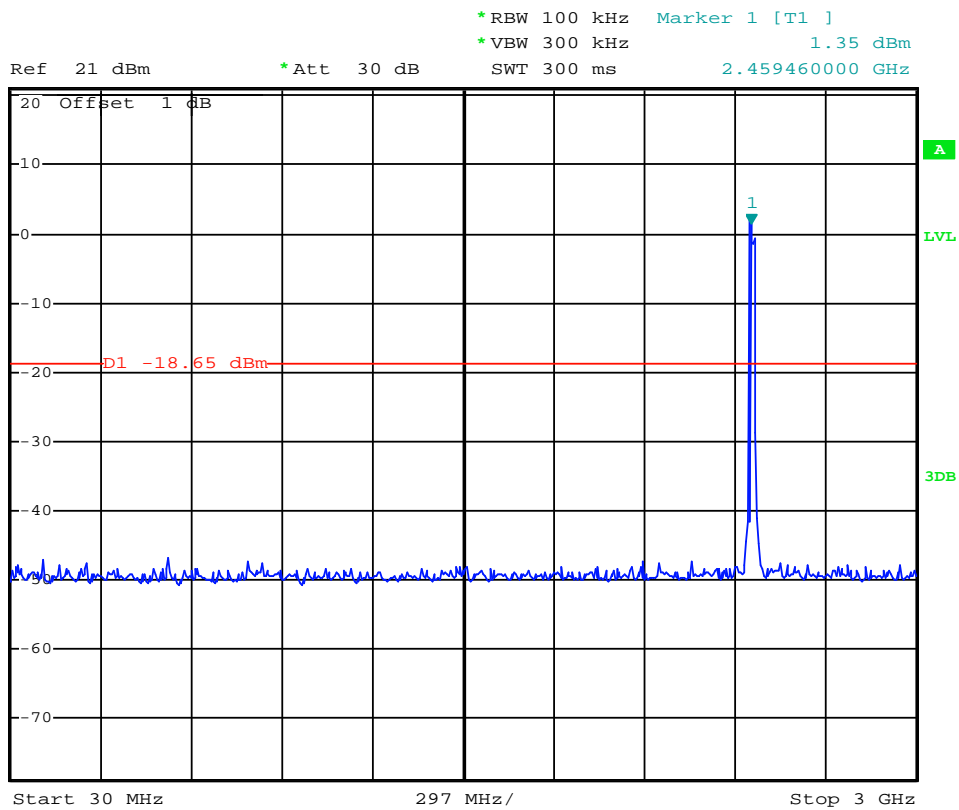

(Plot 4.6.3 C1: Channel 11: 2462MHz @ 802.11N(20MHz))

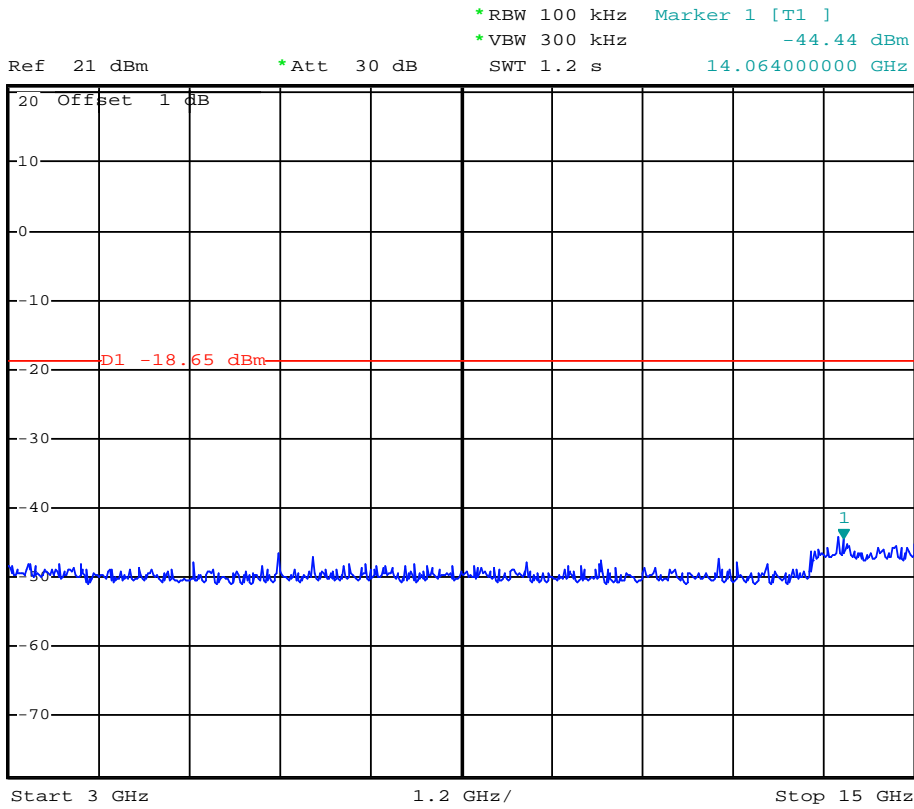

(Plot 4.6.3 C2: Channel 11: 2462MHz @ 802.11N(20MHz))

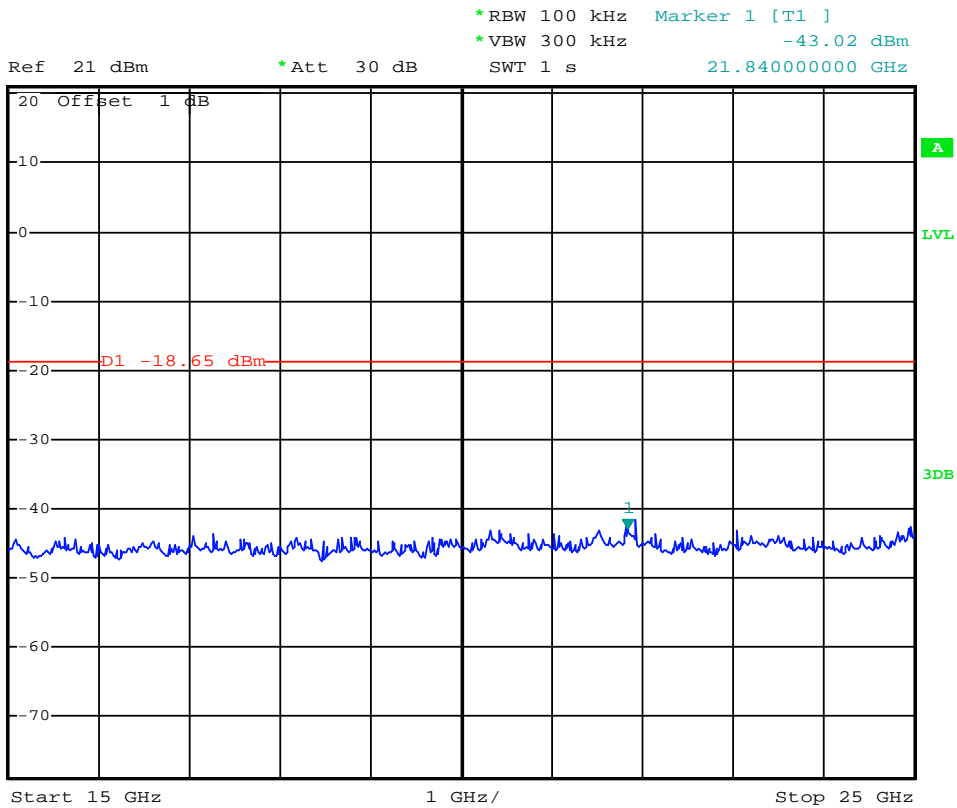

(Plot 4.6.3 C3: Channel 11: 2462MHz @ 802.11N(20MHz))

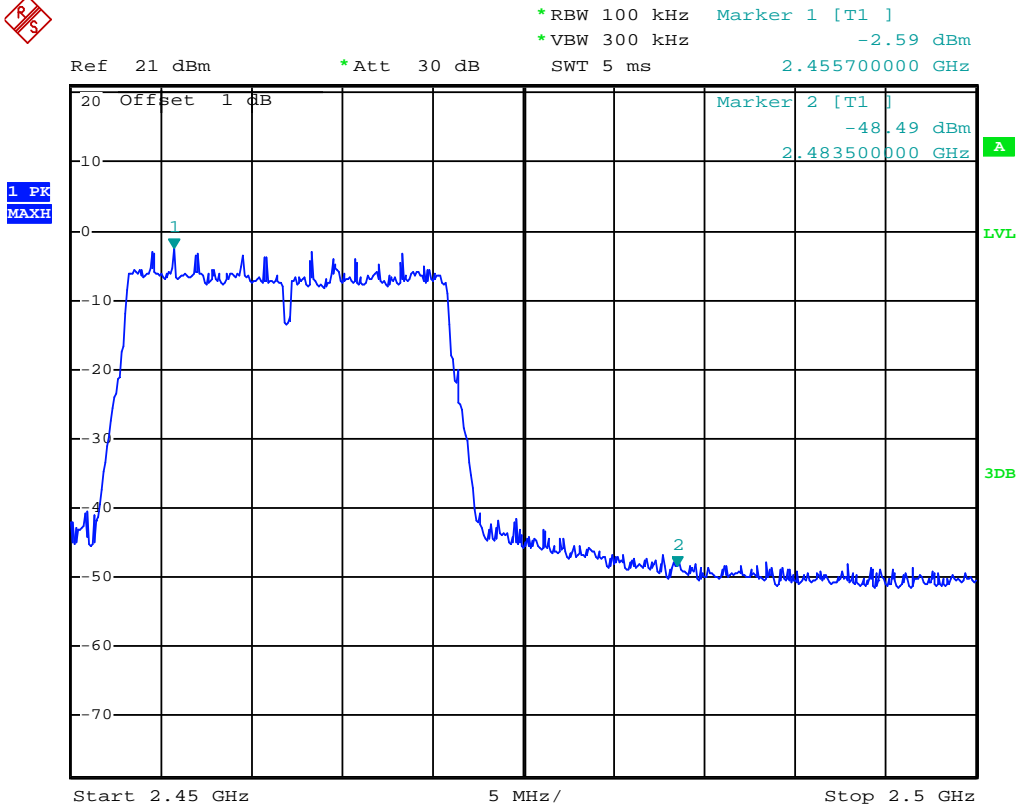

(Plot 4.6.3 C4: Channel 11: 2462MHz @ 802.11N(20MHz))

4.6.4 802.11n(40MHz) Test Mode

A. Test Verdict

Channel	Frequency (MHz)	Refer to Plot	Limit (dBc)	Verdict
3	2422	Plot 4.6.3 A1/A2/A3/A4	-20	PASS
6	2437	Plot 4.6.3 B1/B2/B3	-20	PASS
9	2452	Plot 4.6.3 C1/C2/C3/C4	-20	PASS

Note: 1. For 802.11n(40MHz) mode at final test to get the worst-case emission at 13.5Mbps.
 2. The test results including the cable loss.

B. Test Plots

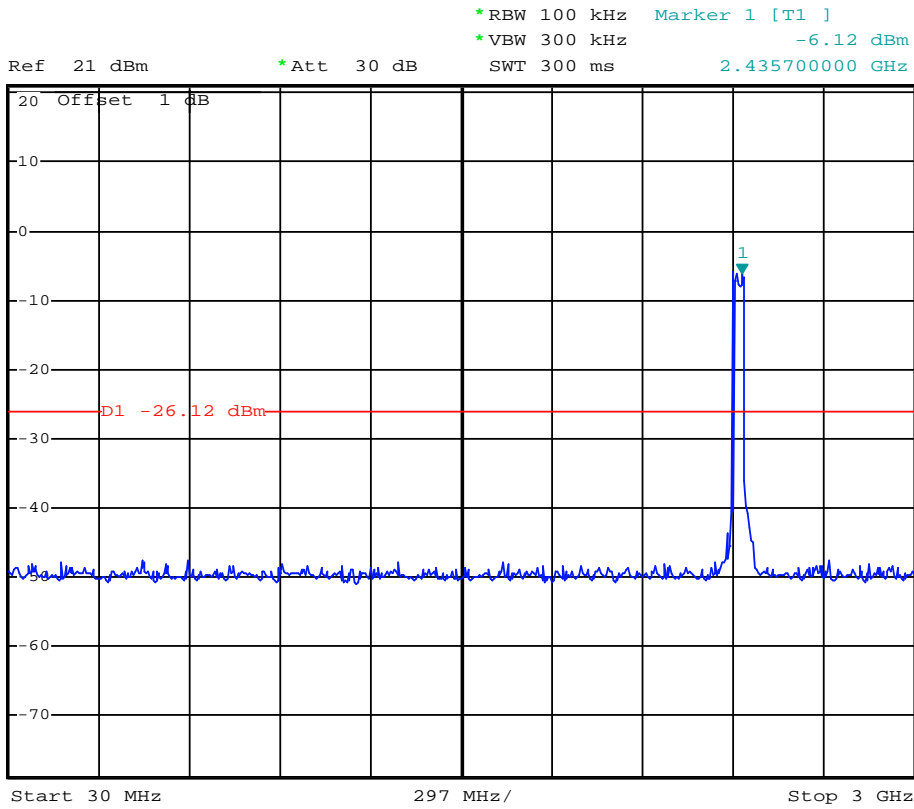

(Plot 4.6.4 A1: Channel 3: 2422MHz @ 802.11n(40MHz))

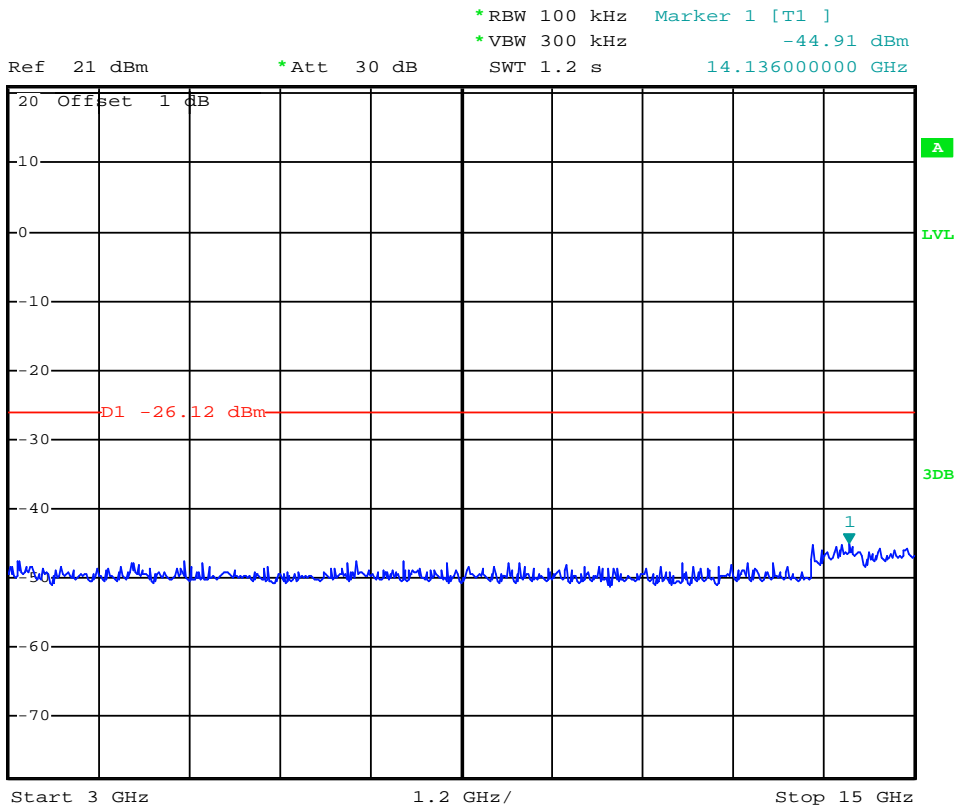

(Plot 4.6.4 A2: Channel 3: 2422MHz @ 802.11n(40MHz))

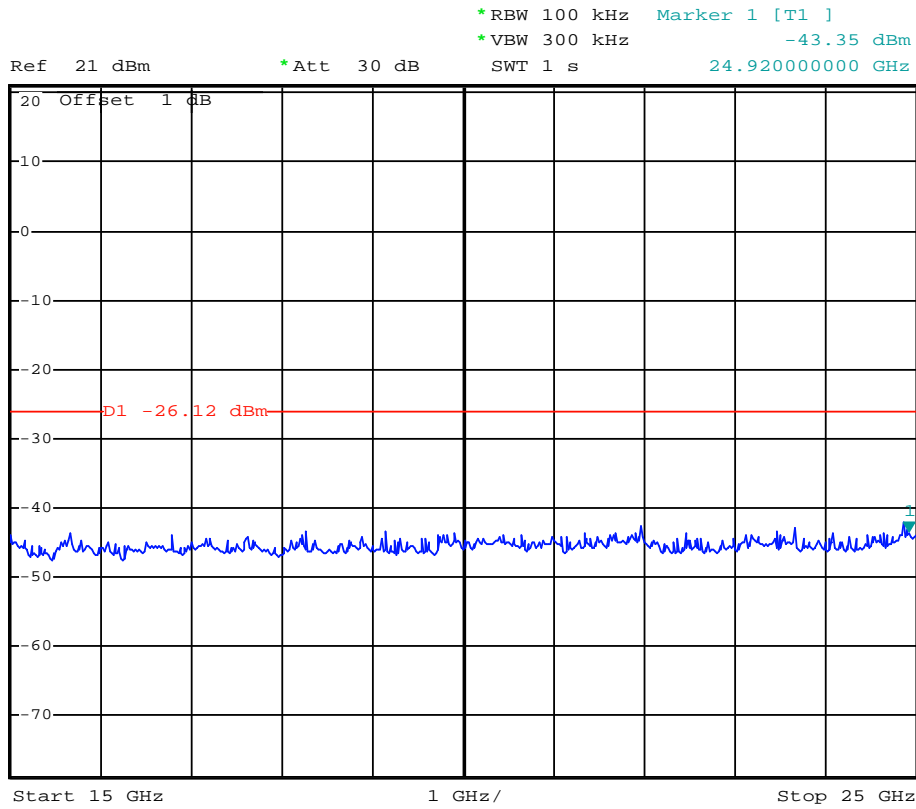

(Plot 4.6.4 A3: Channel 3: 2422MHz @ 802.11n(40MHz))

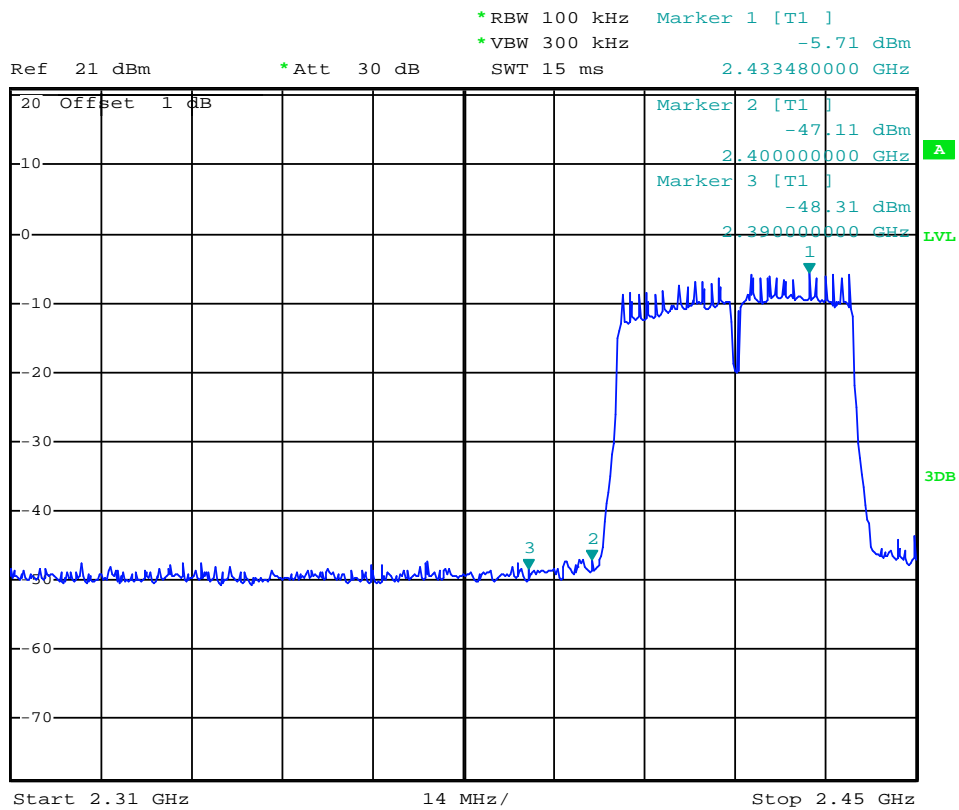

(Plot 4.6.4 A4: Channel 3: 2422MHz @ 802.11n(40MHz))

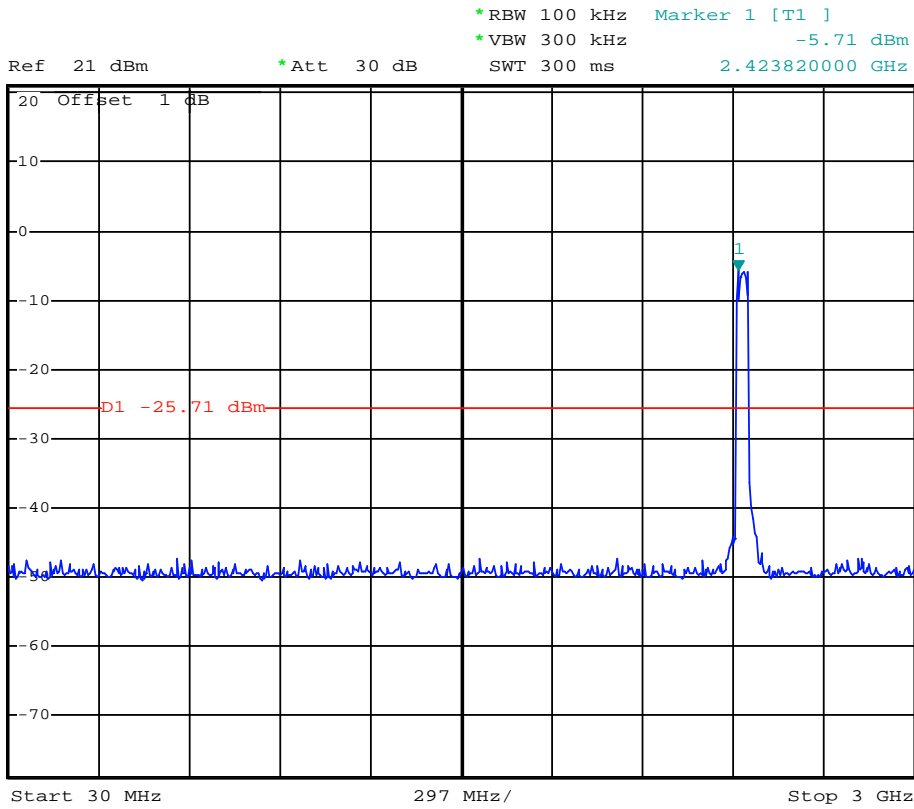

(Plot 4.6.4 B1: Channel 6: 2437MHz @ 802.11n(40MHz))

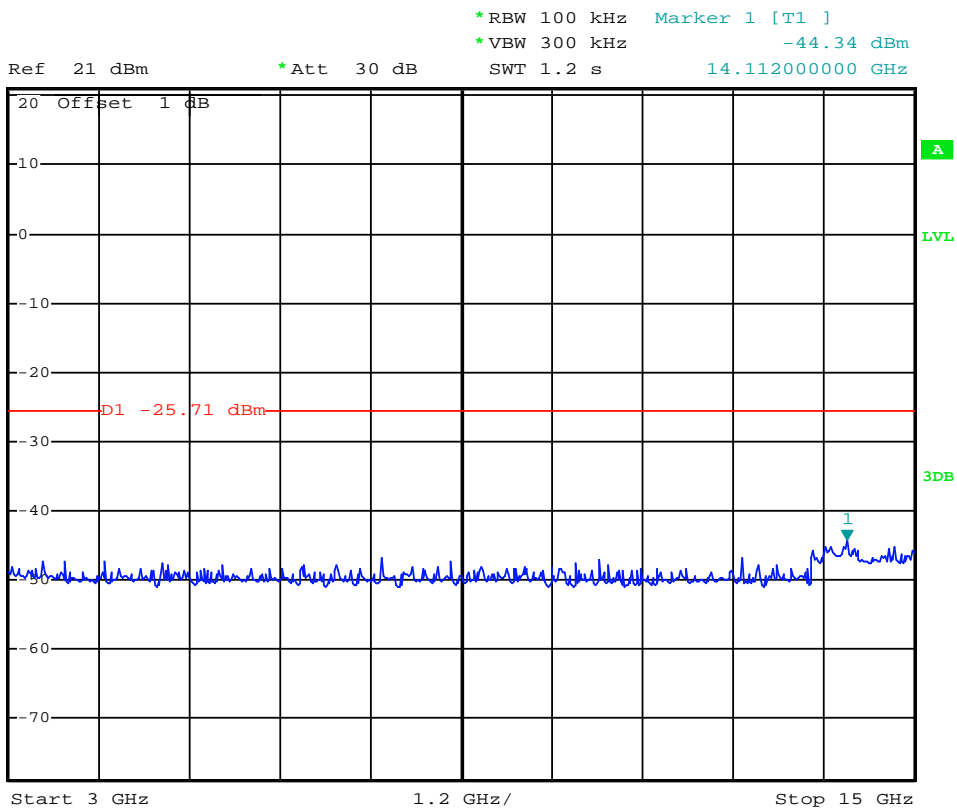

(Plot 4.6.4 B2: Channel 6: 2437MHz @ 802.11N(40MHz))

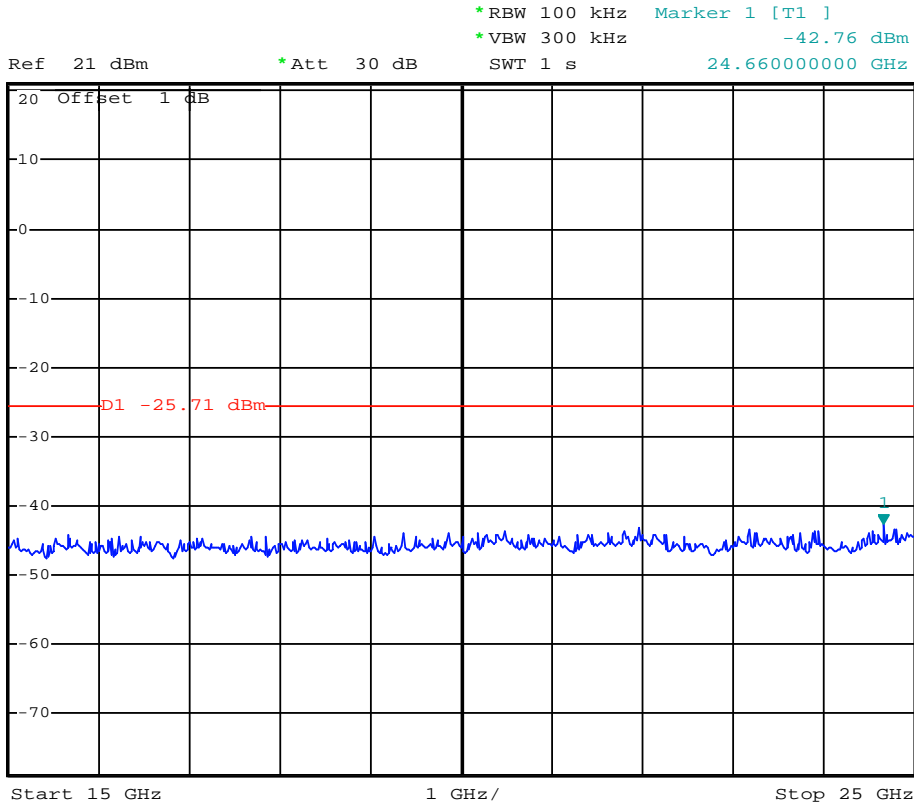

(Plot 4.6.4 B3: Channel 6: 2437MHz @ 802.11N(40MHz))

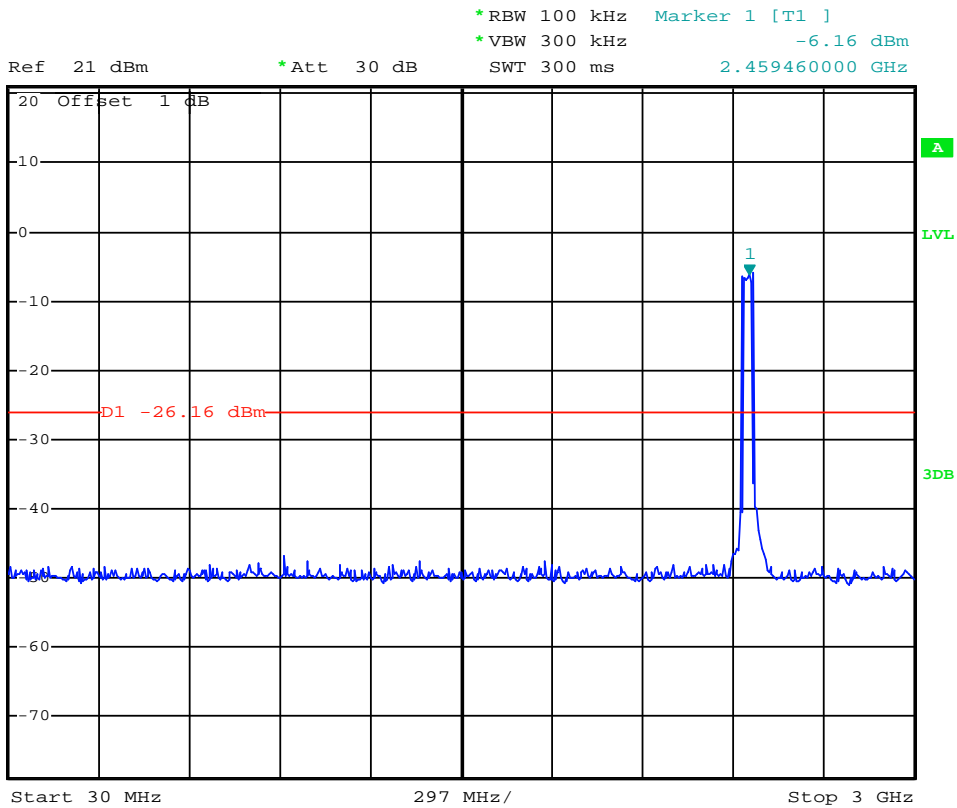

(Plot 4.6.4 C1: Channel 3: 2452MHz @ 802.11n(40MHz))

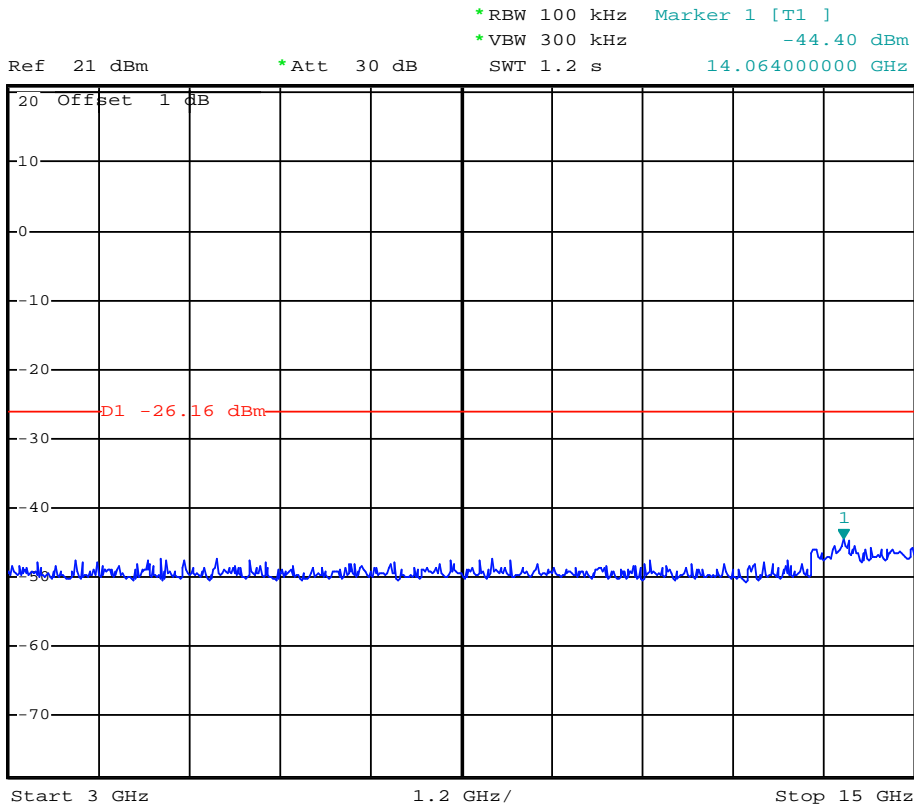

(Plot 4.6.4 C2: Channel 9: 2452MHz @ 802.11n(40MHz))

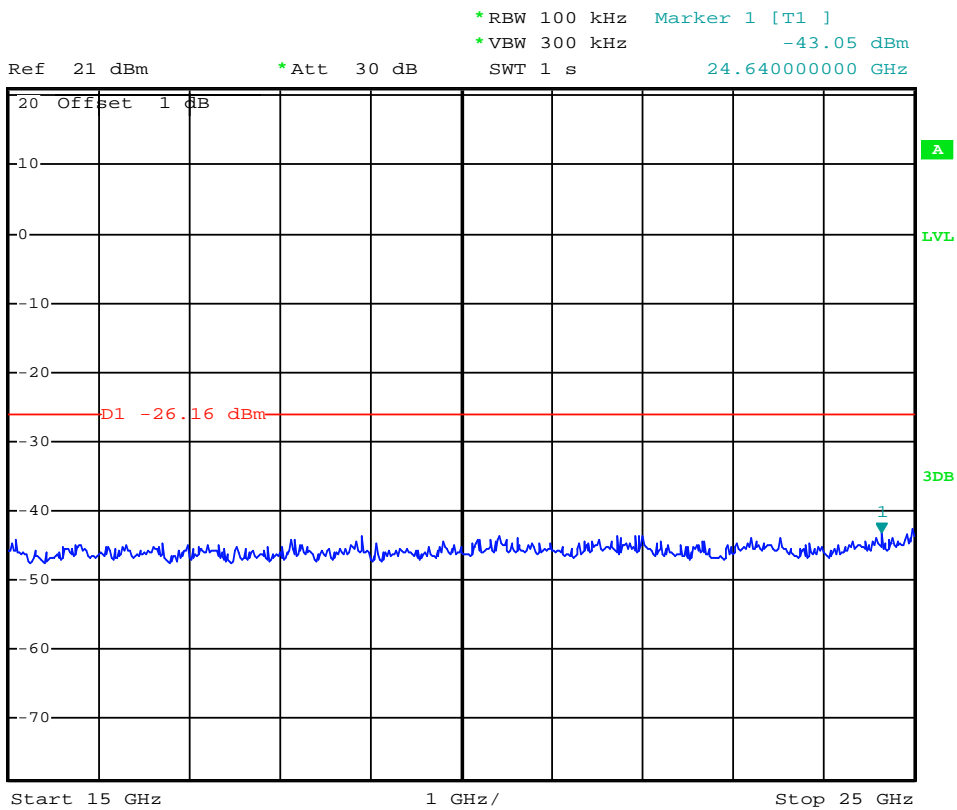

(Plot 4.6.4 C3: Channel 9: 2452MHz @ 802.11n(40MHz))



*RBW 100 kHz Marker 2 [T1]
*VBW 300 kHz -48.69 dBm
SWT 10 ms 2.483500000 GHz

Ref 21 dBm

*Att 30 dB

1 PK
MAXH

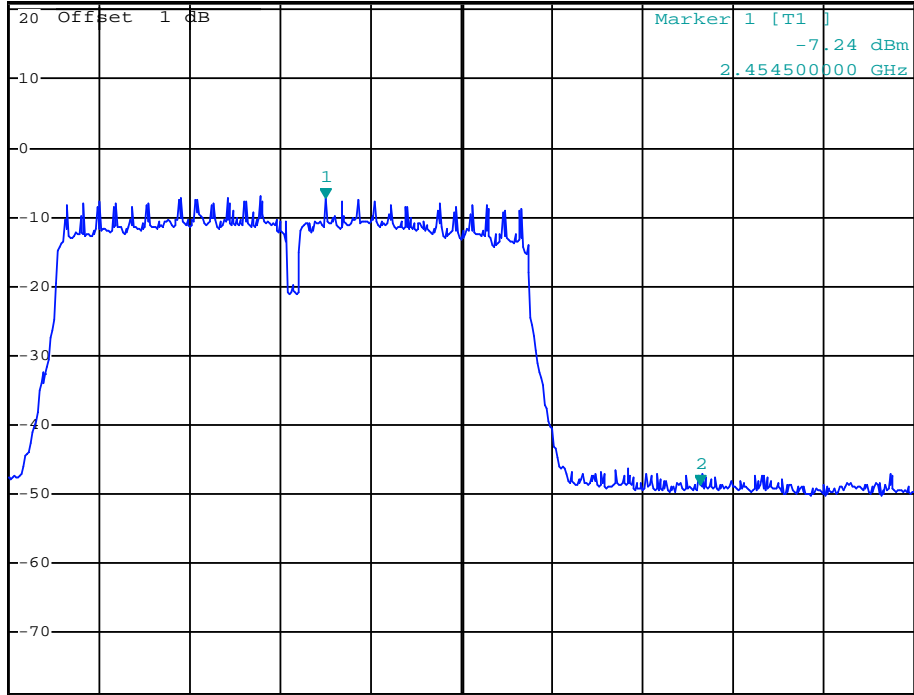

Start 2.43 GHz

7 MHz/

Stop 2.5 GHz

(Plot 4.6.4 C4: Channel 9: 2452MHz @ 802.11n(40MHz))

4.8. Antenna Requirement

Standard Applicable

For intentional device, according to FCC 47 CFR Section 15.203, an intentional radiator shall be designed to ensure that no antenna other than that furnished by the responsible party shall be used with the device.

And according to FCC 47 CFR Section 15.247 (c), if transmitting antennas of directional gain greater than 6dBi are used, the power shall be reduced by the amount in dB that the directional gain of the antenna exceeds 6dBi.

Refer to statement below for compliance.

The manufacturer may design the unit so that the user can replace a broken antenna, but the use of a standard antenna jack or electrical connector is prohibited. Further, this requirement does not apply to intentional radiators that must be professionally installed.

Antenna Connected Construction

The WLAN and BT share difference antenna and the maximum gain of WLAN antenna was 2.00 dBi.

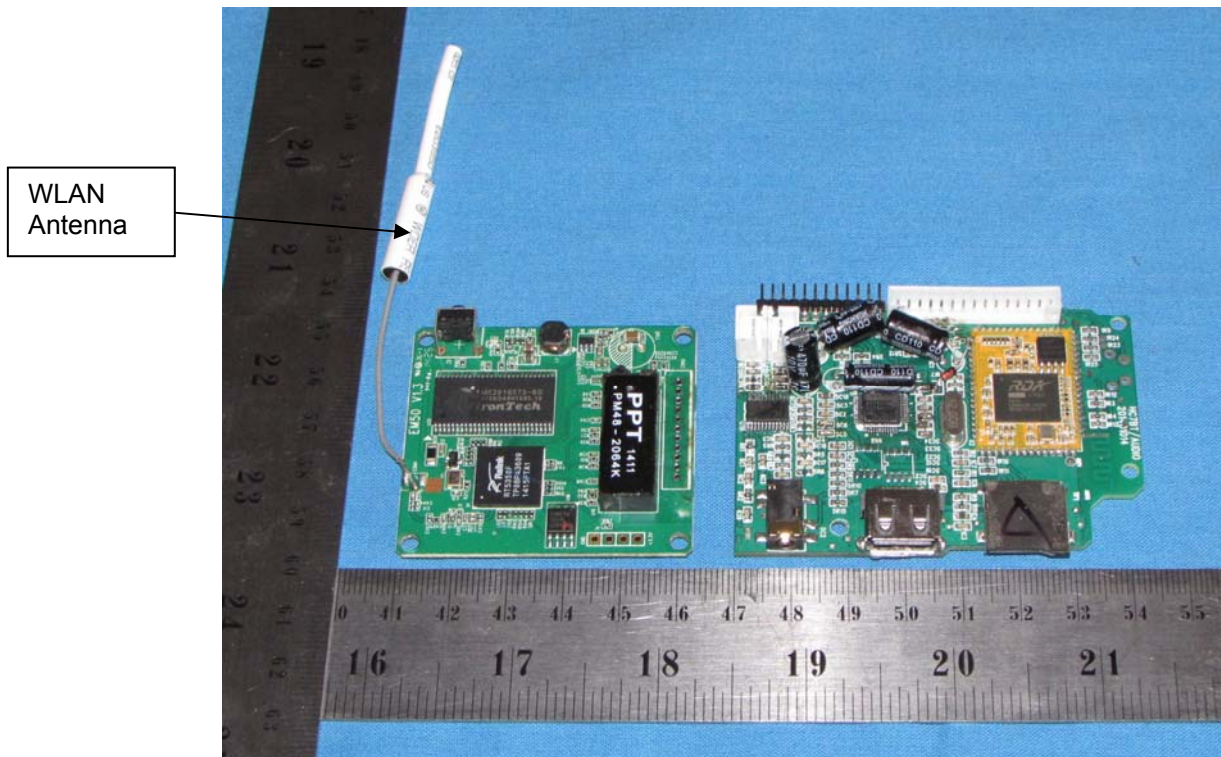

5. Test Setup Photos of the EUT



6. External and Internal Photos of the EUT

External Photos

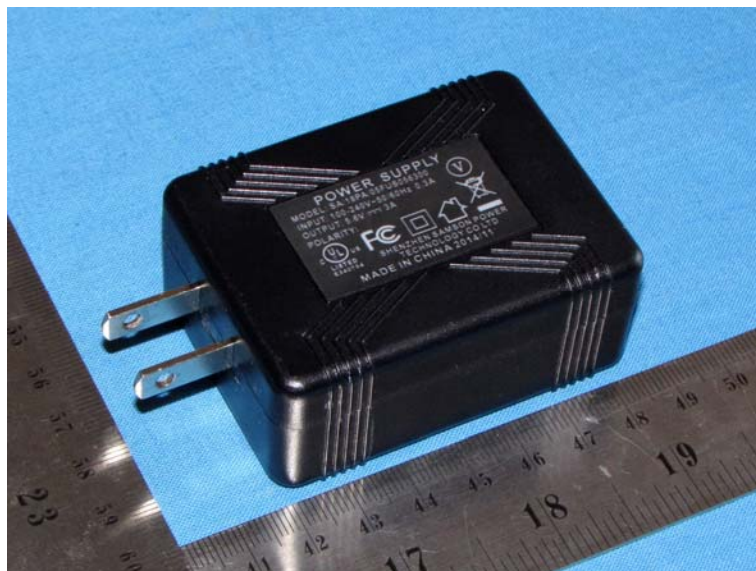



Internal Photos

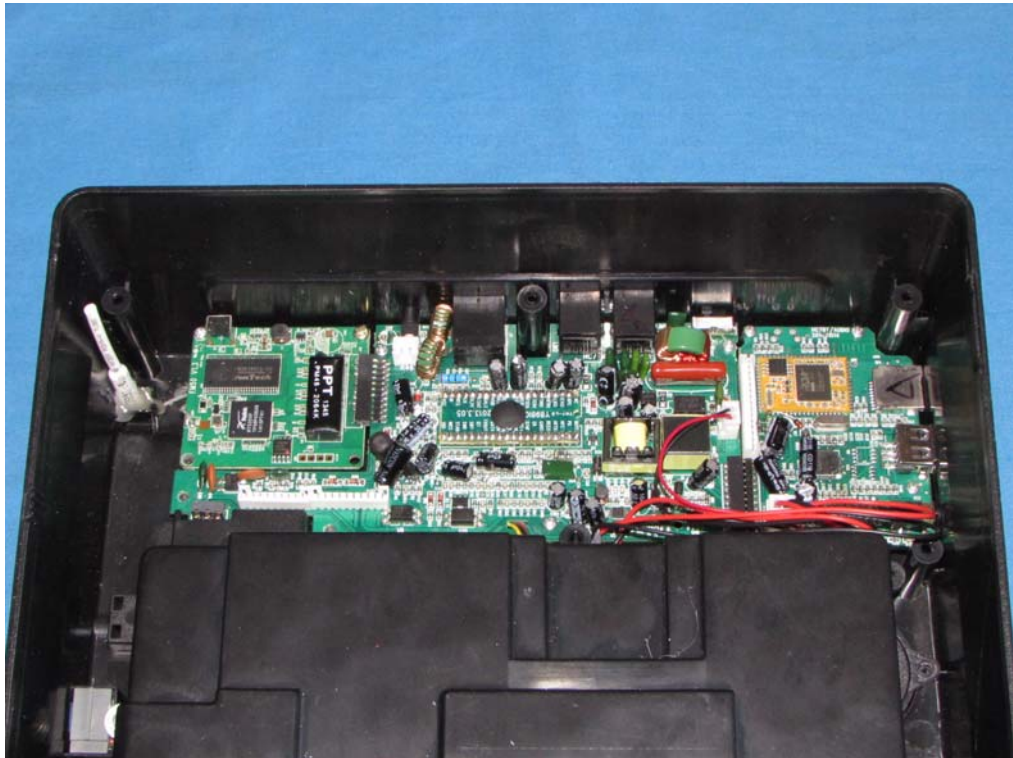

WLAN Antenna

BT Antenna

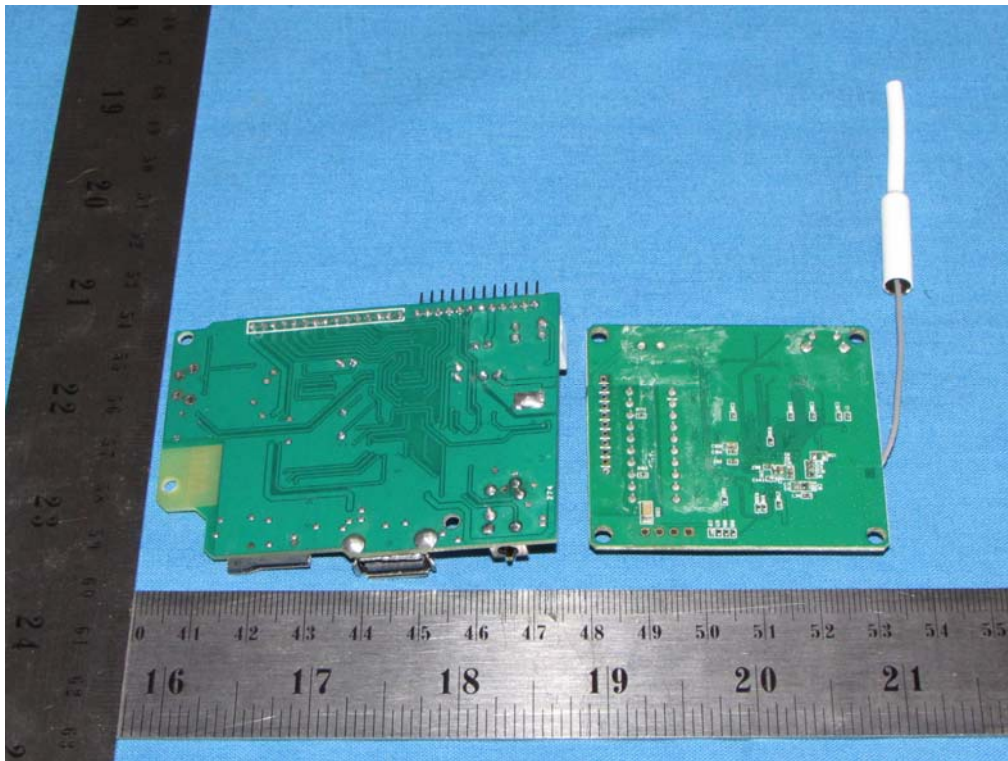
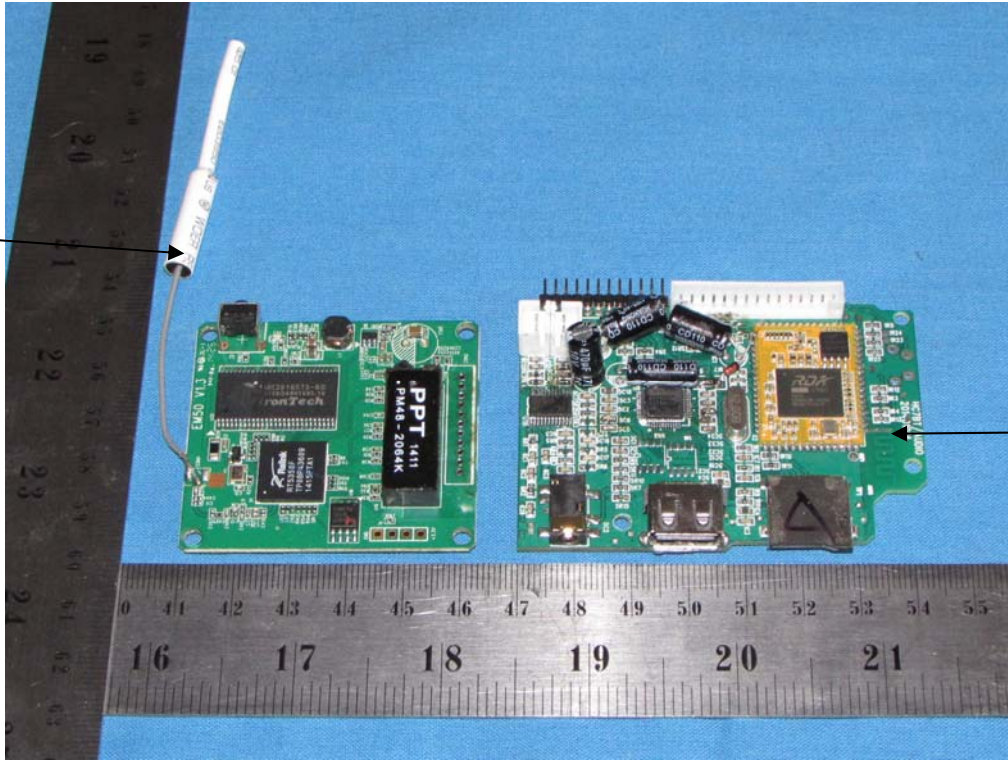

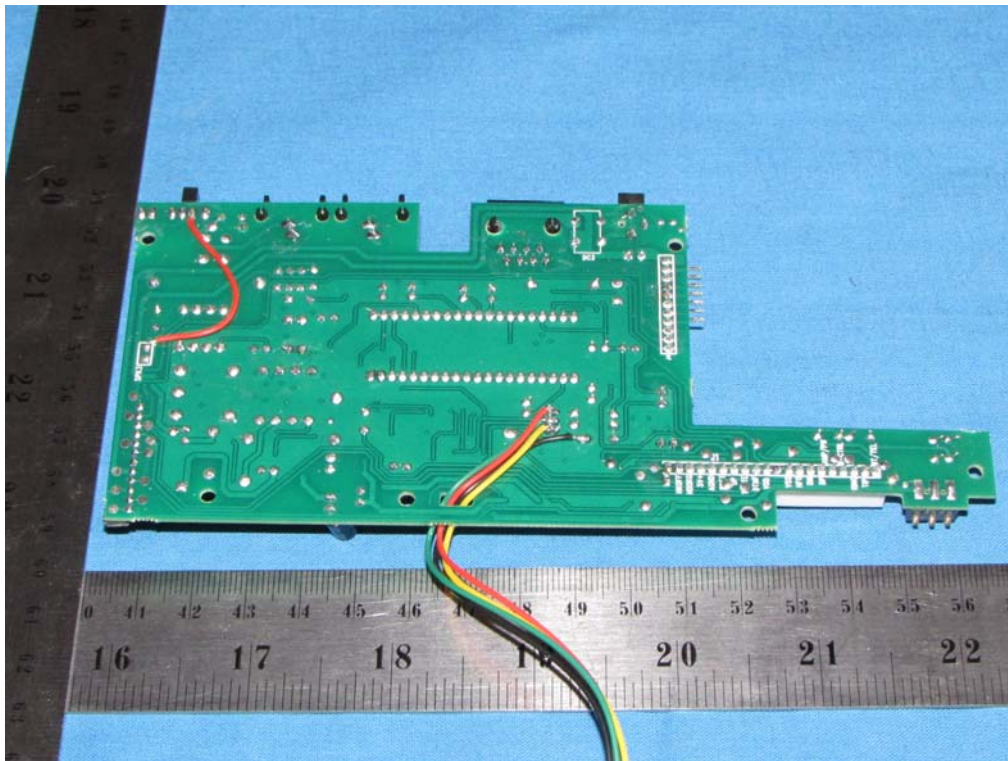
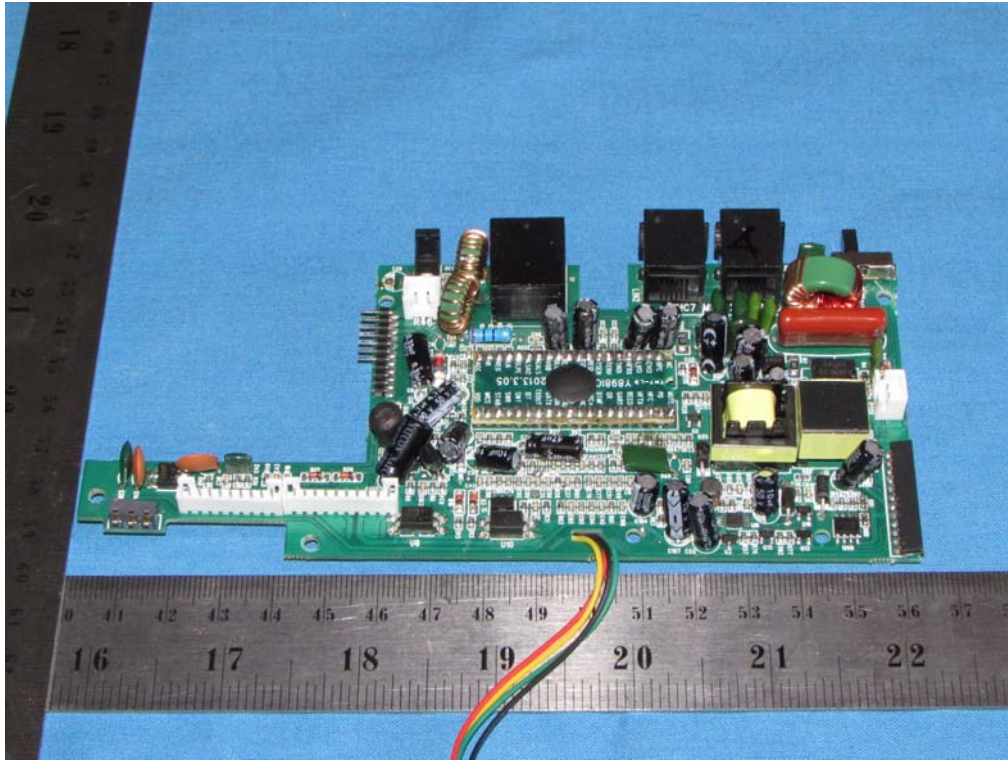

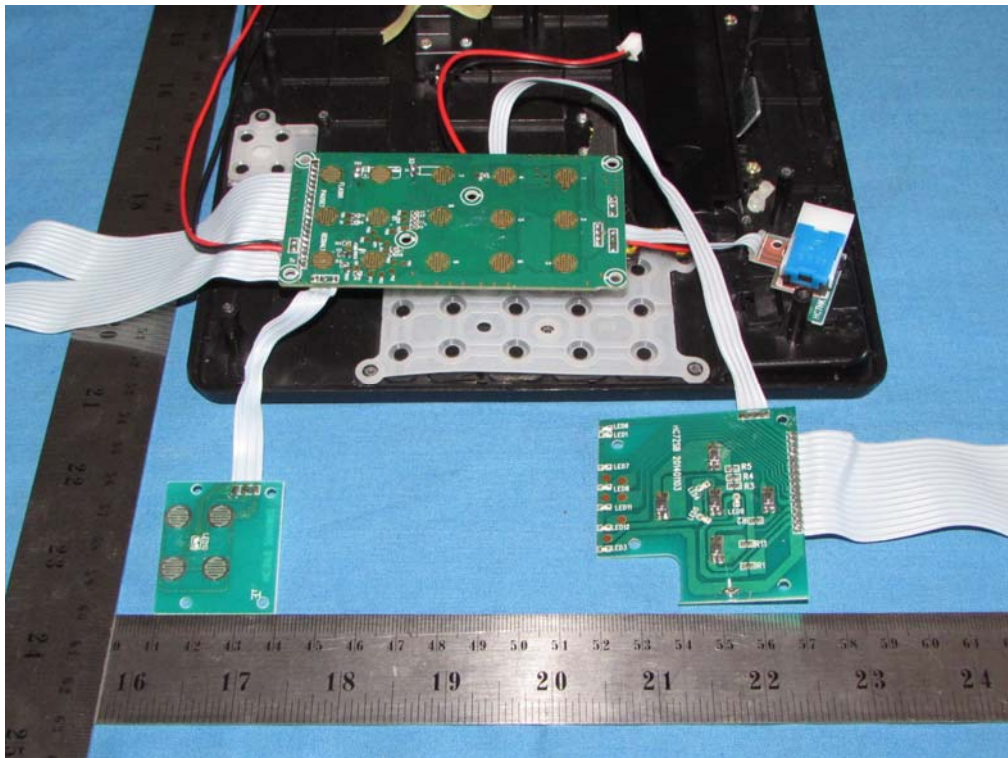
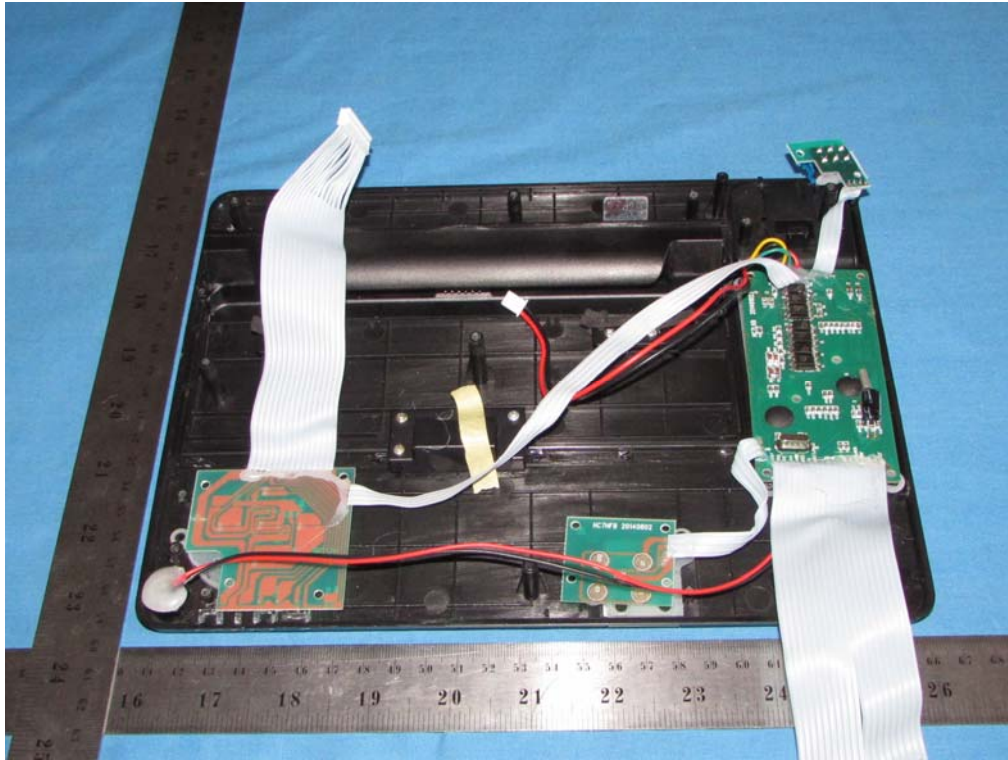

.....End of Report.....