

**ELECTROMAGNETIC EMISSIONS COMPLIANCE REPORT
INTENTIONAL RADIATOR CERTIFICATION TO
FCC PART 15 SUBPART C REQUIREMENT**

OF

LED TV

**Model No.: LE-43GY15-D1, SE43FGT, WD43FC2380, WD43XXXXXXXXXX,
SEXXXXXXXXXX, ELXXXXXXXXXX, LE-43GXXXXXXXXXX
(where X would be any Arabic number or English letter or blank)**

FCC ID: 2ACWIWD43FC238

Trademark: THTF, Fluid, Westinghouse, Seiki, Element

Report No.: KAD150511036E

Issue Date: June 30, 2015

Prepared for

**Shenyang Tongfang Multimedia Technology Co., Limited
No.10 Nanping East Road HunNan New District Shenyang, LiaoNing
Province P.R .China**

Prepared by

**DONGGUAN EMTEK CO., LTD.
No.281, Guantai Road, Nancheng District,
Dongguan, Guangdong, China
TEL: 86-769-22807078
FAX: 86-769-22807079**

**This report shall not be reproduced, except in full, without the written approval of
DONGGUAN EMTEK CO., LTD.**

VERIFICATION OF COMPLIANCE

Applicant:	Shenyang Tongfang Multimedia Technology Co., Limited No.10 Nanping East Road Hunnan New District Shenyang, Liaoning Province P.R .China
Manufacturer:	Shenyang Tongfang Multimedia Technology Co., Limited No.10 Nanping East Road Hunnan New District Shenyang, Liaoning Province P.R .China
Product Description:	LED TV
Model Number:	LE-43GY15-D1, SE43FGT, WD43FC2380, WD43XXXXXXXXXX, SEXXXXXXXXXX, ELXXXXXXXXXX, LE-43GXXXXXXXXXX (where X would be any Arabic number or English letter or blank)

We hereby certify that:

The above equipment was tested by DONGGUAN EMTEK CO., LTD. The test data, data evaluation, test procedures, and equipment configurations shown in this report were made in accordance with the procedures given in ANSI C63.10-2013 and the energy emitted by the sample EUT tested as described in this report is in compliance with conducted and radiated emission limits of FCC Rules Part 15.247(2014).

Date of Test : May 11, 2015 to June 27, 2015

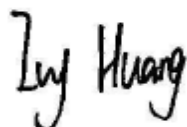
Prepared by : 
Ivy Huang/Editor

Reviewer : 
Hong Yang/Supervisor

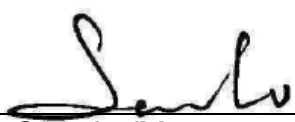
Approved & Authorized Signer : 
Sam Lv/Manager

Modified Information

Version	Summary	Revision Date	Report No.
Ver.1.0	Original Report	/	KAD150511036E

Table of Contents

1. GENERAL INFORMATION	6
1.1 PRODUCT DESCRIPTION	6
2. SYSTEM TEST CONFIGURATION	7
2.1 EUT CONFIGURATION	7
2.2 EUT EXERCISE	7
2.3 TEST PROCEDURE	7
2.4 CONFIGURATION OF TESTED SYSTEM	7
3. DESCRIPTION OF TEST MODES.....	8
4. SUMMARY OF TEST RESULTS.....	9
5. TEST FACILITY.....	10
6. CONDUCTED EMISSIONS TEST	11
6.1 MEASUREMENT PROCEDURE	11
6.2 TEST SET-UP (BLOCK DIAGRAM OF CONFIGURATION)	11
6.3 MEASUREMENT EQUIPMENT USED	11
6.4 CONDUCTED EMISSION LIMIT	11
6.5 MEASUREMENT RESULT	11
7. RADIATED EMISSION TEST.....	16
7.1 MEASUREMENT PROCEDURE	16
7.2 TEST SET-UP (BLOCK DIAGRAM OF CONFIGURATION)	17
7.3 MEASUREMENT EQUIPMENT USED	18
7.4 RADIATED EMISSION LIMIT	19
7.5 MEASUREMENT RESULT	20
8. 6DB BANDWIDTH TEST	37
8.1 MEASUREMENT PROCEDURE	37
8.2 TEST SET-UP (BLOCK DIAGRAM OF CONFIGURATION)	37
8.3 MEASUREMENT EQUIPMENT USED	37
8.4 MEASUREMENT RESULTS	37
9. MAXIMUM PEAK OUTPUT POWER TEST	46
9.1 MEASUREMENT PROCEDURE	46
9.2 TEST SET-UP (BLOCK DIAGRAM OF CONFIGURATION)	46
9.3 MEASUREMENT EQUIPMENT USED	46
9.4 PEAK POWER OUTPUT LIMIT	46
9.5 MEASUREMENT RESULTS	46
10. BAND EDGE TEST	47
10.1 MEASUREMENT PROCEDURE	47
10.2 TEST SET-UP (BLOCK DIAGRAM OF CONFIGURATION)	48
10.3 MEASUREMENT EQUIPMENT USED	48
10.4 MEASUREMENT RESULTS	48
11. POWER DENSITY	60
11.1 TEST EQUIPMENT	60
11.2 MEASURING INSTRUMENTS AND SETTING	60
11.3 TEST PROCEDURES	60
11.4 BLOCK DIAGRAM OF TEST SETUP	60
11.5 LIMIT	60
11.6 TEST RESULT	61

12. ANTENNA PORT EMISSION.....69

- 12.1 TEST EQUIPMENT 69
- 12.2 MEASURING INSTRUMENTS AND SETTING..... 69
- 12.3 TEST PROCEDURES..... 69
- 12.4 BLOCK DIAGRAM OF TEST SETUP 69
- 12.5 TEST RESULT 69

13. ANTENNA APPLICATION 76

- 13.1 ANTENNA REQUIREMENT 76
- 13.2 RESULT..... 76

APPENDIX I (PHOTOS OF EUT)(4 PAGES)

1. General Information

1.1 Product Description

Characteristics	Description
Product Name	LED TV
Model number	WD43FC2380
Power Supply	AC 100V-240V, 50/60Hz, 85W
Modulation	802.11b: DSSS(DBPSK/DQPSK/CCK) 802.11g/n: OFDM(BPSK/QPSK/16QAM/64QAM)
Operating Frequency Range	2412-2462MHz for 802.11b/g/n(HT20) 2422-2452MHz for 802.11n(HT40)
Number of Channels	11 for 20MHz bandwidth; 7 for 40MHz bandwidth
Transmit Power Max	802.11b: 15.62dBm 802.11g: 14.46dBm 802.11n(HT20): 13.92dBm 802.11n(HT40): 11.04dBm
Antenna Type	Internal antenna
Antenna Gain	2.0dBi

Note: for more details, please refer to the User's manual of the EUT.

2. System Test Configuration

2.1 EUT Configuration

The EUT configuration for testing is installed on RF field strength measurement to meet the Commissions requirement and operating in a manner which intends to maximize its emission characteristics in a continuous normal application.

2.2 EUT Exercise

The Transmitter was operated in the normal operating mode. The TX frequency was fixed which was for the purpose of the measurements.

2.3 Test Procedure

2.3.1 Conducted Emissions

The EUT is a placed on as turn table which is 0.8 m above ground plane. According to the requirements in Section 13.1.4.1 of ANSI C63.10-2013 Conducted emissions from the EUT measured in the frequency range between 0.15 MHz and 30 MHz using CISPR Quasi-Peak and average detector mode.

2.3.2 Radiated Emissions

The EUT is a placed on as turn table which is 0.8 m above ground plane. The turn table shall rotate 360 degrees to determine the position of maximum emission level. EUT is set 3m away from the receiving antenna which varied from 1m to 4m to find out the highest emission. And also, each emission was to be maximized by changing the polarization of receiving antenna both horizontal and vertical. In order to find out the max. Emission, the relative positions of this hand-held transmitter (EUT) was rotated through three orthogonal axes according to the requirements in Section 13.1.4.1 of ANSI C63.10-2013.

2.4 Configuration of Tested System

Fig. 2-1 Configuration of Tested System

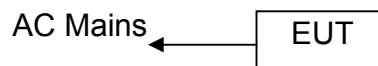

Table 2-1 Equipment Used in Tested System

Item	Equipment	Trademark	Model No.	FCC ID	Note
1.	LED TV	Westinghouse	WD43FC2380	2ACWIWD43FC238	EUT

Note:

- (1) Unless otherwise denoted as EUT in 『Remark』 column, device(s) used in tested system is a support equipment.

3. Description of Test Modes

The EUT has been tested under its typical operating condition.

The EUT configuration for testing is installed on RF field strength measurement to meet the Commissions requirement and operating in a manner which intends to maximize its emission characteristics in a continuous normal application.

The Transmitter was operated in the normal operating mode. The TX frequency was fixed which was for the purpose of the measurements.

Test of channel included the lowest and middle and highest frequency to perform the test, then record on this report.

Those data rates (802.11b: 1 Mbps; 802.11g: 6 Mbps; 802.11n (HT20) : MCS0; 802.11n (HT40) : MCS8) were used for all test.

Pre-defined engineering program for regulatory testing used to control the EUT for staying in continuous transmitting and receiving mode is programmed.

Frequency and Channel list for 802.11 b/g/n (HT20):

Channel	Frequency (MHz)	Channel	Frequency (MHz)	Channel	Frequency (MHz)
1	2412	5	2432	9	2452
2	2417	6	2437	10	2457
3	2422	7	2442	11	2462
4	2427	8	2447		

Frequency and Channel list for 802.11 n (HT40):

Channel	Frequency (MHz)	Channel	Frequency (MHz)	Channel	Frequency (MHz)
3	2422	5	2432	8	2447
4	2427	6	2437	9	2452
		7	2442		

Test Frequency and Channel for 802.11 b/g/n (HT20):

Lowest Frequency		Middle Frequency		Highest Frequency	
Channel	Frequency (MHz)	Channel	Frequency (MHz)	Channel	Frequency (MHz)
1	2412	6	2437	11	2462

Test Frequency and channel for 802.11 n (HT40):

Lowest Frequency		Middle Frequency		Highest Frequency	
Channel	Frequency (MHz)	Channel	Frequency (MHz)	Channel	Frequency (MHz)
3	2422	6	2437	9	2452

4. Summary of Test Results

FCC Rules	Description Of Test	Result
§15.247(a)(2)	6dB bandwidth	Pass
§15.247(b)(3)	Max Peak output Power test	Pass
§15.247(e)	Power density	Pass
§15.247(d)	Band edge test	Pass
§15.207	AC Power Conducted Emission	Pass
§15.247(d), §15.209	Radiated Emission	Pass
§15.247(d)	Antenna Port Emission	Pass
§15.247(b)&§15.203	Antenna Application	Pass

5. Test Facility

Site Description

EMC Lab : Accredited by FCC, June 18, 2014
The Certificate Number is 247565

Accredited by Industry Canada, February 19, 2014
The Certificate Number is 9444A

Name of Firm : DONGGUAN EMTEK CO., LTD.
Site Location : No.281, Guantai Road, Nancheng District,
Dongguan, Guangdong, China

6. Conducted Emissions Test

6.1 Measurement Procedure

1. The EUT was placed on a table which is 0.8m above ground plane.
2. Maximum procedure was performed on the six highest emissions to ensure EUT compliance.
3. Repeat above procedures until all frequency measured were complete.

6.2 Test SET-UP (Block Diagram of Configuration)

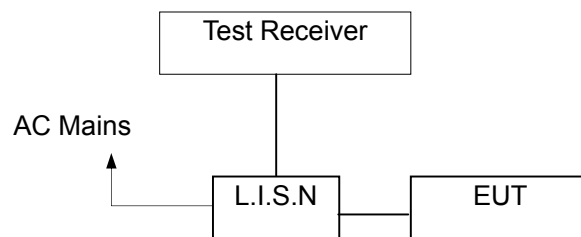

6.3 Measurement Equipment Used

Conducted Emission Test Site					
EQUIPMENT TYPE	MFR	MODEL NUMBER	SERIAL NUMBER	Last Cal.	Due date
Test Receiver	Rohde & Schwarz	ESCS30	100018	03/16/2015	03/15/2016
L.I.S.N	Rohde & Schwarz	ENV216	100017	03/16/2015	03/15/2016
RF Switching Unit	CDS	RSU-M2	38401	03/16/2015	03/15/2016
Coaxial Cable	CDS	79254	46107086	03/16/2015	03/15/2016

6.4 Conducted Emission Limit

Conducted Emission Frequency(MHz)	Quasi-peak	Average
0.15-0.5	66-56	56-46
0.5-5.0	56	46
5.0-30.0	60	50

- Note:** 1. The lower limit shall apply at the transition frequencies
 2. The limit decreases in line with the logarithm of the frequency in the range of 0.15 to 0.50MHz.

6.5 Measurement Result

Please refer to the following pages.

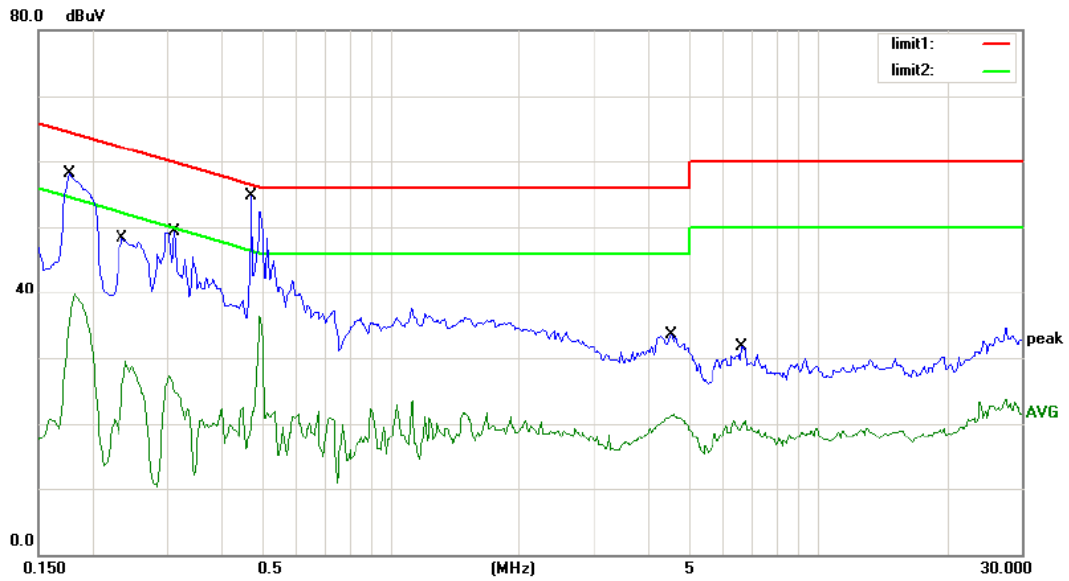

Site site #1 Phase: **N** Temperature: 24
 Limit: (CE)FCC PART 15 class B_QP Power: AC 120V/60Hz Humidity: 55 %
 Mode: TX
 Note:

No.	Mk.	Freq. MHz	Reading Level dBuV	Correct Factor dB	Measure- ment dBuV	Limit dBuV	Over dB	Detector	Comment
1	*	0.1770	56.41	0.00	56.41	64.63	-8.22	QP	
2		0.1770	39.63	0.00	39.63	54.63	-15.00	AVG	
3		0.2354	45.68	0.00	45.68	62.26	-16.58	QP	
4		0.2354	29.44	0.00	29.44	52.26	-22.82	AVG	
5		0.3120	46.53	0.00	46.53	59.92	-13.39	QP	
6		0.3120	27.02	0.00	27.02	49.92	-22.90	AVG	
7		0.4740	46.35	0.00	46.35	56.44	-10.09	QP	
8		0.4740	23.93	0.00	23.93	46.44	-22.51	AVG	
9		4.5400	31.89	0.00	31.89	56.00	-24.11	QP	
10		4.5400	21.42	0.00	21.42	46.00	-24.58	AVG	
11		6.6400	29.35	0.00	29.35	60.00	-30.65	QP	
12		6.6400	20.48	0.00	20.48	50.00	-29.52	AVG	

*:Maximum data x:Over limit !:over margin Comment: Factor build in receiver.

7. Radiated Emission Test

7.1 Measurement Procedure

1. Below 1000MHz, The EUT was placed on a turn table which is 0.8m above ground plane, And above 1000MHz, The EUT was placed on a styrofoam table which is 1.5m above ground plane.
2. Maximum procedure was performed on the six highest emissions to ensure EUT compliance.
3. And also, each emission was to be maximized by changing the polarization of receiving antenna both horizontal and vertical.
4. Repeat above procedures until all frequency measured was complete.

When spectrum scanned from 30MHz to 1GHz setting resolution bandwidth 120KHz and video bandwidth 300KHz:

EMI Test Receiver	Setting
Attenuation	Auto
RB	120KHz
VB	300KHz
Detector	QP
Trace	Max hold

When spectrum scanned above 1GHz setting resolution bandwidth 1MHz, video bandwidth 3MHz:

EMI Test Receiver	Setting
Attenuation	Auto
RB	1MHz
VB	3MHz
Detector	Peak
Trace	Max hold

When spectrum scanned above 1GHz setting resolution bandwidth 1MHz, video bandwidth 10Hz:

EMI Test Receiver	Setting
Attenuation	Auto
RB	1MHz
VB	10Hz
Detector	AVG
Trace	Max hold

7.2 Test SET-UP (Block Diagram of Configuration)

(A) Radiated Emission Test Set-Up, Frequency Below 30MHz

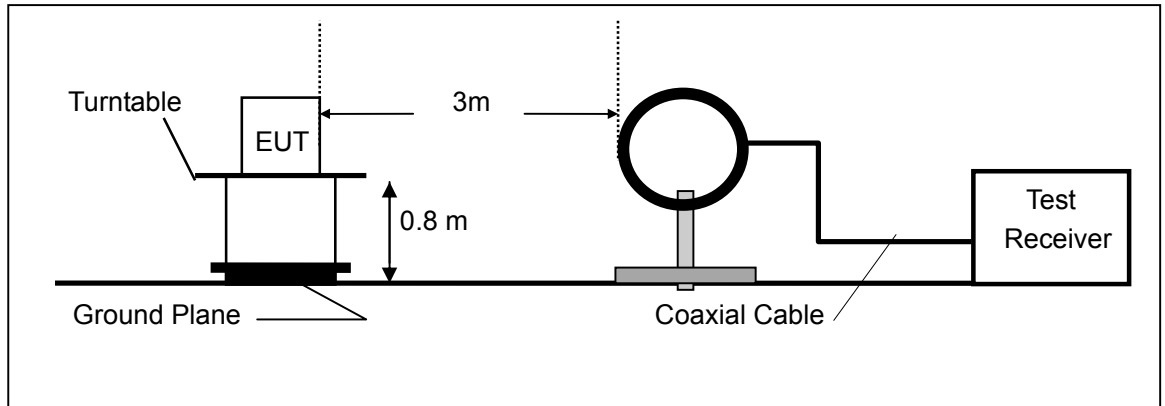

(B) Radiated Emission Test Set-Up, Frequency Below 1000MHz

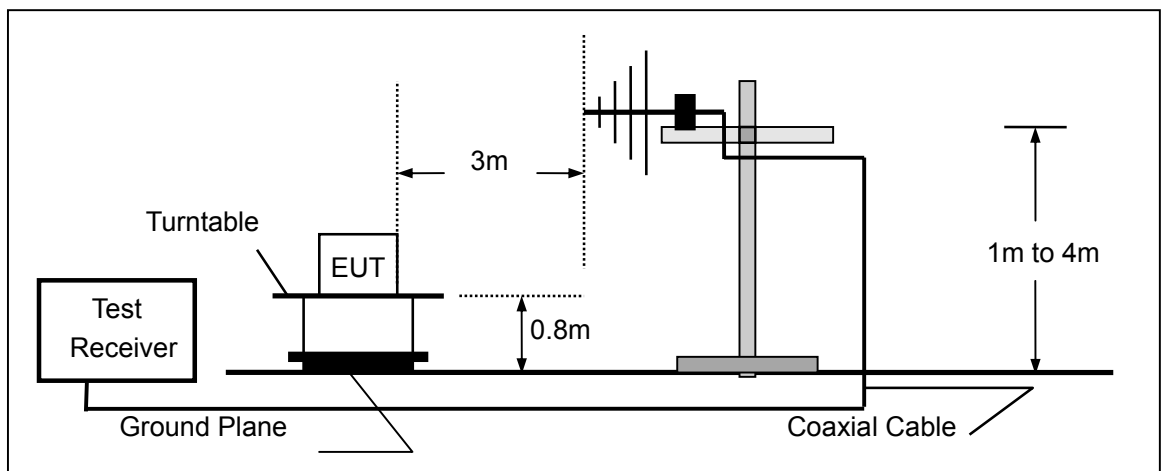

(C) Radiated Emission Test Set-Up, Frequency above 1000MHz

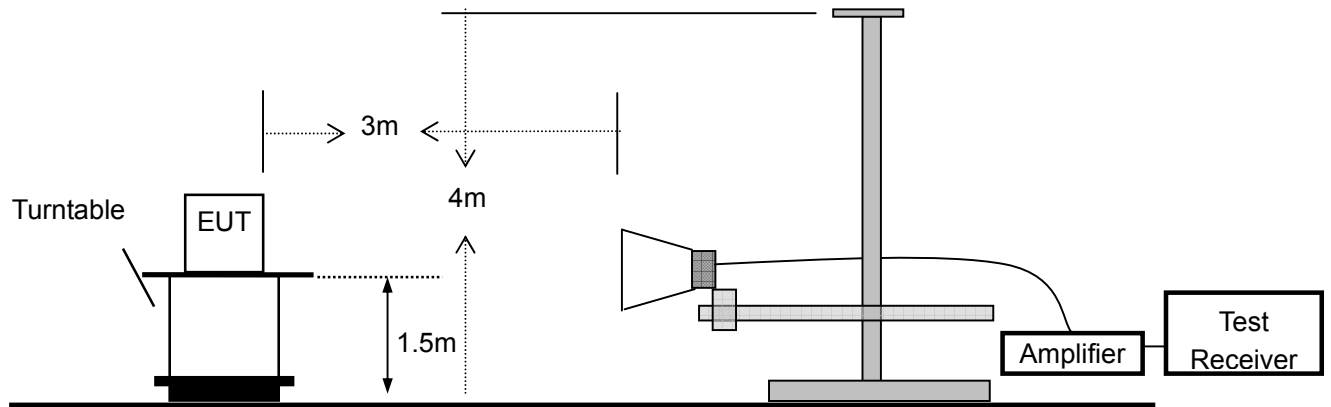

7.3 Measurement Equipment Used

Item	Equipment	Manufacturer	Model No.	Serial No.	Last Cal.	Cal. Interval
1.	Test Receiver	Rohde & Schwarz	ESCI	1166.5950.03	03/16/2015	1 Year
2.	Bilog Antenna	Schwarzbeck	VULB9163	000141	03/16/2015	1 Year
3.	Power Amplifier	CDS	RSU-M352	818	03/16/2015	1 Year
4.	Power Amplifier	HP	8447F	OPT H64	03/16/2015	1 Year
5.	Color Monitor	SUNSP0	SP-140A	N/A	03/16/2015	1 Year
6.	Single Line Filter	JIANLI	XL-3	N/A	03/16/2015	1 Year
7.	Single Phase Power Line Filter	JIANLI	DL-2X100B	N/A	03/16/2015	1 Year
8.	3 Phase Power Line Filter	JIANLI	DL-4X100B	N/A	03/16/2015	1 Year
9.	DC Power Filter	JIANLI	DL-2X50B	N/A	03/16/2015	1 Year
10.	Cable	Schwarzbeck	PLF-100	549489	03/16/2015	1 Year
11.	Cable	Rosenberger	CIL02	A0783566	03/16/2015	1 Year
12.	Cable	Rosenberger	RG 233/U	525178	03/16/2015	1 Year
13.	Signal Analyzer	Rohde & Schwarz	FSV30	103040	12/29/2014	1 Year
14.	Horn Antenna	Schwarzbeck	BBHA9120D	9120D-1272	12/29/2014	1 Year
15.	Power Amplifier	LUNAR EM	LNA1G18-40	J10100000081	12/29/2014	1 Year
16.	Cable	H+S	CBL-26	N/A	12/29/2014	1 Year
17.	Cable	H+S	CBL-26	N/A	12/29/2014	1 Year
18.	Cable	H+S	CBL-26	N/A	12/29/2014	1 Year

7.4 Radiated Emission Limit

The emissions from an intentional radiator shall not exceed the field strength levels specified in the following table 15.209(a):

Frequencies (MHz)	Field Strength (micorvolts/meter)	Measurement Distance (meters)
0.009~0.490	2400/F(KHz)	300
0.490~1.705	24000/F(KHz)	30
1.705~30.0	30	30
30~88	100	3
88~216	150	3
216~960	200	3
Above 960	500	3

15.205 Restricted bands of operation

MHz	MHz	MHz	GHz
0.090 - 0.110	16.42 - 16.423	399.9 - 410	4.5 - 5.15
¹ 0.495 - 0.505	16.69475 - 16.69525	608 - 614	5.35 - 5.46
2.1735 - 2.1905	16.80425 - 16.80475	960 - 1240	7.25 - 7.75
4.125 - 4.128	25.5 - 25.67	1300 - 1427	8.025 - 8.5
4.17725 - 4.17775	37.5 - 38.25	1435 - 1626.5	9.0 - 9.2
4.20725 - 4.20775	73 - 74.6	1645.5 - 1646.5	9.3 - 9.5
6.215 - 6.218	74.8 - 75.2	1660 - 1710	10.6 - 12.7
6.26775 - 6.26825	108 - 121.94	1718.8 - 1722.2	13.25 - 13.4
6.31175 - 6.31225	123 - 138	2200 - 2300	14.47 - 14.5
8.291 - 8.294	149.9 - 150.05	2310 - 2390	15.35 - 16.2
8.362 - 8.366	156.52475 - 156.52525	2483.5 - 2500	17.7 - 21.4
8.37625 - 8.38675	156.7 - 156.9	2690 - 2900	22.01 - 23.12
8.41425 - 8.41475	162.0125 - 167.17	3260 - 3267	23.6 - 24.0
12.29 - 12.293	167.72 - 173.2	3332 - 3339	31.2 - 31.8
12.51975 - 12.52025	240 - 285	3345.8 - 3358	36.43 - 36.5
12.57675 - 12.57725	322 - 335.4	3600 - 4400	(²)

Remark 1. Emission level in dBuV/m=20 log (uV/m)

- :
2. Measurement was performed at an antenna to the closed point of EUT distance of meters.
 3. Only spurious frequency is permitted to locate within the Restricted Bands specified in provision of § 15.205, and the emissions located in restricted bands also comply with 15.209 limit.

7.5 Measurement Result

Below 30MHz:

All the modulation modes were tested the data of the test mode are recorded in the following pages.

Operation Mode:	TX Mode	Test Date :	June 08, 2015
Frequency Range:	9KHz~30MHz	Temperature :	28°C
Test Result:	PASS	Humidity :	60 %
Measured Distance:	3m	Test By:	WOLF

Freq. (MHz)	Ant.Pol. H/V	Emission Level (dBuV/m)	Limit 3m (dBuV/m)	Over (dB)
--	--	--	--	--

Note: the amplitude of spurious emission that is attenuated by more than 20dB below the permissible limit has no need to be reported.

Distance extrapolation factor = $40 \log(\text{Specific distance} / \text{test distance})$ (dB);

Limit line = Specific limits(dBuV) + distance extrapolation factor.

Below 1000MHz:

All the modulation modes were tested the data of the worst mode (TX 802.11b) are recorded in the following pages and the others modulation methods do not exceed the limits.

Please refer to the following test plots:

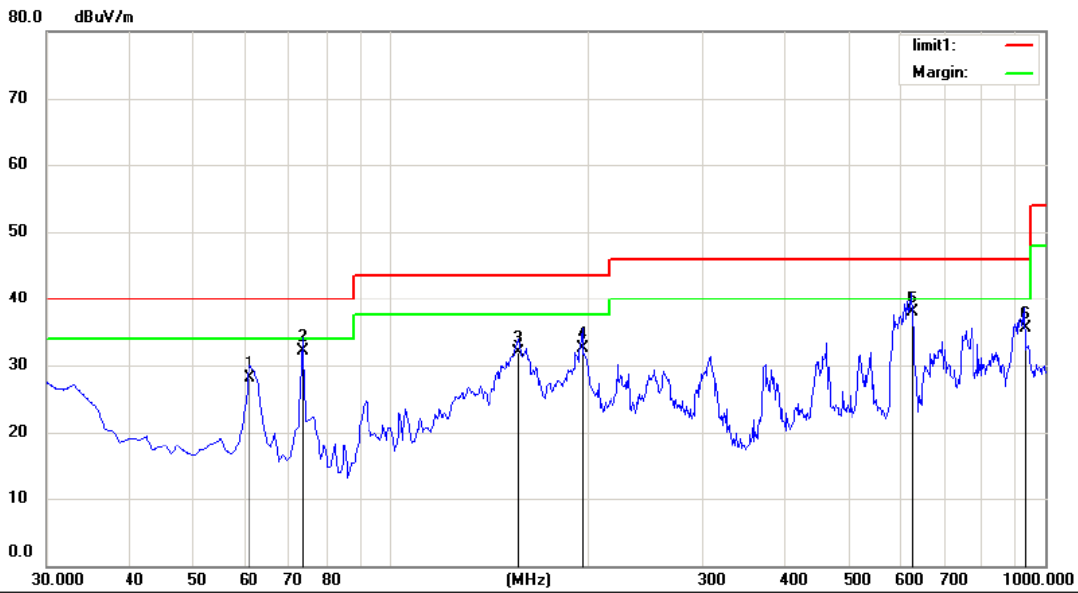

Site: Chamber #1 Polarization: **Horizontal** Temperature: 24
 Limit: (RE)FCC PART 15 class B 3m Power: AC 120V/60Hz Humidity: 55 %
 Mode: TX 2412
 Note:

No.	Mk.	Freq.	Reading Level	Correct Factor	Measurement	Limit	Over	Antenna Height	Table Degree	Comment
		MHz	dBuV	dB	dBuV/m	dBuV/m	dB	cm	degree	
1		61.0400	47.79	-19.70	28.09	40.00	-11.91	QP		
2	*	73.6500	54.60	-22.57	32.03	40.00	-7.97	QP		
3		157.0700	50.15	-18.28	31.87	43.50	-11.63	QP		
4		196.8400	50.38	-17.81	32.57	43.50	-10.93	QP		
5		626.5500	46.18	-8.22	37.96	46.00	-8.04	QP		
6		930.1600	38.13	-2.68	35.45	46.00	-10.55	QP		

*:Maximum data x:Over limit !:over margin

Operator: Snake

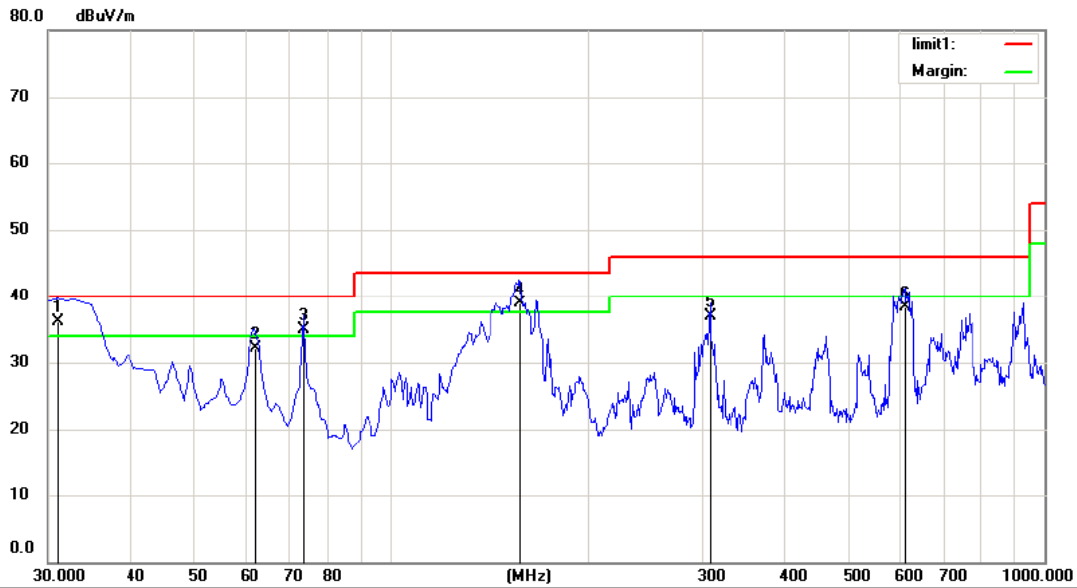

Site Chamber #1 Polarization: **Vertical** Temperature: 24
 Limit: (RE)FCC PART 15 class B 3m Power: AC 120V/60Hz Humidity: 55 %
 Mode: TX 2412
 Note:

No.	Mk.	Freq.	Reading Level	Correct Factor	Measurement	Limit	Over	Antenna Height	Table Degree	
		MHz	dBuV	dB	dBuV/m	dBuV/m	dB	Detector	cm	degree
1	*	30.9700	51.06	-14.90	36.16	40.00	-3.84	QP		
2		62.0100	52.10	-19.98	32.12	40.00	-7.88	QP		
3	!	73.6500	57.38	-22.57	34.81	40.00	-5.19	QP		
4	!	158.0400	57.18	-18.34	38.84	43.50	-4.66	QP		
5		308.3900	50.73	-13.87	36.86	46.00	-9.14	QP		
6		613.9400	46.68	-8.32	38.36	46.00	-7.64	QP		

*:Maximum data x:Over limit !:over margin

Operator: Snake

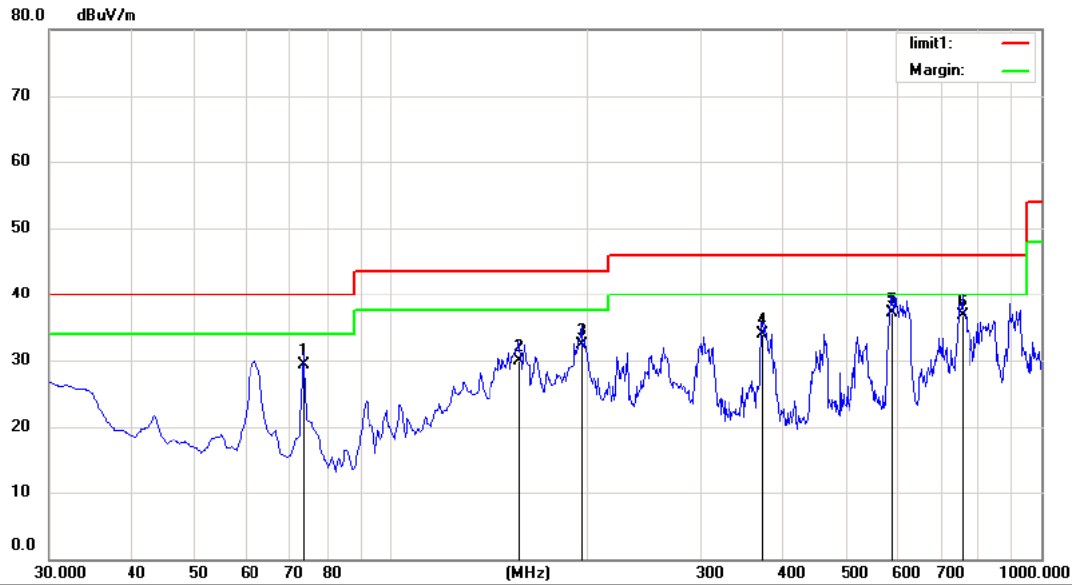

Site Chamber #1 Polarization: **Horizontal** Temperature: 24
 Limit: (RE)FCC PART 15 class B 3m Power: AC 120V/60Hz Humidity: 55 %
 Mode: TX 2437
 Note:

No.	Mk.	Freq. MHz	Reading Level dBuV	Correct Factor dB	Measure- ment dBuV/m	Limit dBuV/m	Over dB	Antenna Height cm	Table Degree	Detector	Comment
1		73.6500	51.87	-22.57	29.30	40.00	-10.70			QP	
2		158.0400	48.15	-18.34	29.81	43.50	-13.69			QP	
3		196.8400	50.02	-17.81	32.21	43.50	-11.29			QP	
4		372.4100	46.26	-12.35	33.91	46.00	-12.09			QP	
5	*	589.6900	45.59	-8.54	37.05	46.00	-8.95			QP	
6		757.5000	42.51	-5.73	36.78	46.00	-9.22			QP	

*:Maximum data x:Over limit !:over margin

Operator: Snake

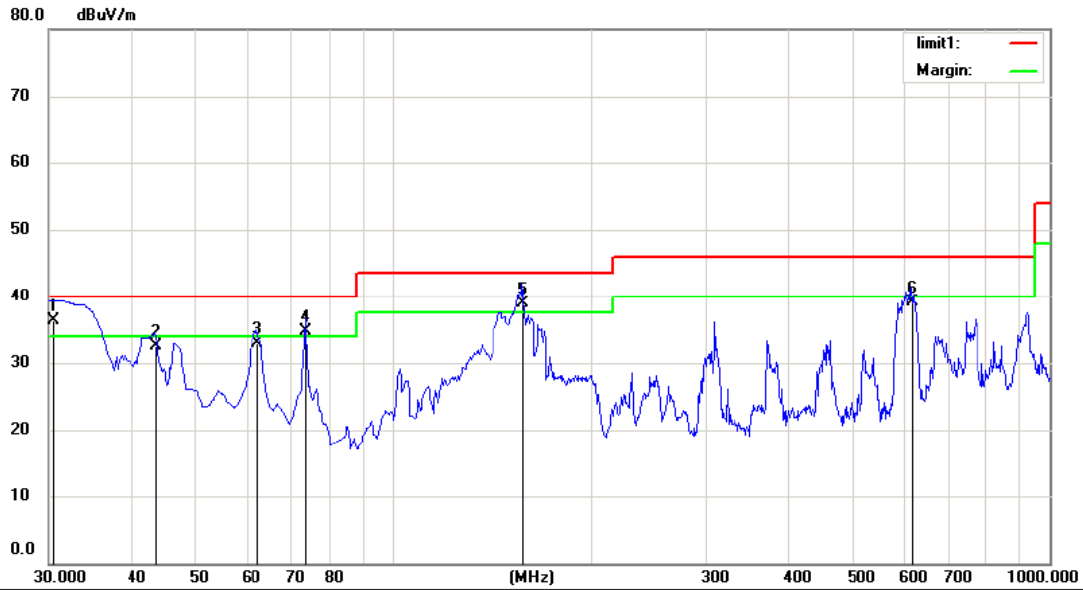

Site: Chamber #1 Polarization: **Vertical** Temperature: 24
 Limit: (RE)FCC PART 15 class B 3m Power: AC 120V/60Hz Humidity: 55 %
 Mode: TX 2437
 Note:

No.	Mk.	Freq. MHz	Reading Level dBuV	Correct Factor dB	Measure- ment dBuV/m	Limit dBuV/m	Over dB	Antenna Height cm	Table Degree degree	Comment
1	*	30.4237	51.34	-15.03	36.31	40.00	-3.69	QP		
2		43.5800	45.89	-13.37	32.52	40.00	-7.48	QP		
3		62.0100	52.81	-19.98	32.83	40.00	-7.17	QP		
4	!	73.6500	57.19	-22.57	34.62	40.00	-5.38	QP		
5	!	158.0400	57.24	-18.34	38.90	43.50	-4.60	QP		
6		616.8500	47.35	-8.31	39.04	46.00	-6.96	QP		

*:Maximum data x:Over limit !:over margin

Operator: Snake

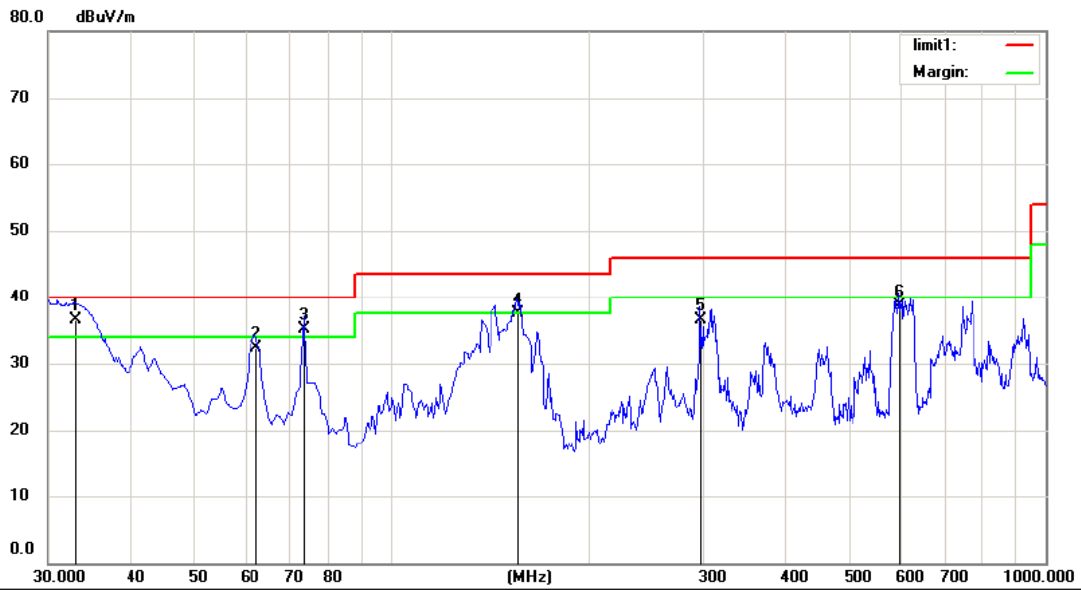

Site: Chamber #1
 Limit: (RE)FCC PART 15 class B 3m
 Mode: TX 2462
 Note:

Polarization: **Vertical**
 Power: AC 120V/60Hz
 Temperature: 24
 Humidity: 55 %

No.	Mk.	Freq. MHz	Reading Level dBuV	Correct Factor dB	Measure- ment dBuV/m	Limit dBuV/m	Over dB	Antenna Height cm	Table Degree	Detector	Comment
1	*	32.9100	50.92	-14.46	36.46	40.00	-3.54			QP	
2		62.0100	52.21	-19.98	32.23	40.00	-7.77			QP	
3	!	73.6500	57.70	-22.57	35.13	40.00	-4.87			QP	
4	!	156.1000	55.82	-18.25	37.57	43.50	-5.93			QP	
5		296.7500	50.98	-14.54	36.44	46.00	-9.56			QP	
6		597.4500	47.21	-8.44	38.77	46.00	-7.23			QP	

*:Maximum data x:Over limit !:over margin

Operator: Snake

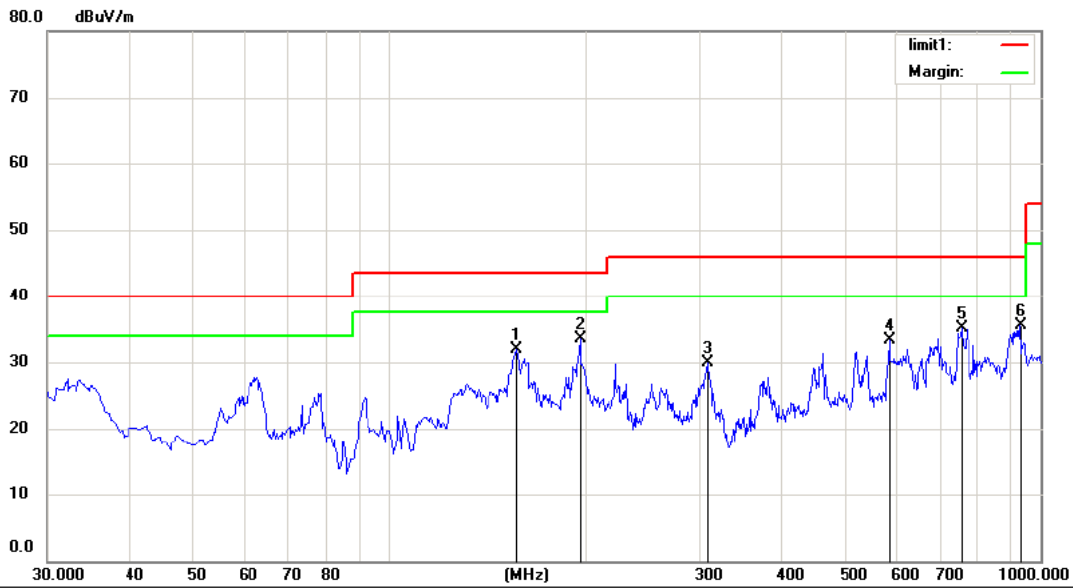

Site Chamber #1 Polarization: **Horizontal** Temperature: 24
 Limit: (RE)FCC PART 15 class B 3m Power: AC 240V/60Hz Humidity: 55 %
 Mode: TX 2412
 Note:

No.	Mk.	Freq.	Reading Level	Correct Factor	Measurement	Limit	Over	Antenna Height	Table Degree	
		MHz	dBuV	dB	dBuV/m	dBuV/m	dB	cm	degree	Comment
1		157.0700	50.15	-18.28	31.87	43.50	-11.63	QP		
2	*	196.8400	51.38	-17.81	33.57	43.50	-9.93	QP		
3		308.3900	43.61	-13.78	29.83	46.00	-16.17	QP		
4		588.7200	41.76	-8.55	33.21	46.00	-12.79	QP		
5		757.5000	40.89	-5.73	35.16	46.00	-10.84	QP		
6		930.1600	38.19	-2.68	35.51	46.00	-10.49	QP		

*:Maximum data x:Over limit !:over margin

Operator: Snake

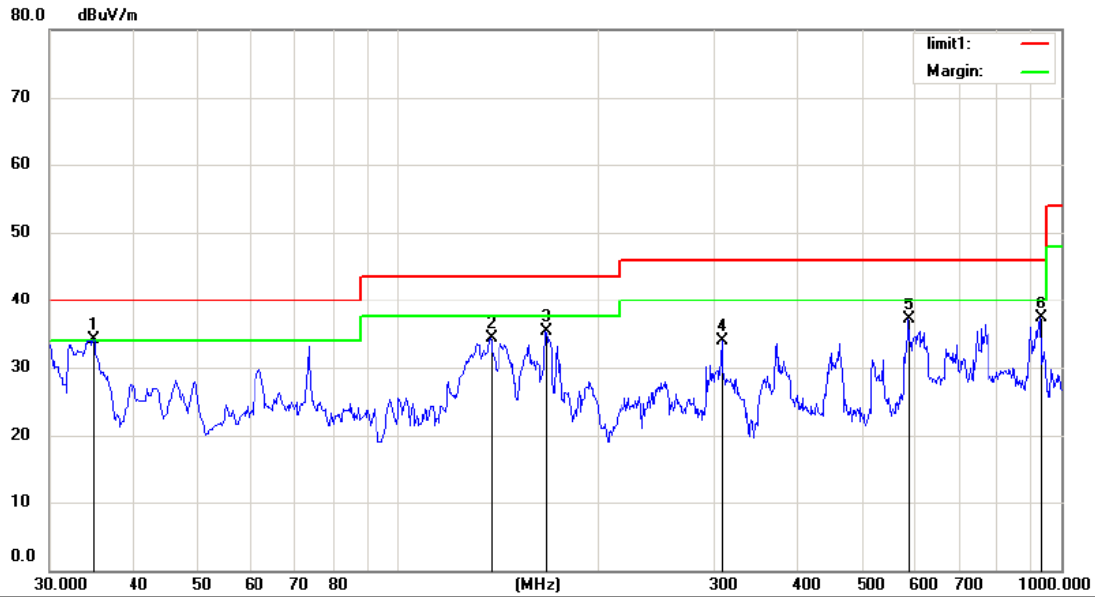

Site Chamber #1 Polarization: **Vertical** Temperature: 24
 Limit: (RE)FCC PART 15 class B 3m Power: AC 240V/60Hz Humidity: 55 %
 Mode: TX 2412
 Note:

No.	Mk.	Freq.	Reading Level	Correct Factor	Measurement	Limit	Over	Antenna Height	Table Degree		
		MHz	dBuV	dB	dBuV/m	dBuV/m	dB	Detector	cm	degree	Comment
1	*	34.8821	48.36	-14.18	34.18	40.00	-5.82	QP			
2		137.9030	51.12	-16.82	34.30	43.50	-9.20	QP			
3		167.7400	53.75	-18.41	35.34	43.50	-8.16	QP			
4		308.3900	47.73	-13.87	33.86	46.00	-12.14	QP			
5		590.6600	45.63	-8.52	37.11	46.00	-8.89	QP			
6		930.1600	39.93	-2.63	37.30	46.00	-8.70	QP			

*:Maximum data x:Over limit !:over margin

Operator: Snake

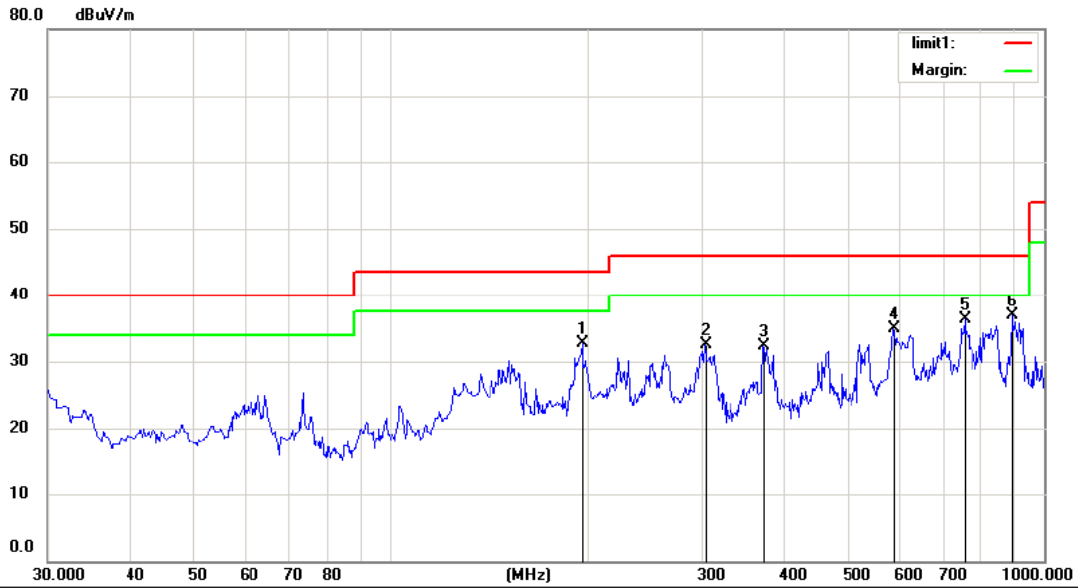

Site: Chamber #1 Polarization: **Horizontal** Temperature: 24
 Limit: (RE)FCC PART 15 class B 3m Power: AC 240V/60Hz Humidity: 55 %
 Mode: TX 2437
 Note:

No.	Mk.	Freq. MHz	Reading Level dBuV	Correct Factor dB	Measure- ment dBuV/m	Limit dBuV/m	Over dB	Antenna Height cm	Table Degree	Comment
1		196.8400	50.52	-17.81	32.71	43.50	-10.79	QP		
2		303.5400	46.65	-14.09	32.56	46.00	-13.44	QP		
3		372.4100	44.58	-12.35	32.23	46.00	-13.77	QP		
4		589.6900	43.54	-8.54	35.00	46.00	-11.00	QP		
5		757.5000	42.07	-5.73	36.34	46.00	-9.66	QP		
6	*	894.2700	40.72	-3.77	36.95	46.00	-9.05	QP		

*:Maximum data x:Over limit !:over margin

Operator: Snake

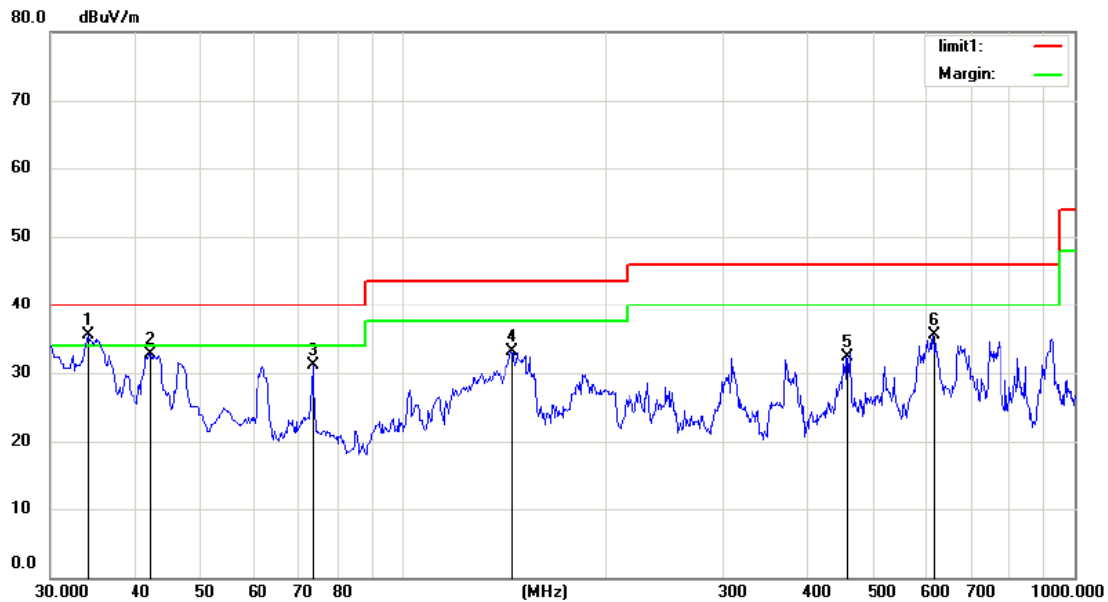

Site Chamber #1
 Limit: (RE)FCC PART 15 class B 3m
 Mode: TX 2437
 Note:

Polarization: **Vertical**
 Power: AC 240V/60Hz

Temperature: 24
 Humidity: 55 %

No.	Mk.	Freq.	Reading Level	Correct Factor	Measurement	Limit	Over	Antenna Height	Table Degree	
		MHz	dBuV	dB	dBuV/m	dBuV/m	dB	cm	degree	Comment
1	*	34.0363	49.78	-14.28	35.50	40.00	-4.50			QP
2		42.3021	46.20	-13.52	32.68	40.00	-7.32			QP
3		73.6500	53.69	-22.57	31.12	40.00	-8.88			QP
4		145.4300	50.45	-17.42	33.03	43.50	-10.47			QP
5		457.7700	43.29	-11.06	32.23	46.00	-13.77			QP
6		616.8500	43.86	-8.31	35.55	46.00	-10.45			QP

*:Maximum data x:Over limit !:over margin

Operator: Snake

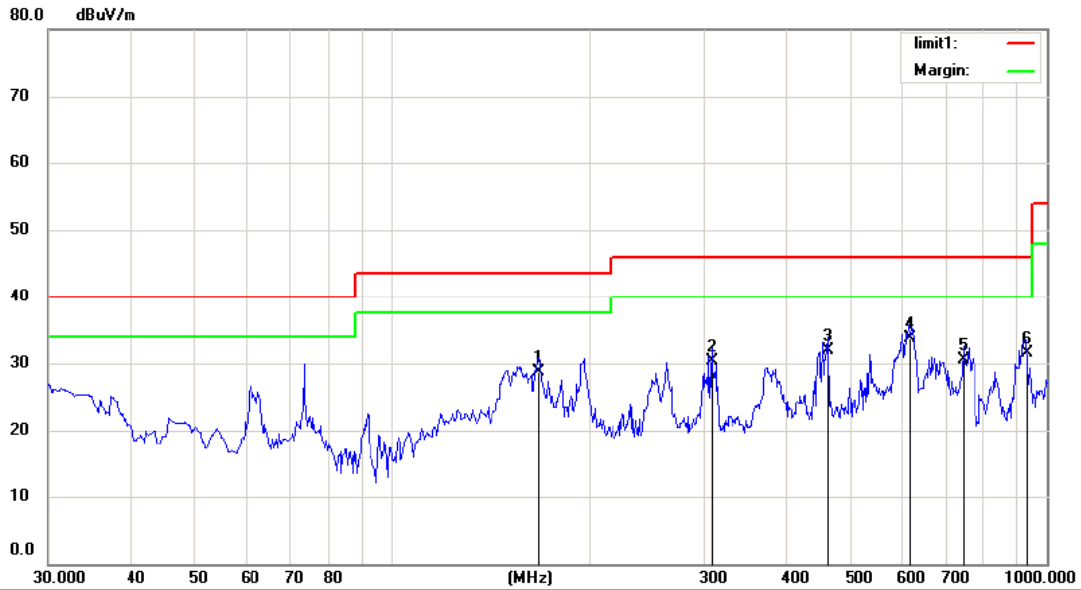

Site: Chamber #1 Polarization: **Horizontal** Temperature: 24
 Limit: (RE)FCC PART 15 class B 3m Power: AC 240V/60Hz Humidity: 55 %
 Mode: TX 2462
 Note:

No.	Mk.	Freq.	Reading Level	Correct Factor	Measurement	Limit	Over	Antenna Height	Table Degree	Comment
		MHz	dBuV	dB	dBuV/m	dBuV/m	dB	cm	degree	
1		167.7400	47.18	-18.41	28.77	43.50	-14.73	QP		
2		308.3900	43.99	-13.78	30.21	46.00	-15.79	QP		
3		463.5900	42.85	-10.91	31.94	46.00	-14.06	QP		
4	*	617.8200	42.05	-8.30	33.75	46.00	-12.25	QP		
5		746.8300	36.39	-5.84	30.55	46.00	-15.45	QP		
6		930.1600	34.26	-2.68	31.58	46.00	-14.42	QP		

*:Maximum data x:Over limit !:over margin Operator: Snake

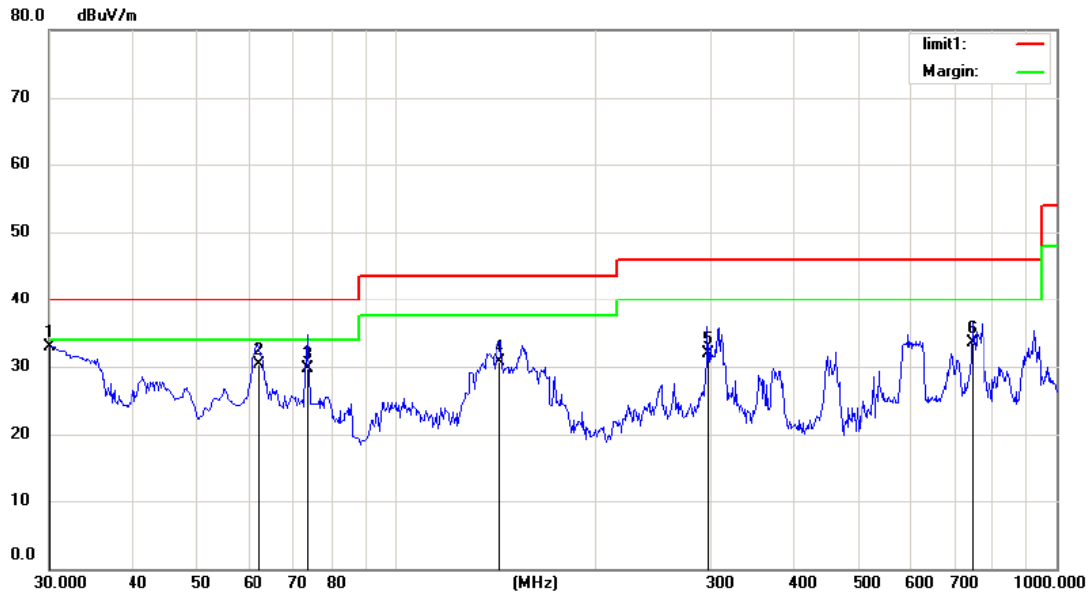

Site Chamber #1 Polarization: **Vertical** Temperature: 24
 Limit: (RE)FCC PART 15 class B 3m Power: AC 240V/60Hz Humidity: 55 %
 Mode: TX 2462
 Note:

No.	Mk.	Freq.	Reading Level	Correct Factor	Measurement	Limit	Over	Antenna Height	Table Degree	Comment
		MHz	dBuV	dB	dBuV/m	dBuV/m	dB	cm	degree	
1	*	30.0000	48.14	-15.15	32.99	40.00	-7.01	QP		
2		62.0100	50.21	-19.98	30.23	40.00	-9.77	QP		
3		73.6500	52.20	-22.57	29.63	40.00	-10.37	QP		
4		143.4900	47.98	-17.29	30.69	43.50	-12.81	QP		
5		296.7500	46.45	-14.54	31.91	46.00	-14.09	QP		
6		745.8600	39.42	-6.00	33.42	46.00	-12.58	QP		

*:Maximum data x:Over limit !:over margin

Operator: Snake

Above 1GHz:

Operation Mode: 802.11b Lowest Test Date : June 08, 2015
 Test Voltage: AC 120V/60Hz Test by: Andy

Freq. (MHz)	Ant. Pol. H/V	Emission Level(dBuV/m)		Limit 3m(dBuV/m)		Over(dB)	
		PK	AV	PK	AV	PK	AV
4824	V	63.25	45.35	74	54	-10.75	-8.65
7236	V	62.1	44.15	74	54	-11.9	-9.85
9648	V	61.74	43.62	74	54	-12.26	-10.38
12060	V	60.28	42.01	74	54	-13.72	-11.99
14472	V	59.34	41.92	74	54	-14.66	-12.08
16884	V	58.04	40.72	74	54	-15.96	-13.28
4824	H	64.72	46.35	74	54	-9.28	-7.65
7236	H	63.2	45.28	74	54	-10.8	-8.72
9648	H	62.08	44.18	74	54	-11.92	-9.82
12060	H	61.85	43.62	74	54	-12.15	-10.38
14472	H	60.48	42.01	74	54	-13.52	-11.99
16884	H	59.72	41.92	74	54	-14.28	-12.08

Operation Mode: 802.11b Middle Test Date : June 08, 2015
 Test Voltage: AC 120V/60Hz Test by: Andy

Freq. (MHz)	Ant. Pol. H/V	Emission Level(dBuV/m)		Limit 3m(dBuV/m)		Over(dB)	
		PK	AV	PK	AV	PK	AV
4824	V	64.35	44.15	74	54	-9.65	-9.85
7236	V	63.15	43.62	74	54	-10.85	-10.38
9648	V	62.04	42.15	74	54	-11.96	-11.85
12060	V	61.72	41.82	74	54	-12.28	-12.18
14472	V	60.25	40.4	74	54	-13.75	-13.6
16884	V	59.72	38.42	74	54	-14.28	-15.58
4824	H	66.33	46.35	74	54	-7.67	-7.65
7236	H	65.15	45.52	74	54	-8.85	-8.48
9648	H	64.72	44.15	74	54	-9.28	-9.85
12060	H	63.35	43.62	74	54	-10.65	-10.38
14472	H	62.18	42.05	74	54	-11.82	-11.95
16884	H	61.04	41.85	74	54	-12.96	-12.15

Operation Mode: 802.11b Highest

Test Date : June 08, 2015

Test Voltage: AC 120V/60Hz

Test by: Andy

Freq. (MHz)	Ant. Pol. H/V	Emission Level(dBuV/m)		Limit 3m(dBuV/m)		Over(dB)	
		PK	AV	PK	AV	PK	AV
4824	V	64.85	45.15	74	54	-9.15	-8.85
7236	V	63.35	44.35	74	54	-10.65	-9.65
9648	V	62.71	43.62	74	54	-11.29	-10.38
12060	V	61.04	42.15	74	54	-12.96	-11.85
14472	V	60.25	41.05	74	54	-13.75	-12.95
16884	V	59.35	40.25	74	54	-14.65	-13.75
4824	H	65.35	46.35	74	54	-8.65	-7.65
7236	H	64.15	45.15	74	54	-9.85	-8.85
9648	H	63.62	44.2	74	54	-10.38	-9.8
12060	H	62.05	43.25	74	54	-11.95	-10.75
14472	H	61.72	42.15	74	54	-12.28	-11.85
16884	H	60.75	41.05	74	54	-13.25	-12.95

Operation Mode: 802.11b Lowest

Test Date : June 08, 2015

Test Voltage: AC 240V/60Hz

Test by: Andy

Freq. (MHz)	Ant. Pol. H/V	Emission Level(dBuV/m)		Limit 3m(dBuV/m)		Over(dB)	
		PK	AV	PK	AV	PK	AV
4824	V	64.13	44.15	74	54	-9.87	-9.85
7236	V	63.92	43.29	74	54	-10.08	-10.71
9648	V	62.05	42.05	74	54	-11.95	-11.95
12060	V	61.48	41.92	74	54	-12.52	-12.08
14472	V	60.59	40.35	74	54	-13.41	-13.65
16884	V	59.48	39.55	74	54	-14.52	-14.45
4824	H	65.14	45.72	74	54	-8.86	-8.28
7236	H	64.72	44.62	74	54	-9.28	-9.38
9648	H	63.15	43.17	74	54	-10.85	-10.83
12060	H	62.92	42.05	74	54	-11.08	-11.95
14472	H	61.74	41.72	74	54	-12.26	-12.28
16884	H	60.85	40.69	74	54	-13.15	-13.31

Operation Mode: 802.11b Middle
 Test Voltage: AC 240V/60Hz

Test Date : June 08, 2015
 Test by: Andy

Freq. (MHz)	Ant. Pol. H/V	Emission Level(dBuV/m)		Limit 3m(dBuV/m)		Over(dB)	
		PK	AV	PK	AV	PK	AV
4824	V	65.33	46.35	74	54	-8.67	-7.65
7236	V	64.05	45.05	74	54	-9.95	-8.95
9648	V	62.18	43.84	74	54	-11.82	-10.16
12060	V	60.48	42.62	74	54	-13.52	-11.38
14472	V	59.35	41.72	74	54	-14.65	-12.28
16884	V	58.47	40.28	74	54	-15.53	-13.72
4824	H	63.05	47.65	74	54	-10.95	-6.35
7236	H	62.71	45.35	74	54	-11.29	-8.65
9648	H	61.8	43.05	74	54	-12.2	-10.95
12060	H	60.28	41.22	74	54	-13.72	-12.78
14472	H	59.48	40.92	74	54	-14.52	-13.08
16884	H	58.36	39.57	74	54	-15.64	-14.43

Operation Mode: 802.11b Highest
 Test Voltage: AC 240V/60Hz

Test Date : June 08, 2015
 Test by: Andy

Freq. (MHz)	Ant. Pol. H/V	Emission Level(dBuV/m)		Limit 3m(dBuV/m)		Over(dB)	
		PK	AV	PK	AV	PK	AV
4824	V	64.25	44.15	74	54	-9.75	-9.85
7236	V	63.62	43.62	74	54	-10.38	-10.38
9648	V	62.15	42.05	74	54	-11.85	-11.95
12060	V	61.72	41.72	74	54	-12.28	-12.28
14472	V	60.33	40.28	74	54	-13.67	-13.72
16884	V	59.72	39.72	74	54	-14.28	-14.28
4824	H	65.38	45.15	74	54	-8.62	-8.85
7236	H	64.17	44.35	74	54	-9.83	-9.65
9648	H	62.59	43.15	74	54	-11.41	-10.85
12060	H	61.72	42.17	74	54	-12.28	-11.83
14472	H	60.35	41.72	74	54	-13.65	-12.28
16884	H	59.72	40.25	74	54	-14.28	-13.75

All emissions not reported were more than 20dB below the specified limit or in the noise floor.

No others harmonics emissions are higher than 20 dB below the limits of 47 CFR Part 15.247.

- Note:**
- (1) All Readings are Peak Value and AV.
 - (2) Emission Level= Reading Level+Probe Factor +Cable Loss.
 - (3) Data of measurement within this frequency range shown “ – ” in the table above means the reading of emissions are attenuated more than 20dB below the permissible limits or the field strength is too small to be measured.

8. 6dB Bandwidth Test

8.1 Measurement Procedure

The EUT was operating in IEEE 802.11b, 802.11g, 802.11n(HT20), 802.11n(HT40) mode or could be controlled its channel. Printed out the test result from the spectrum by hard copy function.

1. Set resolution bandwidth (RBW) = 100 kHz.
2. Set the video bandwidth (VBW) $\geq 3 \times$ RBW.
3. Detector = Peak.
4. Trace mode = max hold.
5. Sweep = auto couple.
6. Allow the trace to stabilize.
7. Measure the maximum width of the emission that is constrained by the frequencies associated with the two outermost amplitude points (upper and lower frequency) that are attenuated by 6 dB relative to the maximum level measured in the fundamental emission.

8.2 Test SET-UP (Block Diagram of Configuration)

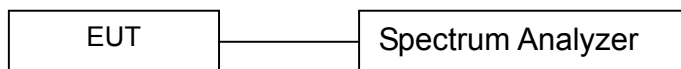

8.3 Measurement Equipment Used

EQUIPMENT TYPE	MFR	MODEL NUMBER	SERIAL NUMBER	LAST CAL.	CAL DUE.
Spectrum Analyzer	Agilent	FSV30	1321.3008K	03/16/2015	03/15/2016

8.4 Measurement Results

6 Bandwidth Test Data Chart:

Refer to attached data chart.

Spectrum Detector: PK	Test Date : June 08, 2015
Test By: Andy	Temperature : 28°C
Test Result: PASS	Humidity : 60%

IEEE 802.11b			
Channel frequency (MHz)	Measurement level (KHz)	Required Limit (KHz)	Result
2412	9111	>500	Pass
2437	9251	>500	
2462	8951	>500	

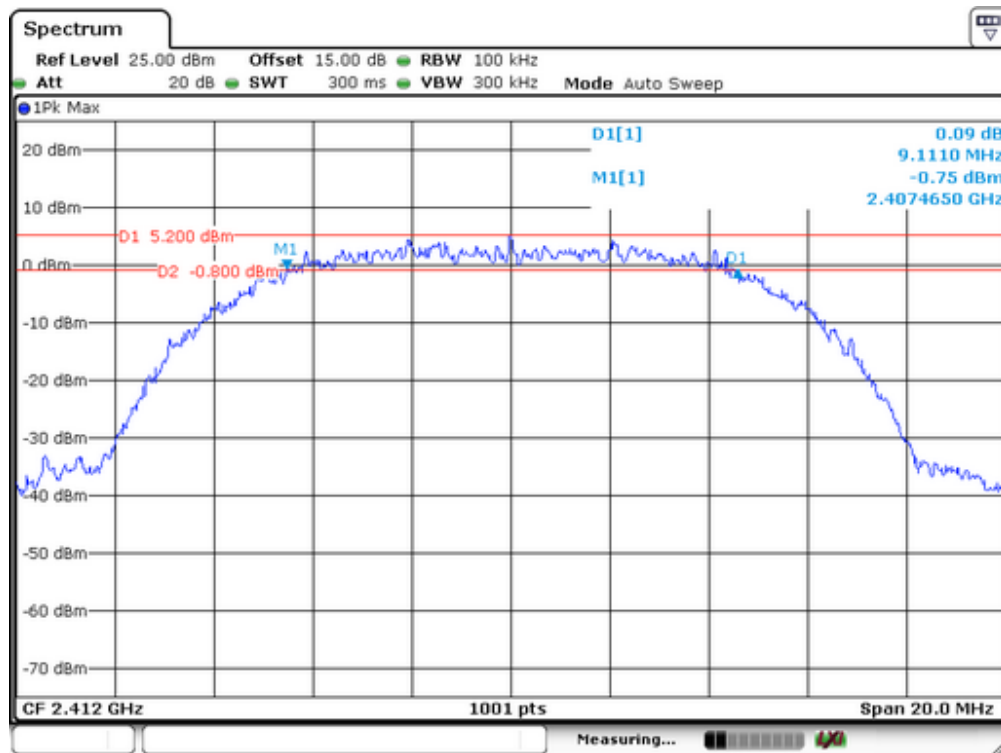

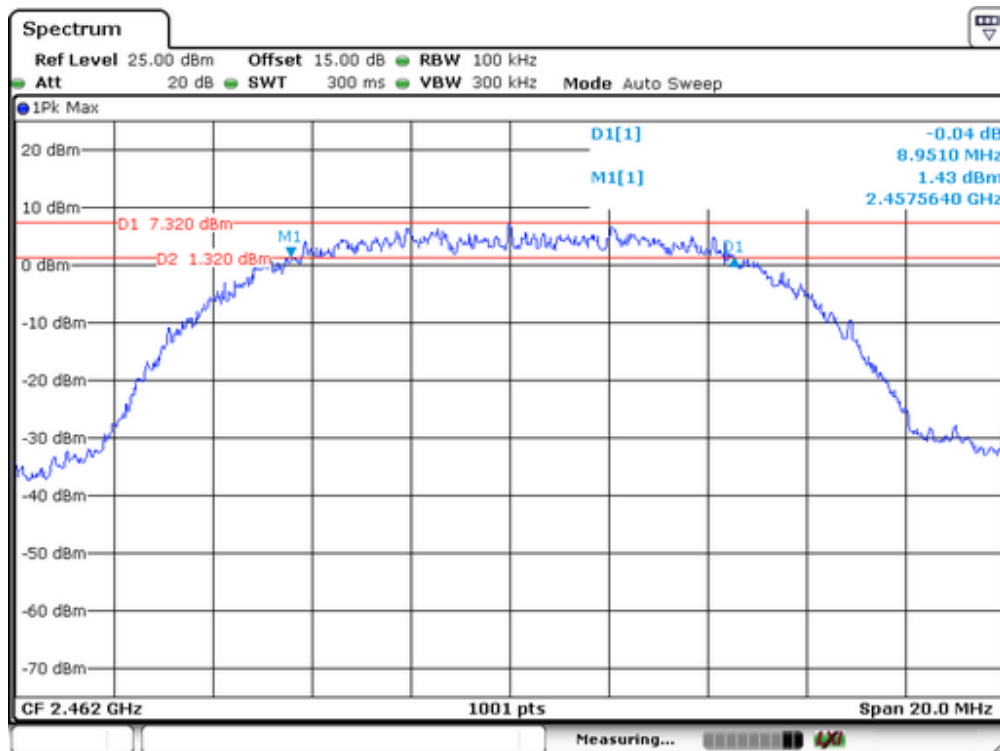
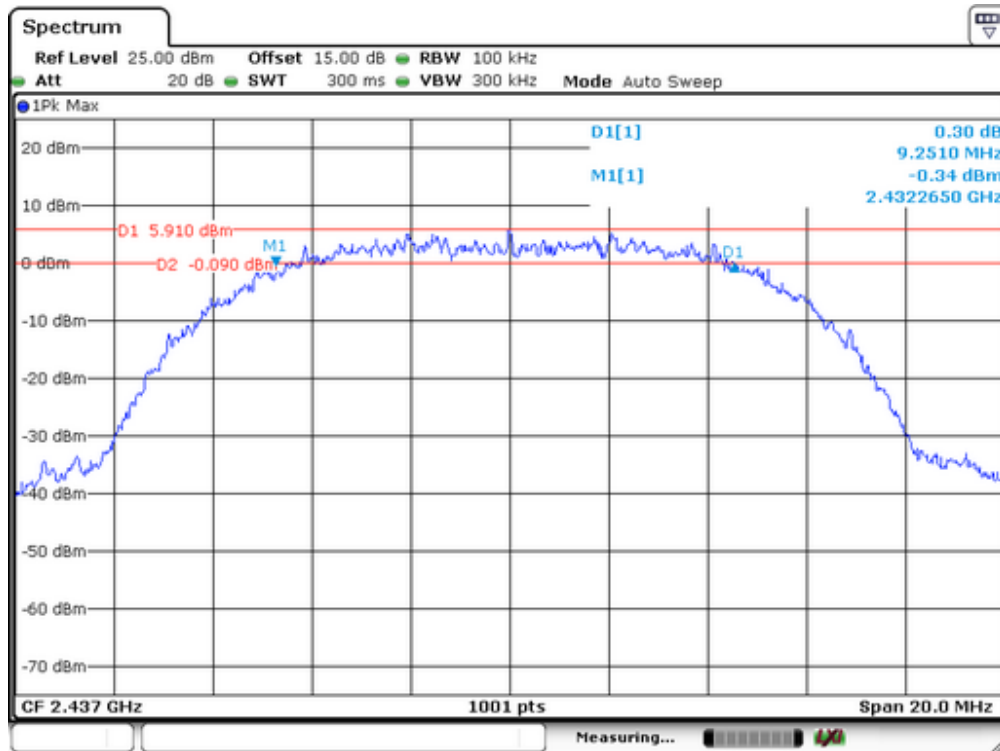

IEEE 802.11g			
Channel frequency (MHz)	Measurement level (KHz)	Required Limit (KHz)	Result
2412	16503	>500	Pass
2437	16484	>500	
2462	16484	>500	

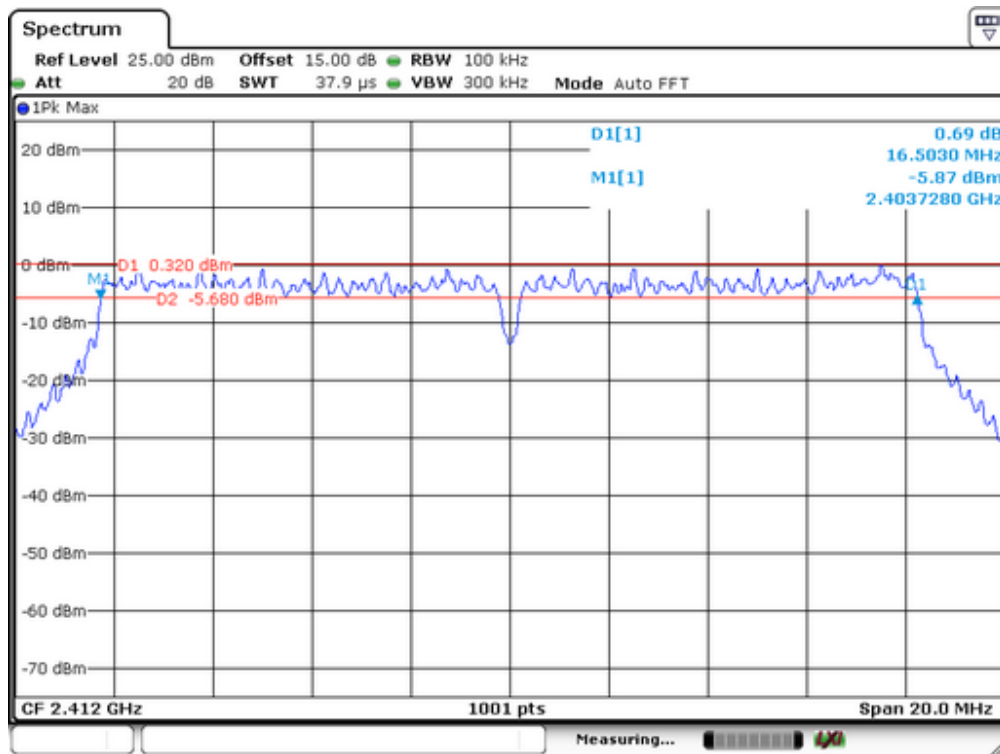

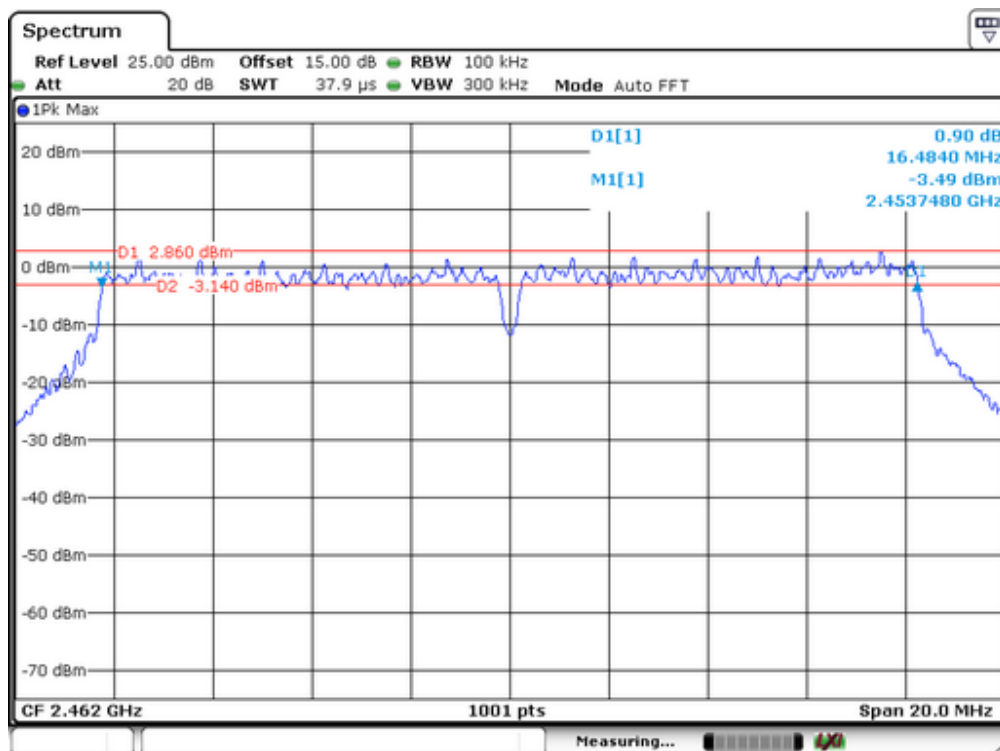
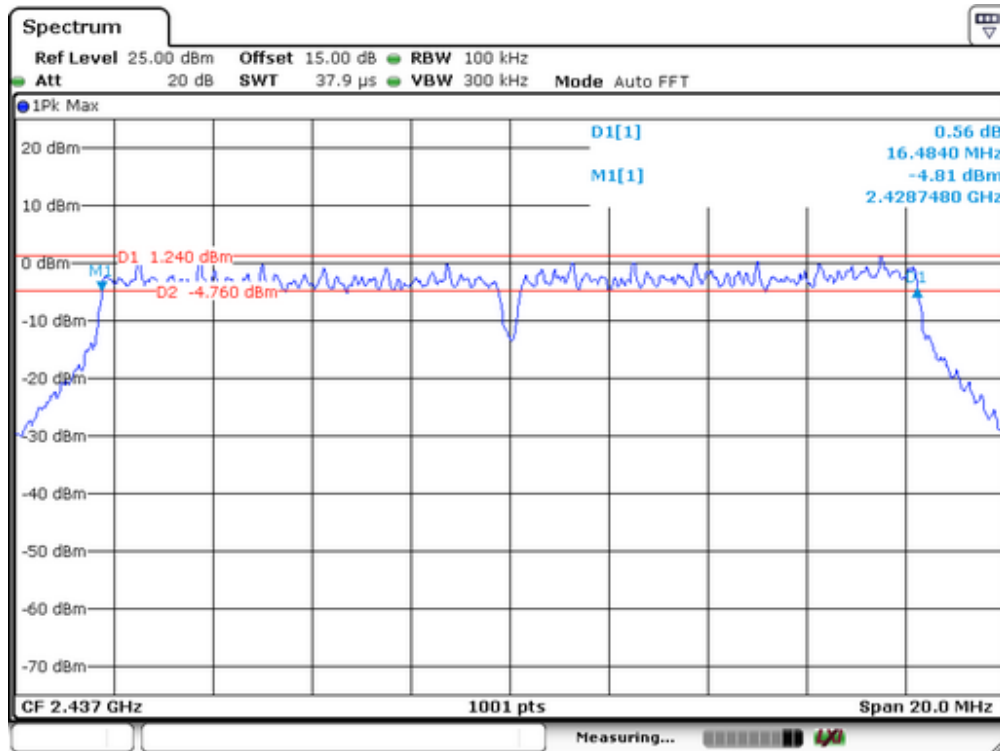

IEEE 802.11n(HT20)			
Channel frequency (MHz)	Measurement level (KHz)	Required Limit (KHz)	Result
2412	17642	>500	Pass
2437	17622	>500	
2462	17602	>500	

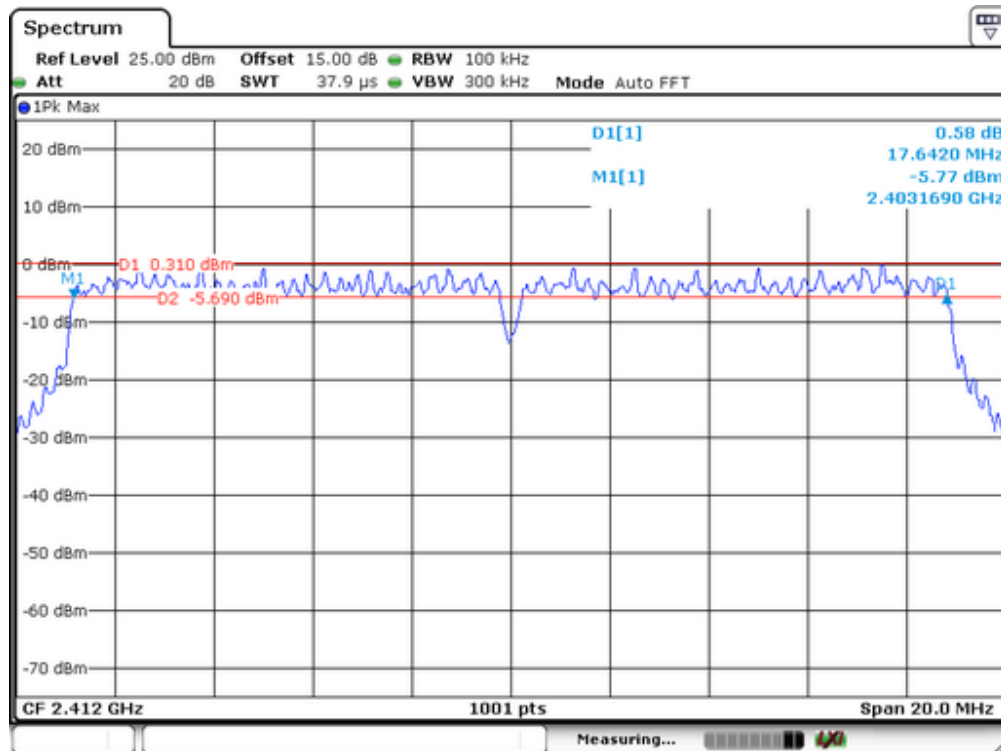

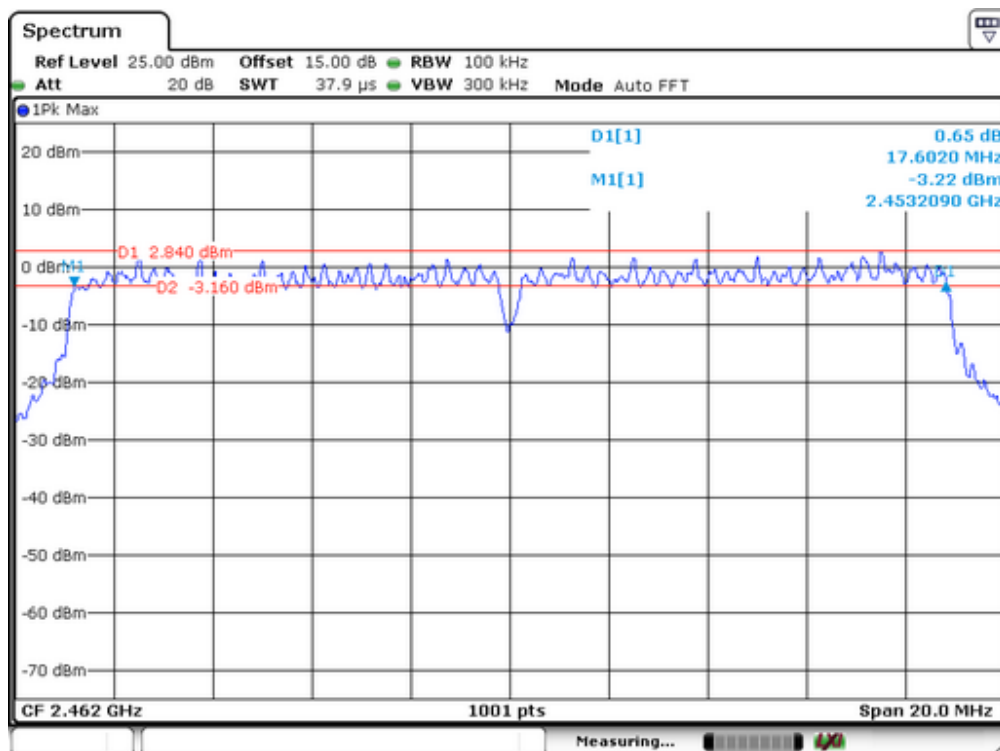
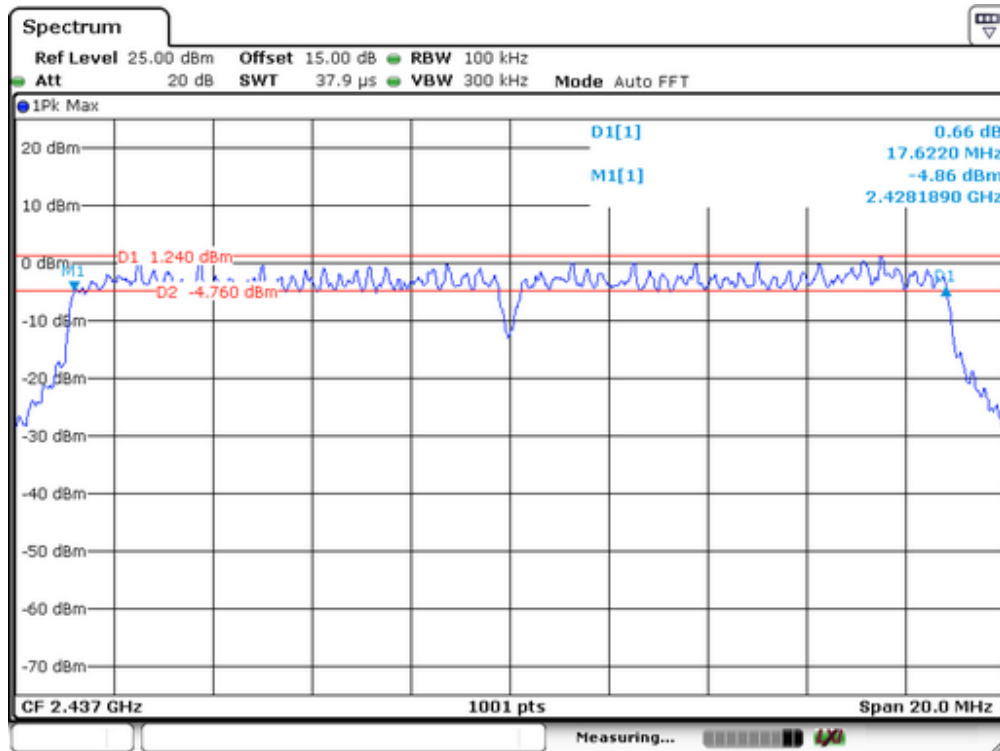

IEEE 802.11n(HT40)			
Channel frequency (MHz)	Measurement level (KHz)	Required Limit (KHz)	Result
2422	36284	>500	Pass
2437	35884	>500	
2452	35764	>500	

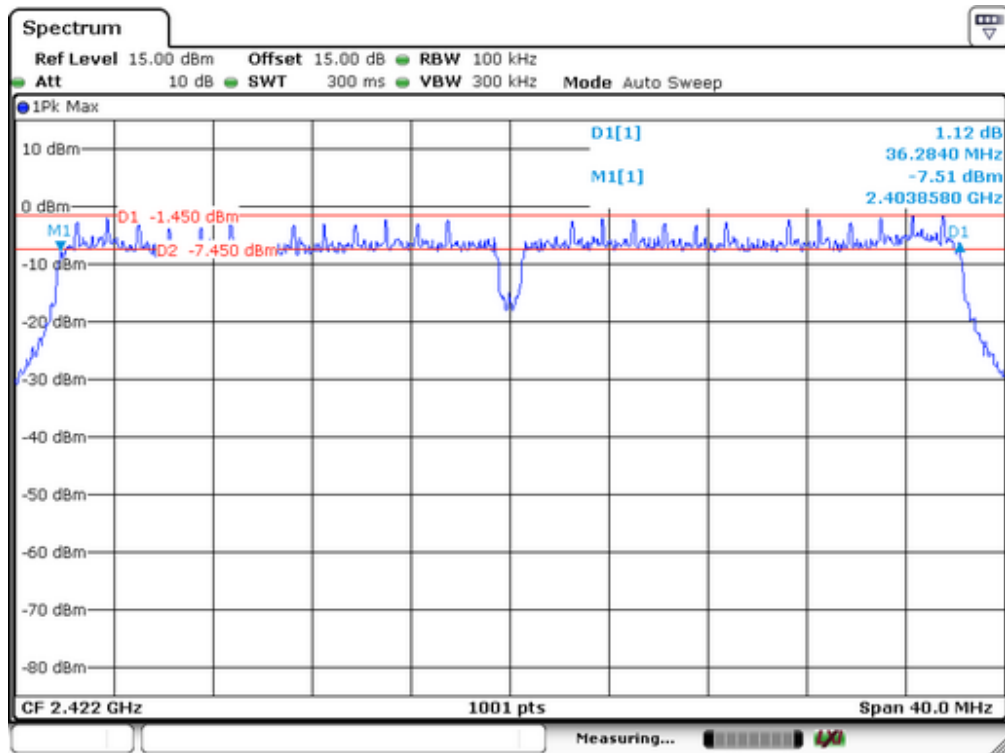

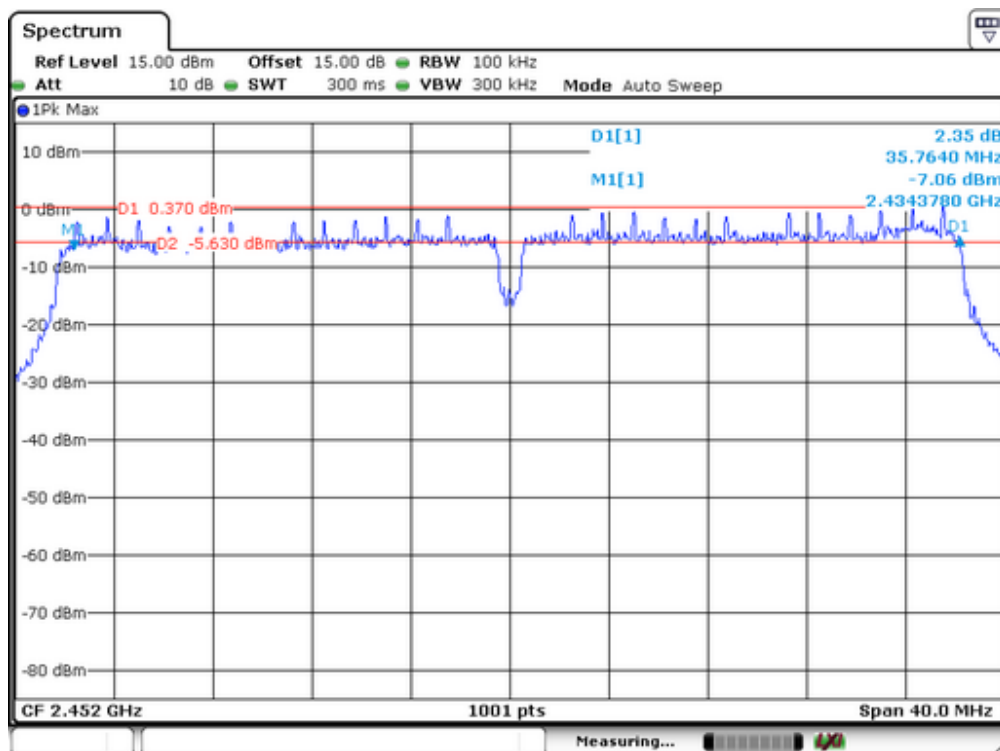
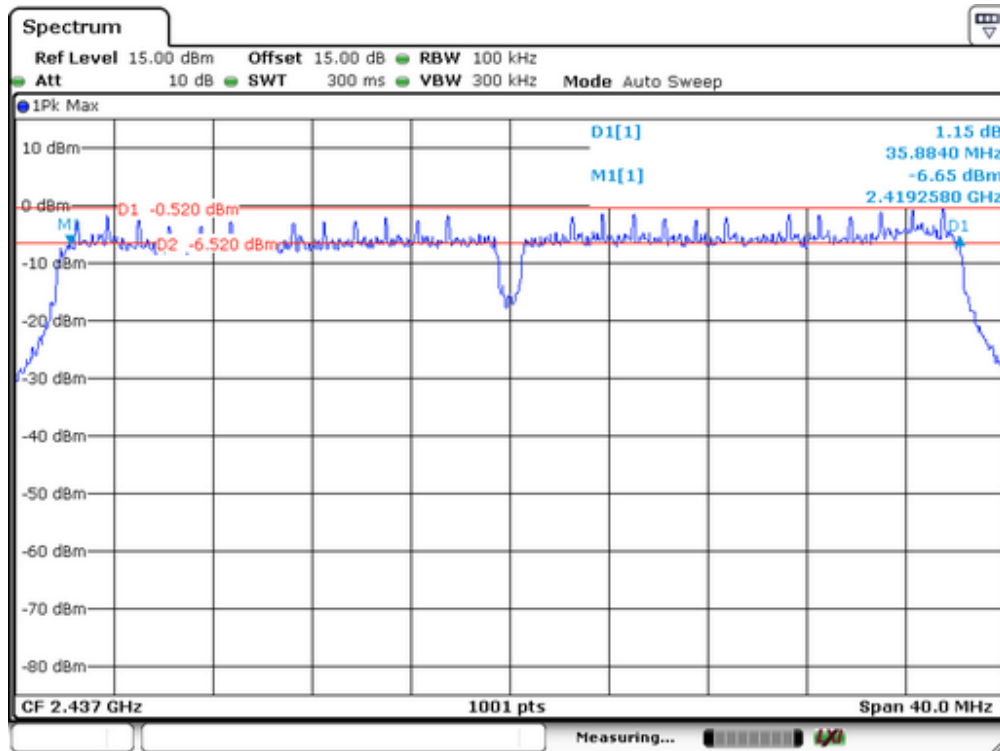

9. Maximum Peak Output Power Test

9.1 Measurement Procedure

1. The testing follows the Measurement Procedure of FCC KDB No. 558074 DTS D01 Meas. Guidance v03r02.
2. The RF output of EUT was connected to the power meter by RF cable and attenuator. The path loss was compensated to the results for each measurement.
3. Set to the maximum power setting and enable the EUT transmit continuously.
4. Measure the conducted output power and record the results in the test report.

9.2 Test SET-UP (Block Diagram of Configuration)



9.3 Measurement Equipment Used

EQUIPMENT TYPE	MODEL NUMBER	SERIAL NUMBER	LAST CAL.	CAL DUE.
Power meter	ML2495A	0824006	03/16/2015	03/15/2016
Power sensor	MA2411B	0738172	03/16/2015	03/15/2016

9.4 Peak Power output limit

The maximum peak power shall be less 1Watt.

9.5 Measurement Results

Spectrum Detector:	PK	Test Date :	June 08, 2015
Test By:	Andy	Temperature :	28°C
Test Result:	PASS	Humidity :	60%

Test Channel	Average Output Power (dBm)				Limit(dBm)	Result
	802.11b	802.11g	802.11n(HT20)	802.11n(HT40)		
Lowest	13.52	12.48	11.74	9.42	30	Pass
Middle	14.05	13.04	12.62	10.07		
Highest	15.62	14.46	13.92	11.04		

10. Band Edge Test

10.1 Measurement Procedure

For Conducted Test

1. The testing follows FCC KDB Publication No. 558074 D01 DTS Meas. Guidance v03r02.
2. The RF output of EUT was connected to the spectrum analyzer by RF cable and attenuator. The path loss was compensated to the results for each measurement.
3. Set to the maximum power setting and enable the EUT transmit continuously.
4. Set RBW = 100 kHz, VBW=300 kHz, Peak Detector. Unwanted Emissions measured in any 100 kHz bandwidth outside of the authorized frequency band shall be attenuated by at least 20 dB relative to the maximum in-band peak PSD level in 100 kHz when maximum peak conducted output power procedure is used. Measure and record the results in the test report.
5. The RF fundamental frequency should be excluded against the limit line in the operating frequency band.

For Radiated emission Test

1. The testing follows FCC KDB Publication No. 558074 D01 DTS Meas. Guidance v03r02.
2. The EUT was arranged to its worst case and then tune the antenna tower (from 1 m to 4 m) and turntable (from 0 degree to 360 degrees) to find the maximum reading. A pre-amp and a high pass filter are used for the test in order to get better signal level.
3. The EUT was placed on a turntable with 0.8 meter above ground.
4. The EUT was set 3 meters from the interference receiving antenna, which was mounted on the top of a variable height antenna tower.
5. Corrected Reading: Antenna Factor + Cable Loss + Read Level - Preamp Factor = Level.
6. For measurement below 1GHz, If the emission level of the EUT measured by the peak detector is 3 dB lower than the applicable limit, the peak emission level will be reported. Otherwise, the emission measurement will be repeated using the quasi-peak detector and reported.
7. Repeat above procedures until all frequency measured were complete.

When spectrum scanned above 1GHz setting resolution bandwidth 1MHz, video bandwidth 3MHz.

EMI Test Receiver	Setting
Attenuation	Auto
RB	1MHz
VB	3MHz
Detector	Peak
Trace	Max hold

When spectrum scanned above 1GHz setting resolution bandwidth 1MHz, video bandwidth 10Hz.

EMI Test Receiver	Setting
Attenuation	Auto
RB	1MHz
VB	10Hz
Detector	AVG
Trace	Max hold

10.2 Test SET-UP (Block Diagram of Configuration)

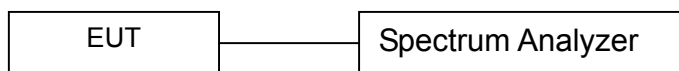

10.3 Measurement Equipment Used

EQUIPMENT TYPE	MFR	MODEL NUMBER	SERIAL NUMBER	LAST CAL.	CAL DUE.
Spectrum Analyzer	Agilent	FSV30	1321.3008K	03/16/2015	03/15/2016

10.4 Measurement Results

1. Conducted Test

Please refer to the following pages.

Test mode: 802.11b

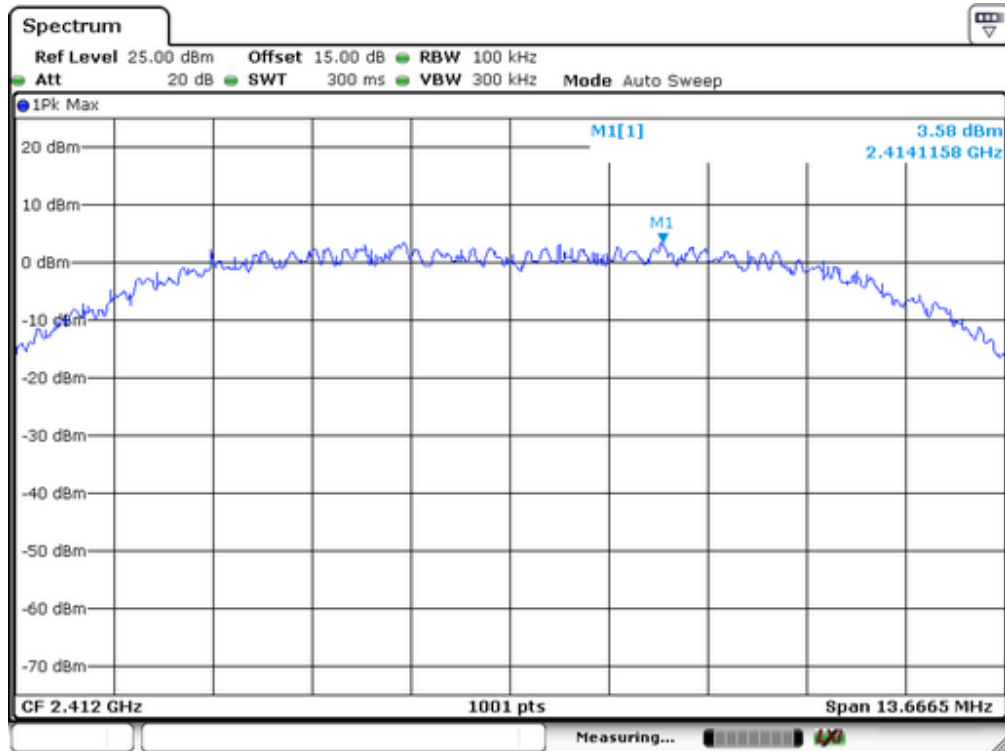

Lowest Channel

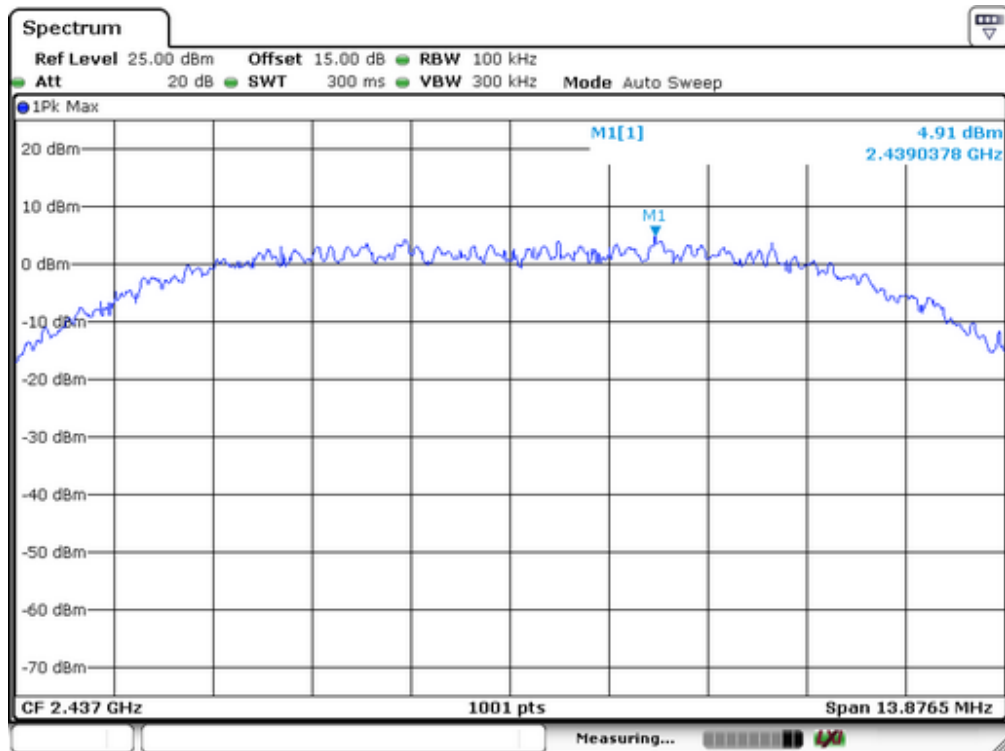

Middle Channel

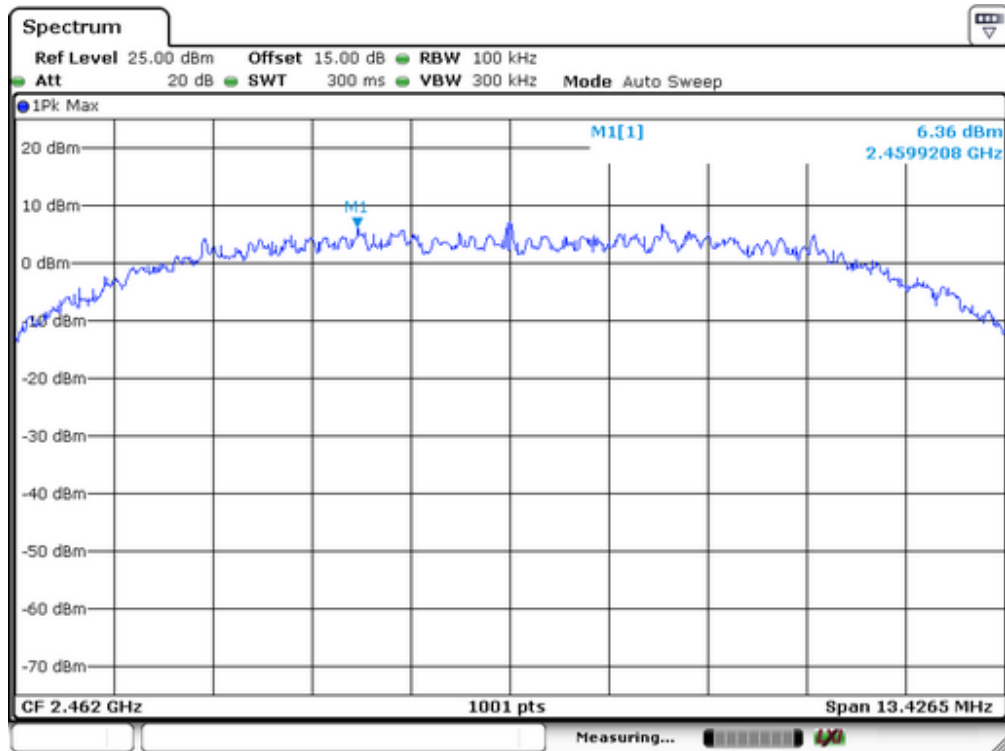

Highest Channel

Test mode: 802.11g

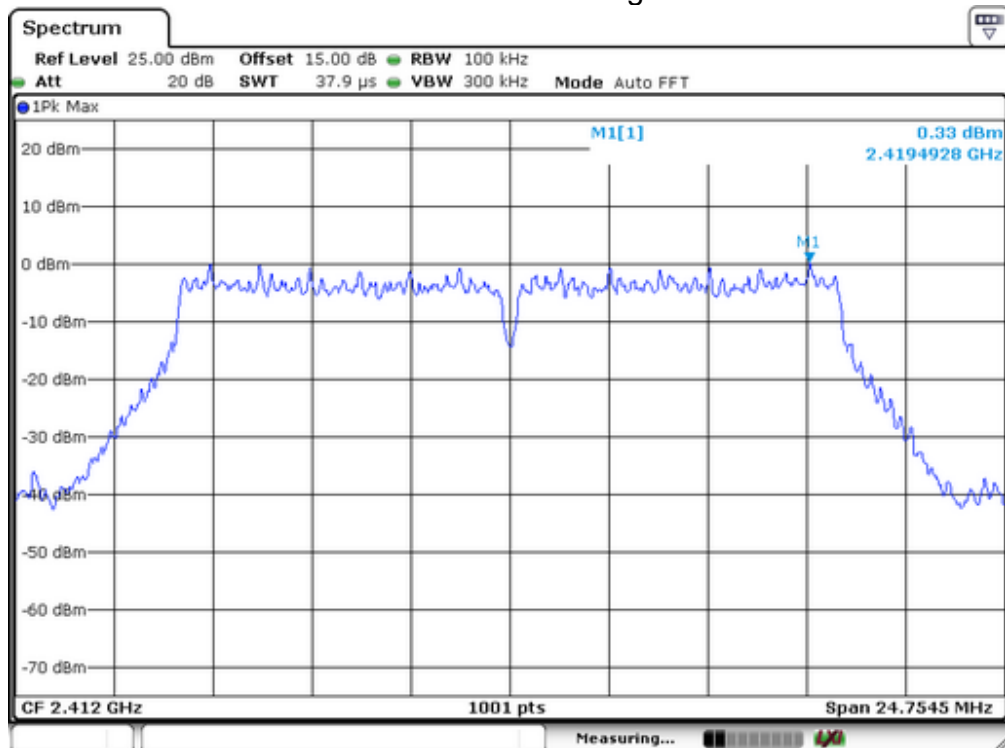

Lowest Channel

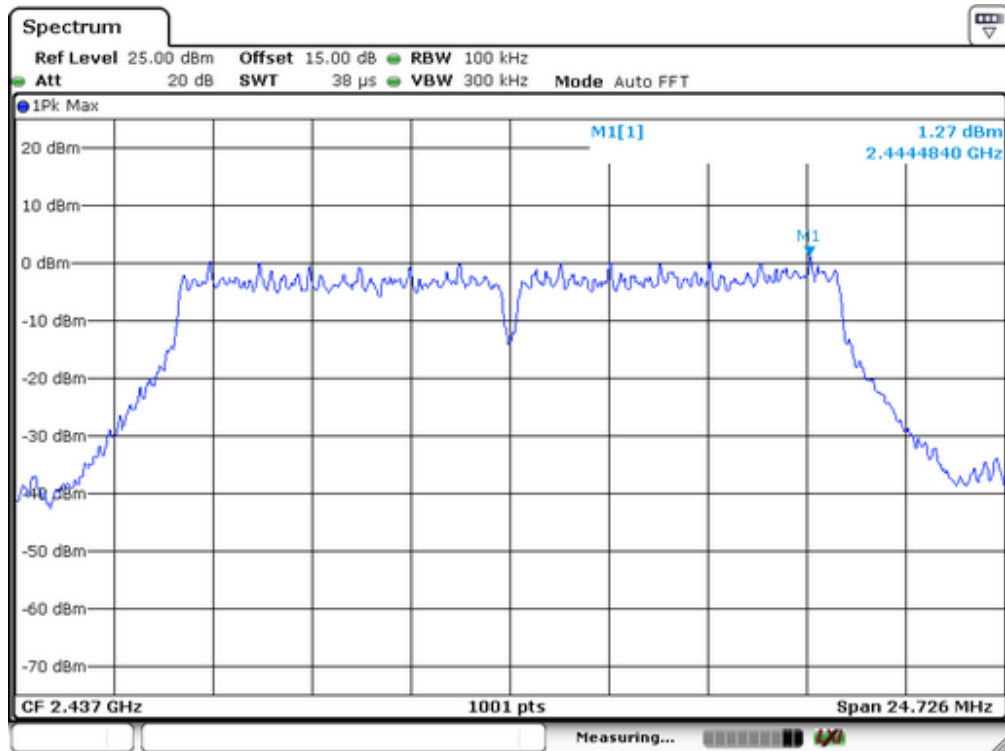

Middle Channel

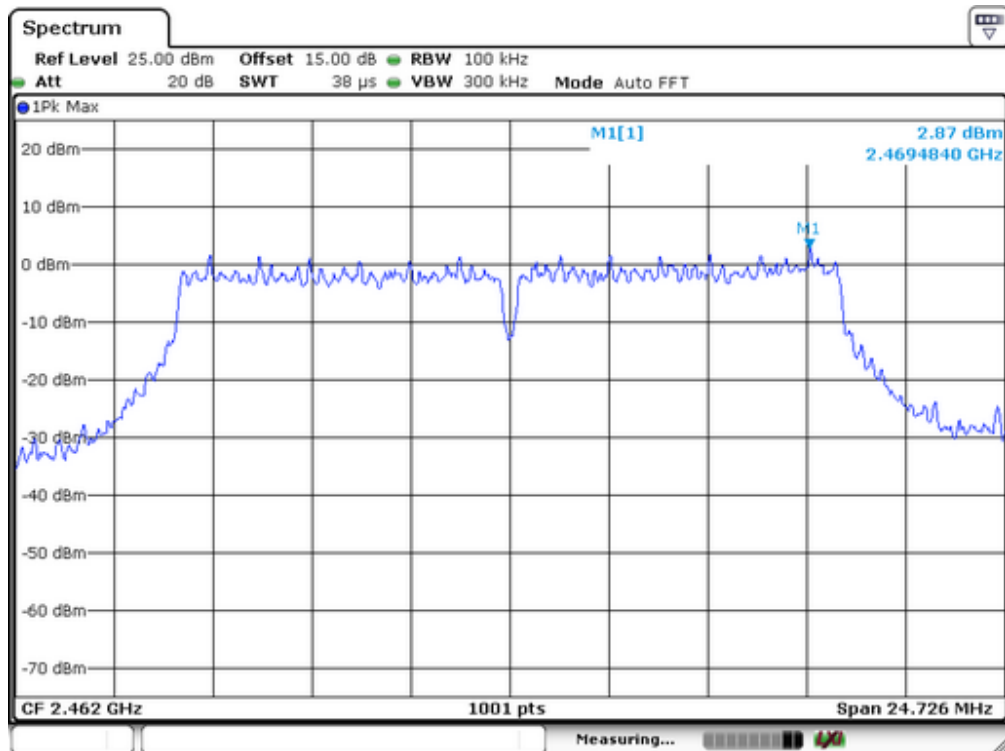

Highest Channel

Test mode: 802.11n(HT20)

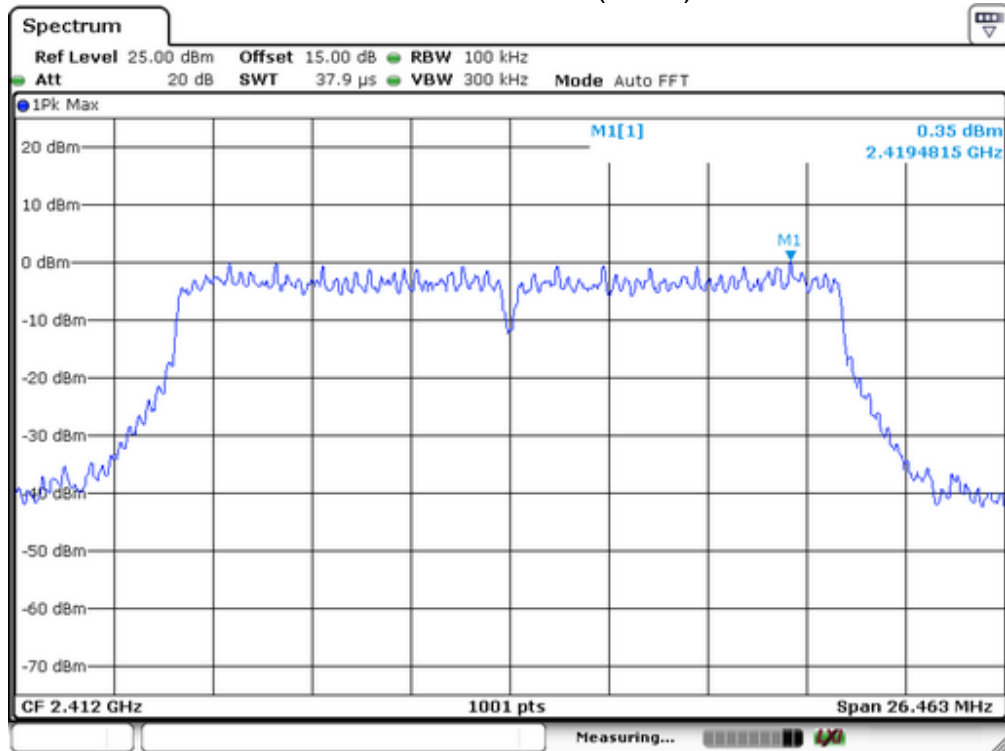

Lowest Channel

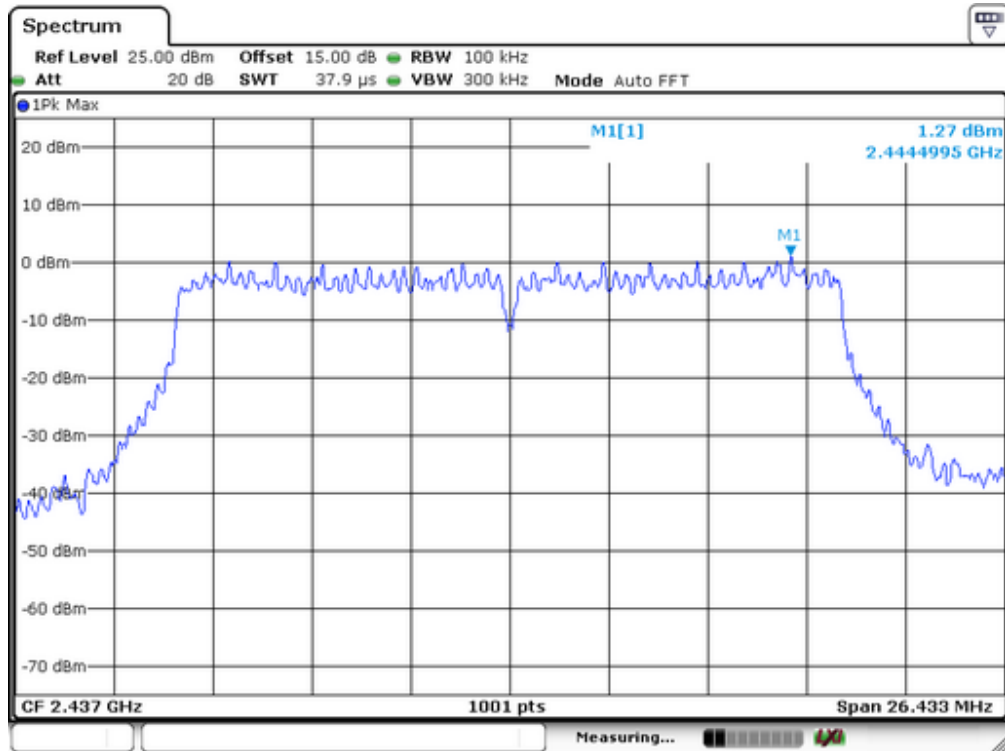

Middle Channel

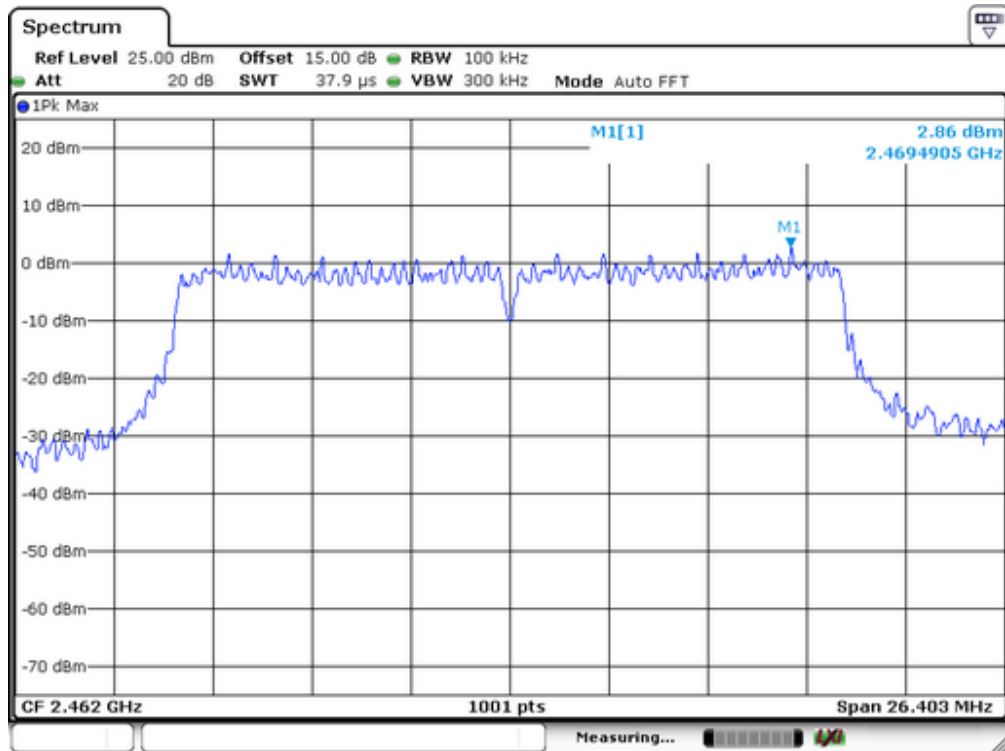

Highest Channel

Test mode: 802.11n(HT40)

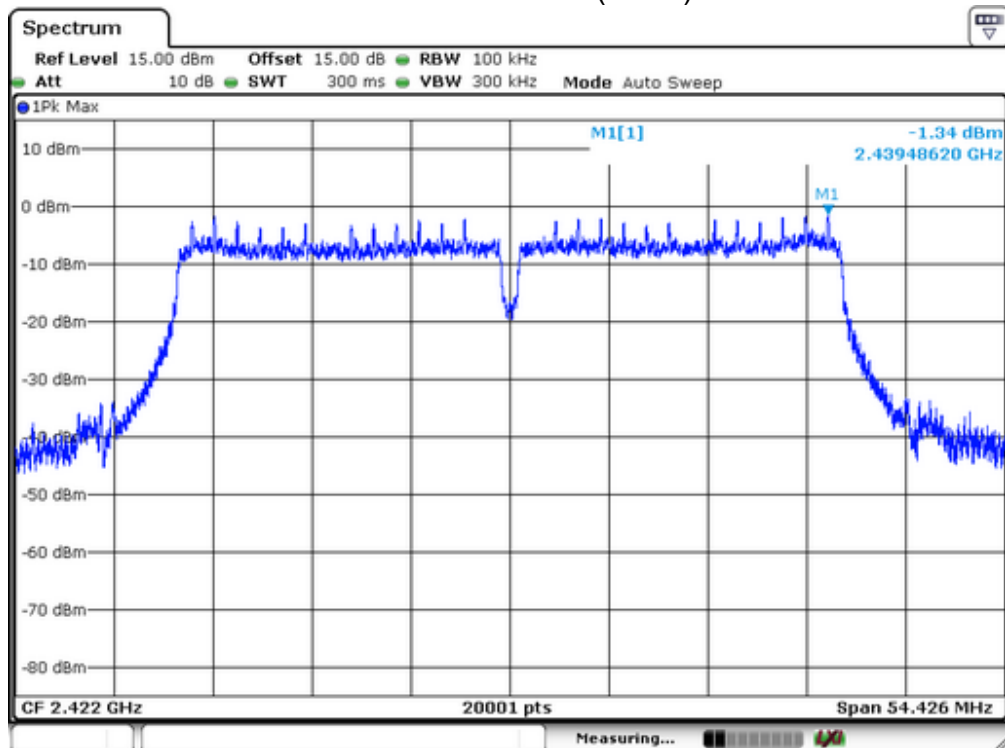

Lowest Channel

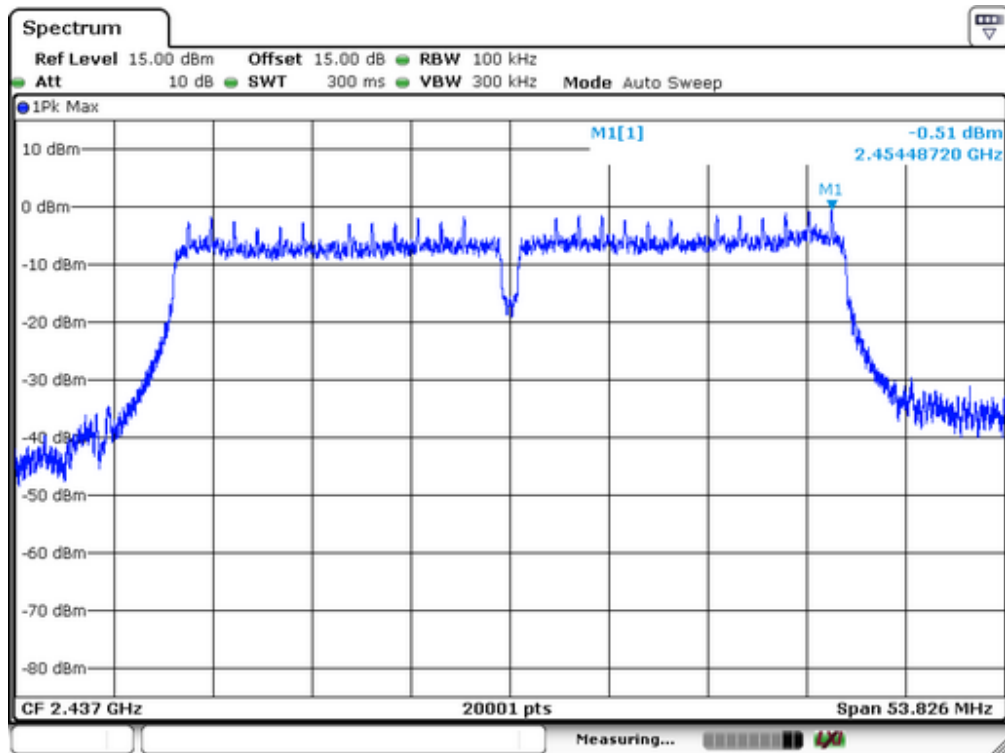

Middle Channel

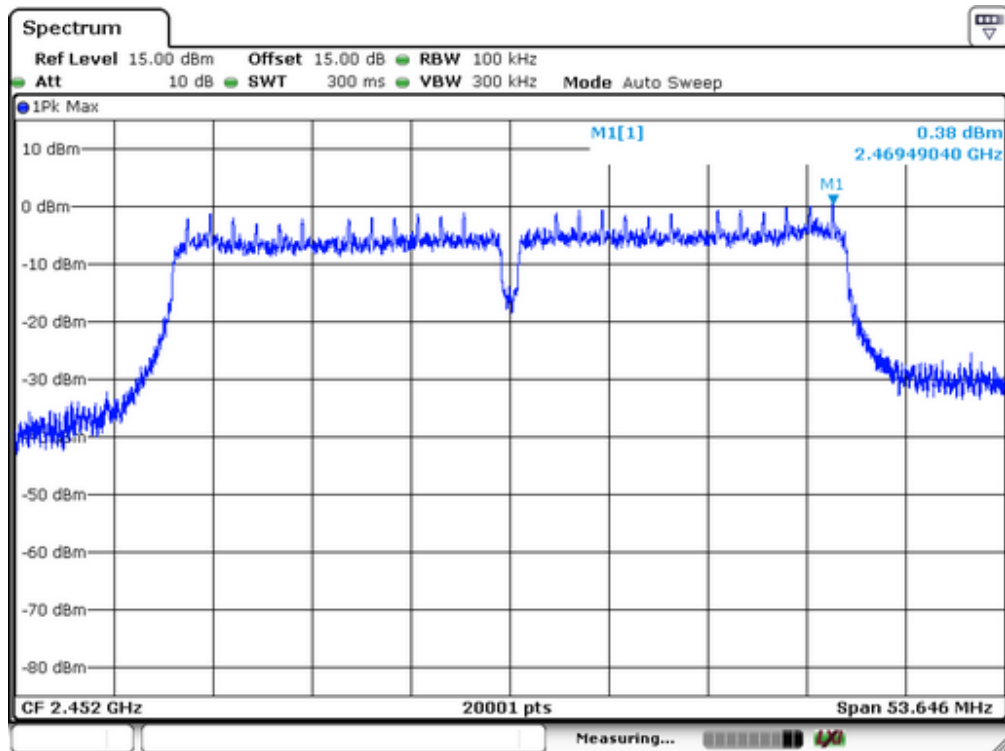

Highest Channel

Test mode: 802.11b

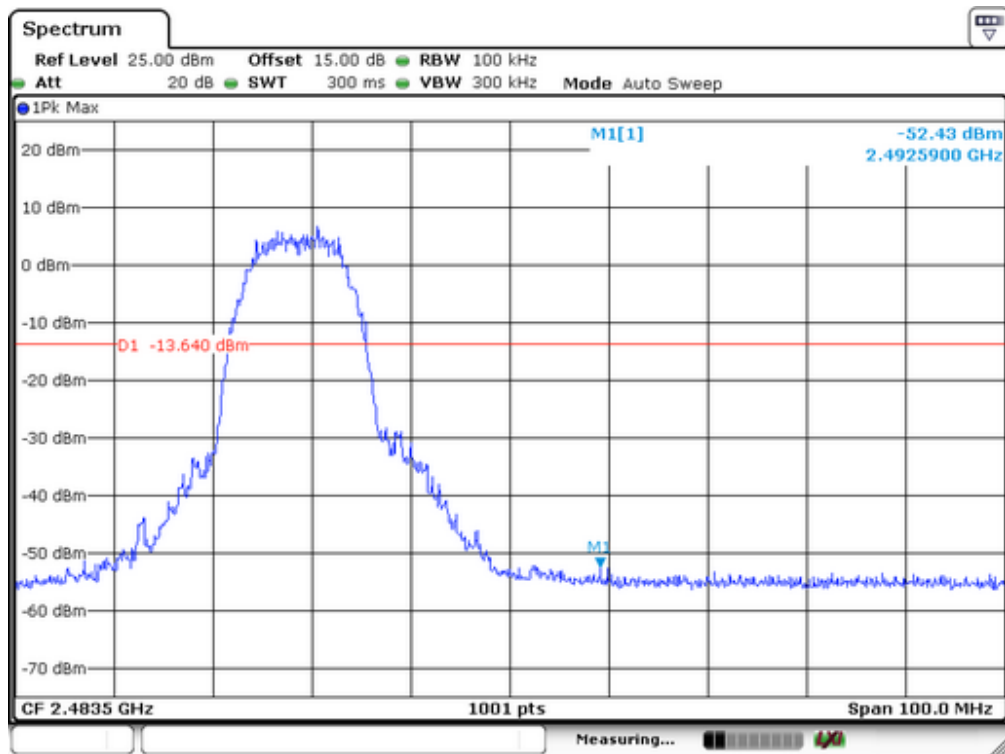
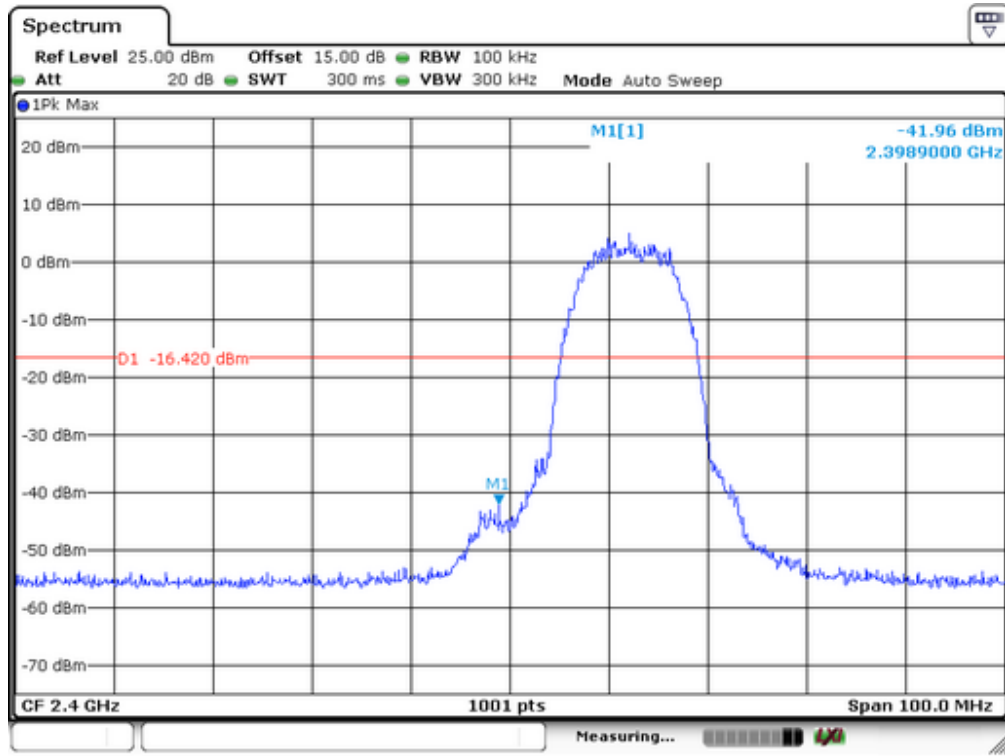

Test mode: 802.11g

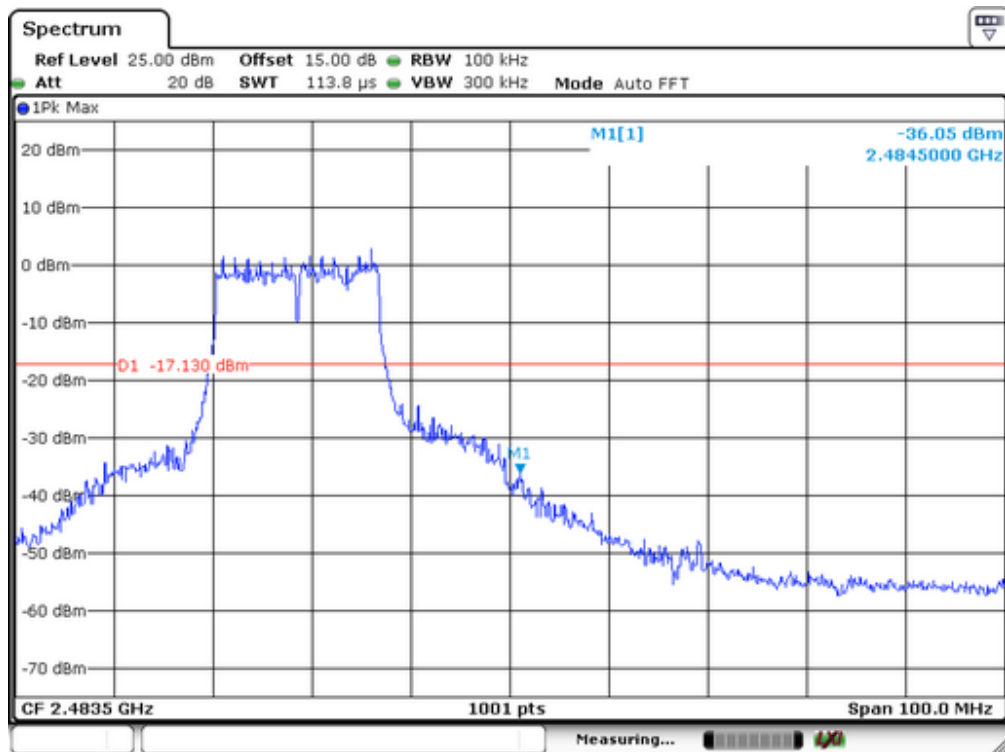
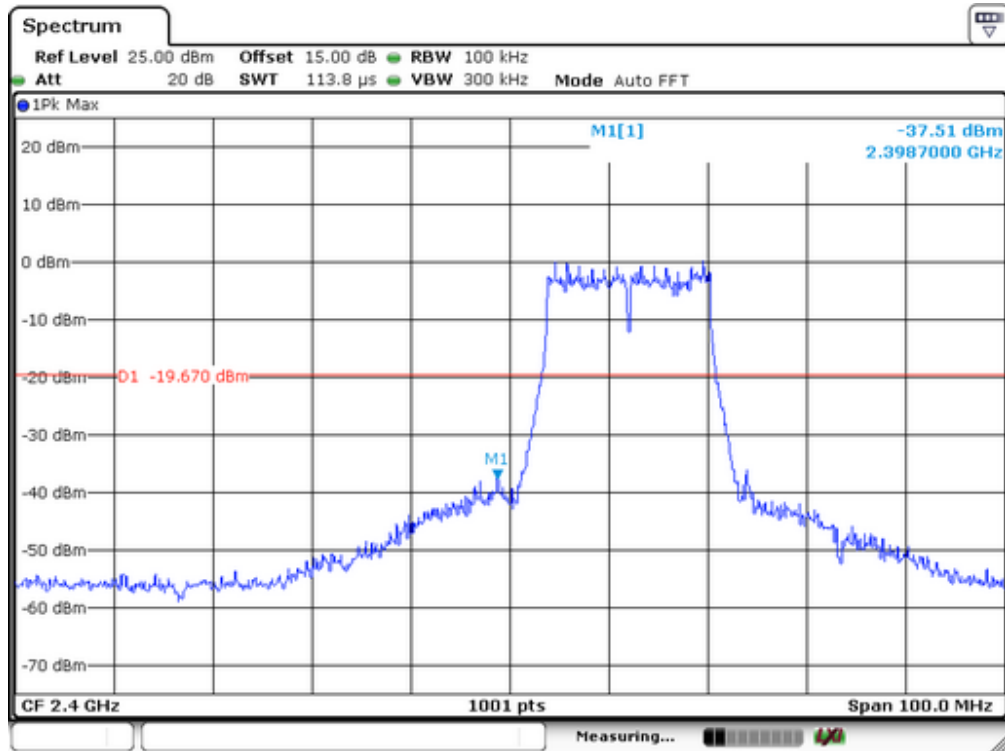

Test mode: 802.11n(HT20)

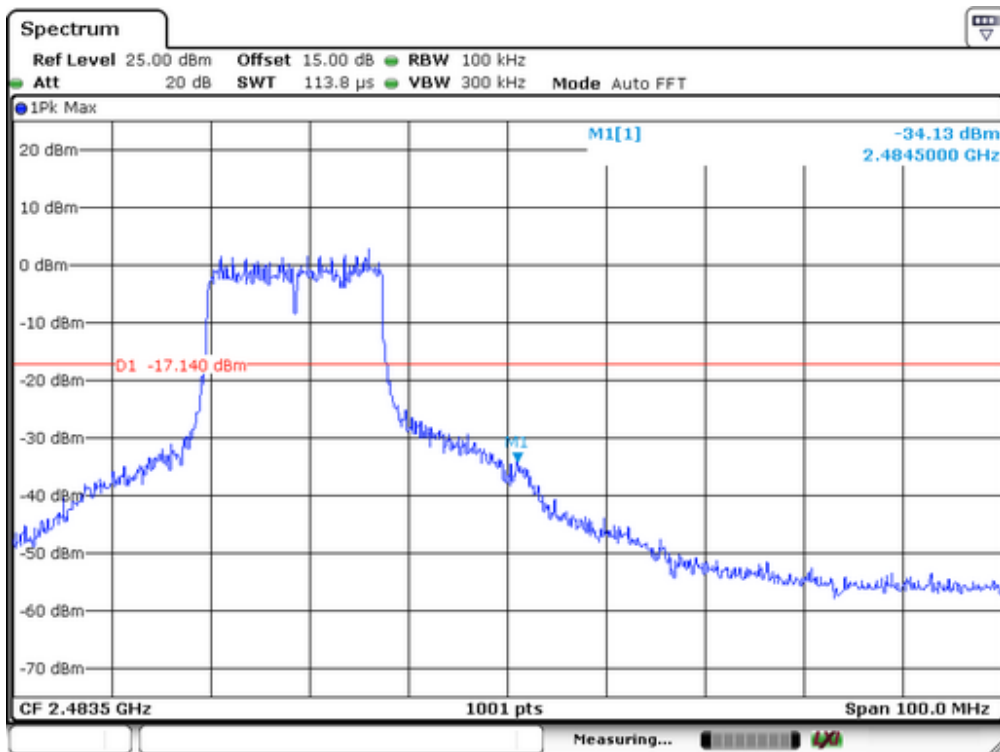
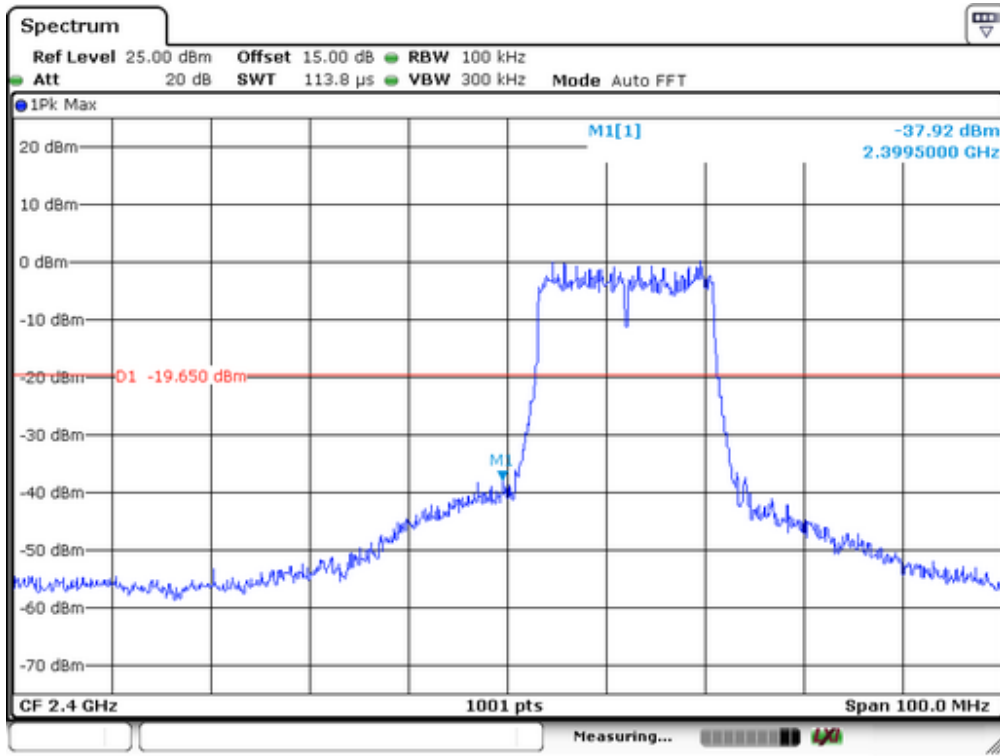

Test mode: 802.11n(HT40)

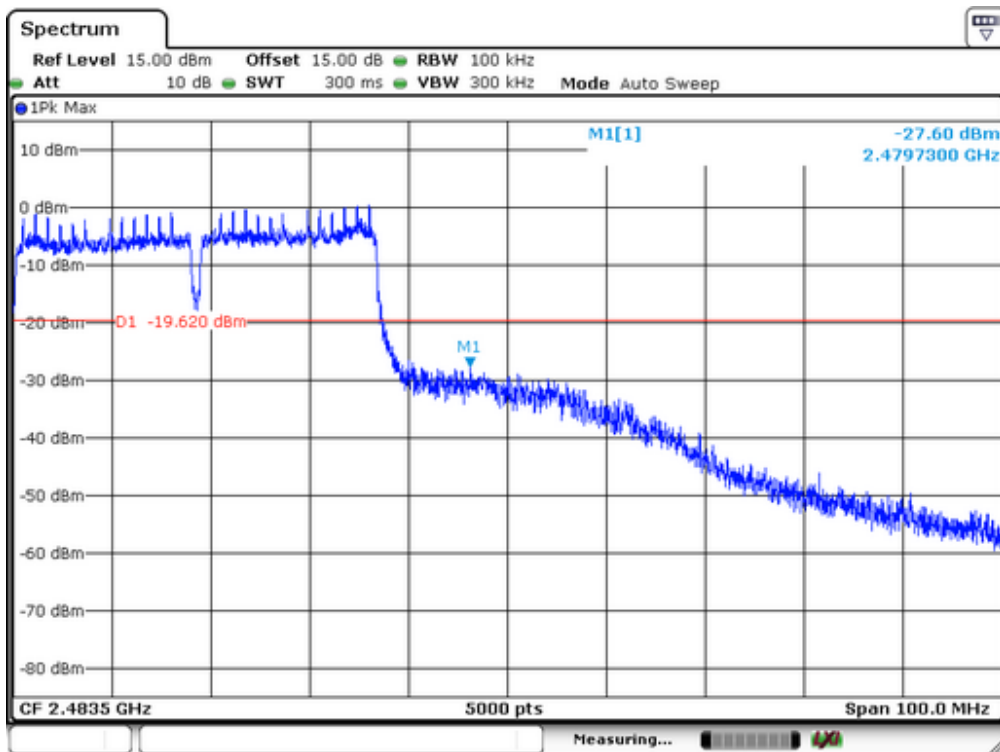
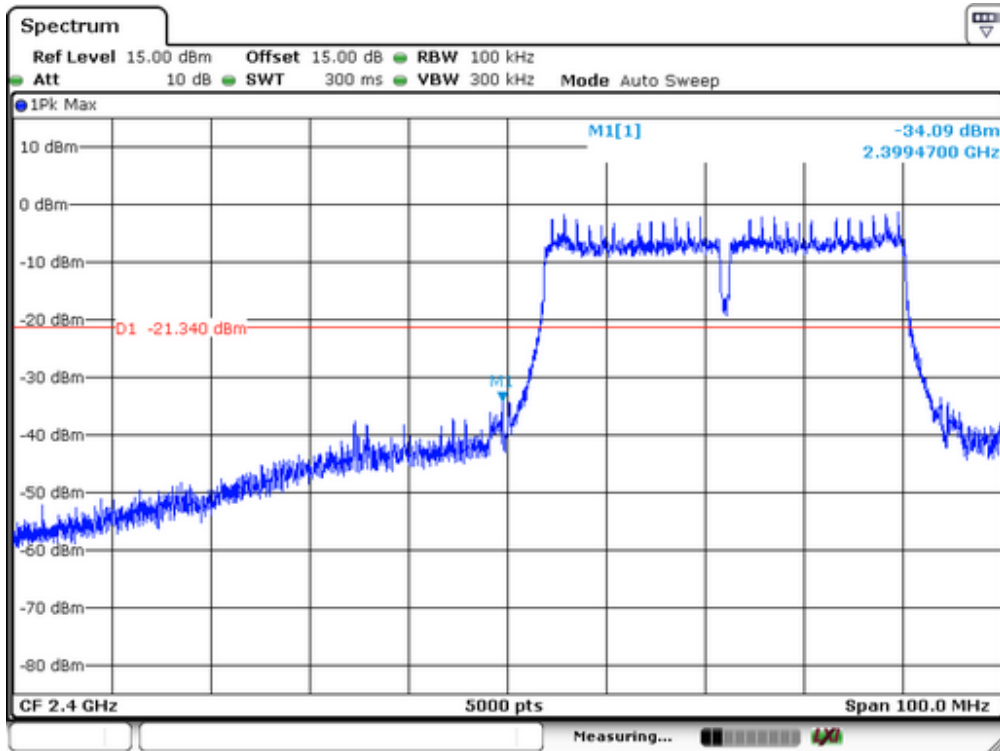

2. Radiated emission Test

Spectrum Detector: PK/AV Test Date : June 08, 2015
 Test By: Andy Temperature : 28 °C
 Humidity : 65 %

IEEE 802.11b							
Frequency (MHz)	Antenna polarization	Emission (dBuV/m)		Band edge Limit (dBuV/m)		Margin (dB)	
	(H/V)	PK	AV	PK	AV	PK	AV
<2400	H	64.15	45.38	74	54	-9.85	-8.62
<2400	V	60.2	39.15	74	54	-13.8	-14.85
>2483.5	H	64.82	46.38	74	54	-9.18	-7.62
>2483.5	V	59.7	39.18	74	54	-14.3	-14.82

IEEE 802.11g							
Frequency (MHz)	Antenna polarization	Emission (dBuV/m)		Band edge Limit (dBuV/m)		Margin (dB)	
	(H/V)	PK	AV	PK	AV	PK	AV
<2400	H	65.15	45.15	74	54	-8.85	-8.85
<2400	V	60.84	40.82	74	54	-13.16	-13.18
>2483.5	H	64.71	46.35	74	54	-9.29	-7.65
>2483.5	V	61.3	39.75	74	54	-12.7	-14.25

IEEE 802.11n(HT20)							
Frequency (MHz)	Antenna polarization	Emission (dBuV/m)		Band edge Limit (dBuV/m)		Margin (dB)	
	(H/V)	PK	AV	PK	AV	PK	AV
<2400	H	65.18	45.36	74	54	-8.82	-8.64
<2400	V	60.35	40.28	74	54	-13.65	-13.72
>2483.5	H	64.72	46.15	74	54	-9.28	-7.85
>2483.5	V	60.1	40.85	74	54	-13.9	-13.15

IEEE 802.11n(HT40)							
Frequency (MHz)	Antenna polarization	Emission (dBuV/m)		Band edge Limit (dBuV/m)		Margin (dB)	
	(H/V)	PK	AV	PK	AV	PK	AV
<2400	H	63.15	46.35	74	54	-10.85	-7.65
<2400	V	56.35	40.18	74	54	-17.65	-13.82
>2483.5	H	64.17	45.2	74	54	-9.83	-8.8
>2483.5	V	60.85	39.57	74	54	-13.15	-14.43

11. Power Density

11.1 Test Equipment

EQUIPMENT TYPE	MFR	MODEL NUMBER	SERIAL NUMBER	LAST CAL.	CAL DUE.
Spectrum Analyzer	Agilent	FSV30	1321.3008K	03/16/2015	03/15/2016

11.2 Measuring Instruments and Setting

The following table is the setting of spectrum analyzer.

Spectrum analyzer	Setting
Attenuation	Auto
Span Frequency	Set the span to 1.5 times the DTS bandwidth.
RB	3kHz
VB	10KHz
Detector	Peak
Trace	Max hold
Sweep Time	Automatic

11.3 Test Procedures

- The transmitter output (antenna port) was connected to the spectrum analyzer.
- Set analyzer center frequency to DTS channel center frequency.
- Set the analyzer span to a minimum of 1.5 times the DTS bandwidth.
- Set the RBW \geq 3 kHz. Set the VBW \geq 3 x RBW.
- Detector = peak.
- Sweep time = auto couple.
- Trace mode = max hold.
- Allow trace to fully stabilize.
- Use the peak marker function to determine the maximum amplitude level.

11.4 Block Diagram of Test Setup

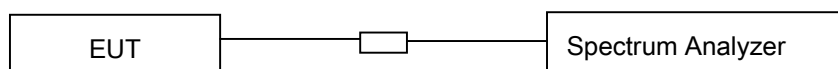

11.5 Limit

The transmitted power density averaged over any 1 second interval shall not be greater +8dBm in any 3 kHz bandwidth.

11.6 Test Result

Spectrum Detector:	PK	Test Date :	June 08, 2015
Test By:	Andy	Temperature :	28°C
Test Result:	PASS	Humidity :	60%

IEEE 802.11b			
Channel frequency (MHz)	Measurement level (dBm)	Limit(dBm)	Result
2412	-9.86	8	Pass
2437	-9.03		
2462	-7.55		

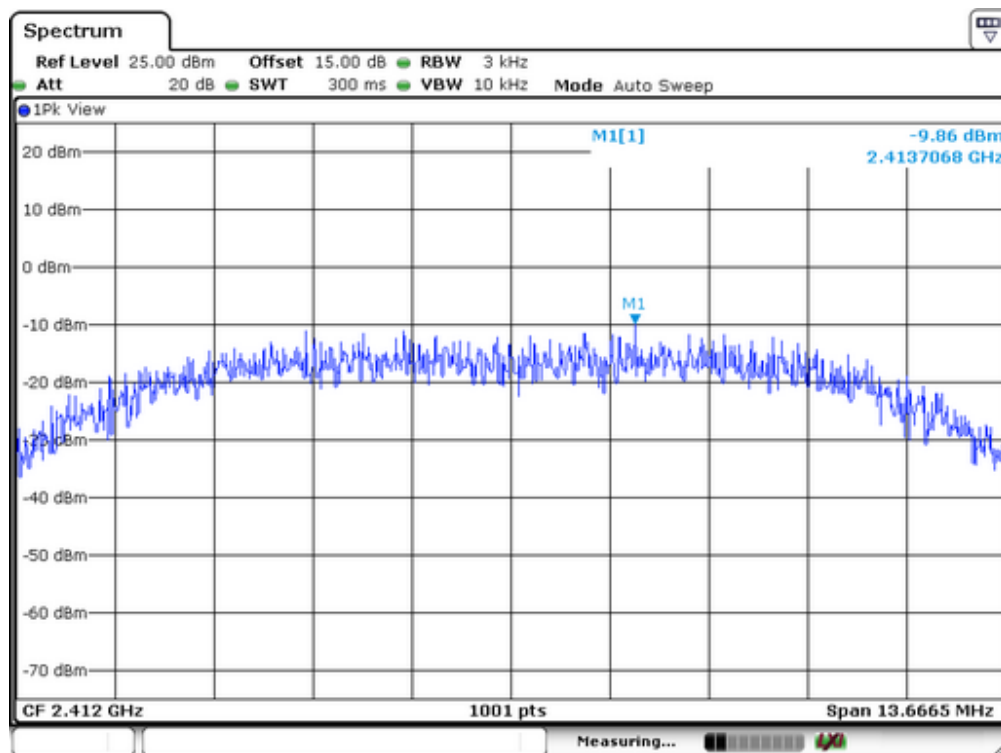

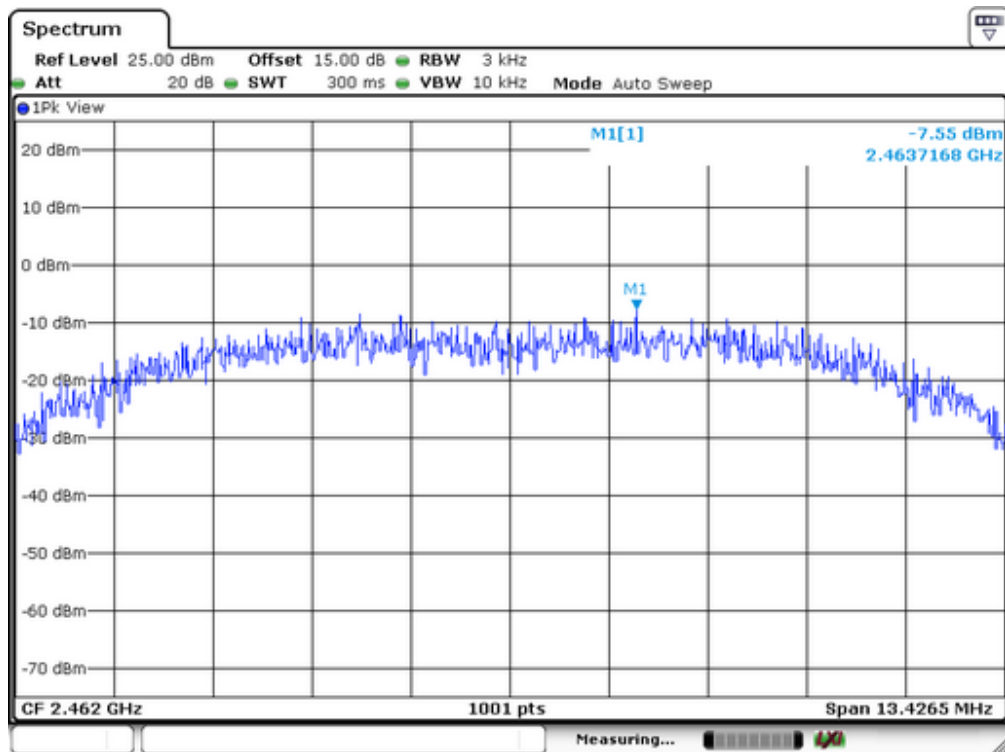
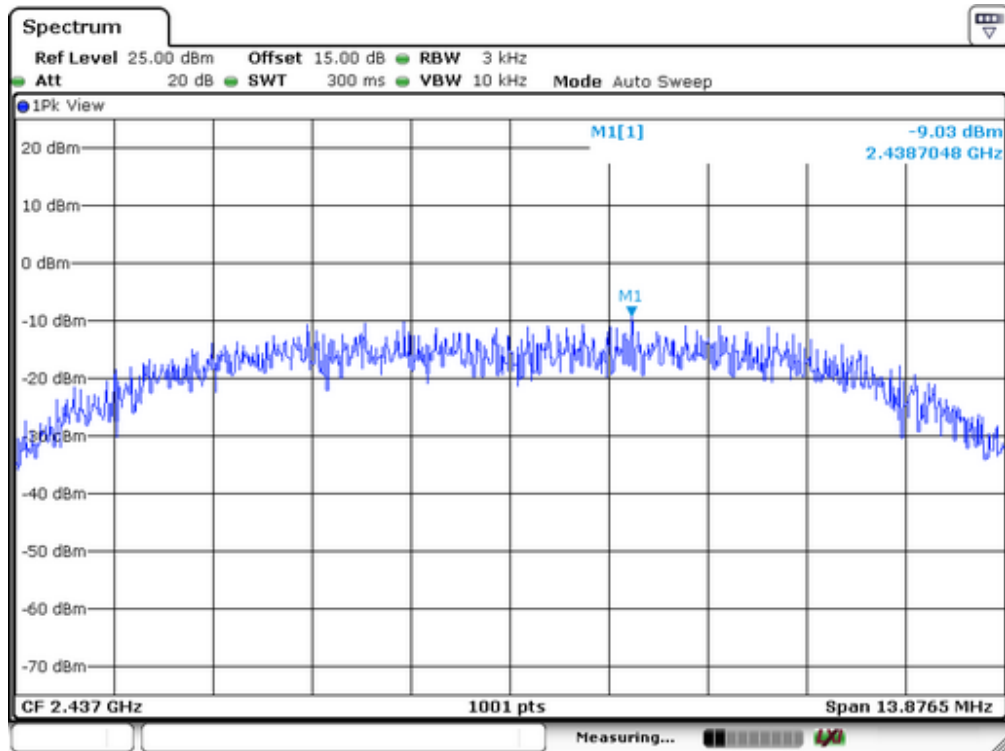

IEEE 802.11g			
Channel frequency (MHz)	Measurement level (dBm)	Limit(dBm)	Result
2412	-14.55	8	Pass
2437	-13.66		
2462	-12.18		

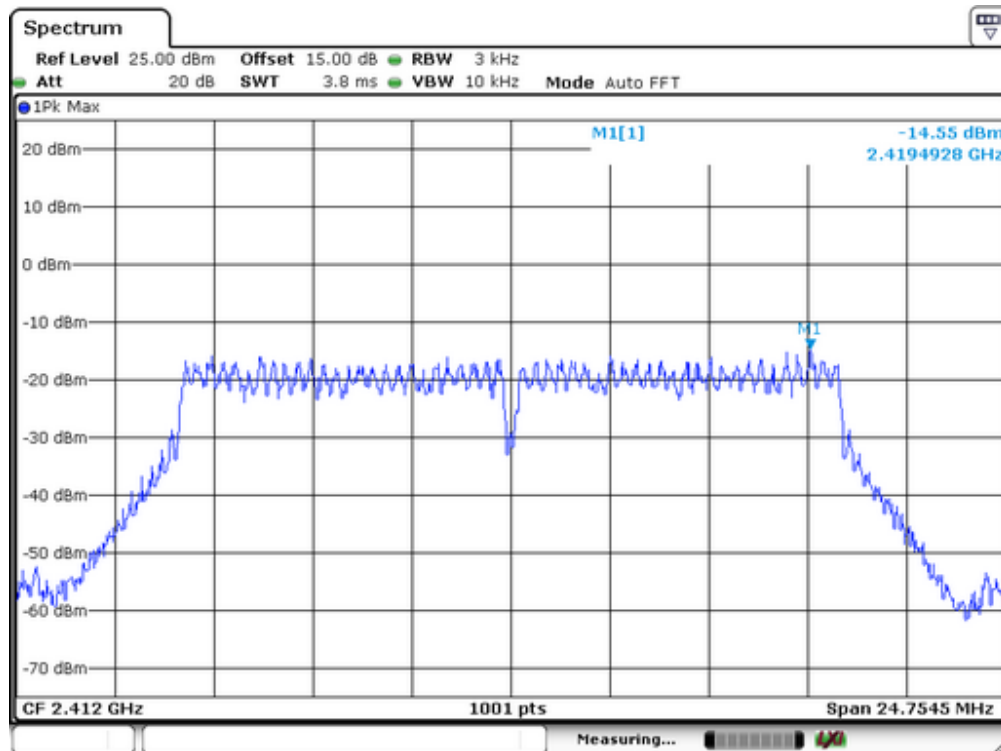

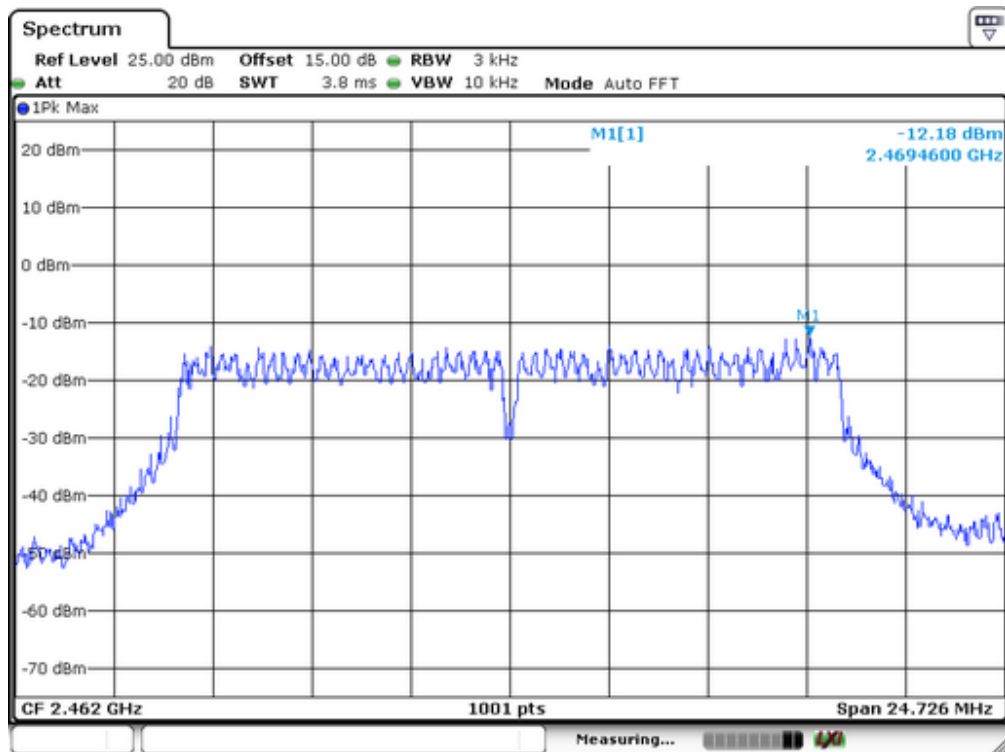
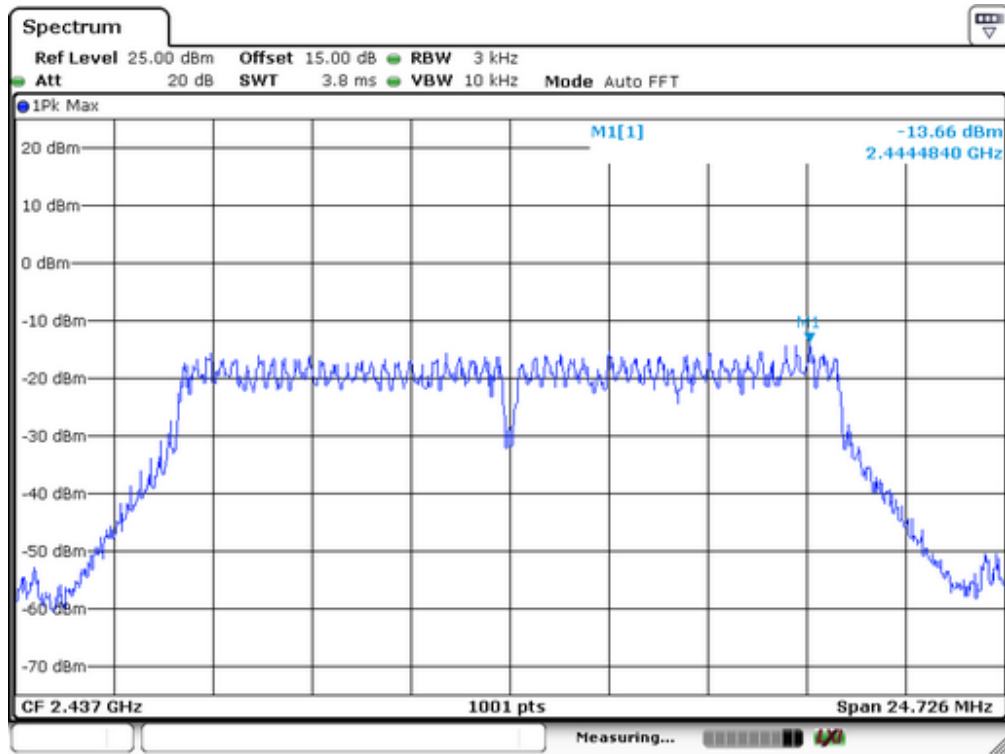

IEEE 802.11n(HT20)			
Channel frequency (MHz)	Measurement level (dBm)	Limit(dBm)	Result
2412	-15.29	8	Pass
2437	-14.83		
2462	-13.23		

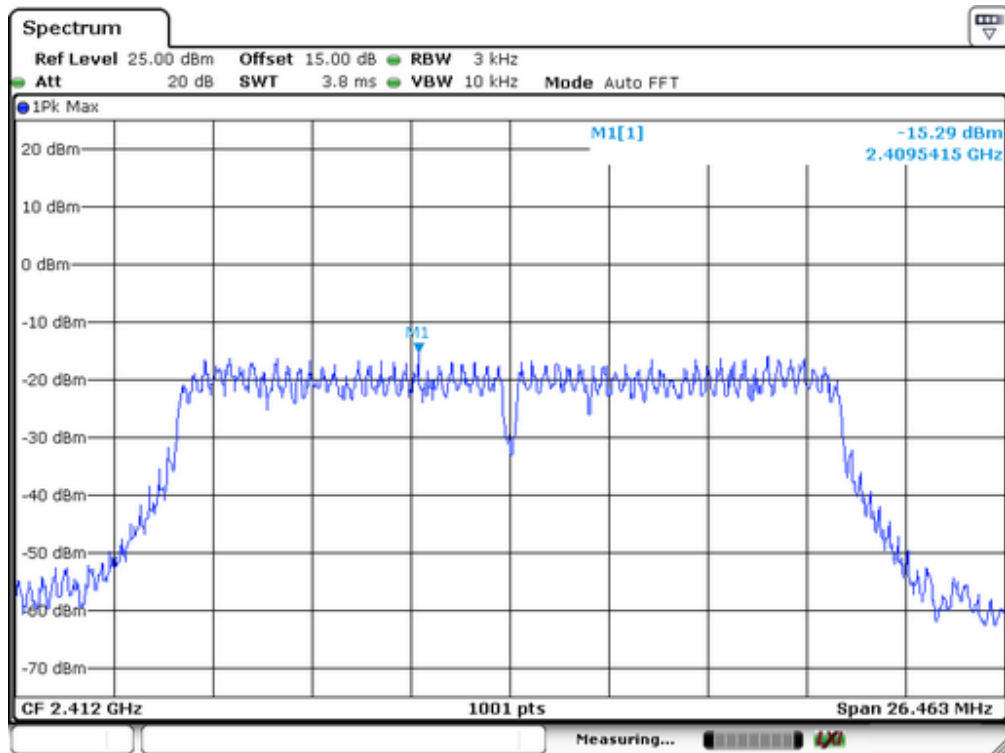

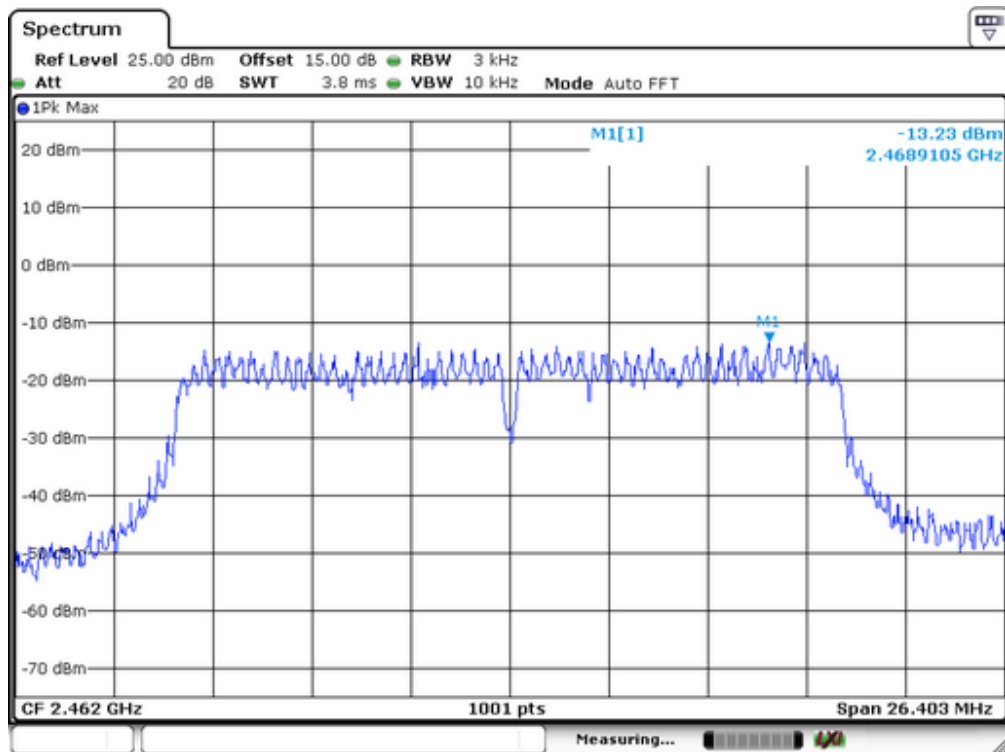
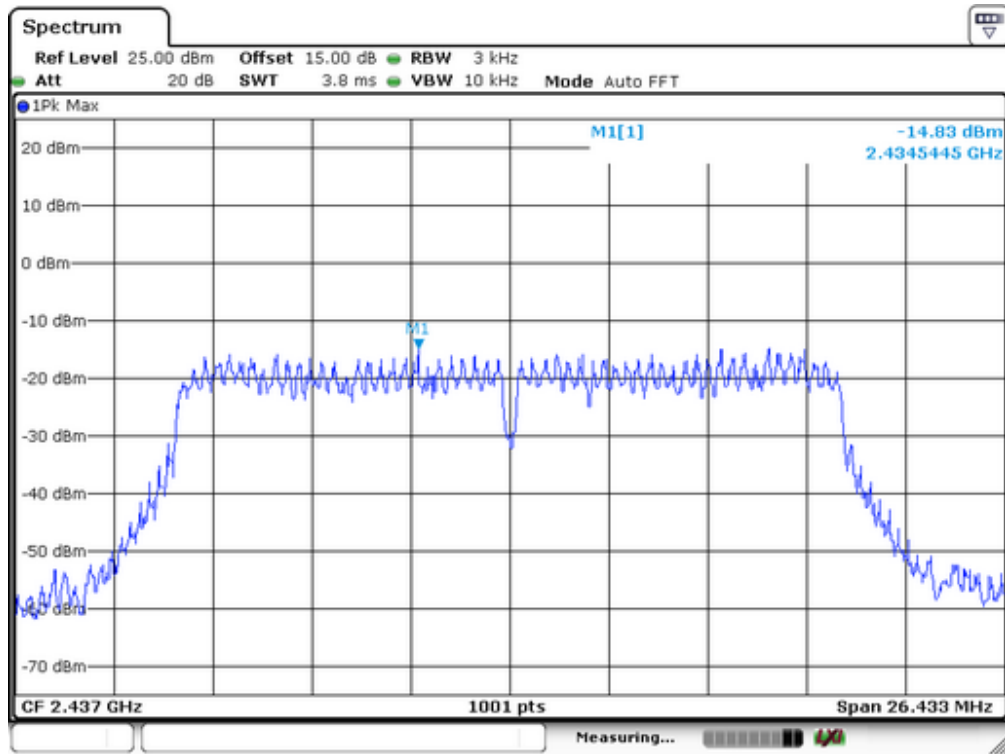

IEEE 802.11n(HT40)			
Channel frequency (MHz)	Measurement level (dBm)	Limit(dBm)	Result
2422	-16.20	8	Pass
2437	-15.37		
2452	-14.54		

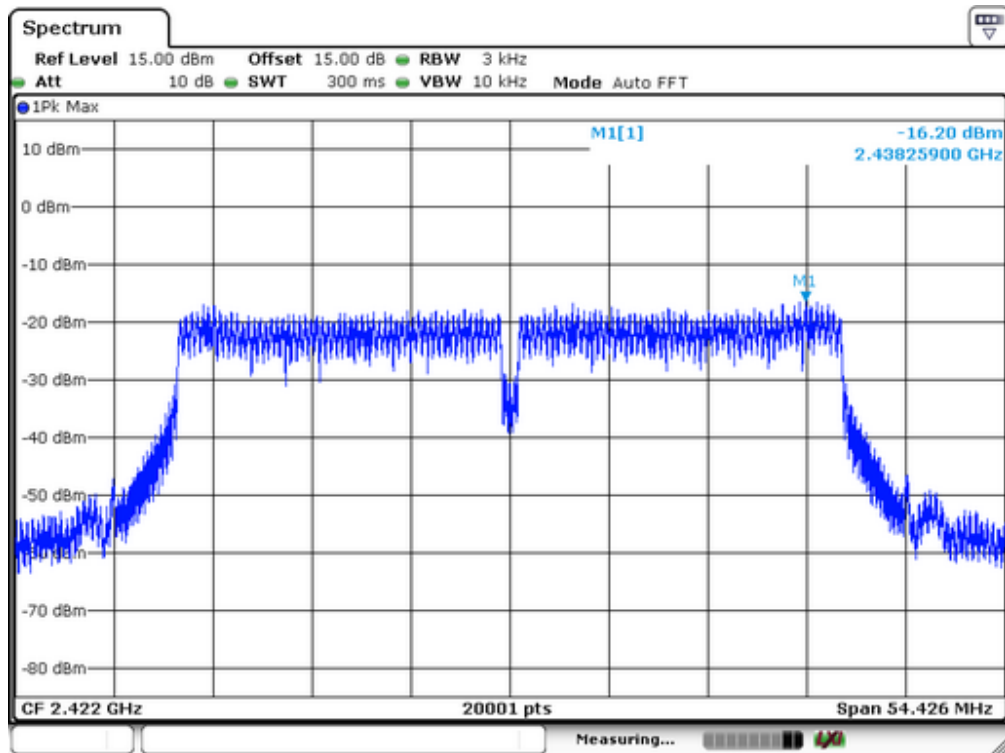

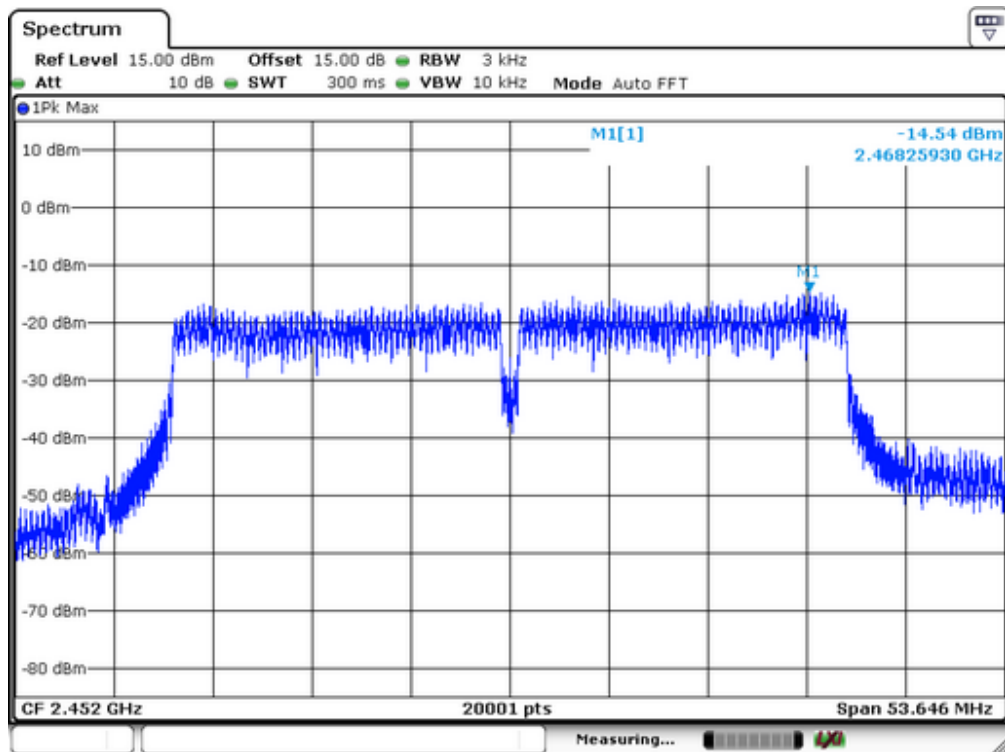
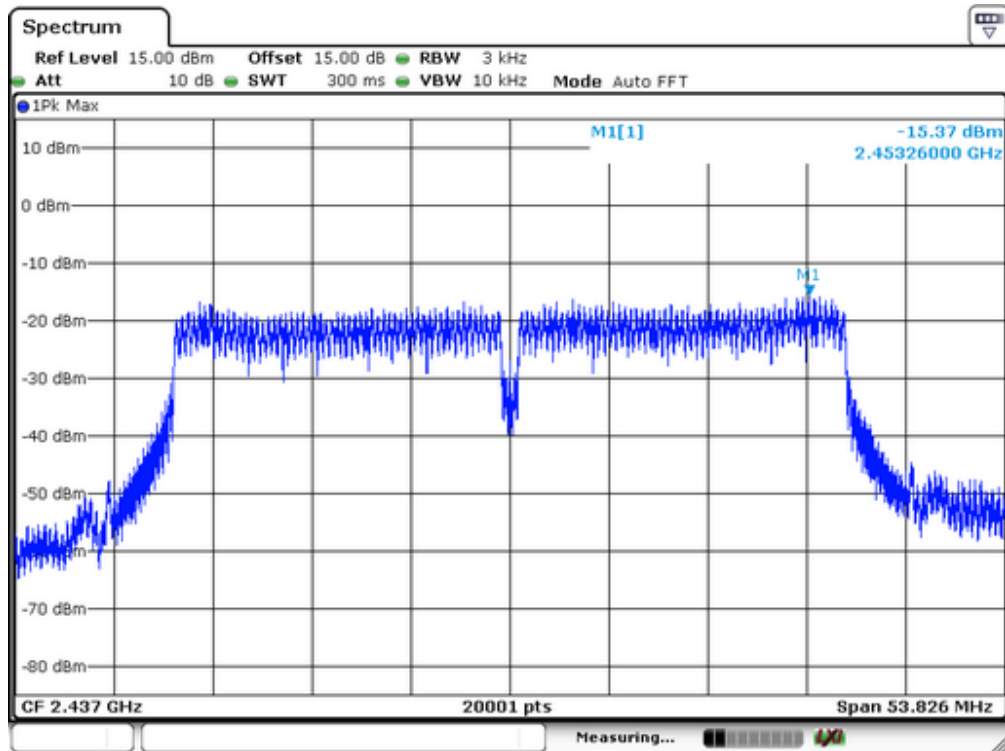

12. Antenna Port Emission

12.1 Test Equipment

EQUIPMENT TYPE	MFR	MODEL NUMBER	SERIAL NUMBER	LAST CAL.	CAL DUE.
Spectrum Analyzer	Agilent	FSV30	1321.3008K	03/16/2015	03/15/2016

12.2 Measuring Instruments and Setting

The following table is the setting of spectrum analyzer.

Spectrum analyzer	Setting
Attenuation	Auto
RB	100kHz
VB	300kHz
Detector	Peak
Trace	Max hold

12.3 Test Procedures

The conducted spurious emissions were measured conducted using a spectrum analyzer at low, Middle, and high channels, the limit was determined by attenuation 20dB of the RF peak power output.

12.4 Block Diagram of Test setup

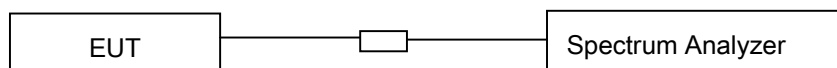

12.5 Test Result

PASS.

Please refer to following pages.

Test Mode: 802.11b

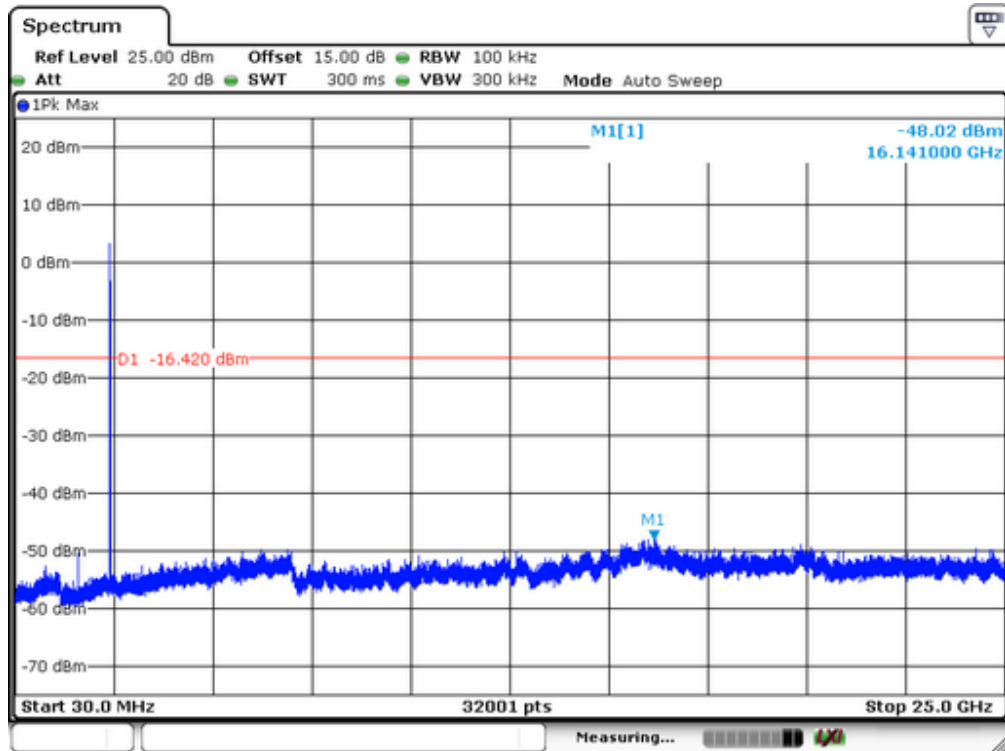

Lowest Channel

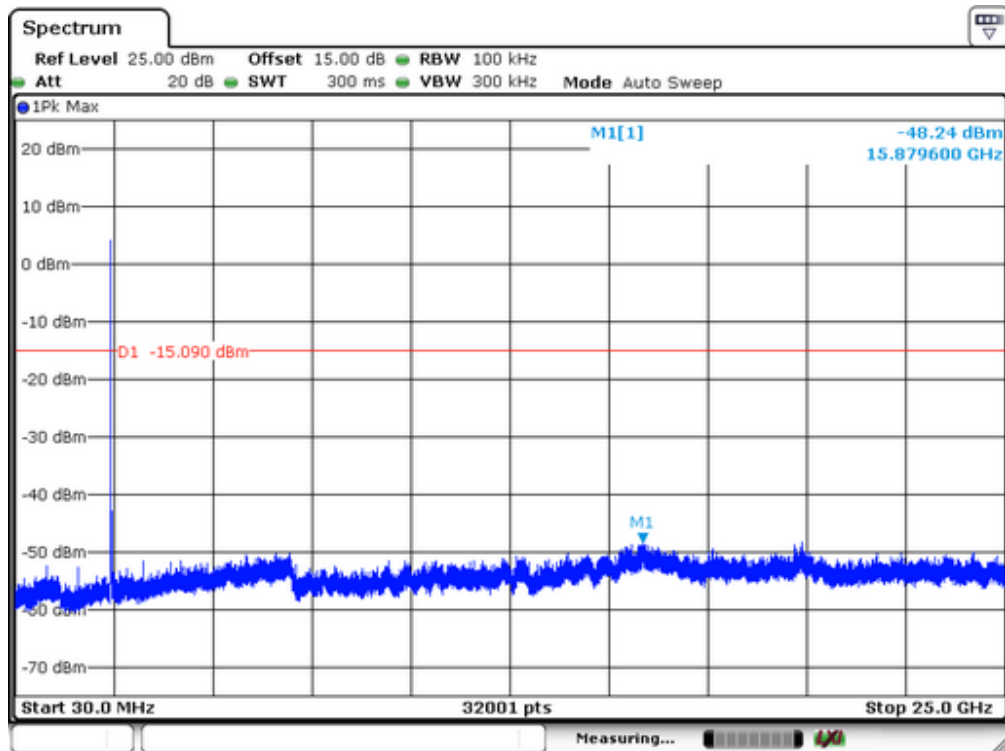

Middel Channel

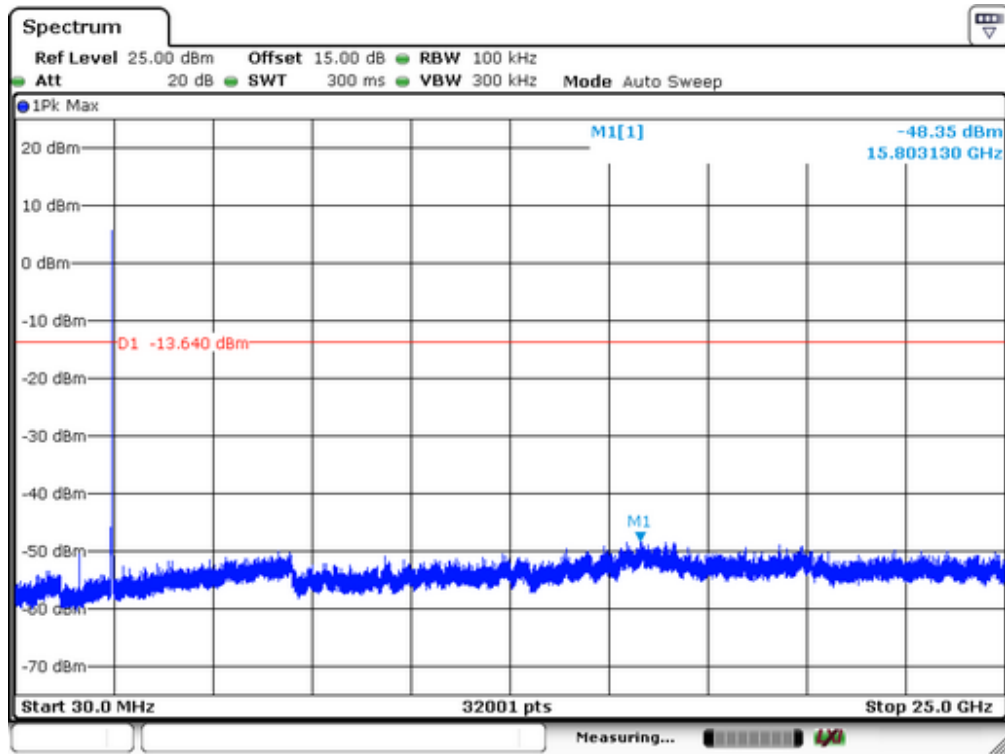

Highest Channel

Test Mode: 802.11g

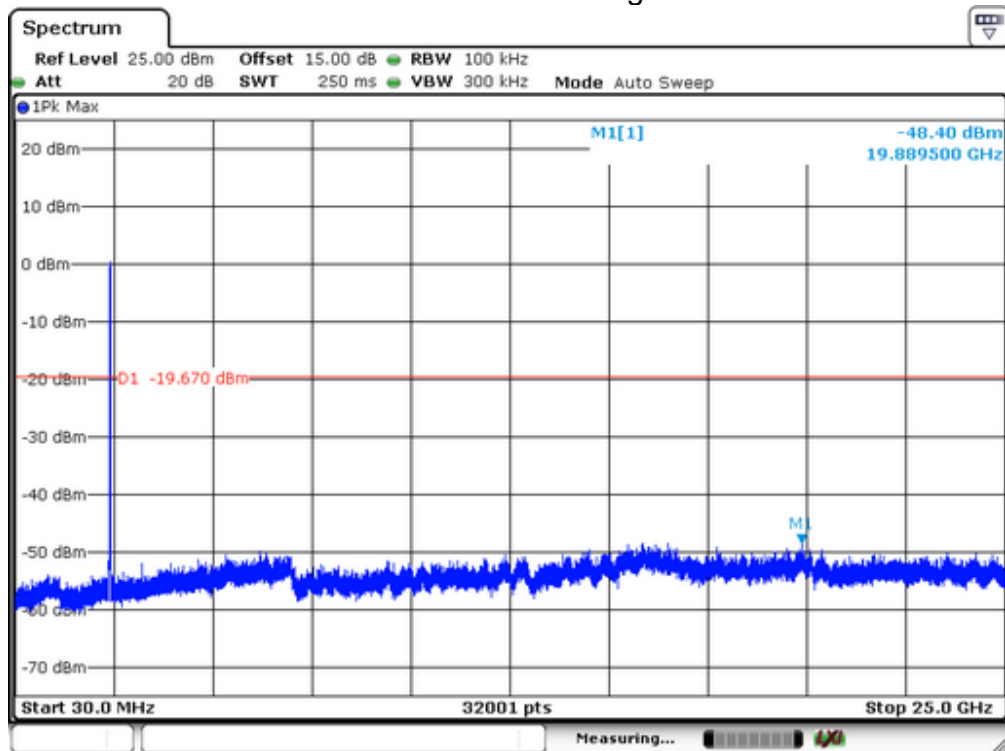

Lowest Channel

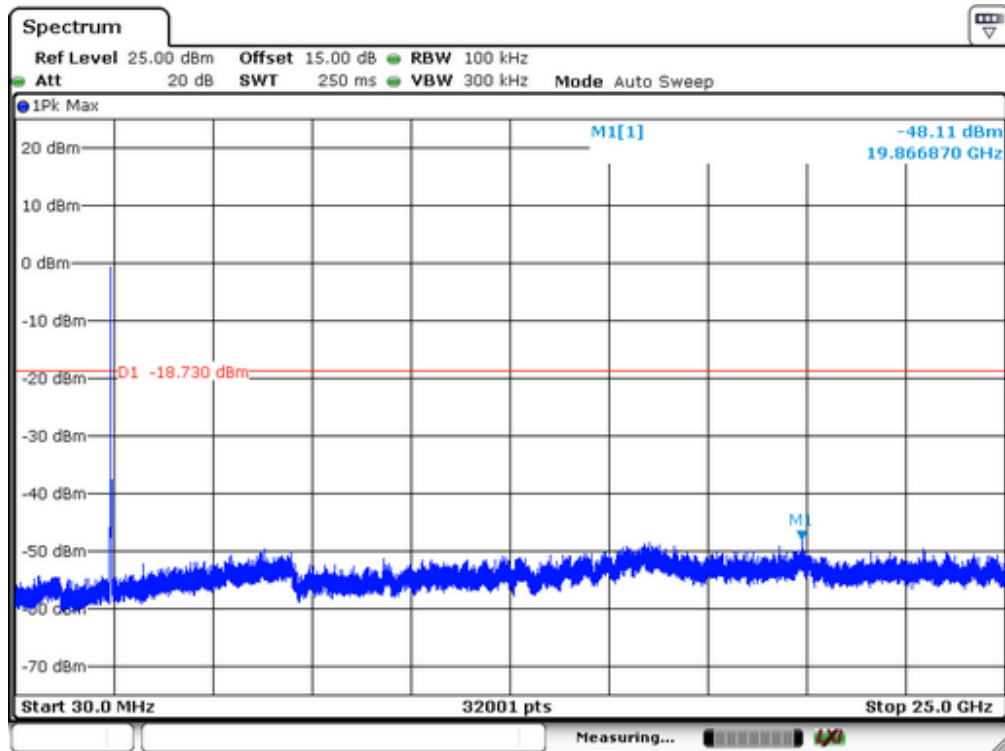

Middle Channel

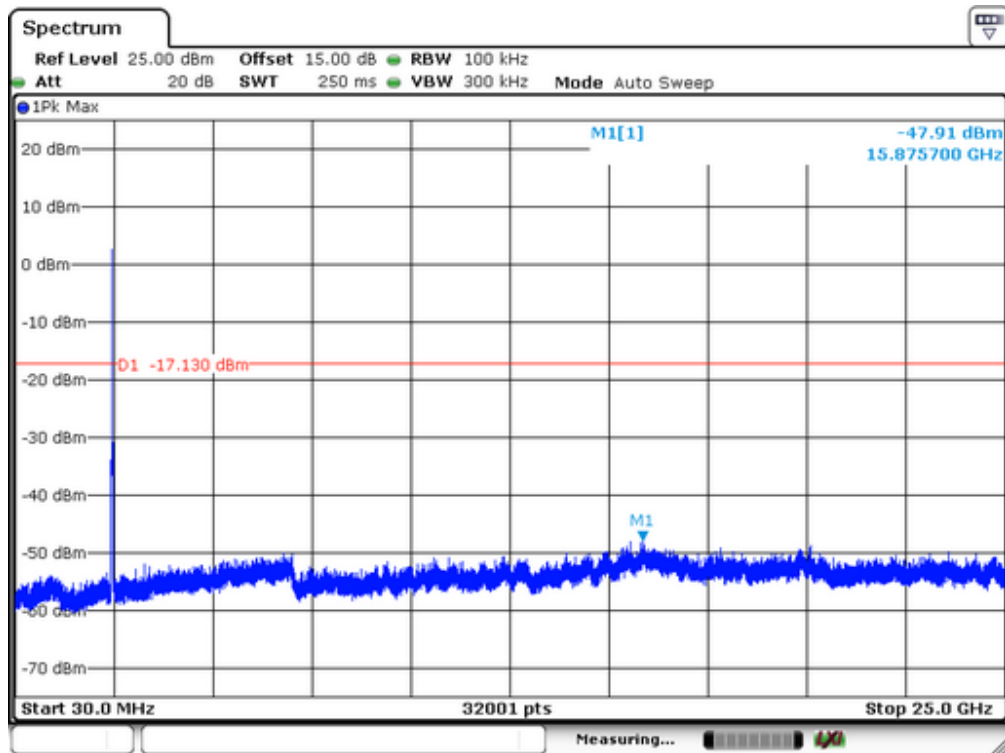

Highest Channel

Test Mode: 802.11n(HT20)

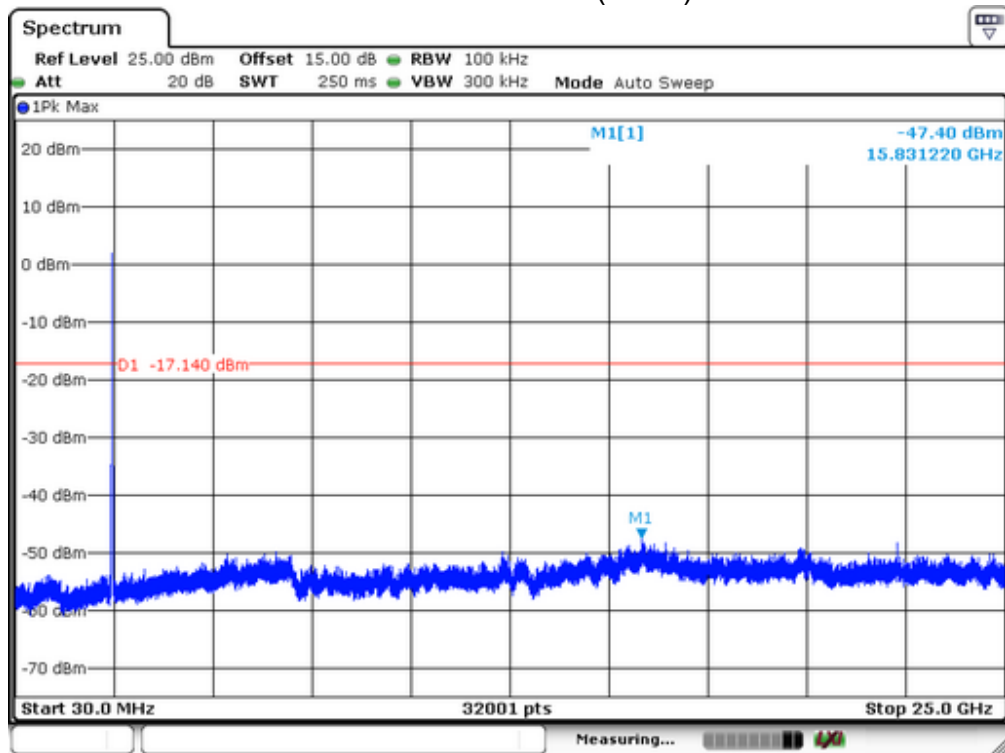

Lowest Channel

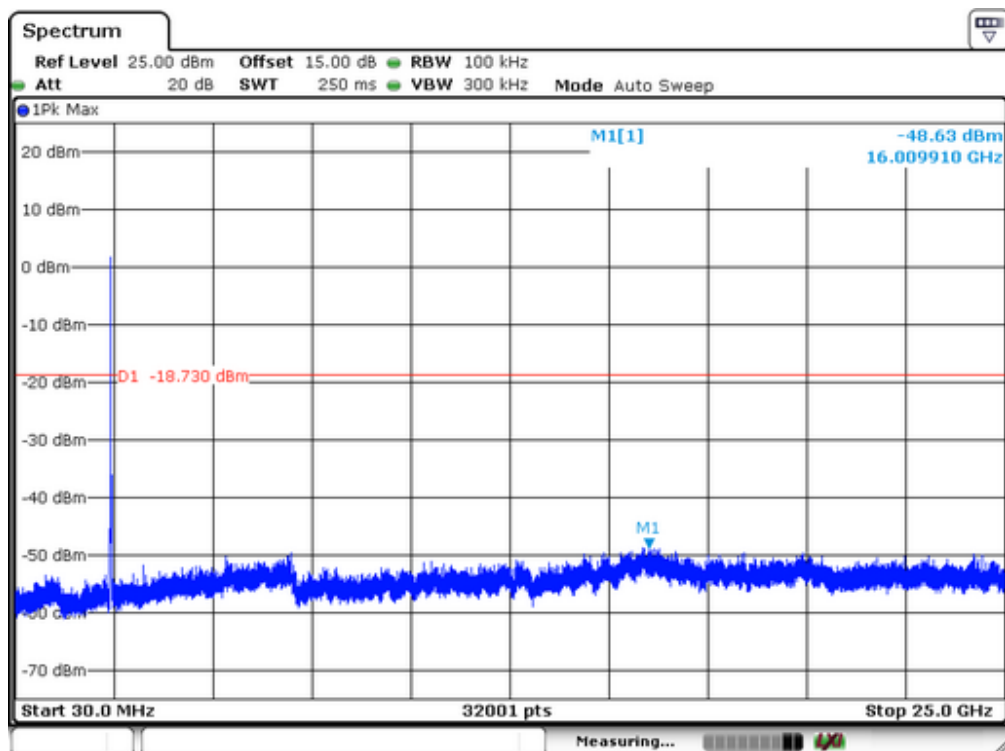

Middle Channel

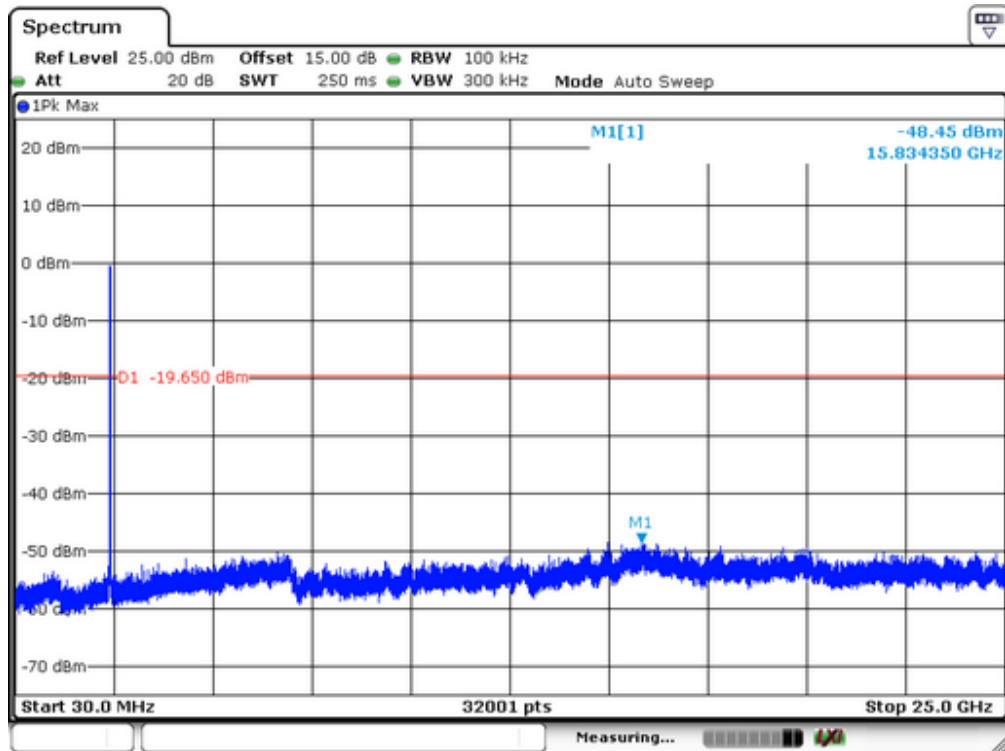

Highest Channel

Test Mode: 802.11n(HT40)

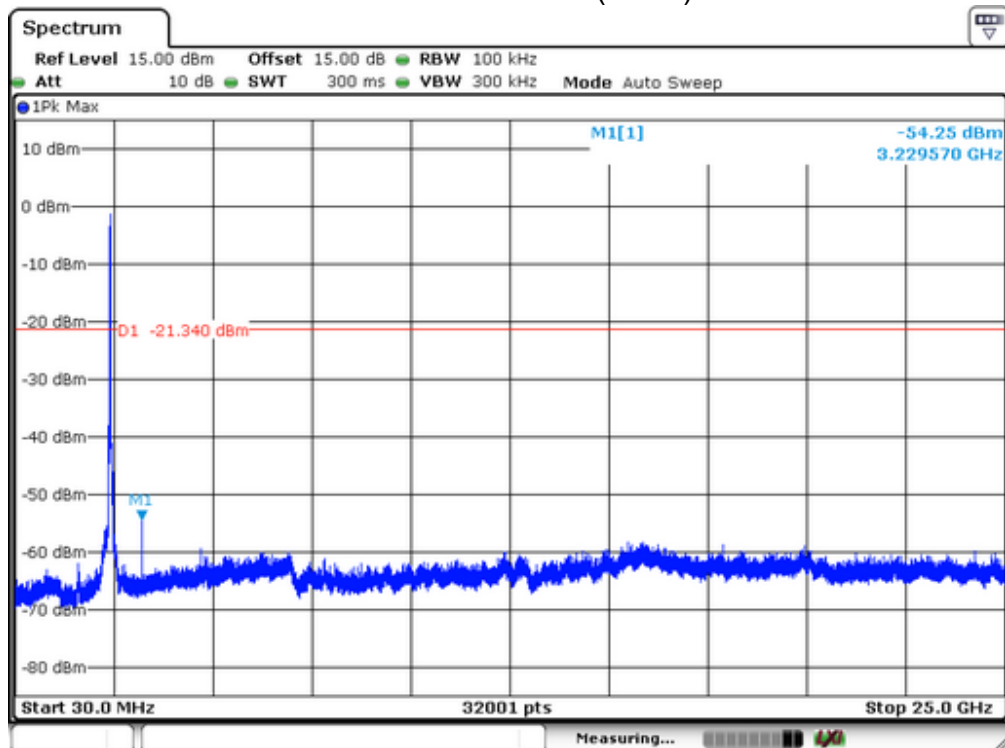

Lowest Channel

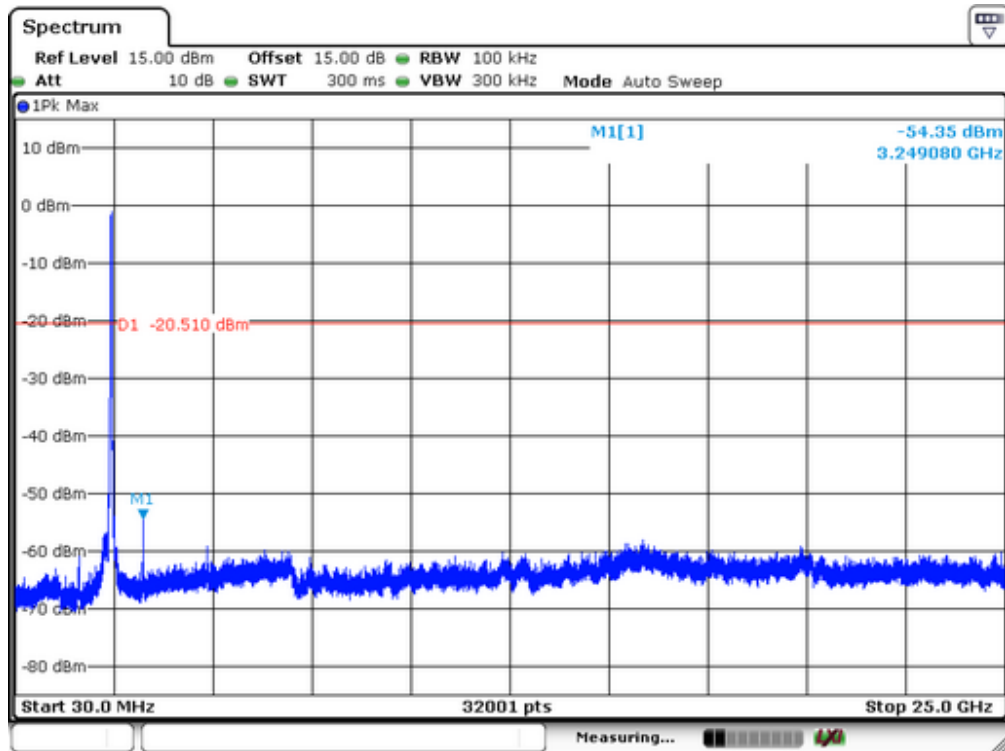

Middle Channel

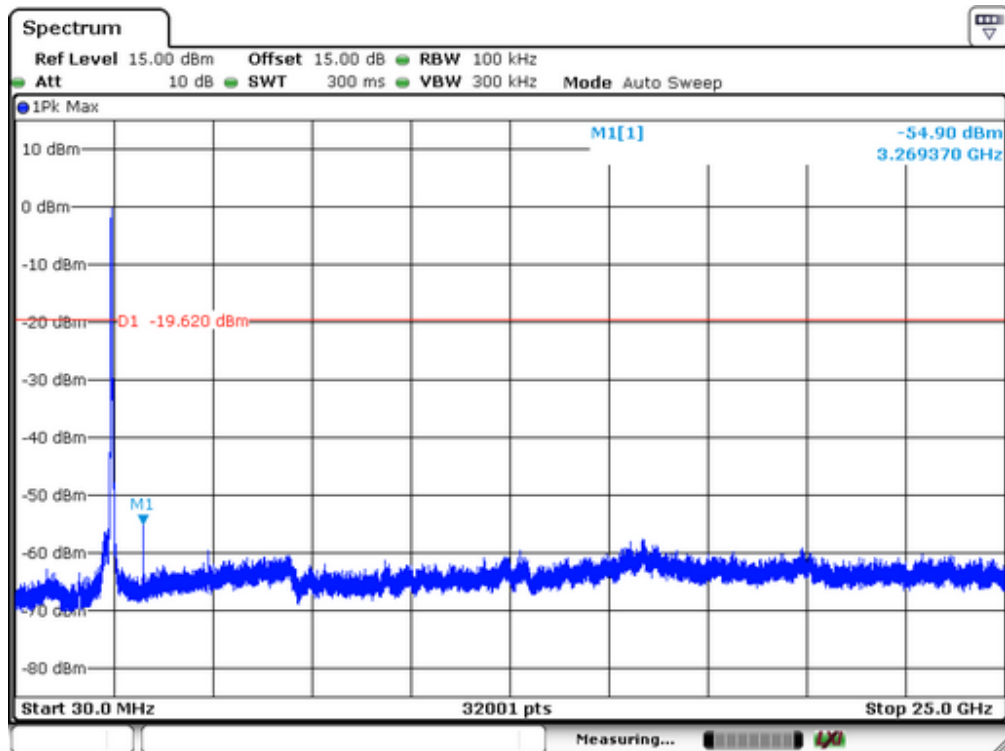

Highest Channel

13. Antenna Application

13.1 Antenna Requirement

For intentional device, according to FCC 47 CFR Section 15.203, an intentional radiator shall be designed to ensure that no antenna other than that furnished by the responsible party shall be used with the device. And according to FCC 47 CFR Section 15.247 (b), if transmitting antennas of directional gain greater than 6dBi are used, the power shall be reduced by the amount in dB that the directional gain of the antenna exceeds 6dBi.

13.2 Result

The EUT'S antenna is an internal PCB antenna. The antenna's gain is 2 dBi and meets the requirement.

APPENDIX I (PHOTOS OF EUT)









