

FCC Test Report

(WLAN UNII-2A / UNII-2C Band)

Report No.: RF170313E12A-1

FCC ID: 2ACTO-APX320

Test Model: APX 320

Received Date: Mar. 13, 2017

Test Date: Mar. 31 to May 05, 2017

Issued Date: Oct. 13, 2017

Applicant: Sophos Ltd

Address: The Pentagon, Abingdon Science Park, Abingdon, OX14 3YP, United Kingdom

Issued By: Bureau Veritas Consumer Products Services (H.K.) Ltd., Taoyuan Branch Hsin Chu Laboratory

Lab Address: E-2, No.1, Li Hsin 1st Road, Hsinchu Science Park, Hsinchu City 300, Taiwan R.O.C.

Test Location (1): E-2, No.1, Li Hsin 1st Road, Hsinchu Science Park, Hsinchu City 300, Taiwan R.O.C.

Test Location (2): No. 49, Ln. 206, Wende Rd., Shangshan Tsuen, Chiung Lin Hsiang, Hsin Chu Hsien 307, Taiwan R.O.C.



This report is for your exclusive use. Any copying or replication of this report to or for any other person or entity, or use of our name or trademark, is permitted only with our prior written permission. This report sets forth our findings solely with respect to the test samples identified herein. The results set forth in this report are not indicative or representative of the quality or characteristics of the lot from which a test sample was taken or any similar or identical product unless specifically and expressly noted. Our report includes all of the tests requested by you and the results thereof based upon the information that you provided to us. You have 60 days from date of issuance of this report to notify us of any material error or omission caused by our negligence, provided, however, that such notice shall be in writing and shall specifically address the issue you wish to raise. A failure to raise such issue within the prescribed time shall constitute your unqualified acceptance of the completeness of this report, the tests conducted and the correctness of the report contents. Unless specific mention, the uncertainty of measurement has been explicitly taken into account to declare the compliance or non-compliance to the specification. The report must not be used by the client to claim product certification, approval, or endorsement by TAF or any government agencies.

Table of Contents

Release Control Record	4
1 Certificate of Conformity	5
2 Summary of Test Results	6
2.1 Measurement Uncertainty	6
2.2 Modification Record	6
3 General Information	7
3.1 General Description of EUT (DFS band)	7
3.2 Description of Test Modes	10
3.2.1 Test Mode Applicability and Tested Channel Detail	11
3.3 Duty Cycle of Test Signal	15
3.4 Description of Support Units	16
3.4.1 Configuration of System under Test	17
3.5 General Description of Applied Standard	19
4 Test Types and Results	20
4.1 Radiated Emission and Bandedge Measurement	20
4.1.1 Limits of Radiated Emission and Bandedge Measurement	20
4.1.2 Test Instruments	21
4.1.3 Test Procedure	22
4.1.4 Deviation from Test Standard	23
4.1.5 Test Setup	23
4.1.6 EUT Operating Condition	24
4.1.7 Test Results	25
4.2 Conducted Emission Measurement	74
4.2.1 Limits of Conducted Emission Measurement	74
4.2.2 Test Instruments	74
4.2.3 Test Procedure	75
4.2.4 Deviation from Test Standard	75
4.2.5 Test Setup	75
4.2.6 EUT Operating Condition	75
4.2.7 Test Results	76
4.3 Transmit Power Measurement	80
4.3.1 Limits of Transmit Power Measurement	80
4.3.2 Test Setup	80
4.3.3 Test Instruments	81
4.3.4 Test Procedure	81
4.3.5 Deviation from Test Standard	81
4.3.6 EUT Operating Condition	81
4.3.7 Test Result	82
4.4 Occupied Bandwidth Measurement	109
4.4.1 Test Setup	109
4.4.2 Test Instruments	109
4.4.3 Test Procedure	109
4.4.4 Test Results	110
4.5 Peak Power Spectral Density Measurement	118
4.5.1 Limits of Peak Power Spectral Density Measurement	118
4.5.2 Test Setup	118
4.5.3 Test Instruments	118
4.5.4 Test Procedure	119
4.5.5 Deviation from Test Standard	119
4.5.6 EUT Operating Condition	119
4.5.7 Test Results	120
4.6 Frequency Stability Measurement	136
4.6.1 Limits of Frequency Stability Measurement	136

4.6.2	Test Setup.....	136
4.6.3	Test Instruments	136
4.6.4	Test Procedure	136
4.6.5	Deviation from Test Standard	136
4.6.6	EUT Operating Condition	136
4.6.7	Test Results	137
4.7	6dB Bandwidth Measurement	139
4.7.1	Limits of 6dB Bandwidth Measurement.....	139
4.7.2	Test Setup.....	139
4.7.3	Test Instruments	139
4.7.4	Test Procedure	139
4.7.5	Deviation from Test Standard	139
4.7.6	EUT Operating Condition	139
4.7.7	Test Results	140
5	Pictures of Test Arrangements.....	144
	Appendix – Information on the Testing Laboratories	145

Release Control Record

Issue No.	Description	Date Issued
RF170313E12A-1	Original release.	Oct. 13, 2017

1 Certificate of Conformity

Product: Sophos Access Point

Brand: SOPHOS

Test Model: APX 320

Sample Status: ENGINEERING SAMPLE

Applicant: Sophos Ltd

Test Date: Mar. 31 to May 05, 2017

Standard: 47 CFR FCC Part 15, Subpart E (Section 15.407)
ANSI C63.10: 2013

The above equipment has been tested by **Bureau Veritas Consumer Products Services (H.K.) Ltd., Taoyuan Branch**, and found compliance with the requirement of the above standards. The test record, data evaluation & Equipment Under Test (EUT) configurations represented herein are true and accurate accounts of the measurements of the sample's EMC characteristics under the conditions specified in this report.

Prepared by : Wendy Wu , **Date:** Oct. 13, 2017
Wendy Wu / Specialist

Approved by : May Chen , **Date:** Oct. 13, 2017
May Chen / Manager

2 Summary of Test Results

47 CFR FCC Part 15, Subpart E (Section 15.407)			
FCC Clause	Test Item	Result	Remarks
15.407(b)(6)	AC Power Conducted Emissions	Pass	Meet the requirement of limit. Minimum passing margin is -5.63dB at 25.125MHz.
15.407(b) (1/2/3/4(i/ii)/6)	Radiated Emissions & Band Edge Measurement*	Pass	Meet the requirement of limit. Minimum passing margin is -0.1dB at 5350.00MHz, 5470.00MHz, 5725.00MHz
15.407(a)(1/2/3)	Max Average Transmit Power	Pass	Meet the requirement of limit.
---	Occupied Bandwidth Measurement	-	Reference only.
15.407(a)(1/2/3)	Peak Power Spectral Density	Pass	Meet the requirement of limit.
15.407(e)	6dB bandwidth	Pass	Meet the requirement of limit. (U-NII-3 Band only)
15.407(g)	Frequency Stability	Pass	Meet the requirement of limit.
15.203	Antenna Requirement	Pass	Antenna connector is i-pex(MHF) not a standard connector.

2.1 Measurement Uncertainty

Where relevant, the following measurement uncertainty levels have been estimated for tests performed on the EUT as specified in CISPR 16-4-2:

Measurement	Frequency	Expanded Uncertainty (k=2) (\pm)
Conducted Emissions at mains ports	150kHz ~ 30MHz	1.84 dB
Radiated Emissions up to 1 GHz	30MHz ~ 1GHz	5.30 dB
Radiated Emissions above 1 GHz	1GHz ~ 6GHz	5.16 dB
	6GHz ~ 18GHz	4.91 dB
	18GHz ~ 40GHz	5.30 dB

2.2 Modification Record

There were no modifications required for compliance.

3 General Information

3.1 General Description of EUT (DFS band)

Product	Sophos Access Point
Brand	SOPHOS
Test Model	APX 320
Status of EUT	ENGINEERING SAMPLE
Power Supply Rating	DC 48V from POE
Modulation Type	64QAM, 16QAM, QPSK, BPSK for OFDM 256QAM for OFDM in 11ac mode only
Modulation Technology	OFDM
Transfer Rate	802.11a: up to 54Mbps 802.11n: up to 300Mbps 802.11ac: up to 866.7Mbps
Operating Frequency	5.26 ~ 5.32GHz, 5.5 ~ 5.72GHz
Number of Channel	802.11a, 802.11n (HT20), 802.11ac (VHT20): 16 802.11n (HT40), 802.11ac (VHT40): 8 802.11ac (VHT80): 4
Output Power	5.26 ~ 5.32GHz: 2TX CDD Mode: 231.012mW Beamforming Mode: 142.985mW 1TX: 158.855mW 5.50 ~ 5.72GHz: 2TX CDD Mode: 202.267mW Beamforming Mode: 110.983mW 1TX: 207.491mW
Antenna Type	Refer to Note
Antenna Connector	Refer to Note
Accessory Device	NA
Data Cable Supplied	NA

Note:

- This report is prepared for FCC class II permissive change. The difference compared with the Report No.: RF170313E12-1 as the following:
 - ◆ Add DFS band <5.26 ~ 5.32GHz, 5.5 ~ 5.72GHz>
- According to above condition, all test items need to be performed. And all data weres verified to meet the requirements.
- Simultaneously transmission condition.

Condition	Technology		
1	WLAN (Radio 1) (2.4GHz)	WLAN (Radio 2) (5GHz-UNII-1, UNII-2A)	Bluetooth
2	WLAN (Radio 1) (5GHz-UNII-2C, UNII-3)	WLAN (Radio 2) (5GHz-UNII-1, UNII-2A)	Bluetooth

Note: The emission of the simultaneous operation has been evaluated and no non-compliance was found.

- The EUT must be supplied with a POE (only for test not for sale) as following table:

Brand	Model No.	Spec.
PowerDsine	PD-3501G/AC	Input: 100-240Vac, 50/60Hz, 0.43A Output: 48Vdc, 0.35A

- The antennas provided to the EUT, please refer to the following table:

Radio 1							
WLAN - 2.4GHz + 5GHz							
Antenna No.	Transmitter Circuit	Brand	Model No.	Antenna Net Gain (dBi)	Frequency Range (GHz)	Antenna Type	Connector Type
1	Chain (0)	WNC	NA	3.48 6.79	2.4~2.4835 5.47~5.85	PIFA	i-pex(MHF)
2	Chain (1)	WNC	NA	3.74 6.16	2.4~2.4835 5.47~5.85	PIFA	i-pex(MHF)
Radio 2							
WLAN 5GHz							
Antenna No.	Transmitter Circuit	Brand	Model No.	Antenna Net Gain (dBi)	Frequency Range (GHz)	Antenna Type	Connector Type
1	Chain (0)	WNC	NA	4.87	5.15~5.35	PIFA	i-pex(MHF)
2	Chain (1)	WNC	NA	5.64	5.15~5.35	PIFA	i-pex(MHF)
Radio 3							
Bluetooth - 2.4GHz							
Antenna No.	Transmitter Circuit	Brand	Model No.	Antenna Net Gain (dBi)	Frequency Range (GHz)	Antenna Type	Connector Type
1	Chain (0)	WNC	NA	1.87	2.4~2.4835	PIFA	i-pex(MHF)

Note: For 1TX configuration mode, max gain was selected for the final test.

6. The EUT incorporates a MIMO function:

2.4GHz Band			
MODULATION MODE	DATA RATE (MCS)	TX & RX CONFIGURATION	
802.11b	1 ~ 11Mbps	2TX/1TX diversity	2TX/1TX diversity
802.11g	6 ~ 54Mbps	2TX/1TX diversity	2TX/1TX diversity
802.11n HT20	MCS 0~7	2TX/1TX diversity	2TX/1TX diversity
	MCS 8~15	2TX	2TX
802.11n HT40	MCS 0~7	2TX/1TX diversity	2TX/1TX diversity
	MCS 8~15	2TX	2TX
5GHz Band			
MODULATION MODE	DATA RATE (MCS)	TX & RX CONFIGURATION	
802.11a	6 ~ 54Mbps	2TX/1TX diversity	2TX/1TX diversity
802.11n HT20	MCS 0~7	2TX/1TX diversity	2TX/1TX diversity
	MCS 8~15	2TX	2TX
802.11n HT40	MCS 0~7	2TX/1TX diversity	2TX/1TX diversity
	MCS 8~15	2TX	2TX
802.11ac VHT20	MCS0~8 Nss=1	2TX/1TX diversity	2TX/1TX diversity
	MCS0~8 Nss=2	2TX	2TX
802.11ac VHT40	MCS0~9 Nss=1	2TX/1TX diversity	2TX/1TX diversity
	MCS0~9 Nss=2	2TX	2TX
802.11ac VHT80	MCS0~9 Nss=1	2TX/1TX diversity	2TX/1TX diversity
	MCS0~9 Nss=2	2TX	2TX

Note:

1. All of modulation mode support beamforming function except 802.11a/b/g modulation mode.
2. The modulation and bandwidth are similar for 802.11n mode for 20MHz (40MHz) and 802.11ac mode for 20MHz (40MHz), therefore investigated worst case to representative mode in test report. (Final test mode refer section 3.2.1)
3. The EUT support Beamforming and CDD mode, therefore both mode were investigated and the worst case scenario was identified. The worst case data were presented in test report.

7. The above EUT information is declared by manufacturer and for more detailed features description, please refer to the manufacturer's specifications or user's manual.

3.2 Description of Test Modes

FOR 5260 ~ 5320MHz

4 channels are provided for 802.11a, 802.11n (HT20), 802.11ac (VHT20):

Channel	Frequency	Channel	Frequency
52	5260 MHz	60	5300 MHz
56	5280 MHz	64	5320 MHz

2 channels are provided for 802.11n (HT40), 802.11ac (VHT40):

Channel	Frequency	Channel	Frequency
54	5270 MHz	62	5310 MHz

1 channel is provided for 802.11ac (VHT80):

Channel	Frequency
58	5290 MHz

FOR 5500 ~ 5720MHz

12 channels are provided for 802.11a, 802.11n (HT20), 802.11ac (VHT20):

Channel	Frequency	Channel	Frequency
100	5500 MHz	124	5620 MHz
104	5520 MHz	128	5640 MHz
108	5540 MHz	132	5660 MHz
112	5560 MHz	136	5680 MHz
116	5580 MHz	140	5700 MHz
120	5600 MHz	144	5720 MHz

6 channels are provided for 802.11n (HT40), 802.11ac (VHT40):

Channel	Frequency	Channel	Frequency
102	5510 MHz	126	5630 MHz
110	5550 MHz	134	5670 MHz
118	5590 MHz	142	5710 MHz

3 channels are provided for 802.11ac (VHT80):

Channel	Frequency	Channel	Frequency
106	5530 MHz	138	5690 MHz
122	5610 MHz		

3.2.1 Test Mode Applicability and Tested Channel Detail

EUT Configure Mode	Applicable To				Description
	RE \geq 1G	RE $<$ 1G	PLC	APCM	
-	√	√	√	√	-

Where **RE \geq 1G**: Radiated Emission above 1GHz **RE $<$ 1G**: Radiated Emission below 1GHz
PLC: Power Line Conducted Emission **APCM**: Antenna Port Conducted Measurement

NOTE:

1. The EUT had been pre-tested on the positioned of each 3 axis. The worst case was found when positioned on **Z-plane**.

Radiated Emission Test (Above 1GHz):

- Pre-Scan has been conducted to determine the worst-case mode from all possible combinations between available modulations, data rates and antenna ports (if EUT with antenna diversity architecture).
- Following channel(s) was (were) selected for the final test as listed below.

2TX Configuration- CDD Mode						
Radio 2						
Mode	FREQ. Band (MHz)	Available Channel	Tested Channel	Modulation Technology	Modulation Type	Data Rate (Mbps)
802.11a	5260-5320	52 to 64	52, 60, 64	OFDM	BPSK	6
802.11ac (VHT20)		52 to 64	52, 60, 64	OFDM	BPSK	6.5
802.11ac (VHT40)		54 to 62	54, 62	OFDM	BPSK	13.5
802.11ac (VHT80)		58	58	OFDM	BPSK	29.3
Radio 1						
802.11a	5500-5720	100 to 144	100, 116, 140, 144	OFDM	BPSK	6
802.11ac (VHT20)		100 to 144	100, 116, 140, 144	OFDM	BPSK	6.5
802.11ac (VHT40)		102 to 142	102, 110, 134, 142	OFDM	BPSK	13.5
802.11ac (VHT80)		106 to 138	106, 122, 138	OFDM	BPSK	29.3
1TX Configuration						
Radio 2						
Mode	FREQ. Band (MHz)	Available Channel	Tested Channel	Modulation Technology	Modulation Type	Data Rate (Mbps)
802.11a	5260-5320	52 to 64	52, 60, 64	OFDM	BPSK	6
802.11ac (VHT20)		52 to 64	52, 60, 64	OFDM	BPSK	6.5
802.11ac (VHT40)		54 to 62	54, 62	OFDM	BPSK	13.5
802.11ac (VHT80)		58	58	OFDM	BPSK	29.3
Radio 1						
802.11a	5500-5720	100 to 144	100, 116, 140, 144	OFDM	BPSK	6
802.11ac (VHT20)		100 to 144	100, 116, 140, 144	OFDM	BPSK	6.5
802.11ac (VHT40)		102 to 142	102, 110, 134, 142	OFDM	BPSK	13.5
802.11ac (VHT80)		106 to 138	106, 122, 138	OFDM	BPSK	29.3

Radiated Emission Test (Below 1GHz):

- Pre-Scan has been conducted to determine the worst-case mode from all possible combinations between available modulations, data rates and antenna ports (if EUT with antenna diversity architecture).
- Following channel(s) was (were) selected for the final test as listed below.

2TX Configuration - CDD Mode						
Radio 2						
Mode	FREQ. Band (MHz)	Available Channel	Tested Channel	Modulation Technology	Modulation Type	Data Rate (Mbps)
802.11ac (VHT40)	5260-5320	54 to 62	54	OFDM	BPSK	13.5
Radio 1						
802.11ac (VHT40)	5500-5720	102 to 142	110	OFDM	BPSK	13.5

Power Line Conducted Emission Test:

- Pre-Scan has been conducted to determine the worst-case mode from all possible combinations between available modulations, data rates and antenna ports (if EUT with antenna diversity architecture).
- Following channel(s) was (were) selected for the final test as listed below.

2TX Configuration - CDD Mode						
Radio 2						
Mode	FREQ. Band (MHz)	Available Channel	Tested Channel	Modulation Technology	Modulation Type	Data Rate (Mbps)
802.11ac (VHT40)	5260-5320	54 to 62	54	OFDM	BPSK	13.5
Radio 1						
802.11ac (VHT40)	5500-5720	102 to 142	110	OFDM	BPSK	13.5

Antenna Port Conducted Measurement:

- This item includes all test value of each mode, but only includes spectrum plot of worst value of each mode.
- Pre-Scan has been conducted to determine the worst-case mode from all possible combinations between available modulations, data rates and antenna ports (if EUT with antenna diversity architecture).
- Following channel(s) was (were) selected for the final test as listed below.

2TX Configuration- CDD Mode						
Radio 2						
Mode	FREQ. Band (MHz)	Available Channel	Tested Channel	Modulation Technology	Modulation Type	Data Rate (Mbps)
802.11a	5260-5320	52 to 64	52, 60, 64	OFDM	BPSK	6
802.11ac (VHT20)		52 to 64	52, 60, 64	OFDM	BPSK	6.5
802.11ac (VHT40)		54 to 62	54, 62	OFDM	BPSK	13.5
802.11ac (VHT80)		58	58	OFDM	BPSK	29.3
Radio 1						
802.11a	5500-5720	100 to 144	100, 116, 140, 144	OFDM	BPSK	6
802.11ac (VHT20)		100 to 144	100, 116, 140, 144	OFDM	BPSK	6.5
802.11ac (VHT40)		102 to 142	102, 110, 134, 142	OFDM	BPSK	13.5
802.11ac (VHT80)		106 to 138	106, 122, 138	OFDM	BPSK	29.3
2TX Configuration- Beamforming Mode (Output power only)						
Radio 2						
Mode	FREQ. Band (MHz)	Available Channel	Tested Channel	Modulation Technology	Modulation Type	Data Rate (Mbps)
802.11ac (VHT20)	5260-5320	52 to 64	52, 60, 64	OFDM	BPSK	6.5
802.11ac (VHT40)		54 to 62	54, 62	OFDM	BPSK	13.5
802.11ac (VHT80)		58	58	OFDM	BPSK	29.3
Radio 1						
802.11ac (VHT20)	5500-5720	100 to 144	100, 116, 140, 144	OFDM	BPSK	6.5
802.11ac (VHT40)		102 to 142	102, 110, 134, 142	OFDM	BPSK	13.5
802.11ac (VHT80)		106 to 138	106, 122, 138	OFDM	BPSK	29.3
1TX Configuration						
Radio 2						
Mode	FREQ. Band (MHz)	Available Channel	Tested Channel	Modulation Technology	Modulation Type	Data Rate (Mbps)
802.11a	5260-5320	52 to 64	52, 60, 64	OFDM	BPSK	6
802.11ac (VHT20)		52 to 64	52, 60, 64	OFDM	BPSK	6.5
802.11ac (VHT40)		54 to 62	54, 62	OFDM	BPSK	13.5
802.11ac (VHT80)		58	58	OFDM	BPSK	29.3
Radio 1						
802.11a	5500-5720	100 to 144	100, 116, 140, 144	OFDM	BPSK	6
802.11ac (VHT20)		100 to 144	100, 116, 140, 144	OFDM	BPSK	6.5
802.11ac (VHT40)		102 to 142	102, 110, 134, 142	OFDM	BPSK	13.5
802.11ac (VHT80)		106 to 138	106, 122, 138	OFDM	BPSK	29.3

Test Condition:

Applicable To	Environmental Conditions	Input Power (System)	Tested By
RE≥1G	24deg. C, 65%RH	120Vac, 60Hz	Terry Huang
RE<1G	23deg. C, 62%RH	120Vac, 60Hz	Weiwei Lo
PLC	24deg. C, 74%RH	120Vac, 60Hz	Andy Ho
APCM	25deg. C, 60%RH	120Vac, 60Hz	Robert Cheng

3.3 Duty Cycle of Test Signal

If duty cycle of test signal is $\geq 98\%$, duty factor is not required.

If duty cycle of test signal is $< 98\%$, duty factor shall be considered.

802.11a: Duty cycle = $2.043 \text{ ms} / 2.126 \text{ ms} = 0.961$, Duty factor = $10 * \log(1/0.961) = 0.17$

802.11ac (VHT20): Duty cycle = $4.963 \text{ ms} / 5.063 \text{ ms} = 0.98$

802.11ac (VHT40): Duty cycle = $2.415 \text{ ms} / 2.505 \text{ ms} = 0.964$, Duty factor = $10 * \log(1/0.964) = 0.16$

802.11ac (VHT80): Duty cycle = $1.135 \text{ ms} / 1.214 \text{ ms} = 0.935$, Duty factor = $10 * \log(1/0.935) = 0.29$

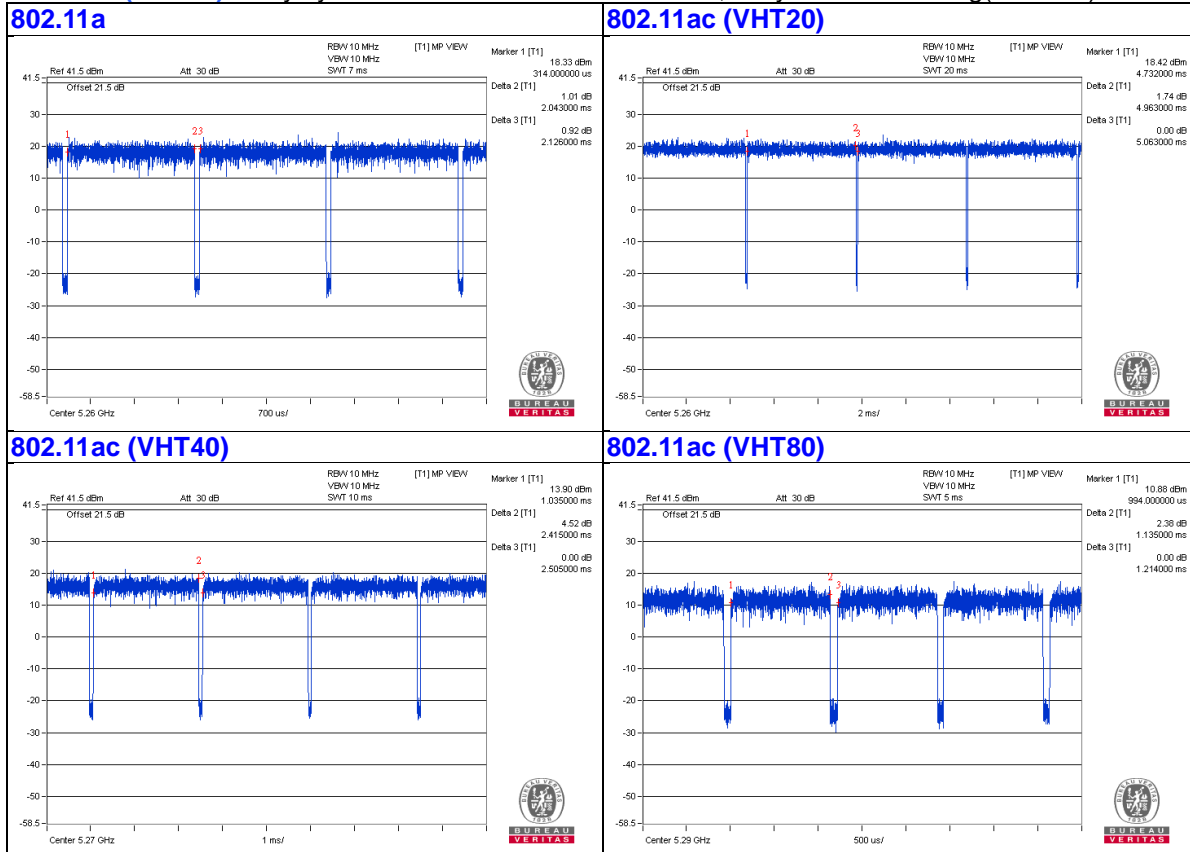

3.4 Description of Support Units

The EUT has been tested as an independent unit together with other necessary accessories or support units. The following support units or accessories were used to form a representative test configuration during the tests.

ID	Product	Brand	Model No.	Serial No.	FCC ID	Remarks
A.	Laptop	DELL	E5430	HYV4VY1	FCC DoC	Provided by Lab
B.	POE	PowerDsine	PD-3501G/AC	NA	NA	Supplied by client

Note:

1. All power cords of the above support units are non-shielded (1.8m).

ID	Descriptions	Qty.	Length (m)	Shielding (Yes/No)	Cores (Qty.)	Remarks
1.	RJ-45 Cable	1	10	No	0	Provided by Lab
2.	RJ-45 Cable	1	3	No	0	Provided by Lab
3.	Console Cable	1	1.8	No	0	Provided by Lab

3.4.1 Configuration of System under Test

For Conducted Emission:

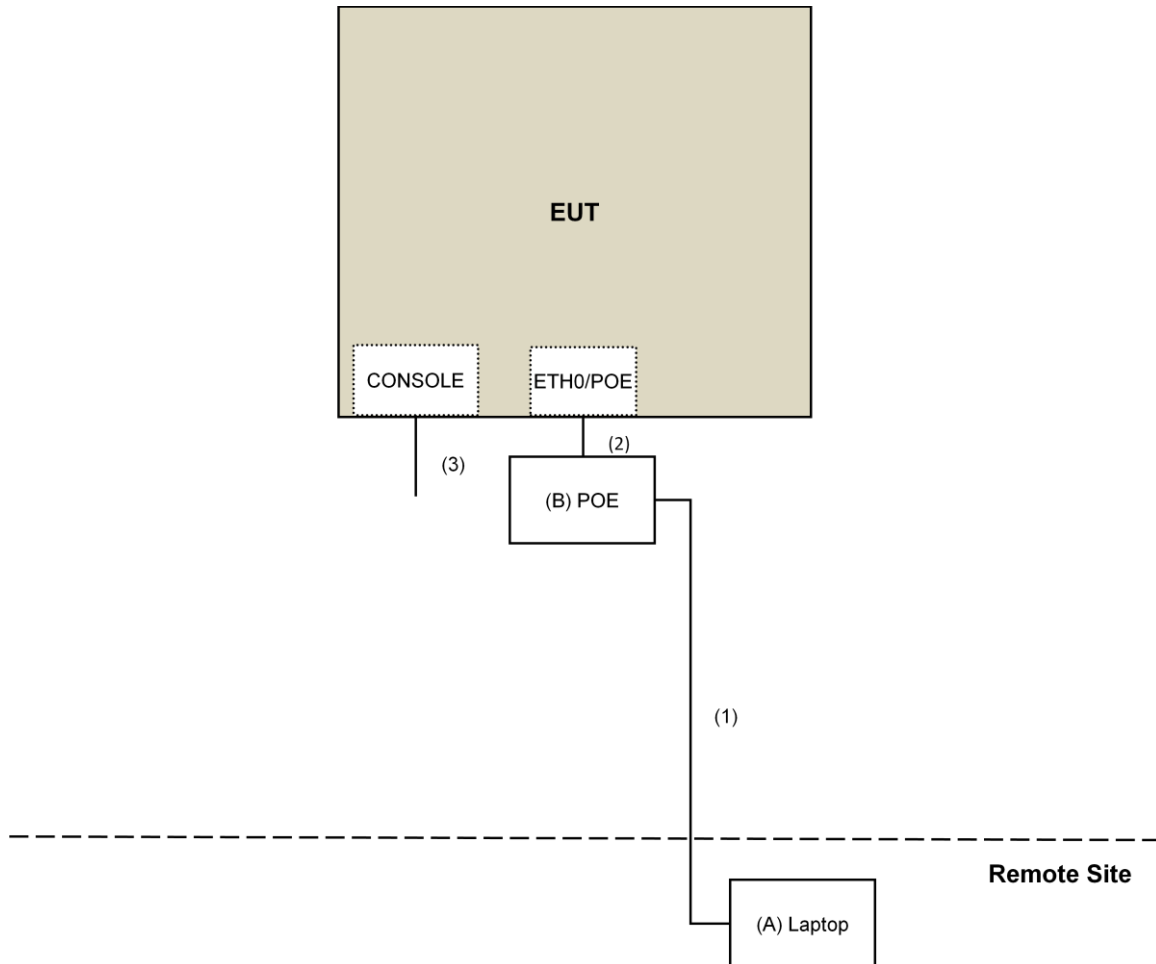

For other test:

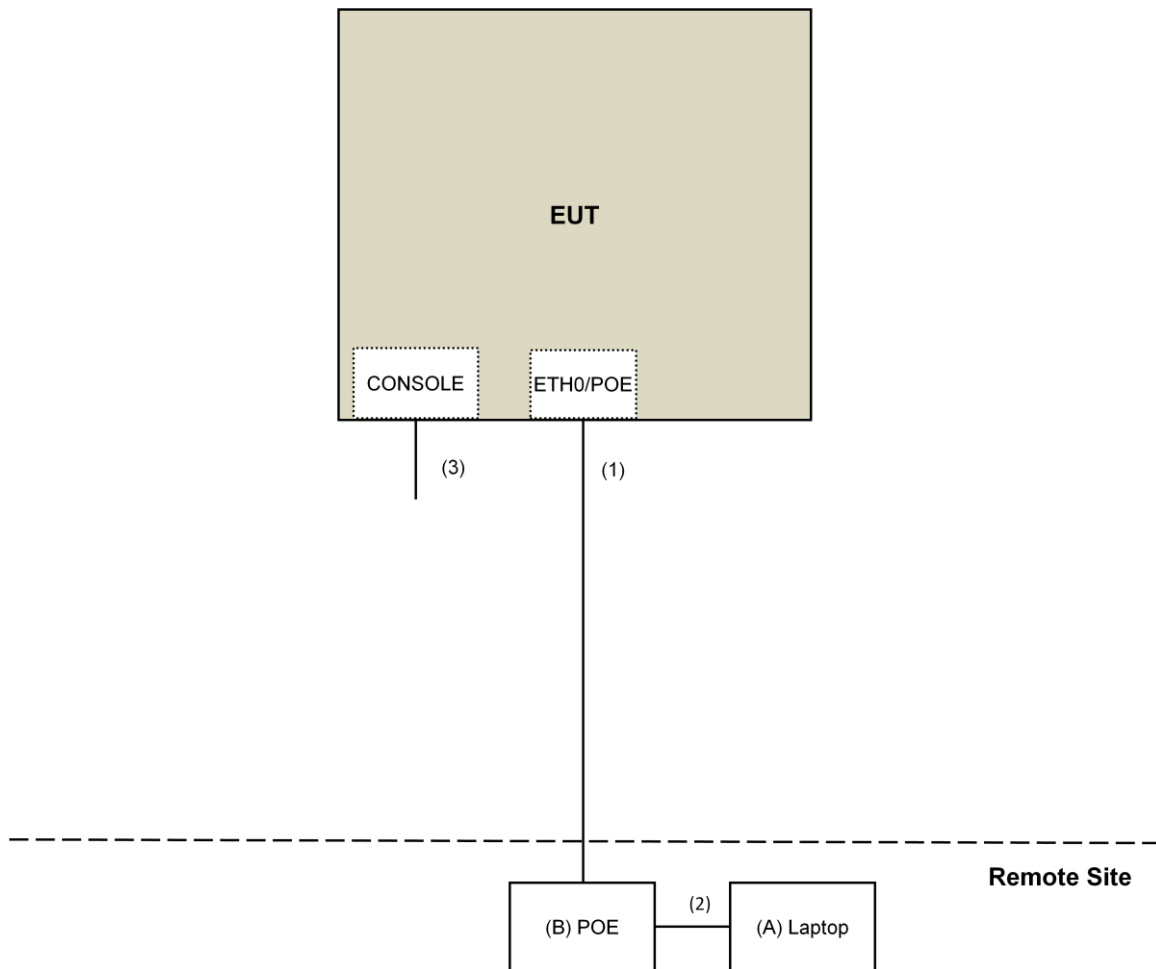

3.5 General Description of Applied Standard

The EUT is a RF Product. According to the specifications of the manufacturer, it must comply with the requirements of the following standards:

FCC Part 15, Subpart E (15.407)
KDB 789033 D02 General UNII Test Procedure New Rules v01r04
KDB 662911 D01 Multiple Transmitter Output v02r01
ANSI C63.10-2013

All test items have been performed and recorded as per the above standards.

NOTE: The EUT has been verified to comply with the requirements of FCC Part 15, Subpart B, Class B (DoC). The test report has been issued separately.

4 Test Types and Results

4.1 Radiated Emission and Bandedge Measurement

4.1.1 Limits of Radiated Emission and Bandedge Measurement

Radiated emissions which fall in the restricted bands must comply with the radiated emission limits specified as below table.

Frequencies (MHz)	Field Strength (microvolts/meter)	Measurement Distance (meters)
0.009 ~ 0.490	2400/F(kHz)	300
0.490 ~ 1.705	24000/F(kHz)	30
1.705 ~ 30.0	30	30
30 ~ 88	100	3
88 ~ 216	150	3
216 ~ 960	200	3
Above 960	500	3

NOTE:

1. The lower limit shall apply at the transition frequencies.
2. Emission level (dBuV/m) = 20 log Emission level (uV/m).
3. For frequencies above 1000MHz, the field strength limits are based on average detector, however, the peak field strength of any emission shall not exceed the maximum permitted average limits, specified above by more than 20dB under any condition of modulation.

Limits of unwanted emission out of the restricted bands

Applicable To		Limit	
789033 D02 General UNII Test Procedure New Rules v01r04		Field Strength at 3m	
		PK:74 (dBuV/m)	AV:54 (dBuV/m)
Frequency Band	Applicable To	EIRP Limit	Equivalent Field Strength at 3m
5150~5250 MHz	15.407(b)(1)	PK:-27 (dBm/MHz)	PK:68.2(dBuV/m)
5250~5350 MHz	15.407(b)(2)		
5470~5725 MHz	15.407(b)(3)		
5725~5850 MHz	<input checked="" type="checkbox"/> 15.407(b)(4)(i)	PK:-27 (dBm/MHz) ^{*1} PK:10 (dBm/MHz) ^{*2} PK:15.6 (dBm/MHz) ^{*3} PK:27 (dBm/MHz) ^{*4}	PK: 68.2(dBuV/m) ^{*1} PK:105.2 (dBuV/m) ^{*2} PK: 110.8(dBuV/m) ^{*3} PK:122.2 (dBuV/m) ^{*4}
	<input type="checkbox"/> 15.407(b)(4)(ii)	Emission limits in section 15.247(d)	
^{*1} beyond 75 MHz or more above of the band edge.		^{*2} below the band edge increasing linearly to 10 dBm/MHz at 25 MHz above.	
^{*3} below the band edge increasing linearly to a level of 15.6 dBm/MHz at 5 MHz above.		^{*4} from 5 MHz above or below the band edge increasing linearly to a level of 27 dBm/MHz at the band edge.	

Note:

The following formula is used to convert the equipment isotropic radiated power (eirp) to field strength:

$$E = \frac{1000000\sqrt{30P}}{3} \mu\text{V/m, where P is the eirp (Watts).}$$

4.1.2 Test Instruments

DESCRIPTION & MANUFACTURER	MODEL NO.	SERIAL NO.	CALIBRATED DATE	CALIBRATED UNTIL
Test Receiver Keysight	N9038A	MY54450088	July 20, 2016	July 19, 2017
Pre-Amplifier ^(*) EMCI	EMC001340	980142	Jan. 20, 2016	Jan. 19, 2018
Loop Antenna ^(*) Electro-Metrics	EM-6879	264	Dec. 16, 2016	Dec. 15, 2018
RF Cable	NA	LOOPCAB-001 LOOPCAB-002	Jan. 17, 2017	Jan. 16, 2018
Pre-Amplifier Mini-Circuits	ZFL-1000VH2B	AMP-ZFL-01	Nov. 10, 2016	Nov. 09, 2017
Trilog Broadband Antenna SCHWARZBECK	VULB 9168	9168-406	Dec. 13, 2016	Dec. 12, 2017
RF Cable	8D	966-4-1 966-4-2 966-4-3	Apr. 01, 2017	Mar. 31, 2018
Fixed attenuator Mini-Circuits	UNAT-5+	PAD-3m-4-01	Oct. 05, 2016	Oct. 04, 2017
Horn_Antenna SCHWARZBECK	BBHA 9120D	9120D-783	Dec. 27, 2016	Dec. 26, 2017
Pre-Amplifier EMCI	EMC12630SE	980385	Feb. 02, 2017	Feb. 01, 2018
RF Cable	EMC104-SM-SM-1200 EMC104-SM-SM-2000 EMC104-SM-SM-5000	160923 150318 150323	Feb. 02, 2017 Mar. 29, 2017 Mar. 29, 2017	Feb. 01, 2018 Mar. 28, 2018 Mar. 28, 2018
Pre-Amplifier EMCI	EMC184045SE	980387	Feb. 02, 2017	Feb. 01, 2018
Horn_Antenna SCHWARZBECK	BBHA 9170	BBHA9170608	Dec. 15, 2016	Dec. 14, 2017
RF Cable	SUCOFLEX 102	36432/2 36433/2	Jan. 15, 2017	Jan. 14, 2018
Software	ADT_Radiated_V8.7.08	NA	NA	NA
Antenna Tower & Turn Table Max-Full	MF-7802	MF780208410	NA	NA
Boresight Antenna Fixture	FBA-01	FBA-SIP02	NA	NA
Spectrum Analyzer R&S	FSv40	100964	June 28, 2016	June 27, 2017
Power meter Anritsu	ML2495A	0824006	May 26, 2016	May 25, 2017
Power sensor Anritsu	MA2411B	0738172	May 26, 2016	May 25, 2017

Note:

1. The calibration interval of the above test instruments is 12 months and the calibrations are traceable to NML/ROC and NIST/USA.
2. *The calibration interval of the above test instruments is 24 months and the calibrations are traceable to NML/ROC and NIST/USA.
3. The test was performed in 966 Chamber No. 4.
4. The FCC Site Registration No. is 292998
5. The CANADA Site Registration No. is 20331-2
- 6 Loop antenna was used for all emissions below 30 MHz.
7. Tested Date: Apr. 29 to May 05, 2017

4.1.3 Test Procedure

For Radiated emission below 30MHz

- a. The EUT was placed on the top of a rotating table 0.8 meters above the ground at a 3 meter chamber room. The table was rotated 360 degrees to determine the position of the highest radiation.
- b. The EUT was set 3 meters away from the interference-receiving antenna, which was mounted on the top of a variable-height antenna tower.
- c. Both X and Y axes of the antenna are set to make the measurement.
- d. For each suspected emission, the EUT was arranged to its worst case and the rotatable table was turned from 0 degrees to 360 degrees to find the maximum reading.
- e. The test-receiver system was set to Quasi-Peak Detect Function and Specified Bandwidth with Maximum Hold Mode.

NOTE:

1. The resolution bandwidth and video bandwidth of test receiver/spectrum analyzer is 9kHz at frequency below 30MHz.

For Radiated emission above 30MHz

- a. The EUT was placed on the top of a rotating table 0.8 meters (for 30MHz ~ 1GHz) / 1.5 meters (for above 1GHz) above the ground at 3 meter chamber room for test. The table was rotated 360 degrees to determine the position of the highest radiation.
- b. The EUT was set 3 meters away from the interference-receiving antenna, which was mounted on the top of a variable-height antenna tower.
- c. The height of antenna is varied from one meter to four meters above the ground to determine the maximum value of the field strength. Both horizontal and vertical polarizations of the antenna are set to make the measurement.
- d. For each suspected emission, the EUT was arranged to its worst case and then the antenna was tuned to heights from 1 meter to 4 meters and the rotatable table was turned from 0 degrees to 360 degrees to find the maximum reading.
- e. The test-receiver system was set to quasi-peak detect function and specified bandwidth with maximum hold mode when the test frequency is below 1 GHz.
- f. The test-receiver system was set to peak and average detect function and specified bandwidth with maximum hold mode when the test frequency is above 1 GHz. If the peak reading value also meets average limit, measurement with the average detector is unnecessary.

Note:

1. The resolution bandwidth and video bandwidth of test receiver/spectrum analyzer is 120kHz for Quasi-peak detection (QP) at frequency below 1GHz.
2. The resolution bandwidth of test receiver/spectrum analyzer is 1 MHz and the video bandwidth is 3 MHz for Peak detection (PK) at frequency above 1GHz.
3. The resolution bandwidth of test receiver/spectrum analyzer is 1MHz and the video bandwidth is $\geq 1/T$ (Duty cycle < 98%) or 10Hz (Duty cycle $\geq 98\%$) for Average detection (AV) at frequency above 1GHz.
4. All modes of operation were investigated and the worst-case emissions are reported.

4.1.4 Deviation from Test Standard

No deviation.

4.1.5 Test Setup

For Radiated emission below 30MHz

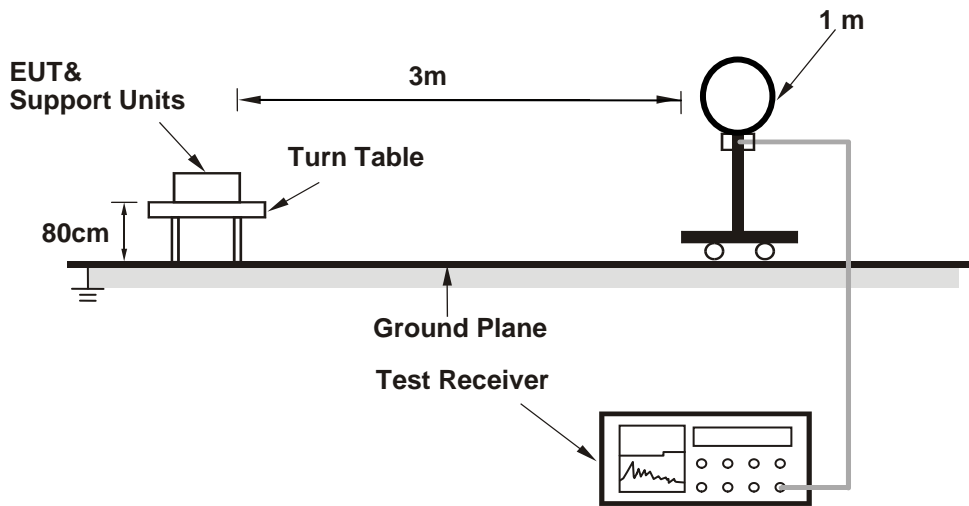

For Radiated emission 30MHz to 1GHz

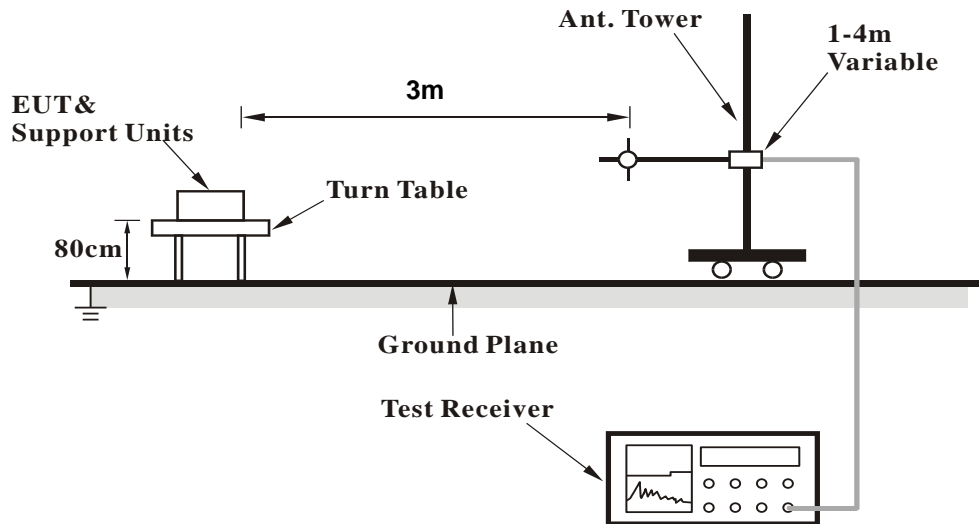

For Radiated emission above 1GHz

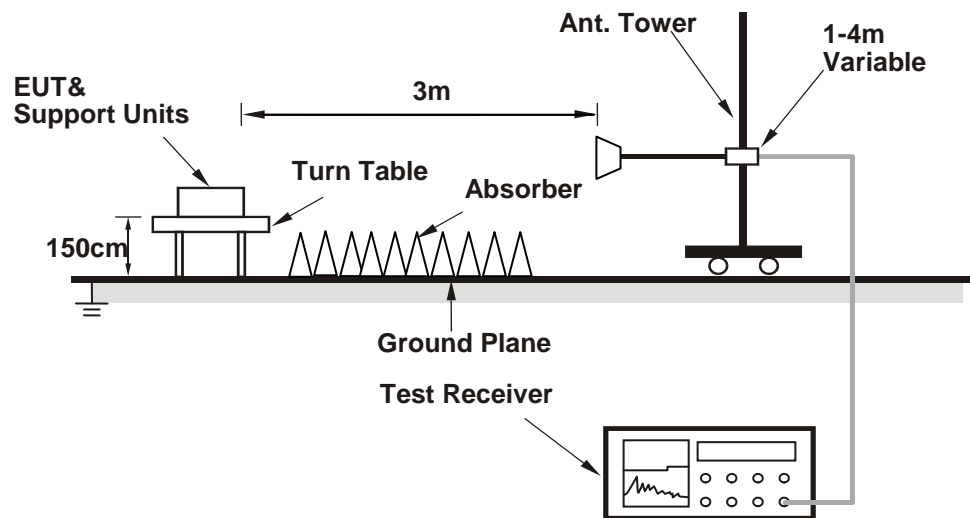

For the actual test configuration, please refer to the attached file (Test Setup Photo).

4.1.6 EUT Operating Condition

- a. Connected the EUT with the Laptop which is placed on remote site.
- b. Controlling software (QRCT_3.0.219.0) has been activated to set the EUT on specific status.

4.1.7 Test Results

2TX Mode

Radio 2

Above 1GHz Data:

802.11a

CHANNEL	TX Channel 52	DETECTOR FUNCTION	Peak (PK)
FREQUENCY RANGE	1GHz ~ 40GHz		Average (AV)

ANTENNA POLARITY & TEST DISTANCE: HORIZONTAL AT 3 M

NO.	FREQ. (MHz)	EMISSION LEVEL (dBuV/m)	LIMIT (dBuV/m)	MARGIN (dB)	ANTENNA HEIGHT (m)	TABLE ANGLE (Degree)	RAW VALUE (dBuV)	CORRECTION FACTOR (dB/m)
1	5150.00	50.4 PK	74.0	-23.6	1.00 H	66	46.4	4.0
2	5150.00	38.8 AV	54.0	-15.2	1.00 H	66	34.8	4.0
3	*5260.00	116.1 PK			1.00 H	66	111.9	4.2
4	*5260.00	105.2 AV			1.00 H	66	101.0	4.2
5	5350.00	49.1 PK	74.0	-24.9	1.00 H	66	44.7	4.4
6	5350.00	37.6 AV	54.0	-16.4	1.00 H	66	33.2	4.4
7	#10520.00	48.5 PK	74.0	-25.5	1.00 H	284	34.7	13.8
8	#10520.00	37.0 AV	54.0	-17.0	1.00 H	284	23.2	13.8
9	15780.00	44.9 PK	74.0	-29.1	1.58 H	34	30.8	14.1
10	15780.00	32.8 AV	54.0	-21.2	1.58 H	34	18.7	14.1

ANTENNA POLARITY & TEST DISTANCE: VERTICAL AT 3 M

NO.	FREQ. (MHz)	EMISSION LEVEL (dBuV/m)	LIMIT (dBuV/m)	MARGIN (dB)	ANTENNA HEIGHT (m)	TABLE ANGLE (Degree)	RAW VALUE (dBuV)	CORRECTION FACTOR (dB/m)
1	5150.00	50.1 PK	74.0	-23.9	1.09 V	112	46.1	4.0
2	5150.00	37.5 AV	54.0	-16.5	1.09 V	112	33.5	4.0
3	*5260.00	106.4 PK			1.09 V	112	102.2	4.2
4	*5260.00	96.5 AV			1.09 V	112	92.3	4.2
5	5350.00	49.9 PK	74.0	-24.1	1.09 V	112	45.5	4.4
6	5350.00	37.3 AV	54.0	-16.7	1.09 V	112	32.9	4.4
7	#10520.00	50.8 PK	74.0	-23.2	2.05 V	350	37.0	13.8
8	#10520.00	38.8 AV	54.0	-15.2	2.05 V	350	25.0	13.8
9	15780.00	46.6 PK	74.0	-27.4	1.63 V	117	32.5	14.1
10	15780.00	33.8 AV	54.0	-20.2	1.63 V	117	19.7	14.1

REMARKS:

1. Emission Level(dBuV/m) = Raw Value(dBuV) + Correction Factor(dB/m)
2. Correction Factor(dB/m) = Antenna Factor(dB/m) + Cable Factor(dB) – Pre-Amplifier Factor(dB)
3. The other emission levels were very low against the limit.
4. Margin value = Emission Level – Limit value
5. " * ": Fundamental frequency.
6. " # ": The radiated frequency is out of the restricted band.

CHANNEL	TX Channel 60	DETECTOR FUNCTION	Peak (PK)
FREQUENCY RANGE	1GHz ~ 40GHz		Average (AV)

ANTENNA POLARITY & TEST DISTANCE: HORIZONTAL AT 3 M

NO.	FREQ. (MHz)	EMISSION LEVEL (dBuV/m)	LIMIT (dBuV/m)	MARGIN (dB)	ANTENNA HEIGHT (m)	TABLE ANGLE (Degree)	RAW VALUE (dBuV)	CORRECTION FACTOR (dB/m)
1	*5300.00	115.3 PK			1.00 H	65	111.0	4.3
2	*5300.00	104.6 AV			1.00 H	65	100.3	4.3
3	5350.00	52.7 PK	74.0	-21.3	1.00 H	65	48.3	4.4
4	5350.00	41.0 AV	54.0	-13.0	1.00 H	65	36.6	4.4
5	10600.00	50.5 PK	74.0	-23.5	1.01 H	280	36.7	13.8
6	10600.00	38.6 AV	54.0	-15.4	1.01 H	280	24.8	13.8
7	15900.00	45.2 PK	74.0	-28.8	1.53 H	35	32.0	13.2
8	15900.00	33.1 AV	54.0	-20.9	1.53 H	35	19.9	13.2

ANTENNA POLARITY & TEST DISTANCE: VERTICAL AT 3 M

NO.	FREQ. (MHz)	EMISSION LEVEL (dBuV/m)	LIMIT (dBuV/m)	MARGIN (dB)	ANTENNA HEIGHT (m)	TABLE ANGLE (Degree)	RAW VALUE (dBuV)	CORRECTION FACTOR (dB/m)
1	*5300.00	106.1 PK			1.08 V	110	101.8	4.3
2	*5300.00	96.4 AV			1.08 V	110	92.1	4.3
3	5350.00	50.5 PK	74.0	-23.5	1.08 V	110	46.1	4.4
4	5350.00	37.4 AV	54.0	-16.6	1.08 V	110	33.0	4.4
5	10600.00	51.5 PK	74.0	-22.5	2.05 V	360	37.7	13.8
6	10600.00	40.0 AV	54.0	-14.0	2.05 V	360	26.2	13.8
7	15900.00	46.7 PK	74.0	-27.3	1.58 V	132	33.5	13.2
8	15900.00	34.3 AV	54.0	-19.7	1.58 V	132	21.1	13.2

REMARKS:

1. Emission Level(dBuV/m) = Raw Value(dBuV) + Correction Factor(dB/m)
2. Correction Factor(dB/m) = Antenna Factor(dB/m) + Cable Factor(dB) – Pre-Amplifier Factor(dB)
3. The other emission levels were very low against the limit.
4. Margin value = Emission Level – Limit value
5. " * ": Fundamental frequency.

CHANNEL	TX Channel 64	DETECTOR FUNCTION	Peak (PK)
FREQUENCY RANGE	1GHz ~ 40GHz		Average (AV)

ANTENNA POLARITY & TEST DISTANCE: HORIZONTAL AT 3 M

NO.	FREQ. (MHz)	EMISSION LEVEL (dBuV/m)	LIMIT (dBuV/m)	MARGIN (dB)	ANTENNA HEIGHT (m)	TABLE ANGLE (Degree)	RAW VALUE (dBuV)	CORRECTION FACTOR (dB/m)
1	*5320.00	115.3 PK			1.00 H	64	111.0	4.3
2	*5320.00	104.1 AV			1.00 H	64	99.8	4.3
3	5350.00	66.7 PK	74.0	-7.3	1.00 H	64	62.3	4.4
4	5350.00	52.1 AV	54.0	-1.9	1.00 H	64	47.7	4.4
5	10640.00	50.0 PK	74.0	-24.0	1.00 H	300	36.0	14.0
6	10640.00	38.3 AV	54.0	-15.7	1.00 H	300	24.3	14.0
7	15960.00	45.3 PK	74.0	-28.7	1.50 H	37	31.8	13.5
8	15960.00	33.2 AV	54.0	-20.8	1.50 H	37	19.7	13.5

ANTENNA POLARITY & TEST DISTANCE: VERTICAL AT 3 M

NO.	FREQ. (MHz)	EMISSION LEVEL (dBuV/m)	LIMIT (dBuV/m)	MARGIN (dB)	ANTENNA HEIGHT (m)	TABLE ANGLE (Degree)	RAW VALUE (dBuV)	CORRECTION FACTOR (dB/m)
1	*5320.00	105.7 PK			1.04 V	107	101.4	4.3
2	*5320.00	96.1 AV			1.04 V	107	91.8	4.3
3	5350.00	59.5 PK	74.0	-14.5	1.04 V	107	55.1	4.4
4	5350.00	45.5 AV	54.0	-8.5	1.04 V	107	41.1	4.4
5	10640.00	52.8 PK	74.0	-21.2	2.08 V	360	38.8	14.0
6	10640.00	40.9 AV	54.0	-13.1	2.08 V	360	26.9	14.0
7	15960.00	47.1 PK	74.0	-26.9	1.61 V	131	33.6	13.5
8	15960.00	34.6 AV	54.0	-19.4	1.61 V	131	21.1	13.5

REMARKS:

1. Emission Level(dBuV/m) = Raw Value(dBuV) + Correction Factor(dB/m)
2. Correction Factor(dB/m) = Antenna Factor(dB/m) + Cable Factor(dB) – Pre-Amplifier Factor(dB)
3. The other emission levels were very low against the limit.
4. Margin value = Emission Level – Limit value
5. " * ": Fundamental frequency.

802.11ac (VHT20)

CHANNEL	TX Channel 52	DETECTOR FUNCTION	Peak (PK)
FREQUENCY RANGE	1GHz ~ 40GHz		Average (AV)

ANTENNA POLARITY & TEST DISTANCE: HORIZONTAL AT 3 M

NO.	FREQ. (MHz)	EMISSION LEVEL (dBuV/m)	LIMIT (dBuV/m)	MARGIN (dB)	ANTENNA HEIGHT (m)	TABLE ANGLE (Degree)	RAW VALUE (dBuV)	CORRECTION FACTOR (dB/m)
1	5150.00	49.5 PK	74.0	-24.5	1.00 H	63	45.5	4.0
2	5150.00	37.7 AV	54.0	-16.3	1.00 H	63	33.7	4.0
3	*5260.00	116.4 PK			1.00 H	63	112.2	4.2
4	*5260.00	105.9 AV			1.00 H	63	101.7	4.2
5	#10520.00	52.5 PK	74.0	-21.5	2.26 H	165	38.7	13.8
6	#10520.00	39.7 AV	54.0	-14.3	2.26 H	165	25.9	13.8
7	15780.00	44.8 PK	74.0	-29.2	1.54 H	42	30.7	14.1
8	15780.00	33.1 AV	54.0	-20.9	1.54 H	42	19.0	14.1

ANTENNA POLARITY & TEST DISTANCE: VERTICAL AT 3 M

NO.	FREQ. (MHz)	EMISSION LEVEL (dBuV/m)	LIMIT (dBuV/m)	MARGIN (dB)	ANTENNA HEIGHT (m)	TABLE ANGLE (Degree)	RAW VALUE (dBuV)	CORRECTION FACTOR (dB/m)
1	5150.00	49.7 PK	74.0	-24.3	1.10 V	104	45.7	4.0
2	5150.00	37.3 AV	54.0	-16.7	1.10 V	104	33.3	4.0
3	*5260.00	107.2 PK			1.10 V	104	103.0	4.2
4	*5260.00	97.5 AV			1.10 V	104	93.3	4.2
5	#10520.00	54.1 PK	74.0	-19.9	1.63 V	166	40.3	13.8
6	#10520.00	41.2 AV	54.0	-12.8	1.63 V	166	27.4	13.8
7	15780.00	46.0 PK	74.0	-28.0	1.01 V	123	31.9	14.1
8	15780.00	33.9 AV	54.0	-20.1	1.01 V	123	19.8	14.1

REMARKS:

- Emission Level(dBuV/m) = Raw Value(dBuV) + Correction Factor(dB/m)
- Correction Factor(dB/m) = Antenna Factor(dB/m) + Cable Factor(dB) – Pre-Amplifier Factor(dB)
- The other emission levels were very low against the limit.
- Margin value = Emission Level – Limit value
- " * ": Fundamental frequency.
- " # ": The radiated frequency is out of the restricted band.

CHANNEL	TX Channel 60	DETECTOR FUNCTION	Peak (PK)
FREQUENCY RANGE	1GHz ~ 40GHz		Average (AV)

ANTENNA POLARITY & TEST DISTANCE: HORIZONTAL AT 3 M

NO.	FREQ. (MHz)	EMISSION LEVEL (dBuV/m)	LIMIT (dBuV/m)	MARGIN (dB)	ANTENNA HEIGHT (m)	TABLE ANGLE (Degree)	RAW VALUE (dBuV)	CORRECTION FACTOR (dB/m)
1	*5300.00	115.5 PK			1.00 H	64	111.2	4.3
2	*5300.00	105.5 AV			1.00 H	64	101.2	4.3
3	5350.00	50.4 PK	74.0	-23.6	1.00 H	64	46.0	4.4
4	5350.00	38.5 AV	54.0	-15.5	1.00 H	64	34.1	4.4
5	10600.00	53.2 PK	74.0	-20.8	2.24 H	153	39.4	13.8
6	10600.00	40.3 AV	54.0	-13.7	2.24 H	153	26.5	13.8
7	15900.00	44.7 PK	74.0	-29.3	1.51 H	32	31.5	13.2
8	15900.00	33.1 AV	54.0	-20.9	1.51 H	32	19.9	13.2

ANTENNA POLARITY & TEST DISTANCE: VERTICAL AT 3 M

NO.	FREQ. (MHz)	EMISSION LEVEL (dBuV/m)	LIMIT (dBuV/m)	MARGIN (dB)	ANTENNA HEIGHT (m)	TABLE ANGLE (Degree)	RAW VALUE (dBuV)	CORRECTION FACTOR (dB/m)
1	*5300.00	106.4 PK			1.09 V	106	102.1	4.3
2	*5300.00	96.9 AV			1.09 V	106	92.6	4.3
3	5350.00	50.1 PK	74.0	-23.9	1.09 V	106	45.7	4.4
4	5350.00	37.7 AV	54.0	-16.3	1.09 V	106	33.3	4.4
5	10600.00	54.2 PK	74.0	-19.8	1.63 V	154	40.4	13.8
6	10600.00	41.5 AV	54.0	-12.5	1.63 V	154	27.7	13.8
7	15900.00	45.8 PK	74.0	-28.2	1.04 V	118	32.6	13.2
8	15900.00	33.8 AV	54.0	-20.2	1.04 V	118	20.6	13.2

REMARKS:

1. Emission Level(dBuV/m) = Raw Value(dBuV) + Correction Factor(dB/m)
2. Correction Factor(dB/m) = Antenna Factor(dB/m) + Cable Factor(dB) – Pre-Amplifier Factor(dB)
3. The other emission levels were very low against the limit.
4. Margin value = Emission Level – Limit value
5. " * ": Fundamental frequency.

CHANNEL	TX Channel 64	DETECTOR FUNCTION	Peak (PK)
FREQUENCY RANGE	1GHz ~ 40GHz		Average (AV)

ANTENNA POLARITY & TEST DISTANCE: HORIZONTAL AT 3 M

NO.	FREQ. (MHz)	EMISSION LEVEL (dBuV/m)	LIMIT (dBuV/m)	MARGIN (dB)	ANTENNA HEIGHT (m)	TABLE ANGLE (Degree)	RAW VALUE (dBuV)	CORRECTION FACTOR (dB/m)
1	*5320.00	116.0 PK			1.00 H	59	111.7	4.3
2	*5320.00	105.3 AV			1.00 H	59	101.0	4.3
3	5350.00	68.7 PK	74.0	-5.3	1.00 H	59	64.3	4.4
4	5350.00	50.7 AV	54.0	-3.3	1.00 H	59	46.3	4.4
5	10640.00	54.1 PK	74.0	-19.9	2.24 H	158	40.1	14.0
6	10640.00	41.8 AV	54.0	-12.2	2.24 H	158	27.8	14.0
7	15960.00	44.7 PK	74.0	-29.3	1.59 H	43	31.2	13.5
8	15960.00	33.0 AV	54.0	-21.0	1.59 H	43	19.5	13.5

ANTENNA POLARITY & TEST DISTANCE: VERTICAL AT 3 M

NO.	FREQ. (MHz)	EMISSION LEVEL (dBuV/m)	LIMIT (dBuV/m)	MARGIN (dB)	ANTENNA HEIGHT (m)	TABLE ANGLE (Degree)	RAW VALUE (dBuV)	CORRECTION FACTOR (dB/m)
1	*5320.00	105.9 PK			1.02 V	124	101.6	4.3
2	*5320.00	96.4 AV			1.02 V	124	92.1	4.3
3	5350.00	61.1 PK	74.0	-12.9	1.02 V	124	56.7	4.4
4	5350.00	43.1 AV	54.0	-10.9	1.02 V	124	38.7	4.4
5	10640.00	55.5 PK	74.0	-18.5	1.65 V	158	41.5	14.0
6	10640.00	43.0 AV	54.0	-11.0	1.65 V	158	29.0	14.0
7	15960.00	45.6 PK	74.0	-28.4	1.01 V	109	32.1	13.5
8	15960.00	33.7 AV	54.0	-20.3	1.01 V	109	20.2	13.5

REMARKS:

1. Emission Level(dBuV/m) = Raw Value(dBuV) + Correction Factor(dB/m)
2. Correction Factor(dB/m) = Antenna Factor(dB/m) + Cable Factor(dB) – Pre-Amplifier Factor(dB)
3. The other emission levels were very low against the limit.
4. Margin value = Emission Level – Limit value
5. " * ": Fundamental frequency.

802.11ac (VHT40)

CHANNEL	TX Channel 38	DETECTOR FUNCTION	Peak (PK)
FREQUENCY RANGE	1GHz ~ 40GHz		Average (AV)

ANTENNA POLARITY & TEST DISTANCE: HORIZONTAL AT 3 M

NO.	FREQ. (MHz)	EMISSION LEVEL (dBuV/m)	LIMIT (dBuV/m)	MARGIN (dB)	ANTENNA HEIGHT (m)	TABLE ANGLE (Degree)	RAW VALUE (dBuV)	CORRECTION FACTOR (dB/m)
1	5150.00	66.6 PK	74.0	-7.4	1.03 H	62	62.6	4.0
2	5150.00	53.8 AV	54.0	-0.2	1.03 H	62	49.8	4.0
3	*5190.00	110.0 PK			1.03 H	62	106.0	4.0
4	*5190.00	99.9 AV			1.03 H	62	95.9	4.0
5	5350.00	47.9 PK	74.0	-26.1	1.03 H	62	43.5	4.4
6	5350.00	35.5 AV	54.0	-18.5	1.03 H	62	31.1	4.4
7	#10380.00	48.3 PK	74.0	-25.7	2.15 H	170	34.7	13.6
8	#10380.00	36.1 AV	54.0	-17.9	2.15 H	170	22.5	13.6
9	15570.00	45.4 PK	74.0	-28.6	1.49 H	55	32.1	13.3
10	15570.00	33.7 AV	54.0	-20.3	1.49 H	55	20.4	13.3

ANTENNA POLARITY & TEST DISTANCE: VERTICAL AT 3 M

NO.	FREQ. (MHz)	EMISSION LEVEL (dBuV/m)	LIMIT (dBuV/m)	MARGIN (dB)	ANTENNA HEIGHT (m)	TABLE ANGLE (Degree)	RAW VALUE (dBuV)	CORRECTION FACTOR (dB/m)
1	5150.00	59.9 PK	74.0	-14.1	1.30 V	118	55.9	4.0
2	5150.00	48.4 AV	54.0	-5.6	1.30 V	118	44.4	4.0
3	*5190.00	102.1 PK			1.30 V	118	98.1	4.0
4	*5190.00	91.3 AV			1.30 V	118	87.3	4.0
5	5350.00	47.4 PK	74.0	-26.6	1.30 V	118	43.0	4.4
6	5350.00	35.2 AV	54.0	-18.8	1.30 V	118	30.8	4.4
7	#10380.00	49.8 PK	74.0	-24.2	1.67 V	187	36.2	13.6
8	#10380.00	37.2 AV	54.0	-16.8	1.67 V	187	23.6	13.6
9	15570.00	45.0 PK	74.0	-29.0	1.00 V	113	31.7	13.3
10	15570.00	33.3 AV	54.0	-20.7	1.00 V	113	20.0	13.3

REMARKS:

- Emission Level(dBuV/m) = Raw Value(dBuV) + Correction Factor(dB/m)
- Correction Factor(dB/m) = Antenna Factor(dB/m) + Cable Factor(dB) – Pre-Amplifier Factor(dB)
- The other emission levels were very low against the limit.
- Margin value = Emission Level – Limit value
- " * ": Fundamental frequency.
- " # ": The radiated frequency is out of the restricted band.

CHANNEL	TX Channel 46	DETECTOR FUNCTION	Peak (PK)
FREQUENCY RANGE	1GHz ~ 40GHz		Average (AV)

ANTENNA POLARITY & TEST DISTANCE: HORIZONTAL AT 3 M

NO.	FREQ. (MHz)	EMISSION LEVEL (dBuV/m)	LIMIT (dBuV/m)	MARGIN (dB)	ANTENNA HEIGHT (m)	TABLE ANGLE (Degree)	RAW VALUE (dBuV)	CORRECTION FACTOR (dB/m)
1	5150.00	65.3 PK	74.0	-8.7	1.00 H	65	61.3	4.0
2	5150.00	52.8 AV	54.0	-1.2	1.00 H	65	48.8	4.0
3	*5230.00	113.9 PK			1.00 H	65	109.7	4.2
4	*5230.00	103.0 AV			1.00 H	65	98.8	4.2
5	5350.00	47.9 PK	74.0	-26.1	1.00 H	65	43.5	4.4
6	5350.00	36.0 AV	54.0	-18.0	1.00 H	65	31.6	4.4
7	#10460.00	52.0 PK	74.0	-22.0	2.20 H	162	38.3	13.7
8	#10460.00	39.7 AV	54.0	-14.3	2.20 H	162	26.0	13.7
9	15690.00	45.4 PK	74.0	-28.6	1.51 H	55	31.4	14.0
10	15690.00	33.5 AV	54.0	-20.5	1.51 H	55	19.5	14.0

ANTENNA POLARITY & TEST DISTANCE: VERTICAL AT 3 M

NO.	FREQ. (MHz)	EMISSION LEVEL (dBuV/m)	LIMIT (dBuV/m)	MARGIN (dB)	ANTENNA HEIGHT (m)	TABLE ANGLE (Degree)	RAW VALUE (dBuV)	CORRECTION FACTOR (dB/m)
1	5150.00	58.5 PK	74.0	-15.5	1.31 V	121	54.5	4.0
2	5150.00	47.3 AV	54.0	-6.7	1.31 V	121	43.3	4.0
3	*5230.00	104.2 PK			1.31 V	121	100.0	4.2
4	*5230.00	94.6 AV			1.31 V	121	90.4	4.2
5	5350.00	49.8 PK	74.0	-24.2	1.31 V	121	45.4	4.4
6	5350.00	37.1 AV	54.0	-16.9	1.31 V	121	32.7	4.4
7	#10460.00	53.5 PK	74.0	-20.5	1.69 V	182	39.8	13.7
8	#10460.00	41.1 AV	54.0	-12.9	1.69 V	182	27.4	13.7
9	15690.00	45.7 PK	74.0	-28.3	1.00 V	105	31.7	14.0
10	15690.00	33.8 AV	54.0	-20.2	1.00 V	105	19.8	14.0

REMARKS:

1. Emission Level(dBuV/m) = Raw Value(dBuV) + Correction Factor(dB/m)
2. Correction Factor(dB/m) = Antenna Factor(dB/m) + Cable Factor(dB) – Pre-Amplifier Factor(dB)
3. The other emission levels were very low against the limit.
4. Margin value = Emission Level – Limit value
5. " * ": Fundamental frequency.
6. " # ": The radiated frequency is out of the restricted band.

802.11ac (VHT80)

CHANNEL	TX Channel 58	DETECTOR FUNCTION	Peak (PK)
FREQUENCY RANGE	1GHz ~ 40GHz		Average (AV)

ANTENNA POLARITY & TEST DISTANCE: HORIZONTAL AT 3 M

NO.	FREQ. (MHz)	EMISSION LEVEL (dBuV/m)	LIMIT (dBuV/m)	MARGIN (dB)	ANTENNA HEIGHT (m)	TABLE ANGLE (Degree)	RAW VALUE (dBuV)	CORRECTION FACTOR (dB/m)
1	5150.00	62.4 PK	74.0	-11.6	1.00 H	61	58.4	4.0
2	5150.00	49.0 AV	54.0	-5.0	1.00 H	61	45.0	4.0
3	*5290.00	108.8 PK			1.00 H	61	104.5	4.3
4	*5290.00	99.8 AV			1.00 H	61	95.5	4.3
5	5350.00	62.6 PK	74.0	-11.4	1.00 H	61	58.2	4.4
6	5350.00	53.9 AV	54.0	-0.1	1.00 H	61	49.5	4.4
7	#10580.00	48.1 PK	74.0	-25.9	2.25 H	181	34.2	13.9
8	#10580.00	34.0 AV	54.0	-20.0	2.25 H	181	20.1	13.9
9	15870.00	45.2 PK	74.0	-28.8	1.44 H	59	31.8	13.4
10	15870.00	33.1 AV	54.0	-20.9	1.44 H	59	19.7	13.4

ANTENNA POLARITY & TEST DISTANCE: VERTICAL AT 3 M

NO.	FREQ. (MHz)	EMISSION LEVEL (dBuV/m)	LIMIT (dBuV/m)	MARGIN (dB)	ANTENNA HEIGHT (m)	TABLE ANGLE (Degree)	RAW VALUE (dBuV)	CORRECTION FACTOR (dB/m)
1	5150.00	55.3 PK	74.0	-18.7	1.29 V	115	51.3	4.0
2	5150.00	42.5 AV	54.0	-11.5	1.29 V	115	38.5	4.0
3	*5290.00	101.2 PK			1.29 V	115	96.9	4.3
4	*5290.00	92.2 AV			1.29 V	115	87.9	4.3
5	5350.00	55.8 PK	74.0	-18.2	1.29 V	115	51.4	4.4
6	5350.00	46.8 AV	54.0	-7.2	1.29 V	115	42.4	4.4
7	#10580.00	47.5 PK	74.0	-26.5	1.71 V	178	33.6	13.9
8	#10580.00	34.1 AV	54.0	-19.9	1.71 V	178	20.2	13.9
9	15870.00	45.3 PK	74.0	-28.7	1.00 V	122	31.9	13.4
10	15870.00	33.3 AV	54.0	-20.7	1.00 V	122	19.9	13.4

REMARKS:

- Emission Level(dBuV/m) = Raw Value(dBuV) + Correction Factor(dB/m)
- Correction Factor(dB/m) = Antenna Factor(dB/m) + Cable Factor(dB) – Pre-Amplifier Factor(dB)
- The other emission levels were very low against the limit.
- Margin value = Emission Level – Limit value
- " * ": Fundamental frequency.
- " # ": The radiated frequency is out of the restricted band.

Below 1GHz Data:

802.11ac (VHT40)

CHANNEL	TX Channel 54	DETECTOR FUNCTION	Quasi-Peak (QP)
FREQUENCY RANGE	9kHz ~ 1GHz		

ANTENNA POLARITY & TEST DISTANCE: HORIZONTAL AT 3 M

NO.	FREQ. (MHz)	EMISSION LEVEL (dBuV/m)	LIMIT (dBuV/m)	MARGIN (dB)	ANTENNA HEIGHT (m)	TABLE ANGLE (Degree)	RAW VALUE (dBuV)	CORRECTION FACTOR (dB/m)
1	31.16	36.7 QP	40.0	-3.3	1.00 H	360	46.2	-9.5
2	61.09	31.7 QP	40.0	-8.3	2.00 H	63	40.5	-8.8
3	99.77	29.8 QP	43.5	-13.7	2.00 H	101	42.6	-12.8
4	164.88	31.3 QP	43.5	-12.2	2.00 H	109	39.4	-8.1
5	225.02	32.1 QP	46.0	-13.9	1.00 H	150	43.7	-11.6
6	375.00	31.0 QP	46.0	-15.0	1.00 H	335	36.8	-5.8

ANTENNA POLARITY & TEST DISTANCE: VERTICAL AT 3 M

NO.	FREQ. (MHz)	EMISSION LEVEL (dBuV/m)	LIMIT (dBuV/m)	MARGIN (dB)	ANTENNA HEIGHT (m)	TABLE ANGLE (Degree)	RAW VALUE (dBuV)	CORRECTION FACTOR (dB/m)
1	38.04	36.8 QP	40.0	-3.2	1.00 V	302	45.1	-8.3
2	84.08	36.3 QP	40.0	-3.7	2.00 V	360	50.1	-13.8
3	225.02	32.5 QP	46.0	-13.5	2.00 V	360	44.1	-11.6
4	275.00	25.5 QP	46.0	-20.5	1.00 V	56	33.8	-8.3
5	374.98	35.3 QP	46.0	-10.7	2.00 V	360	41.1	-5.8
6	500.01	28.3 QP	46.0	-17.7	2.00 V	51	31.1	-2.8

REMARKS:

1. Emission Level(dBuV/m) = Raw Value(dBuV) + Correction Factor(dB/m)
2. Correction Factor(dB/m) = Antenna Factor(dB/m) + Cable Factor(dB) – Pre-Amplifier Factor(dB)
3. The other emission levels were very low against the limit.
4. Margin value = Emission Level – Limit value

Radio 1
Above 1GHz Data:
802.11a

CHANNEL	TX Channel 100	DETECTOR FUNCTION	Peak (PK)
FREQUENCY RANGE	1GHz ~ 40GHz		Average (AV)

ANTENNA POLARITY & TEST DISTANCE: HORIZONTAL AT 3 M

NO.	FREQ. (MHz)	EMISSION LEVEL (dBuV/m)	LIMIT (dBuV/m)	MARGIN (dB)	ANTENNA HEIGHT (m)	TABLE ANGLE (Degree)	RAW VALUE (dBuV)	CORRECTION FACTOR (dB/m)
1	#5470.00	60.7 PK	74.0	-13.3	2.99 H	290	56.2	4.5
2	#5470.00	49.2 AV	54.0	-4.8	2.99 H	290	44.7	4.5
3	*5500.00	115.2 PK			2.99 H	290	110.7	4.5
4	*5500.00	104.4 AV			2.99 H	290	99.9	4.5
5	11000.00	58.2 PK	74.0	-15.8	2.13 H	155	43.4	14.8
6	11000.00	45.4 AV	54.0	-8.6	2.13 H	155	30.6	14.8
7	#16500.00	51.7 PK	74.0	-22.3	1.66 H	145	36.1	15.6
8	#16500.00	38.5 AV	54.0	-15.5	1.66 H	145	22.9	15.6

ANTENNA POLARITY & TEST DISTANCE: VERTICAL AT 3 M

NO.	FREQ. (MHz)	EMISSION LEVEL (dBuV/m)	LIMIT (dBuV/m)	MARGIN (dB)	ANTENNA HEIGHT (m)	TABLE ANGLE (Degree)	RAW VALUE (dBuV)	CORRECTION FACTOR (dB/m)
1	#5470.00	54.8 PK	74.0	-19.2	1.09 V	210	50.3	4.5
2	#5470.00	43.1 AV	54.0	-10.9	1.09 V	210	38.6	4.5
3	*5500.00	105.1 PK			1.09 V	210	100.6	4.5
4	*5500.00	94.2 AV			1.09 V	210	89.7	4.5
5	11000.00	55.3 PK	74.0	-18.7	2.98 V	130	40.5	14.8
6	11000.00	43.4 AV	54.0	-10.6	2.98 V	130	28.6	14.8
7	#16500.00	50.7 PK	74.0	-23.3	2.49 V	147	35.1	15.6
8	#16500.00	38.7 AV	54.0	-15.3	2.49 V	147	23.1	15.6

REMARKS:

- Emission Level(dBuV/m) = Raw Value(dBuV) + Correction Factor(dB/m)
- Correction Factor(dB/m) = Antenna Factor(dB/m) + Cable Factor(dB) – Pre-Amplifier Factor(dB)
- The other emission levels were very low against the limit.
- Margin value = Emission Level – Limit value
- " * ": Fundamental frequency.
- " # ": The radiated frequency is out of the restricted band.

CHANNEL	TX Channel 116	DETECTOR FUNCTION	Peak (PK)
FREQUENCY RANGE	1GHz ~ 40GHz		Average (AV)

ANTENNA POLARITY & TEST DISTANCE: HORIZONTAL AT 3 M

NO.	FREQ. (MHz)	EMISSION LEVEL (dBuV/m)	LIMIT (dBuV/m)	MARGIN (dB)	ANTENNA HEIGHT (m)	TABLE ANGLE (Degree)	RAW VALUE (dBuV)	CORRECTION FACTOR (dB/m)
1	*5580.00	112.5 PK			2.97 H	294	107.9	4.6
2	*5580.00	102.7 AV			2.97 H	294	98.1	4.6
3	11160.00	57.8 PK	74.0	-16.2	2.07 H	161	43.4	14.4
4	11160.00	45.1 AV	54.0	-8.9	2.07 H	161	30.7	14.4
5	#16740.00	51.6 PK	74.0	-22.4	1.71 H	135	35.1	16.5
6	#16740.00	38.7 AV	54.0	-15.3	1.71 H	135	22.2	16.5

ANTENNA POLARITY & TEST DISTANCE: VERTICAL AT 3 M

NO.	FREQ. (MHz)	EMISSION LEVEL (dBuV/m)	LIMIT (dBuV/m)	MARGIN (dB)	ANTENNA HEIGHT (m)	TABLE ANGLE (Degree)	RAW VALUE (dBuV)	CORRECTION FACTOR (dB/m)
1	*5580.00	103.6 PK			1.05 V	200	99.0	4.6
2	*5580.00	92.5 AV			1.05 V	200	87.9	4.6
3	11160.00	54.6 PK	74.0	-19.4	2.98 V	134	40.2	14.4
4	11160.00	42.9 AV	54.0	-11.1	2.98 V	134	28.5	14.4
5	#16740.00	50.4 PK	74.0	-23.6	2.43 V	159	33.9	16.5
6	#16740.00	38.4 AV	54.0	-15.6	2.43 V	159	21.9	16.5

REMARKS:

1. Emission Level(dBuV/m) = Raw Value(dBuV) + Correction Factor(dB/m)
2. Correction Factor(dB/m) = Antenna Factor(dB/m) + Cable Factor(dB) – Pre-Amplifier Factor(dB)
3. The other emission levels were very low against the limit.
4. Margin value = Emission Level – Limit value
5. " * ": Fundamental frequency.
6. " # ": The radiated frequency is out of the restricted band.

CHANNEL	TX Channel 140	DETECTOR FUNCTION	Peak (PK)
FREQUENCY RANGE	1GHz ~ 40GHz		Average (AV)

ANTENNA POLARITY & TEST DISTANCE: HORIZONTAL AT 3 M

NO.	FREQ. (MHz)	EMISSION LEVEL (dBuV/m)	LIMIT (dBuV/m)	MARGIN (dB)	ANTENNA HEIGHT (m)	TABLE ANGLE (Degree)	RAW VALUE (dBuV)	CORRECTION FACTOR (dB/m)
1	*5700.00	113.3 PK			3.03 H	296	108.5	4.8
2	*5700.00	102.3 AV			3.03 H	296	97.5	4.8
3	#5725.00	64.2 PK	74.0	-9.8	3.03 H	296	59.3	4.9
4	#5725.00	48.7 AV	54.0	-5.3	3.03 H	296	43.8	4.9
5	11400.00	57.6 PK	74.0	-16.4	2.08 H	171	43.2	14.4
6	11400.00	45.0 AV	54.0	-9.0	2.08 H	171	30.6	14.4
7	#17100.00	51.2 PK	74.0	-22.8	1.72 H	140	32.7	18.5
8	#17100.00	38.2 AV	54.0	-15.8	1.72 H	140	19.7	18.5

ANTENNA POLARITY & TEST DISTANCE: VERTICAL AT 3 M

NO.	FREQ. (MHz)	EMISSION LEVEL (dBuV/m)	LIMIT (dBuV/m)	MARGIN (dB)	ANTENNA HEIGHT (m)	TABLE ANGLE (Degree)	RAW VALUE (dBuV)	CORRECTION FACTOR (dB/m)
1	*5700.00	103.2 PK			1.11 V	205	98.4	4.8
2	*5700.00	92.1 AV			1.11 V	205	87.3	4.8
3	#5725.00	52.5 PK	74.0	-21.5	1.11 V	205	47.6	4.9
4	#5725.00	42.3 AV	54.0	-11.7	1.11 V	205	37.4	4.9
5	11400.00	54.1 PK	74.0	-19.9	2.97 V	145	39.7	14.4
6	11400.00	42.7 AV	54.0	-11.3	2.97 V	145	28.3	14.4
7	#17100.00	50.4 PK	74.0	-23.6	2.43 V	149	31.9	18.5
8	#17100.00	38.1 AV	54.0	-15.9	2.43 V	149	19.6	18.5

REMARKS:

1. Emission Level(dBuV/m) = Raw Value(dBuV) + Correction Factor(dB/m)
2. Correction Factor(dB/m) = Antenna Factor(dB/m) + Cable Factor(dB) – Pre-Amplifier Factor(dB)
3. The other emission levels were very low against the limit.
4. Margin value = Emission Level – Limit value
5. " * ": Fundamental frequency.
6. " # ": The radiated frequency is out of the restricted band.

CHANNEL	TX Channel 144	DETECTOR FUNCTION	Peak (PK)
FREQUENCY RANGE	1GHz ~ 40GHz		Average (AV)

ANTENNA POLARITY & TEST DISTANCE: HORIZONTAL AT 3 M

NO.	FREQ. (MHz)	EMISSION LEVEL (dBuV/m)	LIMIT (dBuV/m)	MARGIN (dB)	ANTENNA HEIGHT (m)	TABLE ANGLE (Degree)	RAW VALUE (dBuV)	CORRECTION FACTOR (dB/m)
1	#5470.00	50.3 PK	74.0	-23.7	1.14 H	287	45.8	4.5
2	#5470.00	37.2 AV	54.0	-16.8	1.14 H	287	32.7	4.5
3	*5720.00	112.5 PK			1.14 H	287	107.6	4.9
4	*5720.00	101.7 AV			1.14 H	287	96.8	4.9
5	#5850.00	50.5 PK	74.0	-23.5	1.11 H	287	45.4	5.1
6	#5850.00	37.5 AV	54.0	-16.5	1.11 H	287	32.4	5.1
7	11440.00	57.9 PK	74.0	-16.1	2.07 H	175	43.7	14.2
8	11440.00	45.2 AV	54.0	-8.8	2.07 H	175	31.0	14.2
9	#17160.00	50.9 PK	74.0	-23.1	1.70 H	126	32.6	18.3
10	#17160.00	37.7 AV	54.0	-16.3	1.70 H	126	19.4	18.3

ANTENNA POLARITY & TEST DISTANCE: VERTICAL AT 3 M

NO.	FREQ. (MHz)	EMISSION LEVEL (dBuV/m)	LIMIT (dBuV/m)	MARGIN (dB)	ANTENNA HEIGHT (m)	TABLE ANGLE (Degree)	RAW VALUE (dBuV)	CORRECTION FACTOR (dB/m)
1	#5470.00	50.1 PK	74.0	-23.9	1.13 V	207	45.6	4.5
2	#5470.00	37.1 AV	54.0	-16.9	1.13 V	207	32.6	4.5
3	*5720.00	102.8 PK			1.13 V	207	97.9	4.9
4	*5720.00	91.5 AV			1.13 V	207	86.6	4.9
5	#5850.00	50.2 PK	74.0	-23.8	1.13 V	207	45.1	5.1
6	#5850.00	37.3 AV	54.0	-16.7	1.13 V	207	32.2	5.1
7	11440.00	53.7 PK	74.0	-20.3	2.92 V	153	39.5	14.2
8	11440.00	42.4 AV	54.0	-11.6	2.92 V	153	28.2	14.2
9	#17160.00	50.3 PK	74.0	-23.7	2.46 V	152	32.0	18.3
10	#17160.00	38.2 AV	54.0	-15.8	2.46 V	152	19.9	18.3

REMARKS:

1. Emission Level(dBuV/m) = Raw Value(dBuV) + Correction Factor(dB/m)
2. Correction Factor(dB/m) = Antenna Factor(dB/m) + Cable Factor(dB) – Pre-Amplifier Factor(dB)
3. The other emission levels were very low against the limit.
4. Margin value = Emission Level – Limit value
5. " * ": Fundamental frequency.
6. " # ": The radiated frequency is out of the restricted band.

802.11ac (VHT20)

CHANNEL	TX Channel 100	DETECTOR FUNCTION	Peak (PK)
FREQUENCY RANGE	1GHz ~ 40GHz		Average (AV)

ANTENNA POLARITY & TEST DISTANCE: HORIZONTAL AT 3 M

NO.	FREQ. (MHz)	EMISSION LEVEL (dBuV/m)	LIMIT (dBuV/m)	MARGIN (dB)	ANTENNA HEIGHT (m)	TABLE ANGLE (Degree)	RAW VALUE (dBuV)	CORRECTION FACTOR (dB/m)
1	#5470.00	61.0 PK	74.0	-13.0	1.26 H	288	56.5	4.5
2	#5470.00	48.2 AV	54.0	-5.8	1.26 H	288	43.7	4.5
3	*5500.00	115.5 PK			1.26 H	288	111.0	4.5
4	*5500.00	105.6 AV			1.26 H	288	101.1	4.5
5	11000.00	59.3 PK	74.0	-14.7	1.48 H	168	44.5	14.8
6	11000.00	45.2 AV	54.0	-8.8	1.48 H	168	30.4	14.8
7	#16500.00	47.2 PK	74.0	-26.8	1.55 H	360	31.6	15.6
8	#16500.00	33.3 AV	54.0	-20.7	1.55 H	360	17.7	15.6

ANTENNA POLARITY & TEST DISTANCE: VERTICAL AT 3 M

NO.	FREQ. (MHz)	EMISSION LEVEL (dBuV/m)	LIMIT (dBuV/m)	MARGIN (dB)	ANTENNA HEIGHT (m)	TABLE ANGLE (Degree)	RAW VALUE (dBuV)	CORRECTION FACTOR (dB/m)
1	#5470.00	58.1 PK	74.0	-15.9	1.99 V	254	53.6	4.5
2	#5470.00	43.4 AV	54.0	-10.6	1.99 V	254	38.9	4.5
3	*5500.00	105.5 PK			1.99 V	254	101.0	4.5
4	*5500.00	95.5 AV			1.99 V	254	91.0	4.5
5	11000.00	54.1 PK	74.0	-19.9	1.72 V	142	39.3	14.8
6	11000.00	41.3 AV	54.0	-12.7	1.72 V	142	26.5	14.8
7	#16500.00	47.3 PK	74.0	-26.7	1.63 V	218	31.7	15.6
8	#16500.00	33.3 AV	54.0	-20.7	1.63 V	218	17.7	15.6

REMARKS:

- Emission Level(dBuV/m) = Raw Value(dBuV) + Correction Factor(dB/m)
- Correction Factor(dB/m) = Antenna Factor(dB/m) + Cable Factor(dB) – Pre-Amplifier Factor(dB)
- The other emission levels were very low against the limit.
- Margin value = Emission Level – Limit value
- " * ": Fundamental frequency.
- " # ": The radiated frequency is out of the restricted band.

CHANNEL	TX Channel 116	DETECTOR FUNCTION	Peak (PK)
FREQUENCY RANGE	1GHz ~ 40GHz		Average (AV)

ANTENNA POLARITY & TEST DISTANCE: HORIZONTAL AT 3 M

NO.	FREQ. (MHz)	EMISSION LEVEL (dBuV/m)	LIMIT (dBuV/m)	MARGIN (dB)	ANTENNA HEIGHT (m)	TABLE ANGLE (Degree)	RAW VALUE (dBuV)	CORRECTION FACTOR (dB/m)
1	#5470.00	50.1 PK	74.0	-23.9	1.35 H	283	45.6	4.5
2	#5470.00	37.5 AV	54.0	-16.5	1.35 H	283	33.0	4.5
3	*5580.00	115.9 PK			1.35 H	283	111.3	4.6
4	*5580.00	105.8 AV			1.35 H	283	101.2	4.6
5	#5725.00	50.2 PK	74.0	-23.8	1.35 H	283	45.3	4.9
6	#5725.00	37.4 AV	54.0	-16.6	1.35 H	283	32.5	4.9
7	11160.00	59.4 PK	74.0	-14.6	1.42 H	164	45.0	14.4
8	11160.00	45.3 AV	54.0	-8.7	1.42 H	164	30.9	14.4
9	#16740.00	47.5 PK	74.0	-26.5	1.51 H	360	31.0	16.5
10	#16740.00	33.5 AV	54.0	-20.5	1.51 H	360	17.0	16.5

ANTENNA POLARITY & TEST DISTANCE: VERTICAL AT 3 M

NO.	FREQ. (MHz)	EMISSION LEVEL (dBuV/m)	LIMIT (dBuV/m)	MARGIN (dB)	ANTENNA HEIGHT (m)	TABLE ANGLE (Degree)	RAW VALUE (dBuV)	CORRECTION FACTOR (dB/m)
1	#5470.00	50.6 PK	74.0	-23.4	2.01 V	258	46.1	4.5
2	#5470.00	37.9 AV	54.0	-16.1	2.01 V	258	33.4	4.5
3	*5580.00	105.7 PK			2.01 V	258	101.1	4.6
4	*5580.00	95.7 AV			2.01 V	258	91.1	4.6
5	#5725.00	50.0 PK	74.0	-24.0	2.01 V	258	45.1	4.9
6	#5725.00	37.1 AV	54.0	-16.9	2.01 V	258	32.2	4.9
7	11160.00	54.6 PK	74.0	-19.4	1.68 V	140	40.2	14.4
8	11160.00	41.6 AV	54.0	-12.4	1.68 V	140	27.2	14.4
9	#16740.00	47.3 PK	74.0	-26.7	1.58 V	233	30.8	16.5
10	#16740.00	33.1 AV	54.0	-20.9	1.58 V	233	16.6	16.5

REMARKS:

1. Emission Level(dBuV/m) = Raw Value(dBuV) + Correction Factor(dB/m)
2. Correction Factor(dB/m) = Antenna Factor(dB/m) + Cable Factor(dB) – Pre-Amplifier Factor(dB)
3. The other emission levels were very low against the limit.
4. Margin value = Emission Level – Limit value
5. " * ": Fundamental frequency.
6. " # ": The radiated frequency is out of the restricted band.

CHANNEL	TX Channel 140	DETECTOR FUNCTION	Peak (PK)
FREQUENCY RANGE	1GHz ~ 40GHz		Average (AV)

ANTENNA POLARITY & TEST DISTANCE: HORIZONTAL AT 3 M

NO.	FREQ. (MHz)	EMISSION LEVEL (dBuV/m)	LIMIT (dBuV/m)	MARGIN (dB)	ANTENNA HEIGHT (m)	TABLE ANGLE (Degree)	RAW VALUE (dBuV)	CORRECTION FACTOR (dB/m)
1	*5700.00	114.7 PK			1.04 H	298	109.9	4.8
2	*5700.00	104.0 AV			1.04 H	298	99.2	4.8
3	#5725.00	60.9 PK	74.0	-13.1	1.04 H	298	56.0	4.9
4	#5725.00	47.9 AV	54.0	-6.1	1.04 H	298	43.0	4.9
5	11400.00	59.7 PK	74.0	-14.3	1.42 H	149	45.3	14.4
6	11400.00	45.5 AV	54.0	-8.5	1.42 H	149	31.1	14.4
7	#17100.00	48.2 PK	74.0	-25.8	1.51 H	351	29.7	18.5
8	#17100.00	33.9 AV	54.0	-20.1	1.51 H	351	15.4	18.5

ANTENNA POLARITY & TEST DISTANCE: VERTICAL AT 3 M

NO.	FREQ. (MHz)	EMISSION LEVEL (dBuV/m)	LIMIT (dBuV/m)	MARGIN (dB)	ANTENNA HEIGHT (m)	TABLE ANGLE (Degree)	RAW VALUE (dBuV)	CORRECTION FACTOR (dB/m)
1	*5700.00	104.3 PK			2.05 V	255	99.5	4.8
2	*5700.00	94.1 AV			2.05 V	255	89.3	4.8
3	#5725.00	55.1 PK	74.0	-18.9	2.05 V	255	50.2	4.9
4	#5725.00	41.8 AV	54.0	-12.2	2.05 V	255	36.9	4.9
5	11400.00	55.2 PK	74.0	-18.8	1.70 V	130	40.8	14.4
6	11400.00	42.0 AV	54.0	-12.0	1.70 V	130	27.6	14.4
7	#17100.00	47.0 PK	74.0	-27.0	1.60 V	221	28.5	18.5
8	#17100.00	32.8 AV	54.0	-21.2	1.60 V	221	14.3	18.5

REMARKS:

1. Emission Level(dBuV/m) = Raw Value(dBuV) + Correction Factor(dB/m)
2. Correction Factor(dB/m) = Antenna Factor(dB/m) + Cable Factor(dB) – Pre-Amplifier Factor(dB)
3. The other emission levels were very low against the limit.
4. Margin value = Emission Level – Limit value
5. " * ": Fundamental frequency.
6. " # ": The radiated frequency is out of the restricted band.

CHANNEL	TX Channel 144	DETECTOR FUNCTION	Peak (PK)
FREQUENCY RANGE	1GHz ~ 40GHz		Average (AV)

ANTENNA POLARITY & TEST DISTANCE: HORIZONTAL AT 3 M

NO.	FREQ. (MHz)	EMISSION LEVEL (dBuV/m)	LIMIT (dBuV/m)	MARGIN (dB)	ANTENNA HEIGHT (m)	TABLE ANGLE (Degree)	RAW VALUE (dBuV)	CORRECTION FACTOR (dB/m)
1	#5470.00	50.1 PK	74.0	-23.9	1.09 H	288	45.6	4.5
2	#5470.00	37.1 AV	54.0	-16.9	1.09 H	288	32.6	4.5
3	*5720.00	115.2 PK			1.09 H	288	110.3	4.9
4	*5720.00	104.5 AV			1.09 H	288	99.6	4.9
5	#5850.00	50.5 PK	74.0	-23.5	1.09 H	288	45.4	5.1
6	#5850.00	37.2 AV	54.0	-16.8	1.09 H	288	32.1	5.1
7	11440.00	59.7 PK	74.0	-14.3	1.36 H	167	45.5	14.2
8	11440.00	45.5 AV	54.0	-8.5	1.36 H	167	31.3	14.2
9	#17160.00	47.6 PK	74.0	-26.4	1.46 H	359	29.3	18.3
10	#17160.00	33.6 AV	54.0	-20.4	1.46 H	359	15.3	18.3

ANTENNA POLARITY & TEST DISTANCE: VERTICAL AT 3 M

NO.	FREQ. (MHz)	EMISSION LEVEL (dBuV/m)	LIMIT (dBuV/m)	MARGIN (dB)	ANTENNA HEIGHT (m)	TABLE ANGLE (Degree)	RAW VALUE (dBuV)	CORRECTION FACTOR (dB/m)
1	#5470.00	50.0 PK	74.0	-24.0	2.03 V	256	45.5	4.5
2	#5470.00	36.7 AV	54.0	-17.3	2.03 V	256	32.2	4.5
3	*5720.00	104.6 PK			2.03 V	256	99.7	4.9
4	*5720.00	94.3 AV			2.03 V	256	89.4	4.9
5	#5850.00	50.7 PK	74.0	-23.3	2.03 V	256	45.6	5.1
6	#5850.00	37.1 AV	54.0	-16.9	2.03 V	256	32.0	5.1
7	11440.00	54.2 PK	74.0	-19.8	1.68 V	150	40.0	14.2
8	11440.00	41.1 AV	54.0	-12.9	1.68 V	150	26.9	14.2
9	#17160.00	47.4 PK	74.0	-26.6	1.60 V	237	29.1	18.3
10	#17160.00	33.5 AV	54.0	-20.5	1.60 V	237	15.2	18.3

REMARKS:

1. Emission Level(dBuV/m) = Raw Value(dBuV) + Correction Factor(dB/m)
2. Correction Factor(dB/m) = Antenna Factor(dB/m) + Cable Factor(dB) – Pre-Amplifier Factor(dB)
3. The other emission levels were very low against the limit.
4. Margin value = Emission Level – Limit value
5. " * ": Fundamental frequency.
6. " # ": The radiated frequency is out of the restricted band.

802.11ac (VHT40)

CHANNEL	TX Channel 102	DETECTOR FUNCTION	Peak (PK)
FREQUENCY RANGE	1GHz ~ 40GHz		Average (AV)

ANTENNA POLARITY & TEST DISTANCE: HORIZONTAL AT 3 M

NO.	FREQ. (MHz)	EMISSION LEVEL (dBuV/m)	LIMIT (dBuV/m)	MARGIN (dB)	ANTENNA HEIGHT (m)	TABLE ANGLE (Degree)	RAW VALUE (dBuV)	CORRECTION FACTOR (dB/m)
1	#5470.00	64.8 PK	74.0	-9.2	1.25 H	284	60.3	4.5
2	#5470.00	53.7 AV	54.0	-0.3	1.25 H	284	49.2	4.5
3	*5510.00	112.9 PK			1.25 H	284	108.3	4.6
4	*5510.00	103.0 AV			1.25 H	284	98.4	4.6
5	11020.00	58.6 PK	74.0	-15.4	1.40 H	161	43.9	14.7
6	11020.00	43.7 AV	54.0	-10.3	1.40 H	161	29.0	14.7
7	#16530.00	47.1 PK	74.0	-26.9	1.44 H	360	31.3	15.8
8	#16530.00	33.3 AV	54.0	-20.7	1.44 H	360	17.5	15.8

ANTENNA POLARITY & TEST DISTANCE: VERTICAL AT 3 M

NO.	FREQ. (MHz)	EMISSION LEVEL (dBuV/m)	LIMIT (dBuV/m)	MARGIN (dB)	ANTENNA HEIGHT (m)	TABLE ANGLE (Degree)	RAW VALUE (dBuV)	CORRECTION FACTOR (dB/m)
1	#5470.00	58.5 PK	74.0	-15.5	1.99 V	235	54.0	4.5
2	#5470.00	47.8 AV	54.0	-6.2	1.99 V	235	43.3	4.5
3	*5510.00	103.8 PK			1.99 V	235	99.2	4.6
4	*5510.00	92.5 AV			1.99 V	235	87.9	4.6
5	11020.00	52.8 PK	74.0	-21.2	1.74 V	149	38.1	14.7
6	11020.00	39.7 AV	54.0	-14.3	1.74 V	149	25.0	14.7
7	#16530.00	47.9 PK	74.0	-26.1	1.57 V	207	32.1	15.8
8	#16530.00	33.8 AV	54.0	-20.2	1.57 V	207	18.0	15.8

REMARKS:

- Emission Level(dBuV/m) = Raw Value(dBuV) + Correction Factor(dB/m)
- Correction Factor(dB/m) = Antenna Factor(dB/m) + Cable Factor(dB) – Pre-Amplifier Factor(dB)
- The other emission levels were very low against the limit.
- Margin value = Emission Level – Limit value
- " * ": Fundamental frequency.
- " # ": The radiated frequency is out of the restricted band.

CHANNEL	TX Channel 110	DETECTOR FUNCTION	Peak (PK)
FREQUENCY RANGE	1GHz ~ 40GHz		Average (AV)

ANTENNA POLARITY & TEST DISTANCE: HORIZONTAL AT 3 M

NO.	FREQ. (MHz)	EMISSION LEVEL (dBuV/m)	LIMIT (dBuV/m)	MARGIN (dB)	ANTENNA HEIGHT (m)	TABLE ANGLE (Degree)	RAW VALUE (dBuV)	CORRECTION FACTOR (dB/m)
1	#5470.00	59.5 PK	74.0	-14.5	1.24 H	288	55.0	4.5
2	#5470.00	48.7 AV	54.0	-5.3	1.24 H	288	44.2	4.5
3	*5550.00	114.4 PK			1.24 H	288	109.9	4.5
4	*5550.00	103.8 AV			1.24 H	288	99.3	4.5
5	11100.00	60.5 PK	74.0	-13.5	1.37 H	176	46.1	14.4
6	11100.00	45.5 AV	54.0	-8.5	1.37 H	176	31.1	14.4
7	#16650.00	47.1 PK	74.0	-26.9	1.48 H	360	30.7	16.4
8	#16650.00	33.2 AV	54.0	-20.8	1.48 H	360	16.8	16.4

ANTENNA POLARITY & TEST DISTANCE: VERTICAL AT 3 M

NO.	FREQ. (MHz)	EMISSION LEVEL (dBuV/m)	LIMIT (dBuV/m)	MARGIN (dB)	ANTENNA HEIGHT (m)	TABLE ANGLE (Degree)	RAW VALUE (dBuV)	CORRECTION FACTOR (dB/m)
1	#5470.00	53.3 PK	74.0	-20.7	2.00 V	234	48.8	4.5
2	#5470.00	42.5 AV	54.0	-11.5	2.00 V	234	38.0	4.5
3	*5550.00	104.6 PK			2.00 V	234	100.1	4.5
4	*5550.00	93.4 AV			2.00 V	234	88.9	4.5
5	11100.00	54.8 PK	74.0	-19.2	1.73 V	137	40.4	14.4
6	11100.00	41.8 AV	54.0	-12.2	1.73 V	137	27.4	14.4
7	#16650.00	47.8 PK	74.0	-26.2	1.53 V	219	31.4	16.4
8	#16650.00	33.6 AV	54.0	-20.4	1.53 V	219	17.2	16.4

REMARKS:

1. Emission Level(dBuV/m) = Raw Value(dBuV) + Correction Factor(dB/m)
2. Correction Factor(dB/m) = Antenna Factor(dB/m) + Cable Factor(dB) – Pre-Amplifier Factor(dB)
3. The other emission levels were very low against the limit.
4. Margin value = Emission Level – Limit value
5. " * ": Fundamental frequency.
6. " # ": The radiated frequency is out of the restricted band.

CHANNEL	TX Channel 134	DETECTOR FUNCTION	Peak (PK)
FREQUENCY RANGE	1GHz ~ 40GHz		Average (AV)

ANTENNA POLARITY & TEST DISTANCE: HORIZONTAL AT 3 M

NO.	FREQ. (MHz)	EMISSION LEVEL (dBuV/m)	LIMIT (dBuV/m)	MARGIN (dB)	ANTENNA HEIGHT (m)	TABLE ANGLE (Degree)	RAW VALUE (dBuV)	CORRECTION FACTOR (dB/m)
1	*5670.00	113.2 PK			1.22 H	290	108.4	4.8
2	*5670.00	103.1 AV			1.22 H	290	98.3	4.8
3	#5725.00	62.9 PK	74.0	-11.1	1.22 H	290	58.0	4.9
4	#5725.00	50.6 AV	54.0	-3.4	1.22 H	290	45.7	4.9
5	11340.00	60.0 PK	74.0	-14.0	1.34 H	183	45.6	14.4
6	11340.00	44.9 AV	54.0	-9.1	1.34 H	183	30.5	14.4
7	#17010.00	47.7 PK	74.0	-26.3	1.46 H	360	29.5	18.2
8	#17010.00	33.6 AV	54.0	-20.4	1.46 H	360	15.4	18.2

ANTENNA POLARITY & TEST DISTANCE: VERTICAL AT 3 M

NO.	FREQ. (MHz)	EMISSION LEVEL (dBuV/m)	LIMIT (dBuV/m)	MARGIN (dB)	ANTENNA HEIGHT (m)	TABLE ANGLE (Degree)	RAW VALUE (dBuV)	CORRECTION FACTOR (dB/m)
1	*5670.00	103.6 PK			2.04 V	231	98.8	4.8
2	*5670.00	92.3 AV			2.04 V	231	87.5	4.8
3	#5725.00	55.4 PK	74.0	-18.6	2.04 V	231	50.5	4.9
4	#5725.00	44.4 AV	54.0	-9.6	2.04 V	231	39.5	4.9
5	11340.00	54.6 PK	74.0	-19.4	1.72 V	141	40.2	14.4
6	11340.00	41.7 AV	54.0	-12.3	1.72 V	141	27.3	14.4
7	#17010.00	48.4 PK	74.0	-25.6	1.53 V	230	30.2	18.2
8	#17010.00	34.1 AV	54.0	-19.9	1.53 V	230	15.9	18.2

REMARKS:

1. Emission Level(dBuV/m) = Raw Value(dBuV) + Correction Factor(dB/m)
2. Correction Factor(dB/m) = Antenna Factor(dB/m) + Cable Factor(dB) – Pre-Amplifier Factor(dB)
3. The other emission levels were very low against the limit.
4. Margin value = Emission Level – Limit value
5. " * ": Fundamental frequency.
6. " # ": The radiated frequency is out of the restricted band.

CHANNEL	TX Channel 142	DETECTOR FUNCTION	Peak (PK)
FREQUENCY RANGE	1GHz ~ 40GHz		Average (AV)

ANTENNA POLARITY & TEST DISTANCE: HORIZONTAL AT 3 M

NO.	FREQ. (MHz)	EMISSION LEVEL (dBuV/m)	LIMIT (dBuV/m)	MARGIN (dB)	ANTENNA HEIGHT (m)	TABLE ANGLE (Degree)	RAW VALUE (dBuV)	CORRECTION FACTOR (dB/m)
1	#5470.00	50.1 PK	74.0	-23.9	1.17 H	289	45.6	4.5
2	#5470.00	33.5 AV	54.0	-20.5	1.17 H	289	29.0	4.5
3	*5710.00	113.4 PK			1.17 H	289	108.5	4.9
4	*5710.00	103.2 AV			1.17 H	289	98.3	4.9
5	#5850.00	50.9 PK	74.0	-23.1	1.17 H	289	45.8	5.1
6	#5850.00	33.9 AV	54.0	-20.1	1.17 H	289	28.8	5.1
7	11420.00	59.6 PK	74.0	-14.4	1.32 H	198	45.3	14.3
8	11420.00	44.7 AV	54.0	-9.3	1.32 H	198	30.4	14.3
9	#17130.00	48.2 PK	74.0	-25.8	1.47 H	360	29.7	18.5
10	#17130.00	34.0 AV	54.0	-20.0	1.47 H	360	15.5	18.5

ANTENNA POLARITY & TEST DISTANCE: VERTICAL AT 3 M

NO.	FREQ. (MHz)	EMISSION LEVEL (dBuV/m)	LIMIT (dBuV/m)	MARGIN (dB)	ANTENNA HEIGHT (m)	TABLE ANGLE (Degree)	RAW VALUE (dBuV)	CORRECTION FACTOR (dB/m)
1	#5470.00	50.5 PK	74.0	-23.5	2.01 V	233	46.0	4.5
2	#5470.00	33.7 AV	54.0	-20.3	2.01 V	233	29.2	4.5
3	*5710.00	103.2 PK			2.01 V	230	98.3	4.9
4	*5710.00	92.1 AV			2.01 V	230	87.2	4.9
5	#5850.00	51.6 PK	74.0	-22.4	2.01 V	233	46.5	5.1
6	#5850.00	34.3 AV	54.0	-19.7	2.01 V	233	29.2	5.1
7	11420.00	54.4 PK	74.0	-19.6	1.77 V	139	40.1	14.3
8	11420.00	41.5 AV	54.0	-12.5	1.77 V	139	27.2	14.3
9	#17130.00	48.5 PK	74.0	-25.5	1.48 V	232	30.0	18.5
10	#17130.00	34.3 AV	54.0	-19.7	1.48 V	232	15.8	18.5

REMARKS:

- Emission Level(dBuV/m) = Raw Value(dBuV) + Correction Factor(dB/m)
- Correction Factor(dB/m) = Antenna Factor(dB/m) + Cable Factor(dB) – Pre-Amplifier Factor(dB)
- The other emission levels were very low against the limit.
- Margin value = Emission Level – Limit value
- " * ": Fundamental frequency.
- " # ": The radiated frequency is out of the restricted band.

802.11ac (VHT80)

CHANNEL	TX Channel 106	DETECTOR FUNCTION	Peak (PK)
FREQUENCY RANGE	1GHz ~ 40GHz		Average (AV)

ANTENNA POLARITY & TEST DISTANCE: HORIZONTAL AT 3 M

NO.	FREQ. (MHz)	EMISSION LEVEL (dBuV/m)	LIMIT (dBuV/m)	MARGIN (dB)	ANTENNA HEIGHT (m)	TABLE ANGLE (Degree)	RAW VALUE (dBuV)	CORRECTION FACTOR (dB/m)
1	#5470.00	62.1 PK	74.0	-11.9	1.20 H	279	57.6	4.5
2	#5470.00	53.7 AV	54.0	-0.3	1.20 H	279	49.2	4.5
3	*5530.00	109.6 PK			1.20 H	279	105.1	4.5
4	*5530.00	100.0 AV			1.20 H	279	95.5	4.5
5	#5725.00	51.3 PK	74.0	-22.7	1.20 H	279	46.4	4.9
6	#5725.00	40.8 AV	54.0	-13.2	1.20 H	279	35.9	4.9
7	11060.00	54.6 PK	74.0	-19.4	3.95 H	155	40.1	14.5
8	11060.00	40.3 AV	54.0	-13.7	3.95 H	155	25.8	14.5
9	#16590.00	50.4 PK	74.0	-23.6	1.83 H	360	33.8	16.6
10	#16590.00	35.5 AV	54.0	-18.5	1.83 H	360	18.9	16.6

ANTENNA POLARITY & TEST DISTANCE: VERTICAL AT 3 M

NO.	FREQ. (MHz)	EMISSION LEVEL (dBuV/m)	LIMIT (dBuV/m)	MARGIN (dB)	ANTENNA HEIGHT (m)	TABLE ANGLE (Degree)	RAW VALUE (dBuV)	CORRECTION FACTOR (dB/m)
1	#5470.00	54.0 PK	74.0	-20.0	2.13 V	229	49.5	4.5
2	#5470.00	47.6 AV	54.0	-6.4	2.13 V	229	43.1	4.5
3	*5530.00	100.7 PK			2.13 V	229	96.2	4.5
4	*5530.00	89.4 AV			2.13 V	229	84.9	4.5
5	#5725.00	50.3 PK	74.0	-23.7	2.13 V	229	45.4	4.9
6	#5725.00	33.9 AV	54.0	-20.1	2.13 V	229	29.0	4.9
7	11060.00	50.5 PK	74.0	-23.5	1.91 V	110	36.0	14.5
8	11060.00	36.3 AV	54.0	-17.7	1.91 V	110	21.8	14.5
9	#16590.00	48.8 PK	74.0	-25.2	3.20 V	108	32.2	16.6
10	#16590.00	35.5 AV	54.0	-18.5	3.20 V	108	18.9	16.6

REMARKS:

1. Emission Level(dBuV/m) = Raw Value(dBuV) + Correction Factor(dB/m)
2. Correction Factor(dB/m) = Antenna Factor(dB/m) + Cable Factor(dB) – Pre-Amplifier Factor(dB)
3. The other emission levels were very low against the limit.
4. Margin value = Emission Level – Limit value
5. " * ": Fundamental frequency.
6. " # ": The radiated frequency is out of the restricted band.

CHANNEL	TX Channel 122	DETECTOR FUNCTION	Peak (PK)
FREQUENCY RANGE	1GHz ~ 40GHz		Average (AV)

ANTENNA POLARITY & TEST DISTANCE: HORIZONTAL AT 3 M

NO.	FREQ. (MHz)	EMISSION LEVEL (dBuV/m)	LIMIT (dBuV/m)	MARGIN (dB)	ANTENNA HEIGHT (m)	TABLE ANGLE (Degree)	RAW VALUE (dBuV)	CORRECTION FACTOR (dB/m)
1	*5610.00	111.3 PK			1.22 H	290	106.6	4.7
2	*5610.00	102.3 AV			1.22 H	290	97.6	4.7
3	#5725.00	65.4 PK	74.0	-8.6	1.22 H	290	60.5	4.9
4	#5725.00	51.6 AV	54.0	-2.4	1.22 H	290	46.7	4.9
5	11220.00	56.0 PK	74.0	-18.0	3.95 H	152	41.6	14.4
6	11220.00	42.0 AV	54.0	-12.0	3.95 H	152	27.6	14.4
7	#16830.00	50.3 PK	74.0	-23.7	1.88 H	347	33.3	17.0
8	#16830.00	35.7 AV	54.0	-18.3	1.88 H	347	18.7	17.0

ANTENNA POLARITY & TEST DISTANCE: VERTICAL AT 3 M

NO.	FREQ. (MHz)	EMISSION LEVEL (dBuV/m)	LIMIT (dBuV/m)	MARGIN (dB)	ANTENNA HEIGHT (m)	TABLE ANGLE (Degree)	RAW VALUE (dBuV)	CORRECTION FACTOR (dB/m)
1	*5610.00	103.1 PK			2.12 V	226	98.4	4.7
2	*5610.00	91.5 AV			2.12 V	226	86.8	4.7
3	#5725.00	52.3 PK	74.0	-21.7	2.12 V	226	47.4	4.9
4	#5725.00	45.8 AV	54.0	-8.2	2.12 V	226	40.9	4.9
5	11220.00	52.7 PK	74.0	-21.3	1.86 V	125	38.3	14.4
6	11220.00	38.5 AV	54.0	-15.5	1.86 V	125	24.1	14.4
7	#16830.00	48.8 PK	74.0	-25.2	3.25 V	123	31.8	17.0
8	#16830.00	35.5 AV	54.0	-18.5	3.25 V	123	18.5	17.0

REMARKS:

1. Emission Level(dBuV/m) = Raw Value(dBuV) + Correction Factor(dB/m)
2. Correction Factor(dB/m) = Antenna Factor(dB/m) + Cable Factor(dB) – Pre-Amplifier Factor(dB)
3. The other emission levels were very low against the limit.
4. Margin value = Emission Level – Limit value
5. " * ": Fundamental frequency.
6. " # ": The radiated frequency is out of the restricted band.

CHANNEL	TX Channel 138	DETECTOR FUNCTION	Peak (PK)
FREQUENCY RANGE	1GHz ~ 40GHz		Average (AV)

ANTENNA POLARITY & TEST DISTANCE: HORIZONTAL AT 3 M

NO.	FREQ. (MHz)	EMISSION LEVEL (dBuV/m)	LIMIT (dBuV/m)	MARGIN (dB)	ANTENNA HEIGHT (m)	TABLE ANGLE (Degree)	RAW VALUE (dBuV)	CORRECTION FACTOR (dB/m)
1	#5470.00	60.1 PK	74.0	-13.9	1.23 H	285	55.6	4.5
2	#5470.00	44.2 AV	54.0	-9.8	1.23 H	285	39.7	4.5
3	*5690.00	111.4 PK			1.23 H	285	106.6	4.8
4	*5690.00	102.5 AV			1.23 H	285	97.7	4.8
5	#5850.00	63.5 PK	74.0	-10.5	1.23 H	285	58.4	5.1
6	#5850.00	49.1 AV	54.0	-4.9	1.23 H	285	44.0	5.1
7	11380.00	55.6 PK	74.0	-18.4	3.93 H	156	41.2	14.4
8	11380.00	41.9 AV	54.0	-12.1	3.93 H	156	27.5	14.4
9	#17070.00	50.0 PK	74.0	-24.0	1.90 H	350	31.7	18.3
10	#17070.00	35.6 AV	54.0	-18.4	1.90 H	350	17.3	18.3

ANTENNA POLARITY & TEST DISTANCE: VERTICAL AT 3 M

NO.	FREQ. (MHz)	EMISSION LEVEL (dBuV/m)	LIMIT (dBuV/m)	MARGIN (dB)	ANTENNA HEIGHT (m)	TABLE ANGLE (Degree)	RAW VALUE (dBuV)	CORRECTION FACTOR (dB/m)
1	#5470.00	54.3 PK	74.0	-19.7	2.09 V	223	49.8	4.5
2	#5470.00	38.1 AV	54.0	-15.9	2.09 V	223	33.6	4.5
3	*5690.00	103.3 PK			2.09 V	223	98.5	4.8
4	*5690.00	91.7 AV			2.09 V	223	86.9	4.8
5	#5850.00	57.6 PK	74.0	-16.4	2.09 V	223	52.5	5.1
6	#5850.00	43.0 AV	54.0	-11.0	2.09 V	223	37.9	5.1
7	11380.00	52.1 PK	74.0	-21.9	1.88 V	138	37.7	14.4
8	11380.00	38.1 AV	54.0	-15.9	1.88 V	138	23.7	14.4
9	#17070.00	49.4 PK	74.0	-24.6	3.25 V	107	31.1	18.3
10	#17070.00	36.0 AV	54.0	-18.0	3.25 V	107	17.7	18.3

REMARKS:

1. Emission Level(dBuV/m) = Raw Value(dBuV) + Correction Factor(dB/m)
2. Correction Factor(dB/m) = Antenna Factor(dB/m) + Cable Factor(dB) – Pre-Amplifier Factor(dB)
3. The other emission levels were very low against the limit.
4. Margin value = Emission Level – Limit value
5. " * ": Fundamental frequency.
6. " # ": The radiated frequency is out of the restricted band.

Below 1GHz Data:

802.11ac (VHT40)

CHANNEL	TX Channel 110	DETECTOR FUNCTION	Quasi-Peak (QP)
FREQUENCY RANGE	9kHz ~ 1GHz		

ANTENNA POLARITY & TEST DISTANCE: HORIZONTAL AT 3 M

NO.	FREQ. (MHz)	EMISSION LEVEL (dBuV/m)	LIMIT (dBuV/m)	MARGIN (dB)	ANTENNA HEIGHT (m)	TABLE ANGLE (Degree)	RAW VALUE (dBuV)	CORRECTION FACTOR (dB/m)
1	31.14	36.1 QP	40.0	-3.9	2.00 H	360	45.6	-9.5
2	62.13	32.1 QP	40.0	-7.9	2.00 H	75	41.1	-9.0
3	165.48	31.3 QP	43.5	-12.2	2.00 H	293	39.5	-8.2
4	225.02	31.9 QP	46.0	-14.1	1.00 H	140	43.5	-11.6
5	275.02	29.8 QP	46.0	-16.2	1.00 H	92	38.1	-8.3
6	375.00	30.9 QP	46.0	-15.1	1.00 H	0	36.7	-5.8

ANTENNA POLARITY & TEST DISTANCE: VERTICAL AT 3 M

NO.	FREQ. (MHz)	EMISSION LEVEL (dBuV/m)	LIMIT (dBuV/m)	MARGIN (dB)	ANTENNA HEIGHT (m)	TABLE ANGLE (Degree)	RAW VALUE (dBuV)	CORRECTION FACTOR (dB/m)
1	38.03	37.0 QP	40.0	-3.0	1.00 V	0	45.3	-8.3
2	84.47	35.9 QP	40.0	-4.1	1.00 V	360	49.7	-13.8
3	165.41	30.6 QP	43.5	-12.9	1.00 V	272	38.8	-8.2
4	225.02	31.7 QP	46.0	-14.3	1.00 V	360	43.3	-11.6
5	375.03	32.4 QP	46.0	-13.6	1.00 V	360	38.2	-5.8
6	499.99	28.3 QP	46.0	-17.7	2.00 V	23	31.1	-2.8

REMARKS:

1. Emission Level(dBuV/m) = Raw Value(dBuV) + Correction Factor(dB/m)
2. Correction Factor(dB/m) = Antenna Factor(dB/m) + Cable Factor(dB) – Pre-Amplifier Factor(dB)
3. The other emission levels were very low against the limit.
4. Margin value = Emission Level – Limit value

1TX Mode
Above 1GHz Data:
Radio 2
802.11a

CHANNEL	TX Channel 52	DETECTOR FUNCTION	Peak (PK)
FREQUENCY RANGE	1GHz ~ 40GHz		Average (AV)

ANTENNA POLARITY & TEST DISTANCE: HORIZONTAL AT 3 M

NO.	FREQ. (MHz)	EMISSION LEVEL (dBuV/m)	LIMIT (dBuV/m)	MARGIN (dB)	ANTENNA HEIGHT (m)	TABLE ANGLE (Degree)	RAW VALUE (dBuV)	CORRECTION FACTOR (dB/m)
1	5150.00	49.3 PK	74.0	-24.7	1.00 H	60	45.3	4.0
2	5150.00	36.4 AV	54.0	-17.6	1.00 H	60	32.4	4.0
3	*5260.00	112.8 PK			1.00 H	60	108.6	4.2
4	*5260.00	101.3 AV			1.00 H	60	97.1	4.2
5	5350.00	47.0 PK	74.0	-27.0	1.00 H	60	42.6	4.4
6	5350.00	35.4 AV	54.0	-18.6	1.00 H	60	31.0	4.4
7	#10520.00	53.5 PK	74.0	-20.5	1.03 H	81	39.7	13.8
8	#10520.00	41.1 AV	54.0	-12.9	1.03 H	81	27.3	13.8
9	15780.00	45.7 PK	74.0	-28.3	1.44 H	308	31.6	14.1
10	15780.00	33.9 AV	54.0	-20.1	1.44 H	308	19.8	14.1

ANTENNA POLARITY & TEST DISTANCE: VERTICAL AT 3 M

NO.	FREQ. (MHz)	EMISSION LEVEL (dBuV/m)	LIMIT (dBuV/m)	MARGIN (dB)	ANTENNA HEIGHT (m)	TABLE ANGLE (Degree)	RAW VALUE (dBuV)	CORRECTION FACTOR (dB/m)
1	5150.00	46.8 PK	74.0	-27.2	1.06 V	356	42.8	4.0
2	5150.00	35.3 AV	54.0	-18.7	1.06 V	356	31.3	4.0
3	*5260.00	109.3 PK			1.06 V	356	105.1	4.2
4	*5260.00	97.0 AV			1.06 V	356	92.8	4.2
5	5350.00	46.7 PK	74.0	-27.3	1.06 V	356	42.3	4.4
6	5350.00	35.1 AV	54.0	-18.9	1.06 V	356	30.7	4.4
7	#10520.00	53.0 PK	74.0	-21.0	1.40 V	220	39.2	13.8
8	#10520.00	40.9 AV	54.0	-13.1	1.40 V	220	27.1	13.8
9	15780.00	44.6 PK	74.0	-29.4	1.55 V	187	30.5	14.1
10	15780.00	32.6 AV	54.0	-21.4	1.55 V	187	18.5	14.1

REMARKS:

- Emission Level(dBuV/m) = Raw Value(dBuV) + Correction Factor(dB/m)
- Correction Factor(dB/m) = Antenna Factor(dB/m) + Cable Factor(dB) – Pre-Amplifier Factor(dB)
- The other emission levels were very low against the limit.
- Margin value = Emission Level – Limit value
- " * ": Fundamental frequency.
- " # ": The radiated frequency is out of the restricted band.

CHANNEL	TX Channel 60	DETECTOR FUNCTION	Peak (PK)
FREQUENCY RANGE	1GHz ~ 40GHz		Average (AV)

ANTENNA POLARITY & TEST DISTANCE: HORIZONTAL AT 3 M

NO.	FREQ. (MHz)	EMISSION LEVEL (dBuV/m)	LIMIT (dBuV/m)	MARGIN (dB)	ANTENNA HEIGHT (m)	TABLE ANGLE (Degree)	RAW VALUE (dBuV)	CORRECTION FACTOR (dB/m)
1	*5300.00	111.8 PK			1.00 H	68	107.5	4.3
2	*5300.00	100.8 AV			1.00 H	68	96.5	4.3
3	5350.00	49.5 PK	74.0	-24.5	1.00 H	68	45.1	4.4
4	5350.00	37.6 AV	54.0	-16.4	1.00 H	68	33.2	4.4
5	10600.00	53.2 PK	74.0	-20.8	1.09 H	87	39.4	13.8
6	10600.00	41.0 AV	54.0	-13.0	1.09 H	87	27.2	13.8
7	15900.00	45.3 PK	74.0	-28.7	1.43 H	303	32.1	13.2
8	15900.00	33.3 AV	54.0	-20.7	1.43 H	303	20.1	13.2

ANTENNA POLARITY & TEST DISTANCE: VERTICAL AT 3 M

NO.	FREQ. (MHz)	EMISSION LEVEL (dBuV/m)	LIMIT (dBuV/m)	MARGIN (dB)	ANTENNA HEIGHT (m)	TABLE ANGLE (Degree)	RAW VALUE (dBuV)	CORRECTION FACTOR (dB/m)
1	*5300.00	108.6 PK			1.02 V	348	104.3	4.3
2	*5300.00	96.5 AV			1.02 V	348	92.2	4.3
3	5350.00	47.6 PK	74.0	-26.4	1.02 V	348	43.2	4.4
4	5350.00	35.9 AV	54.0	-18.1	1.02 V	348	31.5	4.4
5	10600.00	53.3 PK	74.0	-20.7	1.38 V	225	39.5	13.8
6	10600.00	41.1 AV	54.0	-12.9	1.38 V	225	27.3	13.8
7	15900.00	45.0 PK	74.0	-29.0	1.51 V	174	31.8	13.2
8	15900.00	32.9 AV	54.0	-21.1	1.51 V	174	19.7	13.2

REMARKS:

1. Emission Level(dBuV/m) = Raw Value(dBuV) + Correction Factor(dB/m)
2. Correction Factor(dB/m) = Antenna Factor(dB/m) + Cable Factor(dB) – Pre-Amplifier Factor(dB)
3. The other emission levels were very low against the limit.
4. Margin value = Emission Level – Limit value
5. " * ": Fundamental frequency.

CHANNEL	TX Channel 64	DETECTOR FUNCTION	Peak (PK)
FREQUENCY RANGE	1GHz ~ 40GHz		Average (AV)

ANTENNA POLARITY & TEST DISTANCE: HORIZONTAL AT 3 M

NO.	FREQ. (MHz)	EMISSION LEVEL (dBuV/m)	LIMIT (dBuV/m)	MARGIN (dB)	ANTENNA HEIGHT (m)	TABLE ANGLE (Degree)	RAW VALUE (dBuV)	CORRECTION FACTOR (dB/m)
1	*5320.00	111.6 PK			1.02 H	58	107.3	4.3
2	*5320.00	100.1 AV			1.02 H	58	95.8	4.3
3	5350.00	61.3 PK	74.0	-12.7	1.02 H	58	56.9	4.4
4	5350.00	47.2 AV	54.0	-6.8	1.02 H	58	42.8	4.4
5	10640.00	52.8 PK	74.0	-21.2	1.09 H	86	38.8	14.0
6	10640.00	40.8 AV	54.0	-13.2	1.09 H	86	26.8	14.0
7	15960.00	45.9 PK	74.0	-28.1	1.45 H	297	32.4	13.5
8	15960.00	33.8 AV	54.0	-20.2	1.45 H	297	20.3	13.5

ANTENNA POLARITY & TEST DISTANCE: VERTICAL AT 3 M

NO.	FREQ. (MHz)	EMISSION LEVEL (dBuV/m)	LIMIT (dBuV/m)	MARGIN (dB)	ANTENNA HEIGHT (m)	TABLE ANGLE (Degree)	RAW VALUE (dBuV)	CORRECTION FACTOR (dB/m)
1	*5320.00	108.8 PK			1.09 V	338	104.5	4.3
2	*5320.00	96.7 AV			1.09 V	338	92.4	4.3
3	5350.00	57.5 PK	74.0	-16.5	1.09 V	338	53.1	4.4
4	5350.00	43.1 AV	54.0	-10.9	1.09 V	338	38.7	4.4
5	10640.00	53.6 PK	74.0	-20.4	1.34 V	235	39.6	14.0
6	10640.00	41.6 AV	54.0	-12.4	1.34 V	235	27.6	14.0
7	15960.00	44.4 PK	74.0	-29.6	1.46 V	174	30.9	13.5
8	15960.00	32.5 AV	54.0	-21.5	1.46 V	174	19.0	13.5

REMARKS:

1. Emission Level(dBuV/m) = Raw Value(dBuV) + Correction Factor(dB/m)
2. Correction Factor(dB/m) = Antenna Factor(dB/m) + Cable Factor(dB) – Pre-Amplifier Factor(dB)
3. The other emission levels were very low against the limit.
4. Margin value = Emission Level – Limit value
5. " * ": Fundamental frequency.

802.11ac (VHT20)

CHANNEL	TX Channel 52	DETECTOR FUNCTION	Peak (PK)
FREQUENCY RANGE	1GHz ~ 40GHz		Average (AV)

ANTENNA POLARITY & TEST DISTANCE: HORIZONTAL AT 3 M

NO.	FREQ. (MHz)	EMISSION LEVEL (dBuV/m)	LIMIT (dBuV/m)	MARGIN (dB)	ANTENNA HEIGHT (m)	TABLE ANGLE (Degree)	RAW VALUE (dBuV)	CORRECTION FACTOR (dB/m)
1	5150.00	49.5 PK	74.0	-24.5	1.00 H	65	45.5	4.0
2	5150.00	36.7 AV	54.0	-17.3	1.00 H	65	32.7	4.0
3	*5260.00	112.8 PK			1.00 H	65	108.6	4.2
4	*5260.00	102.5 AV			1.00 H	65	98.3	4.2
5	#10520.00	53.0 PK	74.0	-21.0	1.07 H	103	39.2	13.8
6	#10520.00	40.8 AV	54.0	-13.2	1.07 H	103	27.0	13.8
7	15780.00	45.3 PK	74.0	-28.7	1.55 H	294	31.2	14.1
8	15780.00	33.5 AV	54.0	-20.5	1.55 H	294	19.4	14.1

ANTENNA POLARITY & TEST DISTANCE: VERTICAL AT 3 M

NO.	FREQ. (MHz)	EMISSION LEVEL (dBuV/m)	LIMIT (dBuV/m)	MARGIN (dB)	ANTENNA HEIGHT (m)	TABLE ANGLE (Degree)	RAW VALUE (dBuV)	CORRECTION FACTOR (dB/m)
1	5150.00	48.3 PK	74.0	-25.7	1.10 V	358	44.3	4.0
2	5150.00	35.9 AV	54.0	-18.1	1.10 V	358	31.9	4.0
3	*5260.00	108.9 PK			1.10 V	358	104.7	4.2
4	*5260.00	98.6 AV			1.10 V	358	94.4	4.2
5	#10520.00	53.8 PK	74.0	-20.2	1.43 V	214	40.0	13.8
6	#10520.00	41.3 AV	54.0	-12.7	1.43 V	214	27.5	13.8
7	15780.00	45.3 PK	74.0	-28.7	1.59 V	171	31.2	14.1
8	15780.00	33.6 AV	54.0	-20.4	1.59 V	171	19.5	14.1

REMARKS:

- Emission Level(dBuV/m) = Raw Value(dBuV) + Correction Factor(dB/m)
- Correction Factor(dB/m) = Antenna Factor(dB/m) + Cable Factor(dB) – Pre-Amplifier Factor(dB)
- The other emission levels were very low against the limit.
- Margin value = Emission Level – Limit value
- " * ": Fundamental frequency.
- " # ": The radiated frequency is out of the restricted band.

CHANNEL	TX Channel 60	DETECTOR FUNCTION	Peak (PK)
FREQUENCY RANGE	1GHz ~ 40GHz		Average (AV)

ANTENNA POLARITY & TEST DISTANCE: HORIZONTAL AT 3 M

NO.	FREQ. (MHz)	EMISSION LEVEL (dBuV/m)	LIMIT (dBuV/m)	MARGIN (dB)	ANTENNA HEIGHT (m)	TABLE ANGLE (Degree)	RAW VALUE (dBuV)	CORRECTION FACTOR (dB/m)
1	*5300.00	112.8 PK			1.05 H	63	108.5	4.3
2	*5300.00	101.6 AV			1.05 H	63	97.3	4.3
3	5350.00	51.8 PK	74.0	-22.2	1.05 H	63	47.4	4.4
4	5350.00	38.8 AV	54.0	-15.2	1.05 H	63	34.4	4.4
5	10600.00	53.7 PK	74.0	-20.3	1.05 H	88	39.9	13.8
6	10600.00	41.3 AV	54.0	-12.7	1.05 H	88	27.5	13.8
7	15900.00	45.5 PK	74.0	-28.5	1.53 H	305	32.3	13.2
8	15900.00	33.9 AV	54.0	-20.1	1.53 H	305	20.7	13.2

ANTENNA POLARITY & TEST DISTANCE: VERTICAL AT 3 M

NO.	FREQ. (MHz)	EMISSION LEVEL (dBuV/m)	LIMIT (dBuV/m)	MARGIN (dB)	ANTENNA HEIGHT (m)	TABLE ANGLE (Degree)	RAW VALUE (dBuV)	CORRECTION FACTOR (dB/m)
1	*5300.00	109.6 PK			1.08 V	22	105.3	4.3
2	*5300.00	99.1 AV			1.08 V	22	94.8	4.3
3	5350.00	48.4 PK	74.0	-25.6	1.08 V	360	44.0	4.4
4	5350.00	36.1 AV	54.0	-17.9	1.08 V	360	31.7	4.4
5	10600.00	53.6 PK	74.0	-20.4	1.40 V	205	39.8	13.8
6	10600.00	41.1 AV	54.0	-12.9	1.40 V	205	27.3	13.8
7	15900.00	44.9 PK	74.0	-29.1	1.62 V	169	31.7	13.2
8	15900.00	33.4 AV	54.0	-20.6	1.62 V	169	20.2	13.2

REMARKS:

1. Emission Level(dBuV/m) = Raw Value(dBuV) + Correction Factor(dB/m)
2. Correction Factor(dB/m) = Antenna Factor(dB/m) + Cable Factor(dB) – Pre-Amplifier Factor(dB)
3. The other emission levels were very low against the limit.
4. Margin value = Emission Level – Limit value
5. " * ": Fundamental frequency.

CHANNEL	TX Channel 64	DETECTOR FUNCTION	Peak (PK)
FREQUENCY RANGE	1GHz ~ 40GHz		Average (AV)

ANTENNA POLARITY & TEST DISTANCE: HORIZONTAL AT 3 M

NO.	FREQ. (MHz)	EMISSION LEVEL (dBuV/m)	LIMIT (dBuV/m)	MARGIN (dB)	ANTENNA HEIGHT (m)	TABLE ANGLE (Degree)	RAW VALUE (dBuV)	CORRECTION FACTOR (dB/m)
1	*5320.00	112.1 PK			1.04 H	66	107.8	4.3
2	*5320.00	101.5 AV			1.04 H	66	97.2	4.3
3	5350.00	70.8 PK	74.0	-3.2	1.04 H	66	66.4	4.4
4	5350.00	53.9 AV	54.0	-0.1	1.04 H	66	49.5	4.4
5	10640.00	53.7 PK	74.0	-20.3	1.08 H	84	39.7	14.0
6	10640.00	41.1 AV	54.0	-12.9	1.08 H	84	27.1	14.0
7	15960.00	45.9 PK	74.0	-28.1	1.58 H	308	32.4	13.5
8	15960.00	34.3 AV	54.0	-19.7	1.58 H	308	20.8	13.5

ANTENNA POLARITY & TEST DISTANCE: VERTICAL AT 3 M

NO.	FREQ. (MHz)	EMISSION LEVEL (dBuV/m)	LIMIT (dBuV/m)	MARGIN (dB)	ANTENNA HEIGHT (m)	TABLE ANGLE (Degree)	RAW VALUE (dBuV)	CORRECTION FACTOR (dB/m)
1	*5320.00	109.7 PK			1.05 V	25	105.4	4.3
2	*5320.00	99.2 AV			1.05 V	25	94.9	4.3
3	5350.00	65.5 PK	74.0	-8.5	1.05 V	25	61.1	4.4
4	5350.00	49.7 AV	54.0	-4.3	1.05 V	25	45.3	4.4
5	10640.00	53.9 PK	74.0	-20.1	1.37 V	202	39.9	14.0
6	10640.00	41.3 AV	54.0	-12.7	1.37 V	202	27.3	14.0
7	15960.00	45.7 PK	74.0	-28.3	1.56 V	158	32.2	13.5
8	15960.00	33.9 AV	54.0	-20.1	1.56 V	158	20.4	13.5

REMARKS:

1. Emission Level(dBuV/m) = Raw Value(dBuV) + Correction Factor(dB/m)
2. Correction Factor(dB/m) = Antenna Factor(dB/m) + Cable Factor(dB) – Pre-Amplifier Factor(dB)
3. The other emission levels were very low against the limit.
4. Margin value = Emission Level – Limit value
5. " * ": Fundamental frequency.

802.11ac (VHT40)

CHANNEL	TX Channel 54	DETECTOR FUNCTION	Peak (PK)
FREQUENCY RANGE	1GHz ~ 40GHz		Average (AV)

ANTENNA POLARITY & TEST DISTANCE: HORIZONTAL AT 3 M

NO.	FREQ. (MHz)	EMISSION LEVEL (dBuV/m)	LIMIT (dBuV/m)	MARGIN (dB)	ANTENNA HEIGHT (m)	TABLE ANGLE (Degree)	RAW VALUE (dBuV)	CORRECTION FACTOR (dB/m)
1	5150.00	56.9 PK	74.0	-17.1	1.03 H	65	52.9	4.0
2	5150.00	43.7 AV	54.0	-10.3	1.03 H	65	39.7	4.0
3	*5270.00	111.2 PK			1.03 H	65	107.0	4.2
4	*5270.00	100.3 AV			1.03 H	65	96.1	4.2
5	5350.00	53.5 PK	74.0	-20.5	1.03 H	65	49.1	4.4
6	5350.00	41.6 AV	54.0	-12.4	1.03 H	65	37.2	4.4
7	#10540.00	52.7 PK	74.0	-21.3	1.17 H	86	39.0	13.7
8	#10540.00	40.3 AV	54.0	-13.7	1.17 H	86	26.6	13.7
9	15810.00	45.3 PK	74.0	-28.7	1.58 H	311	31.3	14.0
10	15810.00	33.8 AV	54.0	-20.2	1.58 H	311	19.8	14.0

ANTENNA POLARITY & TEST DISTANCE: VERTICAL AT 3 M

NO.	FREQ. (MHz)	EMISSION LEVEL (dBuV/m)	LIMIT (dBuV/m)	MARGIN (dB)	ANTENNA HEIGHT (m)	TABLE ANGLE (Degree)	RAW VALUE (dBuV)	CORRECTION FACTOR (dB/m)
1	5150.00	52.5 PK	74.0	-21.5	1.10 V	35	48.5	4.0
2	5150.00	39.5 AV	54.0	-14.5	1.10 V	35	35.5	4.0
3	*5270.00	107.4 PK			1.10 V	35	103.2	4.2
4	*5270.00	95.7 AV			1.10 V	35	91.5	4.2
5	5350.00	49.3 PK	74.0	-24.7	1.10 V	35	44.9	4.4
6	5350.00	37.5 AV	54.0	-16.5	1.10 V	35	33.1	4.4
7	#10540.00	52.8 PK	74.0	-21.2	1.35 V	206	39.1	13.7
8	#10540.00	40.2 AV	54.0	-13.8	1.35 V	206	26.5	13.7
9	15810.00	45.0 PK	74.0	-29.0	1.48 V	157	31.0	14.0
10	15810.00	33.4 AV	54.0	-20.6	1.48 V	157	19.4	14.0

REMARKS:

- Emission Level(dBuV/m) = Raw Value(dBuV) + Correction Factor(dB/m)
- Correction Factor(dB/m) = Antenna Factor(dB/m) + Cable Factor(dB) – Pre-Amplifier Factor(dB)
- The other emission levels were very low against the limit.
- Margin value = Emission Level – Limit value
- " * ": Fundamental frequency.
- " # ": The radiated frequency is out of the restricted band.

CHANNEL	TX Channel 62	DETECTOR FUNCTION	Peak (PK)
FREQUENCY RANGE	1GHz ~ 40GHz		Average (AV)

ANTENNA POLARITY & TEST DISTANCE: HORIZONTAL AT 3 M

NO.	FREQ. (MHz)	EMISSION LEVEL (dBuV/m)	LIMIT (dBuV/m)	MARGIN (dB)	ANTENNA HEIGHT (m)	TABLE ANGLE (Degree)	RAW VALUE (dBuV)	CORRECTION FACTOR (dB/m)
1	*5310.00	106.2 PK			1.03 H	66	101.9	4.3
2	*5310.00	95.6 AV			1.03 H	66	91.3	4.3
3	5350.00	67.2 PK	74.0	-6.8	1.03 H	66	62.8	4.4
4	5350.00	53.7 AV	54.0	-0.3	1.03 H	66	49.3	4.4
5	10620.00	50.8 PK	74.0	-23.2	1.02 H	72	36.9	13.9
6	10620.00	38.6 AV	54.0	-15.4	1.02 H	72	24.7	13.9
7	15930.00	45.5 PK	74.0	-28.5	1.54 H	300	32.2	13.3
8	15930.00	34.1 AV	54.0	-19.9	1.54 H	300	20.8	13.3

ANTENNA POLARITY & TEST DISTANCE: VERTICAL AT 3 M

NO.	FREQ. (MHz)	EMISSION LEVEL (dBuV/m)	LIMIT (dBuV/m)	MARGIN (dB)	ANTENNA HEIGHT (m)	TABLE ANGLE (Degree)	RAW VALUE (dBuV)	CORRECTION FACTOR (dB/m)
1	*5310.00	104.7 PK			1.05 V	14	100.4	4.3
2	*5310.00	93.4 AV			1.05 V	14	89.1	4.3
3	5350.00	63.2 PK	74.0	-10.8	1.05 V	14	58.8	4.4
4	5350.00	49.4 AV	54.0	-4.6	1.05 V	14	45.0	4.4
5	10620.00	51.1 PK	74.0	-22.9	1.45 V	195	37.2	13.9
6	10620.00	38.8 AV	54.0	-15.2	1.45 V	195	24.9	13.9
7	15930.00	45.0 PK	74.0	-29.0	1.61 V	166	31.7	13.3
8	15930.00	33.5 AV	54.0	-20.5	1.61 V	166	20.2	13.3

REMARKS:

1. Emission Level(dBuV/m) = Raw Value(dBuV) + Correction Factor(dB/m)
2. Correction Factor(dB/m) = Antenna Factor(dB/m) + Cable Factor(dB) – Pre-Amplifier Factor(dB)
3. The other emission levels were very low against the limit.
4. Margin value = Emission Level – Limit value
5. " * ": Fundamental frequency.

802.11ac (VHT80)

CHANNEL	TX Channel 58	DETECTOR FUNCTION	Peak (PK)
FREQUENCY RANGE	1GHz ~ 40GHz		Average (AV)

ANTENNA POLARITY & TEST DISTANCE: HORIZONTAL AT 3 M

NO.	FREQ. (MHz)	EMISSION LEVEL (dBuV/m)	LIMIT (dBuV/m)	MARGIN (dB)	ANTENNA HEIGHT (m)	TABLE ANGLE (Degree)	RAW VALUE (dBuV)	CORRECTION FACTOR (dB/m)
1	5150.00	59.8 PK	74.0	-14.2	1.00 H	66	55.8	4.0
2	5150.00	47.2 AV	54.0	-6.8	1.00 H	66	43.2	4.0
3	*5290.00	104.6 PK			1.00 H	66	100.3	4.3
4	*5290.00	94.9 AV			1.00 H	66	90.6	4.3
5	5350.00	64.4 PK	74.0	-9.6	1.00 H	66	60.0	4.4
6	5350.00	53.7 AV	54.0	-0.3	1.00 H	66	49.3	4.4
7	#10580.00	50.0 PK	74.0	-24.0	1.04 H	98	36.1	13.9
8	#10580.00	36.6 AV	54.0	-17.4	1.04 H	98	22.7	13.9
9	15870.00	46.3 PK	74.0	-27.7	1.49 H	306	32.9	13.4
10	15870.00	34.7 AV	54.0	-19.3	1.49 H	306	21.3	13.4

ANTENNA POLARITY & TEST DISTANCE: VERTICAL AT 3 M

NO.	FREQ. (MHz)	EMISSION LEVEL (dBuV/m)	LIMIT (dBuV/m)	MARGIN (dB)	ANTENNA HEIGHT (m)	TABLE ANGLE (Degree)	RAW VALUE (dBuV)	CORRECTION FACTOR (dB/m)
1	5150.00	56.6 PK	74.0	-17.4	1.09 V	34	52.6	4.0
2	5150.00	44.1 AV	54.0	-9.9	1.09 V	34	40.1	4.0
3	*5290.00	102.1 PK			1.09 V	34	97.8	4.3
4	*5290.00	91.5 AV			1.09 V	34	87.2	4.3
5	5350.00	61.2 PK	74.0	-12.8	1.09 V	34	56.8	4.4
6	5350.00	50.1 AV	54.0	-3.9	1.09 V	34	45.7	4.4
7	#10580.00	50.3 PK	74.0	-23.7	1.40 V	204	36.4	13.9
8	#10580.00	37.1 AV	54.0	-16.9	1.40 V	204	23.2	13.9
9	15870.00	45.5 PK	74.0	-28.5	1.63 V	166	32.1	13.4
10	15870.00	33.9 AV	54.0	-20.1	1.63 V	166	20.5	13.4

REMARKS:

- Emission Level(dBuV/m) = Raw Value(dBuV) + Correction Factor(dB/m)
- Correction Factor(dB/m) = Antenna Factor(dB/m) + Cable Factor(dB) – Pre-Amplifier Factor(dB)
- The other emission levels were very low against the limit.
- Margin value = Emission Level – Limit value
- " * ": Fundamental frequency.
- " # ": The radiated frequency is out of the restricted band.

Radio 1
802.11a

CHANNEL	TX Channel 100	DETECTOR FUNCTION	Peak (PK)
FREQUENCY RANGE	1GHz ~ 40GHz		Average (AV)

ANTENNA POLARITY & TEST DISTANCE: HORIZONTAL AT 3 M

NO.	FREQ. (MHz)	EMISSION LEVEL (dBuV/m)	LIMIT (dBuV/m)	MARGIN (dB)	ANTENNA HEIGHT (m)	TABLE ANGLE (Degree)	RAW VALUE (dBuV)	CORRECTION FACTOR (dB/m)
1	#5470.00	69.4 PK	74.0	-4.6	1.16 H	292	64.9	4.5
2	#5470.00	53.8 AV	54.0	-0.2	1.16 H	292	49.3	4.5
3	*5500.00	115.5 PK			1.16 H	292	111.0	4.5
4	*5500.00	103.6 AV			1.16 H	292	99.1	4.5
5	11000.00	58.3 PK	74.0	-15.7	2.12 H	174	43.5	14.8
6	11000.00	44.3 AV	54.0	-9.7	2.12 H	174	29.5	14.8
7	#16500.00	54.1 PK	74.0	-19.9	1.15 H	178	38.5	15.6
8	#16500.00	41.5 AV	54.0	-12.5	1.15 H	178	25.9	15.6

ANTENNA POLARITY & TEST DISTANCE: VERTICAL AT 3 M

NO.	FREQ. (MHz)	EMISSION LEVEL (dBuV/m)	LIMIT (dBuV/m)	MARGIN (dB)	ANTENNA HEIGHT (m)	TABLE ANGLE (Degree)	RAW VALUE (dBuV)	CORRECTION FACTOR (dB/m)
1	#5470.00	67.7 PK	74.0	-6.3	1.65 V	250	63.2	4.5
2	#5470.00	52.2 AV	54.0	-1.8	1.65 V	250	47.7	4.5
3	*5500.00	109.5 PK			1.65 V	250	105.0	4.5
4	*5500.00	97.4 AV			1.65 V	250	92.9	4.5
5	11000.00	50.5 PK	74.0	-23.5	3.91 V	186	35.7	14.8
6	11000.00	38.5 AV	54.0	-15.5	3.91 V	186	23.7	14.8
7	#16500.00	52.4 PK	74.0	-21.6	2.41 V	174	36.8	15.6
8	#16500.00	40.8 AV	54.0	-13.2	2.41 V	174	25.2	15.6

REMARKS:

1. Emission Level(dBuV/m) = Raw Value(dBuV) + Correction Factor(dB/m)
2. Correction Factor(dB/m) = Antenna Factor(dB/m) + Cable Factor(dB) – Pre-Amplifier Factor(dB)
3. The other emission levels were very low against the limit.
4. Margin value = Emission Level – Limit value
5. " * ": Fundamental frequency.
6. " # ": The radiated frequency is out of the restricted band.

CHANNEL	TX Channel 116	DETECTOR FUNCTION	Peak (PK)
FREQUENCY RANGE	1GHz ~ 40GHz		Average (AV)

ANTENNA POLARITY & TEST DISTANCE: HORIZONTAL AT 3 M

NO.	FREQ. (MHz)	EMISSION LEVEL (dBuV/m)	LIMIT (dBuV/m)	MARGIN (dB)	ANTENNA HEIGHT (m)	TABLE ANGLE (Degree)	RAW VALUE (dBuV)	CORRECTION FACTOR (dB/m)
1	#5470.00	50.0 PK	74.0	-24.0	1.16 H	265	45.5	4.5
2	#5470.00	37.6 AV	54.0	-16.4	1.16 H	265	33.1	4.5
3	*5580.00	116.9 PK			1.16 H	265	112.3	4.6
4	*5580.00	105.6 AV			1.16 H	265	101.0	4.6
5	11160.00	61.8 PK	74.0	-12.2	2.15 H	167	47.4	14.4
6	11160.00	47.8 AV	54.0	-6.2	2.15 H	167	33.4	14.4
7	#16740.00	53.7 PK	74.0	-20.3	1.10 H	194	37.2	16.5
8	#16740.00	41.2 AV	54.0	-12.8	1.10 H	194	24.7	16.5

ANTENNA POLARITY & TEST DISTANCE: VERTICAL AT 3 M

NO.	FREQ. (MHz)	EMISSION LEVEL (dBuV/m)	LIMIT (dBuV/m)	MARGIN (dB)	ANTENNA HEIGHT (m)	TABLE ANGLE (Degree)	RAW VALUE (dBuV)	CORRECTION FACTOR (dB/m)
1	#5470.00	47.9 PK	74.0	-26.1	1.70 V	255	43.4	4.5
2	#5470.00	35.9 AV	54.0	-18.1	1.70 V	255	31.4	4.5
3	*5580.00	111.0 PK			1.70 V	255	106.4	4.6
4	*5580.00	99.4 AV			1.70 V	255	94.8	4.6
5	11160.00	54.7 PK	74.0	-19.3	3.95 V	197	40.3	14.4
6	11160.00	42.1 AV	54.0	-11.9	3.95 V	197	27.7	14.4
7	#16740.00	52.7 PK	74.0	-21.3	2.46 V	161	36.2	16.5
8	#16740.00	41.1 AV	54.0	-12.9	2.46 V	161	24.6	16.5

REMARKS:

1. Emission Level(dBuV/m) = Raw Value(dBuV) + Correction Factor(dB/m)
2. Correction Factor(dB/m) = Antenna Factor(dB/m) + Cable Factor(dB) – Pre-Amplifier Factor(dB)
3. The other emission levels were very low against the limit.
4. Margin value = Emission Level – Limit value
5. " * ": Fundamental frequency.
6. " # ": The radiated frequency is out of the restricted band.

CHANNEL	TX Channel 140	DETECTOR FUNCTION	Peak (PK)
FREQUENCY RANGE	1GHz ~ 40GHz		Average (AV)

ANTENNA POLARITY & TEST DISTANCE: HORIZONTAL AT 3 M

NO.	FREQ. (MHz)	EMISSION LEVEL (dBuV/m)	LIMIT (dBuV/m)	MARGIN (dB)	ANTENNA HEIGHT (m)	TABLE ANGLE (Degree)	RAW VALUE (dBuV)	CORRECTION FACTOR (dB/m)
1	*5700.00	113.6 PK			1.25 H	262	108.8	4.8
2	*5700.00	102.4 AV			1.25 H	262	97.6	4.8
3	#5725.00	71.3 PK	74.0	-2.7	1.25 H	262	66.4	4.9
4	#5725.00	53.7 AV	54.0	-0.3	1.25 H	262	48.8	4.9
5	11400.00	57.9 PK	74.0	-16.1	2.15 H	180	43.5	14.4
6	11400.00	44.1 AV	54.0	-9.9	2.15 H	180	29.7	14.4
7	#17100.00	54.3 PK	74.0	-19.7	1.21 H	172	35.8	18.5
8	#17100.00	41.6 AV	54.0	-12.4	1.21 H	172	23.1	18.5

ANTENNA POLARITY & TEST DISTANCE: VERTICAL AT 3 M

NO.	FREQ. (MHz)	EMISSION LEVEL (dBuV/m)	LIMIT (dBuV/m)	MARGIN (dB)	ANTENNA HEIGHT (m)	TABLE ANGLE (Degree)	RAW VALUE (dBuV)	CORRECTION FACTOR (dB/m)
1	*5700.00	107.5 PK			1.69 V	243	102.7	4.8
2	*5700.00	96.3 AV			1.69 V	243	91.5	4.8
3	#5725.00	69.8 PK	74.0	-4.2	1.69 V	243	64.9	4.9
4	#5725.00	51.9 AV	54.0	-2.1	1.69 V	243	47.0	4.9
5	11400.00	50.5 PK	74.0	-23.5	3.87 V	198	36.1	14.4
6	11400.00	38.4 AV	54.0	-15.6	3.87 V	198	24.0	14.4
7	#17100.00	52.4 PK	74.0	-21.6	2.36 V	174	33.9	18.5
8	#17100.00	40.5 AV	54.0	-13.5	2.36 V	174	22.0	18.5

REMARKS:

1. Emission Level(dBuV/m) = Raw Value(dBuV) + Correction Factor(dB/m)
2. Correction Factor(dB/m) = Antenna Factor(dB/m) + Cable Factor(dB) – Pre-Amplifier Factor(dB)
3. The other emission levels were very low against the limit.
4. Margin value = Emission Level – Limit value
5. " * ": Fundamental frequency.
6. " # ": The radiated frequency is out of the restricted band.

CHANNEL	TX Channel 144	DETECTOR FUNCTION	Peak (PK)
FREQUENCY RANGE	1GHz ~ 40GHz		Average (AV)

ANTENNA POLARITY & TEST DISTANCE: HORIZONTAL AT 3 M

NO.	FREQ. (MHz)	EMISSION LEVEL (dBuV/m)	LIMIT (dBuV/m)	MARGIN (dB)	ANTENNA HEIGHT (m)	TABLE ANGLE (Degree)	RAW VALUE (dBuV)	CORRECTION FACTOR (dB/m)
1	#5470.00	49.4 PK	74.0	-24.6	1.93 H	298	44.9	4.5
2	#5470.00	37.9 AV	54.0	-16.1	1.93 H	298	33.4	4.5
3	*5720.00	117.3 PK			1.93 H	298	112.4	4.9
4	*5720.00	105.7 AV			1.93 H	298	100.8	4.9
5	#5850.00	54.0 PK	74.0	-20.0	1.93 H	298	48.9	5.1
6	#5850.00	41.4 AV	54.0	-12.6	1.93 H	298	36.3	5.1
7	11440.00	61.3 PK	74.0	-12.7	2.11 H	160	47.1	14.2
8	11440.00	47.6 AV	54.0	-6.4	2.11 H	160	33.4	14.2
9	#17160.00	53.5 PK	74.0	-20.5	1.08 H	184	35.2	18.3
10	#17160.00	41.0 AV	54.0	-13.0	1.08 H	184	22.7	18.3

ANTENNA POLARITY & TEST DISTANCE: VERTICAL AT 3 M

NO.	FREQ. (MHz)	EMISSION LEVEL (dBuV/m)	LIMIT (dBuV/m)	MARGIN (dB)	ANTENNA HEIGHT (m)	TABLE ANGLE (Degree)	RAW VALUE (dBuV)	CORRECTION FACTOR (dB/m)
1	#5470.00	48.4 PK	74.0	-25.6	1.71 V	257	43.9	4.5
2	#5470.00	36.2 AV	54.0	-17.8	1.71 V	257	31.7	4.5
3	*5720.00	111.2 PK			1.71 V	257	106.3	4.9
4	*5720.00	99.5 AV			1.71 V	257	94.6	4.9
5	#5850.00	52.3 PK	74.0	-21.7	1.71 V	257	47.2	5.1
6	#5850.00	39.8 AV	54.0	-14.2	1.71 V	257	34.7	5.1
7	11440.00	54.5 PK	74.0	-19.5	3.99 V	191	40.3	14.2
8	11440.00	41.7 AV	54.0	-12.3	3.99 V	191	27.5	14.2
9	#17160.00	52.3 PK	74.0	-21.7	2.50 V	154	34.0	18.3
10	#17160.00	41.0 AV	54.0	-13.0	2.50 V	154	22.7	18.3

REMARKS:

1. Emission Level(dBuV/m) = Raw Value(dBuV) + Correction Factor(dB/m)
2. Correction Factor(dB/m) = Antenna Factor(dB/m) + Cable Factor(dB) – Pre-Amplifier Factor(dB)
3. The other emission levels were very low against the limit.
4. Margin value = Emission Level – Limit value
5. " * ": Fundamental frequency.
6. " # ": The radiated frequency is out of the restricted band.

802.11ac (VHT20)

CHANNEL	TX Channel 100	DETECTOR FUNCTION	Peak (PK)
FREQUENCY RANGE	1GHz ~ 40GHz		Average (AV)

ANTENNA POLARITY & TEST DISTANCE: HORIZONTAL AT 3 M

NO.	FREQ. (MHz)	EMISSION LEVEL (dBuV/m)	LIMIT (dBuV/m)	MARGIN (dB)	ANTENNA HEIGHT (m)	TABLE ANGLE (Degree)	RAW VALUE (dBuV)	CORRECTION FACTOR (dB/m)
1	#5470.00	69.1 PK	74.0	-4.9	1.15 H	284	64.6	4.5
2	#5470.00	53.7 AV	54.0	-0.3	1.15 H	284	49.2	4.5
3	*5500.00	116.1 PK			1.15 H	284	111.6	4.5
4	*5500.00	104.6 AV			1.15 H	284	100.1	4.5
5	11000.00	57.9 PK	74.0	-16.1	2.07 H	172	43.1	14.8
6	11000.00	44.1 AV	54.0	-9.9	2.07 H	172	29.3	14.8
7	#16500.00	53.8 PK	74.0	-20.2	1.10 H	165	38.2	15.6
8	#16500.00	41.1 AV	54.0	-12.9	1.10 H	165	25.5	15.6

ANTENNA POLARITY & TEST DISTANCE: VERTICAL AT 3 M

NO.	FREQ. (MHz)	EMISSION LEVEL (dBuV/m)	LIMIT (dBuV/m)	MARGIN (dB)	ANTENNA HEIGHT (m)	TABLE ANGLE (Degree)	RAW VALUE (dBuV)	CORRECTION FACTOR (dB/m)
1	#5470.00	67.2 PK	74.0	-6.8	1.64 V	257	62.7	4.5
2	#5470.00	51.9 AV	54.0	-2.1	1.64 V	257	47.4	4.5
3	*5500.00	110.3 PK			1.64 V	257	105.8	4.5
4	*5500.00	97.9 AV			1.64 V	257	93.4	4.5
5	11000.00	50.7 PK	74.0	-23.3	3.88 V	175	35.9	14.8
6	11000.00	38.4 AV	54.0	-15.6	3.88 V	175	23.6	14.8
7	#16500.00	52.6 PK	74.0	-21.4	2.40 V	167	37.0	15.6
8	#16500.00	41.1 AV	54.0	-12.9	2.40 V	167	25.5	15.6

REMARKS:

- Emission Level(dBuV/m) = Raw Value(dBuV) + Correction Factor(dB/m)
- Correction Factor(dB/m) = Antenna Factor(dB/m) + Cable Factor(dB) – Pre-Amplifier Factor(dB)
- The other emission levels were very low against the limit.
- Margin value = Emission Level – Limit value
- " * ": Fundamental frequency.
- " # ": The radiated frequency is out of the restricted band.

CHANNEL	TX Channel 116	DETECTOR FUNCTION	Peak (PK)
FREQUENCY RANGE	1GHz ~ 40GHz		Average (AV)

ANTENNA POLARITY & TEST DISTANCE: HORIZONTAL AT 3 M

NO.	FREQ. (MHz)	EMISSION LEVEL (dBuV/m)	LIMIT (dBuV/m)	MARGIN (dB)	ANTENNA HEIGHT (m)	TABLE ANGLE (Degree)	RAW VALUE (dBuV)	CORRECTION FACTOR (dB/m)
1	#5470.00	48.7 PK	74.0	-25.3	1.10 H	274	44.2	4.5
2	#5470.00	37.4 AV	54.0	-16.6	1.10 H	274	32.9	4.5
3	*5580.00	116.9 PK			1.10 H	274	112.3	4.6
4	*5580.00	105.5 AV			1.10 H	274	100.9	4.6
5	#5725.00	50.4 PK	74.0	-23.6	1.10 H	274	45.5	4.9
6	#5725.00	37.6 AV	54.0	-16.4	1.10 H	274	32.7	4.9
7	11160.00	61.4 PK	74.0	-12.6	2.15 H	175	47.0	14.4
8	11160.00	47.5 AV	54.0	-6.5	2.15 H	175	33.1	14.4
9	#16740.00	54.2 PK	74.0	-19.8	1.13 H	205	37.7	16.5
10	#16740.00	41.6 AV	54.0	-12.4	1.13 H	205	25.1	16.5

ANTENNA POLARITY & TEST DISTANCE: VERTICAL AT 3 M

NO.	FREQ. (MHz)	EMISSION LEVEL (dBuV/m)	LIMIT (dBuV/m)	MARGIN (dB)	ANTENNA HEIGHT (m)	TABLE ANGLE (Degree)	RAW VALUE (dBuV)	CORRECTION FACTOR (dB/m)
1	#5470.00	47.1 PK	74.0	-26.9	1.72 V	271	42.6	4.5
2	#5470.00	35.4 AV	54.0	-18.6	1.72 V	271	30.9	4.5
3	*5580.00	110.5 PK			1.72 V	271	105.9	4.6
4	*5580.00	99.1 AV			1.72 V	271	94.5	4.6
5	#5725.00	49.3 PK	74.0	-24.7	1.72 V	271	44.4	4.9
6	#5725.00	35.6 AV	54.0	-18.4	1.72 V	271	30.7	4.9
7	11160.00	54.2 PK	74.0	-19.8	3.99 V	209	39.8	14.4
8	11160.00	41.7 AV	54.0	-12.3	3.99 V	209	27.3	14.4
9	#16740.00	52.4 PK	74.0	-21.6	2.51 V	173	35.9	16.5
10	#16740.00	40.8 AV	54.0	-13.2	2.51 V	173	24.3	16.5

REMARKS:

- Emission Level(dBuV/m) = Raw Value(dBuV) + Correction Factor(dB/m)
- Correction Factor(dB/m) = Antenna Factor(dB/m) + Cable Factor(dB) – Pre-Amplifier Factor(dB)
- The other emission levels were very low against the limit.
- Margin value = Emission Level – Limit value
- " * ": Fundamental frequency.
- " # ": The radiated frequency is out of the restricted band.

CHANNEL	TX Channel 140	DETECTOR FUNCTION	Peak (PK)
FREQUENCY RANGE	1GHz ~ 40GHz		Average (AV)

ANTENNA POLARITY & TEST DISTANCE: HORIZONTAL AT 3 M

NO.	FREQ. (MHz)	EMISSION LEVEL (dBuV/m)	LIMIT (dBuV/m)	MARGIN (dB)	ANTENNA HEIGHT (m)	TABLE ANGLE (Degree)	RAW VALUE (dBuV)	CORRECTION FACTOR (dB/m)
1	*5700.00	113.4 PK			1.14 H	292	108.6	4.8
2	*5700.00	102.7 AV			1.14 H	292	97.9	4.8
3	#5725.00	69.8 PK	74.0	-4.2	1.14 H	292	64.9	4.9
4	#5725.00	53.7 AV	54.0	-0.3	1.14 H	292	48.8	4.9
5	11400.00	57.8 PK	74.0	-16.2	2.11 H	187	43.4	14.4
6	11400.00	44.1 AV	54.0	-9.9	2.11 H	187	29.7	14.4
7	#17100.00	53.8 PK	74.0	-20.2	1.13 H	157	35.3	18.5
8	#17100.00	41.1 AV	54.0	-12.9	1.13 H	157	22.6	18.5

ANTENNA POLARITY & TEST DISTANCE: VERTICAL AT 3 M

NO.	FREQ. (MHz)	EMISSION LEVEL (dBuV/m)	LIMIT (dBuV/m)	MARGIN (dB)	ANTENNA HEIGHT (m)	TABLE ANGLE (Degree)	RAW VALUE (dBuV)	CORRECTION FACTOR (dB/m)
1	*5700.00	107.6 PK			1.64 V	246	102.8	4.8
2	*5700.00	96.6 AV			1.64 V	246	91.8	4.8
3	#5725.00	70.1 PK	74.0	-3.9	1.64 V	246	65.2	4.9
4	#5725.00	51.9 AV	54.0	-2.1	1.64 V	246	47.0	4.9
5	11400.00	50.3 PK	74.0	-23.7	3.85 V	187	35.9	14.4
6	11400.00	38.5 AV	54.0	-15.5	3.85 V	187	24.1	14.4
7	#17100.00	52.5 PK	74.0	-21.5	2.40 V	180	34.0	18.5
8	#17100.00	40.7 AV	54.0	-13.3	2.40 V	180	22.2	18.5

REMARKS:

- Emission Level(dBuV/m) = Raw Value(dBuV) + Correction Factor(dB/m)
- Correction Factor(dB/m) = Antenna Factor(dB/m) + Cable Factor(dB) – Pre-Amplifier Factor(dB)
- The other emission levels were very low against the limit.
- Margin value = Emission Level – Limit value
- " * ": Fundamental frequency.
- " # ": The radiated frequency is out of the restricted band.

802.11ac (VHT40)

CHANNEL	TX Channel 102	DETECTOR FUNCTION	Peak (PK)
FREQUENCY RANGE	1GHz ~ 40GHz		Average (AV)

ANTENNA POLARITY & TEST DISTANCE: HORIZONTAL AT 3 M								
NO.	FREQ. (MHz)	EMISSION LEVEL (dBuV/m)	LIMIT (dBuV/m)	MARGIN (dB)	ANTENNA HEIGHT (m)	TABLE ANGLE (Degree)	RAW VALUE (dBuV)	CORRECTION FACTOR (dB/m)
1	#5470.00	68.5 PK	74.0	-5.5	1.05 H	269	64.0	4.5
2	#5470.00	53.9 AV	54.0	-0.1	1.05 H	269	49.4	4.5
3	*5510.00	110.5 PK			1.05 H	269	105.9	4.6
4	*5510.00	99.8 AV			1.05 H	269	95.2	4.6
5	11020.00	55.8 PK	74.0	-18.2	2.13 H	173	41.1	14.7
6	11020.00	42.0 AV	54.0	-12.0	2.13 H	173	27.3	14.7
7	#16530.00	54.1 PK	74.0	-19.9	1.17 H	194	38.3	15.8
8	#16530.00	41.2 AV	54.0	-12.8	1.17 H	194	25.4	15.8

ANTENNA POLARITY & TEST DISTANCE: VERTICAL AT 3 M								
NO.	FREQ. (MHz)	EMISSION LEVEL (dBuV/m)	LIMIT (dBuV/m)	MARGIN (dB)	ANTENNA HEIGHT (m)	TABLE ANGLE (Degree)	RAW VALUE (dBuV)	CORRECTION FACTOR (dB/m)
1	#5470.00	66.3 PK	74.0	-7.7	1.80 V	256	61.8	4.5
2	#5470.00	51.8 AV	54.0	-2.2	1.80 V	256	47.3	4.5
3	*5510.00	104.2 PK			1.80 V	256	99.6	4.6
4	*5510.00	94.6 AV			1.80 V	256	90.0	4.6
5	11020.00	50.1 PK	74.0	-23.9	3.86 V	189	35.4	14.7
6	11020.00	38.3 AV	54.0	-15.7	3.86 V	189	23.6	14.7
7	#16530.00	51.9 PK	74.0	-22.1	2.43 V	178	36.1	15.8
8	#16530.00	40.6 AV	54.0	-13.4	2.43 V	178	24.8	15.8

REMARKS:

1. Emission Level(dBuV/m) = Raw Value(dBuV) + Correction Factor(dB/m)
2. Correction Factor(dB/m) = Antenna Factor(dB/m) + Cable Factor(dB) – Pre-Amplifier Factor(dB)
3. The other emission levels were very low against the limit.
4. Margin value = Emission Level – Limit value
5. " * ": Fundamental frequency.
6. " # ": The radiated frequency is out of the restricted band.

CHANNEL	TX Channel 110	DETECTOR FUNCTION	Peak (PK)
FREQUENCY RANGE	1GHz ~ 40GHz		Average (AV)

ANTENNA POLARITY & TEST DISTANCE: HORIZONTAL AT 3 M

NO.	FREQ. (MHz)	EMISSION LEVEL (dBuV/m)	LIMIT (dBuV/m)	MARGIN (dB)	ANTENNA HEIGHT (m)	TABLE ANGLE (Degree)	RAW VALUE (dBuV)	CORRECTION FACTOR (dB/m)
1	#5470.00	60.8 PK	74.0	-13.2	1.00 H	301	56.3	4.5
2	#5470.00	46.5 AV	54.0	-7.5	1.00 H	301	42.0	4.5
3	*5550.00	113.6 PK			1.00 H	301	109.1	4.5
4	*5550.00	102.2 AV			1.00 H	301	97.7	4.5
5	11100.00	62.5 PK	74.0	-11.5	2.17 H	162	48.1	14.4
6	11100.00	48.1 AV	54.0	-5.9	2.17 H	162	33.7	14.4
7	#16650.00	53.9 PK	74.0	-20.1	1.09 H	201	37.5	16.4
8	#16650.00	41.3 AV	54.0	-12.7	1.09 H	201	24.9	16.4

ANTENNA POLARITY & TEST DISTANCE: VERTICAL AT 3 M

NO.	FREQ. (MHz)	EMISSION LEVEL (dBuV/m)	LIMIT (dBuV/m)	MARGIN (dB)	ANTENNA HEIGHT (m)	TABLE ANGLE (Degree)	RAW VALUE (dBuV)	CORRECTION FACTOR (dB/m)
1	#5470.00	58.5 PK	74.0	-15.5	1.80 V	265	54.0	4.5
2	#5470.00	44.2 AV	54.0	-9.8	1.80 V	265	39.7	4.5
3	*5550.00	107.5 PK			1.80 V	265	103.0	4.5
4	*5550.00	97.3 AV			1.80 V	265	92.8	4.5
5	11100.00	54.5 PK	74.0	-19.5	3.99 V	226	40.1	14.4
6	11100.00	41.4 AV	54.0	-12.6	3.99 V	226	27.0	14.4
7	#16650.00	52.5 PK	74.0	-21.5	2.34 V	190	36.1	16.4
8	#16650.00	40.9 AV	54.0	-13.1	2.34 V	190	24.5	16.4

REMARKS:

1. Emission Level(dBuV/m) = Raw Value(dBuV) + Correction Factor(dB/m)
2. Correction Factor(dB/m) = Antenna Factor(dB/m) + Cable Factor(dB) – Pre-Amplifier Factor(dB)
3. The other emission levels were very low against the limit.
4. Margin value = Emission Level – Limit value
5. " * ": Fundamental frequency.
6. " # ": The radiated frequency is out of the restricted band.

CHANNEL	TX Channel 134	DETECTOR FUNCTION	Peak (PK)
FREQUENCY RANGE	1GHz ~ 40GHz		Average (AV)

ANTENNA POLARITY & TEST DISTANCE: HORIZONTAL AT 3 M

NO.	FREQ. (MHz)	EMISSION LEVEL (dBuV/m)	LIMIT (dBuV/m)	MARGIN (dB)	ANTENNA HEIGHT (m)	TABLE ANGLE (Degree)	RAW VALUE (dBuV)	CORRECTION FACTOR (dB/m)
1	*5670.00	113.0 PK			1.00 H	292	108.2	4.8
2	*5670.00	101.8 AV			1.00 H	292	97.0	4.8
3	#5725.00	68.1 PK	74.0	-5.9	1.00 H	292	63.2	4.9
4	#5725.00	53.9 AV	54.0	-0.1	1.00 H	292	49.0	4.9
5	11340.00	61.8 PK	74.0	-12.2	2.11 H	147	47.4	14.4
6	11340.00	47.3 AV	54.0	-6.7	2.11 H	147	32.9	14.4
7	#17010.00	53.9 PK	74.0	-20.1	1.12 H	210	35.7	18.2
8	#17010.00	41.1 AV	54.0	-12.9	1.12 H	210	22.9	18.2

ANTENNA POLARITY & TEST DISTANCE: VERTICAL AT 3 M

NO.	FREQ. (MHz)	EMISSION LEVEL (dBuV/m)	LIMIT (dBuV/m)	MARGIN (dB)	ANTENNA HEIGHT (m)	TABLE ANGLE (Degree)	RAW VALUE (dBuV)	CORRECTION FACTOR (dB/m)
1	*5670.00	106.7 PK			1.86 V	279	101.9	4.8
2	*5670.00	96.8 AV			1.86 V	279	92.0	4.8
3	#5725.00	65.8 PK	74.0	-8.2	1.86 V	279	60.9	4.9
4	#5725.00	51.5 AV	54.0	-2.5	1.86 V	279	46.6	4.9
5	11340.00	54.7 PK	74.0	-19.3	3.92 V	215	40.3	14.4
6	11340.00	41.6 AV	54.0	-12.4	3.92 V	215	27.2	14.4
7	#17010.00	53.1 PK	74.0	-20.9	2.31 V	173	34.9	18.2
8	#17010.00	41.6 AV	54.0	-12.4	2.31 V	173	23.4	18.2

REMARKS:

1. Emission Level(dBuV/m) = Raw Value(dBuV) + Correction Factor(dB/m)
2. Correction Factor(dB/m) = Antenna Factor(dB/m) + Cable Factor(dB) – Pre-Amplifier Factor(dB)
3. The other emission levels were very low against the limit.
4. Margin value = Emission Level – Limit value
5. " * ": Fundamental frequency.
6. " # ": The radiated frequency is out of the restricted band.

CHANNEL	TX Channel 142	DETECTOR FUNCTION	Peak (PK)
FREQUENCY RANGE	1GHz ~ 40GHz		Average (AV)

ANTENNA POLARITY & TEST DISTANCE: HORIZONTAL AT 3 M

NO.	FREQ. (MHz)	EMISSION LEVEL (dBuV/m)	LIMIT (dBuV/m)	MARGIN (dB)	ANTENNA HEIGHT (m)	TABLE ANGLE (Degree)	RAW VALUE (dBuV)	CORRECTION FACTOR (dB/m)
1	#5470.00	49.2 PK	74.0	-24.8	1.92 H	299	44.7	4.5
2	#5470.00	37.8 AV	54.0	-16.2	1.92 H	299	33.3	4.5
3	*5710.00	114.5 PK			1.92 H	299	109.6	4.9
4	*5710.00	103.5 AV			1.92 H	299	98.6	4.9
5	#5850.00	54.0 PK	74.0	-20.0	1.92 H	299	48.9	5.1
6	#5850.00	41.4 AV	54.0	-12.6	1.92 H	299	36.3	5.1
7	11420.00	62.7 PK	74.0	-11.3	2.22 H	176	48.4	14.3
8	11420.00	48.0 AV	54.0	-6.0	2.22 H	176	33.7	14.3
9	#17130.00	53.6 PK	74.0	-20.4	1.08 H	217	35.1	18.5
10	#17130.00	41.1 AV	54.0	-12.9	1.08 H	217	22.6	18.5

ANTENNA POLARITY & TEST DISTANCE: VERTICAL AT 3 M

NO.	FREQ. (MHz)	EMISSION LEVEL (dBuV/m)	LIMIT (dBuV/m)	MARGIN (dB)	ANTENNA HEIGHT (m)	TABLE ANGLE (Degree)	RAW VALUE (dBuV)	CORRECTION FACTOR (dB/m)
1	#5470.00	46.7 PK	74.0	-27.3	1.88 V	280	42.2	4.5
2	#5470.00	35.3 AV	54.0	-18.7	1.88 V	280	30.8	4.5
3	*5710.00	108.4 PK			1.88 V	280	103.5	4.9
4	*5710.00	98.2 AV			1.88 V	280	93.3	4.9
5	#5850.00	52.2 PK	74.0	-21.8	1.88 V	280	47.1	5.1
6	#5850.00	39.3 AV	54.0	-14.7	1.88 V	280	34.2	5.1
7	11420.00	54.9 PK	74.0	-19.1	3.97 V	217	40.6	14.3
8	11420.00	41.9 AV	54.0	-12.1	3.97 V	217	27.6	14.3
9	#17130.00	53.2 PK	74.0	-20.8	2.30 V	199	34.7	18.5
10	#17130.00	41.5 AV	54.0	-12.5	2.30 V	199	23.0	18.5

REMARKS:

1. Emission Level(dBuV/m) = Raw Value(dBuV) + Correction Factor(dB/m)
2. Correction Factor(dB/m) = Antenna Factor(dB/m) + Cable Factor(dB) – Pre-Amplifier Factor(dB)
3. The other emission levels were very low against the limit.
4. Margin value = Emission Level – Limit value
5. " * ": Fundamental frequency.
6. " # ": The radiated frequency is out of the restricted band.

802.11ac (VHT80)

CHANNEL	TX Channel 106	DETECTOR FUNCTION	Peak (PK)
FREQUENCY RANGE	1GHz ~ 40GHz		Average (AV)

ANTENNA POLARITY & TEST DISTANCE: HORIZONTAL AT 3 M

NO.	FREQ. (MHz)	EMISSION LEVEL (dBuV/m)	LIMIT (dBuV/m)	MARGIN (dB)	ANTENNA HEIGHT (m)	TABLE ANGLE (Degree)	RAW VALUE (dBuV)	CORRECTION FACTOR (dB/m)
1	#5470.00	67.9 PK	74.0	-6.1	1.00 H	281	63.4	4.5
2	#5470.00	53.7 AV	54.0	-0.3	1.00 H	281	49.2	4.5
3	*5530.00	104.1 PK			1.00 H	281	99.6	4.5
4	*5530.00	94.8 AV			1.00 H	281	90.3	4.5
5	#5725.00	50.8 PK	74.0	-23.2	1.00 H	281	45.9	4.9
6	#5725.00	39.2 AV	54.0	-14.8	1.00 H	281	34.3	4.9
7	11060.00	56.1 PK	74.0	-17.9	2.08 H	162	41.6	14.5
8	11060.00	42.5 AV	54.0	-11.5	2.08 H	162	28.0	14.5
9	#16590.00	55.8 PK	74.0	-18.2	1.06 H	236	39.2	16.6
10	#16590.00	42.5 AV	54.0	-11.5	1.06 H	236	25.9	16.6

ANTENNA POLARITY & TEST DISTANCE: VERTICAL AT 3 M

NO.	FREQ. (MHz)	EMISSION LEVEL (dBuV/m)	LIMIT (dBuV/m)	MARGIN (dB)	ANTENNA HEIGHT (m)	TABLE ANGLE (Degree)	RAW VALUE (dBuV)	CORRECTION FACTOR (dB/m)
1	#5470.00	65.5 PK	74.0	-8.5	1.83 V	258	61.0	4.5
2	#5470.00	51.5 AV	54.0	-2.5	1.83 V	258	47.0	4.5
3	*5530.00	97.7 PK			1.83 V	258	93.2	4.5
4	*5530.00	88.9 AV			1.83 V	258	84.4	4.5
5	#5725.00	48.7 PK	74.0	-25.3	1.83 V	258	43.8	4.9
6	#5725.00	37.1 AV	54.0	-16.9	1.83 V	258	32.2	4.9
7	11060.00	53.8 PK	74.0	-20.2	3.91 V	216	39.3	14.5
8	11060.00	41.1 AV	54.0	-12.9	3.91 V	216	26.6	14.5
9	#16590.00	53.4 PK	74.0	-20.6	2.35 V	181	36.8	16.6
10	#16590.00	41.7 AV	54.0	-12.3	2.35 V	181	25.1	16.6

REMARKS:

- Emission Level(dBuV/m) = Raw Value(dBuV) + Correction Factor(dB/m)
- Correction Factor(dB/m) = Antenna Factor(dB/m) + Cable Factor(dB) – Pre-Amplifier Factor(dB)
- The other emission levels were very low against the limit.
- Margin value = Emission Level – Limit value
- " * ": Fundamental frequency.
- " # ": The radiated frequency is out of the restricted band.

CHANNEL	TX Channel 122	DETECTOR FUNCTION	Peak (PK)
FREQUENCY RANGE	1GHz ~ 40GHz		Average (AV)

ANTENNA POLARITY & TEST DISTANCE: HORIZONTAL AT 3 M

NO.	FREQ. (MHz)	EMISSION LEVEL (dBuV/m)	LIMIT (dBuV/m)	MARGIN (dB)	ANTENNA HEIGHT (m)	TABLE ANGLE (Degree)	RAW VALUE (dBuV)	CORRECTION FACTOR (dB/m)
1	*5610.00	109.1 PK			1.00 H	295	104.4	4.7
2	*5610.00	99.5 AV			1.00 H	295	94.8	4.7
3	#5725.00	68.0 PK	74.0	-6.0	1.00 H	295	63.1	4.9
4	#5725.00	53.9 AV	54.0	-0.1	1.00 H	295	49.0	4.9
5	11220.00	61.2 PK	74.0	-12.8	2.11 H	170	46.8	14.4
6	11220.00	47.2 AV	54.0	-6.8	2.11 H	170	32.8	14.4
7	#16830.00	55.4 PK	74.0	-18.6	1.01 H	222	38.4	17.0
8	#16830.00	42.2 AV	54.0	-11.8	1.01 H	222	25.2	17.0

ANTENNA POLARITY & TEST DISTANCE: VERTICAL AT 3 M

NO.	FREQ. (MHz)	EMISSION LEVEL (dBuV/m)	LIMIT (dBuV/m)	MARGIN (dB)	ANTENNA HEIGHT (m)	TABLE ANGLE (Degree)	RAW VALUE (dBuV)	CORRECTION FACTOR (dB/m)
1	*5610.00	102.8 PK			1.78 V	251	98.1	4.7
2	*5610.00	93.6 AV			1.78 V	251	88.9	4.7
3	#5725.00	65.8 PK	74.0	-8.2	1.78 V	251	60.9	4.9
4	#5725.00	51.5 AV	54.0	-2.5	1.78 V	251	46.6	4.9
5	11220.00	54.1 PK	74.0	-19.9	3.96 V	221	39.7	14.4
6	11220.00	41.3 AV	54.0	-12.7	3.96 V	221	26.9	14.4
7	#16830.00	52.9 PK	74.0	-21.1	2.34 V	191	35.9	17.0
8	#16830.00	41.5 AV	54.0	-12.5	2.34 V	191	24.5	17.0

REMARKS:

1. Emission Level(dBuV/m) = Raw Value(dBuV) + Correction Factor(dB/m)
2. Correction Factor(dB/m) = Antenna Factor(dB/m) + Cable Factor(dB) – Pre-Amplifier Factor(dB)
3. The other emission levels were very low against the limit.
4. Margin value = Emission Level – Limit value
5. " * ": Fundamental frequency.
6. " # ": The radiated frequency is out of the restricted band.

CHANNEL	TX Channel 138	DETECTOR FUNCTION	Peak (PK)
FREQUENCY RANGE	1GHz ~ 40GHz		Average (AV)

ANTENNA POLARITY & TEST DISTANCE: HORIZONTAL AT 3 M

NO.	FREQ. (MHz)	EMISSION LEVEL (dBuV/m)	LIMIT (dBuV/m)	MARGIN (dB)	ANTENNA HEIGHT (m)	TABLE ANGLE (Degree)	RAW VALUE (dBuV)	CORRECTION FACTOR (dB/m)
1	#5470.00	53.9 PK	74.0	-20.1	1.91 H	262	49.4	4.5
2	#5470.00	41.6 AV	54.0	-12.4	1.91 H	262	37.1	4.5
3	*5690.00	110.8 PK			1.91 H	262	106.0	4.8
4	*5690.00	101.4 AV			1.91 H	262	96.6	4.8
5	#5850.00	61.5 PK	74.0	-12.5	1.91 H	262	56.4	5.1
6	#5850.00	47.9 AV	54.0	-6.1	1.91 H	262	42.8	5.1
7	11380.00	61.5 PK	74.0	-12.5	2.14 H	179	47.1	14.4
8	11380.00	47.6 AV	54.0	-6.4	2.14 H	179	33.2	14.4
9	#17070.00	54.7 PK	74.0	-19.3	1.01 H	207	36.4	18.3
10	#17070.00	41.7 AV	54.0	-12.3	1.01 H	207	23.4	18.3

ANTENNA POLARITY & TEST DISTANCE: VERTICAL AT 3 M

NO.	FREQ. (MHz)	EMISSION LEVEL (dBuV/m)	LIMIT (dBuV/m)	MARGIN (dB)	ANTENNA HEIGHT (m)	TABLE ANGLE (Degree)	RAW VALUE (dBuV)	CORRECTION FACTOR (dB/m)
1	#5470.00	53.8 PK	74.0	-20.2	1.80 V	266	49.3	4.5
2	#5470.00	41.5 AV	54.0	-12.5	1.80 V	266	37.0	4.5
3	*5690.00	104.7 PK			1.80 V	266	99.9	4.8
4	*5690.00	95.4 AV			1.80 V	266	90.6	4.8
5	#5850.00	59.3 PK	74.0	-14.7	1.80 V	266	54.2	5.1
6	#5850.00	45.5 AV	54.0	-8.5	1.80 V	266	40.4	5.1
7	11380.00	54.8 PK	74.0	-19.2	3.93 V	232	40.4	14.4
8	11380.00	41.6 AV	54.0	-12.4	3.93 V	232	27.2	14.4
9	#17070.00	54.6 PK	74.0	-19.4	2.24 V	184	36.3	18.3
10	#17070.00	41.9 AV	54.0	-12.1	2.24 V	184	23.6	18.3

REMARKS:

1. Emission Level(dBuV/m) = Raw Value(dBuV) + Correction Factor(dB/m)
2. Correction Factor(dB/m) = Antenna Factor(dB/m) + Cable Factor(dB) – Pre-Amplifier Factor(dB)
3. The other emission levels were very low against the limit.
4. Margin value = Emission Level – Limit value
5. " * ": Fundamental frequency.
6. " # ": The radiated frequency is out of the restricted band.

4.2 Conducted Emission Measurement

4.2.1 Limits of Conducted Emission Measurement

Frequency (MHz)	Conducted Limit (dBuV)	
	Quasi-peak	Average
0.15 - 0.5	66 - 56	56 - 46
0.50 - 5.0	56	46
5.0 - 30.0	60	50

Note: 1. The lower limit shall apply at the transition frequencies.

2. The limit decreases in line with the logarithm of the frequency in the range of 0.15 to 0.50MHz.

4.2.2 Test Instruments

DESCRIPTION & MANUFACTURER	MODEL NO.	SERIAL NO.	CALIBRATED DATE	CALIBRATED UNTIL
Test Receiver R&S	ESCS 30	847124/029	Oct. 24, 2016	Oct. 23, 2017
Line-Impedance Stabilization Network (for EUT) R&S	ESH3-Z5	848773/004	Oct. 26, 2016	Oct. 25, 2017
Line-Impedance Stabilization Network (for Peripheral) R&S	ENV216	100072	June 13, 2016	June 12, 2017
50 ohms Terminator	N/A	EMC-02	Sep. 29, 2016	Sep. 28, 2017
RF Cable	5D-FB	COCCAB-001	Sep. 30, 2016	Sep. 29, 2017
10 dB PAD Mini-Circuits	HAT-10+	CONATT-004	June 20, 2016	June 19, 2017
Software BVADT	BVADT_Cond_ V7.3.7.4	NA	NA	NA

Note:

1. The calibration interval of the above test instruments are 12 months and the calibrations are traceable to NML/ROC and NIST/USA.
2. The test was performed in Shielded Room No. 1.
3. Tested Date: Mar. 31, 2017

4.2.3 Test Procedure

- The EUT was placed 0.4 meters from the conducting wall of the shielded room with EUT being connected to the power mains through a line impedance stabilization network (LISN). Other support units were connected to the power mains through another LISN. The two LISNs provide 50 ohm/ 50uH of coupling impedance for the measuring instrument.
- Both lines of the power mains connected to the EUT were checked for maximum conducted interference.
- The frequency range from 150kHz to 30MHz was searched. Emission levels under (Limit - 20dB) was not recorded.

NOTE: All modes of operation were investigated and the worst-case emissions are reported.

4.2.4 Deviation from Test Standard

No deviation.

4.2.5 Test Setup

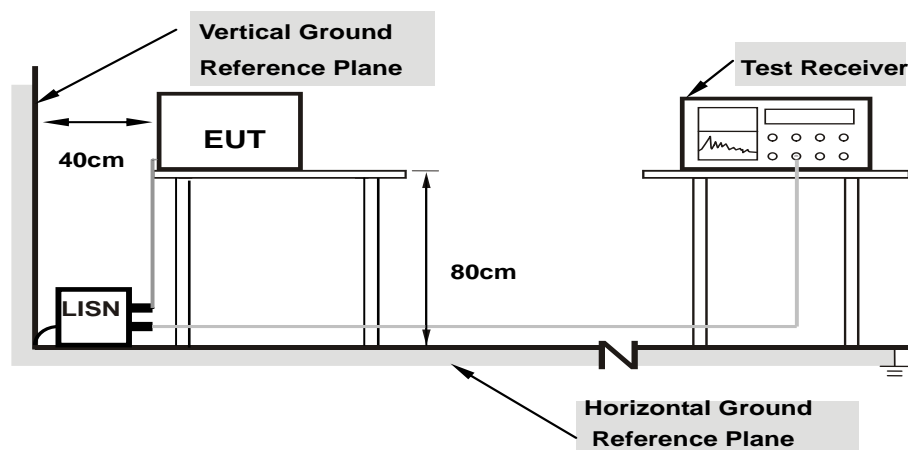

Note: 1.Support units were connected to second LISN.

For the actual test configuration, please refer to the attached file (Test Setup Photo).

4.2.6 EUT Operating Condition

Same as 4.1.6.

4.2.7 Test Results

Radio 2

Phase	Line (L)	Detector Function	Quasi-Peak (QP) / Average (AV)
-------	----------	-------------------	--------------------------------

No	Freq. [MHz]	Corr.	Reading Value		Emission Level		Limit		Margin	
		Factor (dB)	[dB (uV)]		[dB (uV)]		[dB (uV)]		(dB)	
			Q.P.	AV.	Q.P.	AV.	Q.P.	AV.	Q.P.	AV.
1	0.15391	10.19	36.55	25.75	46.74	35.94	65.79	55.79	-19.05	-19.85
2	0.18125	10.19	28.94	18.42	39.13	28.61	64.43	54.43	-25.30	-25.82
3	0.49766	10.23	23.77	15.34	34.00	25.57	56.04	46.04	-22.04	-20.47
4	3.54297	10.24	18.90	15.27	29.14	25.51	56.00	46.00	-26.86	-20.49
5	7.31250	10.41	31.58	29.60	41.99	40.01	60.00	50.00	-18.01	-9.99
6	24.87891	11.42	32.69	31.65	44.11	43.07	60.00	50.00	-15.89	-6.93

REMARKS:

1. Q.P. and AV. are abbreviations of quasi-peak and average individually.
2. The emission levels of other frequencies were very low against the limit.
3. Margin value = Emission level - Limit value
4. Correction factor = Insertion loss + Cable loss
5. Emission Level = Correction Factor + Reading Value.

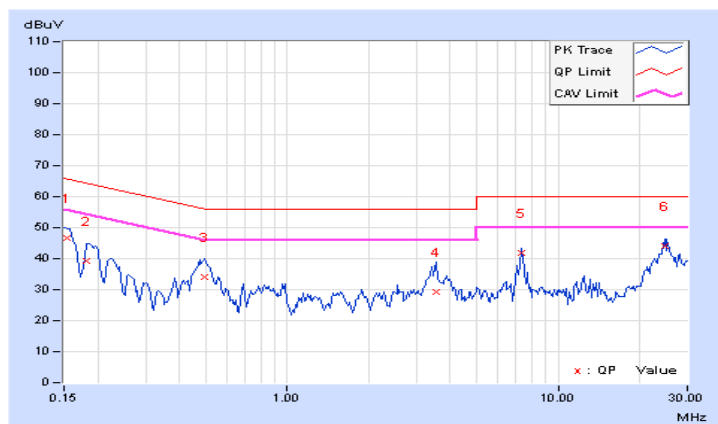

Phase	Neutral (N)	Detector Function	Quasi-Peak (QP) / Average (AV)
-------	-------------	-------------------	--------------------------------

No	Freq.	Corr.	Reading Value		Emission Level		Limit		Margin	
	[MHz]	Factor	[dB (uV)]		[dB (uV)]		[dB (uV)]		(dB)	
		(dB)	Q.P.	AV.	Q.P.	AV.	Q.P.	AV.	Q.P.	AV.
1	0.15000	10.18	38.02	28.79	48.20	38.97	66.00	56.00	-17.80	-17.03
2	0.18516	10.17	32.68	22.89	42.85	33.06	64.25	54.25	-21.40	-21.19
3	0.48984	10.21	26.17	21.62	36.38	31.83	56.17	46.17	-19.79	-14.34
4	3.46484	10.19	16.16	10.96	26.35	21.15	56.00	46.00	-29.65	-24.85
5	7.31250	10.34	32.12	30.17	42.46	40.51	60.00	50.00	-17.54	-9.49
6	25.12500	11.07	33.57	33.30	44.64	44.37	60.00	50.00	-15.36	-5.63

REMARKS:

1. Q.P. and AV. are abbreviations of quasi-peak and average individually.
2. The emission levels of other frequencies were very low against the limit.
3. Margin value = Emission level - Limit value
4. Correction factor = Insertion loss + Cable loss
5. Emission Level = Correction Factor + Reading Value.

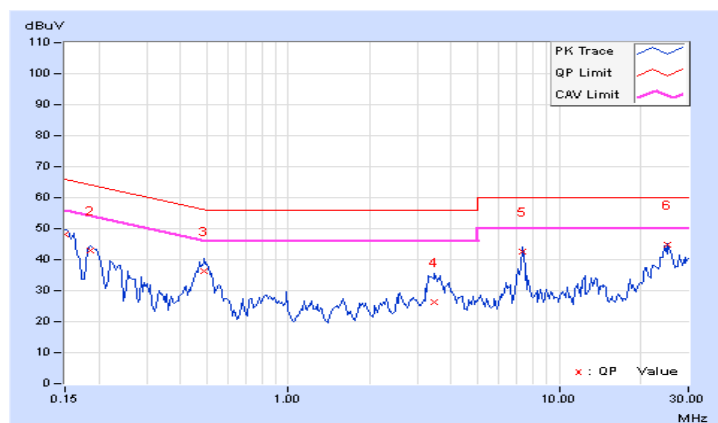

Radio 1

Phase	Line (L)	Detector Function	Quasi-Peak (QP) / Average (AV)
-------	----------	-------------------	--------------------------------

No	Freq. [MHz]	Corr. Factor	Reading Value [dB (uV)]		Emission Level [dB (uV)]		Limit [dB (uV)]		Margin (dB)	
		(dB)	Q.P.	AV.	Q.P.	AV.	Q.P.	AV.	Q.P.	AV.
	1	0.15000	10.19	38.42	29.54	48.61	39.73	66.00	56.00	-17.39
2	0.18516	10.19	32.96	24.00	43.15	34.19	64.25	54.25	-21.10	-20.06
3	0.20859	10.19	15.89	0.35	26.08	10.54	63.26	53.26	-37.18	-42.72
4	0.49375	10.23	24.94	17.68	35.17	27.91	56.10	46.10	-20.93	-18.19
5	7.31641	10.41	31.25	28.38	41.66	38.79	60.00	50.00	-18.34	-11.21
6	25.12500	11.43	32.87	31.24	44.30	42.67	60.00	50.00	-15.70	-7.33

REMARKS:

1. Q.P. and AV. are abbreviations of quasi-peak and average individually.
2. The emission levels of other frequencies were very low against the limit.
3. Margin value = Emission level - Limit value
4. Correction factor = Insertion loss + Cable loss
5. Emission Level = Correction Factor + Reading Value.

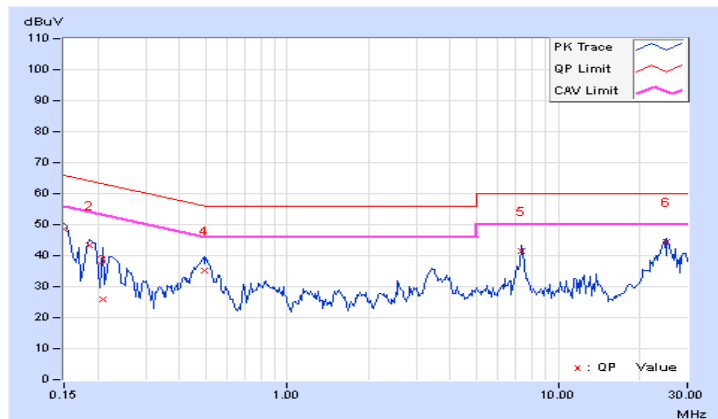

Phase	Neutral (N)	Detector Function	Quasi-Peak (QP) / Average (AV)
-------	-------------	-------------------	--------------------------------

No	Freq. [MHz]	Corr. Factor	Reading Value [dB (uV)]		Emission Level [dB (uV)]		Limit [dB (uV)]		Margin (dB)	
		(dB)	Q.P.	AV.	Q.P.	AV.	Q.P.	AV.	Q.P.	AV.
	1	0.15000	10.18	38.10	29.04	48.28	39.22	66.00	56.00	-17.72
2	0.18516	10.17	32.64	23.07	42.81	33.24	64.25	54.25	-21.44	-21.01
3	0.22422	10.17	27.56	17.49	37.73	27.66	62.66	52.66	-24.93	-25.00
4	0.48984	10.21	26.15	21.60	36.36	31.81	56.17	46.17	-19.81	-14.36
5	7.31641	10.34	31.31	28.46	41.65	38.80	60.00	50.00	-18.35	-11.20
6	25.12109	11.07	34.84	33.18	45.91	44.25	60.00	50.00	-14.09	-5.75

REMARKS:

1. Q.P. and AV. are abbreviations of quasi-peak and average individually.
2. The emission levels of other frequencies were very low against the limit.
3. Margin value = Emission level - Limit value
4. Correction factor = Insertion loss + Cable loss
5. Emission Level = Correction Factor + Reading Value.

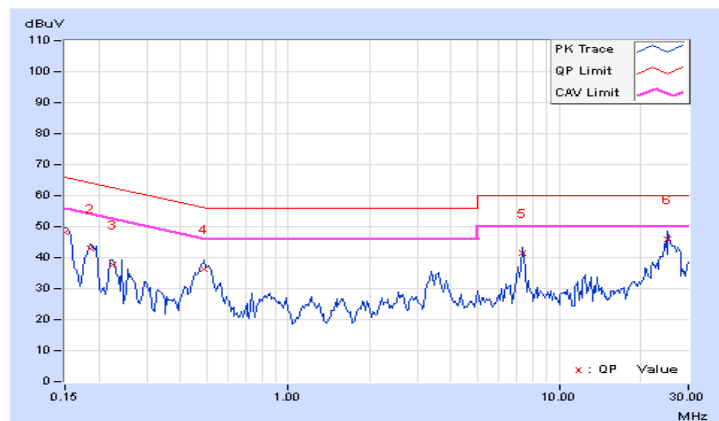

4.3 Transmit Power Measurement

4.3.1 Limits of Transmit Power Measurement

Operation Band	EUT Category		Limit
U-NII-1		Outdoor Access Point	1 Watt (30 dBm) (Max. e.i.r.p \leq 125mW(21 dBm) at any elevation angle above 30 degrees as measured from the horizon)
		Fixed point-to-point Access Point	1 Watt (30 dBm)
		Indoor Access Point	1 Watt (30 dBm)
		Mobile and Portable client device	250mW (24 dBm)
U-NII-2A		√	250mW (24 dBm) or 11 dBm+10 log B*
U-NII-2C		√	250mW (24 dBm) or 11 dBm+10 log B*
U-NII-3		√	1 Watt (30 dBm)

*B is the 26 dB emission bandwidth in megahertz

Per KDB 662911 Method of conducted output power measurement on IEEE 802.11 devices,

Array Gain = 0 dB (i.e., no array gain) for $N_{ANT} \leq 4$;

Array Gain = 0 dB (i.e., no array gain) for channel widths ≥ 40 MHz for any N_{ANT} ;

Array Gain = $5 \log(N_{ANT}/N_{SS})$ dB or 3 dB, whichever is less for 20-MHz channel widths with $N_{ANT} \geq 5$.

For power measurements on all other devices: Array Gain = $10 \log(N_{ANT}/N_{SS})$ dB.

4.3.2 Test Setup

FOR POWER OUTPUT MEASUREMENT

For channel straddling 5725MHz:

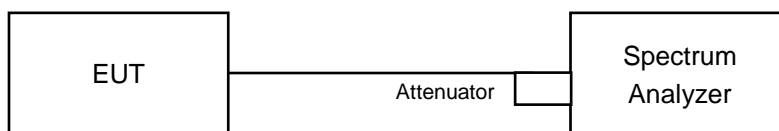

For other channels:

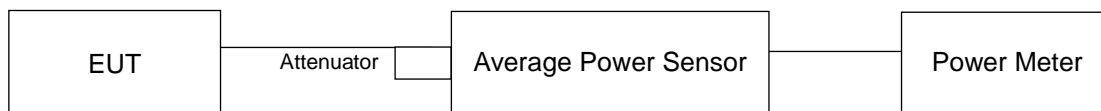

FOR 26dB OCCUPIED BANDWIDTH

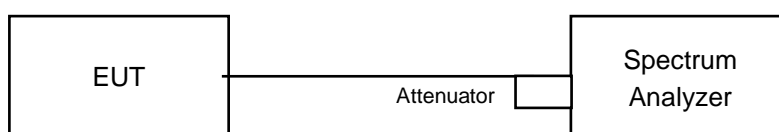

4.3.3 Test Instruments

Refer to section 4.1.2 to get information of above instrument.

4.3.4 Test Procedure

For Average Power Measurement

For channel straddling 5725MHz:

802.11ac (VHT20)

Method SA-1

1. Set span to encompass the entire emission bandwidth (EBW) of the signal.
2. Set RBW = 1MHz.
3. Set the VBW $\geq 3 \times$ RBW.
4. Number of points in sweep ≥ 2 Span / RBW.
5. Sweep time = auto.
6. Set trigger to free run (duty cycle ≥ 98 percent)
7. Detector = RMS.
8. Trace average at least 100 traces in power averaging mode
9. Compute power by integrating the spectrum across the 26 dB EBW of the signal.

Other Modulation mode

Method SA-2

1. Set span to encompass the emission bandwidth (EBW) of the signal.
2. Set RBW = 1MHz.
3. Set the VBW $\geq 3 \times$ RBW.
4. Number of points in sweep ≥ 2 Span / RBW.
5. Sweep time = auto.
6. Detector = RMS.
7. Trace average at least 100 traces in power averaging mode
8. Compute power by integrating the spectrum across the 26 dB EBW of the signal.
9. Duty factor need added to measured value (duty cycle < 98 percent).

For other channels:

Method PM is used to perform output power measurement, trigger and gating function of wide band power meter is enabled to measure max output power of TX on burst. Duty factor is not added to measured value.

FOR 26dB OCCUPIED BANDWIDTH

1. Set RBW = approximately 1% of the emission bandwidth.
2. Set the VBW $>$ RBW.
3. Detector = Peak.
4. Trace mode = max hold.
5. Measure the maximum width of the emission that is 26 dB down from the peak of the emission. Compare this with the RBW setting of the analyzer. Readjust RBW and repeat measurement as needed until the RBW/EBW ratio is approximately 1%.

4.3.5 Deviation from Test Standard

No deviation.

4.3.6 EUT Operating Condition

The software provided by client to enable the EUT under transmission condition continuously at lowest, middle and highest channel frequencies individually.

4.3.7 Test Result

2TX Mode

Radio 2

CDD Mode

802.11a

Power Output:

CHAN.	FREQ. (MHz)	Maximum Conducted Power (dBm)		Total Power (mW)	Total Power (dBm)	Power Limit (dBm)	Pass/Fail
		CHAIN 0	CHAIN 1				
52	5260	18.66	18.47	143.758	21.58	24.00	Pass
60	5300	18.75	18.29	142.442	21.54	24.00	Pass
64	5320	18.76	18.27	142.305	21.53	24.00	Pass

26dB BANDWIDTH:

Channel	Frequency (MHz)	26dBc Bandwidth (MHz)	
		Chain 0	Chain 1
52	5260	28.15	27.51
60	5300	22.14	21.41
64	5320	32.10	38.61

Note: For U-NII-2A Band output power limitation is determined based on 26dBc bandwidth.

Power Limit = 11dBm + 10logB < U-NII-2A >			
Channel Number	Freq.(MHz)	Min. B(MHz)	Determined Conducted Limit (dBm)
52	5260	27.51	25.39 > 24
60	5300	21.41	24.3 > 24
64	5320	32.10	26.06 > 24

802.11ac (VHT20)

Power Output:

CHAN.	FREQ. (MHz)	Maximum Conducted Power (dBm)		Total Power (mW)	Total Power (dBm)	Power Limit (dBm)	Pass/Fail
		CHAIN 0	CHAIN 1				
52	5260	18.61	18.40	141.794	21.52	24.00	Pass
60	5300	18.69	18.34	142.195	21.53	24.00	Pass
64	5320	18.66	18.31	141.215	21.50	24.00	Pass

26dB BANDWIDTH:

Channel	Frequency (MHz)	26dBc Bandwidth (MHz)	
		Chain 0	Chain 1
52	5260	29.25	29.31
60	5300	20.70	22.51
64	5320	30.18	37.64

Note: For U-NII-2A Band output power limitation is determined based on 26dBc bandwidth.

Power Limit = 11dBm + 10logB < U-NII-2A >			
Channel Number	Freq.(MHz)	Min. B(MHz)	Determined Conducted Limit (dBm)
52	5260	29.25	25.66 > 24
60	5300	20.70	24.15 > 24
64	5320	30.18	25.79 > 24

802.11ac (VHT40)

Power Output:

CHAN.	FREQ. (MHz)	Maximum Conducted Power (dBm)		Total Power (mW)	Total Power (dBm)	Power Limit (dBm)	Pass/Fail
		CHAIN 0	CHAIN 1				
54	5270	20.72	20.53	231.012	23.64	24.00	Pass
62	5310	15.89	15.59	75.039	18.75	24.00	Pass

26dB BANDWIDTH:

Channel	Frequency (MHz)	26dBc Bandwidth (MHz)	
		Chain 0	Chain 1
54	5270	66.10	56.47
62	5310	41.16	41.38

Note: For U-NII-2A Band output power limitation is determined based on 26dBc bandwidth.

Power Limit = 11dBm + 10logB < U-NII-2A >			
Channel Number	Freq.(MHz)	Min. B(MHz)	Determined Conducted Limit (dBm)
54	5270	56.47	28.51 > 24
62	5310	41.16	27.14 > 24

802.11ac (VHT80)

Power Output:

CHAN.	CHAN. FREQ. (MHz)	Maximum Conducted Power (dBm)		Total Power (mW)	Total Power (dBm)	Power Limit (dBm)	Pass/Fail
		CHAIN 0	CHAIN 1				
58	5290	16.41	16.09	84.396	19.26	24.00	Pass

26dB BANDWIDTH:

Channel	Frequency (MHz)	26dBc Bandwidth (MHz)	
		Chain 0	Chain 1
58	5290	83.81	83.14

Note: For U-NII-2A Band output power limitation is determined based on 26dBc bandwidth.

Power Limit = 11dBm + 10logB < U-NII-2A, U-NII-2C >			
Channel Number	Freq.(MHz)	Min. B(MHz)	Determined Conducted Limit (dBm)
58	5290	83.14	30.19 > 24

Spectrum Plot of Worst Value

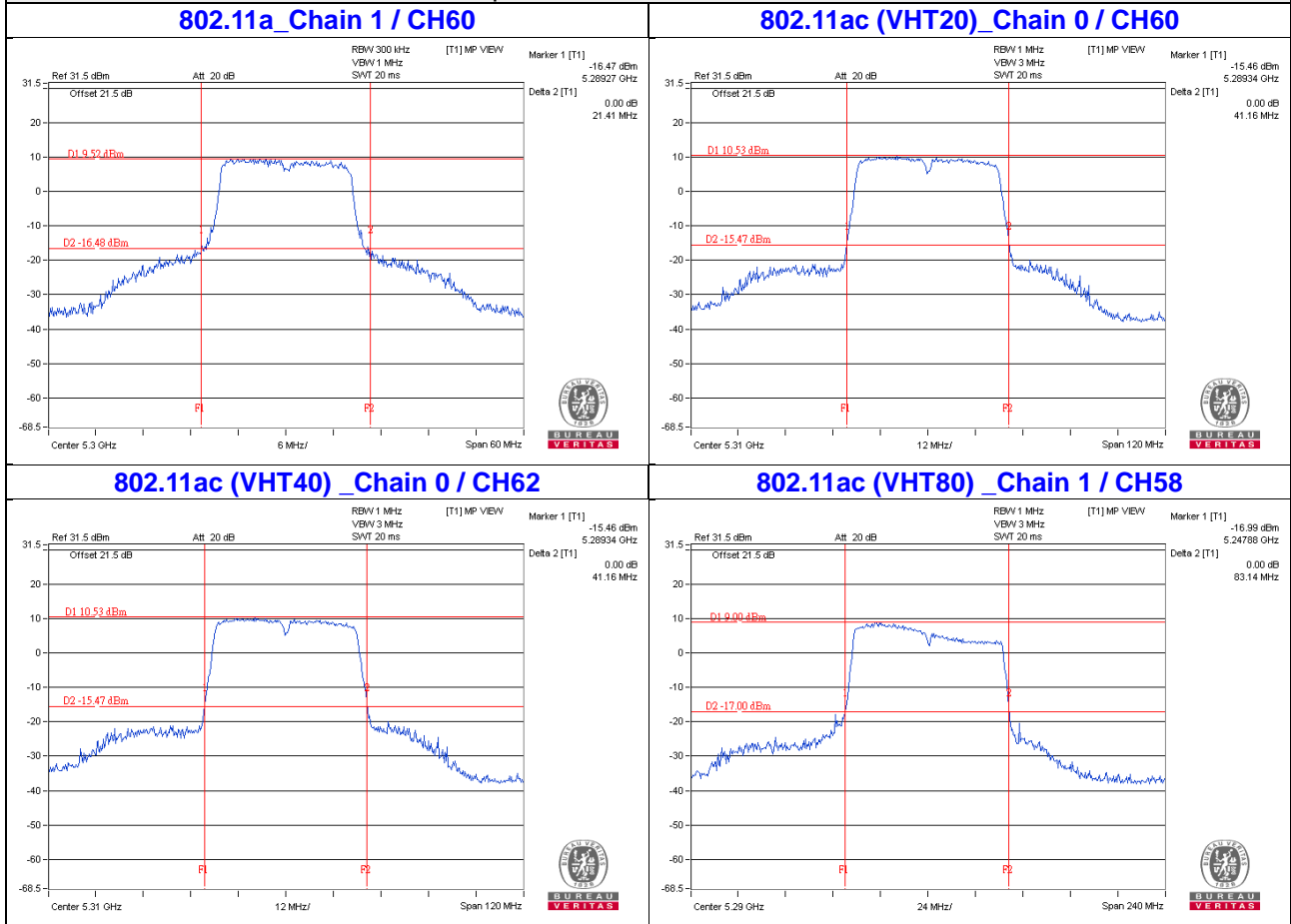

Beamforming Mode

802.11ac (VHT20)

Power Output:

CHAN.	FREQ. (MHz)	Maximum Conducted Power (dBm)		Total Power (mW)	Total Power (dBm)	Power Limit (dBm)	Pass/Fail
		CHAIN 0	CHAIN 1				
52	5260	18.61	18.40	141.794	21.52	21.73	Pass
60	5300	18.69	18.34	142.195	21.53	21.73	Pass
64	5320	18.66	18.31	141.215	21.50	21.73	Pass

Note: 1. Directional gain = $10 \log[(10^{G1/20} + 10^{G2/20})^2 / 2] = 8.27\text{dBi} > 6\text{dBi}$, so the power limit shall be reduced to $24 - (8.27 - 6) = 21.73\text{dBm}$.

26dB BANDWIDTH:

Channel	Frequency (MHz)	26dBc Bandwidth (MHz)	
		Chain 0	Chain 1
52	5260	29.25	29.31
60	5300	20.70	22.51
64	5320	30.18	37.64

Note: For U-NII-2A Band output power limitation is determined based on 26dBc bandwidth.

Power Limit = $11\text{dBm} + 10\log B < \text{U-NII-2A} >$			
Channel Number	Freq.(MHz)	Min. B(MHz)	Determined Conducted Limit (dBm)
52	5260	29.25	25.66 > 24
60	5300	20.70	24.15 > 24
64	5320	30.18	25.79 > 24

802.11ac (VHT40)

Power Output:

CHAN.	FREQ. (MHz)	Maximum Conducted Power (dBm)		Total Power (mW)	Total Power (dBm)	Power Limit (dBm)	Pass/Fail
		CHAIN 0	CHAIN 1				
54	5270	18.69	18.39	142.985	21.55	21.73	Pass
62	5310	15.01	15.59	67.92	18.32	21.73	Pass

Note: 1. Directional gain = $10 \log[(10^{G1/20} + 10^{G2/20})^2 / 2] = 8.27\text{dBi} > 6\text{dBi}$, so the power limit shall be reduced to $24 - (8.27 - 6) = 21.73\text{dBm}$.

26dB BANDWIDTH:

Channel	Frequency (MHz)	26dBc Bandwidth (MHz)	
		Chain 0	Chain 1
54	5270	66.10	56.47
62	5310	41.16	41.38

Note: For U-NII-2A Band output power limitation is determined based on 26dBc bandwidth.

Power Limit = $11\text{dBm} + 10\log B < \text{U-NII-2A} >$			
Channel Number	Freq.(MHz)	Min. B(MHz)	Determined Conducted Limit (dBm)
54	5270	56.47	28.51 > 24
62	5310	41.16	27.14 > 24

802.11ac (VHT80)

Power Output:

CHAN.	CHAN. FREQ. (MHz)	Maximum Conducted Power (dBm)		Total Power (mW)	Total Power (dBm)	Power Limit (dBm)	Pass/Fail
		CHAIN 0	CHAIN 1				
58	5290	16.41	16.09	84.396	19.26	21.73	Pass

Note: 1. Directional gain = $10 \log[(10^{G1/20} + 10^{G2/20})^2 / 2]$ = 8.27dBi > 6dBi , so the power limit shall be reduced to $24 - (8.27 - 6) = 21.73\text{dBm}$.

26dB BANDWIDTH:

Channel	Frequency (MHz)	26dBc Bandwidth (MHz)	
		Chain 0	Chain 1
58	5290	83.81	83.14

Note: For U-NII-2A Band output power limitation is determined based on 26dBc bandwidth.

Power Limit = 11dBm + 10logB < U-NII-2A, U-NII-2C >			
Channel Number	Freq.(MHz)	Min. B(MHz)	Determined Conducted Limit (dBm)
58	5290	83.14	30.19 > 24

Spectrum Plot of Worst Value

802.11ac (VHT20)_Chain 0 / CH60

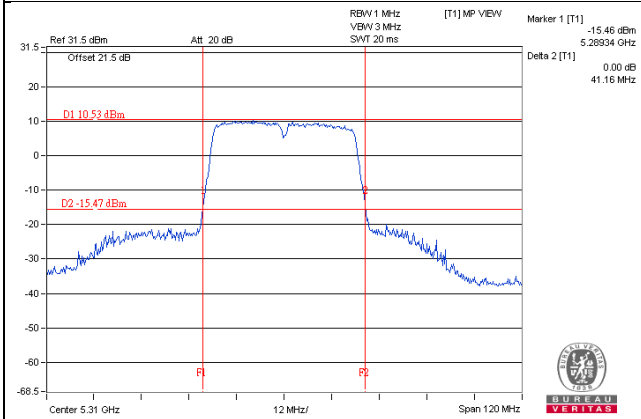

802.11ac (VHT40)_Chain 0 / CH62

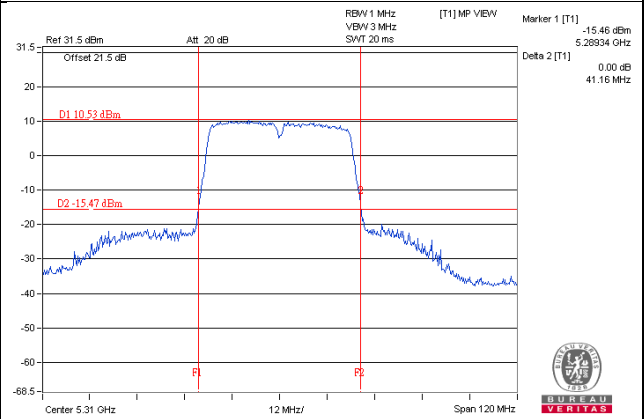

802.11ac (VHT80)_Chain 1 / CH58

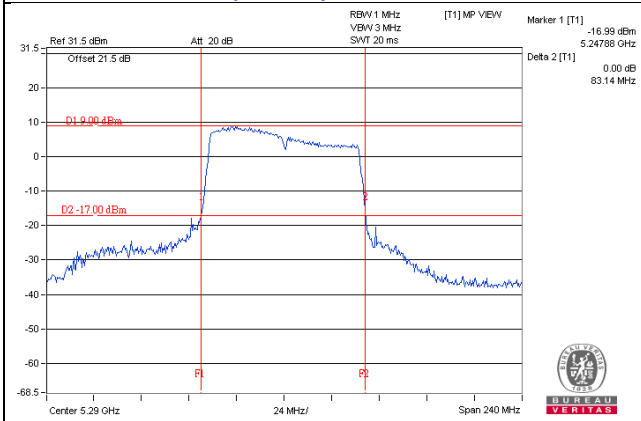

Radio 1
CDD Mode
802.11a
Power Output:

CHAN.	FREQ. (MHz)	Maximum Conducted Power (dBm)		Total Power (mW)	Total Power (dBm)	Power Limit (dBm)	Pass/Fail
		CHAIN 0	CHAIN 1				
100	5500	17.27	17.67	111.812	20.48	23.11	Pass
116	5580	17.38	16.99	104.705	20.20	23.08	Pass
140	5700	17.77	16.52	104.716	20.20	23.11	Pass
*144 (UNII-2C Band)	5720	13.10	12.15	38.319	15.83	21.87	Pass
*144 (UNII-3 Band)	5720	6.44	5.95	8.681	9.39	29.21	Pass

Note: 1. * Test was performed in accordance with Measurement follow FCC KDB 789033 UNII test procedure Method SA-2 and use spectrum analyzer test.

2. For UNII-3: The max.antenna gain is 6.79dBi > 6dBi, therefore the limit needs to reduce, so the power limit shall be reduced to $30-(6.79-6) = 29.21\text{dBm}$.

The Total Power for the straddle channel:

Chan.	Chan. Freq. (MHz)	Average Power (mW)	Average Power (dBm)
144	5720	47	16.72

Note: The total power was calculated through formula and record the value for reference only.

26dB BANDWIDTH:

Channel	Frequency (MHz)	26dBc Bandwidth (MHz)	
		Chain 0	Chain 1
100	5500	19.76	19.50
116	5580	19.74	19.39
140	5700	19.55	19.53
144 (UNII-2C Band)	5720	14.72	14.66

Note: For U-NII-2C Band output power limitation is determined based on 26dBc bandwidth.

Power Limit = $11\text{dBm} + 10\log B < \text{U-NII-2C} >$			
Channel Number	Freq.(MHz)	Min. B(MHz)	Determined Conducted Limit (dBm)
100	5500	19.50	23.9 < 24
116	5580	19.39	23.87 < 24
140	5700	19.53	23.9 < 24
144 (UNII-2C Band)	5720	14.66	22.66 < 24

802.11ac (VHT20)

Power Output:

CHAN.	FREQ. (MHz)	Maximum Conducted Power (dBm)		Total Power (mW)	Total Power (dBm)	Power Limit (dBm)	Pass/Fail
		CHAIN 0	CHAIN 1				
100	5500	16.93	17.51	105.681	20.24	23.21	Pass
116	5580	17.51	17.02	106.714	20.28	23.08	Pass
140	5700	17.71	16.36	102.271	20.10	23.21	Pass
*144 (UNII-2C Band)	5720	13.62	12.74	41.807	16.21	22.01	Pass
*144 (UNII-3 Band)	5720	7.92	7.19	11.43	10.58	29.21	Pass

Note: 1. * Test was performed in accordance with Measurement follow FCC KDB 789033 UNII test procedure Method SA-1 and use spectrum analyzer test.

2. For UNII-3: The max.antenna gain is 6.79dBi > 6dBi, therefore the limit needs to reduce, so the power limit shall be reduced to $30-(6.79-6) = 29.21$ dBm.

The Total Power for the straddle channel:

Chan.	Chan. Freq. (MHz)	Average Power (mW)	Average Power (dBm)
144	5720	53.237	17.26

Note: The total power was calculated through formula and record the value for reference only.

26dB BANDWIDTH:

Channel	Frequency (MHz)	26dBc Bandwidth (MHz)	
		Chain 0	Chain 1
100	5500	20.62	20.46
116	5580	20.33	19.39
140	5700	20.42	20.55
144 (UNII-2C Band)	5720	15.17	15.21

Note: For U-NII-2C Band output power limitation is determined based on 26dBc bandwidth.

Power Limit = 11dBm + 10logB < U-NII-2C >			
Channel Number	Freq.(MHz)	Min. B(MHz)	Determined Conducted Limit (dBm)
100	5500	20.46	24.1 > 24
116	5580	19.39	23.87 < 24
140	5700	20.42	24.1 > 24
144 (UNII-2C Band)	5720	15.17	22.8 < 24

802.11ac (VHT40)

Power Output:

CHAN.	FREQ. (MHz)	Maximum Conducted Power (dBm)		Total Power (mW)	Total Power (dBm)	Power Limit (dBm)	Pass/Fail
		CHAIN 0	CHAIN 1				
102	5510	17.59	18.20	123.481	20.92	23.21	Pass
110	5550	19.99	20.08	201.629	23.05	23.21	Pass
134	5670	20.34	19.26	192.476	22.84	23.21	Pass
*142 (UNII-2C Band)	5710	16.62	15.82	87.249	19.41	23.21	Pass
*142 (UNII-3 Band)	5710	4.92	4.57	6.191	7.92	29.21	Pass

Note: 1. * Test was performed in accordance with Measurement follow FCC KDB 789033 UNII test procedure Method SA-2 and use spectrum analyzer test.

2. For UNII-3: The max.antenna gain is 6.79dBi > 6dBi, therefore the limit needs to reduce, so the power limit shall be reduced to $30-(6.79-6) = 29.21$ dBm.

The Total Power for the straddle channel:

Chan.	Chan. Freq. (MHz)	Average Power (mW)	Average Power (dBm)
142	5710	93.44	19.71

Note: The total power was calculated through formula and record the value for reference only.

26dB BANDWIDTH:

Channel	Frequency (MHz)	26dBc Bandwidth (MHz)	
		Chain 0	Chain 1
102	5510	41.01	40.63
110	5550	40.95	40.72
134	5670	40.87	40.83
142 (UNII-2C Band)	5710	35.46	35.32

Note: For U-NII-2C Band output power limitation is determined based on 26dBc bandwidth.

Power Limit = 11dBm + 10logB < U-NII-2C >			
Channel Number	Freq.(MHz)	Min. B(MHz)	Determined Conducted Limit (dBm)
102	5510	40.63	27.08 > 24
110	5550	40.72	27.09 > 24
134	5670	40.83	27.1 > 24
142 (UNII-2C Band)	5710	35.32	26.48 > 24

802.11ac (VHT80)

Power Output:

CHAN.	CHAN. FREQ. (MHz)	Maximum Conducted Power (dBm)		Total Power (mW)	Total Power (dBm)	Power Limit (dBm)	Pass/Fail
		CHAIN 0	CHAIN 1				
106	5530	17.64	18.15	123.389	20.91	23.21	Pass
122	5610	20.23	19.86	202.267	23.06	23.21	Pass
*138 (UNII-2C Band)	5690	16.11	15.20	79.092	18.98	23.21	Pass
*138 (UNII-3 Band)	5690	1.83	2.13	3.377	5.29	29.21	Pass

Note: 1. * Test was performed in accordance with Measurement follow FCC KDB 789033 UNII test procedure Method SA-2 and use spectrum analyzer test.

2. For UNII-3: The max.antenna gain is 6.79dBi > 6dBi, therefore the limit needs to reduce, so the power limit shall be reduced to $30 - (6.79 - 6) = 29.21$ dBm.

The Total Power for the straddle channel:

Chan.	Chan. Freq. (MHz)	Average Power (mW)	Average Power (dBm)
138	5690	82.469	19.16

Note: The total power was calculated through formula and record the value for reference only.

26dB BANDWIDTH:

Channel	Frequency (MHz)	26dBc Bandwidth (MHz)	
		Chain 0	Chain 1
106	5530	84.60	83.49
122	5610	84.33	83.43
138 (UNII-2C Band)	5690	81.21	76.67

Note: For U-NII-2C Band output power limitation is determined based on 26dBc bandwidth.

Power Limit = 11dBm + 10logB < U-NII-2C >			
Channel Number	Freq.(MHz)	Min. B(MHz)	Determined Conducted Limit (dBm)
106	5530	83.49	30.21 > 24
122	5610	83.43	30.21 > 24
138 (UNII-2C Band)	5690	76.67	29.84 > 24

Spectrum Plot of Worst Value

802.11a_Chain 0 / CH144 (UNII-2C)

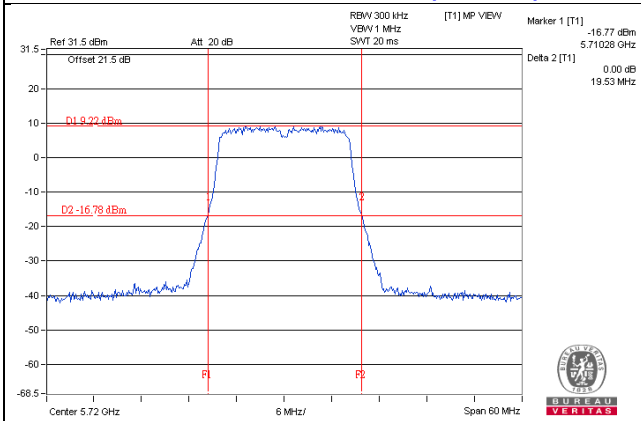

802.11ac (VHT20)_Chain 0 / CH144 (UNII-2C)

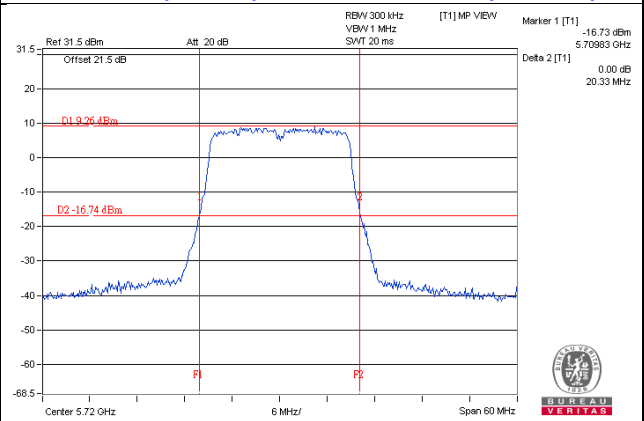

802.11ac (VHT40)_Chain 1 / CH142 (UNII-2C)

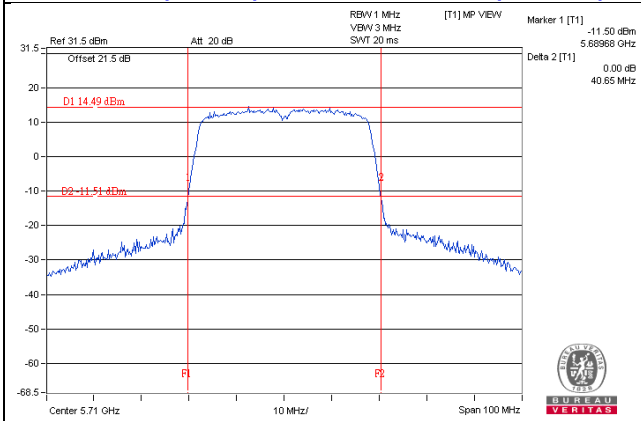

802.11ac (VHT80)_Chain 0 / CH138 (UNII-2C)

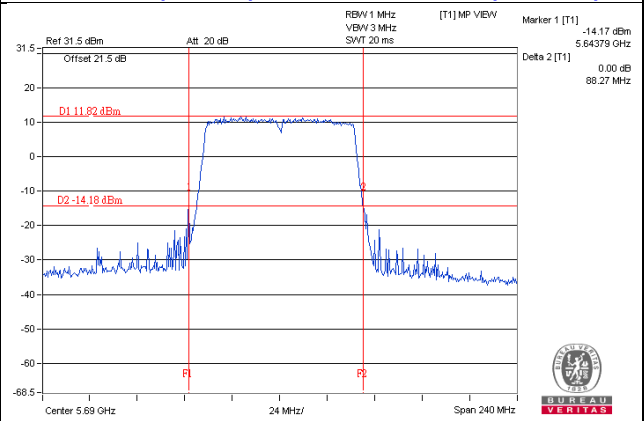

NOTE:

- For CH144 (U_NII-2C) = 5725MHz - Marker 1
- For CH142 (U_NII-2C) = 5725MHz - Marker 1
- For CH138 (U_NII-2C) = 5725MHz - Marker 1

Beamforming Mode

802.11ac (VHT20)

Power Output:

CHAN.	FREQ. (MHz)	Maximum Conducted Power (dBm)		Total Power (mW)	Total Power (dBm)	Power Limit (dBm)	Pass/Fail
		CHAIN 0	CHAIN 1				
100	5500	16.93	17.51	105.681	20.24	20.51	Pass
116	5580	17.51	17.02	106.714	20.28	20.51	Pass
140	5700	17.71	16.36	102.271	20.10	20.51	Pass
*144 (UNII-2C Band)	5720	13.62	12.74	41.807	16.21	19.31	Pass
*144 (UNII-3 Band)	5720	7.92	7.19	11.43	10.58	26.51	Pass

Note: 1. * Test was performed in accordance with Measurement follow FCC KDB 789033 UNII test procedure Method SA-1 and use spectrum analyzer test.

2. For UNII-3: Directional gain = $10 \log[(10^{G1/20} + 10^{G2/20})^2 / 2]$ = 9.49dBi > 6dBi , so the power limit shall be reduced to $30-(9.49-6) = 26.51$ dBm.

The Total Power for the straddle channel:

Chan.	Chan. Freq. (MHz)	Average Power (mW)	Average Power (dBm)
144	5720	53.237	17.26

Note: The total power was calculated through formula and record the value for reference only.

26dB BANDWIDTH:

Channel	Frequency (MHz)	26dBc Bandwidth (MHz)	
		Chain 0	Chain 1
100	5500	20.62	20.46
116	5580	20.33	20.38
140	5700	20.42	20.55
144 (UNII-2C Band)	5720	15.17	15.21

Note: For U-NII-2C Band output power limitation is determined based on 26dBc bandwidth.

Power Limit = 11dBm + 10logB < U-NII-2C >			
Channel Number	Freq.(MHz)	Min. B(MHz)	Determined Conducted Limit (dBm)
100	5500	20.46	24.1 > 24
116	5580	20.33	24.08 > 24
140	5700	20.42	24.1 > 24
144 (UNII-2C Band)	5720	15.17	22.8 < 24

802.11ac (VHT40)

Power Output:

CHAN.	FREQ. (MHz)	Maximum Conducted Power (dBm)		Total Power (mW)	Total Power (dBm)	Power Limit (dBm)	Pass/Fail
		CHAIN 0	CHAIN 1				
102	5510	17.01	17.68	108.848	20.37	20.51	Pass
110	5550	17.40	17.45	110.544	20.44	20.51	Pass
134	5670	17.85	16.89	109.819	20.41	20.51	Pass
*142 (UNII-2C Band)	5710	13.65	13.08	45.119	16.54	20.51	Pass
*142 (UNII-3 Band)	5710	2.30	1.97	3.394	5.31	26.51	Pass

Note: 1. * Test was performed in accordance with Measurement follow FCC KDB 789033 UNII test procedure Method SA-2 and use spectrum analyzer test.

2. For UNII-3: Directional gain = $10 \log[(10^{G1/20} + 10^{G2/20})^2 / 2]$ = 9.49dBi > 6dBi , so the power limit shall be reduced to 30-(9.49-6) = 26.51dBm.

The Total Power for the straddle channel:

Chan.	Chan. Freq. (MHz)	Average Power (mW)	Average Power (dBm)
142	5710	48.513	16.86

Note: The total power was calculated through formula and record the value for reference only.

26dB BANDWIDTH:

Channel	Frequency (MHz)	26dBc Bandwidth (MHz)	
		Chain 0	Chain 1
102	5510	41.01	40.63
110	5550	40.95	40.72
134	5670	40.87	40.83
142 (UNII-2C Band)	5710	35.41	35.38

Note: For U-NII-2C Band output power limitation is determined based on 26dBc bandwidth.

Power Limit = 11dBm + 10logB < U-NII-2C >			
Channel Number	Freq.(MHz)	Min. B(MHz)	Determined Conducted Limit (dBm)
102	5510	40.63	27.08 > 24
110	5550	40.72	27.09 > 24
134	5670	40.83	27.1 > 24
142 (UNII-2C Band)	5710	35.38	26.48 > 24

802.11ac (VHT80)

Power Output:

CHAN.	CHAN. FREQ. (MHz)	Maximum Conducted Power (dBm)		Total Power (mW)	Total Power (dBm)	Power Limit (dBm)	Pass/Fail
		CHAIN 0	CHAIN 1				
106	5530	17.16	17.60	109.544	20.40	20.51	Pass
122	5610	17.58	17.30	110.983	20.45	20.51	Pass
*138 (UNII-2C Band)	5690	12.72	12.23	37.883	15.78	20.51	Pass
*138 (UNII-3 Band)	5690	-1.47	-1.07	1.5985	2.04	26.51	Pass

Note: 1. * Test was performed in accordance with Measurement follow FCC KDB 789033 UNII test procedure Method SA-2 and use spectrum analyzer test.

2. For UNII-3: Directional gain = $10 \log[(10^{G1/20} + 10^{G2/20})^2 / 2] = 9.49\text{dBi} > 6\text{dBi}$, so the power limit shall be reduced to $30 - (9.49 - 6) = 26.51\text{dBm}$.

The Total Power for the straddle channel:

Chan.	Chan. Freq. (MHz)	Average Power (mW)	Average Power (dBm)
138	5690	39.4815	15.96

Note: The total power was calculated through formula and record the value for reference only.

26dB BANDWIDTH:

Channel	Frequency (MHz)	26dBc Bandwidth (MHz)	
		Chain 0	Chain 1
106	5530	84.60	83.49
122	5610	84.33	83.43
138 (UNII-2C Band)	5690	77.04	77.39

Note: For U-NII-2C Band output power limitation is determined based on 26dBc bandwidth.

Power Limit = 11dBm + 10logB < U-NII-2C >			
Channel Number	Freq.(MHz)	Min. B(MHz)	Determined Conducted Limit (dBm)
106	5530	83.49	30.21 > 24
122	5610	83.43	30.21 > 24
138 (UNII-2C Band)	5690	77.04	29.86 > 24

Spectrum Plot of Worst Value

802.11ac (VHT20)_Chain 0 / CH144 (UNII-2C)

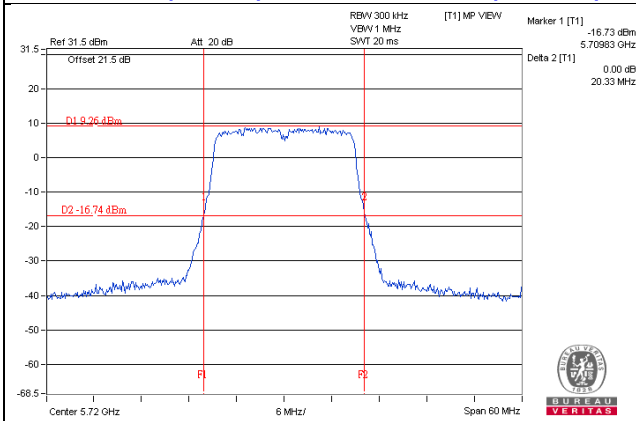

802.11ac (VHT40)_Chain 1 / CH142 (UNII-2C)

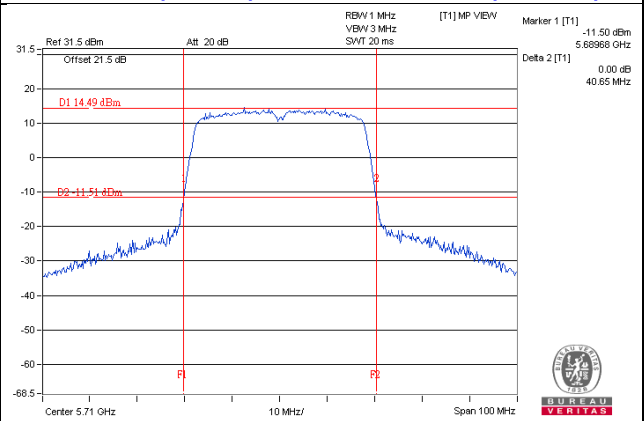

802.11ac (VHT80)_Chain 0 / CH138 (UNII-2C)

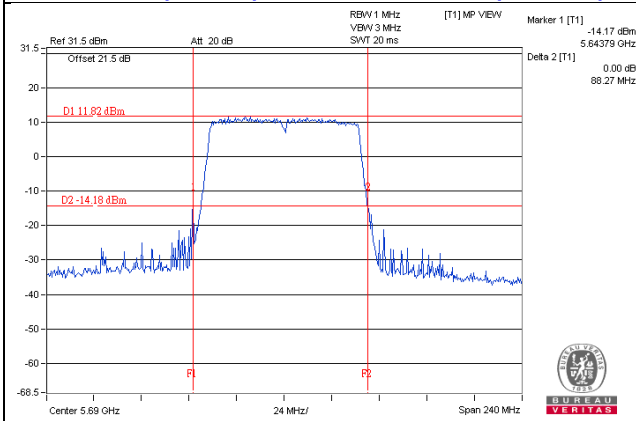

NOTE:

- For CH144 (U_NII-2C) = 5725MHz - Marker 1
- For CH142 (U_NII-2C) = 5725MHz - Marker 1
- For CH138 (U_NII-2C) = 5725MHz - Marker 1

1TX Mode

Radio 2

802.11a

Power Output:

Channel	Channel Frequency (MHz)	Maximum Conducted Power (mW)	Maximum Conducted Power (dBm)	Power Limit (dBm)	Pass/Fail
52	5260	137.404	21.38	24.00	Pass
60	5300	129.42	21.12	24.00	Pass
64	5320	100.462	20.02	24.00	Pass

26dB BANDWIDTH:

Channel	Frequency (MHz)	26dBc Bandwidth (MHz)
52	5260	38.14
60	5300	34.97
64	5320	37.85

Note: For U-NII-2A Band output power limitation is determined based on 26dBc bandwidth.

Power Limit = 11dBm + 10logB < U-NII-2A >			
Channel Number	Freq.(MHz)	Min. B(MHz)	Determined Conducted Limit (dBm)
52	5260	38.14	26.81 > 24
60	5300	34.97	26.43 > 24
64	5320	37.85	26.78 > 24

802.11ac (VHT20)

Power Output:

Channel	Channel Frequency (MHz)	Maximum Conducted Power (mW)	Maximum Conducted Power (dBm)	Power Limit (dBm)	Pass/Fail
52	5260	133.352	21.25	24.00	Pass
60	5300	131.522	21.19	24.00	Pass
64	5320	100.693	20.03	24.00	Pass

26dB BANDWIDTH:

Channel	Frequency (MHz)	26dBc Bandwidth (MHz)
52	5260	39.54
60	5300	34.07
64	5320	38.98

Note: For U-NII-2A Band output power limitation is determined based on 26dBc bandwidth.

Power Limit = 11dBm + 10logB < U-NII-2A >			
Channel Number	Freq.(MHz)	Min. B(MHz)	Determined Conducted Limit (dBm)
52	5260	39.54	26.97 > 24
60	5300	34.07	26.32 > 24
64	5320	38.98	26.9 > 24

802.11ac (VHT40)

Channel	Channel Frequency (MHz)	Maximum Conducted Power (mW)	Maximum Conducted Power (dBm)	Power Limit (dBm)	Pass/Fail
54	5270	158.855	22.01	24.00	Pass
62	5310	63.241	18.01	24.00	Pass

26dB BANDWIDTH:

Channel	Frequency (MHz)	26dBc Bandwidth (MHz)
54	5270	80.69
62	5310	41.88

Note: For U-NII-2A Band output power limitation is determined based on 26dBc bandwidth.

Power Limit = 11dBm + 10logB < U-NII-2A >			
Channel Number	Freq.(MHz)	Min. B(MHz)	Determined Conducted Limit (dBm)
54	5270	80.69	30.06 > 24
62	5310	41.88	27.22 > 24

802.11ac (VHT80)

Channel	Channel Frequency (MHz)	Maximum Conducted Power (mW)	Maximum Conducted Power (dBm)	Power Limit (dBm)	Pass/Fail
58	5290	68.391	18.35	24.00	Pass

26dB BANDWIDTH:

Channel	Frequency (MHz)	26dBc Bandwidth (MHz)
58	5290	85.91

Note: For U-NII-2A Band output power limitation is determined based on 26dBc bandwidth.

Power Limit = 11dBm + 10logB < U-NII-2A >			
Channel Number	Freq.(MHz)	Min. B(MHz)	Determined Conducted Limit (dBm)
58	5290	85.91	30.34 > 24

Spectrum Plot of Worst Value

802.11a / CH60

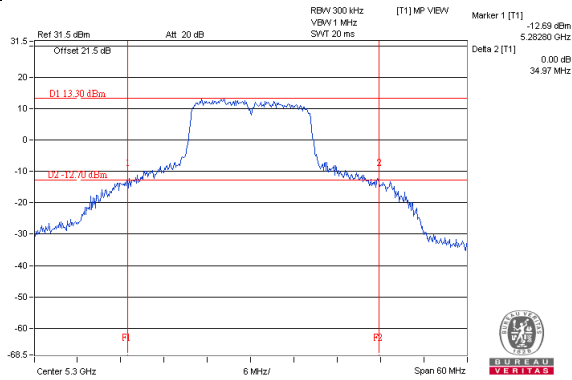

802.11ac (VHT20) / CH60

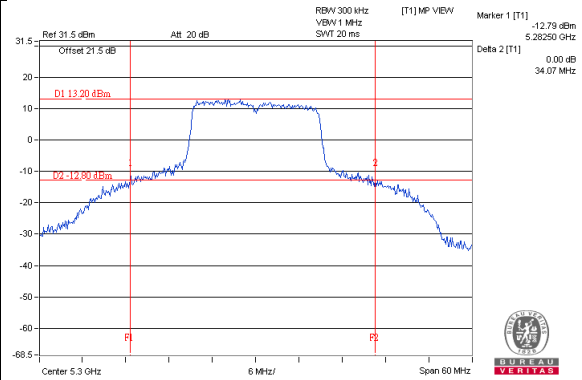

802.11ac (VHT40) / CH62

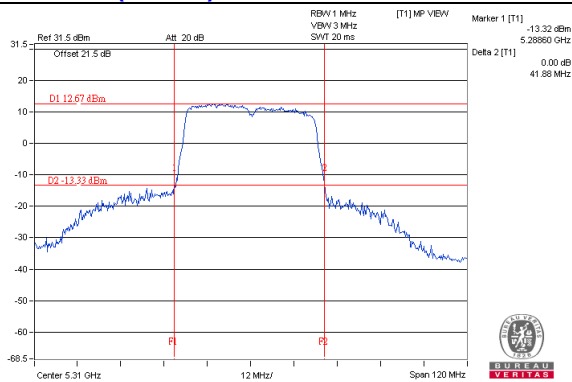

802.11ac (VHT80) / CH58

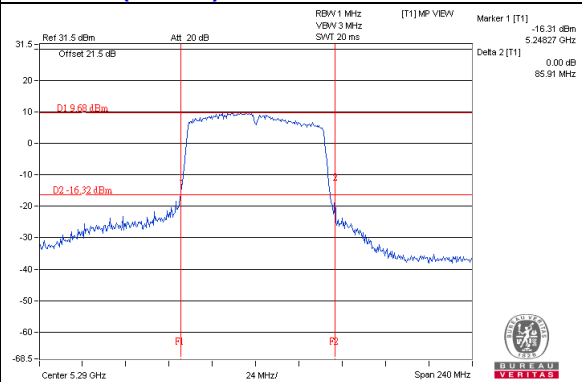

Radio 1
802.11a
Power Output:

Channel	Channel Frequency (MHz)	Maximum Conducted Power (mW)	Maximum Conducted Power (dBm)	Power Limit (dBm)	Pass/Fail
100	5500	151.705	21.81	23.14	Pass
116	5580	207.491	23.17	23.21	Pass
140	5700	206.063	23.14	23.21	Pass
*144 (UNII-2C Band)	5720	83.041	19.19	22.15	Pass
*144 (UNII-3 Band)	5720	20.244	13.06	29.21	Pass

Note: 1. * Test was performed in accordance with Measurement follow FCC KDB 789033 UNII test procedure Method SA-2 and use spectrum analyzer test.

2. The max.antenna gain is 6.79dBi > 6dBi, therefore the limit needs to reduce, so the power limit shall be reduced to $30 - (6.79 - 6) = 29.21\text{dBm}$.

The Total Power for the straddle channel:

Chan.	Chan. Freq. (MHz)	Average Power (mW)	Average Power (dBm)
144	5720	103.285	20.14

Note: The total power was calculated through formula and record the value for reference only.

26dB BANDWIDTH:

Channel	Frequency (MHz)	26dBc Bandwidth (MHz)
100	5500	19.65
116	5580	26.33
140	5700	22.05
144 (UNII-2C Band)	5720	15.66

Note: For U-NII-2C Band output power limitation is determined based on 26dBc bandwidth.

Power Limit = $11\text{dBm} + 10\log B < \text{U-NII-2C} >$			
Channel Number	Freq.(MHz)	Min. B(MHz)	Determined Conducted Limit (dBm)
100	5500	19.65	23.93 > 24
116	5580	26.33	25.2 > 24
140	5700	22.05	24.43 > 24
144 (UNII-2C Band)	5720	15.66	22.94 > 24

802.11ac (VHT20)

Power Output:

Channel	Channel Frequency (MHz)	Maximum Conducted Power (mW)	Maximum Conducted Power (dBm)	Power Limit (dBm)	Pass/Fail
100	5500	184.077	22.65	23.21	Pass
116	5580	182.81	22.62	23.21	Pass
140	5700	204.174	23.10	23.21	Pass
*144 (UNII-2C Band)	5720	90.365	19.56	22.31	Pass
*144 (UNII-3 Band)	5720	23.768	13.76	29.21	Pass

Note: 1. * Test was performed in accordance with Measurement follow FCC KDB 789033 UNII test procedure Method SA-1 and use spectrum analyzer test.

2. The max.antenna gain is 6.79dBi > 6dBi, therefore the limit needs to reduce, so the power limit shall be reduced to $30-(6.79-6) = 29.21\text{dBm}$.

The Total Power for the straddle channel:

Chan.	Chan. Freq. (MHz)	Average Power (mW)	Average Power (dBm)
144	5720	114.133	20.57

Note: The total power was calculated through formula and record the value for reference only.

26dB BANDWIDTH:

Channel	Frequency (MHz)	26dBc Bandwidth (MHz)
100	5500	20.39
116	5580	21.69
140	5700	21.34
144 (UNII-2C Band)	5720	16.23

Note: For U-NII-2C Band output power limitation is determined based on 26dBc bandwidth.

Power Limit = $11\text{dBm} + 10\log B < \text{U-NII-2C} >$			
Channel Number	Freq.(MHz)	Min. B(MHz)	Determined Conducted Limit (dBm)
100	5500	20.39	24.09 > 24
116	5580	21.69	24.36 > 24
140	5700	21.34	24.29 > 24
144 (UNII-2C Band)	5720	16.23	23.1 > 24

802.11ac (VHT40)

Power Output:

Channel	Channel Frequency (MHz)	Maximum Conducted Power (mW)	Maximum Conducted Power (dBm)	Power Limit (dBm)	Pass/Fail
102	5510	130.918	21.17	23.21	Pass
110	5550	198.153	22.97	23.21	Pass
134	5670	197.697	22.96	23.21	Pass
*142 (UNII-2C Band)	5710	100.668	20.03	23.21	Pass
*142 (UNII-3 Band)	5710	6.932	8.41	29.21	Pass

Note: 1. * Test was performed in accordance with Measurement follow FCC KDB 789033 UNII test procedure Method SA-2 and use spectrum analyzer test.

2. The max.antenna gain is 6.79dBi > 6dBi, therefore the limit needs to reduce, so the power limit shall be reduced to $30 - (6.79 - 6) = 29.21\text{dBm}$.

The Total Power for the straddle channel:

Chan.	Chan. Freq. (MHz)	Average Power (mW)	Average Power (dBm)
142	5710	107.6	20.32

Note: The total power was calculated through formula and record the value for reference only.

26dB BANDWIDTH:

Channel	Frequency (MHz)	26dBc Bandwidth (MHz)
102	5510	40.95
110	5550	48.68
134	5670	40.87
142 (UNII-2C Band)	5710	35.89

Note: For U-NII-2C Band output power limitation is determined based on 26dBc bandwidth.

Power Limit = $11\text{dBm} + 10\log B < \text{U-NII-2C} >$			
Channel Number	Freq.(MHz)	Min. B(MHz)	Determined Conducted Limit (dBm)
102	5510	40.95	27.12 > 24
110	5550	48.68	27.87 > 24
134	5670	40.87	27.11 > 24
142 (UNII-2C Band)	5710	35.89	26.54 > 24

802.11ac (VHT80)

Power Output:

Channel	Channel Frequency (MHz)	Maximum Conducted Power (mW)	Maximum Conducted Power (dBm)	Power Limit (dBm)	Pass/Fail
106	5530	93.541	19.71	23.21	Pass
122	5610	189.671	22.78	23.21	Pass
*138 (UNII-2C Band)	5690	74.683	18.73	23.21	Pass
*138 (UNII-3 Band)	5690	2.139	3.30	29.21	Pass

Note: 1. * Test was performed in accordance with Measurement follow FCC KDB 789033 UNII test procedure Method SA-2 and use spectrum analyzer test.

2. The max.antenna gain is 6.79dBi > 6dBi, therefore the limit needs to reduce, so the power limit shall be reduced to $30 - (6.79 - 6) = 29.21$ dBm.

The Total Power for the straddle channel:

Chan.	Chan. Freq. (MHz)	Average Power (mW)	Average Power (dBm)
138	5690	76.822	18.85

Note: The total power was calculated through formula and record the value for reference only.

26dB BANDWIDTH:

Channel	Frequency (MHz)	26dBc Bandwidth (MHz)
106	5530	84.56
122	5610	85.94
138 (UNII-2C Band)	5690	77.66

Note: For U-NII-2C Band output power limitation is determined based on 26dBc bandwidth.

Power Limit = 11dBm + 10logB < U-NII-2C >			
Channel Number	Freq.(MHz)	Min. B(MHz)	Determined Conducted Limit (dBm)
106	5530	84.56	30.27 > 24
122	5610	85.94	30.34 > 24
138 (UNII-2C Band)	5690	77.66	29.9 > 24

Spectrum Plot of Worst Value

802.11a / CH144 (UNII-2C)

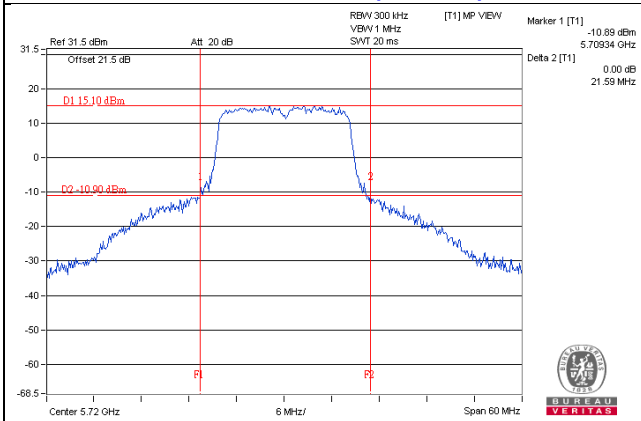

802.11ac (VHT20) / CH144 (UNII-2C)

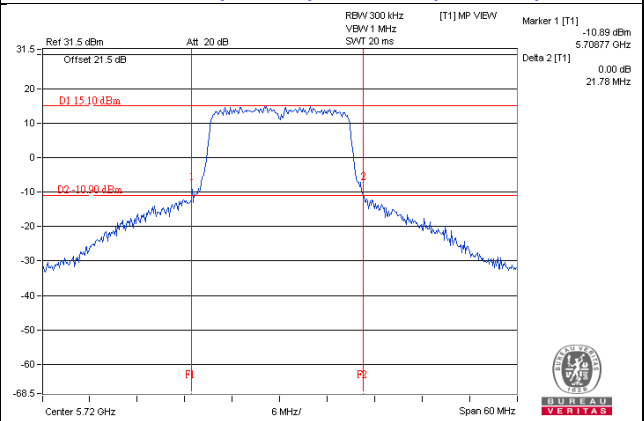

802.11ac (VHT40) / CH142 (UNII-2C)

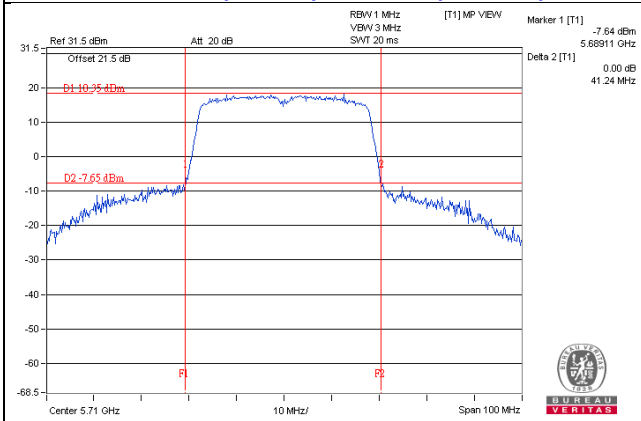

802.11ac (VHT80) / CH138 (UNII-2C)

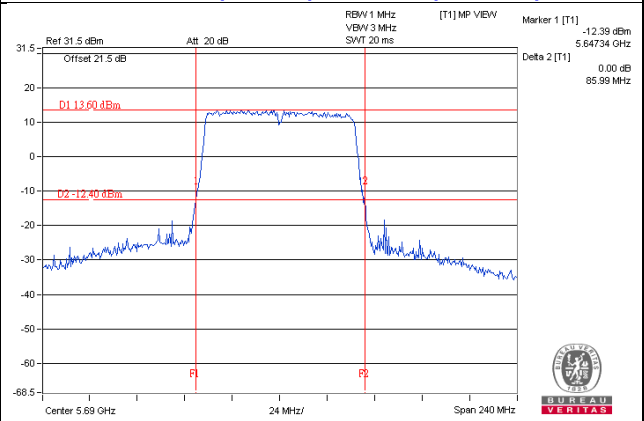

NOTE:

- For CH144 (U_NII-2C) = 5725MHz - Marker 1
- For CH142 (U_NII-2C) = 5725MHz - Marker 1
- For CH138 (U_NII-2C) = 5725MHz - Marker 1

4.4 Occupied Bandwidth Measurement

4.4.1 Test Setup

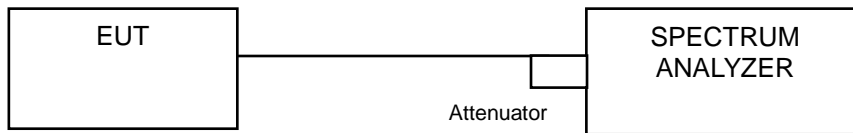

4.4.2 Test Instruments

Refer to section 4.1.2 to get information of above instrument.

4.4.3 Test Procedure

The transmitter output was connected to the spectrum analyzer through an attenuator. The bandwidth of the fundamental frequency was measured by spectrum analyzer with resolution bandwidth in the range of 1% to 5% of the anticipated emission bandwidth, and a video bandwidth at least 3x the resolution bandwidth and set the detector to SAMPLE. The width of a frequency band such that, below the lower and above the upper frequency limits, the mean powers emitted are each equal to a specified percentage 0.5 %of the total mean power of a given emission.

4.4.4 Test Results

2TX Mode

Radio 2

802.11a

Channel	Channel Frequency (MHz)	Occupied Bandwidth (MHz)	
		CHAIN 0	CHAIN 1
52	5260	16.68	16.56
60	5300	16.56	16.56
64	5320	17.04	19.56

802.11ac (VHT20)

Channel	Channel Frequency (MHz)	Occupied Bandwidth (MHz)	
		CHAIN 0	CHAIN 1
52	5260	17.88	17.76
60	5300	17.64	17.88
64	5320	17.76	19.56

802.11ac (VHT40)

Channel	Channel Frequency (MHz)	Occupied Bandwidth (MHz)	
		CHAIN 0	CHAIN 1
54	5270	36.48	36.24
62	5310	36.48	36.48

802.11ac (VHT80)

Channel	Channel Frequency (MHz)	Occupied Bandwidth (MHz)	
		CHAIN 0	CHAIN 1
58	5290	75.84	75.84

Spectrum Plot of Worst Value

802.11a_Chain1 / CH64

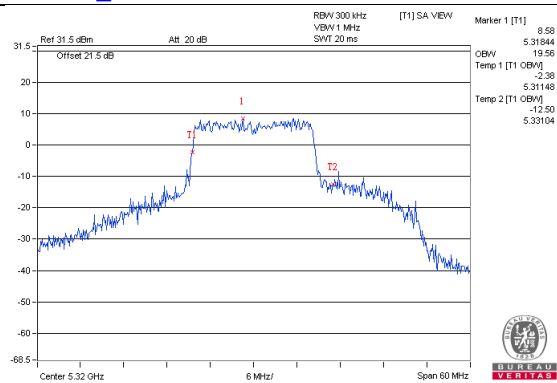

802.11a (VHT20)_Chain1 / CH64

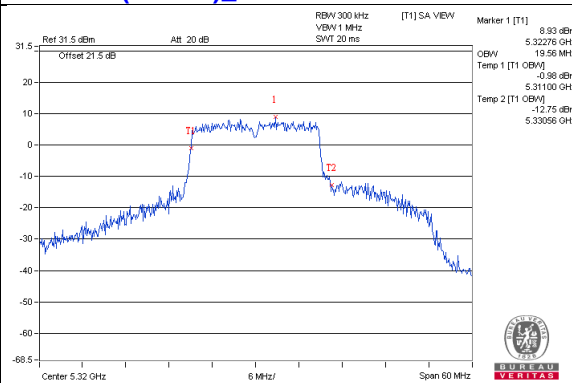

802.11ac (VHT40)_Chain0 / CH54

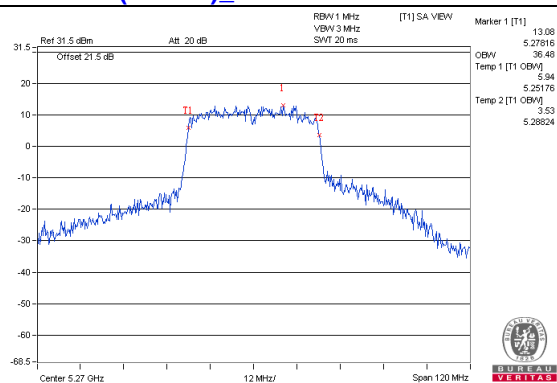

802.11ac (VHT80)_Chain0 / CH58

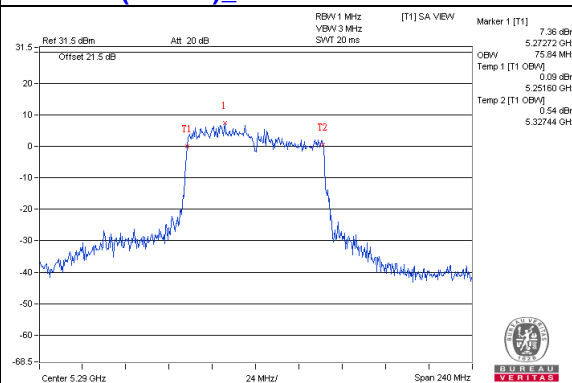

Radio 1
802.11a

Channel	Channel Frequency (MHz)	Occupied Bandwidth (MHz)	
		CHAIN 0	CHAIN 1
100	5500	17.16	17.04
116	5580	16.44	16.56
140	5700	17.16	17.16
144 (UNII-2C Band)	5720	13.28	13.28
144 (UNII-3 Band)	5720	3.16	3.16

802.11ac (VHT20)

Channel	Channel Frequency (MHz)	Occupied Bandwidth (MHz)	
		CHAIN 0	CHAIN 1
100	5500	18.24	18.24
116	5580	17.64	16.56
140	5700	18.24	18.36
144 (UNII-2C Band)	5720	13.88	13.88
144 (UNII-3 Band)	5720	3.88	3.76

802.11ac (VHT40)

Channel	Channel Frequency (MHz)	Occupied Bandwidth (MHz)	
		CHAIN 0	CHAIN 1
54	5270	36.48	36.24
62	5310	36.48	36.48
102	5510	36.24	36.24
110	5550	36.24	36.24
134	5670	36.24	36.24
142 (UNII-2C Band)	5710	33.20	33.20
142 (UNII-3 Band)	5710	3.00	3.00

802.11ac (VHT80)

Channel	Channel Frequency (MHz)	Occupied Bandwidth (MHz)	
		CHAIN 0	CHAIN 1
122	5610	75.84	76.32
138 (UNII-2C Band)	5690	72.92	72.92
138 (UNII-3 Band)	5690	2.92	2.92

Spectrum Plot of Worst Value

802.11a_Chain0 / CH100

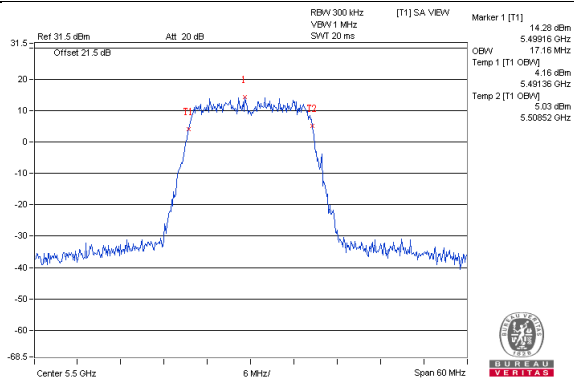

802.11ac (VHT20)_Chain0 / CH100

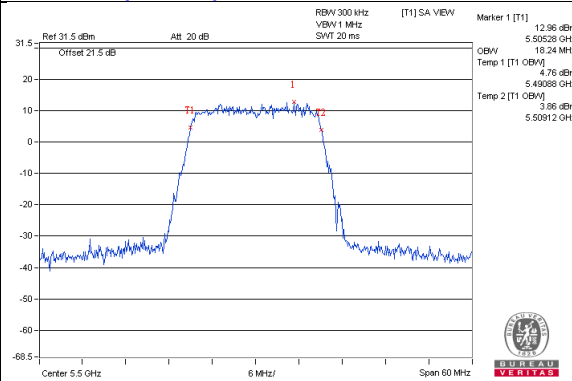

802.11ac (VHT40)_Chain0 / CH102

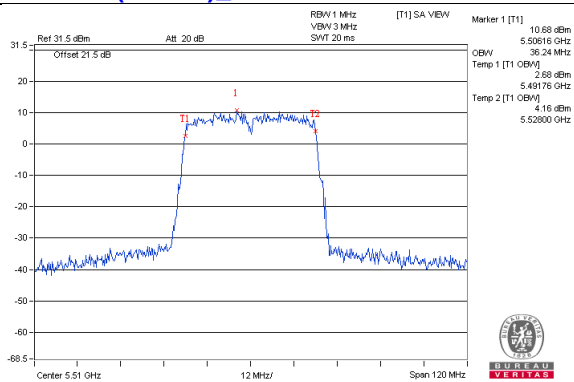

802.11ac (VHT80)_Chain1 / CH122

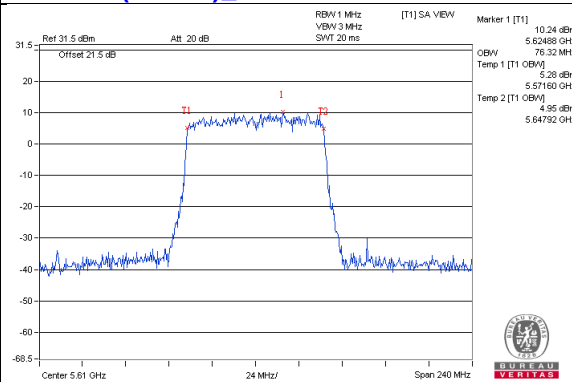

1TX Mode
Radio 2
802.11a

Channel	Channel Frequency (MHz)	Occupied Bandwidth (MHz)
52	5260	19.66
60	5300	18.00
64	5320	18.36

802.11ac (VHT20)

Channel	Channel Frequency (MHz)	Occupied Bandwidth (MHz)
52	5260	19.76
60	5300	18.84
64	5320	19.32

802.11ac (VHT40)

Channel	Channel Frequency (MHz)	Occupied Bandwidth (MHz)
54	5270	39.20
62	5310	36.48

802.11ac (VHT80)

Channel	Channel Frequency (MHz)	Occupied Bandwidth (MHz)
58	5290	75.84

Spectrum Plot of Worst Value

802.11a / CH52

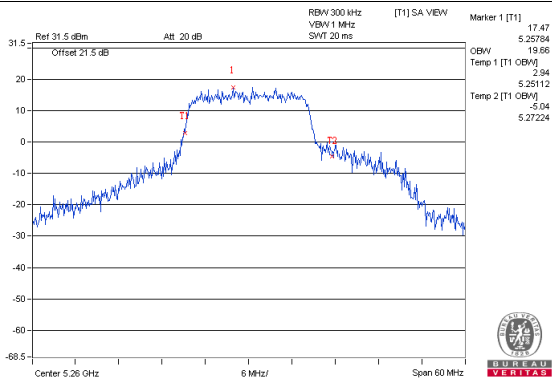

802.11ac (VHT20) / CH52

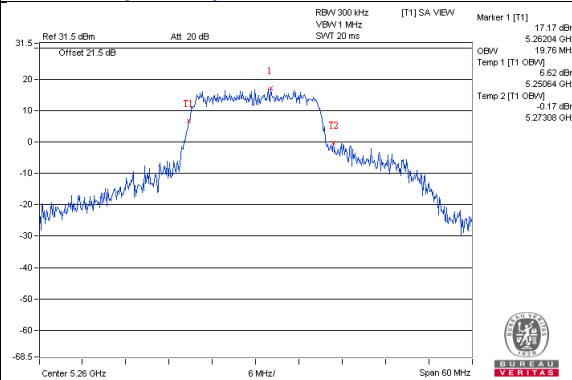

802.11ac (VHT40) / CH54

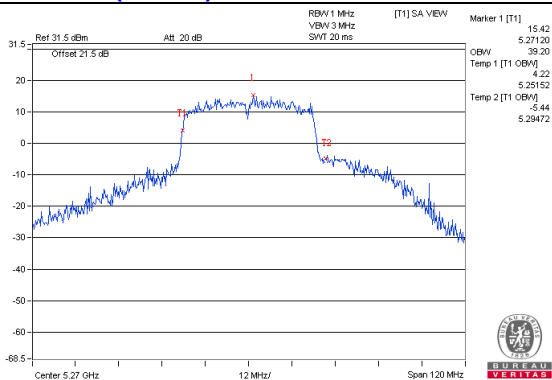

802.11ac (VHT80) / CH58

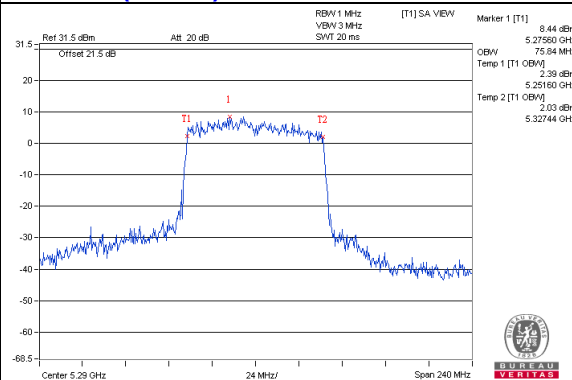

Radio 1
802.11a

Channel	Channel Frequency (MHz)	Occupied Bandwidth (MHz)
100	5500	17.16
116	5580	16.68
140	5700	17.16
144 (UNII-2C Band)	5720	13.40
144 (UNII-3 Band)	5720	3.28

802.11ac (VHT20)

Channel	Channel Frequency (MHz)	Occupied Bandwidth (MHz)
100	5500	18.36
116	5580	17.76
140	5700	18.24
144 (UNII-2C Band)	5720	13.88
144 (UNII-3 Band)	5720	3.88

802.11ac (VHT40)

Channel	Channel Frequency (MHz)	Occupied Bandwidth (MHz)
102	5510	36.24
110	5550	36.24
134	5670	36.48
142 (UNII-2C Band)	5710	33.40
142 (UNII-3 Band)	5710	3.00

802.11ac (VHT80)

Channel	Channel Frequency (MHz)	Occupied Bandwidth (MHz)
106	5530	76.32
122	5610	76.32
138 (UNII-2C Band)	5690	73.40
138 (UNII-3 Band)	5690	2.44

Spectrum Plot of Worst Value

802.11a / CH100

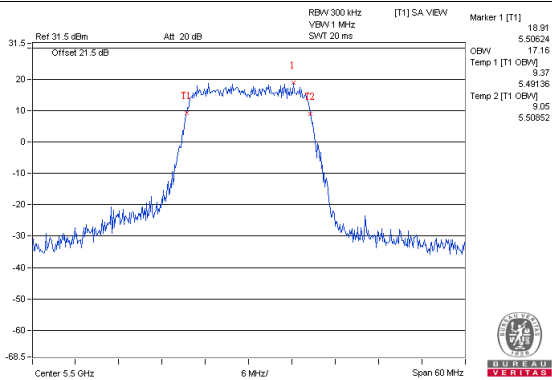

802.11ac (VHT20) / CH100

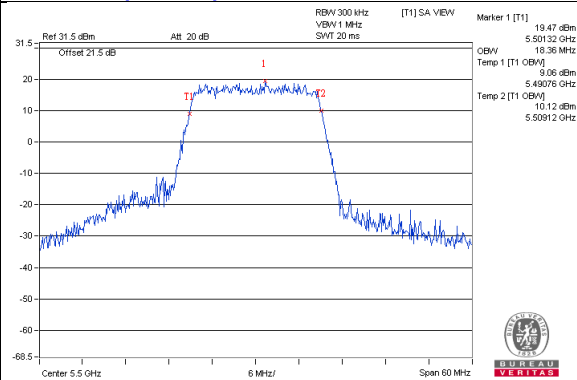

802.11ac (VHT40) / CH134

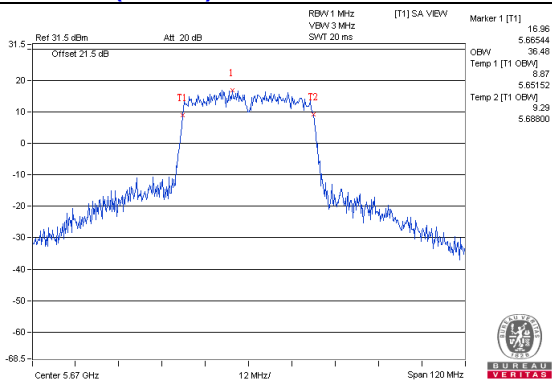

802.11ac (VHT80) / CH106

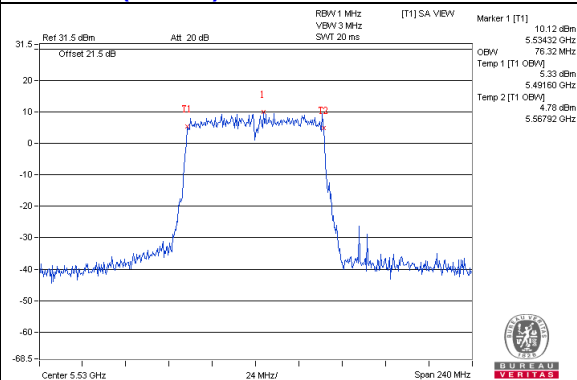

4.5 Peak Power Spectral Density Measurement

4.5.1 Limits of Peak Power Spectral Density Measurement

Operation Band	EUT Category		Limit
U-NII-1		Outdoor Access Point	17dBm/ MHz
		Fixed point-to-point Access Point	
		Indoor Access Point	
		Mobile and Portable client device	11dBm/ MHz
U-NII-2A		√	11dBm/ MHz
U-NII-2C		√	11dBm/ MHz
U-NII-3		√	30dBm/ 500kHz

4.5.2 Test Setup

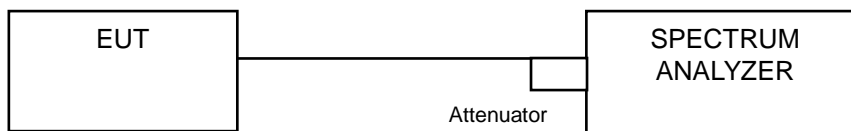

4.5.3 Test Instruments

Refer to section 4.1.2 to get information of above instrument.

4.5.4 Test Procedure

802.11ac (VHT20)

For U-NII-2A, UNII-2C:

Using method SA-1

1. Set span to encompass the entire emission bandwidth (EBW) of the signal.
2. Set RBW = 1 MHz, Set VBW \geq 3 MHz, Detector = RMS
3. Sweep time = auto, trigger set to "free run".
4. Trace average at least 100 traces in power averaging mode.
5. Record the max value

For U-NII-3:

1. Set span to encompass the entire emission bandwidth (EBW) of the signal.
2. Set RBW = 300 kHz, Set VBW \geq 1 MHz, Detector = RMS
3. Use the peak marker function to determine the maximum power level in any 300 kHz band segment within the fundamental EBW.
4. Scale the observed power level to an equivalent value in 500 kHz by adjusting (reducing) the measured power by a bandwidth correction factor (BWCF) where $BWCF = 10\log(500 \text{ kHz}/300\text{kHz})$
5. Sweep time = auto, trigger set to "free run".
6. Trace average at least 100 traces in power averaging mode.
7. Record the max value

802.11a, 802.11ac (VHT40), 802.11ac (VHT80)

For U-NII-2A, UNII-2C:

Using method SA-2

1. Set span to encompass the entire emission bandwidth (EBW) of the signal.
2. Set RBW = 1 MHz, Set VBW \geq 3 MHz, Detector = RMS
3. Sweep time = auto, trigger set to "free run".
4. Trace average at least 100 traces in power averaging mode.
5. Record the max value and add $10 \log (1/\text{duty cycle})$

For U-NII-3:

1. Set span to encompass the entire emission bandwidth (EBW) of the signal.
2. Set RBW = 300 kHz, Set VBW \geq 1 MHz, Detector = RMS
3. Use the peak marker function to determine the maximum power level in any 300 kHz band segment within the fundamental EBW.
4. Scale the observed power level to an equivalent value in 500 kHz by adjusting (reducing) the measured power by a bandwidth correction factor (BWCF) where $BWCF = 10\log(500 \text{ kHz}/300\text{kHz})$
5. Sweep time = auto, trigger set to "free run".
6. Trace average at least 100 traces in power averaging mode.
7. Record the max value and add $10 \log (1/\text{duty cycle})$

4.5.5 Deviation from Test Standard

No deviation.

4.5.6 EUT Operating Condition

Same as Item 4.3.6.

4.5.7 Test Results

Radio 2

2TX Mode

802.11a

Chan.	Chan. Freq. (MHz)	PSD W/O Duty Factor (dBm)		Duty Factor (dB)	Total PSD With Duty Factor (dBm)	MAX. Limit (dBm)	Pass / Fail
		Chain 0	Chain 1				
52	5260	4.96	4.93	0.17	8.13	8.73	Pass
60	5300	5.29	4.34	0.17	8.02	8.73	Pass
64	5320	5.18	4.98	0.17	8.26	8.73	Pass

- Note:** 1. Method a) of power density measurement of KDB 662911 is using for calculating total power density. Total power density is summing entire spectra across corresponding frequency bins on the various outputs by computer.
2. Directional gain = $10 \log[(10^{G1/20} + 10^{G2/20})^2 / 2] = 8.27\text{dBi} > 6\text{dBi}$, so the power density limit shall be reduced to $11-(8.27-6) = 8.73\text{dBm}$.
3. Refer to section 3.3 for duty cycle spectrum plot.

802.11ac (VHT20)

Chan.	Chan. Freq. (MHz)	PSD (dBm/MHz)		Total Power Density (dBm/MHz)	MAX. Limit (dBm/MHz)	Pass / Fail
		Chain 0	Chain 1			
52	5260	4.71	4.63	7.68	8.73	Pass
60	5300	4.38	4.54	7.47	8.73	Pass
64	5320	3.78	4.07	6.94	8.73	Pass

- Note:** 1. Method a) of power density measurement of KDB 662911 is using for calculating total power density. Total power density is summing entire spectra across corresponding frequency bins on the various outputs by computer.
2. Directional gain = $10 \log[(10^{G1/20} + 10^{G2/20})^2 / 2] = 8.27\text{dBi} > 6\text{dBi}$, so the power density limit shall be reduced to $11-(8.27-6) = 8.73\text{dBm}$.

802.11ac (VHT40)

Chan.	Chan. Freq. (MHz)	PSD W/O Duty Factor (dBm)		Duty Factor (dB)	Total PSD With Duty Factor (dBm)	MAX. Limit (dBm)	Pass / Fail
		Chain 0	Chain 1				
54	5270	3.31	4.10	0.16	6.89	8.73	Pass
62	5310	-1.29	-1.70	0.16	1.68	8.73	Pass

- Note:** 1. Method a) of power density measurement of KDB 662911 is using for calculating total power density. Total power density is summing entire spectra across corresponding frequency bins on the various outputs by computer.
2. Directional gain = $10 \log[(10^{G1/20} + 10^{G2/20})^2 / 2] = 8.27\text{dBi} > 6\text{dBi}$, so the power density limit shall be reduced to $11-(8.27-6) = 8.73\text{dBm}$.
3. Refer to section 3.3 for duty cycle spectrum plot.

802.11ac (VHT80)

Chan.	Chan. Freq. (MHz)	PSD W/O Duty Factor (dBm)		Duty Factor (dB)	Total PSD With Duty Factor (dBm)	MAX. Limit (dBm)	Pass / Fail
		Chain 0	Chain 1				
58	5290	-2.69	-3.09	0.29	0.42	8.73	Pass

- Note:**
- Method a) of power density measurement of KDB 662911 is using for calculating total power density. Total power density is summing entire spectra across corresponding frequency bins on the various outputs by computer.
 - Directional gain = $10 \log[(10^{G1/20} + 10^{G2/20})^2 / 2] = 8.27\text{dBi} > 6\text{dBi}$, so the power density limit shall be reduced to $11-(8.27-6) = 8.73\text{dBm}$.
 - Refer to section 3.3 for duty cycle spectrum plot.

Spectrum Plot of Worst Value

802.11a_Chain 0 / CH64

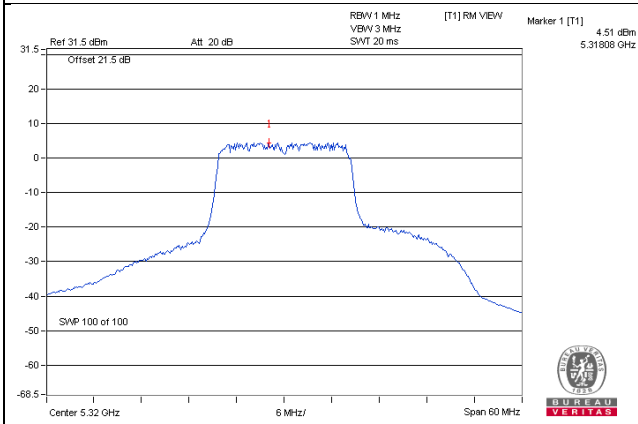

802.11ac (VHT20)_Chain 0 / CH52

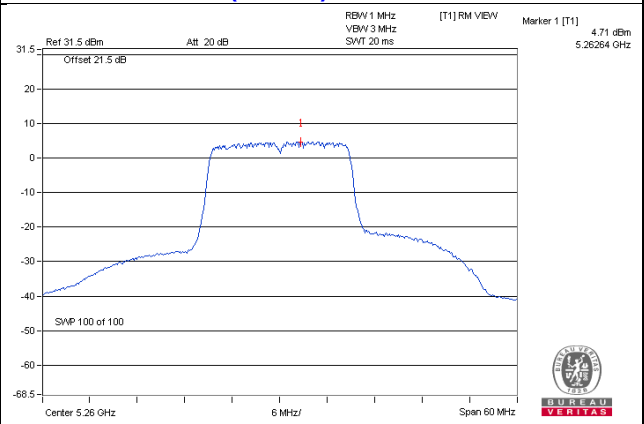

802.11ac (VHT40)_Chain 0 / CH54

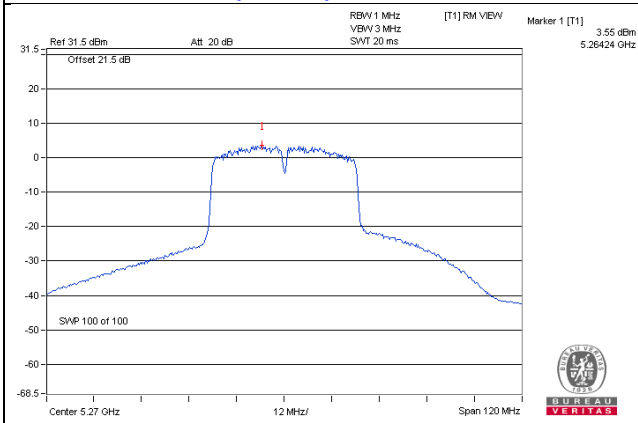

802.11ac (VHT80)_Chain 0 / CH58

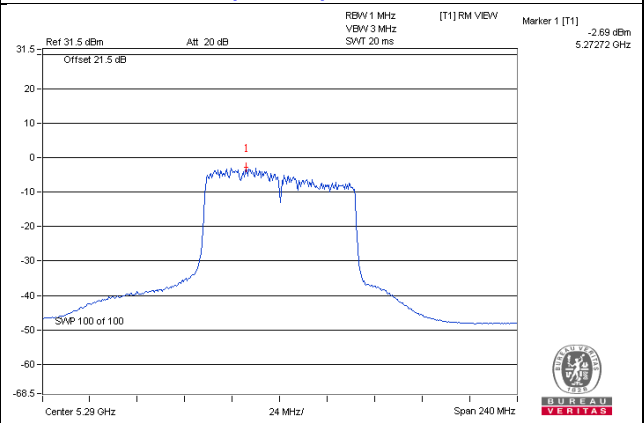

1TX Mode

802.11a

Chan.	Chan. Freq. (MHz)	PSD W/O Duty Factor (dBm/MHz)	Duty Factor (dB)	PSD With Duty Factor (dBm/MHz)	MAX. Limit (dBm/MHz)	Pass / Fail
52	5260	7.07	0.17	7.24	11.00	Pass
60	5300	7.67	0.17	7.84	11.00	Pass
64	5320	6.26	0.17	6.43	11.00	Pass

Note: 1. Refer to section 3.3 for duty cycle spectrum plot.

802.11ac (VHT20)

Chan.	Chan. Freq. (MHz)	PSD (dBm/MHz)	MAX. Limit (dBm/MHz)	Pass / Fail
52	5260	6.88	11.00	Pass
60	5300	7.40	11.00	Pass
64	5320	6.02	11.00	Pass

802.11ac (VHT40)

Chan.	Chan. Freq. (MHz)	PSD W/O Duty Factor (dBm/MHz)	Duty Factor (dB)	PSD With Duty Factor (dBm/MHz)	MAX. Limit (dBm/MHz)	Pass / Fail
54	5270	4.99	0.16	5.15	11.00	Pass
62	5310	1.57	0.16	1.73	11.00	Pass

Note: 1. Refer to section 3.3 for duty cycle spectrum plot.

802.11ac (VHT80)

Chan.	Chan. Freq. (MHz)	PSD W/O Duty Factor (dBm/MHz)	Duty Factor (dB)	PSD With Duty Factor (dBm/MHz)	MAX. Limit (dBm/MHz)	Pass / Fail
58	5290	-1.34	0.29	-1.05	11.00	Pass

Note: 1. Refer to section 3.3 for duty cycle spectrum plot.

Spectrum Plot of Worst Value

802.11a / CH60

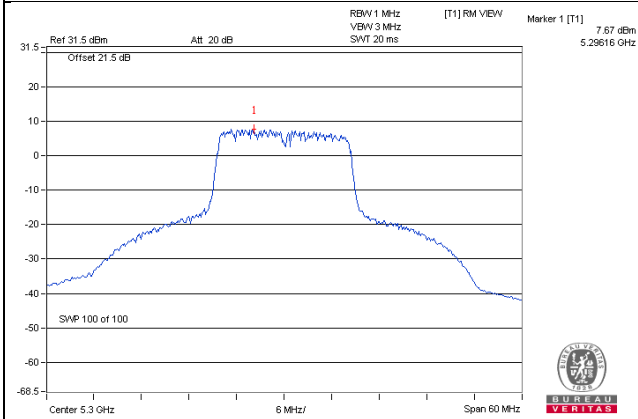

802.11ac (VHT20) / CH60

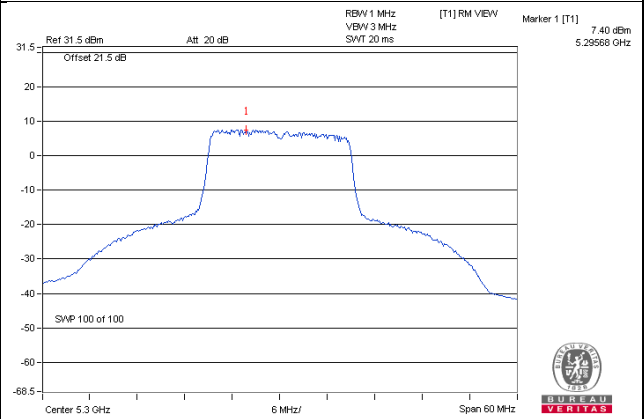

802.11ac (VHT40) / CH54

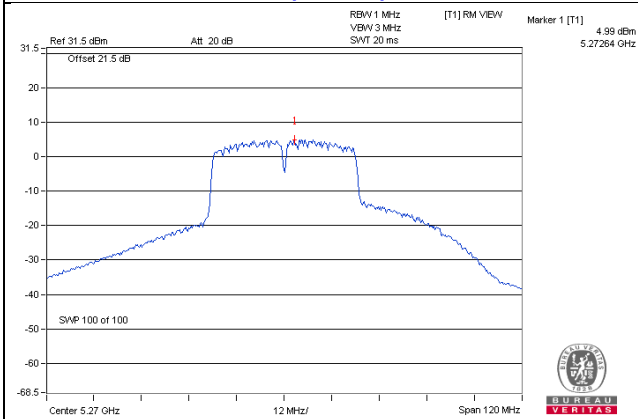

802.11ac (VHT80) / CH58

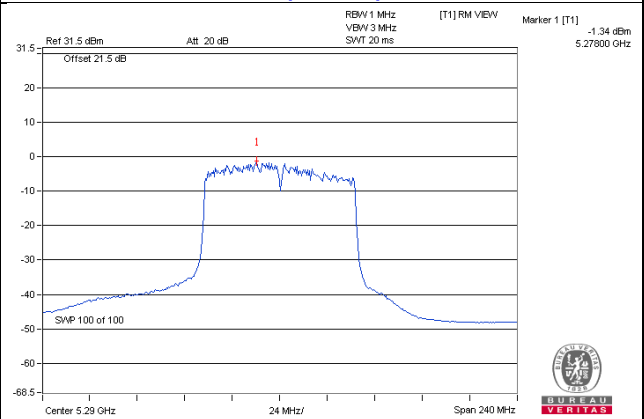

Radio 2 (UNII-2C)
2TX Mode
802.11a

Chan.	Chan. Freq. (MHz)	PSD W/O Duty Factor (dBm)		Duty Factor (dB)	Total PSD With Duty Factor (dBm)	MAX. Limit (dBm)	Pass / Fail
		Chain 0	Chain 1				
100	5500	4.22	3.40	0.17	7.01	7.51	Pass
116	5580	4.34	3.10	0.17	6.95	7.51	Pass
140	5700	4.30	3.21	0.17	6.97	7.51	Pass
144 (UNII-2C Band)	5720	4.51	3.05	0.17	7.02	7.51	Pass

- Note:** 1. Method a) of power density measurement of KDB 662911 is using for calculating total power density. Total power density is summing entire spectra across corresponding frequency bins on the various outputs by computer.
2. Directional gain = $10 \log[(10^{G1/20} + 10^{G2/20})^2 / 2] = 9.49\text{dBi} > 6\text{dBi}$, so the power density limit shall be reduced to $11-(9.49-6) = 7.51\text{dBm}$.
3. Refer to section 3.3 for duty cycle spectrum plot.

802.11ac (VHT20)

Chan.	Chan. Freq. (MHz)	PSD (dBm/MHz)		Total Power Density (dBm/MHz)	MAX. Limit (dBm/MHz)	Pass / Fail
		Chain 0	Chain 1			
100	5500	2.52	3.63	6.12	7.51	Pass
116	5580	3.16	3.20	6.19	7.51	Pass
140	5700	3.29	2.68	6.01	7.51	Pass
144 (UNII-2C Band)	5720	3.55	2.64	6.13	7.51	Pass

- Note:** 1. Method a) of power density measurement of KDB 662911 is using for calculating total power density. Total power density is summing entire spectra across corresponding frequency bins on the various outputs by computer.
2. Directional gain = $10 \log[(10^{G1/20} + 10^{G2/20})^2 / 2] = 9.49\text{dBi} > 6\text{dBi}$, so the power density limit shall be reduced to $11-(9.49-6) = 7.51\text{dBm}$.

802.11ac (VHT40)

Chan.	Chan. Freq. (MHz)	PSD W/O Duty Factor (dBm)		Duty Factor (dB)	Total PSD With Duty Factor (dBm)	MAX. Limit (dBm)	Pass / Fail
		Chain 0	Chain 1				
102	5510	0.76	1.79	0.16	4.47	7.51	Pass
110	5550	3.70	4.08	0.16	7.06	7.51	Pass
134	5670	3.31	2.50	0.16	6.09	7.51	Pass
142 (UNII-2C Band)	5710	3.45	2.64	0.16	6.23	7.51	Pass

- Note:** 1. Method a) of power density measurement of KDB 662911 is using for calculating total power density. Total power density is summing entire spectra across corresponding frequency bins on the various outputs by computer.
2. Directional gain = $10 \log[(10^{G1/20} + 10^{G2/20})^2 / 2] = 9.49\text{dBi} > 6\text{dBi}$, so the power density limit shall be reduced to $11-(9.49-6) = 7.51\text{dBm}$.
3. Refer to section 3.3 for duty cycle spectrum plot.

802.11ac (VHT80)

Chan.	Chan. Freq. (MHz)	PSD W/O Duty Factor (dBm)		Duty Factor (dB)	Total PSD With Duty Factor (dBm)	MAX. Limit (dBm)	Pass / Fail
		Chain 0	Chain 1				
106	5530	-3.42	-1.40	0.29	1.01	7.51	Pass
122	5610	-0.45	-0.37	0.29	2.89	7.51	Pass
138 (UNII-2C Band)	5690	-0.28	-1.27	0.29	2.56	7.51	Pass

- Note:** 1. Method a) of power density measurement of KDB 662911 is using for calculating total power density. Total power density is summing entire spectra across corresponding frequency bins on the various outputs by computer.
2. Directional gain = $10 \log[(10^{G1/20} + 10^{G2/20})^2 / 2] = 9.49\text{dBi} > 6\text{dBi}$, so the power density limit shall be reduced to $11-(9.49-6) = 7.51\text{dBm}$.
3. Refer to section 3.3 for duty cycle spectrum plot.

Spectrum Plot of Worst Value

802.11a_Chain 0 / CH144 (UNII-2C)

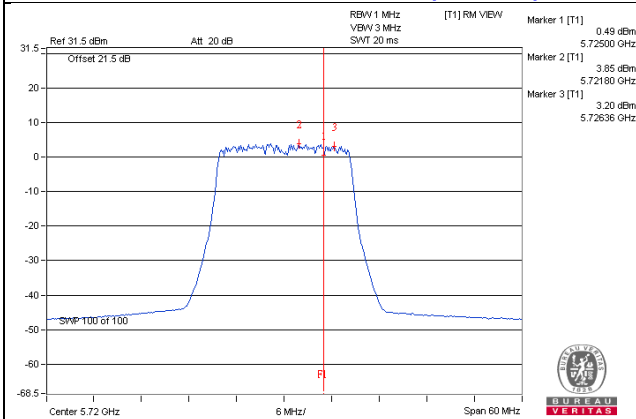

802.11ac (VHT20)_Chain 1 / CH100

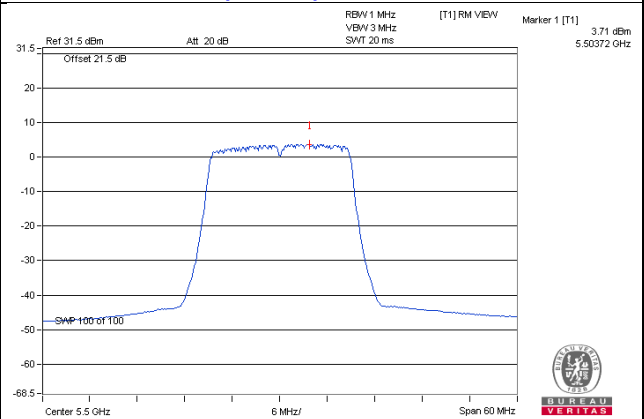

802.11ac (VHT40)_Chain 1 / CH110

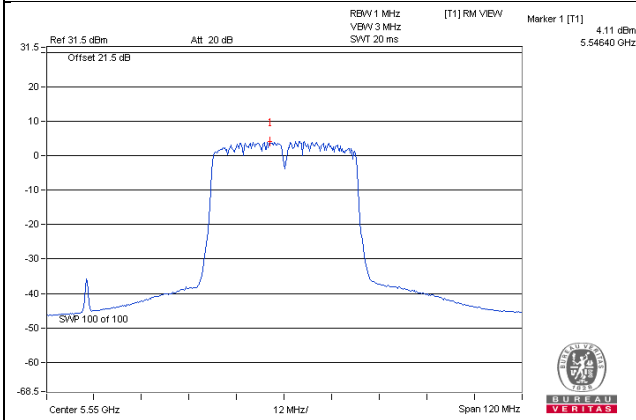

802.11ac (VHT80)_Chain 1 / CH122

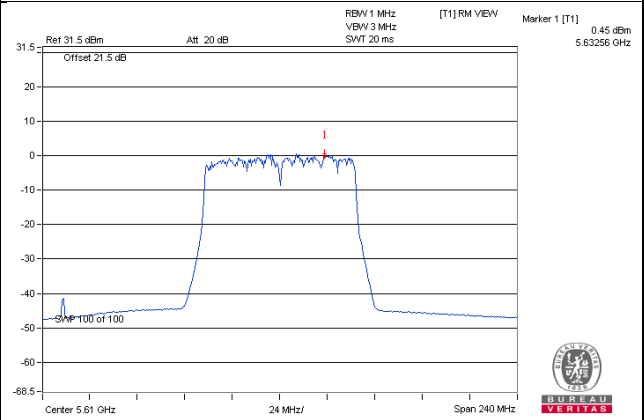

1TX Mode

802.11a

Chan.	Chan. Freq. (MHz)	PSD W/O Duty Factor (dBm/MHz)	Duty Factor (dB)	PSD With Duty Factor (dBm/MHz)	MAX. Limit (dBm/MHz)	Pass / Fail
100	5500	8.55	0.17	8.72	10.21	Pass
116	5580	9.98	0.17	10.15	10.21	Pass
140	5700	9.70	0.17	9.87	10.21	Pass
144 (UNII-2C Band)	5720	9.76	0.17	9.93	10.21	Pass

- Note:** 1. The max antenna gain = 6.79dBi > 6dBi, so the power density limit shall be reduced to $11-(6.79-6) = 10.21\text{dBm}$.
2. Refer to section 3.3 for duty cycle spectrum plot.

802.11ac (VHT20)

Chan.	Chan. Freq. (MHz)	PSD (dBm/MHz)	MAX. Limit (dBm/MHz)	Pass / Fail
100	5500	9.21	10.21	Pass
116	5580	9.63	10.21	Pass
140	5700	9.67	10.21	Pass
144 (UNII-2C Band)	5720	9.50	10.21	Pass

- Note:** 1. The max antenna gain = 6.79dBi > 6dBi, so the power density limit shall be reduced to $11-(6.79-6) = 10.21\text{dBm}$.

802.11ac (VHT40)

Chan.	Chan. Freq. (MHz)	PSD W/O Duty Factor (dBm/MHz)	Duty Factor (dB)	PSD With Duty Factor (dBm/MHz)	MAX. Limit (dBm/MHz)	Pass / Fail
102	5510	4.84	0.16	5.00	10.21	Pass
110	5550	6.88	0.16	7.04	10.21	Pass
134	5670	6.95	0.16	7.11	10.21	Pass
142 (UNII-2C Band)	5710	6.68	0.16	6.84	10.21	Pass

- Note:** 1. The max antenna gain = 6.79dBi > 6dBi, so the power density limit shall be reduced to $11-(6.79-6) = 10.21\text{dBm}$.
2. Refer to section 3.3 for duty cycle spectrum plot.

802.11ac (VHT80)

Chan.	Chan. Freq. (MHz)	PSD W/O Duty Factor (dBm/MHz)	Duty Factor (dB)	PSD With Duty Factor (dBm/MHz)	MAX. Limit (dBm/MHz)	Pass / Fail
106	5530	-0.34	0.29	-0.05	10.21	Pass
122	5610	3.01	0.29	3.30	10.21	Pass
138 (UNII-2C Band)	5690	1.87	0.29	2.16	10.21	Pass

- Note:**
1. The max antenna gain = 6.79dBi > 6dBi, so the power density limit shall be reduced to $11 - (6.79 - 6) = 10.21$ dBm.
 2. Refer to section 3.3 for duty cycle spectrum plot.

Spectrum Plot of Worst Value

802.11a / CH116

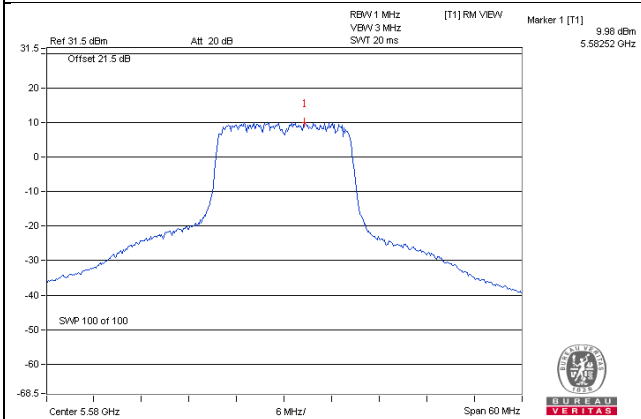

802.11ac (VHT20) / CH140

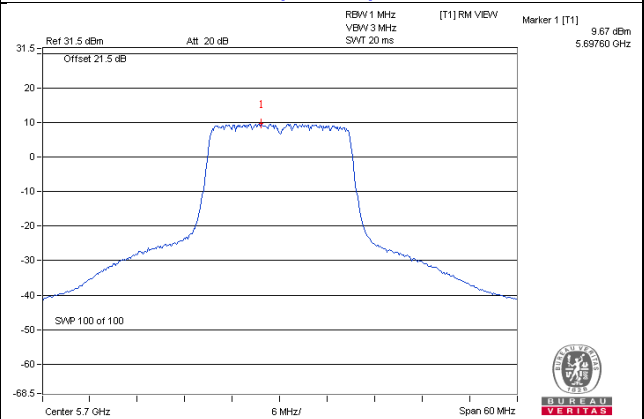

802.11ac (VHT40) / CH134

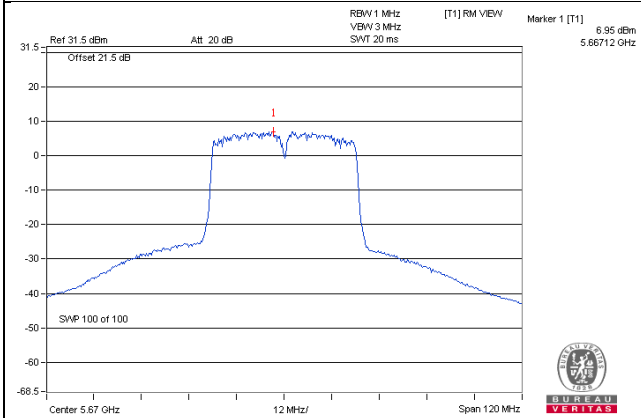

802.11ac (VHT80) / CH122

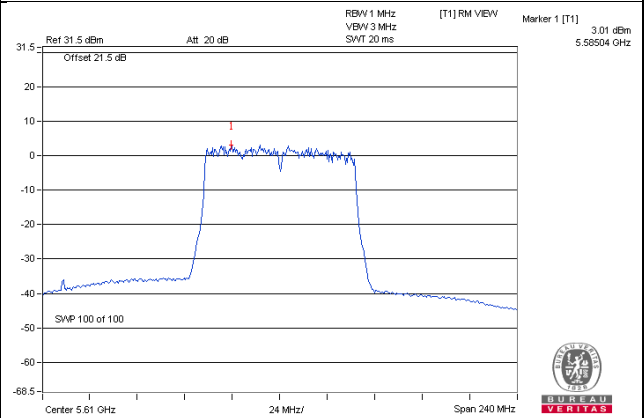

Radio 2 (UNII-3)

2TX Mode

802.11a

TX chain	Chan.	Chan. Freq. (MHz)	PSD W/O Duty Factor		10 log (N=2) dB	Duty Factor (dB)	Total PSD With Duty Factor (dBm/500kHz)	Limit (dBm/500kHz)	Pass /Fail
			(dBm/300kHz)	(dBm/500kHz)					
0	144 (U-NII-3 Band)	5720	-5.02	-2.80	3.01	0.17	0.38	26.51	Pass
1	144 (U-NII-3 Band)	5720	-5.46	-3.24	3.01	0.17	-0.06	26.51	Pass

Note: 1. Directional gain = $10 \log[(10^{G1/20} + 10^{G2/20})^2 / 2] = 9.49\text{dBi} > 6\text{dBi}$, so the power density limit shall be reduced to $30-(9.49-6) = 26.51\text{dBm}$.

2. Refer to section 3.3 for duty cycle spectrum plot.

802.11ac (VHT20)

TX chain	Channel	Freq. (MHz)	PSD (dBm/300kHz)	PSD (dBm/500kHz)	10 log (N=2) dB	Total PSD (dBm/500kHz)	Limit (dBm/500kHz)	Pass /Fail
0	144 (U-NII-3 Band)	5720	-4.92	-2.70	3.01	0.31	26.51	Pass
1	144 (U-NII-3 Band)	5720	-5.59	-3.37	3.01	-0.36	26.51	Pass

Note: 1. Directional gain = $10 \log[(10^{G1/20} + 10^{G2/20})^2 / 2] = 9.49\text{dBi} > 6\text{dBi}$, so the power density limit shall be reduced to $30-(9.49-6) = 26.51\text{dBm}$.

802.11ac (VHT40)

TX chain	Chan.	Chan. Freq. (MHz)	PSD W/O Duty Factor		10 log (N=2) dB	Duty Factor (dB)	Total PSD With Duty Factor (dBm/500kHz)	Limit (dBm/500kHz)	Pass /Fail
			(dBm/300kHz)	(dBm/500kHz)					
0	142 (U-NII-3 Band)	5710	-6.49	-4.27	3.01	0.16	-1.10	26.51	Pass
1	142 (U-NII-3 Band)	5710	-7.01	-4.79	3.01	0.16	-1.62	26.51	Pass

Note: 1. Directional gain = $10 \log[(10^{G1/20} + 10^{G2/20})^2 / 2] = 9.49\text{dBi} > 6\text{dBi}$, so the power density limit shall be reduced to $30-(9.49-6) = 26.51\text{dBm}$.

2. Refer to section 3.3 for duty cycle spectrum plot.

802.11ac (VHT80)

TX chain	Chan.	Chan. Freq. (MHz)	PSD W/O Duty Factor		10 log (N=2) dB	Duty Factor (dB)	Total PSD With Duty Factor (dBm/500kHz)	Limit (dBm/500kHz)	Pass /Fail
			(dBm/300kHz)	(dBm/500kHz)					
0	138 (U-NII-3 Band)	5690	-10.07	-7.85	3.01	0.29	-4.55	26.51	Pass
1	138 (U-NII-3 Band)	5690	-10.23	-8.01	3.01	0.29	-4.71	26.51	Pass

Note: 1. Directional gain = $10 \log[(10^{G1/20} + 10^{G2/20})^2 / 2] = 9.49\text{dBi} > 6\text{dBi}$, so the power density limit shall be reduced to $30 - (9.49 - 6) = 26.51\text{dBm}$.

2. Refer to section 3.3 for duty cycle spectrum plot.

Spectrum Plot of Worst Value

802.11a – Chain 0: CH 144 (U-NII-3)

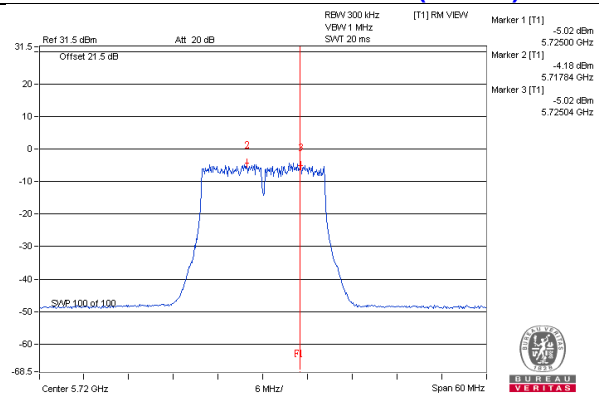

802.11ac (VHT20) – Chain 0: CH 144 (U-NII-3)

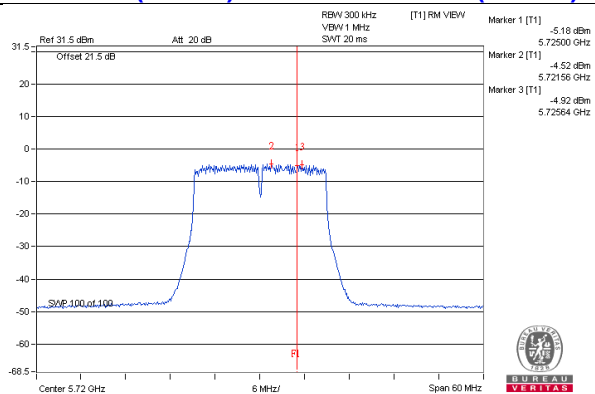

802.11ac (VHT40) – Chain 0: CH 142 (U-NII-3)

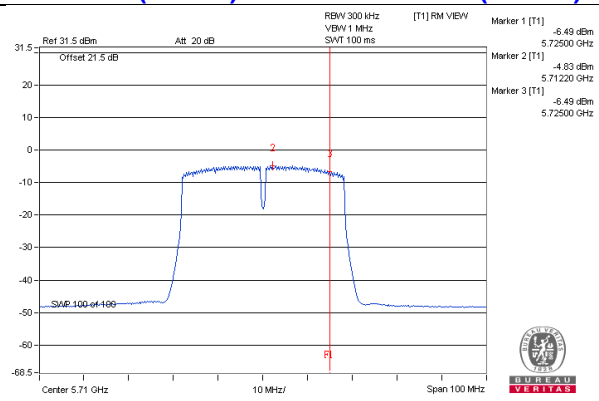

802.11ac (VHT80) – Chain 0: CH 138 (U-NII-3)

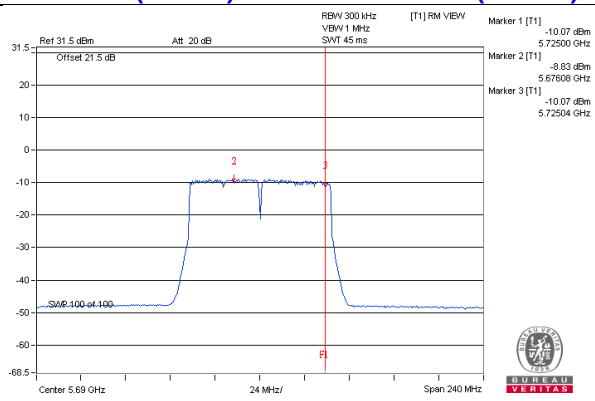

1TX Mode

802.11a

Chan.	Chan. Freq. (MHz)	PSD W/O Duty Factor		Duty Factor (dB)	Total PSD With Duty Factor (dBm/500kHz)	Limit (dBm/500kHz)	Pass /Fail
		(dBm/300kHz)	(dBm/500kHz)				
144 (U-NII-3 Band)	5720	0.99	3.21	0.17	3.38	29.21	Pass

Note: 1. Refer to section 3.3 for duty cycle spectrum plot.

802.11ac (VHT20)

Chan.	Chan. Freq. (MHz)	PSD (dBm/300kHz)	PSD (dBm/500kHz)	Limit (dBm/500kHz)	Pass /Fail
144 (U-NII-3 Band)	5720	0.85	3.07	29.21	Pass

802.11ac (VHT40)

Chan.	Chan. Freq. (MHz)	PSD W/O Duty Factor		Duty Factor (dB)	Total PSD With Duty Factor (dBm/500kHz)	Limit (dBm/500kHz)	Pass /Fail
		(dBm/300kHz)	(dBm/500kHz)				
142 (U-NII-3 Band)	5710	-3.15	-0.93	0.16	-0.77	29.21	Pass

Note: 1. Refer to section 3.3 for duty cycle spectrum plot.

802.11ac (VHT80)

Chan.	Chan. Freq. (MHz)	PSD W/O Duty Factor		Duty Factor (dB)	Total PSD With Duty Factor (dBm/500kHz)	Limit (dBm/500kHz)	Pass /Fail
		(dBm/300kHz)	(dBm/500kHz)				
138 (U-NII-3 Band)	5690	-7.92	-5.70	0.29	-5.41	29.21	Pass

Note: 1. Refer to section 3.3 for duty cycle spectrum plot.

Spectrum Plot of Worst Value

802.11a: CH 144 (UNII-3)

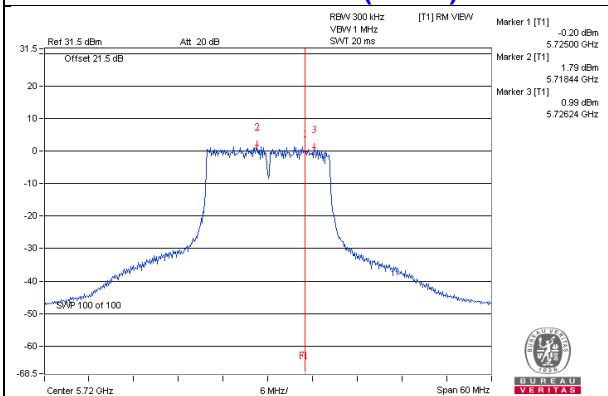

802.11ac (VHT20): CH 144 (UNII-3)

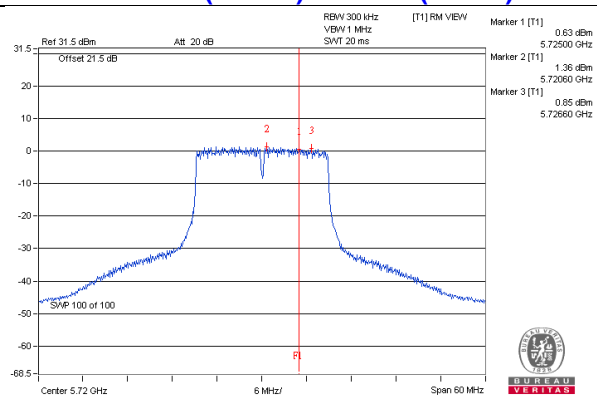

802.11ac (VHT40): CH 142 (UNII-3)

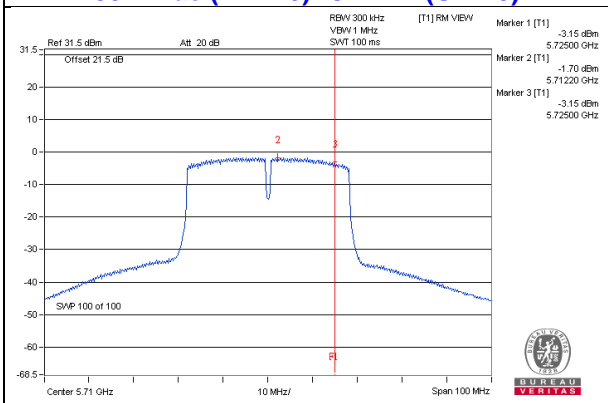

802.11ac (VHT80): CH 138 (UNII-3)

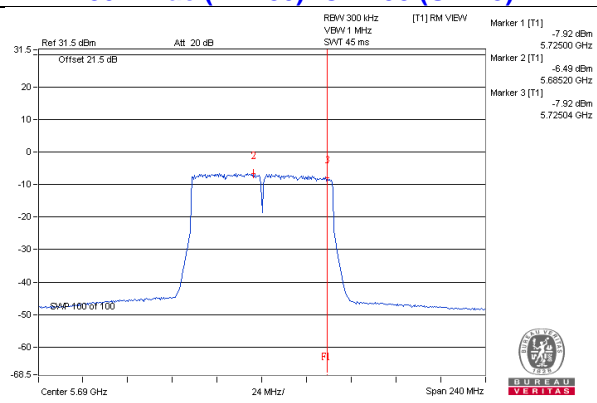

4.6 Frequency Stability Measurement

4.6.1 Limits of Frequency Stability Measurement

The frequency of the carrier signal shall be maintained within band of operation

4.6.2 Test Setup

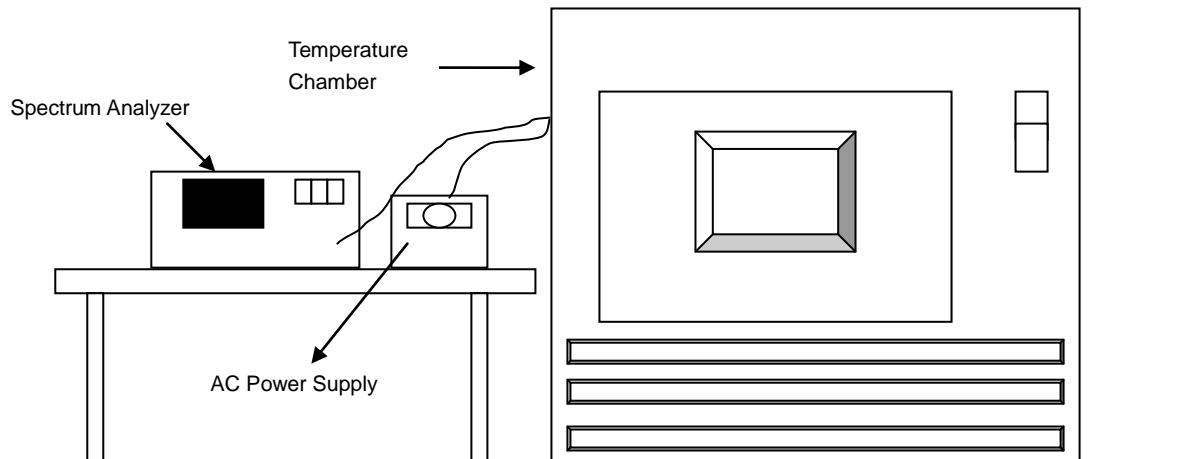

4.6.3 Test Instruments

Refer to section 4.1.2 to get information of above instrument.

4.6.4 Test Procedure

- The EUT was placed inside the environmental test chamber and powered by nominal AC voltage.
- Turn the EUT on and couple its output to a spectrum analyzer.
- Turn the EUT off and set the chamber to the highest temperature specified.
- Allow sufficient time (approximately 30 min) for the temperature of the chamber to stabilize, turn the EUT on and measure the operating frequency after 2, 5, and 10 Minutes.
- Repeat step 2 and 3 with the temperature chamber set to the lowest temperature.
- The test chamber was allowed to stabilize at +20 degree C for a minimum of 30 Minutes. The supply voltage was then adjusted on the EUT from 85% to 115% and the frequency record.

4.6.5 Deviation from Test Standard

No deviation.

4.6.6 EUT Operating Condition

Set the EUT transmit at un-modulation mode to test frequency stability.

4.6.7 Test Results

Radio 2

Frequency Stability Versus Temp.									
Operating Frequency: 5260 MHz									
TEMP. (°C)	Power Supply (Vac)	0 Minute		2 Minute		5 Minute		10 Minute	
		Measured Frequency (MHz)	Pass/Fail	Measured Frequency (MHz)	Pass/Fail	Measured Frequency (MHz)	Pass/Fail	Measured Frequency (MHz)	Pass/Fail
50	120	5260.0188	PASS	5260.0199	PASS	5260.0196	PASS	5260.021	PASS
40	120	5260.0109	PASS	5260.0149	PASS	5260.0146	PASS	5260.0116	PASS
30	120	5259.998	PASS	5260.0026	PASS	5260.0017	PASS	5259.9982	PASS
20	120	5259.9798	PASS	5259.9768	PASS	5259.98	PASS	5259.9798	PASS
10	120	5259.9801	PASS	5259.9788	PASS	5259.9778	PASS	5259.9777	PASS
0	120	5260.0206	PASS	5260.0226	PASS	5260.025	PASS	5260.0234	PASS
-10	120	5259.9979	PASS	5259.9979	PASS	5260.0025	PASS	5260.0022	PASS
-20	120	5260.0163	PASS	5260.0177	PASS	5260.0163	PASS	5260.0193	PASS
-30	120	5260.004	PASS	5260.0047	PASS	5260.0029	PASS	5260.0058	PASS

Frequency Stability Versus Voltage									
Operating Frequency: 5260 MHz									
TEMP. (°C)	Power Supply (Vac)	0 Minute		2 Minute		5 Minute		10 Minute	
		Measured Frequency (MHz)	Pass/Fail	Measured Frequency (MHz)	Pass/Fail	Measured Frequency (MHz)	Pass/Fail	Measured Frequency (MHz)	Pass/Fail
20	138	5259.9799	PASS	5259.9767	PASS	5259.9805	PASS	5259.98	PASS
	120	5259.9798	PASS	5259.9768	PASS	5259.98	PASS	5259.9798	PASS
	102	5259.9794	PASS	5259.9768	PASS	5259.9791	PASS	5259.979	PASS

Radio 1
Frequency Stability Versus Temp.
Operating Frequency: 5500 MHz

TEMP. (°C)	Power Supply (Vac)	0 Minute		2 Minute		5 Minute		10 Minute	
		Measured Frequency (MHz)	Pass/Fail	Measured Frequency (MHz)	Pass/Fail	Measured Frequency (MHz)	Pass/Fail	Measured Frequency (MHz)	Pass/Fail
50	120	5499.9907	PASS	5499.9875	PASS	5499.9898	PASS	5499.9922	PASS
40	120	5500.0008	PASS	5500	PASS	5500.0015	PASS	5499.9991	PASS
30	120	5500.0123	PASS	5500.0104	PASS	5500.0084	PASS	5500.0113	PASS
20	120	5499.986	PASS	5499.9835	PASS	5499.9828	PASS	5499.9846	PASS
10	120	5499.9996	PASS	5499.9973	PASS	5499.9997	PASS	5499.9985	PASS
0	120	5500.0203	PASS	5500.0211	PASS	5500.0201	PASS	5500.0185	PASS
-10	120	5500.0077	PASS	5500.0062	PASS	5500.0052	PASS	5500.0092	PASS
-20	120	5499.998	PASS	5499.9997	PASS	5500.001	PASS	5499.9966	PASS
-30	120	5500.0001	PASS	5500.0022	PASS	5500.0024	PASS	5500.0025	PASS

Frequency Stability Versus Voltage
Operating Frequency: 5500 MHz

TEMP. (°C)	Power Supply (Vac)	0 Minute		2 Minute		5 Minute		10 Minute	
		Measured Frequency (MHz)	Pass/Fail	Measured Frequency (MHz)	Pass/Fail	Measured Frequency (MHz)	Pass/Fail	Measured Frequency (MHz)	Pass/Fail
20	138	5499.9851	PASS	5499.9826	PASS	5499.983	PASS	5499.9855	PASS
	120	5499.986	PASS	5499.9835	PASS	5499.9828	PASS	5499.9846	PASS
	102	5499.9857	PASS	5499.9826	PASS	5499.9833	PASS	5499.9838	PASS

4.7 6dB Bandwidth Measurement

4.7.1 Limits of 6dB Bandwidth Measurement

The minimum of 6dB Bandwidth Measurement is 0.5MHz.

4.7.2 Test Setup

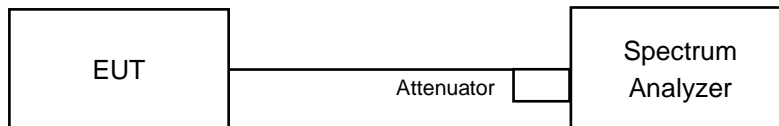

4.7.3 Test Instruments

Refer to section 4.1.2 to get information of above instrument.

4.7.4 Test Procedure

MEASUREMENT PROCEDURE REF

- a. Set resolution bandwidth (RBW) = 100kHz
- b. Set the video bandwidth (VBW) $\geq 3 \times$ RBW, Detector = Peak.
- c. Trace mode = max hold.
- d. Sweep = auto couple.
- e. Measure the maximum width of the emission that is constrained by the frequencies associated with the two amplitude points (upper and lower) that are attenuated by 6 dB relative to the maximum level measured in the fundamental emission

4.7.5 Deviation from Test Standard

No deviation.

4.7.6 EUT Operating Condition

The software provided by client to enable the EUT under transmission condition continuously at lowest, middle and highest channel frequencies individually.

4.7.7 Test Results

2TX Mode

802.11a

Channel	Frequency (MHz)	6dB Bandwidth (MHz)		Minimum Limit (MHz)	Pass / Fail
		Chain 0	Chain 1		
144 (UNII-3 Band)	5720	3.18	3.19	0.5	PASS

802.11ac (VHT20)

Channel	Frequency (MHz)	6dB Bandwidth (MHz)		Minimum Limit (MHz)	Pass / Fail
		Chain 0	Chain 1		
144 (UNII-3 Band)	5720	3.81	3.80	0.5	PASS

802.11ac (VHT40)

Channel	Frequency (MHz)	6dB Bandwidth (MHz)		Minimum Limit (MHz)	Pass / Fail
		Chain 0	Chain 1		
142 (UNII-3 Band)	5710	2.67	2.83	0.5	PASS

802.11ac (VHT80)

Channel	Frequency (MHz)	6dB Bandwidth (MHz)		Minimum Limit (MHz)	Pass / Fail
		Chain 0	Chain 1		
138 (UNII-3 Band)	5690	2.76	3.11	0.5	PASS

Spectrum Plot of Worst Value

802.11a_Chain 0 / CH144 (U-NII-3)

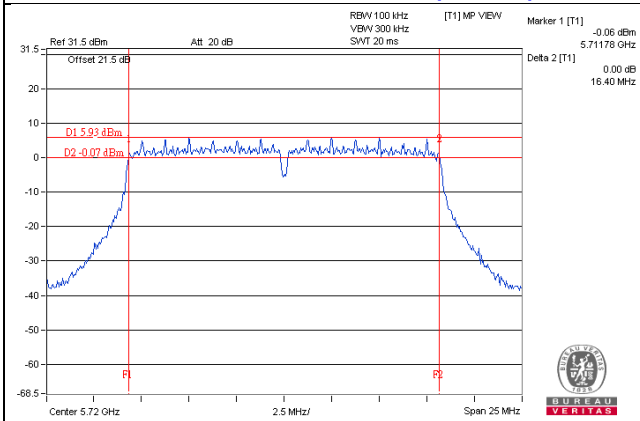

802.11ac (VHT20)_Chain 1 / CH144 (U-NII-3)

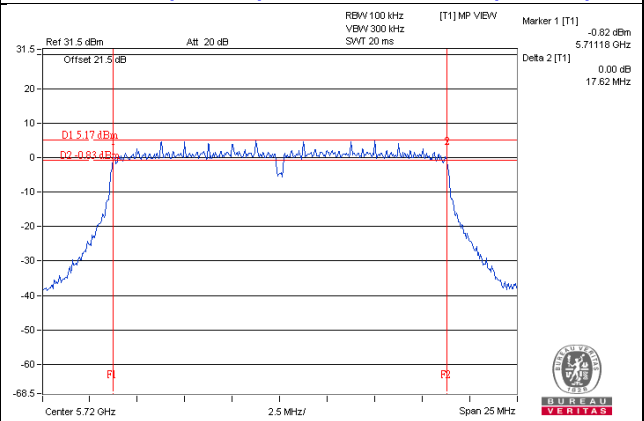

802.11ac (VHT40)_Chain 0 / CH142 (U-NII-3)

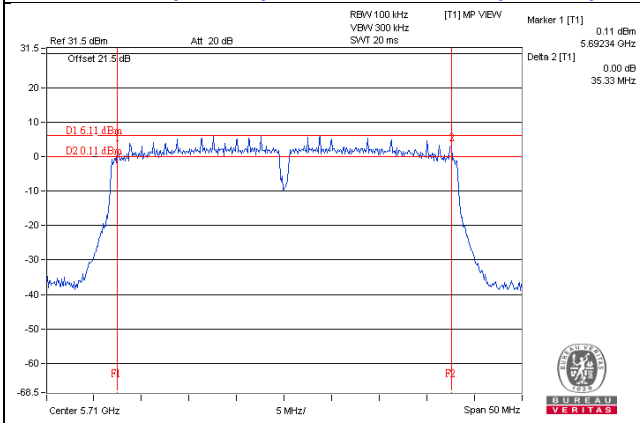

802.11ac (VHT80)_Chain 0 / CH138 (U-NII-3)

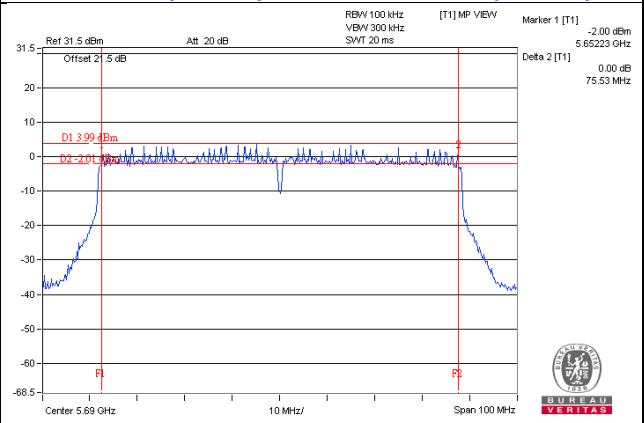

Note: The 6dB bandwidth above 5725MHz = Marker 1 + Delta 2 - 5725MHz

1TX Mode

802.11a

Channel	Frequency (MHz)	6dB Bandwidth (MHz)	Minimum Limit (MHz)	Pass / Fail
144 (UNII-3 Band)	5720	3.17	0.5	PASS

802.11ac (VHT20)

Channel	Frequency (MHz)	6dB Bandwidth (MHz)	Minimum Limit (MHz)	Pass / Fail
144 (UNII-3 Band)	5720	3.80	0.5	PASS

802.11ac (VHT40)

Channel	Frequency (MHz)	6dB Bandwidth (MHz)	Minimum Limit (MHz)	Pass / Fail
142 (UNII-3 Band)	5710	2.61	0.5	PASS

802.11ac (VHT80)

Channel	Frequency (MHz)	6dB Bandwidth (MHz)	Minimum Limit (MHz)	Pass / Fail
138 (UNII-3 Band)	5690	2.77	0.5	PASS

Spectrum Plot of Worst Value

802.11a / CH144 (U-NII-3)

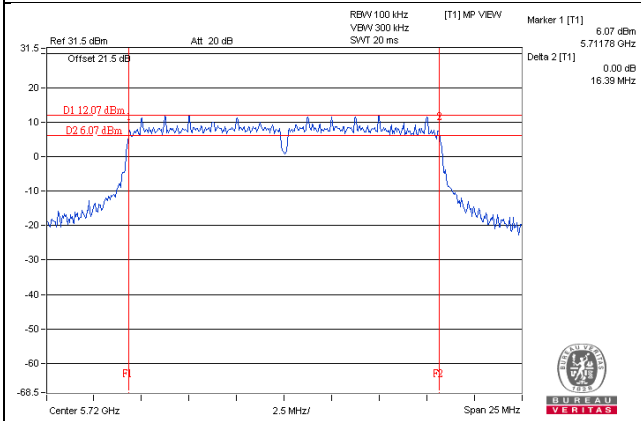

802.11ac (VHT20) / CH144 (U-NII-3)

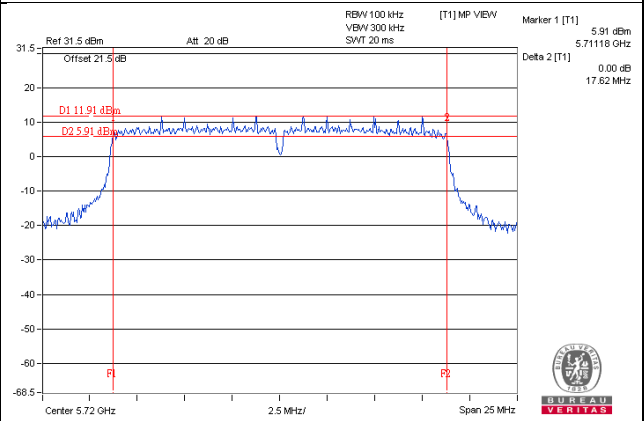

802.11ac (VHT40) / CH142 (U-NII-3)

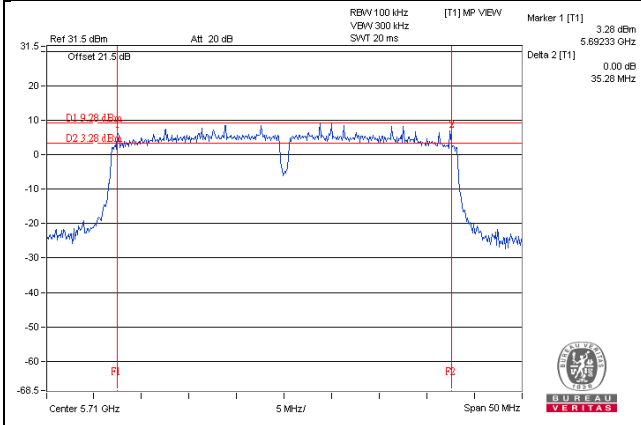

802.11ac (VHT80) / CH138 (U-NII-3)

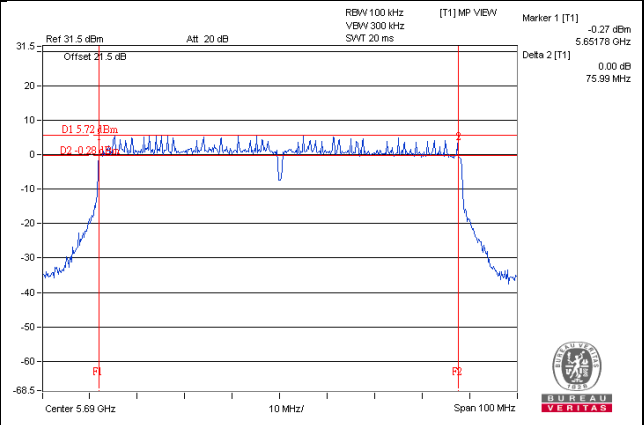

Note: The 6dB bandwidth above 5725MHz = Marker 1 + Delta 2 - 5725MHz

5 Pictures of Test Arrangements

Please refer to the attached file (Test Setup Photo).

Appendix – Information on the Testing Laboratories

We, Bureau Veritas Consumer Products Services (H.K.) Ltd., Taoyuan Branch, were founded in 1988 to provide our best service in EMC, Radio, Telecom and Safety consultation. Our laboratories are accredited and approved according to ISO/IEC 17025.

If you have any comments, please feel free to contact us at the following:

Linko EMC/RF Lab

Tel: 886-2-26052180

Fax: 886-2-26051924

Hsin Chu EMC/RF/Telecom Lab

Tel: 886-3-6668565

Fax: 886-3-6668323

Hwa Ya EMC/RF/Safety Lab

Tel: 886-3-3183232

Fax: 886-3-3270892

Email: service.adt@tw.bureauveritas.com

Web Site: www.bureauveritas-adt.com

The address and road map of all our labs can be found in our web site also.

--- END ---