

# FCC REPORT

**Applicant:** SHENZHEN HONESTY ELECTRONIC TECHNOLOGY CO.,LTD

**Address of Applicant:** Room6E, Douhui Electronic City Building A, Zhonghang Road, Futian District, Shenzhen, China

## Equipment Under Test (EUT)

Product Name: Mobile Phone

Model No.: S19, HQ6500

**FCC ID:** 2ACIC-HQ6500

**Applicable standards:** FCC CFR Title 47 Part 2  
FCC CFR Title 47 Part22 Subpart H  
FCC CFR Title 47 Part24 Subpart E

**Date of sample receipt:** 23 Jun. 2014

**Date of Test:** 24 Jun. to 14 Jul., 2014

**Date of report issued:** 15 Jul., 2014

**Test Result:** PASS \*

\* In the configuration tested, the EUT complied with the standards specified above.

Authorized Signature:



Bruce Zhang  
Laboratory Manager

This report details the results of the testing carried out on one sample. The results contained in this test report do not relate to other samples of the same product and does not permit the use of the CCIS product certification mark. The manufacturer should ensure that all products in series production are in conformity with the product sample detailed in this report.

This report may only be reproduced and distributed in full. If the product in this report is used in any configuration other than that detailed in the report, the manufacturer must ensure the new system complies with all relevant standards.

This document cannot be reproduced except in full, without prior written approval of the Company. Any unauthorized alteration, forgery or falsification of the content or appearance of this document is unlawful and offenders may be prosecuted to the fullest extent of the law. Unless otherwise stated the results shown in this test report refer only to the sample(s) tested and such sample(s) are retained for 90 days only.

## 2. Version

Version No.	Date	Description
00	15 Jul., 2014	Original

**Prepared by:** Luna Gao **Date:** 15 Jul., 2014  
**Report Clerk**

**Reviewed by:** Abomb Yang **Date:** 15 Jul., 2014  
**Project Engineer**

## 3. Contents

	Page
<b>1. COVER PAGE</b> .....	<b>1</b>
<b>2. VERSION</b> .....	<b>2</b>
<b>3. CONTENTS</b> .....	<b>3</b>
<b>4. TEST SUMMARY</b> .....	<b>4</b>
<b>5. GENERAL INFORMATION</b> .....	<b>5</b>
5.1 CLIENT INFORMATION.....	5
5.2 GENERAL DESCRIPTION OF E.U.T.....	5
5.3 TEST MODES.....	8
5.4 RELATED SUBMITTAL(S) / GRANT (S).....	8
5.5 TEST METHODOLOGY.....	8
5.6 LABORATORY FACILITY.....	8
5.7 LABORATORY LOCATION.....	8
5.8 TEST INSTRUMENTS LIST.....	9
<b>6. SYSTEM TEST CONFIGURATION</b> .....	<b>10</b>
6.1 EUT CONFIGURATION.....	10
6.2 EUT EXERCISE.....	10
6.3 CONFIGURATION OF TESTED SYSTEM.....	10
6.4 DESCRIPTION OF TEST MODES.....	10
6.5 CONDUCTED OUTPUT POWER.....	11
6.6 OCCUPY BANDWIDTH.....	15
6.7 MODULATION CHARACTERISTIC.....	25
6.8 OUT OF BAND EMISSION AT ANTENNA TERMINALS.....	25
6.9 ERP, EIRP MEASUREMENT.....	36
6.10 FIELD STRENGTH OF SPURIOUS RADIATION MEASUREMENT.....	39
6.11 FREQUENCY STABILITY V.S. TEMPERATURE MEASUREMENT.....	48
6.12 FREQUENCY STABILITY V.S. VOLTAGE MEASUREMENT.....	51
<b>7 TEST SETUP PHOTO</b> .....	<b>53</b>
<b>8 EUT CONSTRUCTIONAL DETAILS</b> .....	<b>54</b>

## 4. Test Summary

Test Item	Section in CFR 47	Result
RF Exposure (SAR)	Part 1.1307 Part 2.1093	Passed* (Please refer to SAR Report)
RF Output Power	Part 2.1046 Part 22.913 (a)(2) Part 24.232 (c)	Pass
Modulation Characteristics	Part 2.1047	Pass
99% & -26 dB Occupied Bandwidth	Part 2.1049 Part 22.917 Part 24.238	Pass
Spurious Emissions at Antenna Terminal	Part 2.1051 Part 22.917 (a) Part 24.238 (a)	Pass
Field Strength of Spurious Radiation	Part 2.1053 Part 22.917 (a) Part 24.238 (a)	Pass
Out of band emission, Band Edge	Part 22.917 (a) Part 24.238 (a)	Pass
Frequency stability vs. temperature	Part 2.1055(a)(1)(b)	Pass
Frequency stability vs. voltage	Part 2.1055(d)(1)(2)	Pass

*Pass: The EUT complies with the essential requirements in the standard.*

## 5. General Information

### 5.1 Client Information

Applicant:	SHENZHEN HONESTY ELECTRONIC TECHNOLOGY CO., LTD
Address of Applicant:	Room6E, Douhui Electronic City Building A, Zhonghang Road, Futian District, Shenzhen, China
Manufacturer :	SHENZHEN HONESTY ELECTRONIC TECHNOLOGY CO., LTD
Address of Manufacturer:	Room6E, Douhui Electronic City Building A, Zhonghang Road, Futian District, Shenzhen, China

### 5.2 General Description of E.U.T.

Product Name:	Mobile Phone
Model No.:	S19, HQ6500
Hardware Version:	E2106_V1.10
Software Version	106_v89_gp3010hd_op
Operation Frequency range:	GSM 850: 824.20MHz-848.80MHz PCS1900: 1850.20MHz-1909.80MHz WCDMA Band V:826.4MHz-846.6MHz WCDMA Band II:1852.4 MHz -1907.6 MHz
Modulation type:	GSM/GPRS:GMSK, UMTS:QPSK
Antenna type:	Internal Antenna
Antenna gain:	GSM 850: 0.22 dBi PCS 1900: 1.87 dBi WCDMA 850 : 0.22 dBi WCDMA1900 : 1.87 dBi
AC adapter:	MODEL:C14500 Input: AC 100-240V 50/60Hz 0.15A Output: DC 5V, 700mA
Power supply:	Rechargeable Li-ion Battery DC3.7V-3800mAh
Remark:	The model: S19, HQ6500 were identical inside, the electrical circuit design, components used and internal wiring, with only difference being model name, ID and mechanical components.

**Operation Frequency List:**

GSM 850		PCS1900	
Channel:	Frequency (MHz)	Channel:	Frequency (MHz)
128	824.20	512	1850.20
129	824.40	513	1850.40
....	....	....	....
189	836.40	660	1879.80
190	836.60	661	1880.00
191	836.80	662	1880.20
...	...	...	...
250	848.60	809	1909.60
251	848.80	810	1909.80
WCDMA Band V		WCDMA Band II	
Channel:	Frequency (MHz)	Channel:	Frequency (MHz)
4132	826.40	9262	1852.40
4133	826.60	9263	1852.60
....	....	....	....
4182	836.40	9399	1879.80
4183	836.60	9400	1880.00
4184	836.80	9401	1880.20
...	...	...	...
4232	846.40	9537	1907.40
4233	846.60	9538	1907.60

Regards to the operating frequency range over 10 MHz, the Lowest frequency, the middle frequency, and the highest frequency of channel were selected to perform the test, and the selected channel see below:

GSM850			PCS1900		
	Channel	Frequency(MHz)		Channel	Frequency(MHz)
Lowest channel	128	824.20	Lowest channel	512	1850.20
Middle channel	190	836.60	Middle channel	661	1880.00
Highest channel	251	848.80	Highest channel	810	1909.80
WCDMA Band V			WCDMA Band II		
	Channel	Frequency(MHz)		Channel	Frequency(MHz)
Lowest channel	4132	826.40	Lowest channel	9262	1852.40
Middle channel	4183	836.60	Middle channel	9400	1880.00
Highest channel	4233	846.60	Highest channel	9538	1907.60

## 5.3 Test modes

Communicate mode (GSM850)	Keep the EUT in communicating mode on GSM 850 band.
Data mode (GPRS850)	Keep the EUT in data communicating mode on GPRS 850 band.
Communicate mode (PCS1900)	Keep the EUT in communicating mode on PCS1900 band.
Data mode (GPRS1900)	Keep the EUT in data communicating mode on GPRS1900 band.
Communicate mode (UMTS 850)	Keep the EUT in communicating mode on UMTS 850 band.
Communicate mode (UMTS 1900)	Keep the EUT in communicating mode on UMTS 1900 band.
Data mode (RMC UMTS 850)	Keep the EUT in data communicating mode on RMC in UMTS 850 (12.2 kbps, 64 kbps, 144 kbps & 384 kbps).
Data mode (HSDPA UMTS 850)	Keep the EUT in data communicating mode on HSDPA in UMTS 850(Sub-test 1~Sub-test 4).
Data mode (HSUPA UMTS 850)	Keep the EUT in data communicating mode on HSUPA in UMTS 850(Sub-test 1~Sub-test 5).
Data mode (RMC UMTS 1900)	Keep the EUT in data communicating mode on RMC in UMTS 850 (12.2 kbps, 64 kbps, 144 kbps & 384 kbps).
Data mode (HSDPA UMTS 1900)	Keep the EUT in data communicating mode on HSDPA in UMTS 1900. (Sub-test 1~Sub-test 4).
Data mode (HSUPA UMTS 1900)	Keep the EUT in data communicating mode on HSUPA in UMTS 1900. (Sub-test 1~Sub-test 5).
Remark :	Pre-test output power of all modes, and found GSM 850, PCS 1900, UMTS 850 12.2 kbps RMC & UMTS 1900 12.2 kbps RMC were the worst case. The details please refer to section 6.5.

## 5.4 Related Submittal(s) / Grant (s)

This submittal(s) (test report) is filing to comply with Section Part 22 subpart H and Part 24 subpart E of the FCC CFR 47 Rules.

## 5.5 Test Methodology

Both conducted and radiated testing were performed according to the procedures document on TIA/EIA 603 and FCC CFR 47.1046, 2.1047, 2.1049, 2.1051, 2.1053, 2.1055 and 2.1057

## 5.6 Laboratory Facility

The test facility is recognized, certified, or accredited by the following organizations:

● **FCC - Registration No.: 817957**

Shenzhen Zhongjian Nanfang Testing Co., Ltd. EMC Laboratory has been registered and fully described in a report filed with the (FCC) Federal Communications Commission. The acceptance letter from the FCC is maintained in out files. Registration 817957, February 27, 2012.

● **IC - Registration No.: 10106A-1**

The 3m Semi-anechoic chamber of Shenzhen Zhongjian Nanfang Testing Co., Ltd. has been Registered by Certification and Engineering Bureau of Industry Canada for radio equipment testing with Registration No.: 10106A-1.

● **CNAS - Registration No.: CNAS L6048**

Shenzhen Zhongjian Nanfang Testing Co., Ltd. is accredited to ISO/IEC 17025:2005 General Requirements for the Competence of Testing and Calibration laboratories for the competence of testing. The Registration No. is CNAS L6048.

## 5.7 Laboratory Location

Shenzhen Zhongjian Nanfang Testing Co., Ltd.  
 Address: No.B-C, 1/F., Building 2, Laodong No.2 Industrial Park, Xixiang Road,  
 Bao'an District, Shenzhen, Guangdong, China  
 Tel: +86-755-23118282  
 Fax: +86-755-23116366



## 5.8 Test Instruments list

Radiated Emission:						
Item	Test Equipment	Manufacturer	Model No.	Inventory No.	Cal. Date (mm-dd-yy)	Cal. Due date (mm-dd-yy)
1	3m Semi- Anechoic Chamber	SAEMC	9(L)*6(W)* 6(H)	CCIS0001	July 09 2014	July 08 2015
2	BiConiLog Antenna	SCHWARZBECK MESS-ELEKTRONIK	VULB9163	CCIS0005	July 04 2014	July 03 2015
3	Double -ridged waveguide horn	SCHWARZBECK MESS-ELEKTRONIK	BBHA9120D	CCIS0006	June 30 2014	June 29 2015
4	EMI Test Software	AUDIX	E3	N/A	N/A	N/A
5	Coaxial Cable	CCIS	N/A	CCIS0016	Apr. 01 2014	Mar. 31 2015
6	Coaxial Cable	CCIS	N/A	CCIS0017	Apr. 01 2014	Mar. 31 2015
7	Coaxial cable	CCIS	N/A	CCIS0018	Apr. 01 2014	Mar. 31 2015
8	Coaxial Cable	CCIS	N/A	CCIS0019	Apr. 01 2014	Mar. 31 2015
9	Coaxial Cable	CCIS	N/A	CCIS0087	Apr. 01 2014	Mar. 31 2015
10	Amplifier(10kHz-1.3GHz)	HP	8447D	CCIS0003	Apr. 01 2014	Mar. 31 2015
11	Amplifier(1GHz-18GHz)	Compliance Direction Systems Inc.	PAP-1G18	CCIS0011	July 09 2014	July 08 2015
12	Pre-amplifier (18-26GHz)	Rohde & Schwarz	AFS33-18002 650-30-8P-44	GTS218	Apr. 01 2014	Mar. 31 2015
13	Horn Antenna	ETS-LINDGREN	3160	GTS217	Mar. 30 2014	Mar. 29 2015
14	Printer	HP	HP LaserJet P1007	N/A	N/A	N/A
15	Positioning Controller	UC	UC3000	CCIS0015	N/A	N/A
16	Spectrum analyzer 9k-30GHz	Rohde & Schwarz	FSP	CCIS0023	June. 29 2014	June. 28 2015
17	EMI Test Receiver	Rohde & Schwarz	ESPI	CCIS0022	Apr 01 2014	Mar. 31 2015
18	Loop antenna	Laplace instrument	RF300	EMC0701	Aug. 12 2013	Aug. 11 2014
19	Universal radio communication tester	Rhode & Schwarz	CMU200	CCIS0069	June. 29 2014	June. 28 2015
20	Signal Analyzer	Rohde & Schwarz	FSIQ3	CCIS0088	June. 29 2014	June. 28 2015

## 6. System test configuration

### 6.1 EUT Configuration

The EUT configuration for testing is installed on RF field strength measurement to meet the commission's requirement and operating in a manner which intends to maximize its emission characteristics in a continuous normal application.

### 6.2 EUT Exercise

The EUT (Transmitter) was operated in the engineering mode to fix the Tx frequency which was for the purpose of the measurements.

### 6.3 Configuration of Tested System

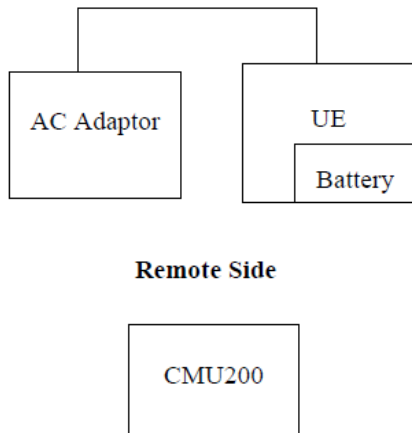

### 6.4 Description of Test Modes

The EUT has been tested under operating condition.  
 EUT staying in continuous transmitting mode. Channel Low, Mid and High for each type band with rated data rate were chosen for full testing.  
 The field strength of spurious radiation emission was measured as EUT stand-up position (H mode) and lie down position (E1, E2 mode) for three modes (GSM850, PCS1900, WCDMA Band V and WCDMA Band II) with power adaptor, earphone and Data cable. The worst-case H mode for GSM850, PCS1900, UMTS 850 and UMTS 1900.

## 6.5 Conducted Output Power

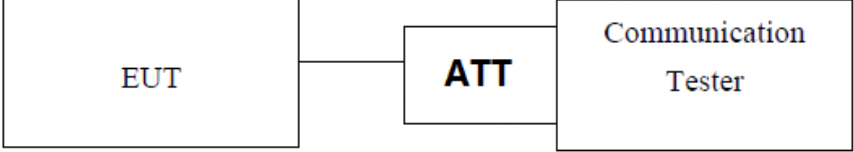
Test Requirement:	FCC part 22.913(a) and FCC part 24.232(b)
Test Method:	FCC part 2.1046
Limit:	GSM 850 7W PCS 1900 2W WCDMA Band V: 7W WCDMA Band II: 2W
Test setup:	 <p style="text-align: center;"><i>Note: Measurement setup for testing on Antenna connector</i></p>
Test Procedure:	The transmitter output was connected to a calibrated attenuator, the other end of which was connected to the CMU200. Transmitter output power was read off in dBm.
Test Instruments:	Refer to section 5.8 for details
Test mode:	Refer to section 5.3 for details
Test results:	Passed

### Measurement Data

EUT Mode	Channel	Frequency (MHz)	Burst Average power (dBm)	Limit(dBm)	Result
GSM 850	128	824.20	32.76	38.45	Pass
	190	836.60	32.61		
	251	848.80	32.75		
GPRS 850 (1 Uplink slot)	128	824.20	32.74		
	190	836.60	32.60		
	251	848.80	32.73		
GPRS 850 (2 Uplink slots)	128	824.20	31.82		
	190	836.60	31.65		
	251	848.80	31.83		
GPRS 850 (3 Uplink slots)	128	824.20	30.10		
	190	836.60	29.96		
	251	848.80	30.10		
GPRS 850 (4 Uplink slots)	128	824.20	29.28		
	190	836.60	29.10		
	251	848.80	29.26		

EUT Mode	Channel	Frequency (MHz)	Burst Average power (dBm)	Limit(dBm)	Result
PCS 1900	512	1850.20	29.02	33.00	Pass
	661	1880.00	29.21		
	810	1909.80	29.35		
GPRS 1900 (1 Uplink slot)	512	1850.20	29.02		
	661	1880.00	29.19		
	810	1909.80	29.35		
GPRS 1900 (2 Uplink slots)	512	1850.20	28.05		
	661	1880.00	28.30		
	810	1909.80	28.51		
GPRS 1900 (3 Uplink slots)	512	1850.20	26.36		
	661	1880.00	26.74		
	810	1909.80	26.97		
GPRS 1900 (4 Uplink slots)	512	1850.20	25.51		
	661	1880.00	25.85		
	810	1909.80	26.14		

EUT Mode		Channel	Frequency (MHz)	Burst Average power (dBm)	Limit(dBm)	Result
UMTS 850 HSDPA	Subtest 1	4132	826.40	22.31	38.45	Pass
		4183	836.00	22.26		
		4233	846.60	22.14		
	Subtest 2	4132	826.40	21.87		
		4183	836.00	21.85		
		4233	846.60	21.69		
	Subtest 3	4132	826.40	20.31		
		4183	836.00	20.24		
		4233	846.60	20.06		
	Subtest 4	4132	826.40	20.20		
		4183	836.00	20.21		
		4233	846.60	20.05		
UMTS 850 HSUPA	Subtest 1	4132	826.40	22.21		
		4183	836.00	22.17		
		4233	846.60	22.00		
	Subtest 2	4132	826.40	22.27		
		4183	836.00	22.25		
		4233	846.60	22.05		
	Subtest 3	4132	826.40	20.26		
		4183	836.00	20.27		
		4233	846.60	20.09		
	Subtest 4	4132	826.40	22.29		
		4183	836.00	22.26		
		4233	846.60	22.14		
Subtest 5	4132	826.40	21.16			
	4183	836.00	21.16			
	4233	846.60	21.19			
UMTS 850 RMC	12.2kbps	4132	826.40	23.30		
		4183	836.00	23.26		
		4233	846.60	23.13		
UMTS 850 AMR	12.2kbps	4132	826.40	23.30		
		4183	836.00	23.16		
		4233	846.60	23.12		

EUT Mode		Channel	Frequency (MHz)	Burst Average power (dBm)	Limit(dBm)	Result
UMTS1900 HSDPA	Subtest 1	9262	1852.40	21.74	33.00	Pass
		9400	1880.00	21.41		
		9538	1907.60	21.45		
	Subtest 2	9262	1852.40	21.35		
		9400	1880.00	21.03		
		9538	1907.60	20.99		
	Subtest 3	9262	1852.40	19.78		
		9400	1880.00	19.65		
		9538	1907.60	19.48		
	Subtest 4	9262	1852.40	19.76		
		9400	1880.00	19.39		
		9538	1907.60	19.26		
UMTS1900 HSUPA	Subtest 1	9262	1852.40	21.70		
		9400	1880.00	21.37		
		9538	1907.60	21.38		
	Subtest 2	9262	1852.40	21.75		
		9400	1880.00	21.41		
		9538	1907.60	21.41		
	Subtest 3	9262	1852.40	19.96		
		9400	1880.00	19.40		
		9538	1907.60	19.40		
	Subtest 4	9262	1852.40	21.78		
		9400	1880.00	21.40		
		9538	1907.60	21.47		
	Subtest 5	9262	1852.40	20.83		
		9400	1880.00	20.48		
		9538	1907.60	20.39		
UMTS1900 RMC	12.2kbps	9262	1852.40	22.75		
		9400	1880.00	22.39		
		9538	1907.60	22.41		
UMTS1900 AMR	12.2kbps	9262	1852.40	22.67		
		9400	1880.00	22.27		
		9538	1907.60	22.30		

## 6.6 Occupy Bandwidth

Test Requirement:	FCC part 22.913(a) and FCC part 24.232(b)
Test Method:	FCC part 2.1049
Test setup:	<p><i>Note: Measurement setup for testing on Antenna connector</i></p>
Test Procedure:	<ol style="list-style-type: none"> <li>1. The EUT's output RF connector was connected with a short cable to the spectrum analyzer</li> <li>2. RBW was set to about 1% of emission BW, VBW= 3 times RBW.</li> <li>3. -26dBc display line was placed on the screen (or 99% bandwidth), the occupied bandwidth is the delta frequency between the two points where the display line intersects the signal trace.</li> </ol>
Test Instruments:	Refer to section 5.8 for details
Test mode:	Refer to section 5.3 for details
Test results:	Passed

### Measurement Data

EUT Mode	Channel	Frequency (MHz)	99% Occupy bandwidth (kHz)	-26dB bandwidth (kHz)
GSM 850	128	824.2	244	326
	190	836.6	246	316
	251	848.8	250	320
PCS 1900	512	1850.2	242	320
	661	1880.0	242	316
	810	1909.8	244	316
UMTS850 12.2k RMC	4132	824.40	4160	4680
	4183	836.00	4160	4700
	4233	846.60	4180	4700
UMTS1900 12.2k RMC	9262	1852.40	4180	4740
	9400	1880.00	4180	4720
	9538	1907.60	4220	4760

Note: GSM & GPRS use the same modulation technical (GMSK), and with the same channels, so the 99% OBW and the -26dB of GPRS not performed.

Test plot as follows:



Test Item:	99% Occupy bandwidth	Test Mode:	GSM850
------------	----------------------	------------	--------

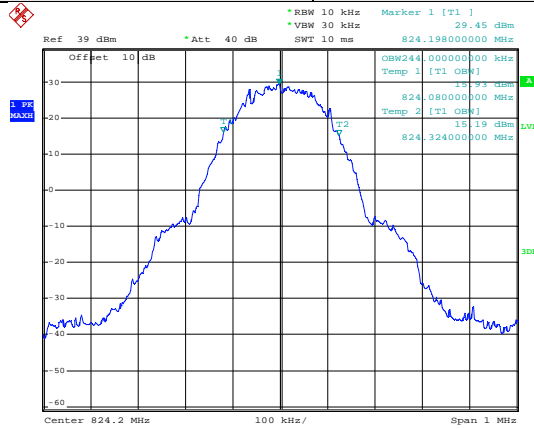

Date: 27.MAY.2014 18:32:23

### Lowest channel

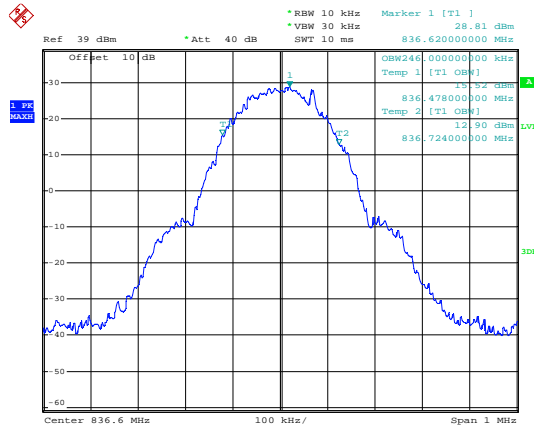

Date: 27.MAY.2014 18:33:42

### Middle channel

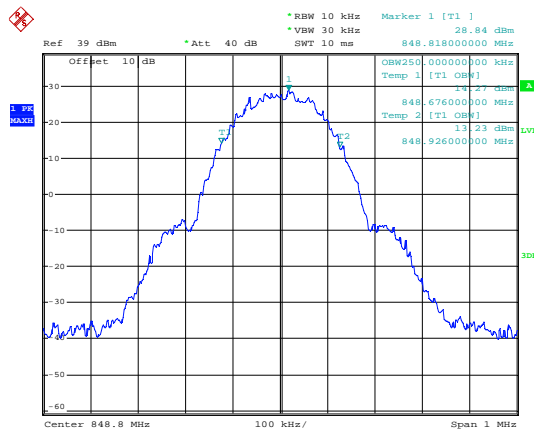

Date: 27.MAY.2014 18:34:11

### Highest channel

Test Item:	-26dB bandwidth	Test Mode:	GSM850
------------	-----------------	------------	--------

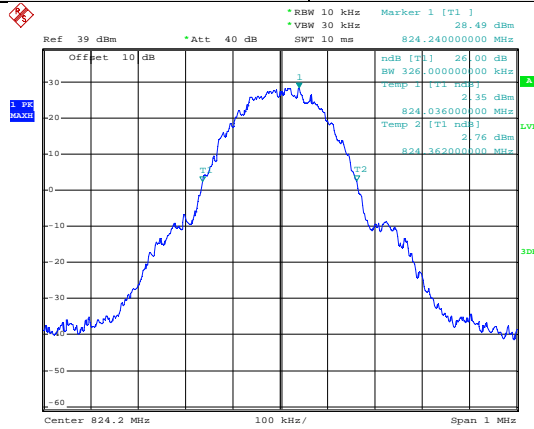

Date: 27.MAY.2014 18:32:50

### Lowest channel

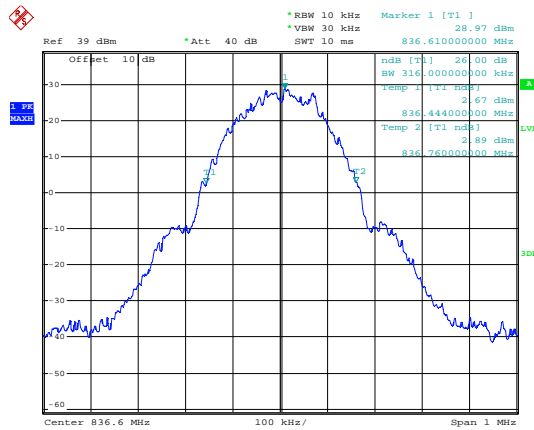

Date: 27.MAY.2014 18:33:14

### Middle channel

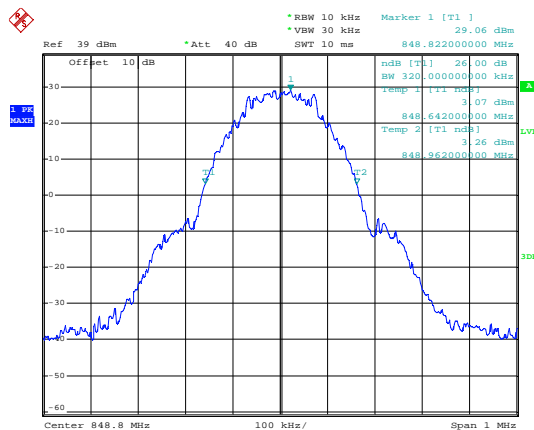

Date: 27.MAY.2014 18:34:27

### Highest channel

Test Item:	99% Occupancy bandwidth	Test Mode:	PCS 1900
------------	-------------------------	------------	----------

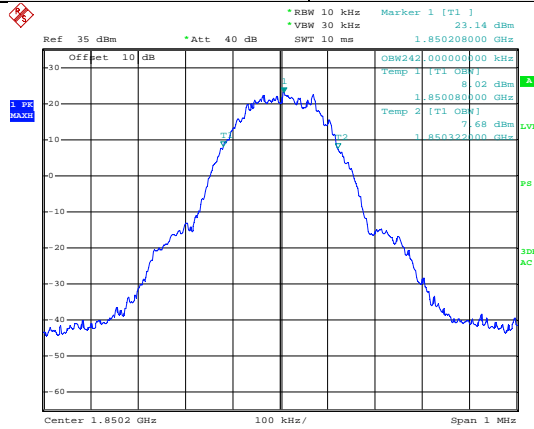

Date: 27.JUN.2014 00:40:16

### Lowest channel

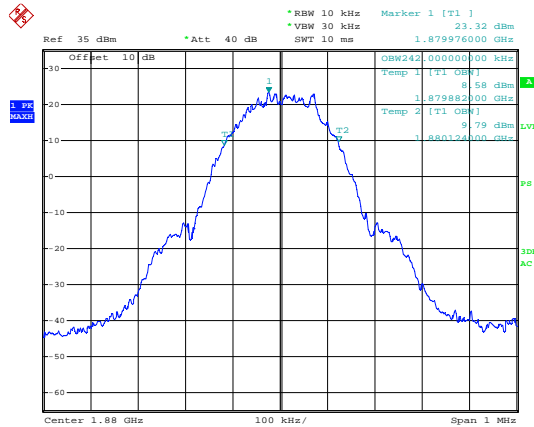

Date: 27.JUN.2014 00:40:54

### Middle channel

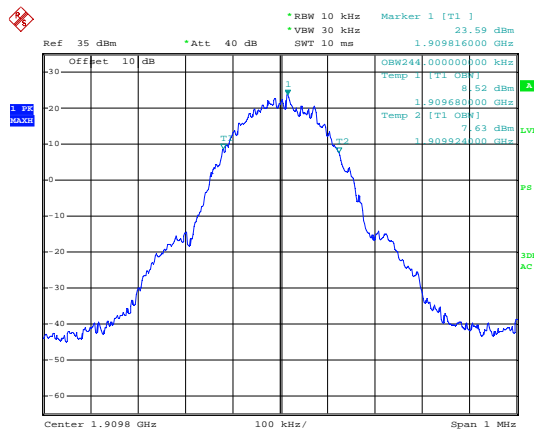

Date: 27.JUN.2014 00:41:48

### Highest channel

Test Item:	-26dB bandwidth	Test Mode:	PCS 1900
------------	-----------------	------------	----------

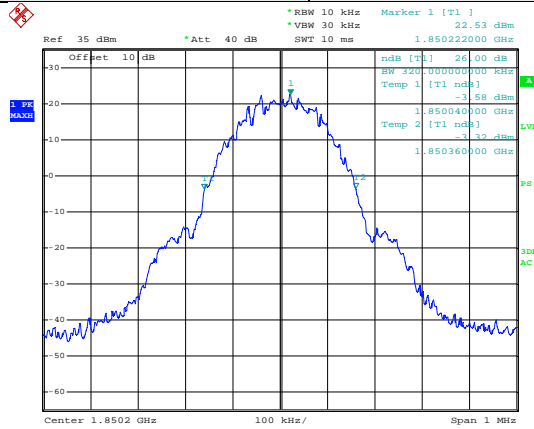

Date: 27.JUN.2014 00:43:53

### Lowest channel

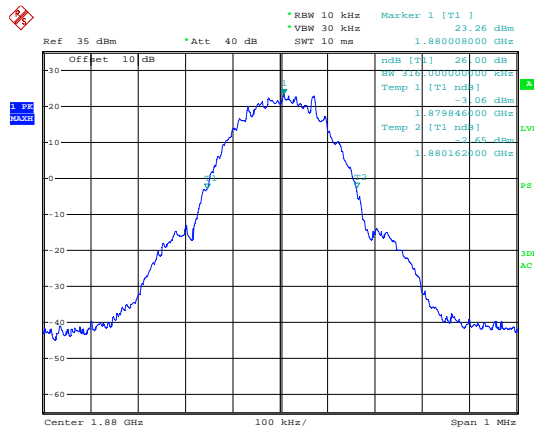

Date: 27.JUN.2014 00:43:22

### Middle channel

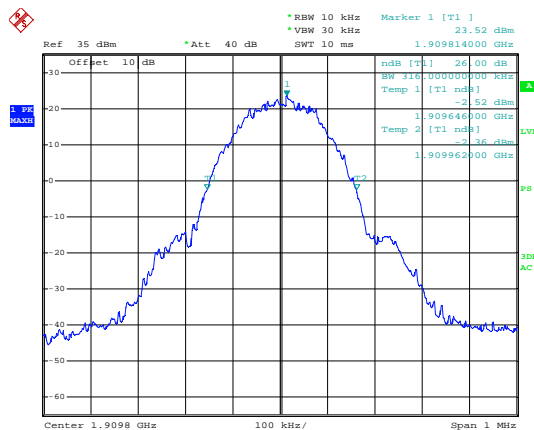

Date: 27.JUN.2014 00:42:10

### Highest channel

Test Item:	99% Occupancy bandwidth	Test Mode:	UMTS 850 12.2k RMC
------------	-------------------------	------------	--------------------

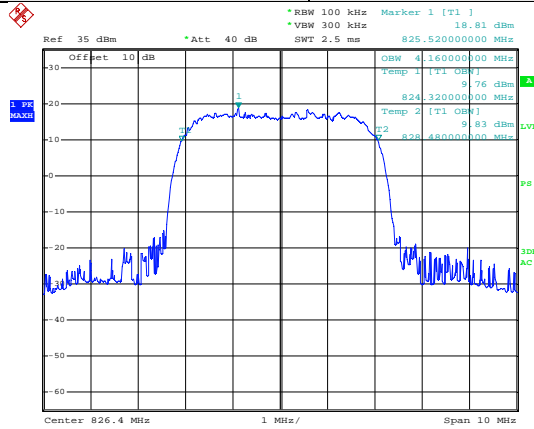

Date: 26.JUN.2014 23:49:30

### Lowest channel

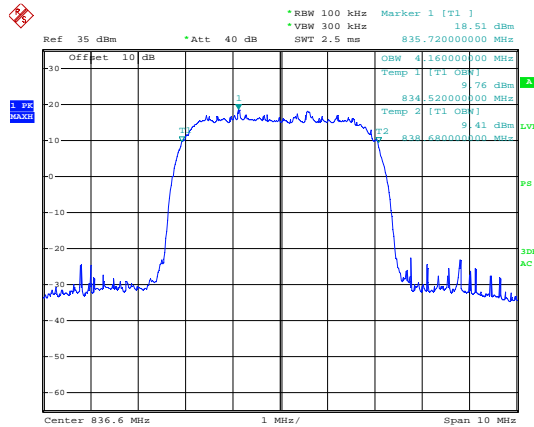

Date: 26.JUN.2014 23:50:29

### Middle channel

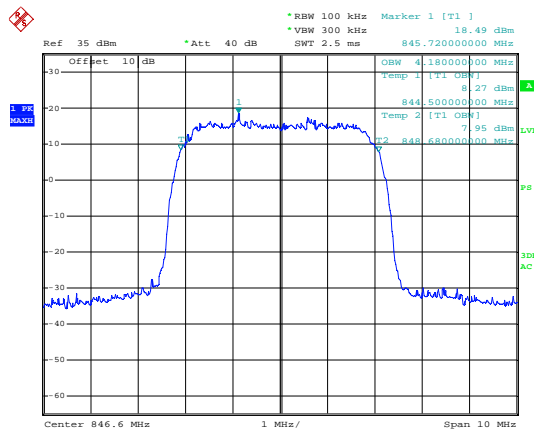

Date: 26.JUN.2014 23:51:34

### Highest channel

Test Item:	-26dB bandwidth	Test Mode:	UMTS 850 12.2k RMC
------------	-----------------	------------	--------------------

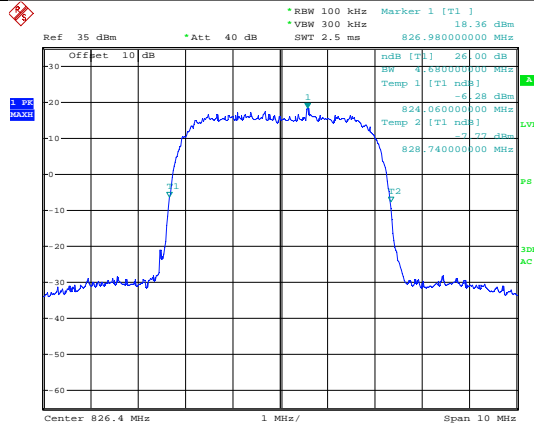

Date: 26.JUN.2014 23:53:25

### Lowest channel

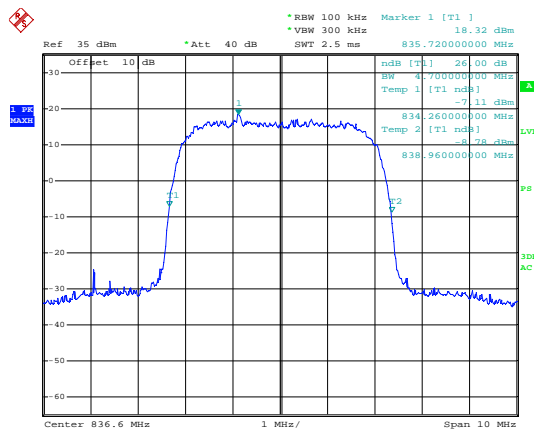

Date: 26.JUN.2014 23:52:44

### Middle channel

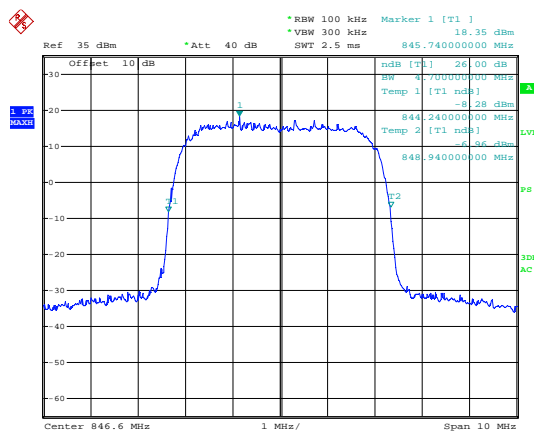

Date: 26.JUN.2014 23:51:53

### Highest channel

Test Item:	99% Occupy bandwidth	Test Mode:	UMTS 1900 12.2k RMC
------------	----------------------	------------	---------------------

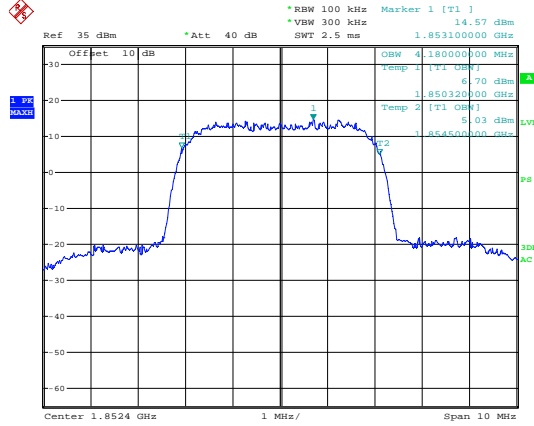

Date: 27.JUN.2014 00:11:42

### Lowest channel

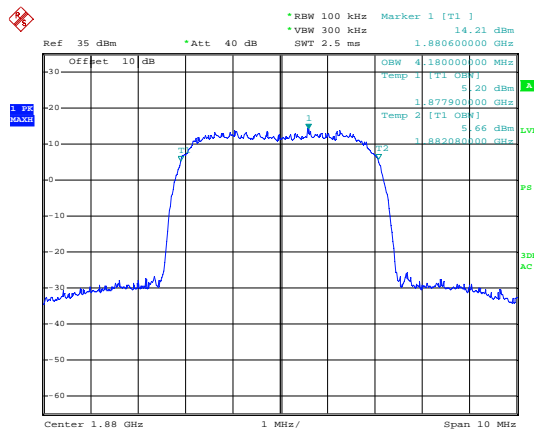

Date: 27.JUN.2014 00:12:17

### Middle channel

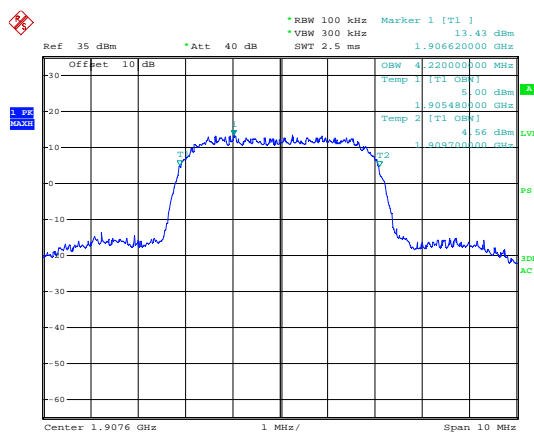

Date: 27.JUN.2014 00:12:47

### Highest channel

Test Item:	-26dB bandwidth	Test Mode:	UMTS 1900 12.2k RMC
------------	-----------------	------------	---------------------

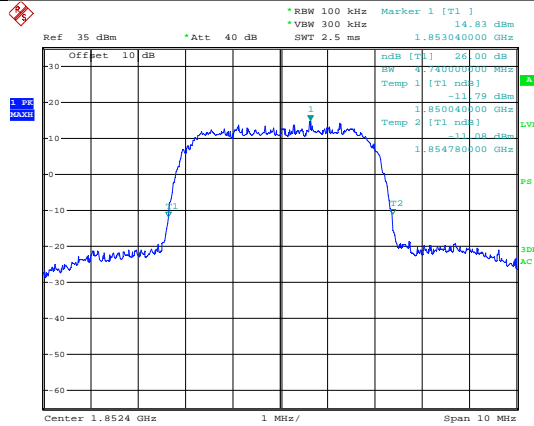

Date: 27.JUN.2014 00:14:57

### Lowest channel

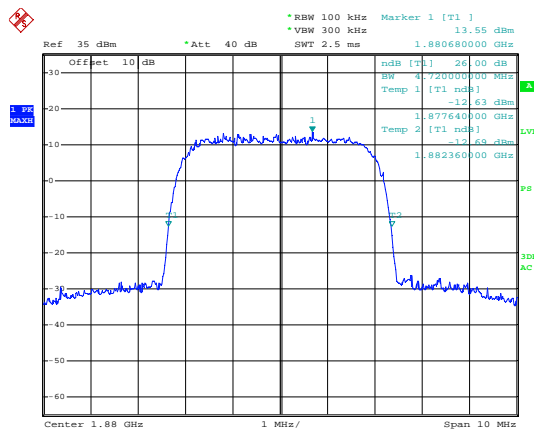

Date: 27.JUN.2014 00:13:26

### Middle channel

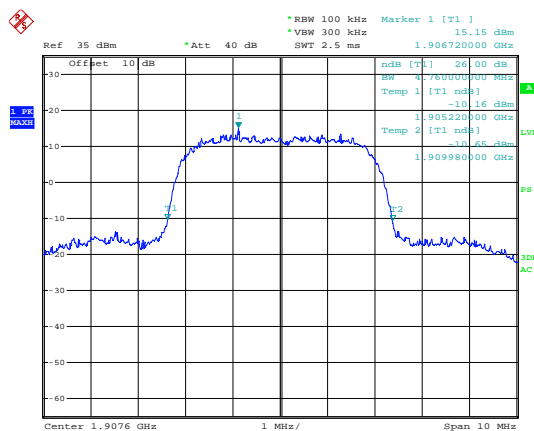

Date: 27.JUN.2014 00:13:03

### Highest channel



## 6.7 Modulation Characteristic

According to FCC § 2.1047(d), Part 22H & 24E there is no specific requirement for digital modulation, therefore modulation characteristic is not presented.

## 6.8 Out of band emission at antenna terminals

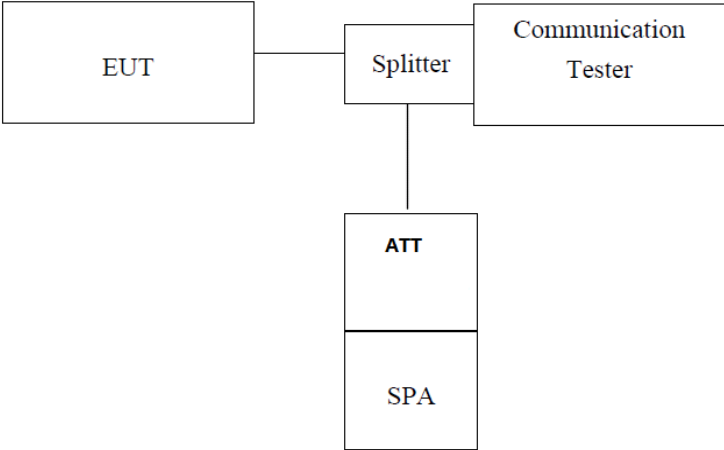
Test Requirement:	FCC part22.917(a) and FCC part24.238(a)
Test Method:	FCC part2.1051
Limit:	-13dBm
Test setup:	 <p><i>Note: Measurement setup for testing on Antenna connector</i></p>
Test Procedure:	<ol style="list-style-type: none"> <li>1 The RF output of the transceiver was connected to a spectrum analyzer through appropriate attenuation.</li> <li>2 The resolution bandwidth of the spectrum analyzer was set at 100 kHz when below 1GHz, 1MHz when above 1 GHz; sufficient scans were taken to show the out of band Emissions if any up to 10th harmonic.</li> <li>3 For the out of band: Set the RBW=100 kHz, VBW=300 kHz when below 1 GHz, RBW =1 MHz, VBW=3 MHz when above 1 GHz, Start=30MHz, Stop= 10th harmonic.</li> <li>4 Band Edge Requirements: In the 1 MHz bands immediately outside and adjacent to the frequency block, a resolution bandwidth of at least 1 percent of the emission bandwidth of the fundamental emission of the transmitter may be employed to measure the out of band Emissions.</li> </ol>
Test Instruments:	Refer to section 5.8 for details
Test mode:	Refer to section 5.3 for details
Test results:	Passed

Test plots as follows:

## Spurious emission

Test Mode:	GSM850	Test Channel:	Lowest channel
------------	--------	---------------	----------------

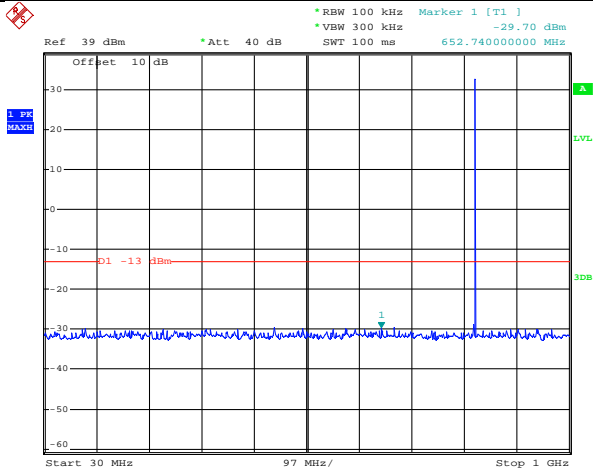

Date: 27.MAY.2014 18:36:52

30MHz~1GHz

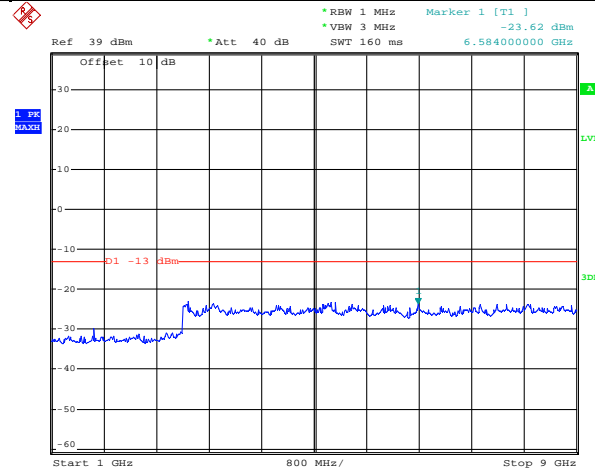

Date: 27.MAY.2014 18:37:32

1GHz~9GHz

Test Mode:	GSM850	Test Channel:	Middle channel
------------	--------	---------------	----------------

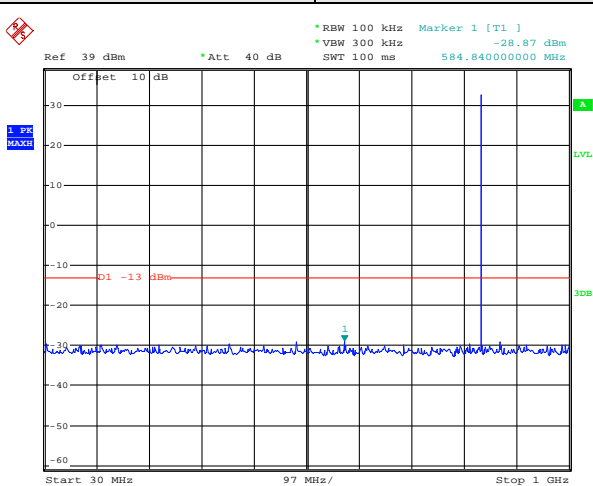

Date: 27.MAY.2014 18:36:26

30MHz~1GHz

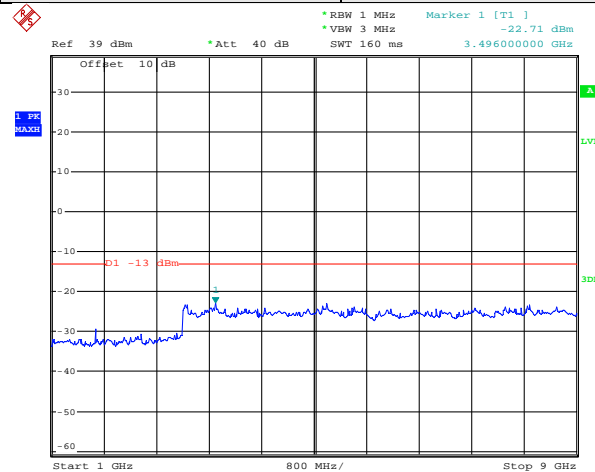

Date: 27.MAY.2014 18:38:04

1GHz~9GHz

Test Mode:	GSM850	Test Channel:	Highest channel
------------	--------	---------------	-----------------

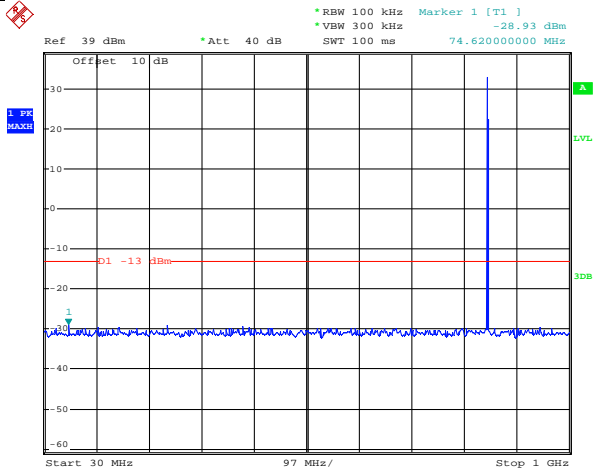

Date: 27.MAY.2014 18:35:51

30MHz~1GHz

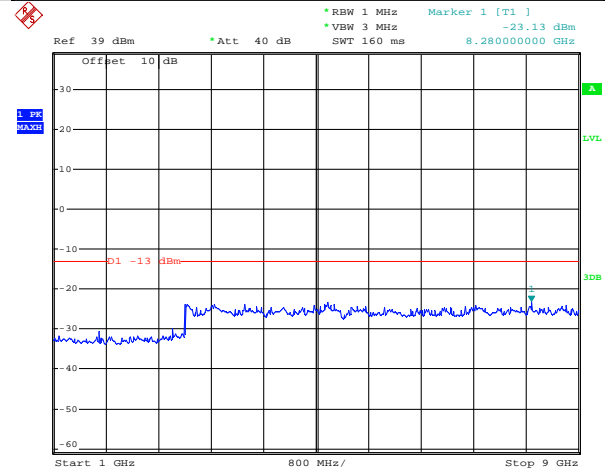

Date: 27.MAY.2014 18:38:20

1GHz~9GHz

Test Mode:	PCS1900	Test Channel:	Lowest channel
------------	---------	---------------	----------------

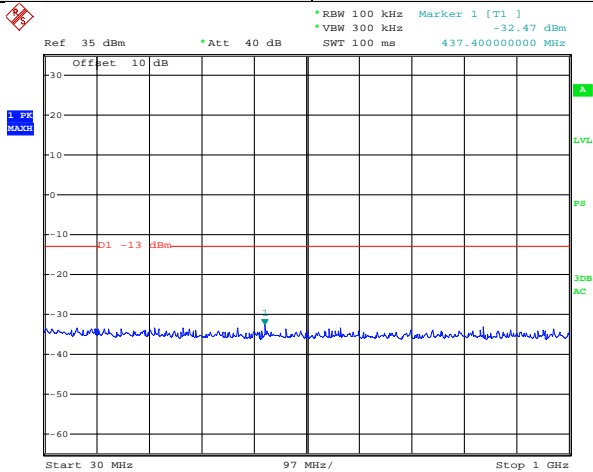

Date: 27.JUN.2014 00:45:26

30MHz~1GHz

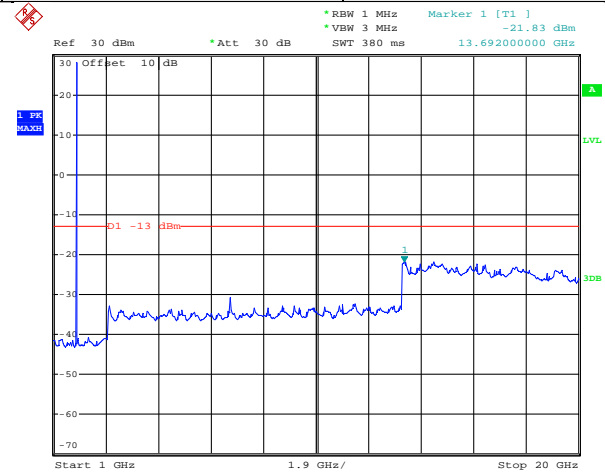

Date: 27.MAY.2014 18:50:02

1GHz~20GHz

Test Mode:	PCS1900	Test Channel:	Middle channel
------------	---------	---------------	----------------

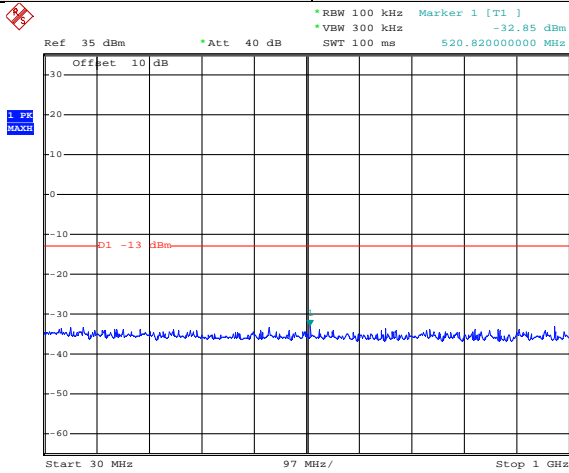

Date: 27.JUN.2014 00:45:55

30MHz~1GHz

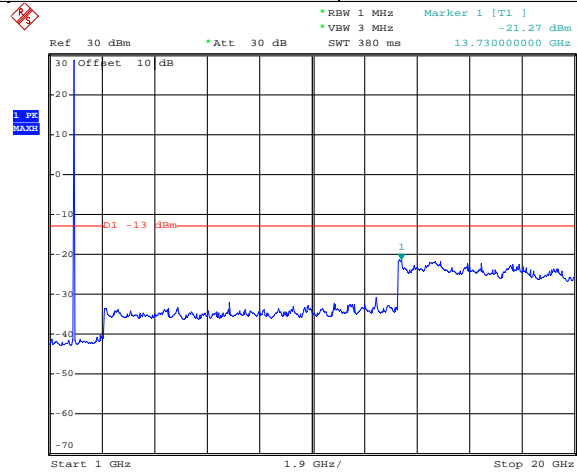

Date: 27.MAY.2014 18:50:50

1GHz~20GHz

Test Mode:	PCS1900	Test Channel:	Highest channel
------------	---------	---------------	-----------------

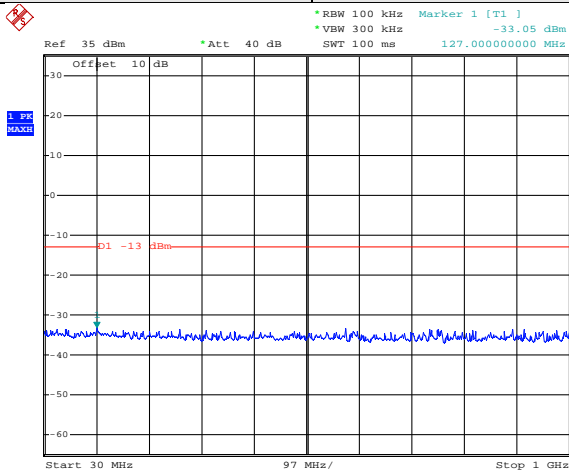

Date: 27.JUN.2014 00:46:51

30MHz~1GHz

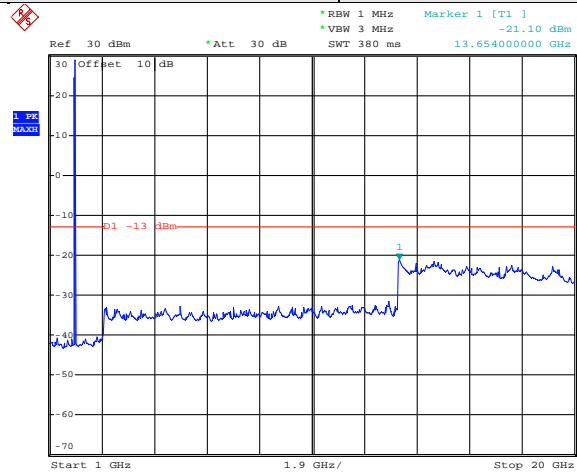

Date: 27.MAY.2014 18:51:40

1GHz~20GHz

Test Mode:	UMTS 850 12.2k RMC	Test Channel:	Lowest channel
------------	--------------------	---------------	----------------

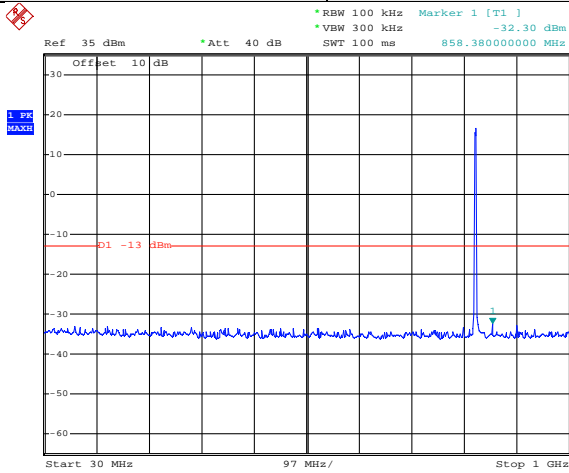

Date: 27.JUN.2014 00:07:15

30MHz~1GHz

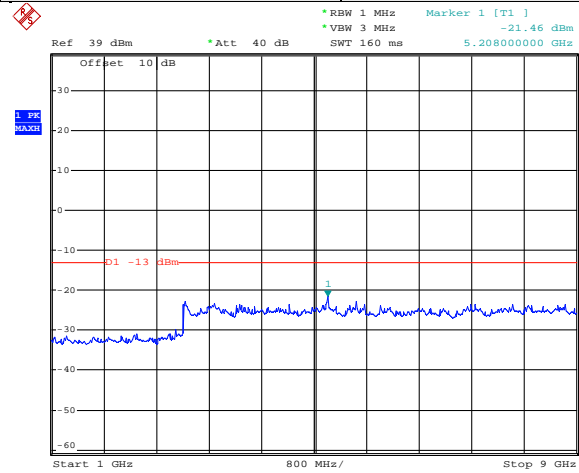

Date: 27.MAY.2014 18:40:54

1GHz~9GHz

Test Mode:	UMTS 850 12.2k RMC	Test Channel:	Middle channel
------------	--------------------	---------------	----------------

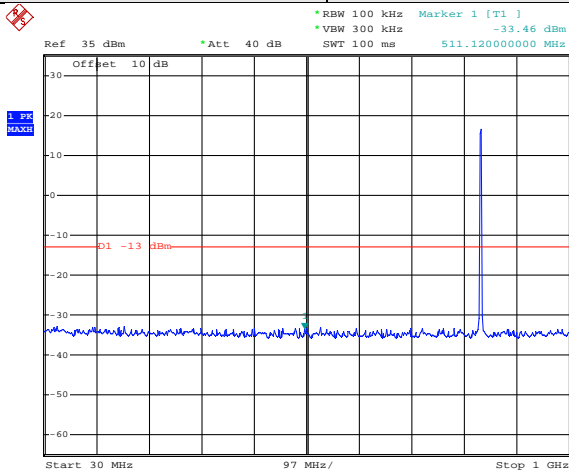

Date: 27.JUN.2014 00:09:09

30MHz~1GHz

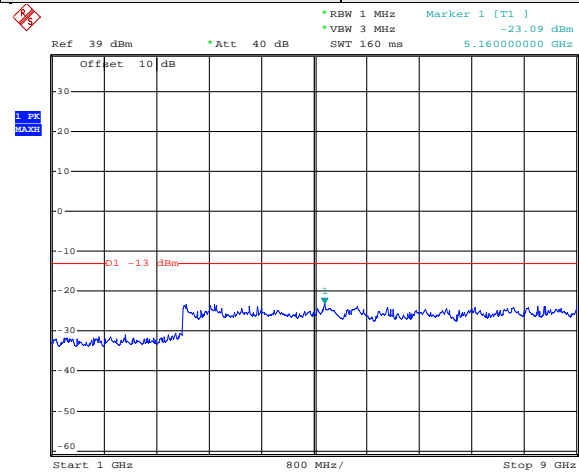

Date: 27.MAY.2014 18:41:17

1GHz~9GHz

Test Mode:	UMTS 850 12.2k RMC	Test Channel:	Highest channel
------------	--------------------	---------------	-----------------

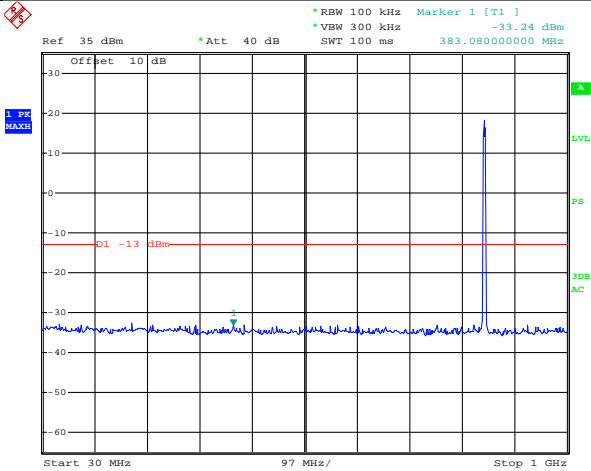

Date: 27.JUN.2014 00:03:47

30MHz~1GHz

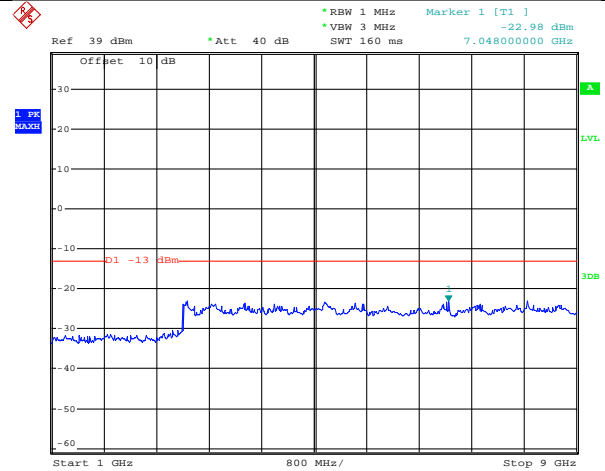

Date: 27.MAY.2014 18:41:44

1GHz~9GHz

Test Mode:	UMTS 1900 12.2k RMC	Test Channel:	Lowest channel
------------	---------------------	---------------	----------------

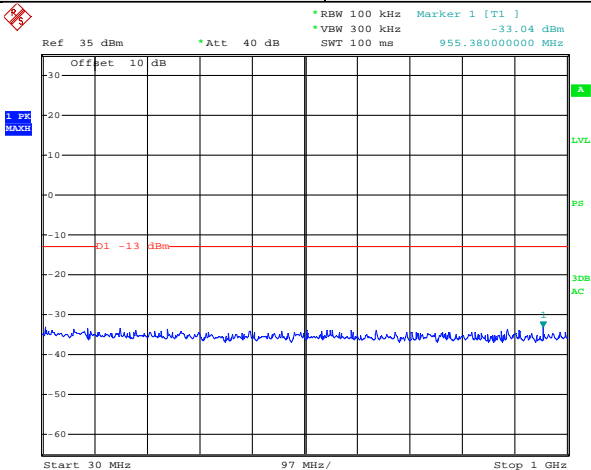

Date: 27.JUN.2014 00:25:00

30MHz~1GHz

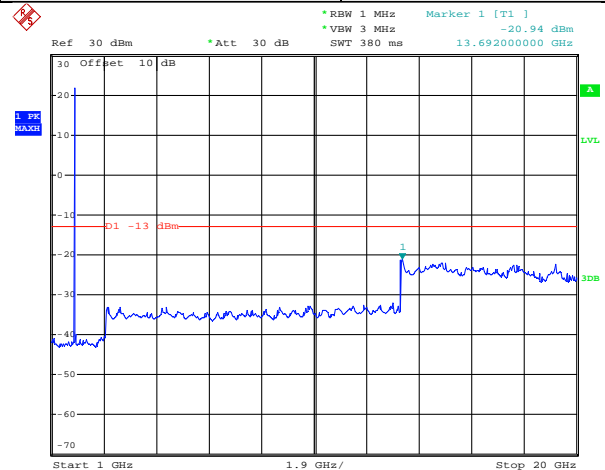

Date: 27.MAY.2014 18:44:05

1GHz~20GHz

Test Mode:	UMTS 1900 12.2k RMC	Test Channel:	Middle channel
------------	---------------------	---------------	----------------

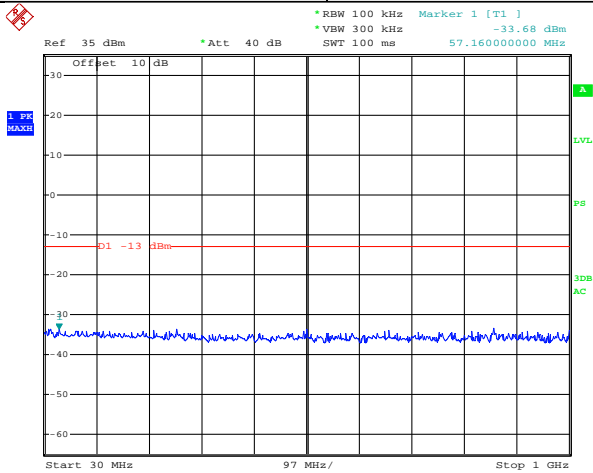

Date: 27.JUN.2014 00:24:24

30MHz~1GHz

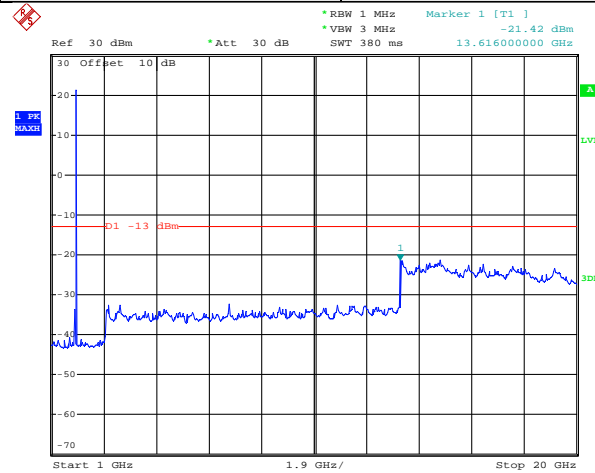

Date: 27.MAY.2014 18:44:29

1GHz~20GHz

Test Mode:	UMTS 1900 12.2k RMC	Test Channel:	Highest channel
------------	---------------------	---------------	-----------------

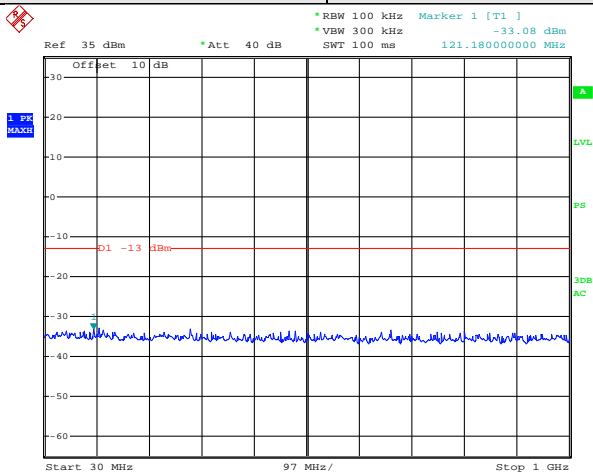

Date: 27.JUN.2014 00:23:50

30MHz~1GHz

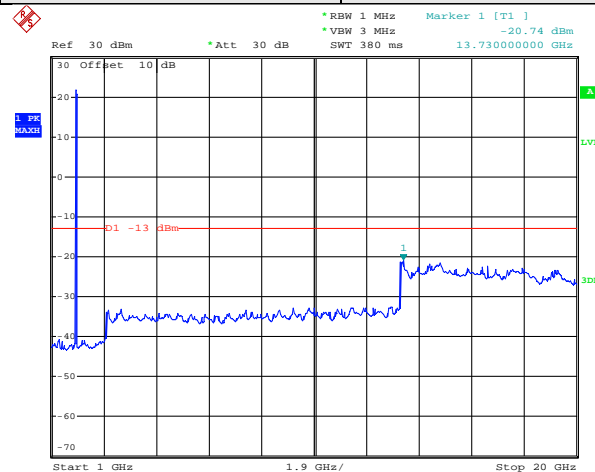

Date: 27.MAY.2014 18:45:05

1GHz~20GHz

**Band edge emission:**

Test Mode:	GSM850
------------	--------

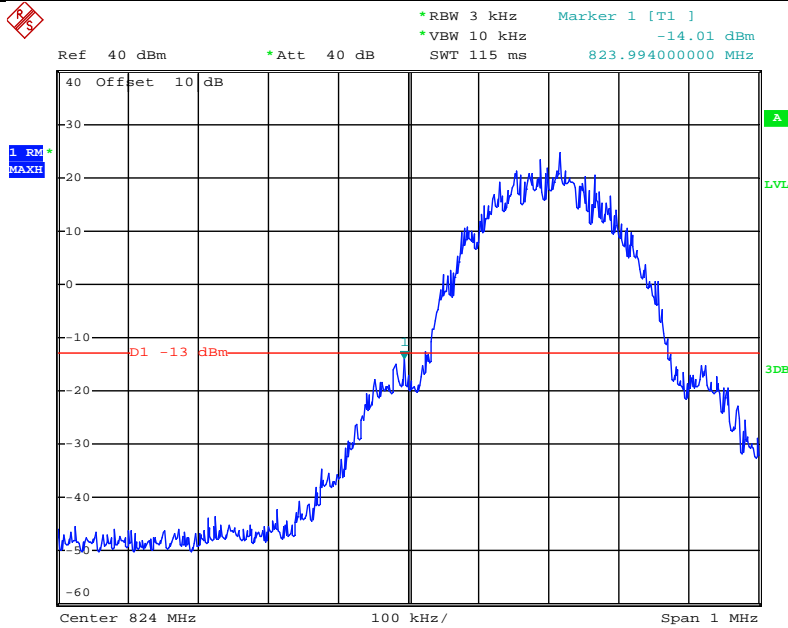

Date: 12.JUN.2014 12:59:59

**Lowest channel**

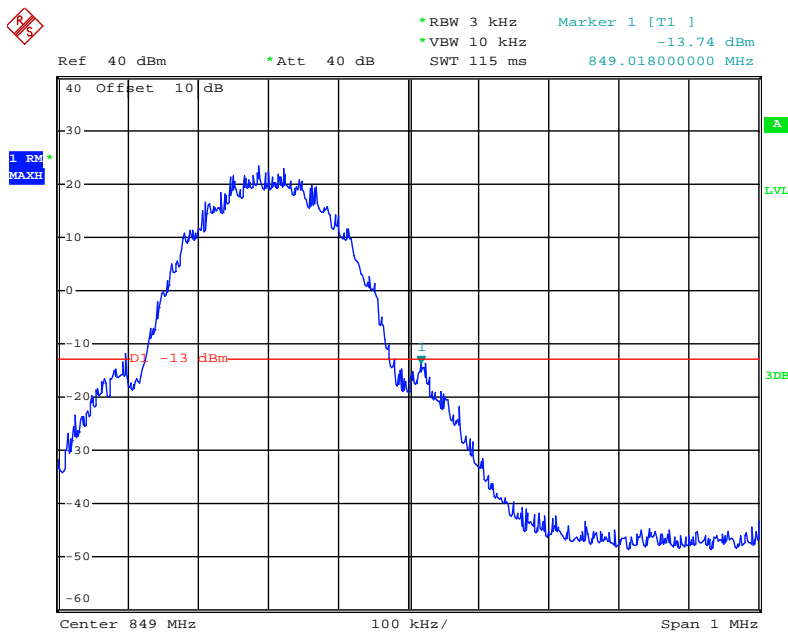

Date: 12.JUN.2014 13:00:48

**Highest channel**



Test Mode:	PCS1900
------------	---------

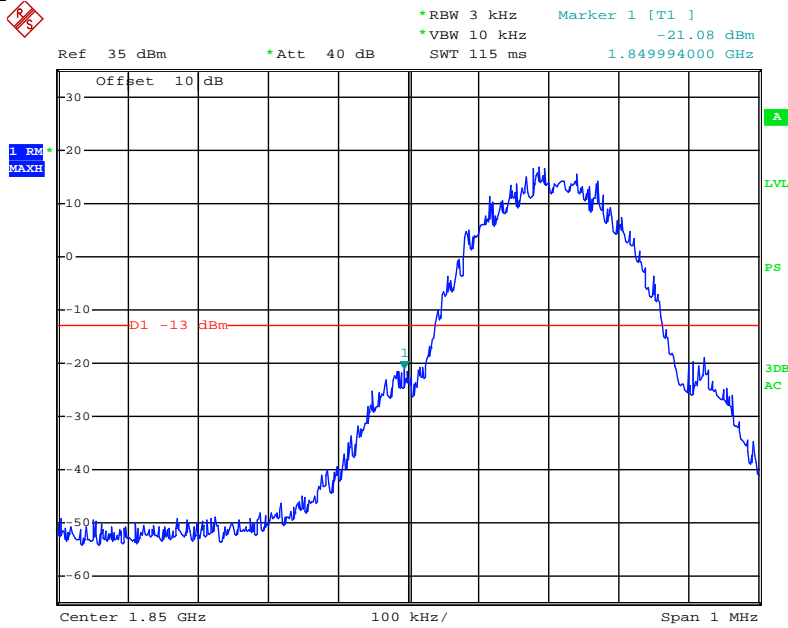

Date: 27.JUN.2014 00:37:33

### Lowest channel

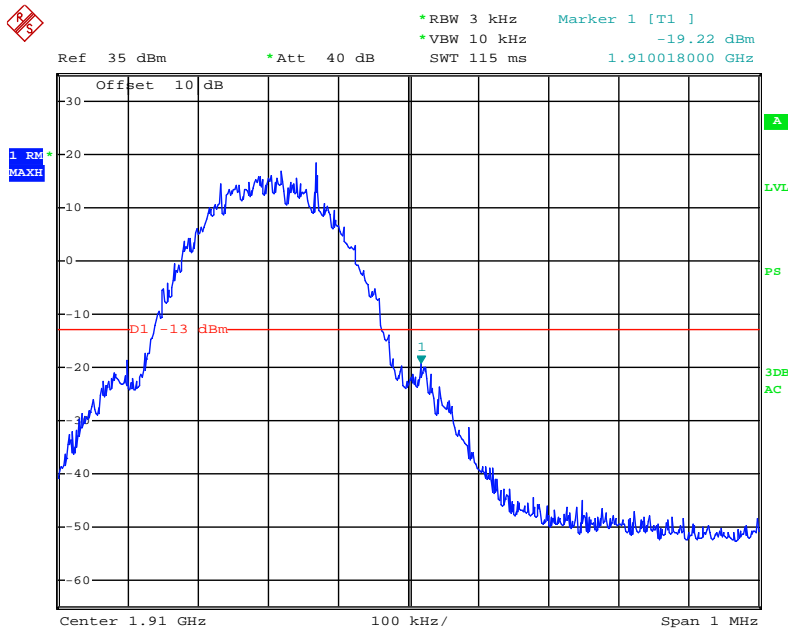

Date: 27.JUN.2014 00:38:49

### Highest channel

Test Mode:	UMTS850 12.2k RMC
------------	-------------------

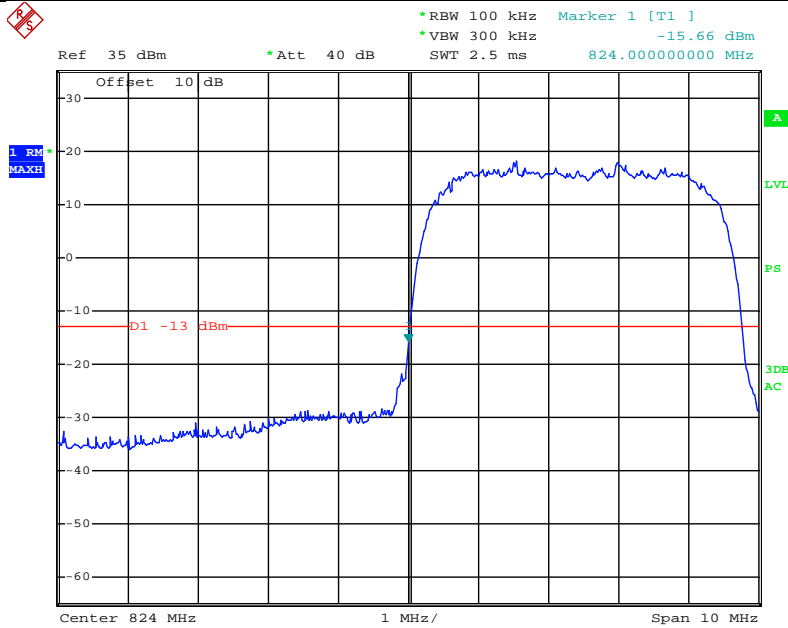

Date: 26.JUN.2014 23:58:08

### Lowest channel

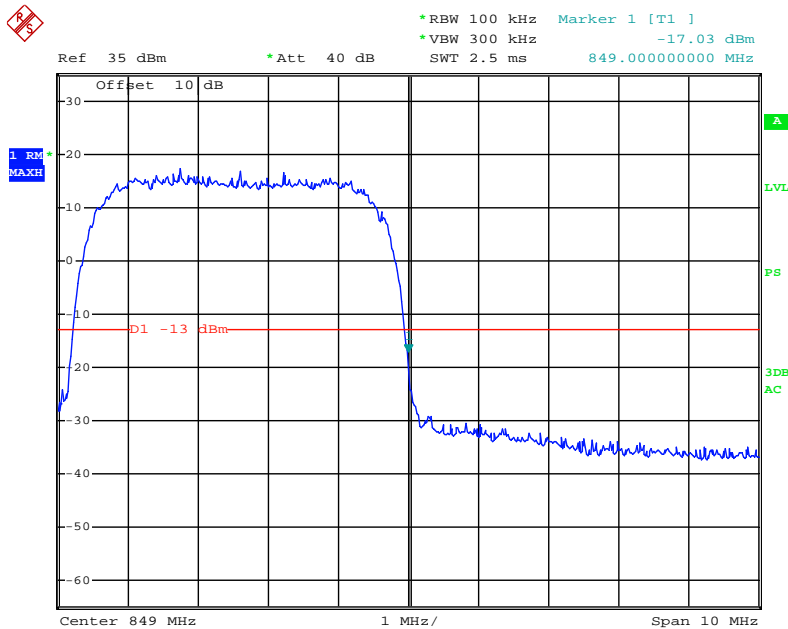

Date: 26.JUN.2014 23:59:16

### Highest channel

Test Mode:	UMTS 1900 12.2k RMC
------------	---------------------

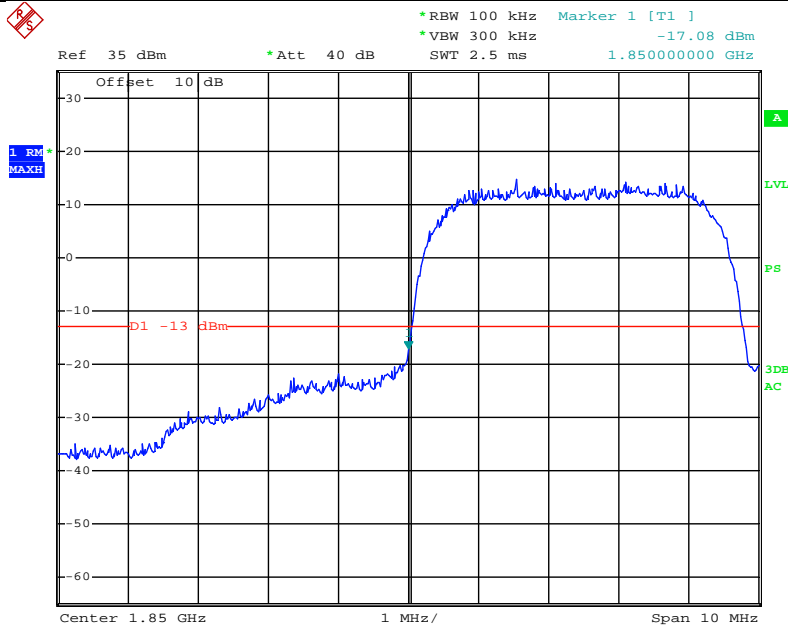

Date: 2.JUL.2014 18:09:31

### Lowest channel

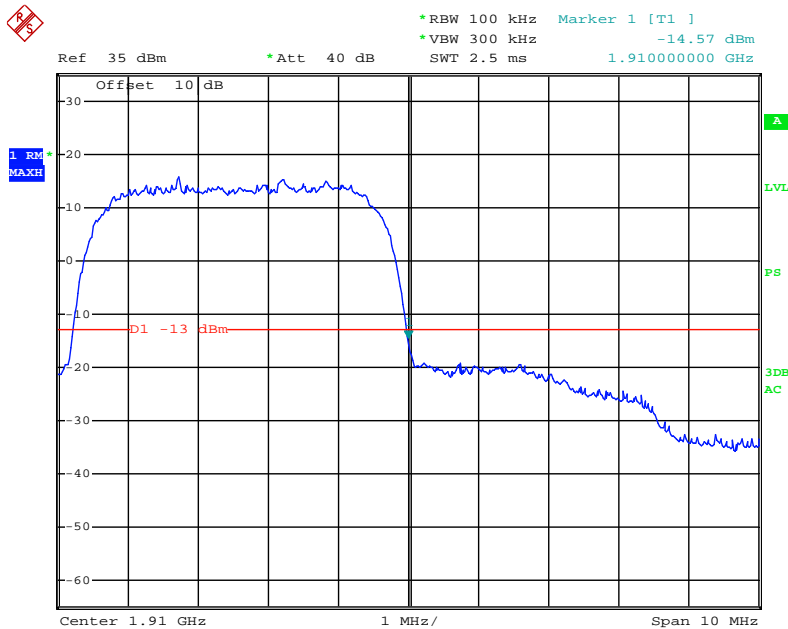

Date: 2.JUL.2014 18:09:00

### Highest channel

## 6.9 ERP, EIRP Measurement

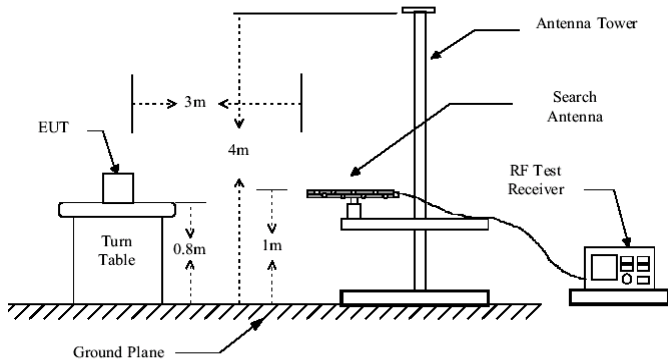
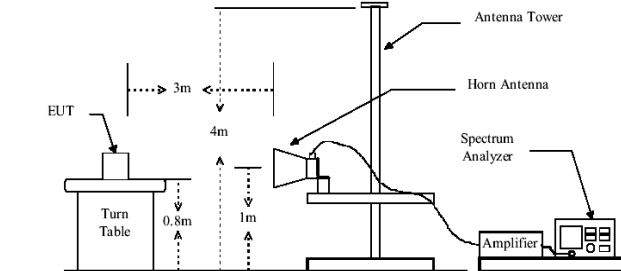
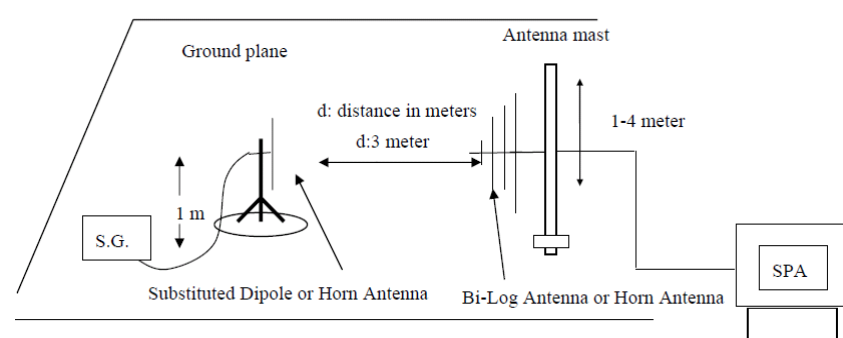
Test Requirement:	FCC part 22.913(a) and FCC part 24.232(b)
Test Method:	FCC part 2.1046
Limit:	GSM850 7W ERP PCS1900 2W EIRP WCDMA Band V: 7W ERP WCDMA Band II: 2W EIRP
Test setup:	<p>Below 1GHz</p>  <p>Above 1GHz</p>  <p>Substituted method:</p> 

<p>Test Procedure:</p>	<ol style="list-style-type: none"> <li>1. The EUT was placed on an non-conductive turntable using a non-conductive support. The radiated emission at the fundamental frequency was measured at 3 m with a test antenna and EMI spectrum analyzer.</li> <li>2. During the measurement, the EUT was communication with the station. The highest emission was recorded with the rotation of the turntable and the lowering of the test antenna from 4m to 1m. The reading was recorded and the field strength (E in dBuV/m) was calculated.</li> <li>3. ERP in frequency band 824.2 –848.80.8MHz were measured using a substitution method. The EUT was replaced by dipole antenna connected, the S.G. output was recorded and ERP was calculated as follows:  <math display="block">\text{ERP} = \text{S.G. output (dBm)} + \text{Antenna Gain (dBd)} - \text{Cable Loss (dB)}</math> </li> <li>4. EIRP in frequency band 1850.2 –1909.8MHz were measured using a substitution method. The EUT was replaced by or horn antenna connected, the S.G. output was recorded and EIRP was calculated as follows:  <math display="block">\text{EIRP} = \text{S.G. output (dBm)} + \text{Antenna Gain (dBi)} - \text{Cable Loss (dB)}</math> </li> <li>5. The worse case was relating to the conducted output power.</li> </ol>
<p>Test Instruments:</p>	<p>Refer to section 5.8 for details</p>
<p>Test mode:</p>	<p>Refer to section 5.3 for details</p>
<p>Test results:</p>	<p>Passed</p>

Measurement Data (worst case)

EUT mode	Channel	EUT Pol.	Antenna Pol.	ERP(dBm)	Limit (dBm)	Result
GSM850	128	H	V	21.96	38.45	Pass
			H	22.43		
		E1	V	21.63		
			H	22.17		
		E2	V	20.48		
			H	21.76		

EUT mode	Channel	EUT Pol.	Antenna Pol.	EIRP(dBm)	Limit (dBm)	Result
PCS1900	810	H	V	17.33	33.00	Pass
			H	19.68		
		E1	V	16.99		
			H	19.15		
		E2	V	16.63		
			H	16.44		

EUT mode	Channel	EUT Pol.	Antenna Pol.	ERP(dBm)	Limit (dBm)	Result
UMTS 850 12.2k RMC	4132	H	V	9.19	38.45	Pass
			H	16.29		
		E1	V	9.01		
			H	15.98		
		E2	V	8.96		
			H	15.75		

EUT mode	Channel	EUT Pol.	Antenna Pol.	EIRP(dBm)	Limit (dBm)	Result
UMTS 1900 12.2k RMC	9262	H	V	12.89	33.00	Pass
			H	12.62		
		E1	V	12.63		
			H	12.47		
		E2	V	12.04		
			H	11.92		

## 6.10 Field strength of spurious radiation measurement

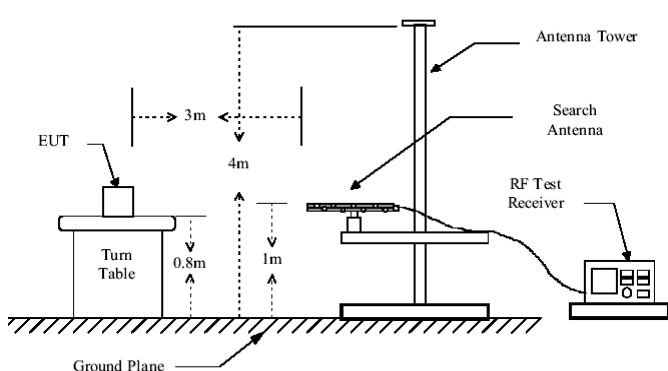
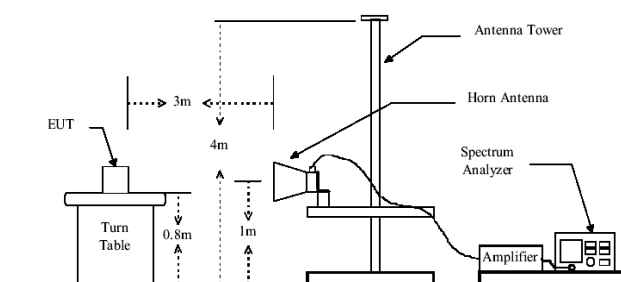
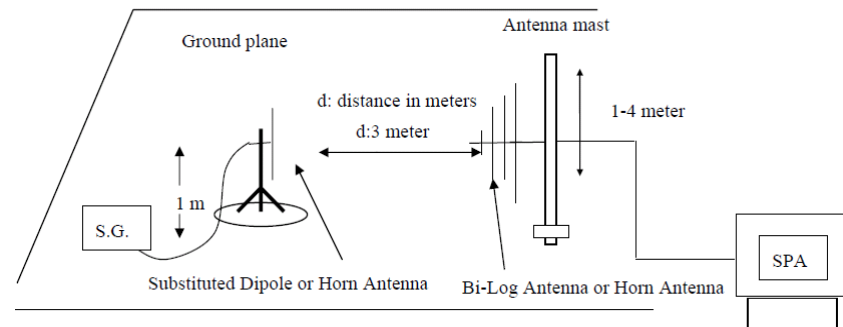
Test Requirement:	FCC part 22.917(a) and FCC part 24.238(a)
Test Method:	FCC part 2.1053
Limit:	-13dBm
Test setup:	<p>Below 1GHz</p>  <p>Above 1GHz</p>  <p>Substituted method:</p> 
Test Procedure:	<ol style="list-style-type: none"> <li>1. The EUT was placed on an non-conductive turntable using a non-conductive support. The radiated emission at the fundamental frequency was measured at 3 m with a test antenna and EMI spectrum analyzer.</li> <li>2. During the tests, the antenna height and the EUT azimuth were varied in order to identify the maximum level of emissions from the EUT. This maximization process was repeated with the EUT positioned in each of its three orthogonal orientations.</li> <li>3. The frequency range up to tenth harmonic was investigated for each of three fundamental frequency (low, middle and high channels).</li> </ol>

	<p>Once spurious emission was identified, the power of the emission was determined using the substitution method.</p> <p>4. The spurious emissions attenuation was calculated as the difference between radiated power at the fundamental frequency and the spurious emissions frequency.</p> $\text{ERP / EIRP} = \text{S.G. output (dBm)} + \text{Antenna Gain(dB/dBi)} - \text{Cable Loss (dB)}$
Test Instruments:	Refer to section 5.8 for details
Test mode:	<p>Refer to section 5.3 for details.</p> <p>Based on the ERP/EIRP results, we selected GSM850, PCS1900, UMTS RMC 850 and UMTS RMC 1900 for Radiated spurious emission test, other modes were not test.</p>
Test results:	Passed



Measurement Data (worst case)

Test mode:	GSM850		Test channel:	Lowest
Frequency (MHz)	Spurious Emission		Limit (dBm)	Result
	Polarization	Level (dBm)		
1648.40	Vertical	-48.87	-13.00	Pass
2472.60	V	-46.85		
3296.80	V	-51.07		
4121.00	V	-49.31		
4945.20	V	---		
5769.40	V	---		
1648.40	Horizontal	-51.34	-13.00	Pass
2472.60	H	-44.28		
3296.80	H	-48.90		
4121.00	H	-47.93		
4945.20	H	---		
5769.40	H	---		
Test mode:	GSM850		Test channel:	Middle
Frequency (MHz)	Spurious Emission		Limit (dBm)	Result
	Polarization	Level (dBm)		
1673.20	Vertical	-52.09	-13.00	Pass
2509.80	V	-45.63		
3346.40	V	-49.20		
4183.00	V	-47.85		
5019.60	V	---		
5856.20	V	---		
1673.20	Horizontal	-50.43	-13.00	Pass
2509.80	H	-52.17		
3346.40	H	-49.41		
4183.00	H	-44.04		
5019.60	H	---		
5856.20	H	---		

Remark :

1. The emission behavior belongs to narrowband spurious emission.
2. Remark"---" means that the emission level is too low to be measured
3. The emission levels of below 1 GHz are very lower than the limit and not show in test report.

Test mode:	GSM850		Test channel:	Highest
Frequency (MHz)	Spurious Emission		Limit (dBm)	Result
	Polarization	Level (dBm)		
1697.60	Vertical	-50.31	-13.00	Pass
2546.40	V	-46.30		
3395.20	V	-49.81		
4244.00	V	-43.67		
5092.80	V	---		
5941.60	V	---		
1697.60	Horizontal	-48.34	-13.00	Pass
2546.40	H	-48.53		
3395.20	H	-49.28		
4244.00	H	-44.17		
5092.80	H	---		
5941.60	H	---		
Test mode:	PCS1900		Test channel:	Lowest
Frequency (MHz)	Spurious Emission		Limit (dBm)	Result
	Polarization	Level (dBm)		
3700.40	Vertical	-47.89	-13.00	Pass
5550.60	V	-43.43		
7400.80	V	-39.49		
9251.00	V	-35.00		
11101.20	V	---		
12951.40	V	---		
3700.40	Horizontal	-49.72	-13.00	Pass
5550.60	H	-43.29		
7400.80	H	-40.25		
9251.00	H	-35.70		
11101.20	H	---		
12951.40	H	---		

Remark :

1. The emission behavior belongs to narrowband spurious emission.
2. Remark"---" means that the emission level is too low to be measured
3. The emission levels of below 1 GHz are very lower than the limit and not show in test report.

Test mode:	PCS1900		Test channel:	Middle
Frequency (MHz)	Spurious Emission		Limit (dBm)	Result
	Polarization	Level (dBm)		
3760.00	Vertical	-45.12	-13.00	Pass
5640.00	V	-42.98		
7520.00	V	-40.57		
9400.00	V	-38.18		
11280.00	V	---		
13160.00	V	---		
3760.00	Horizontal	-47.82	-13.00	Pass
5640.00	H	-44.21		
7520.00	H	-41.12		
9400.00	H	-37.25		
11280.00	H	---		
13160.00	H	---		
Test mode:	PCS1900		Test channel:	Highest
Frequency (MHz)	Spurious Emission		Limit (dBm)	Result
	Polarization	Level (dBm)		
3819.60	Vertical	-42.30	-13.00	Pass
5729.40	V	-44.09		
7639.20	V	-39.43		
9549.00	V	-34.67		
11458.80	V	---		
13368.60	V	---		
3819.60	Horizontal	-43.13	-13.00	Pass
5729.40	H	-43.97		
7639.20	H	-38.21		
9549.00	H	-34.27		
11458.80	H	---		
13368.60	H	---		

Remark :

1. The emission behavior belongs to narrowband spurious emission.
2. Remark"---" means that the emission level is too low to be measured
3. The emission levels of below 1 GHz are very lower than the limit and not show in test report.

Test mode:	UMTS850 12.2k RMC		Test channel:	Lowest
Frequency (MHz)	Spurious Emission		Limit (dBm)	Result
	Polarization	Level (dBm)		
1652.80	Vertical	-54.98	-13.00	Pass
2479.20	V	-44.43		
3305.60	V	-48.83		
4132.00	V	-49.17		
4958.40	V	---		
5784.80	V	---		
1652.80	Horizontal	-58.00	-13.00	Pass
2479.20	H	-46.21		
3305.60	H	-49.24		
4132.00	H	-49.68		
4958.40	H	---		
5784.80	H	---		
Test mode:	UMTS850 12.2k RMC		Test channel:	Middle
Frequency (MHz)	Spurious Emission		Limit (dBm)	Result
	Polarization	Level (dBm)		
1672.00	Vertical	-49.81	-13.00	Pass
2508.00	V	-45.83		
3344.00	V	-49.36		
4180.00	V	-47.56		
5016.00	V	---		
5852.00	V	---		
1672.00	Horizontal	-55.94	-13.00	Pass
2508.00	H	-49.03		
3344.00	H	-48.31		
4180.00	H	-49.78		
5016.00	H	---		
5852.00	H	---		

Test mode:	UMTS850 12.2k RMC		Test channel:	Highest
Frequency (MHz)	Spurious Emission		Limit (dBm)	Result
	Polarization	Level (dBm)		
1693.20	Vertical	-54.54	-13.00	Pass
2539.80	V	-44.79		
3386.40	V	-49.47		
4233.00	V	-45.51		
5079.60	V	---		
5926.20	V	---		
1693.20	Horizontal	-58.10	-13.00	Pass
2539.80	H	-46.58		
3386.40	H	-48.89		
4233.00	H	-46.77		
5079.60	H	---		
5926.20	H	---		

Remark :

1. The emission behavior belongs to narrowband spurious emission.
2. Remark”---“ means that the emission level is too low to be measured
3. The emission levels of below 1 GHz are very lower than the limit and not show in test report.

Test mode:	UMTS 1900 12.2k RMC		Test channel:	Lowest
Frequency (MHz)	Spurious Emission		Limit (dBm)	Result
	Polarization	Level (dBm)		
3704.80	Vertical	-49.77	-13.00	Pass
5557.20	V	-42.90		
7409.60	V	-39.43		
9262.00	V	---		
11114.40	V	---		
12966.80	V	---		
3704.80	Horizontal	-49.60	-13.00	Pass
5557.20	H	-41.45		
7409.60	H	-40.97		
9262.00	H	---		
11114.40	H	---		
12966.80	H	---		
Test mode:	UMTS 1900 12.2k RMC		Test channel:	Middle
Frequency (MHz)	Spurious Emission		Limit (dBm)	Result
	Polarization	Level (dBm)		
3760.00	Vertical	-51.20	-13.00	Pass
5640.00	V	-44.11		
7520.00	V	-40.71		
9400.00	V	---		
11280.00	V	---		
13160.00	V	---		
3760.00	Horizontal	-49.96	-13.00	Pass
5640.00	H	-43.60		
7520.00	H	-41.52		
9400.00	H	---		
11280.00	H	---		
13160.00	H	---		

Test mode:	UMTS 1900 12.2k RMC		Test channel:	Highest
Frequency (MHz)	Spurious Emission		Limit (dBm)	Result
	Polarization	Level (dBm)		
3815.20	Vertical	-50.61	-13.00	Pass
5722.80	V	-41.22		
7630.40	V	-40.59		
9538.00	V	---		
11445.60	V	---		
13353.20	V	---		
3815.20	Horizontal	-49.59	-13.00	Pass
5722.80	H	-41.86		
7630.40	H	-39.52		
9538.00	H	---		
11445.60	H	---		
13353.20	H	---		

Remark :

1. The emission behavior belongs to narrowband spurious emission.
2. Remark"---" means that the emission level is too low to be measured
3. The emission levels of below 1 GHz are very lower than the limit and not show in test report.

## 6.11 Frequency stability V.S. Temperature measurement

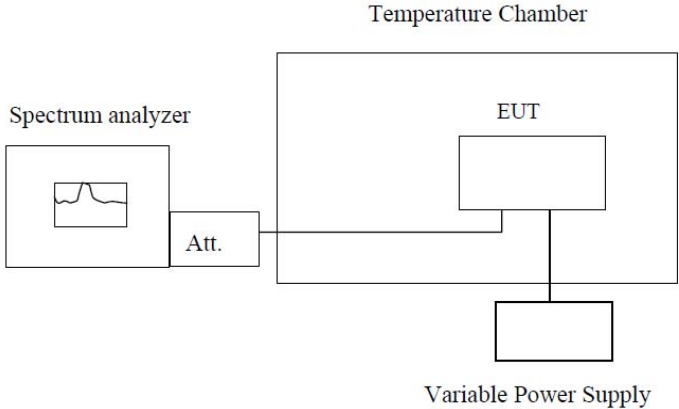
Test Requirement:	FCC Part 2.1055(a)(1)(b)
Test Method:	FCC Part 2.1055(a)(1)(b)
Limit:	2.5 ppm
Test setup:	 <p style="text-align: center;"><b>Note :</b> Measurement setup for testing on Antenna connector</p>
Test procedure:	<ol style="list-style-type: none"> <li>1. The equipment under test was connected to an external DC power supply and input rated voltage.</li> <li>2. RF output was connected to a frequency counter or spectrum analyzer via feed through attenuators.</li> <li>3. The EUT was placed inside the temperature chamber.</li> <li>4. Set the spectrum analyzer RBW low enough to obtain the desired frequency resolution and measure EUT 25°C operating frequency as reference frequency.</li> <li>5. Turn EUT off and set the chamber temperature to -30°C. After the temperature stabilized for approximately 30 minutes recorded the frequency.</li> <li>6. Repeat step measure with 10°C increased per stage until the highest temperature of +50°C reached</li> </ol>
Test Instruments:	Refer to section 5.8 for details
Test mode:	Refer to section 5.3 for details
Test results:	Passed
Remark:	All three channels of all modulations have been tested, but only the worst channel and the worst modulation show in this test item.



Measurement Data:

Reference Frequency: GSM850 Middle channel=190 channel=836.6MHz					
Power supplied (Vdc)	Temperature (°C)	Frequency error		Limit (ppm)	Result
		Hz	ppm		
3.70	-30	130	0.155391	2.5	Pass
	-20	125	0.149414		
	-10	136	0.162563		
	0	111	0.132680		
	10	138	0.164953		
	20	120	0.143438		
	30	106	0.126703		
	40	103	0.123117		
	50	119	0.142242		
Reference Frequency: PCS1900 Middle channel=661 channel=1880MHz					
Power supplied (Vdc)	Temperature (°C)	Frequency error		Limit (ppm)	Result
		Hz	ppm		
3.70	-30	160	0.085106	2.5	Pass
	-20	159	0.084574		
	-10	136	0.072340		
	0	120	0.063830		
	10	165	0.087766		
	20	151	0.080319		
	30	143	0.076064		
	40	115	0.061170		
	50	117	0.062234		

Reference Frequency: UMTS850 12.2k RMC Middle channel=4183 channel=836.6MHz					
Power supplied (Vdc)	Temperature (°C)	Frequency error		Limit (ppm)	Result
		Hz	ppm		
3.70	-30	80	0.095625	2.5	Pass
	-20	89	0.106383		
	-10	45	0.053789		
	0	60	0.071719		
	10	66	0.078891		
	20	78	0.093235		
	30	72	0.086063		
	40	41	0.049008		
	50	56	0.066938		
Reference Frequency: UMTS1900 12.2k RMC Middle channel=9400 channel=1880MHz					
Power supplied (Vdc)	Temperature (°C)	Frequency error		Limit (ppm)	Result
		Hz	ppm		
3.70	-30	77	0.040957	2.5	Pass
	-20	42	0.022340		
	-10	56	0.029787		
	0	71	0.037766		
	10	63	0.033511		
	20	66	0.035106		
	30	52	0.027660		
	40	86	0.045745		
	50	89	0.047340		

## 6.12 Frequency stability V.S. Voltage measurement

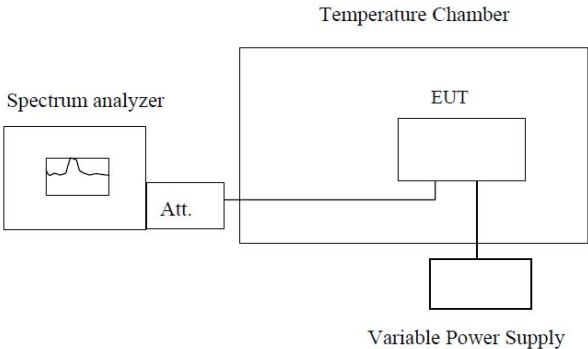
Test Requirement:	FCC Part 2.1055(d)(1)(2)
Test Method:	FCC Part 2.1055(d)(1)(2)
Limit:	2.5ppm
Test setup:	 <p><b>Note :</b> Measurement setup for testing on Antenna connector</p>
Test procedure:	<ol style="list-style-type: none"> <li>1. Set chamber temperature to 25°C. Use a variable DC power source to power the EUT and set the voltage to rated voltage.</li> <li>2. Set the spectrum analyzer RBW low enough to obtain the desired frequency resolution and recorded the frequency.</li> <li>3. Reduce the input voltage to specify extreme voltage variation (+/- 15%) and endpoint, record the maximum frequency change.</li> </ol>
Test Instruments:	Refer to section 5.8 for details
Test mode:	Refer to section 5.3 for details, and all channels have been tested, only shows the worst channel data in this report.
Test results:	Passed

Measurement Data (the worst channel):

Reference Frequency: GSM850 Middle channel=190 channel=836.6MHz					
Temperature (°C)	Power supplied (Vdc)	Frequency error		Limit (ppm)	Result
		Hz	ppm		
25	4.25	105	0.125508	2.5	Pass
	3.70	80	0.095625		
	3.40	68	0.081281		

Reference Frequency: PCS1900 Middle channel=661 channel=1880MHz					
Temperature (°C)	Power supplied (Vdc)	Frequency error		Limit (ppm)	Result
		Hz	ppm		
25	4.25	79	0.042021	2.5	Pass
	3.70	112	0.059574		
	3.40	98	0.052128		

Reference Frequency: UMTS 850 12.2k RMC Middle channel=4183 channel=836.6MHz					
Temperature (°C)	Power supplied (Vdc)	Frequency error		Limit (ppm)	Result
		Hz	ppm		
25	4.25	85	0.101602	2.5	Pass
	3.70	76	0.090844		
	3.40	113	0.135071		

Reference Frequency: UMTS 1900 12.2k RMC Middle channel=9400 channel=1880MHz					
Temperature (°C)	Power supplied (Vdc)	Frequency error		Limit (ppm)	Result
		Hz	ppm		
25	4.25	89	0.047340	2.5	Pass
	3.70	120	0.063830		
	3.40	71	0.037766		