



HAC RF TEST REPORT

No. I19Z62229-SEM01

For

TCL Communication Ltd.

**HSUPA/HSDPA/UMTS 5 Bands/GSM Quad Bands/LTE 17 bands
mobile phone**

Model name: T770B

With

Hardware Version: 03

Software Version: 3C2G

FCC ID: 2ACCJN036

Results Summary: M Category = M4

Issued Date: 2020-2-28

Note:

The test results in this test report relate only to the devices specified in this report. This report shall not be reproduced except in full without the written approval of CTTL.

The report must not be used by the client to claim product certification, approval, or endorsement by NVLAP, NIST, or any agency of the U.S.Government.

Test Laboratory:

CTTL, Telecommunication Technology Labs, CAICT

No. 51, Xueyuan Road, Haidian District, Beijing, P. R. China 100191.

Tel:+86(0)10-62304633-2512, Fax:+86(0)10-62304633-2504

Email: ctl_terminals@caict.ac.cn, website: www.caict.ac.cn

©Copyright. All rights reserved by CTTL.



No.I19Z62229-SEM01

REPORT HISTORY

Report Number	Revision	Issue Date	Description
I19Z62229-SEM01	Rev.0	2020-2-28	Initial creation of test report

TABLE OF CONTENT

1 TEST LABORATORY	5
1.1 TESTING LOCATION	5
1.2 TESTING ENVIRONMENT.....	5
1.3 PROJECT DATA	5
1.4 SIGNATURE.....	5
2 CLIENT INFORMATION	6
2.1 APPLICANT INFORMATION	6
2.2 MANUFACTURER INFORMATION	6
3 EQUIPMENT UNDER TEST (EUT) AND ANCILLARY EQUIPMENT (AE)	7
3.1 ABOUT EUT	7
3.2 INTERNAL IDENTIFICATION OF EUT USED DURING THE TEST	7
3.3 INTERNAL IDENTIFICATION OF AE USED DURING THE TEST	7
3.4 AIR INTERFACES / BANDS INDICATING OPERATING MODES	8
4 MAXIMUM OUTPUT POWER	9
5 REFERENCE DOCUMENTS.....	10
5.1 REFERENCE DOCUMENTS FOR TESTING	10
6 OPERATIONAL CONDITIONS DURING TEST	11
6.1 HAC MEASUREMENT SET-UP.....	11
6.2 PROBE SPECIFICATION	12
6.3 TEST ARCH PHANTOM & PHONE POSITIONER	13
6.4 ROBOTIC SYSTEM SPECIFICATIONS	13
7 EUT ARRANGEMENT	14
7.1 WD RF EMISSION MEASUREMENTS REFERENCE AND PLANE	14
8 SYSTEM VALIDATION	15
8.1 VALIDATION PROCEDURE	15
8.2 VALIDATION RESULT	15
9 EVALUATION OF MIF	16
9.1 INTRODUCTION.....	16
9.2 MIF MEASUREMENT WITH THE AIA	17
9.3 TEST EQUIPMENT FOR THE MIF MEASUREMENT	17
9.4 TEST SIGNAL VALIDATION.....	17
9.5 DUT MIF RESULTS.....	18
10 EVALUATION FOR LOW-POWER EXEMPTION	21
10.1 PRODUCT TESTING THRESHOLD	21
10.2 CONDUCTED POWER.....	21
10.3 CONCLUSION	22



11 RF TEST PROCEDURES..... 22

12 MEASUREMENT RESULTS (E-FIELD)..... 24

13 ANSIC 63.19-2011 LIMITS 25

14 MEASUREMENT UNCERTAINTY 26

15 MAIN TEST INSTRUMENTS..... 27

16 CONCLUSION 27

ANNEX A TEST LAYOUT 28

ANNEX B TEST PLOTS 29

ANNEX C SYSTEM VALIDATION RESULT..... 71

ANNEX D PROBE CALIBRATION CERTIFICATE 74

ANNEX E DIPOLE CALIBRATION CERTIFICATE..... 83

1 Test Laboratory

1.1 Testing Location

CompanyName:	CTTL(Shouxiang)
Address:	No. 51 Shouxiang Science Building, Xueyuan Road, Haidian District, Beijing, P. R. China100191

1.2 Testing Environment

Temperature:	18°C~25°C,
Relative humidity:	30%~ 70%
Ground system resistance:	< 0.5 Ω
Ambient noise is checked and found very low and in compliance with requirement of standards. Reflection of surrounding objects is minimized and in compliance with requirement of standards.	

1.3 Project Data

Project Leader:	Qi Dianyuan
Test Engineer:	Lin Hao
Testing Start Date:	January 12, 2020
Testing End Date:	January 14, 2020

1.4 Signature



Lin Xiaojun
(Prepared this test report)

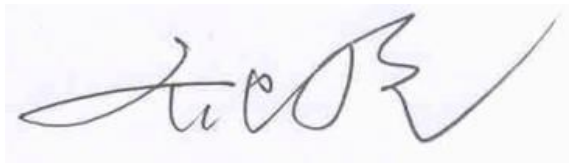

Qi Dianyuan
(Reviewed this test report)

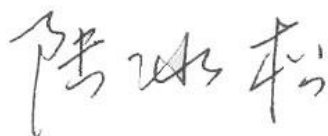

Lu Bingsong
Deputy Director of the laboratory
(Approved this test report)



2 Client Information

2.1 Applicant Information

Company Name:	TCL Communication Ltd.
Address/Post:	5/F, Building 22E, 22 Science Park East Avenue,Hong Kong Science Park, Shatin, NT, Hong Kong
Contact Person:	Gong Zhizhou
Contact Email:	zhizhou.gong@tcl.com
Telephone:	0086-755-36611722
Fax:	0086-755-36612000-81722

2.2 Manufacturer Information

Company Name:	TCL Communication Ltd.
Address/Post:	5/F, Building 22E, 22 Science Park East Avenue,Hong Kong Science Park, Shatin, NT, Hong Kong
Contact Person:	Gong Zhizhou
Contact Email:	zhizhou.gong@tcl.com
Telephone:	0086-755-36611722
Fax:	0086-755-36612000-81722

3 Equipment Under Test (EUT) and Ancillary Equipment (AE)

3.1 About EUT

Description:	HSUPA/HSDPA/UMTS 5 Bands/GSM Quad Bands/LTE 17 bands mobile phone
Model name:	T770B
Operating mode(s):	GSM 850/900/1800/1900, UMTS FDD1/2/4/5/8, BT, Wi-Fi LTE Band 1/2/3/4/5/7/8/12/13/17/25/26/28/38/40/41/66

3.2 Internal Identification of EUT used during the test

EUT ID*	IMEI	HW Version	SW Version
EUT1	015658000200889	03	3C2G

*EUT ID: is used to identify the test sample in the lab internally.

3.3 Internal Identification of AE used during the test

AE ID*	Description	Model	SN	Manufacturer
AE1	Battery	TLp038D7	/	VEKEN
AE2	Battery	TLp038D1	/	BYD
AE3	Headset	SOCL110WTT-EU	/	TES

*AE ID: is used to identify the test sample in the lab internally.

3.4 Air Interfaces / Bands Indicating Operating Modes

Air-interface	Band(MHz)	Type	C63.19/tested	Simultaneous Transmissions	OTT
GSM	850	VO	Yes	BT, WLAN	NA
	1900				
GPRS/EDGE	850	DT	Yes	BT, WLAN	Google duo
	1900				
WCDMA (UMTS)	850	VO	Yes	BT, WLAN	NA
	1700				
	1900				
	HSPA	DT	Yes	Google duo	
LTE FDD	Band7/12/13/25/26/41/66	V/D	Yes	BT, WLAN	Google duo
BT	2450	DT	NA	GSM,WCDMA,LTE	NA
WLAN	2450	V/D	Yes	GSM,WCDMA,LTE	Google duo
WLAN	5G	V/D	Yes	GSM,WCDMA, LTE	Google duo

NA: Not Applicable

VO: Voice Only

V/D: CMRS and IP Voice Service over Digital Transport

DT: Digital Transport

* HAC Rating was not based on concurrent voice and data modes, Non current mode was found to represent worst case rating for both M and T rating

Note1 = No Associated T-Coil measurement has been made in accordance with 285076 D02 T-Coil testing for CMRS IP

4 Maximum Output Power

GSM 850MHz	Tune up (dBm)		
	Channel 251(848.8MHz)	Channel 190(836.6MHz)	Channel 128(824.2MHz)
Voice	34.5	34.5	34.5
EDGE	31.5	31.5	31.5
GSM 1900MHz	Tune up(dBm)		
	Channel 810(1909.8MHz)	Channel 661(1880MHz)	Channel 512(1850.2MHz)
Voice	32	32	32
EDGE	29.5	29.5	29.5
WCDMA 850MHz	Tune up (dBm)		
	Channel 4233(846.6MHz)	Channel 4182(836.4MHz)	Channel 4132(826.4MHz)
RMC	25	25	25
HSPA	24	24	24
WCDMA 1700MHz	Tune up (dBm)		
	Channel1513(1752.6MHz)	Channel 1412(1732.4MHz)	Channel 1312(1712.4MHz)
RMC	24.5	24.5	24.5
HSPA	23.5	23.5	23.5
WCDMA 1900MHz	Tune up (dBm)		
	Channel9538(1907.6MHz)	Channel 9400(1880MHz)	Channel 9262(1852.4MHz)
RMC	24.8	24.8	24.8
HSPA	23.5	23.5	23.5
LTE Band7	Tune up (dBm)		
	Channel 21350(2560Hz)	Channel 21100(2535MHz)	Channel20850(2510MHz)
QPSK	23.6	23.6	23.6
16QAM	22.6	22.6	22.6
64QAM	21.6	21.6	21.6
LTE Band12	Tune up (dBm)		
	Channel 23130(711MHz)	Channel 23095(707.5MHz)	Channel23060(704MHz)
QPSK	24.2	24.2	24.2
16QAM	23.2	23.2	23.2
64QAM	22.2	22.2	22.2
LTE Band13	Tune up (dBm)		
	Channel 23230(782MHz)		
QPSK	24.5		
16QAM	23.5		
64QAM	22.5		
LTE Band25	Tune up (dBm)		
	Channel26590(1905MHz)	Channel26365(1882.5MHz)	Channel26140(1860MHz)
QPSK	24.5	24.5	24.5
16QAM	23.5	23.5	23.5
64QAM	22.5	22.5	22.5

LTE Band26	Tune up (dBm)		
	Channel26965(841.5MHz)	Channel 26865(831.5MHz)	Channel 26765(821.5MHz)
QPSK	24.5	24.5	24.5
16QAM	23.5	23.5	23.5
64QAM	22.5	22.5	22.5
LTE Band41	Tune up(dBm)		
	Channel 41490(2680MHz)	Channel 40620(2593MHz)	Channel 39750(2506MHz)
QPSK	25	25	25
16QAM	24	24	24
64QAM	23	23	23
LTE Band66	Tune up(dBm)		
	Channel 132572(1770MHz)	Channel 132322(1745MHz)	Channel 133072(1720MHz)
QPSK	24.5	24.5	24.5
16QAM	23.5	23.5	23.5
64QAM	22.5	22.5	22.5
2.4GHz 802.11b	Tune up (dBm)		
	Channel 11 (2462MHz)	Channel 6 (2437MHz)	Channel 1 (2412MHz)
	19.6	19.6	19.6
5GHz 802.11a	Tune up (dBm)		
	Channel 100(5500 MHz)	Channel 124(5620 MHz)	Channel 144(5720 MHz)
	18.6	18.6	18.6

5 Reference Documents

5.1 Reference Documents for testing

The following document listed in this section is referred for testing.

Reference	Title	Version
ANSI C63.19-2011	American National Standard for Methods of Measurement of Compatibility between Wireless Communication Devices and Hearing Aids	2011 Edition
FCC 47 CFR §20.19	Hearing Aid Compatible Mobile Headsets	2015 Edition
KDB 285076 D01	Equipment Authorization Guidance for Hearing Aid Compatibility	v05

6 OPERATIONAL CONDITIONS DURING TEST

6.1 HAC MEASUREMENT SET-UP

These measurements are performed using the DASY5 NEO automated dosimetric assessment system. It is made by Schmid & Partner Engineering AG (SPEAG) in Zurich, Switzerland. It consists of high precision robotics system (Stäubli), robot controller, Intel Core2 computer, near-field probe, probe alignment sensor. The robot is a six-axis industrial robot performing precise movements. A cell controller system contains the power supply, robot controller, teach pendant (Joystick), and remote control, is used to drive the robot motors. The PC consists of the HP Intel Core21.86 GHz computer with Windows XP system and HAC Measurement Software DASY5 NEO, A/D interface card, monitor, mouse, and keyboard. The Stäubli Robot is connected to the cell controller to allow software manipulation of the robot. A data acquisition electronic (DAE) circuit performs the signal amplification, signal multiplexing, AD-conversion, offset measurements, mechanical surface detection, collision detection, etc. is connected to the Electro-optical coupler (EOC). The EOC performs the conversion from the optical into digital electric signal of the DAE and transfers data to the PC plug-in card.

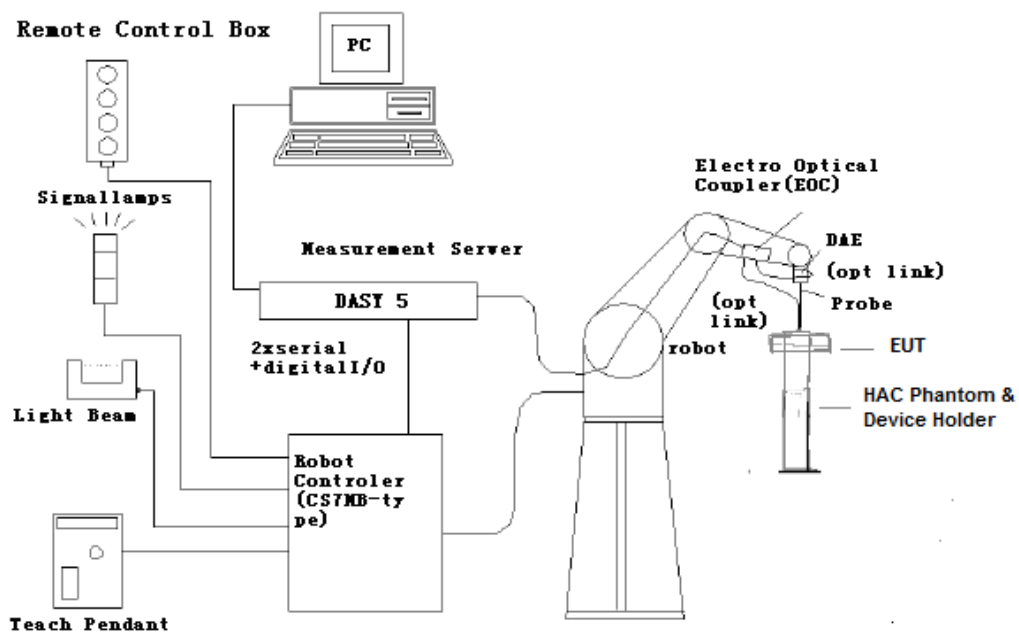

Fig. 1 HAC Test Measurement Set-up

The DAE4 consists of a highly sensitive electrometer-grade preamplifier with auto-zeroing, a channel and gain-switching multiplexer, a fast 16 bit AD-converter and a command decoder and control logic unit. Transmission to the PC-card is accomplished through an optical downlink for data and status information and an optical uplink for commands and clock lines. The mechanical probe mounting device includes two different sensor systems for frontal and sidewise probe contacts. They are also used for mechanical surface detection and probe collision detection. The robot uses its own controller with a built in VME-bus computer.

6.2 Probe Specification

E-Field Probe Description

Construction	One dipole parallel, two dipoles normal to probe axis Built-in shielding against static charges PEEK enclosure material
Calibration	In air from 100 MHz to 3.0 GHz (absolute accuracy $\pm 6.0\%$, $k=2$)
Frequency	40 MHz to > 6 GHz (can be extended to < 20 MHz) Linearity: ± 0.2 dB (100 MHz to 3 GHz)
Directivity	± 0.2 dB in air (rotation around probe axis) ± 0.4 dB in air (rotation normal to probe axis)
Dynamic Range	2 V/m to > 1000 V/m; Linearity: ± 0.2 dB
Dimensions	Overall length: 330 mm (Tip: 16 mm) Tip diameter: 8 mm (Body: 12 mm) Distance from probe tip to dipole centers: 2.5 mm
Application	General near-field measurements up to 6 GHz Field component measurements Fast automatic scanning in phantoms



[ER3DV6]

6.3 Test Arch Phantom & Phone Positioner

The Test Arch phantom should be positioned horizontally on a stable surface. Reference markings on the Phantom allow the complete setup of all predefined phantom positions and measurement grids by manually teaching three points in the robot. It enables easy and well defined positioning of the phone and validation dipoles as well as simple teaching of the robot (Dimensions: 370 x 370 x 370 mm).

The Phone Positioner supports accurate and reliable positioning of any phone with effect on near field $< \pm 0.5$ dB.

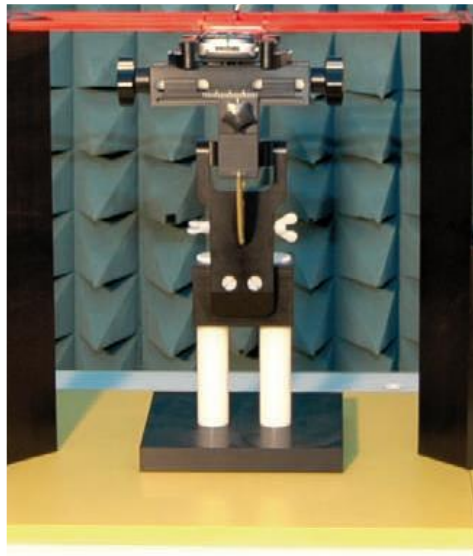

Fig. 2 HAC Phantom & Device Holder

6.4 Robotic System Specifications

Specifications

Positioner: Stäubli Unimation Corp. Robot Model: RX160L

Repeatability: ± 0.02 mm

No. of Axis: 6

Data Acquisition Electronic (DAE) System

Cell Controller

Processor: Intel Core2

Clock Speed: 1.86GHz

Operating System: Windows XP

Data Converter

Features: Signal Amplifier, multiplexer, A/D converter, and control logic

Software: DASY5 software

Connecting Lines: Optical downlink for data and status info.

Optical uplink for commands and clock

7 EUT ARRANGEMENT

7.1 WD RF Emission Measurements Reference and Plane

Figure 4 illustrates the references and reference plane that shall be used in the WD emissions measurement.

- The grid is 5 cm by 5 cm area that is divided into 9 evenly sized blocks or sub-grids.
- The grid is centered on the audio frequency output transducer of the WD (speaker or T-coil).
- The grid is located by reference to a reference plane. This reference plane is the planar area that contains the highest point in the area of the WD that normally rests against the user's ear
- The measurement plane is located parallel to the reference plane and 15 mm from it, out from the phone. The grid is located in the measurement plane.

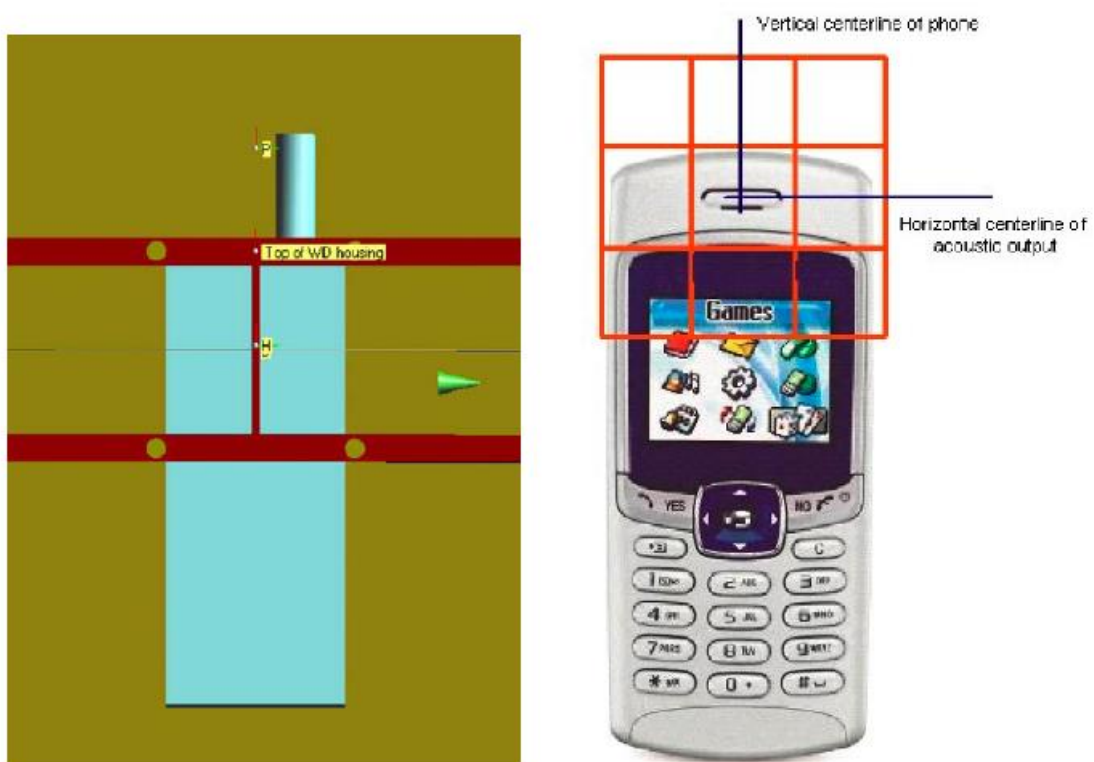

Fig. 3 WD reference and plane for RF emission measurements

8 SYSTEM VALIDATION

8.1 Validation Procedure

Place a dipole antenna meeting the requirements given in ANSI C63.19 in the position normally occupied by the WD. The dipole antenna serves as a known source for an electrical output. Position the E-field probes so that:

- The probes and their cables are parallel to the coaxial feed of the dipole antenna
- The probe cables and the coaxial feed of the dipole antenna approach the measurement area from opposite directions
- The center point of the probe element(s) are 15 mm from the closest surface of the dipole elements.

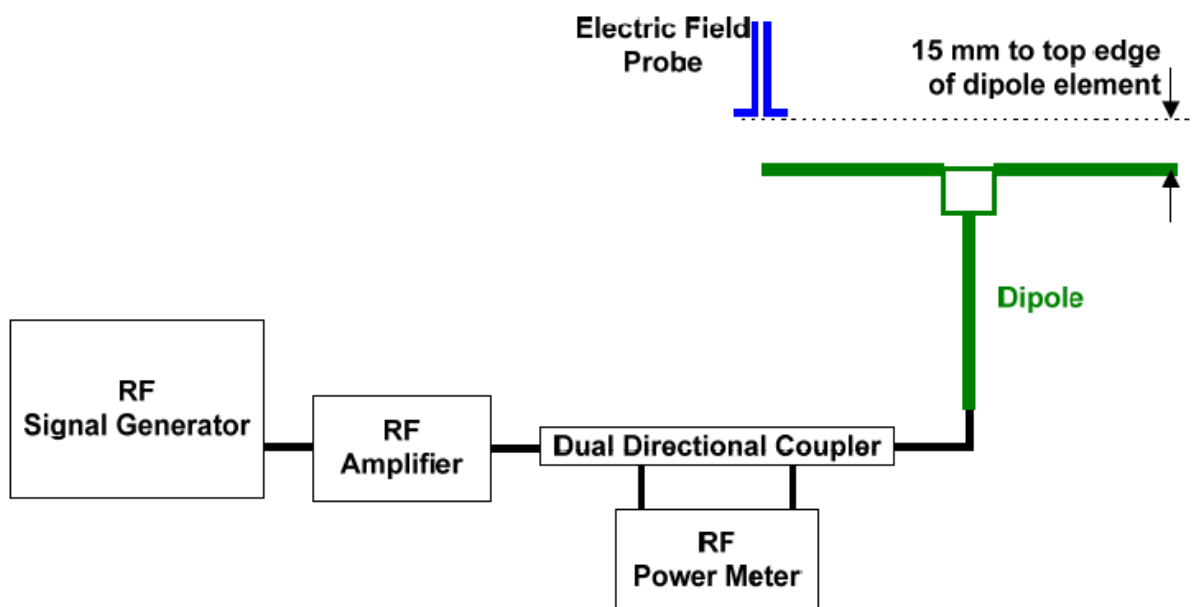

Fig. 4 Dipole Validation Setup

8.2 Validation Result

E-Field Scan						
Mode	Frequency (MHz)	Input Power (mW)	Measured ¹ Value(dBV/m)	Target ² Value(dBV/m)	Deviation ³ (%)	Limit ⁴ (%)
CW	835	100	40.68	40.56	1.39	±25
CW	1880	100	39.14	38.89	2.92	±25
CW	2600	100	38.65	38.57	0.93	±25

Notes:

1. Please refer to the attachment for detailed measurement data and plot.
2. Target value is provided by SPEAD in the calibration certificate of specific dipoles.
3. Deviation (%) = $100 * (\text{Measured value minus Target value}) / \text{Target value}$.
4. ANSI C63.19 requires values within $\pm 25\%$ are acceptable, of which 12% is deviation and 13% is measurement uncertainty. Values independently validated for the dipole actually used in the measurements should be used, when available.

9 Evaluation of MIF

9.1 Introduction

The MIF (Modulation Interference Factor) is used to classify E-field emission to determine Hearing Aid Compatibility (HAC). It scales the power-averaged signal to the RF audio interference level and is characteristic to a modulation scheme. The HAC standard preferred "indirect" measurement method is based on average field measurement with separate scaling by the MIF. With an Audio Interference Analyzer (AIA) designed by SPEAG specifically for the MIF measurement, these values have been verified by practical measurements on an RF signal modulated with each of the waveforms. The resulting deviations from the simulated values are within the requirements of the HAC standard.

The AIA (Audio Interference Analyzer) is a USB powered electronic sensor to evaluate signals in the frequency range 698MHz - 6 GHz. It contains RMS detector and audio frequency circuits for sampling of the RF envelope.

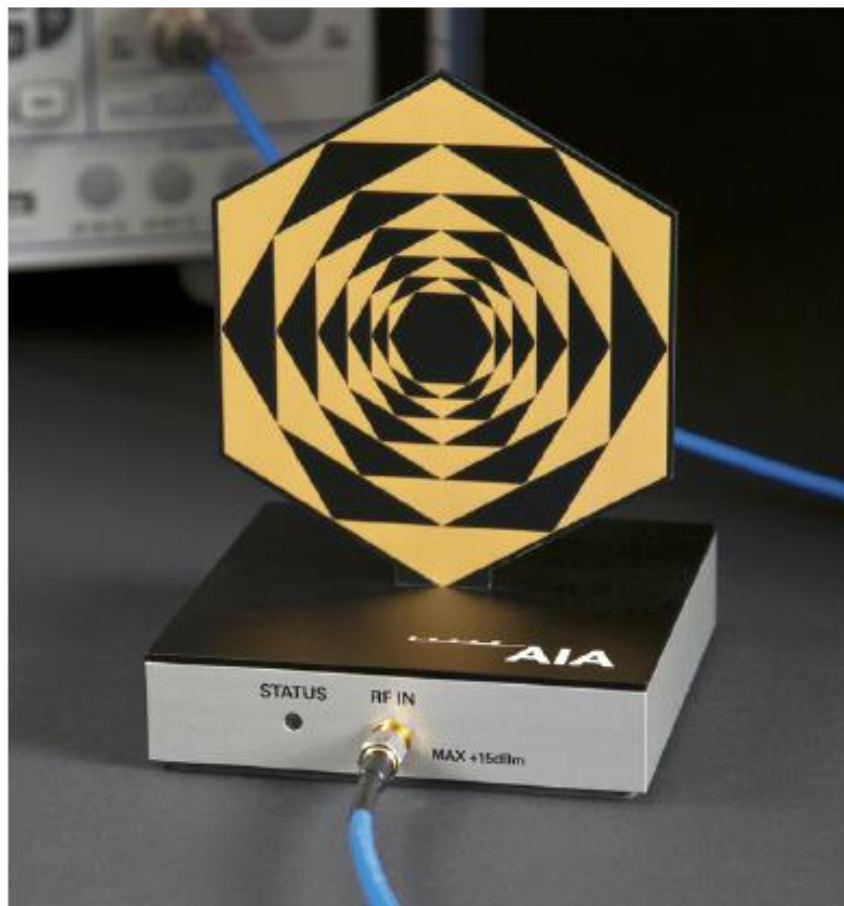

Fig. 5 AIA Front View

9.2 MIF measurement with the AIA

The MIF is measured with the AIA as follows:

1. Connect the AIA via USB to the DASY5 PC and verify the configuration settings.
2. Couple the RF signal to be evaluated to an AIA via cable or antenna.
3. Generate a MIF measurement job for the unknown signal and select the measurement port and timing settings.
4. Document the results via the post processor in a report.

9.3 Test equipment for the MIF measurement

No.	Name	Type	Serial Number	Manufacturer
01	Signal Generator	E4438C	MY49071430	Agilent
02	AIA	SE UMS 170 CB	1029	SPEAG
03	BTS	E5515C	MY50263375	Agilent

9.4 Test signal validation

The signal generator (E4438C) is used to generate a 1GHz signal with different modulation in the below table based on the ANSI C63.19-2011. The measured MIF with AIA are compared with the target values given in ANSI C63.19-2011 table D.3, D.4 and D5.

Pulse modulation	Target MIF	Measured MIF	Deviation
0.5ms pulse, 1000Hz repetition rate	-0.9 dB	-0.9 dB	0 dB
1ms pulse, 100Hz repetition rate	+3.9 dB	+3.7 dB	0.2 dB
0.1ms pulse, 100Hz repetition rate	+10.1 dB	+10.0 dB	0.1 dB
10ms pulse, 10Hz repetition rate	+1.6 dB	+1.7 dB	0.1 dB
Sine-wave modulation	Target MIF	Measured MIF	Deviation
1 kHz, 80% AM	-1.2 dB	-1.3 dB	0.1 dB
1 kHz, 10% AM	-9.1 dB	-9.0 dB	0.1 dB
1 kHz, 1% AM	-19.1 dB	-18.9 dB	0.2 dB
100 Hz, 10% AM	-16.1 dB	-16.0 dB	0.1 dB
10 kHz, 10% AM	-21.5 dB	-21.6 dB	0.1 dB
Transmission protocol	Target MIF	Measured MIF	Deviation
GSM; full-rate version 2; speech codec/handset low	+3.5 dB	+3.47 dB	0.03 dB
WCDMA; speech; speech codec low; AMR 12.2 kb/s	-20.0 dB	-19.8 dB	0.2 dB
CDMA; speech; SO3; RC3; full frame rate; 8kEVRC	-19.0 dB	-19.1 dB	0.1 dB
CDMA; speech; SO3; RC1; 1/8 th frame rate; 8kEVRC	+3.3 dB	+3.44 dB	0.14 dB

9.5 DUT MIF results

Typical MIF levels in ANSI C63.19-2011	
Transmission protocol	Modulation interference factor
GSM-FDD (TDMA, GMSK)	+3.63 dB
EDGE-FDD (TDMA, 8PSK, TN 0-1)	+1.23dB
EDGE-FDD (TDMA, 8PSK, TN 0-1-2-3)	-1.82dB
UMTS-FDD (WCDMA)	-27.23 dB
UMTS-FDD (HSPA)	-20.75dB
LTE-FDD (SC-FDMA, 1RB, 20MHz, QPSK)	-15.63 dB
LTE-FDD (SC-FDMA, 1RB, 20MHz, 16QAM)	-9.76 dB
LTE-FDD (SC-FDMA, 1RB, 20MHz, 64QAM)	-9.93 dB
LTE-TDD (SC-FDMA, 1RB, 20MHz, QPSK)	-1.62 dB
LTE-TDD (SC-FDMA, 1RB, 20MHz, 16QAM)	-1.44 dB
LTE-TDD (SC-FDMA, 1RB, 20MHz, 64QAM)	-1.54 dB
CDMA2000, RC1, SO3, 1/8th Rate 25 fr	+3.26 dB

Measured MIF for GSM							
Band		GSM 850			GSM 1900		
Channel		251	190	128	810	661	512
Mode	Voice	3.47	3.45	3.5	3.5	3.5	3.51
	EDGE	0.32	0.53	0.49	0.44	0.56	0.39

Measured MIF for WCDMA										
Band		WCDMA 850			WCDMA 1700			WCDMA 1900		
Channel		4458	4407	4357	1738	1637	1537	9938	9800	9662
Mode	RMC	-22.4	-22.72	-22.8	-23.51	-22.68	-23.49	-24.23	-24.12	-24.04
	HSUPA	-23.32	-22.97	-22.84	-23.64	-22.87	-23.65	-24.38	-24.33	-24.18

QPSK

Measured MIF levels		
Band	Channel	Modulation interference factor
Band7	21350	-14.77
	21100	-14.66
	20850	-13.94
Band12	23130	-14.21
	23095	-14.3
	23060	-14.31
Band13	23230	-14.11
Band25	26590	-14.35
	26365	-14.78
	26140	-14.55
Band26	26965	-14.34
	26865	-13.81
	26775	-14.65
Band41	41490	-1.7
	41055	-1.85
	40620	-1.67
	40185	-1.73
	39750	-1.7
Band66	132572	-14.61
	132322	-14.69
	132072	-14.1

16QAM

Measured MIF levels		
Band	Channel	Modulation interference factor
Band7	21350	-10.65
	21100	-10.71
	20850	-10.08
Band12	23130	-10.12
	23095	-10.57
	23060	-10.23
Band13	23230	-10.11
Band25	26590	-10.03
	26365	-10.55
	26140	-10.6
Band26	26965	-10.04
	26865	-10.43
	26775	-10.49
Band41	41490	-1.71
	41055	-1.95

	40620	-1.55
	40185	-1.67
	39750	-1.75
Band66	132572	-10.41
	132322	-10.57
	132072	-10.28

64QAM

Measured MIF levels		
Band	Channel	Modulation interference factor
Band7	21350	-10.43
	21100	-10.45
	20850	-10.73
Band12	23130	-10
	23095	-10.47
	23060	-10.42
Band13	23230	-10.89
Band25	26590	-10.42
	26365	-10.14
	26140	-10.38
Band26	26965	-10.35
	26865	-10.16
	26775	-10.28
Band41	41490	-1.78
	41055	-1.66
	40620	-1.49
	40185	-1.71
	39750	-1.55
Band66	132572	-10.12
	132322	-10.36
	132072	-10.33

WiFi

2.4GHz 802.11b	11	-4.29
	6	-4.78
	1	-4.33
5GHz 802.11a	48	-6.18

10 Evaluation for low-power exemption

10.1 Product testing threshold

There are two methods for exempting an RF air interface technology from testing. The first method requires evaluation of the MIF for the worst-case operating mode. An RF air interface technology of a device is exempt from testing when its average antenna input power plus its MIF is ≤ 17 dBm for any of its operating modes. The second method does not require determination of the MIF. The RF emissions testing exemption shall be applied to an RF air interface technology in a device whose peak antenna input power, averaged over intervals $\leq 50 \mu s$, is ≤ 23 dBm. An RF air interface technology that is exempted from testing by either method shall be rated as M4.

The first method is used to be exempt from testing for the RF air interface technology in this report.

10.2 Conducted power

Band	Average power (dBm)	MIF (dB)	Sum (dBm)	C63.19 Tested
GSM 850 - Voice	34.5	3.5	38.00	Yes
GSM 850 - EDGE	31.5	0.53	32.03	Yes*
GSM 1900 - Voice	32	3.51	35.51	Yes
GSM 1900 - EDGE	29.5	0.56	30.06	Yes*
WCDMA 850 - RMC	25	-22.4	2.60	No
WCDMA 850 - HSPA	24	-22.84	1.16	No
WCDMA 1700 - RMC	24.5	-22.68	1.82	No
WCDMA 1700 - HSPA	23.5	-22.87	0.63	No
WCDMA 1900 - RMC	24.8	-24.04	0.76	No
WCDMA 1900 - HSPA	23.5	-24.18	-0.68	No
LTE Band 7 QPSK	23.6	-13.94	9.66	No
LTE Band 12 QPSK	24.2	-14.21	9.99	No
LTE Band 13 QPSK	24.5	-14.11	10.39	No
LTE Band 25 QPSK	24.5	-14.35	10.15	No
LTE Band 26 QPSK	24.5	-13.81	10.69	No
LTE Band 41 QPSK	25	-1.67	23.33	Yes
LTE Band 66 QPSK	24.5	-14.1	10.40	No
LTE Band 7 16QAM	22.6	-10.08	12.52	No
LTE Band 12 16QAM	23.2	-10.12	13.08	No
LTE Band 13 16QAM	23.5	-10.11	13.39	No
LTE Band 25 16QAM	23.5	-10.03	13.47	No
LTE Band 26 16QAM	23.5	-10.04	13.46	No
LTE Band 41 16QAM	24	-1.55	22.45	Yes
LTE Band 66 16QAM	23.5	-10.28	13.22	No
LTE Band 7 64QAM	21.6	-10.43	11.17	No
LTE Band 12 64QAM	22.2	-10	12.20	No

LTE Band 13 64QAM	22.5	-10.89	11.61	No
LTE Band 25 64QAM	22.5	-10.14	12.36	No
LTE Band 26 64QAM	22.5	-10.16	12.34	No
LTE Band 41 64QAM	23	-1.49	21.51	Yes
LTE Band 66 64QAM	22.5	-10.12	12.38	No
WiFi-2.4G	19.6	-4.29	15.31	No
WiFi-5G	18.6	-6.18	12.42	No

*Note: For GSM bands, EDGE modes were not evaluated as Voice modes were found to be the worst-case modes for the GSM air interface.

10.3 Conclusion

According to the above table, the sums of average power and MIF for WCDMA, LTE FDD and WiFi are less than 17dBm. So it is measured for GSM and LTE TDD bands. The WCDMA, LTE FDD and WiFi are exempt from testing and rated as M4.

11 RF TEST PROCEDURES

The evaluation was performed with the following procedure:

- 1) Confirm proper operation of the field probe, probe measurement system and other instrumentation and the positioning system.
- 2) Position the WD in its intended test position. The gauge block can simplify this positioning.
- 3) Configure the WD normal operation for maximum rated RF output power, at the desired channel and other operating parameters (e.g., test mode), as intended for the test.
- 4) The center sub-grid shall be centered on the center of the T-Coil mode axial measurement point or the acoustic output, as appropriate. Locate the field probe at the initial test position in the 50 mm by 50 mm grid, which is contained in the measurement plane. If the field alignment method is used, align the probe for maximum field reception.
- 5) Record the reading.
- 6) Scan the entire 50 mm by 50 mm region in equally spaced increments and record the reading at each measurement point. The distance between measurement points shall be sufficient to assure the identification of the maximum reading.
- 7) Identify the five contiguous sub-grids around the center sub-grid whose maximum reading is the lowest of all available choices. This eliminates the three sub-grids with the maximum readings. Thus, the six areas to be used to determine the WD's highest emissions are identified.
- 8) Identify the maximum field reading within the non-excluded sub-grids identified in Step 7)
- 9) Evaluate the MIF and add to the maximum steady-state rms field-strength reading to obtain the RF audio interference level..
- 10) Compare this RF audio interference level with the categories and record the resulting WD category rating.

12 Measurement Results (E-Field)

Frequency		Measured Value(dBV/m)	Power Drift (dB)	Category
MHz	Channel			
GSM 850				
848.8	251	34.32	-0.03	M4 (see Fig B.1)
836.6	190	34.93	-0.01	M4 (see Fig B.2)
824.2	128	34.29	0.01	M4 (see Fig B.3)
GSM 1900				
1909.8	810	22.41	0.17	M4 (see Fig B.4)
1880	661	22.08	-0.04	M4 (see Fig B.5)
1850.2	512	22.11	0.12	M4 (see Fig B.6)
LTE Band 41 QPSK				
2680	41490	24.34	-0.04	M4 (see Fig B.7)
2636.5	41055	21.17	0	M4 (see Fig B.8)
2593	40620	24.92	-0.01	M4 (see Fig B.9)
2549.5	40185	21.67	0.01	M4 (see Fig B.10)
2506	39750	23.37	0.05	M4 (see Fig B.11)
LTE Band 41 16QAM				
2680	41490	19.71	0.13	M4 (see Fig B.12)
2636.5	41055	19.08	-0.01	M4 (see Fig B.13)
2593	40620	20.66	-0.02	M4 (see Fig B.14)
2549.5	40185	19.48	-0.11	M4 (see Fig B.15)
2506	39750	21.16	-0.1	M4 (see Fig B.16)
LTE Band 41 64QAM				
2680	41490	23.04	0.01	M4 (see Fig B.17)
2636.5	41055	22.39	-0.03	M4 (see Fig B.18)
2593	40620	24.1	-0.03	M4 (see Fig B.19)
2549.5	40185	23.14	-0.05	M4 (see Fig B.20)
2506	39750	24.7	-0.01	M4 (see Fig B.21)

Note: For LTE TDD, UL-DL Configuration 0 was used to evaluate Band41

13 ANSIC 63.19-2011 LIMITS

WD RF audio interference level categories in logarithmic units

Emission categories	< 960 MHz	E-field emissions
Category M1	50 to 55	dB (V/m)
Category M2	45 to 50	dB (V/m)
Category M3	40 to 45	dB (V/m)
Category M4	< 40	dB (V/m)
Emission categories	> 960 MHz	E-field emissions
Category M1	40 to 45	dB (V/m)
Category M2	35 to 40	dB (V/m)
Category M3	30 to 35	dB (V/m)
Category M4	< 30	dB (V/m)

14 MEASUREMENT UNCERTAINTY

No.	Error source	Type	Uncertainty Value(%)	Prob. Dist.	k	c _i E	Standard Uncertainty (%) u_i ; (%)E	Degree of freedom V_{eff} or ν_i
Measurement System								
1	Probe Calibration	B	5.	N	1	1	5.1	∞
2	Axial Isotropy	B	4.7	R	$\sqrt{3}$	1	2.7	∞
3	Sensor Displacement	B	16.5	R	$\sqrt{3}$	1	9.5	∞
4	Boundary Effects	B	2.4	R	$\sqrt{3}$	1	1.4	∞
5	Linearity	B	4.7	R	$\sqrt{3}$	1	2.7	∞
6	Scaling to Peak Envelope Power	B	2.0	R	$\sqrt{3}$	1	1.2	∞
7	System Detection Limit	B	1.0	R	$\sqrt{3}$	1	0.6	∞
8	Readout Electronics	B	0.3	N	1	1	0.3	∞
9	Response Time	B	0.8	R	$\sqrt{3}$	1	0.5	∞
10	Integration Time	B	2.6	R	$\sqrt{3}$	1	1.5	∞
11	RF Ambient Conditions	B	3.0	R	$\sqrt{3}$	1	1.7	∞
12	RF Reflections	B	12.0	R	$\sqrt{3}$	1	6.9	∞
13	Probe Positioner	B	1.2	R	$\sqrt{3}$	1	0.7	∞
14	Probe Positioning	A	4.7	R	$\sqrt{3}$	1	2.7	∞
15	Extra. And Interpolation	B	1.0	R	$\sqrt{3}$	1	0.6	∞
Test Sample Related								
16	Device Positioning Vertical	B	4.7	R	$\sqrt{3}$	1	2.7	∞
17	Device Positioning Lateral	B	1.0	R	$\sqrt{3}$	1	0.6	∞
18	Device Holder and Phantom	B	2.4	R	$\sqrt{3}$	1	1.4	∞
19	Power Drift	B	5.0	R	$\sqrt{3}$	1	2.9	∞

20	AIA measurement	B	12	R	$\sqrt{3}$	1	6.9	∞
Phantom and Setup related								
21	Phantom Thickness	B	2.4	R	$\sqrt{3}$	1	1.4	∞
Combined standard uncertainty(%)							16.2	
Expanded uncertainty (confidence interval of 95 %)		$u_e = 2u_c$		N	k=2		32.4	

15 MAIN TEST INSTRUMENTS

Table 1: List of Main Instruments

No.	Name	Type	Serial Number	Calibration Date	Valid Period
01	Signal Generator	E4438C	MY49071430	January 23, 2019	One Year
02	Power meter	NRP2	106277	September 4, 2019	One year
03	Power sensor	NRP8S	104291		
04	Amplifier	60S1G4	0331848	No Calibration Requested	
05	E-Field Probe	EF3DV3	4060	May 17, 2019	One year
06	DAE	SPEAG DAE4	1331	February 6, 2019	One year
07	HAC Dipole	CD835V3	1023	August 26, 2019	One year
08	HAC Dipole	CD1880V3	1018	August 26, 2019	One year
09	HAC Dipole	CD2600V3	1017	August 23, 2019	One year
10	BTS	E5515C	MY50263375	January 17, 2019	One year
11	AIA	SE UMS 170 CB	1029	No Calibration Requested	

16 CONCLUSION

The HAC measurement indicates that the EUT complies with the HAC limits of the ANSIC63.19-2011. The total M-rating is **M4**.

END OF REPORT BODY

ANNEX A TEST LAYOUT

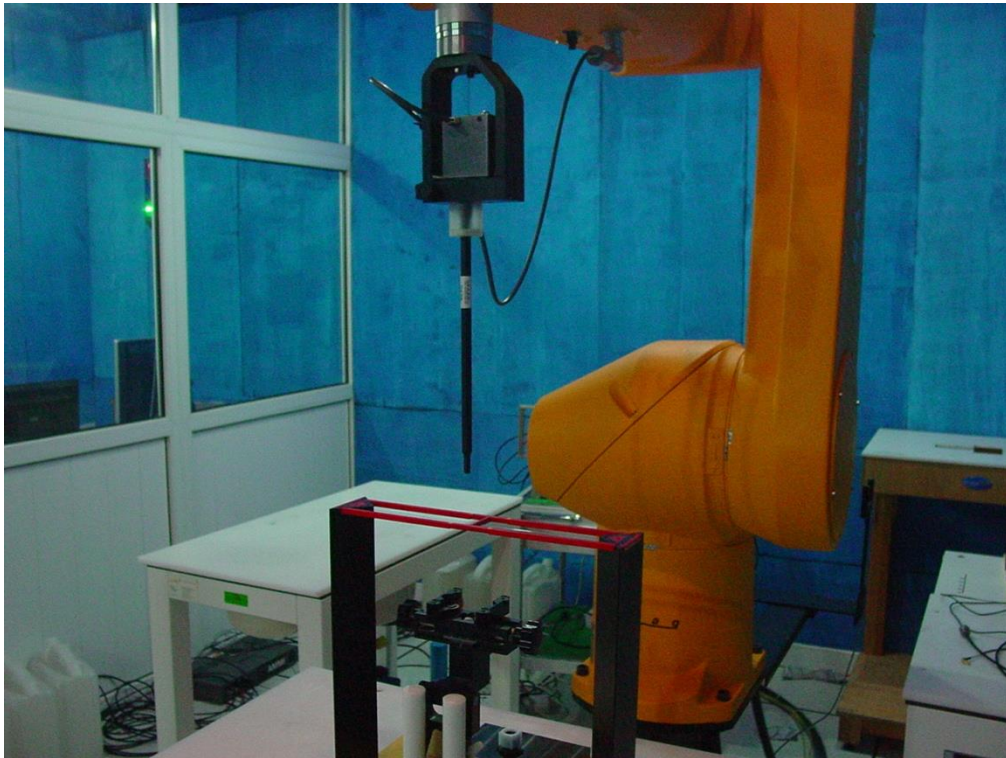

Picture A1:HAC RF System Layout

ANNEX B TEST PLOTS

HAC RF E-Field GSM 850 High

Date: 2020-1-12

Electronics: DAE4 Sn1331

Medium: Air

Medium parameters used: $\sigma = 0$ mho/m, $\epsilon_r = 1$; $\rho = 1000$ kg/m³

Ambient Temperature: 22.0°C

Communication System: GSM 850; Frequency: 848.8 MHz; Duty Cycle: 1:8.3

Probe: EF3DV3 - SN4060;ConvF(1, 1, 1)

GSM850/E Scan - ER3DV6 - 2011: 15 mm from Probe Center to the

Device/Hearing Aid Compatibility Test (101x101x1): Interpolated grid:

dx=0.5000 mm, dy=0.5000 mm

Device Reference Point: 0, 0, -6.3 mm

Reference Value = 43.61 V/m; Power Drift = -0.03 dB

Applied MIF = 3.47 dB

RF audio interference level = 34.32 dBV/m

Emission category: **M4**

MIF scaled E-field

Grid 1 M4 33.17 dBV/m	Grid 2 M4 33.42 dBV/m	Grid 3 M4 32.74 dBV/m
Grid 4 M4 33.89 dBV/m	Grid 5 M4 34.32 dBV/m	Grid 6 M4 33.66 dBV/m
Grid 7 M4 34.99 dBV/m	Grid 8 M4 35.23 dBV/m	Grid 9 M4 34.24 dBV/m

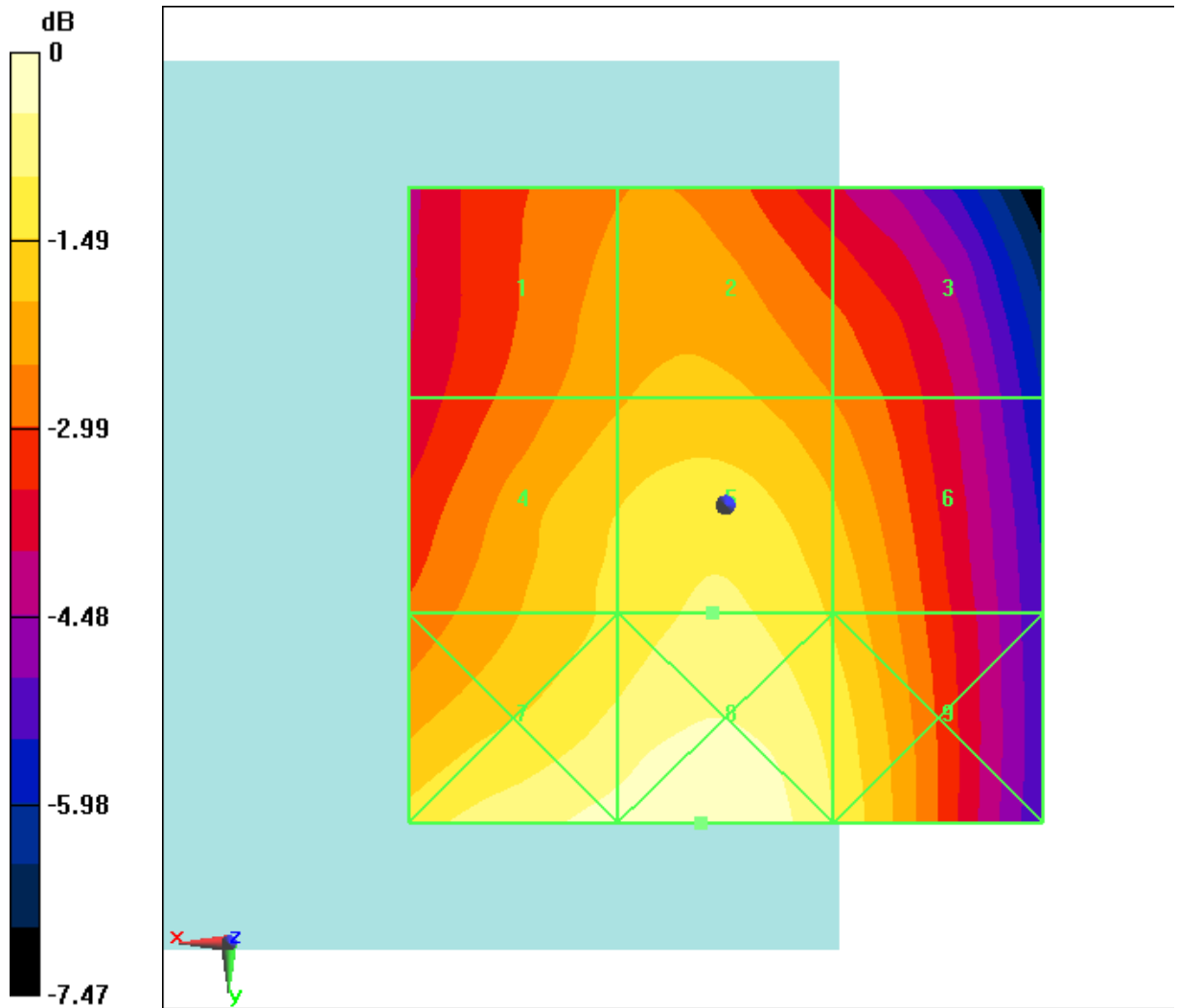

0 dB = 57.76 V/m = 35.23 dBV/m

Fig B.1 HAC RF E-Field GSM 850 High

HAC RF E-Field GSM 850 Middle

Date: 2020-1-12

Electronics: DAE4 Sn1331

Medium: Air

Medium parameters used: $\sigma = 0$ mho/m, $\epsilon_r = 1$; $\rho = 1000$ kg/m³

Ambient Temperature: 22.0°C

Communication System: GSM 850; Frequency: 836.6 MHz; Duty Cycle: 1:8.3

Probe: EF3DV3 - SN4060;ConvF(1, 1, 1)

GSM850/E Scan - ER3DV6 - 2011: 15 mm from Probe Center to the Device

2/Hearing Aid Compatibility Test (101x101x1): Interpolated grid:

dx=0.5000 mm, dy=0.5000 mm

Device Reference Point: 0, 0, -6.3 mm

Reference Value = 46.65 V/m; Power Drift = -0.01 dB

Applied MIF = 3.45 dB

RF audio interference level = 34.93 dBV/m

Emission category: M4

MIF scaled E-field

Grid 1 M4 33.72 dBV/m	Grid 2 M4 33.89 dBV/m	Grid 3 M4 33.34 dBV/m
Grid 4 M4 34.52 dBV/m	Grid 5 M4 34.93 dBV/m	Grid 6 M4 34.29 dBV/m
Grid 7 M4 35.73 dBV/m	Grid 8 M4 35.94 dBV/m	Grid 9 M4 34.93 dBV/m

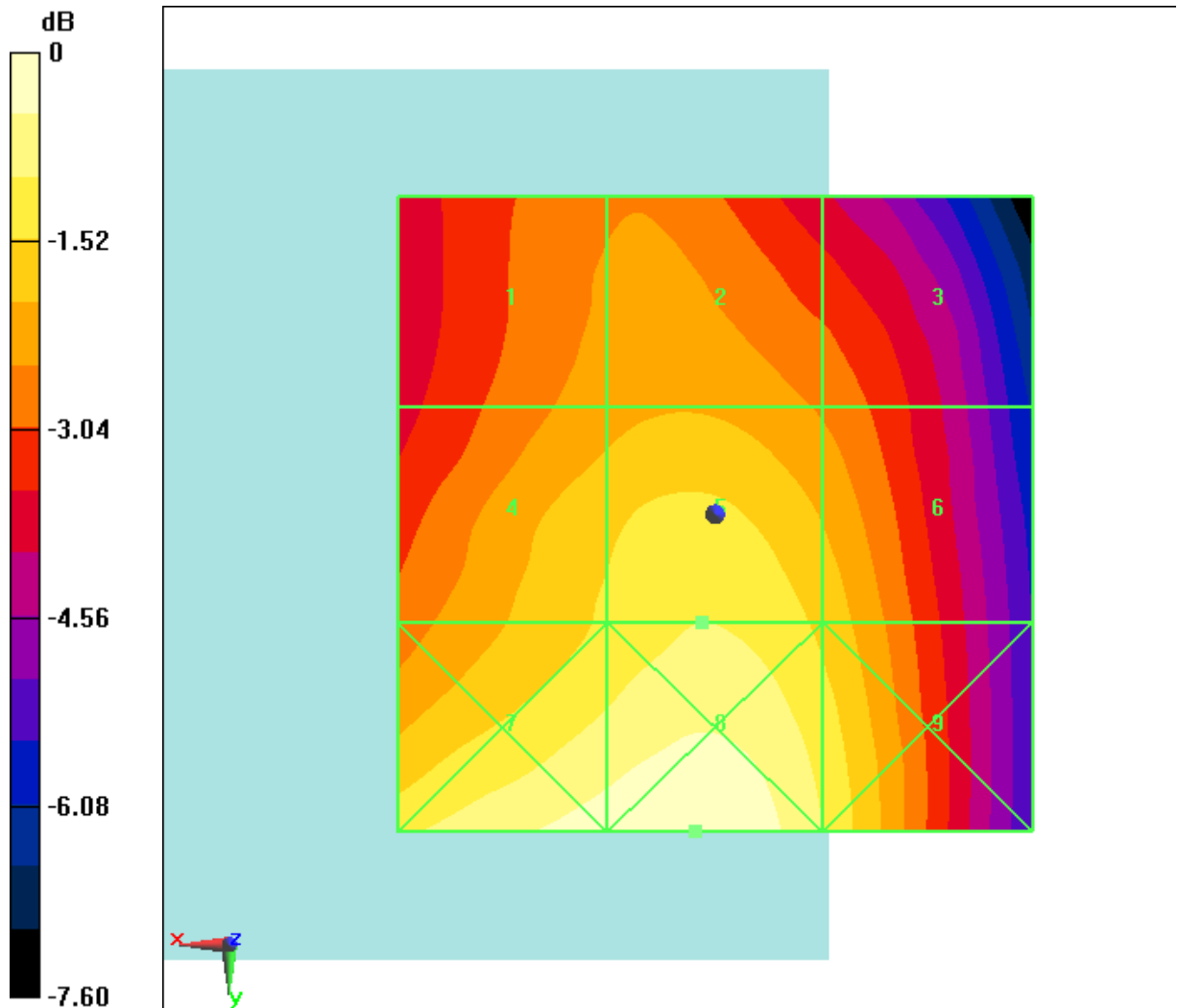

$0 \text{ dB} = 62.68 \text{ V/m} = 35.94 \text{ dBV/m}$

Fig B.2 HAC RF E-Field GSM 850 Middle

HAC RF E-Field GSM 850 Low**Date: 2020-1-12**

Electronics: DAE4 Sn1331

Medium: Air

Medium parameters used: $\sigma = 0$ mho/m, $\epsilon_r = 1$; $\rho = 1000$ kg/m³

Ambient Temperature: 22.0°C

Communication System: GSM 850; Frequency: 824.2 MHz; Duty Cycle: 1:8.3

Probe: EF3DV3 - SN4060;ConvF(1, 1, 1)

GSM850/E Scan - ER3DV6 - 2011: 15 mm from Probe Center to the Device

3/Hearing Aid Compatibility Test (101x101x1): Interpolated grid:

dx=0.5000 mm, dy=0.5000 mm

Device Reference Point: 0, 0, -6.3 mm

Reference Value = 43.51 V/m; Power Drift = 0.01 dB

Applied MIF = 3.50 dB

RF audio interference level = 34.29 dBV/m

Emission category: M4

MIF scaled E-field

Grid 1 M4 32.29 dBV/m	Grid 2 M4 33.31 dBV/m	Grid 3 M4 33.24 dBV/m
Grid 4 M4 33.59 dBV/m	Grid 5 M4 34.29 dBV/m	Grid 6 M4 33.93 dBV/m
Grid 7 M4 34.9 dBV/m	Grid 8 M4 35.22 dBV/m	Grid 9 M4 34.33 dBV/m

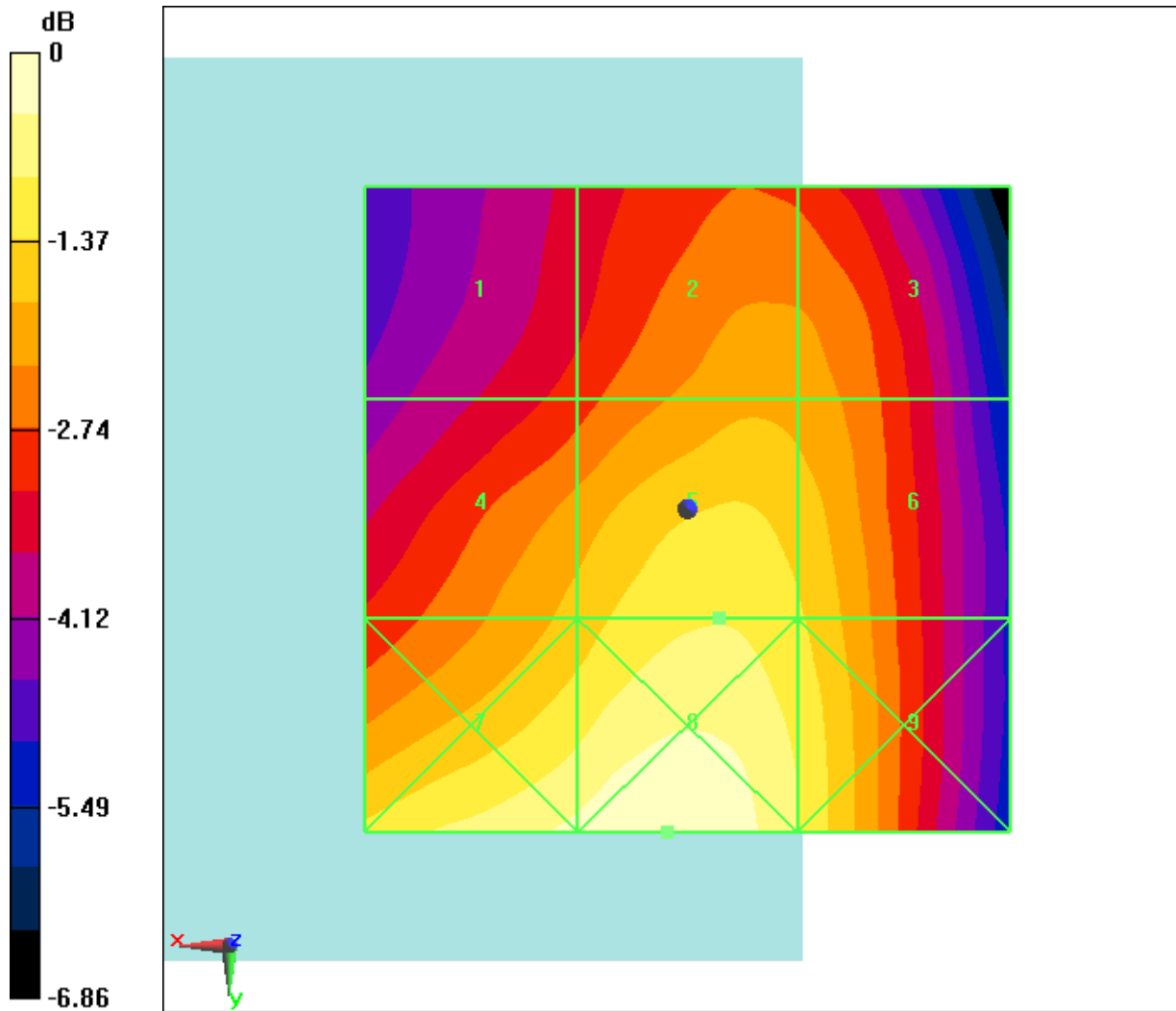

$0 \text{ dB} = 57.68 \text{ V/m} = 35.22 \text{ dBV/m}$

Fig B.3 HAC RF E-Field GSM 850 Low

HAC RF E-Field GSM 1900 High

Date: 2020-1-13

Electronics: DAE4 Sn1331

Medium: Air

Medium parameters used: $\sigma = 0$ mho/m, $\epsilon_r = 1$; $\rho = 1000$ kg/m³

Ambient Temperature: 22.0°C

Communication System: PCS 1900; Frequency: 1909.8 MHz; Duty Cycle: 1:8.3

Probe: EF3DV3 - SN4060;ConvF(1, 1, 1)

GSM1900/E Scan - ER3DV6 - 2011: 15 mm from Probe Center to the

Device/Hearing Aid Compatibility Test (101x101x1): Interpolated grid:

dx=0.5000 mm, dy=0.5000 mm

Device Reference Point: 0, 0, -6.3 mm

Reference Value = 7.498 V/m; Power Drift = 0.17 dB

Applied MIF = 3.50 dB

RF audio interference level = 22.41 dBV/m

Emission category: M4

MIF scaled E-field

Grid 1 M4 19.38 dBV/m	Grid 2 M4 21.27 dBV/m	Grid 3 M4 21 dBV/m
Grid 4 M4 22.09 dBV/m	Grid 5 M4 22.41 dBV/m	Grid 6 M4 20.75 dBV/m
Grid 7 M4 26.23 dBV/m	Grid 8 M4 26.57 dBV/m	Grid 9 M4 24.3 dBV/m

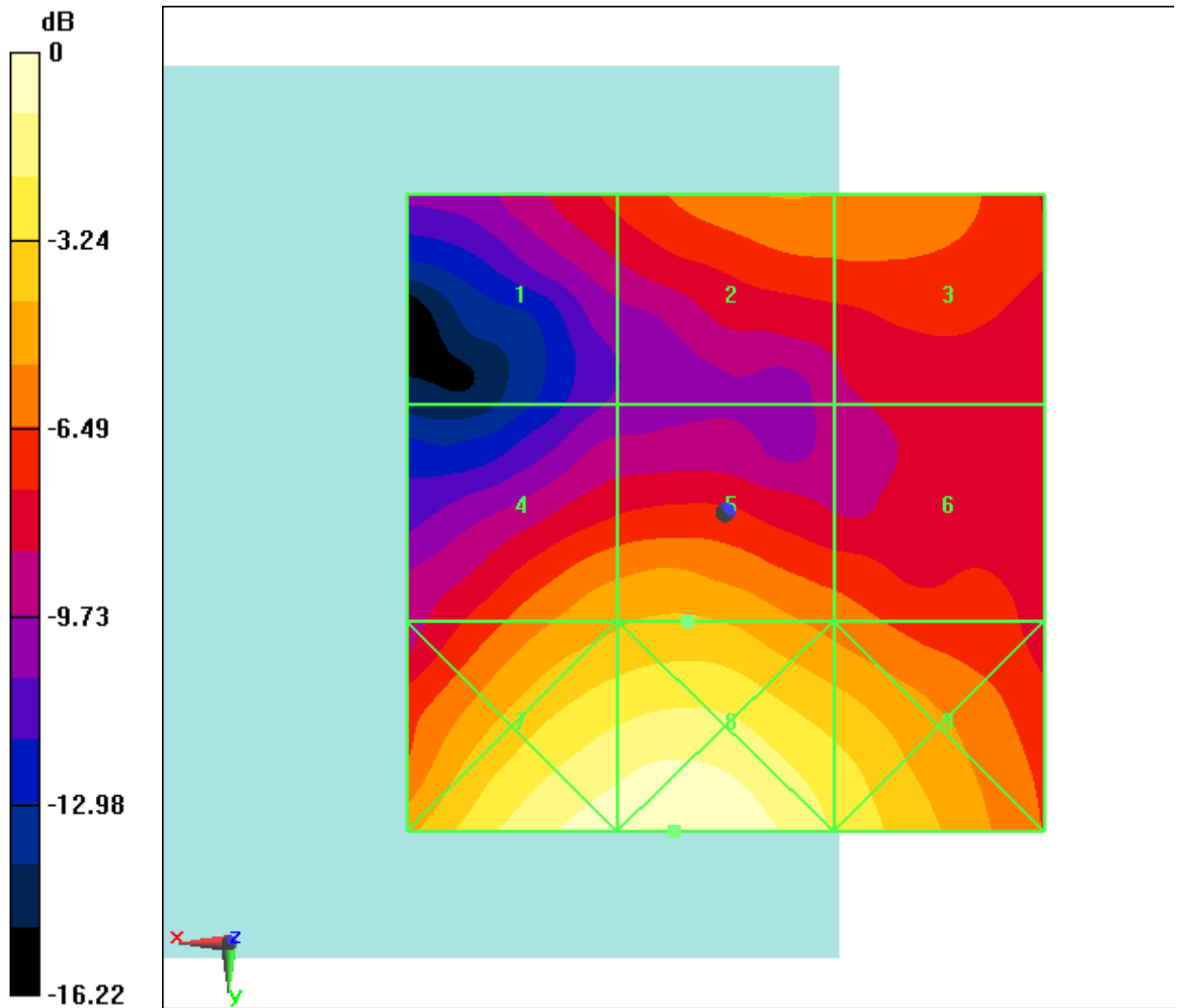

$0 \text{ dB} = 21.30 \text{ V/m} = 26.57 \text{ dBV/m}$

Fig B.4 HAC RF E-Field GSM 1900 High

HAC RF E-Field GSM 1900 Middle**Date: 2020-1-13**

Electronics: DAE4 Sn1331

Medium: Air

Medium parameters used: $\sigma = 0$ mho/m, $\epsilon_r = 1$; $\rho = 1000$ kg/m³

Ambient Temperature: 22.0°C

Communication System: PCS 1900; Frequency: 1880 MHz; Duty Cycle: 1:8.3

Probe: EF3DV3 - SN4060;ConvF(1, 1, 1)

GSM1900/E Scan – ER3DV6 – 2011: 15 mm from Probe Center to the Device

2/Hearing Aid Compatibility Test (101x101x1): Interpolated grid:

dx=0.5000 mm, dy=0.5000 mm

Device Reference Point: 0, 0, -6.3 mm

Reference Value = 7.358 V/m; Power Drift = -0.04 dB

Applied MIF = 3.50 dB

RF audio interference level = 22.08 dBV/m

Emission category: M4

MIF scaled E-field

Grid 1 M4 17.48 dBV/m	Grid 2 M4 20.01 dBV/m	Grid 3 M4 19.86 dBV/m
Grid 4 M4 21.88 dBV/m	Grid 5 M4 22.08 dBV/m	Grid 6 M4 20.28 dBV/m
Grid 7 M4 25.7 dBV/m	Grid 8 M4 25.95 dBV/m	Grid 9 M4 23.84 dBV/m

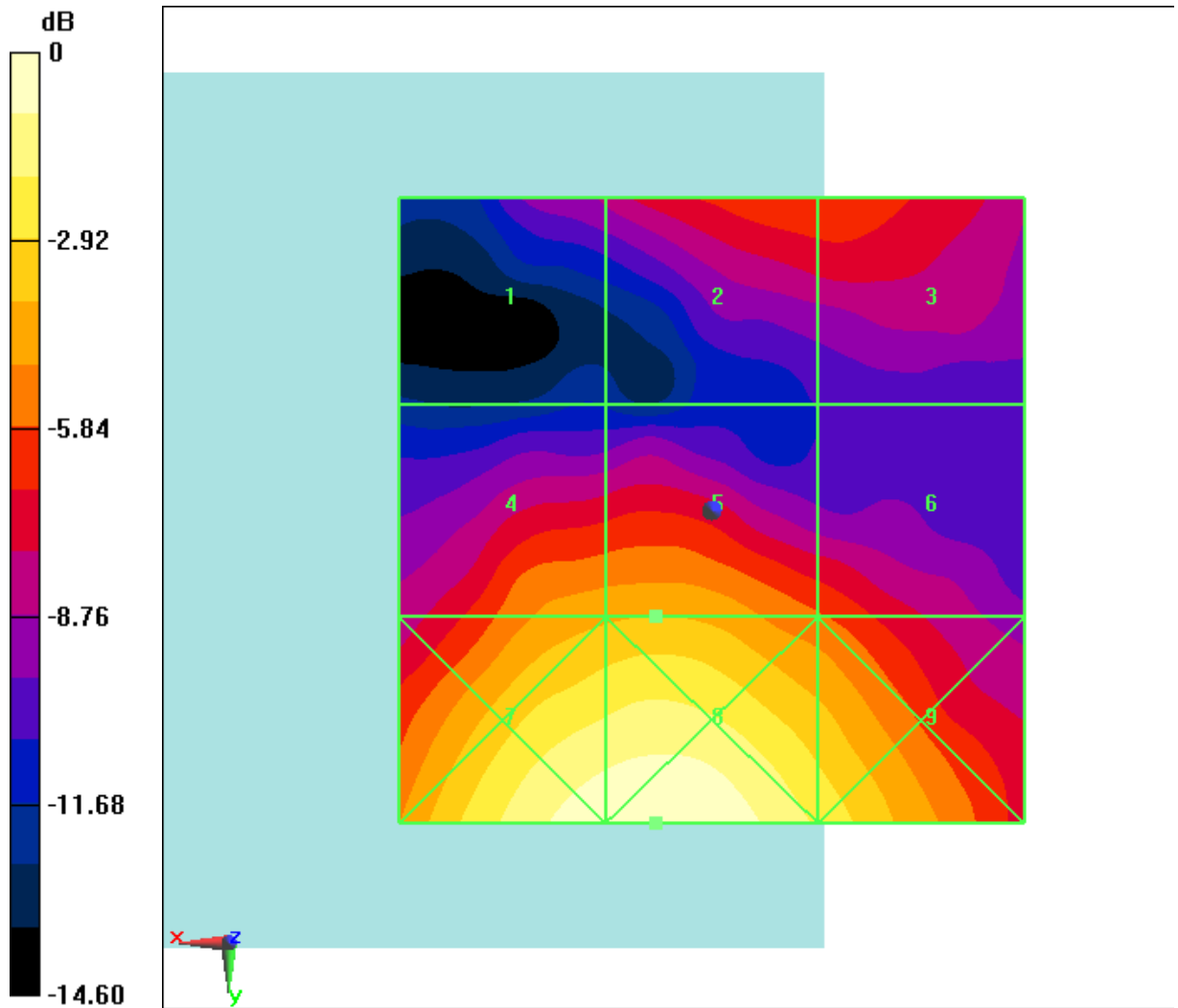

$0 \text{ dB} = 19.83 \text{ V/m} = 25.95 \text{ dBV/m}$

Fig B.5 HAC RF E-Field GSM 1900 Middle

HAC RF E-Field GSM 1900 Low**Date: 2020-1-13**

Electronics: DAE4 Sn1331

Medium: Air

Medium parameters used: $\sigma = 0$ mho/m, $\epsilon_r = 1$; $\rho = 1000$ kg/m³

Ambient Temperature: 22.0°C

Communication System: PCS 1900; Frequency: 1850.2 MHz; Duty Cycle: 1:8.3

Probe: EF3DV3 - SN4060;ConvF(1, 1, 1)

GSM1900/E Scan – ER3DV6 – 2011: 15 mm from Probe Center to the Device

3/Hearing Aid Compatibility Test (101x101x1): Interpolated grid:

dx=0.5000 mm, dy=0.5000 mm

Device Reference Point: 0, 0, -6.3 mm

Reference Value = 6.062 V/m; Power Drift = 0.12 dB

Applied MIF = 3.51 dB

RF audio interference level = 22.11 dBV/m

Emission category: M4

MIF scaled E-field

Grid 1 M4 19.43 dBV/m	Grid 2 M4 20.81 dBV/m	Grid 3 M4 20.43 dBV/m
Grid 4 M4 22.04 dBV/m	Grid 5 M4 22.11 dBV/m	Grid 6 M4 19.46 dBV/m
Grid 7 M4 26.36 dBV/m	Grid 8 M4 26.59 dBV/m	Grid 9 M4 24.17 dBV/m

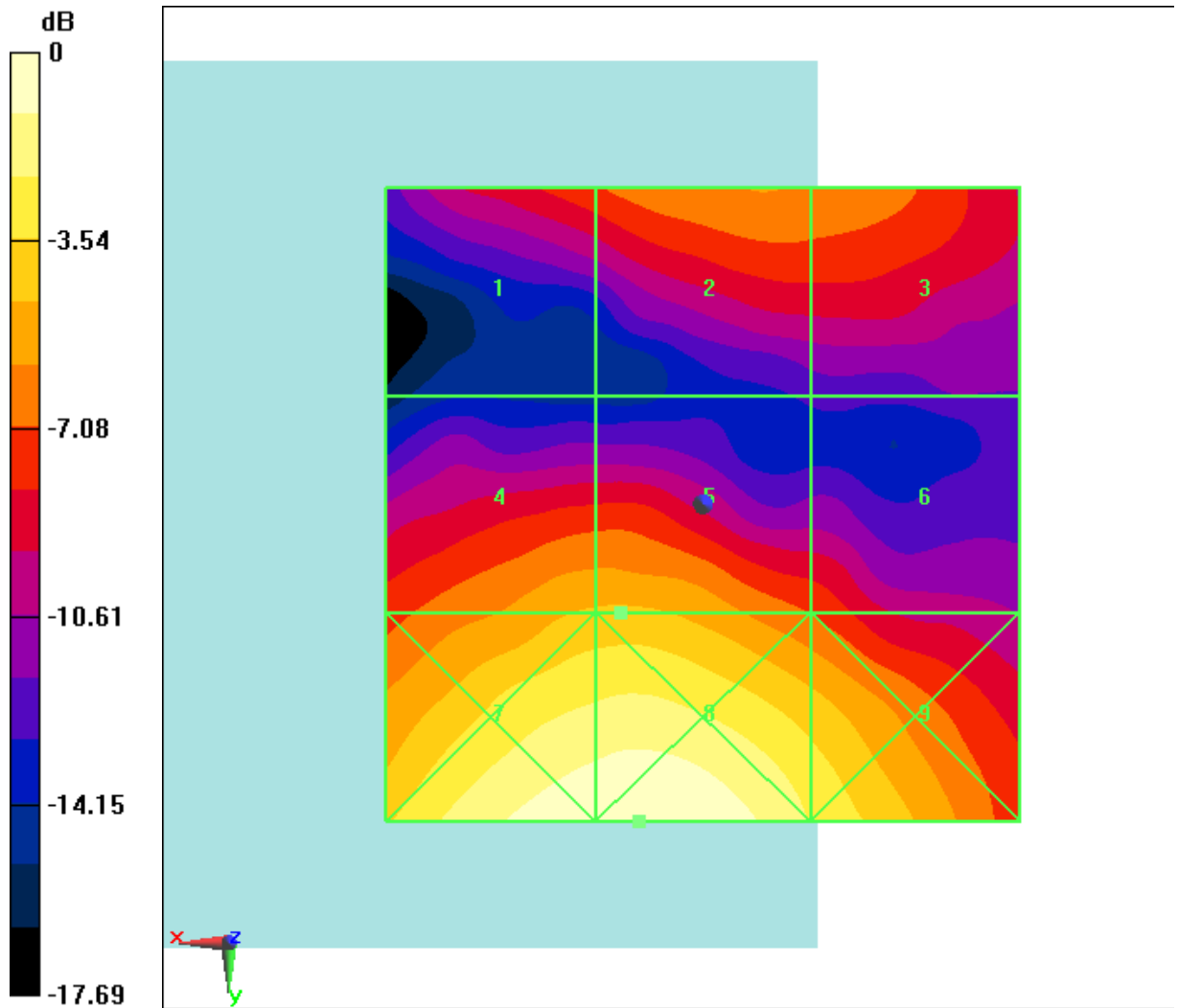

0 dB = 21.36 V/m = 26.59 dBV/m

Fig B.6 HAC RF E-Field GSM 1900 Low

**HAC RF E-Field LTE Band41 QPSK CH41490****Date: 2020-1-14**

Electronics: DAE4 Sn1331

Medium: Air

Medium parameters used: $\sigma = 0$ mho/m, $\epsilon_r = 1$; $\rho = 1000$ kg/m³

Ambient Temperature: 22.0°C

Communication System: LTE Band41; Frequency: 2680 MHz; Duty Cycle: 1:1.58

Probe: EF3DV3 - SN4060;ConvF(1, 1, 1)

B41/E Scan – ER3DV6 – 2011: 15 mm from Probe Center to the Device/Hearing**Aid Compatibility Test (101x101x1):** Interpolated grid: dx=0.5000 mm,

dy=0.5000 mm

Device Reference Point: 0, 0, -6.3 mm

Reference Value = 25.85 V/m; Power Drift = -0.04 dB

Applied MIF = -1.70 dB

RF audio interference level = 24.34 dBV/m

Emission category: M4

MIF scaled E-field

Grid 1 M4 24.42 dBV/m	Grid 2 M4 24.29 dBV/m	Grid 3 M4 23.56 dBV/m
Grid 4 M4 24.12 dBV/m	Grid 5 M4 24.34 dBV/m	Grid 6 M4 23.61 dBV/m
Grid 7 M4 22.07 dBV/m	Grid 8 M4 22.34 dBV/m	Grid 9 M4 21.9 dBV/m

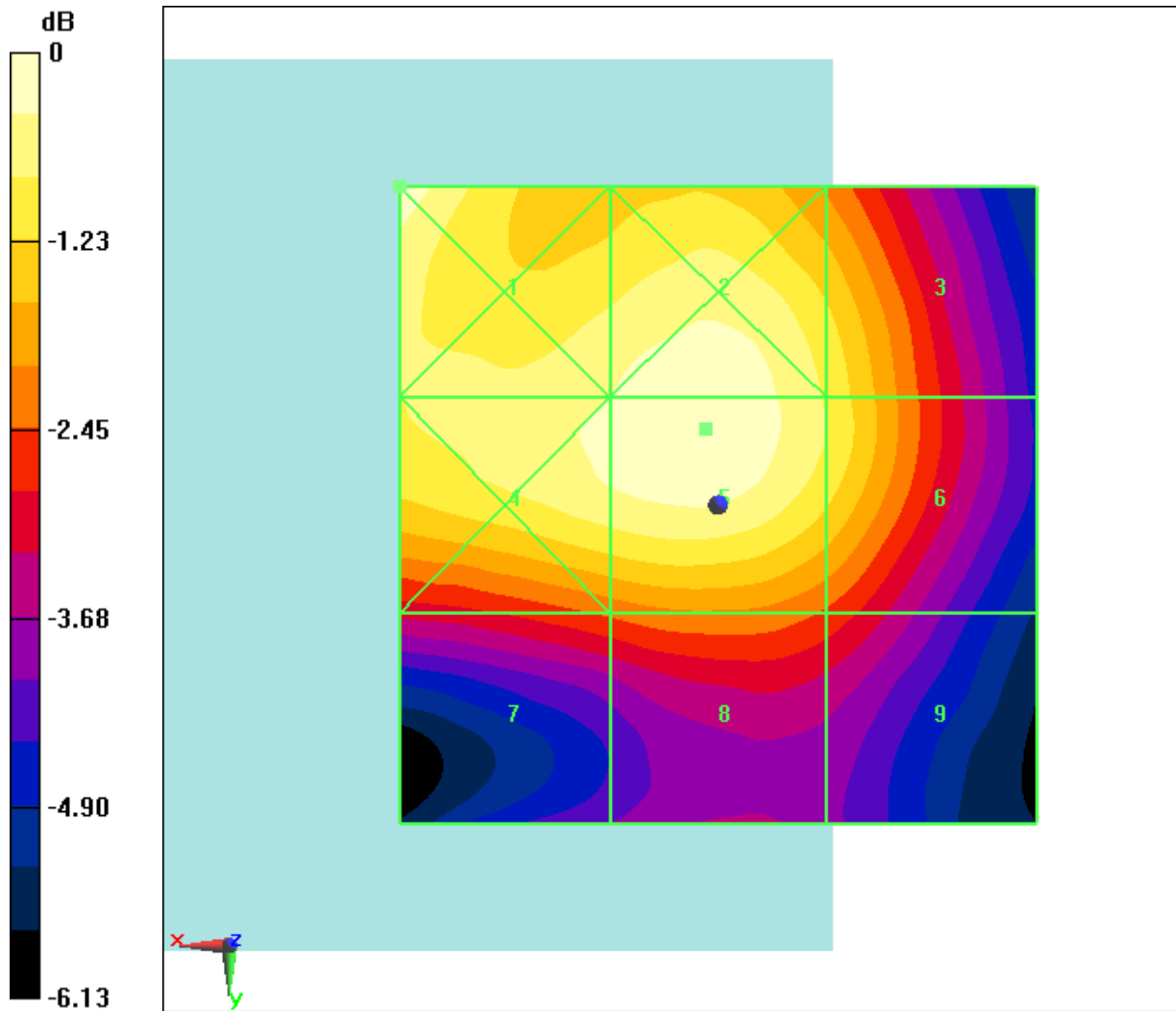

0 dB = 16.64 V/m = 24.42 dBV/m

Fig B.7 HAC RF E-Field LTE Band41 QPSK CH41490

HAC RF E-Field LTE Band41 QPSK CH41055

Date: 2020-1-14

Electronics: DAE4 Sn1331

Medium: Air

Medium parameters used: $\sigma = 0$ mho/m, $\epsilon_r = 1$; $\rho = 1000$ kg/m³

Ambient Temperature: 22.0°C

Communication System: LTE Band41; Frequency: 2636.5 MHz; Duty Cycle: 1:1.58

Probe: EF3DV3 - SN4060;ConvF(1, 1, 1)

B41/E Scan - ER3DV6 - 2011: 15 mm from Probe Center to the Device

2/Hearing Aid Compatibility Test (101x101x1): Interpolated grid:

dx=0.5000 mm, dy=0.5000 mm

Device Reference Point: 0, 0, -6.3 mm

Reference Value = 18.24 V/m; Power Drift = 0.00 dB

Applied MIF = -1.85 dB

RF audio interference level = 21.17 dBV/m

Emission category: **M4**

MIF scaled E-field

Grid 1 M4 22.79 dBV/m	Grid 2 M4 21.56 dBV/m	Grid 3 M4 20.09 dBV/m
Grid 4 M4 21.83 dBV/m	Grid 5 M4 21.17 dBV/m	Grid 6 M4 20.21 dBV/m
Grid 7 M4 19.51 dBV/m	Grid 8 M4 19.93 dBV/m	Grid 9 M4 19.61 dBV/m

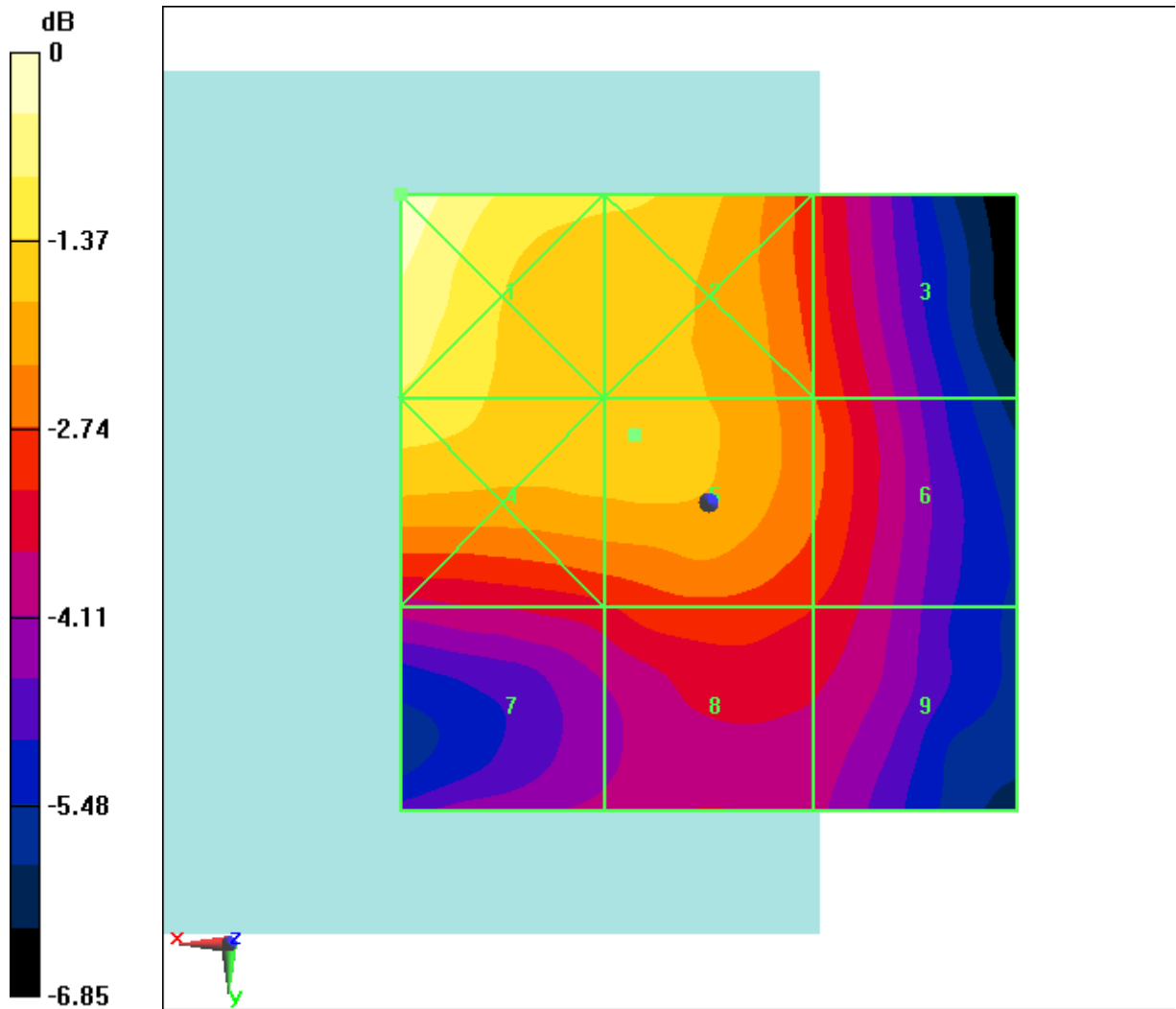

0 dB = 13.79 V/m = 22.79 dBV/m

Fig B.8 HAC RF E-Field LTE Band41 QPSK CH41055

HAC RF E-Field LTE Band41 QPSK CH40620

Date: 2020-1-14

Electronics: DAE4 Sn1331

Medium: Air

Medium parameters used: $\sigma = 0$ mho/m, $\epsilon_r = 1$; $\rho = 1000$ kg/m³

Ambient Temperature: 22.0°C

Communication System: LTE Band41; Frequency: 2593 MHz; Duty Cycle: 1:1.58

Probe: EF3DV3 - SN4060;ConvF(1, 1, 1)

B41/E Scan - ER3DV6 - 2011: 15 mm from Probe Center to the Device

2/Hearing Aid Compatibility Test (101x101x1): Interpolated grid:

dx=0.5000 mm, dy=0.5000 mm

Device Reference Point: 0, 0, -6.3 mm

Reference Value = 18.24 V/m; Power Drift = 0.00 dB

Applied MIF = -1.85 dB

RF audio interference level = 21.17 dBV/m

Emission category: **M4**

MIF scaled E-field

Grid 1 M4 22.79 dBV/m	Grid 2 M4 21.56 dBV/m	Grid 3 M4 20.09 dBV/m
Grid 4 M4 21.83 dBV/m	Grid 5 M4 21.17 dBV/m	Grid 6 M4 20.21 dBV/m
Grid 7 M4 19.51 dBV/m	Grid 8 M4 19.93 dBV/m	Grid 9 M4 19.61 dBV/m

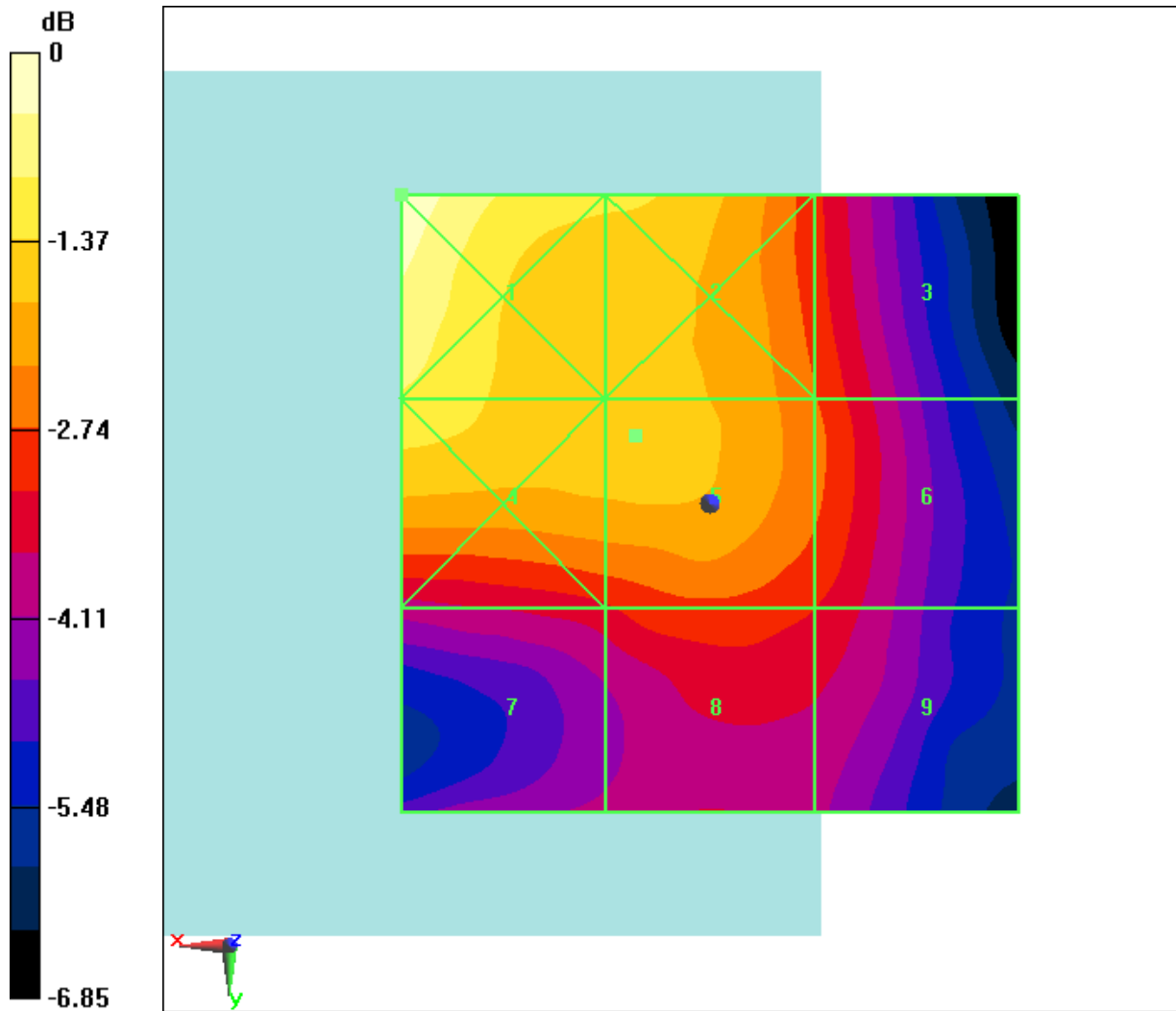

0 dB = 13.79 V/m = 22.79 dBV/m

Fig B.9 HAC RF E-Field LTE Band41 QPSK CH40620

HAC RF E-Field LTE Band41 QPSK CH40185

Date: 2020-1-14

Electronics: DAE4 Sn1331

Medium: Air

Medium parameters used: $\sigma = 0$ mho/m, $\epsilon_r = 1$; $\rho = 1000$ kg/m³

Ambient Temperature: 22.0°C

Communication System: LTE Band41; Frequency: 2549.5 MHz; Duty Cycle: 1:1.58

Probe: EF3DV3 - SN4060;ConvF(1, 1, 1)

B41/E Scan - ER3DV6 - 2011: 15 mm from Probe Center to the Device 3

3/Hearing Aid Compatibility Test (101x101x1): Interpolated grid:

dx=0.5000 mm, dy=0.5000 mm

Device Reference Point: 0, 0, -6.3 mm

Reference Value = 18.55 V/m; Power Drift = 0.01 dB

Applied MIF = -1.73 dB

RF audio interference level = 21.67 dBV/m

Emission category: **M4**

MIF scaled E-field

Grid 1 M4 24.22 dBV/m	Grid 2 M4 22.78 dBV/m	Grid 3 M4 20.56 dBV/m
Grid 4 M4 22.74 dBV/m	Grid 5 M4 21.67 dBV/m	Grid 6 M4 20.66 dBV/m
Grid 7 M4 20.12 dBV/m	Grid 8 M4 20.61 dBV/m	Grid 9 M4 20.28 dBV/m

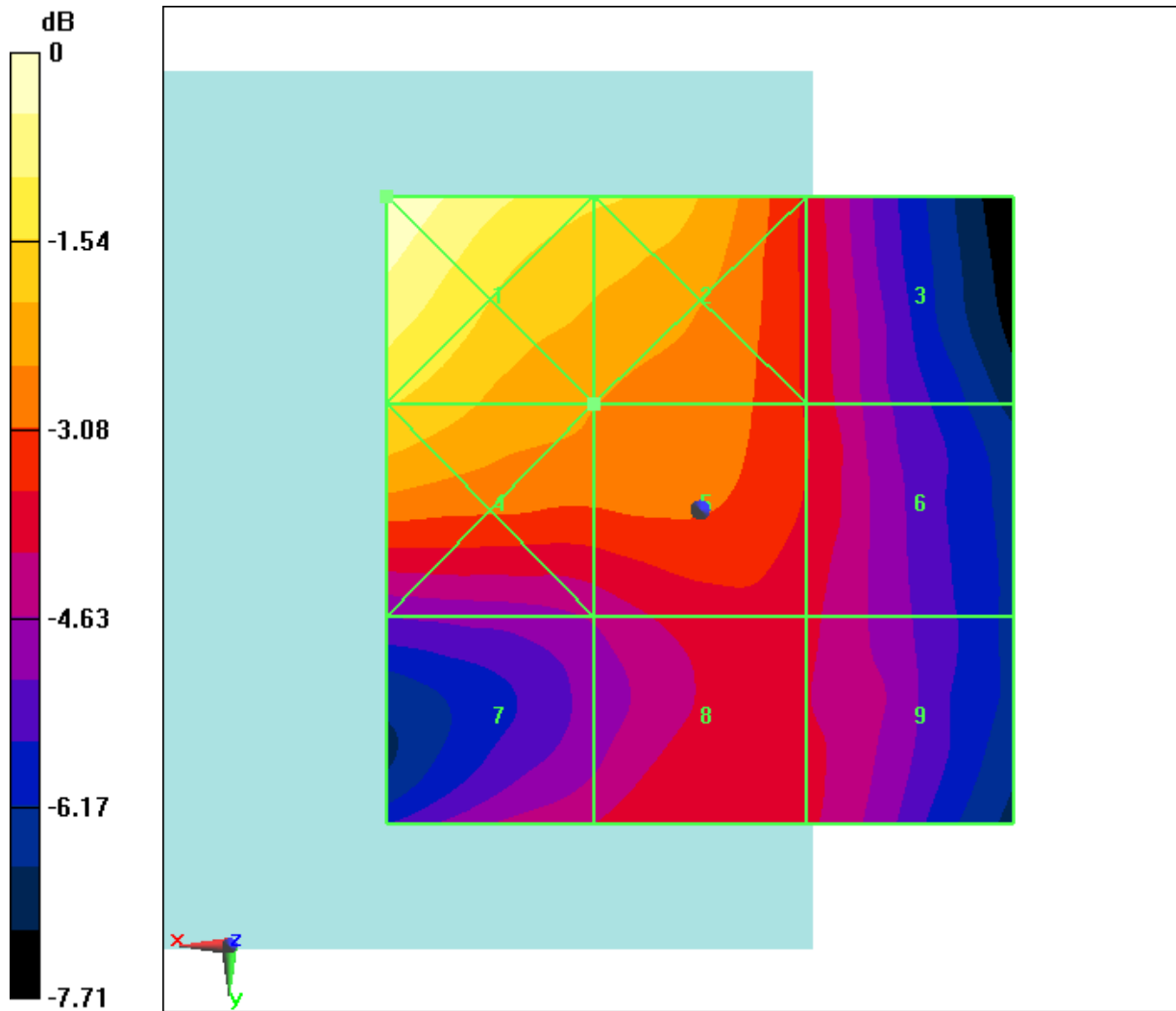

0 dB = 16.25 V/m = 24.22 dBV/m

Fig B.10 HAC RF E-Field LTE Band41 QPSK CH40185

HAC RF E-Field LTE Band41 QPSK CH39750

Date: 2020-1-14

Electronics: DAE4 Sn1331

Medium: Air

Medium parameters used: $\sigma = 0$ mho/m, $\epsilon_r = 1$; $\rho = 1000$ kg/m³

Ambient Temperature: 22.0°C

Communication System: LTE Band41; Frequency: 2506 MHz; Duty Cycle: 1:1.58

Probe: EF3DV3 - SN4060;ConvF(1, 1, 1)

B41/E Scan - ER3DV6 - 2011: 15 mm from Probe Center to the Device 3

2/Hearing Aid Compatibility Test (101x101x1): Interpolated grid:

dx=0.5000 mm, dy=0.5000 mm

Device Reference Point: 0, 0, -6.3 mm

Reference Value = 23.30 V/m; Power Drift = 0.05 dB

Applied MIF = -1.70 dB

RF audio interference level = 23.37 dBV/m

Emission category: **M4**

MIF scaled E-field

Grid 1 M4 25.76 dBV/m	Grid 2 M4 23.82 dBV/m	Grid 3 M4 22.44 dBV/m
Grid 4 M4 24.06 dBV/m	Grid 5 M4 23.37 dBV/m	Grid 6 M4 22.59 dBV/m
Grid 7 M4 21.58 dBV/m	Grid 8 M4 22.13 dBV/m	Grid 9 M4 21.79 dBV/m