



FCC RF Test Report

APPLICANT : TCL Communication Ltd
EQUIPMENT : GSM Quad-band / UMTS Quad-band /
LTE 6 band mobile phone
BRAND NAME : ALCATEL ONETOUCH
MODEL NAME : 6045B
MARKETING NAME : ALCATEL ONETOUCH IDOL 3 (5.5)
FCC ID : 2ACCJN001
STANDARD : FCC Part 15 Subpart E §15.407
CLASSIFICATION : (NII) Unlicensed National Information
Infrastructure

The product was received on Jan. 13, 2015 and testing was completed on Feb. 20, 2015. We, SPORTON INTERNATIONAL (KUNSHAN) INC., would like to declare that the tested sample has been evaluated in accordance with the test procedures and has been in compliance with the applicable technical standards.

The test results in this report apply exclusively to the tested model / sample. Without written approval of SPORTON INTERNATIONAL (KUNSHAN) INC., the test report shall not be reproduced except in full.

Reviewed by: Joseph Lin / Supervisor

Approved by: Jones Tsai / Manager



SPORTON INTERNATIONAL (KUNSHAN) INC.
No. 3-2, PingXiang Road, Kunshan, Jiangsu Province, P. R. China



TABLE OF CONTENTS

REVISION HISTORY..... 3

SUMMARY OF TEST RESULT 4

1 GENERAL DESCRIPTION 5

 1.1 Applicant 5

 1.2 Manufacturer 5

 1.3 Feature of Equipment Under Test 5

 1.4 Product Specification of Equipment Under Test 5

 1.5 Modification of EUT 6

 1.6 Testing Location 6

 1.7 Applicable Standards 6

2 TEST CONFIGURATION OF EQUIPMENT UNDER TEST 7

 2.1 Carrier Frequency and Channel 7

 2.2 Pre-Scanned RF Power 8

 2.3 Test Mode 9

 2.4 Connection Diagram of Test System 10

 2.5 Support Unit used in test configuration and system 11

 2.6 EUT Operation Test Setup 11

 2.7 Measurement Results Explanation Example 12

3 TEST RESULT 13

 3.1 6dB Bandwidth Measurement 13

 3.2 Maximum Conducted Output Power Measurement 15

 3.3 Power Spectral Density Measurement 16

 3.4 Unwanted Emissions Measurement 19

 3.5 AC Conducted Emission Measurement 23

 3.6 Frequency Stability Measurement 27

 3.7 Automatically Discontinue Transmission 28

 3.8 Antenna Requirements 29

4 LIST OF MEASURING EQUIPMENT 30

5 UNCERTAINTY OF EVALUATION 31

APPENDIX A. CONDUCTED TEST RESULTS

APPENDIX B. RADIATED TEST RESULTS

APPENDIX C. SETUP PHOTOGRAPHS



REVISION HISTORY

REPORT NO.	VERSION	DESCRIPTION	ISSUED DATE
FR511301F	Rev. 01	Initial issue of report	Apr. 06, 2015
FR511301F	Rev. 02	Revised the equipment to "GSM Quad-band / UMTS Quad-band / LTE 6 band mobile phone".	Apr. 14, 2015
FR511301F	Rev. 03	Update report for revising Brand Name to ALCATEL ONETOUCH	Apr. 20, 2015



SUMMARY OF TEST RESULT

Report Section	FCC Rule	Description	Limit	Result	Remark
3.1	15.403(i)	6dB Bandwidth	> 500kHz	Pass	-
3.2	15.407(a)	Maximum Conducted Output Power	≤ 30 dBm	Pass	-
3.3	15.407(a)	Power Spectral Density	≤ 30 dBm/500kHz	Pass	-
3.4	15.407(b)	Unwanted Emissions	≤ -17, -27 dBm/MHz & 15.209(a)	Pass	Under limit 4.63 dB at 5714.040 MHz
3.5	15.207	AC Conducted Emission	15.207(a)	Pass	Under limit 5.18 dB at 0.520 MHz
3.6	15.407(g)	Frequency Stability	Within Operation Band	Pass	-
3.7	15.407(c)	Automatically Discontinue Transmission	Discontinue Transmission	Pass	-
3.8	15.203 & 15.407(a)	Antenna Requirement	N/A	Pass	-



1 General Description

1.1 Applicant

TCL Communication Ltd

FLAT/RM 1910-12A BLOCK 3 19/F CHINA HONG KONG CITY 33 CANTON ROAD TSIMSHATSUI KL

1.2 Manufacturer

TCL Communication Ltd

FLAT/RM 1910-12A BLOCK 3 19/F CHINA HONG KONG CITY 33 CANTON ROAD TSIMSHATSUI KL

1.3 Feature of Equipment Under Test

Product Feature	
Equipment	GSM Quad-band / UMTS Quad-band / LTE 6 band mobile phone
Brand Name	ALCATEL ONETOUCH
Model Name	6045B
Marketing Name	ALCATEL ONETOUCH IDOL 3 (5.5)
FCC ID	2ACCJN001
EUT supports Radios application	GSM/EGPRS/WCDMA/HSPA/ HSPA+(Downlink Only)/DC-HSDPA/LTE/NFC/ WLAN 2.4GHz 802.11b/g/n HT20/ WLAN 5GHz 802.11a/HT20/HT40/ Bluetooth v3.0 + EDR/Bluetooth v4.1 LE
HW Version	PIO
SW Version	7S25
EUT Stage	Identical Prototype

Remark: The above EUT's information was declared by manufacturer. Please refer to the specifications or user's manual for more detailed description.

1.4 Product Specification of Equipment Under Test

Product Specification subjective to this standard	
Tx/Rx Channel Frequency Range	5725 MHz ~ 5850 MHz
Maximum Output Power	802.11a : 13.35 dBm / 0.0216 W 802.11n HT20 : 11.80 dBm / 0.0151 W 802.11n HT40 : 11.79 dBm / 0.0151 W
Antenna Type / Gain	PIFA Antenna with gain 0 dBi
Type of Modulation	OFDM (BPSK / QPSK / 16QAM / 64QAM)



1.5 Modification of EUT

No modifications are made to the EUT during all test items.

1.6 Testing Location

Test Site	SPORTON INTERNATIONAL (KUNSHAN) INC.			
Test Site Location	No. 3-2, PingXiang Road, Kunshan, Jiangsu Province, P. R. China TEL: +86-0512-5790-0158 FAX: +86-0512-5790-0958			
Test Site No.	Sporton Site No.			FCC Registration No.
	TH01-KS	03CH01-KS	CO01-KS	149928

Note: The test site complies with ANSI C63.4 2009 requirement.

1.7 Applicable Standards

According to the specifications of the manufacturer, the EUT must comply with the requirements of the following standards:

- ♦ FCC Part 15 Subpart E
- ♦ FCC KDB 789033 D02 General UNII Test Procedures New Rules v01
- ♦ ANSI C63.10-2009

Remark:

1. All test items were verified and recorded according to the standards and without any deviation during the test.
2. This EUT has also been tested and complied with the requirements of FCC Part 15, Subpart B, recorded in a separate test report.



2 Test Configuration of Equipment Under Test

The EUT has been associated with peripherals and configuration operated in a manner tended to maximize its emission characteristics in a typical application. Frequency range investigated: conducted emission (150 kHz to 30 MHz) and radiated emission (9 kHz to the 10th harmonic of the highest fundamental frequency or to 40 GHz, whichever is lower). For radiated measurement, pre-scanned in three orthogonal panels, X, Y, Z. The worst cases (Y plane) were recorded in this report.

The final configuration from all the combinations and the worst-case data rates were investigated by measuring the maximum power across all the data rates and modulation modes under section 2.2.

Based on the worst configuration found above, the RF power setting is set individually to meet FCC compliance limit for the final conducted and radiated tests shown in section 2.3.

2.1 Carrier Frequency and Channel

Frequency Band	Channel	Freq. (MHz)	Channel	Freq. (MHz)
5725-5850 MHz Band 4 (U-NII-3)	149	5745	159	5795
	151	5755	161	5805
	153	5765	165	5825
	157	5785		

Note: The above Frequency and Channel in boldface were 802.11n HT40.



2.2 Pre-Scanned RF Power

Preliminary tests were performed in different data rate and data rate associated with the highest power were chosen for full test in the following tables. Final Output Power equals to Measured Output Power adds the duty factor.

WLAN 5GHz 802.11a Output Power (dBm)										
Power vs. Channel			Power vs. Data Rate							
Channel	Frequency (MHz)	Data Rate	Channel	9Mbps	12Mbps	18Mbps	24Mbps	36Mbps	48Mbps	54Mbps
		6Mbps								
CH 149	5745	13.05	CH 157	13.24	13.22	13.28	13.26	13.30	13.34	13.28
CH 157	5785	13.35								
CH 165	5825	12.80								

WLAN 5GHz 802.11n-HT20 Output Power (dBm)										
Power vs. Channel			Power vs. Data Rate							
Channel	Frequency (MHz)	MCS Index	Channel	MCS1	MCS2	MCS3	MCS4	MCS5	MCS6	MCS7
		MCS0								
CH 149	5745	11.41	CH 157	11.77	11.73	11.59	11.66	11.72	11.74	11.77
CH 157	5785	11.80								
CH 165	5825	11.30								

WLAN 5GHz 802.11n-HT40 Output Power (dBm)										
Power vs. Channel			Power vs. Data Rate							
Channel	Frequency (MHz)	MCS Index	Channel	MCS1	MCS2	MCS3	MCS4	MCS5	MCS6	MCS7
		MCS0								
CH 151	5755	11.51	CH 159	11.69	11.64	11.77	11.76	11.74	11.77	11.74
CH 159	5795	11.79								



2.3 Test Mode

Final test mode of conducted test items and radiated spurious emissions are considering the modulation and worse data rates from the power table described in section 2.2.

Modulation	Data Rate
802.11a	6 Mbps
802.11n HT20	MCS0
802.11n HT40	MCS0

AC Conducted Emission	Mode 1 : GSM850 Idle + Bluetooth Link + WLAN (5GHz) Link + USB Cable 1 (Charging from Adapter 1) + Earphone + Battery 1
Remark: For Radiated TCs, the tests were performed with adapter 1, USB cable 1, battery 1 and earphone.	

Ch. #		Band IV : 5725-5850 MHz		
		802.11a	802.11n HT20	802.11n HT40
L	Low	149	149	151
M	Middle	157	157	-
H	High	165	165	159

2.4 Connection Diagram of Test System

<WLAN Tx Mode>

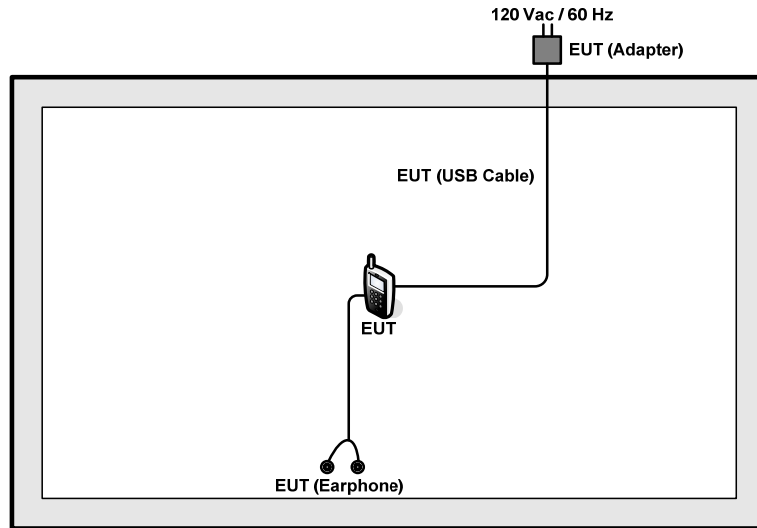

<AC Conducted Emission Mode>

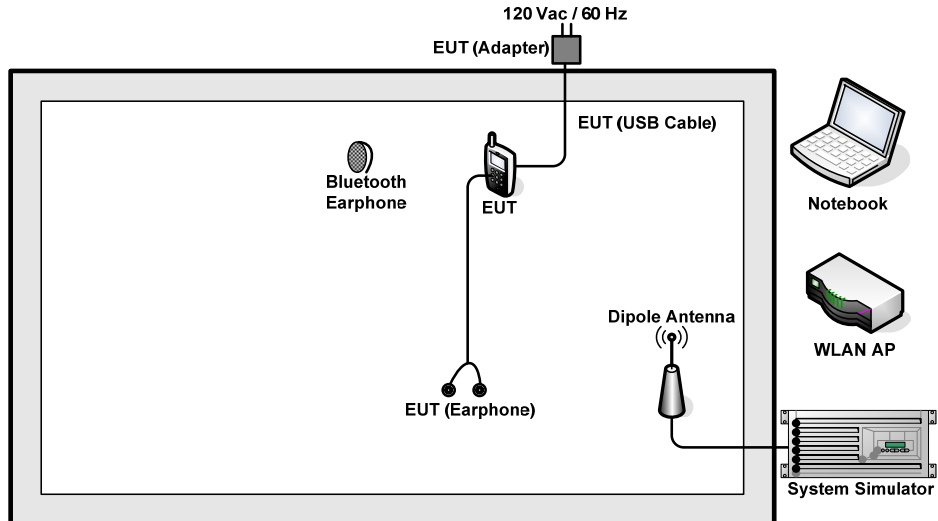



2.5 Support Unit used in test configuration and system

Item	Equipment	Trade Name	Model Name	FCC ID	Data Cable	Power Cord
1.	System Simulator	Anritsu	MT8820C	N/A	N/A	Unshielded, 1.8 m
2.	WLAN AP	D-Link	DIR-855	KA2DIR855A2	N/A	Unshielded, 1.8 m
3.	Notebook	Lenovo	G480	PRC4	N/A	AC I/P: Unshielded, 1.8 m DC O/P: Shielded, 1.8 m
4.	Bluetooth Earphone	Nokia	BH-102	PYAHS-107W	N/A	N/A
5.	DC Power Supply	GW INSTEK	GPD-2303S	N/A	N/A	Unshielded, 1.8 m

2.6 EUT Operation Test Setup

For WLAN RF test items, an engineering test program was provided and enabled to make EUT continuously transmit/receive.

For AC power line conducted emissions, the EUT was set to connect with the WLAN AP under large package sizes transmission.



2.7 Measurement Results Explanation Example

For all conducted test items:

The offset level is set in the spectrum analyzer to compensate the RF cable loss between EUT conducted output port and spectrum analyzer. With the offset compensation, the spectrum analyzer reading level is exactly the EUT RF output level.

Example:

The spectrum analyzer offset is derived from RF cable loss.

Offset = RF cable loss.

Following shows an offset computation example with cable loss 7 dB.

$$\begin{aligned} \text{Offset (dB)} &= \text{RF cable loss (dB)}. \\ &= 7 \text{ (dB)} \end{aligned}$$

3 Test Result

3.1 6dB Bandwidth Measurement

3.1.1 Description of 6dB Bandwidth

The minimum 6 dB bandwidth shall be at least 500 kHz.

3.1.2 Measuring Instruments

The measuring equipment is listed in the section 4 of this test report.

3.1.3 Test Procedures

1. The testing follows FCC KDB 789033 D02 General UNII Test Procedures New Rules v01. Section C) Emission bandwidth for the band 5.725-5.85GHz
2. Set RBW = 100kHz.
3. Set the VBW $\geq 3 \times$ RBW.
4. Detector = Peak.
5. Trace mode = max hold
6. Measure the maximum width of the emission that is 6 dB down from the peak of the emission.
7. Measure and record the results in the test report.

3.1.4 Test Setup

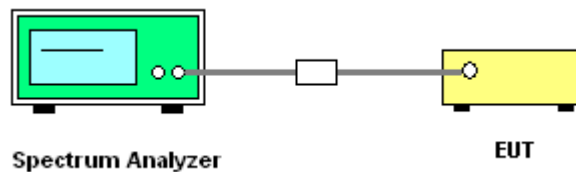



3.1.5 Test Result of 6dB Bandwidth

Please refer to Appendix A.

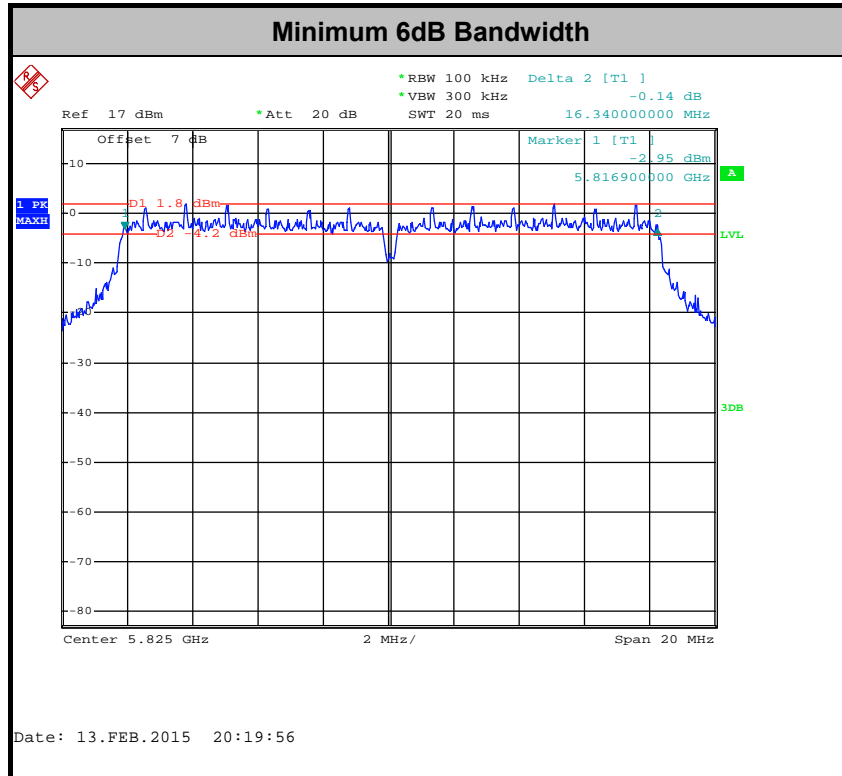

Note: The occupied channel bandwidth is maintained within the band of operation for all of the modulations.

3.2 Maximum Conducted Output Power Measurement

3.2.1 Limit of Maximum Conducted Output Power

<FCC 14-30 CFR 15.407>

For the band 5.725–5.85 GHz, the maximum conducted output power over the frequency band of operation shall not exceed 1 W.

If transmitting antennas of directional gain greater than 6 dBi are used, the peak output power shall be reduced by the amount in dB that the directional gain of the antenna exceeds 6 dBi.

3.2.2 Measuring Instruments

The measuring equipment is listed in the section 4 of this test report.

3.2.3 Test Procedures

The testing follows Method PM of FCC KDB 789033 D02 General UNII Test Procedures New Rules v01.

Method PM (Measurement using an RF average power meter):

1. Measurement is performed using a wideband RF power meter.
2. The EUT is configured to transmit continuously with a consistent duty cycle at its maximum power control level.
3. Measure the average power of the transmitter, and the average power is corrected with duty factor, $10 \log(1/x)$, where x is the duty cycle.

3.2.4 Test Setup

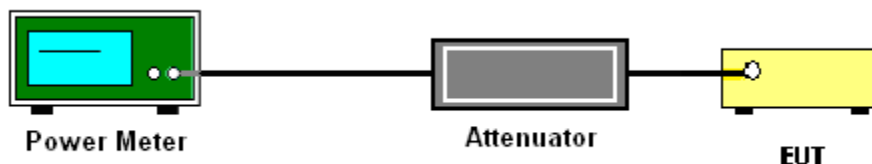

3.2.5 Test Result of Maximum Conducted Output Power

Please refer to Appendix A.



3.3 Power Spectral Density Measurement

3.3.1 Limit of Power Spectral Density

<FCC 14-30 CFR 15.407>

For the band 5.725–5.85 GHz, the maximum power spectral density shall not exceed 30 dBm in any 500-kHz band.

If transmitting antennas of directional gain greater than 6 dBi are used, the peak output power shall be reduced by the amount in dB that the directional gain of the antenna exceeds 6 dBi.

3.3.2 Measuring Instruments

The measuring equipment is listed in the section 4 of this test report.

3.3.3 Test Procedures

The testing follows FCC KDB 789033 D02 General UNII Test Procedures New Rules v01. Section F) Maximum power spectral density.

Method SA-2

(trace averaging across on and off times of the EUT transmissions, followed by duty cycle correction).

1. The testing follows Method SA-2 of FCC KDB 789033 D01 General UNII Test Procedures v01r03.
 - Measure the duty cycle.
 - Set span to encompass the entire emission bandwidth (EBW) of the signal.
 - Set RBW = 300 kHz.
 - Set VBW \geq 1 MHz.
 - Number of points in sweep \geq 2 Span / RBW.
 - Sweep time = auto.
 - Detector = RMS
 - Trace average at least 100 traces in power averaging mode.
 - Add $10 \log(500\text{kHz}/\text{RBW})$ to the test result.
 - Add $10 \log(1/x)$, where x is the duty cycle, to the measured power in order to compute the average power during the actual transmission times. For example, add $10 \log(1/0.25) = 6$ dB if the duty cycle is 25 percent.

2. The RF output of EUT was connected to the spectrum analyzer by a low loss cable.
3. Each plot has already offset with cable loss, and attenuator loss. Measure the PPSD and record it.

3.3.4 Test Setup

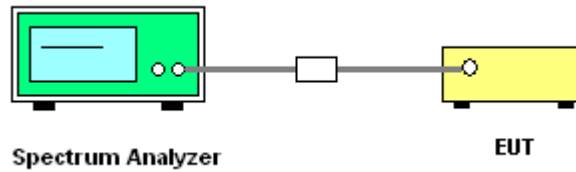



3.3.5 Test Result of Power Spectral Density

Please refer to Appendix A.

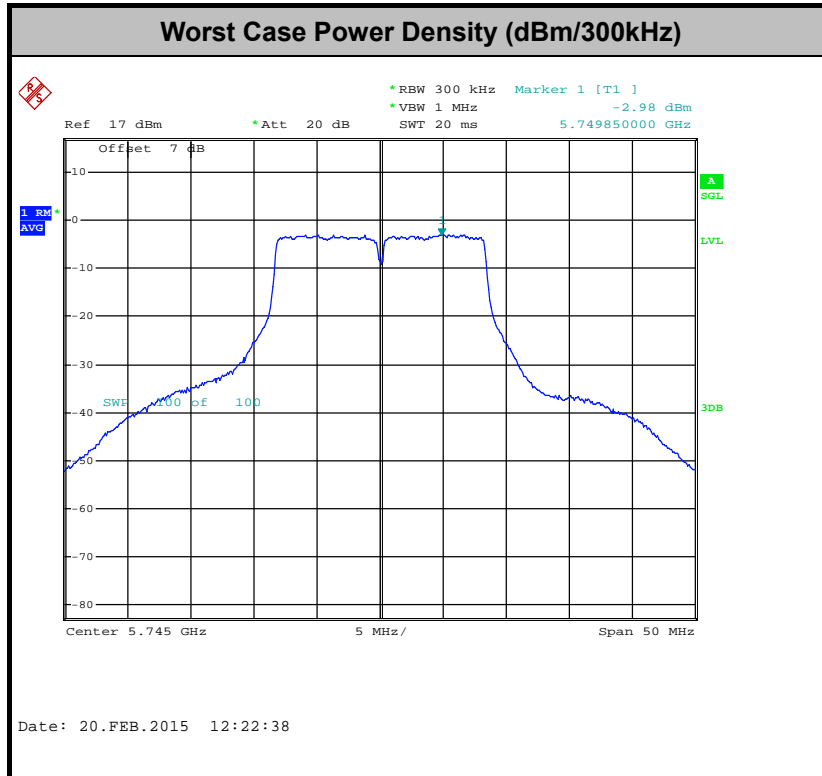



3.4 Unwanted Emissions Measurement

This section as specified in FCC Part 15.407(b) is to measure unwanted emissions through radiated measurement for band edge spurious emissions and out of band emissions measurement. The unwanted emissions shall comply with 15.407(b)(1) to (6), and restricted bands per FCC Part15.205.

3.4.1 Limit of Unwanted Emissions

- (1) For transmitters operating in the 5725-5850 MHz band: all emissions within the frequency range from the band edge to 10 MHz above or below the band edge shall not exceed an EIRP of -17 dBm/MHz (78.3dBμV/m); for frequencies 10 MHz or greater above or below the band edge, emissions shall not exceed an EIRP of -27 dBm/MHz (68.3dBμV/m).
- (2) Unwanted spurious emissions fallen in restricted bands per FCC Part15.205 shall comply with the general field strength limits set forth in § 15.209 as below table,

Frequency (MHz)	Field Strength (microvolts/meter)	Measurement Distance (meters)
0.009 – 0.490	2400/F(kHz)	300
0.490 – 1.705	24000/F(kHz)	30
1.705 – 30.0	30	30
30 – 88	100	3
88 – 216	150	3
216 - 960	200	3
Above 960	500	3

Note: The following formula is used to convert the EIRP to field strength.

$$E = \frac{1000000\sqrt{30P}}{3} \mu\text{V/m, where P is the eirp (Watts)}$$

EIRP (dBm)	Field Strength at 3m (dBμV/m)
-17	78.3
- 27	68.3

- (3) KDB789033 v01r03 H)2)c)(i) As specified in 15.407(b), emissions above 1000 MHz that are outside of the restricted bands are subject to a peak emission limit of -27 dBm/MHz (or -17 dBm/MHz as specified in 15.407(b)(4)). However, an out-of-band emission that complies with both the average and peak limits of 15.209 is not required to satisfy the -27 dBm/MHz or -17 dBm/MHz peak emission limit.



3.4.2 Measuring Instruments

The measuring equipment is listed in the section 4 of this test report.

3.4.3 Test Procedures

1. The testing follows FCC KDB 789033 D02 General UNII Test Procedures New Rules v01. Section G) Unwanted emissions measurement.

(1) Procedure for Unwanted Emissions Measurements Below 1000MHz

- RBW = 120 kHz
- VBW = 300 kHz
- Detector = Peak
- Trace mode = max hold

(2) Procedure for Peak Unwanted Emissions Measurements Above 1000 MHz

- RBW = 1 MHz
- VBW ≥ 3 MHz
- Detector = Peak
- Sweep time = auto
- Trace mode = max hold

(3) Procedures for Average Unwanted Emissions Measurements Above 1000MHz

- RBW = 1 MHz
- VBW = 10 Hz, when duty cycle is no less than 98 percent.
- $VBW \geq 1/T$, when duty cycle is less than 98 percent where T is the minimum transmission duration over which the transmitter is on and is transmitting at its maximum power control level for the tested mode of operation.

Band	Duty Cycle (%)	T(ms)	1/T(kHz)	VBW Setting
802.11a	87.26	1.37	0.73	1kHz
802.11n HT20	86.62	1.28	0.78	1kHz
802.11n HT40	76.30	0.64	1.55	3kHz

2. The EUT was placed on a turntable with 0.8 meter above ground.
3. The EUT was set 3 meters from the interference receiving antenna which was mounted on the top of a variable height antenna tower.
4. The antenna is a broadband antenna and its height is adjusted between one meter and four meters above ground to find the maximum value of the field strength for both horizontal polarization and vertical polarization of the antenna.
5. For each suspected emission, the EUT was arranged to its worst case and then adjust the antenna tower (from 1 m to 4 m) and turntable (from 0 degree to 360 degrees) to find the maximum reading.
6. For testing below 1GHz, if the emission level of the EUT in peak mode was 3 dB lower than the limit specified, then peak values of EUT will be reported, otherwise, the emissions will be repeated one by one using the CISPR quasi-peak method and reported.
7. For testing above 1GHz, the emission level of the EUT in peak mode was 20dB lower than average limit (that means the emission level in average mode also complies with the limit in average mode), then peak values of EUT will be reported, otherwise, the emissions will be measured in average mode again and reported.

3.4.4 Test Setup

For radiated emissions below 30MHz

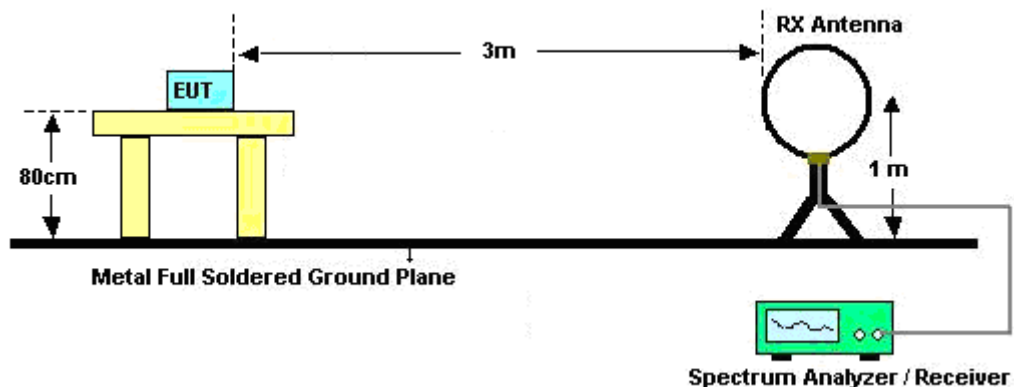

For radiated emissions from 30MHz to 1GHz

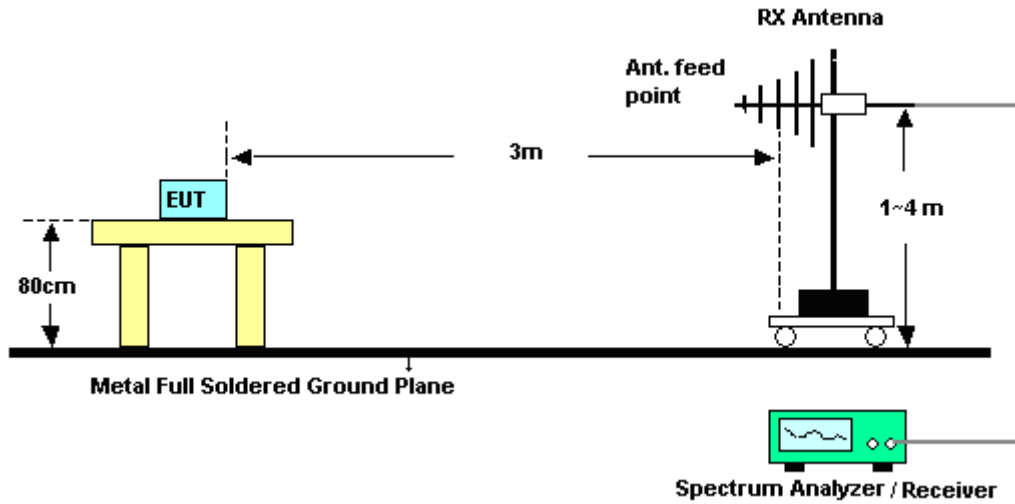

For radiated emissions above 1GHz

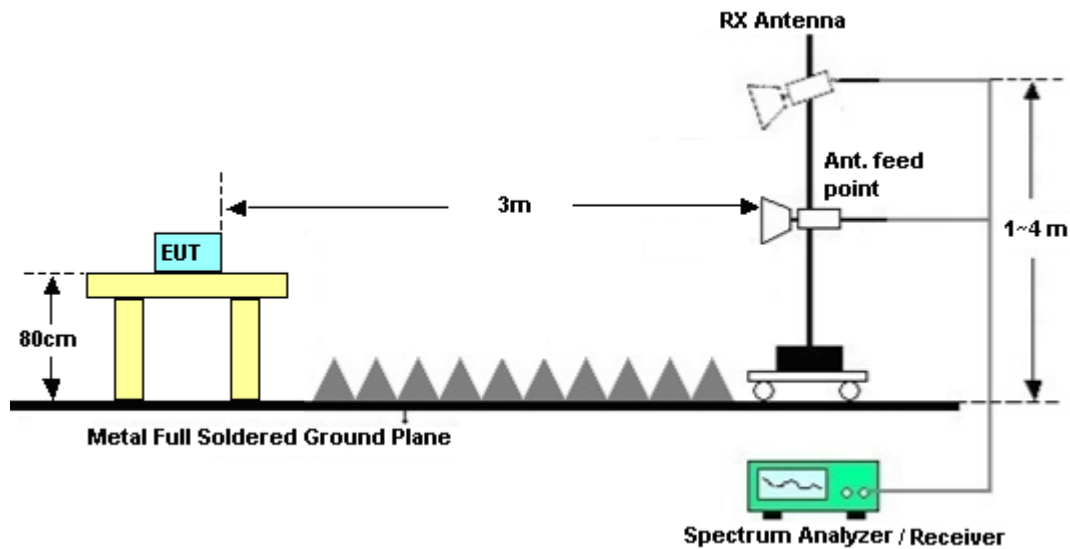

3.4.5 Test Results of Radiated Emissions (9 kHz ~ 30 MHz)

The low frequency, which started from 9 kHz to 30MHz, was pre-scanned and the result which was 20dB lower than the limit line per 15.31(o) was not reported.

3.4.6 Test Result of Radiated Band Edges

Please refer to Appendix A.

3.4.7 Test Result of Unwanted Radiated Emission (30MHz ~ 10th Harmonic)

Please refer to Appendix A.



3.5 AC Conducted Emission Measurement

3.5.1 Limit of AC Conducted Emission

For equipment that is designed to be connected to the public utility (AC) power line, the radio frequency voltage that is conducted back onto the AC power line on any frequency or frequencies within the band 150 kHz to 30 MHz shall not exceed the limits in the following table.

Frequency of emission (MHz)	Conducted limit (dB μ V)	
	Quasi-peak	Average
0.15-0.5	66 to 56*	56 to 46*
0.5-5	56	46
5-30	60	50

*Decreases with the logarithm of the frequency.

3.5.2 Measuring Instruments

The measuring equipment is listed in the section 4 of this test report.

3.5.3 Test Procedures

1. The EUT was placed 0.4 meter from the conducting wall of the shielding room was kept at least 80 centimeters from any other grounded conducting surface.
2. Connect EUT to the power mains through a line impedance stabilization network (LISN).
3. All the support units are connecting to the other LISN.
4. The LISN provides 50 ohm coupling impedance for the measuring instrument.
5. The FCC states that a 50 ohm, 50 microhenry LISN should be used.
6. Both sides of AC line were checked for maximum conducted interference.
7. The frequency range from 150 kHz to 30 MHz was searched.
8. Set the test-receiver system to Peak Detect Function and specified bandwidth with Maximum Hold Mode.

3.5.4 Test Setup

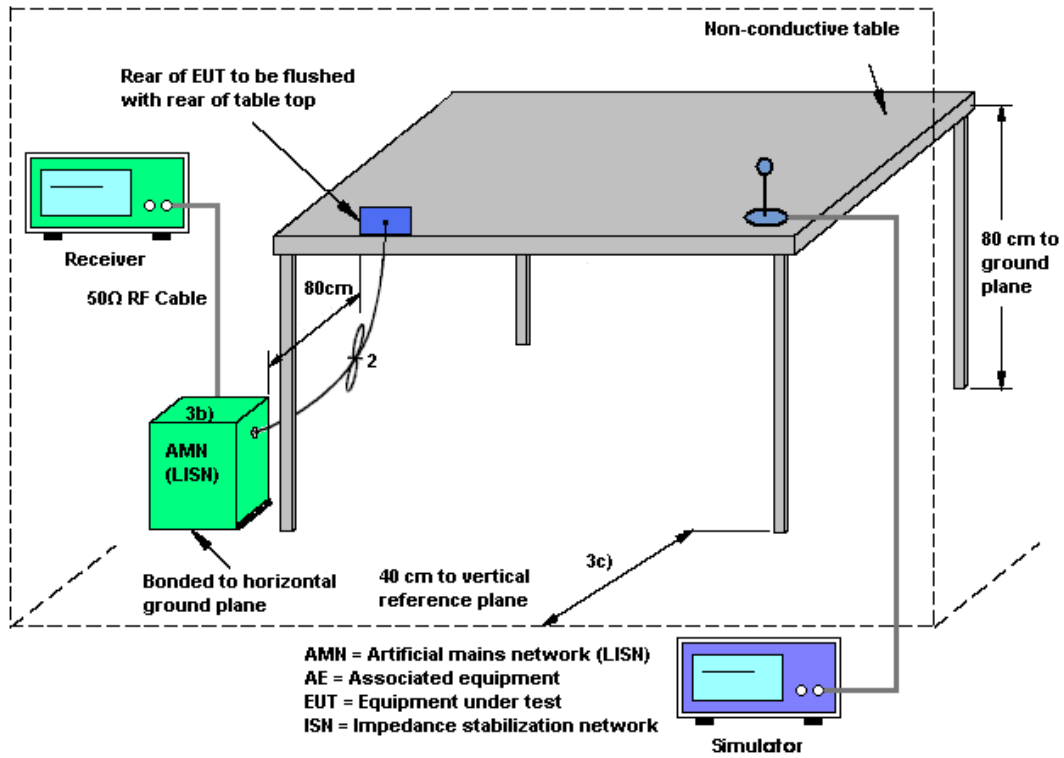



3.5.5 Test Result of AC Conducted Emission

Test Mode :	Mode 1	Temperature :	22~24°C
Test Engineer :	Eko Guan	Relative Humidity :	30~32%
Test Voltage :	120Vac / 60Hz	Phase :	Line
Function Type :	GSM850 Idle + Bluetooth Link + WLAN (5GHz) Link + USB Cable 1 (Charging from Adapter 1) + Earphone + Battery 1		

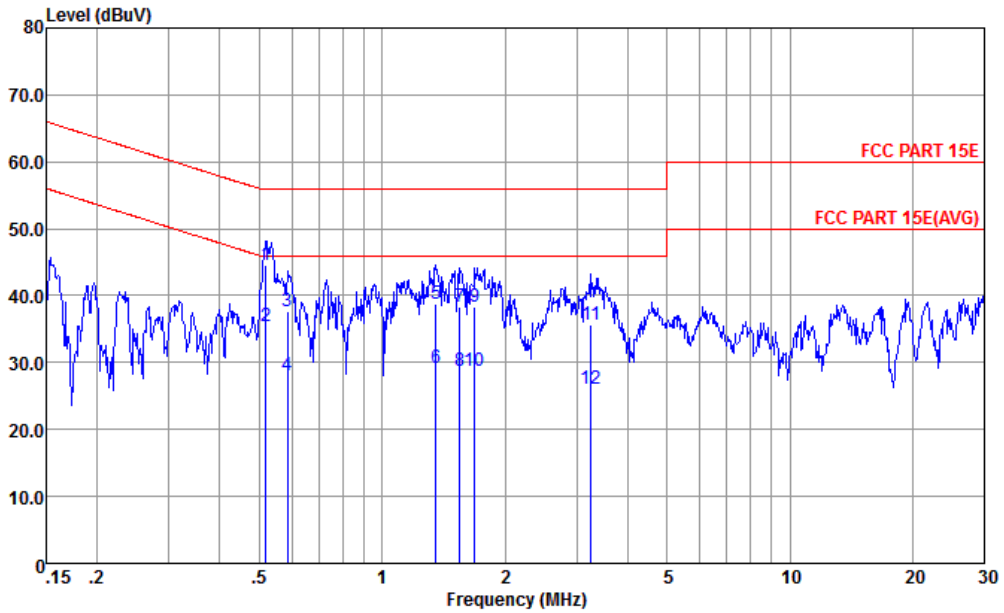

Site : CO01-KS
 Condition : FCC PART 15E LISN-L20140306 LINE

	Freq	Level	Over	Limit	Read	LISN	Cable	Remark
	MHz	dBuV	Limit	Line	Level	Factor	Loss	
			dB	dBuV	dBuV	dB	dB	
1	0.52	44.63	-11.37	56.00	33.80	0.20	10.63	QP
2 *	0.52	35.53	-10.47	46.00	24.70	0.20	10.63	Average
3	0.59	37.73	-18.27	56.00	26.90	0.20	10.63	QP
4	0.59	28.13	-17.87	46.00	17.30	0.20	10.63	Average
5	1.35	38.67	-17.33	56.00	27.90	0.10	10.67	QP
6	1.35	29.17	-16.83	46.00	18.40	0.10	10.67	Average
7	1.55	38.29	-17.71	56.00	27.50	0.10	10.69	QP
8	1.55	28.69	-17.31	46.00	17.90	0.10	10.69	Average
9	1.69	38.39	-17.61	56.00	27.60	0.10	10.69	QP
10	1.69	28.69	-17.31	46.00	17.90	0.10	10.69	Average
11	3.26	35.76	-20.24	56.00	24.80	0.16	10.80	QP
12	3.26	26.16	-19.84	46.00	15.20	0.16	10.80	Average



Test Mode :	Mode 1	Temperature :	22~24°C
Test Engineer :	Eko Guan	Relative Humidity :	30~32%
Test Voltage :	120Vac / 60Hz	Phase :	Neutral
Function Type :	GSM850 Idle + Bluetooth Link + WLAN (5GHz) Link + USB Cable 1 (Charging from Adapter 1) + Earphone + Battery 1		

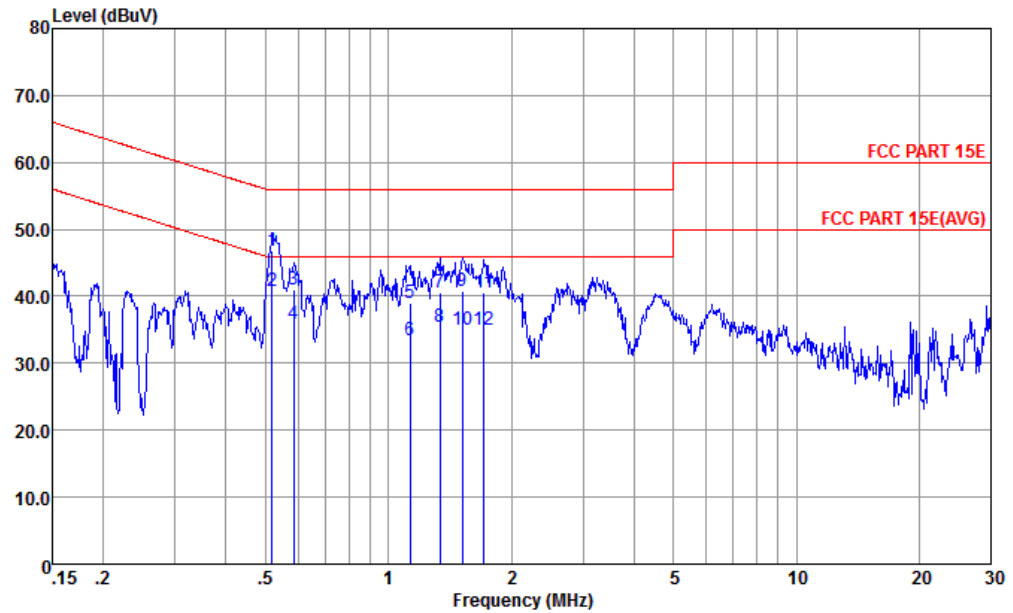

Site : CO01-KS
 Condition : FCC PART 15E LISN-N20140306 NEUTRAL

	Freq	Level	Over	Limit	Read	LISN	Cable	Remark
	MHz	dBuV	dB	dBuV	dBuV	dB	dB	
1	0.52	46.72	-9.28	56.00	35.80	0.29	10.63	QP
2 *	0.52	40.82	-5.18	46.00	29.90	0.29	10.63	Average
3	0.59	40.98	-15.02	56.00	30.10	0.25	10.63	QP
4	0.59	35.78	-10.22	46.00	24.90	0.25	10.63	Average
5	1.13	39.06	-16.94	56.00	28.30	0.10	10.66	QP
6	1.13	33.46	-12.54	46.00	22.70	0.10	10.66	Average
7	1.34	40.67	-15.33	56.00	29.90	0.10	10.67	QP
8	1.34	35.37	-10.63	46.00	24.60	0.10	10.67	Average
9	1.52	40.68	-15.32	56.00	29.90	0.10	10.68	QP
10	1.52	35.08	-10.92	46.00	24.30	0.10	10.68	Average
11	1.72	40.49	-15.51	56.00	29.70	0.10	10.69	QP
12	1.72	35.09	-10.91	46.00	24.30	0.10	10.69	Average

3.6 Frequency Stability Measurement

3.6.1 Limit of Frequency Stability

Manufacturers of U-NII devices are responsible for ensuring frequency stability such that an emission is maintained within the band of operation under all conditions of normal operation as specified in the user's manual.

3.6.2 Measuring Instruments

The measuring equipment is listed in the section 4 of this test report.

3.6.3 Test Procedures

1. To ensure emission at the band edge is maintained within the authorized band, those values shall be measured by radiation emissions at upper and lower frequency points, and finally compensated by frequency deviation as procedures below.
2. The EUT was operated at the maximum output power, and connected to the spectrum analyzer, which is set to maximum hold function and peak detector. The peak value of the power envelope was measured and noted. The upper and lower frequency points were respectively measured relatively 10dB lower than the measured peak value.
3. The frequency deviation was calculated by adding the upper frequency point and the lower frequency point divided by two. Those detailed values of frequency deviation are provided in table below.

3.6.4 Test Setup

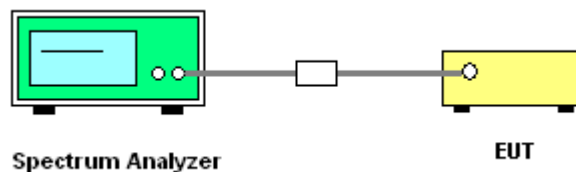

3.6.5 Test Result of Frequency Stability

Please refer to Appendix A.



3.7 Automatically Discontinue Transmission

3.7.1 Limit of Automatically Discontinue Transmission

The device shall automatically discontinue transmission in case of either absence of information to transmit or operational failure. These provisions are not intended to preclude the transmission of control or signaling information or the use of repetitive codes used by certain digital technologies to complete frame or burst intervals. Applicants shall include in their application for equipment authorization to describe how this requirement is met.

3.7.2 Measuring Instruments

The measuring equipment is listed in the section 4 of this test report.

3.7.3 Test Result of Automatically Discontinue Transmission

While the EUT is not transmitting any information, the EUT can automatically discontinue transmission and become standby mode for power saving. The EUT can detect the controlling signal of ACK message transmitting from remote device and verify whether it shall resend or discontinue transmission.



3.8 Antenna Requirements

3.8.1 Standard Applicable

According to FCC 47 CFR Section 15.407(a)(1)(2) ,if transmitting antenna directional gain is greater than 6 dBi, both the peak transmit power and the peak power spectral density shall be reduced by the amount in dB that the directional gain of the antenna exceeds 6 dBi.

3.8.2 Antenna Anti-Replacement Construction

An embedded-in antenna design is used.

3.8.3 Antenna Gain

The antenna gain is less than 6 dBi. Therefore, it is not necessary to reduce maximum output power limit.



4 List of Measuring Equipment

Instrument	Manufacturer	Model No.	Serial No.	Characteristics	Calibration Date	Test Date	Due Date	Remark
Spectrum Analyzer	R&S	FSP40	100319	9kHz~40GHz	Oct. 28, 2014	Feb. 13, 2015~ Feb. 20, 2015	Oct. 27, 2015	Conducted (TH01-KS)
Pulse Power Sensor	Anritsu	MA2411B	0917070	30MHz~40GHz	Jan. 23, 2015	Feb. 13, 2015~ Feb. 20, 2015	Jan. 22, 2016	Conducted (TH01-KS)
Power Meter	Anritsu	ML2495A	1005002	50MHz Bandwidth	Jan. 23, 2015	Feb. 13, 2015~ Feb. 20, 2015	Jan. 22, 2016	Conducted (TH01-KS)
Thermal Chamber	Ten Billion	TTC-B3S	TBN-960502	-40~+150°C	Oct. 25, 2014	Feb. 13, 2015~ Feb. 20, 2015	Oct. 24, 2015	Conducted (TH01-KS)
EMI Test Receiver	R&S	ESCI	100534	9kHz~3GHz	Oct. 25, 2014	Feb. 20, 2015	Oct. 24, 2015	Radiation (03CH01-KS)
Spectrum Analyzer	R&S	FSP40	100319	9kHz~40GHz	Oct. 28, 2014	Feb. 20, 2015	Oct. 27, 2015	Radiation (03CH01-KS)
Loop Antenna	R&S	HFH2-Z2	100321	9kHz~30MHz	Nov. 13, 2014	Feb. 20, 2015	Nov. 12, 2015	Radiation (03CH01-KS)
Bilog Antenna	TeseQ	CBL6112D	23182	25Mhz-2Ghz	Jan. 17, 2015	Feb. 20, 2015	Jan. 16, 2016	Radiation (03CH01-KS)
Double Ridge Horn Antenna	ETS-Lindgren	3117	75959	1GHz~18GHz	Jan. 17, 2015	Feb. 20, 2015	Jan. 16, 2016	Radiation (03CH01-KS)
Active Horn Antenna	com-power	AHA-118	701030	1GHz~18GHz	Nov. 08, 2014	Feb. 20, 2015	Nov. 07, 2015	Radiation (03CH01-KS)
SHF-EHF Horn	Schwarzbeck	BBHA 9170	BBHA170249	15GHz~40GHz	Mar. 10, 2014	Feb. 20, 2015	Mar. 09, 2015	Radiation (03CH01-KS)
Amplifier	com-power	PA-103A	161069	1MHz~1GHz /32dB	May 04, 2014	Feb. 20, 2015	May 03, 2015	Radiation (03CH01-KS)
Amplifier	Agilent	8449B	3008A02371	1GHz~26.5GHz	Oct. 28, 2014	Feb. 20, 2015	Oct. 27, 2015	Radiation (03CH01-KS)
AC Power Source	Chroma	61601	F104090004	N/A	NCR	Feb. 20, 2015	NCR	Radiation (03CH01-KS)
Turn Table	MF	MF7802	N/A	0~360 degree	NCR	Feb. 20, 2015	NCR	Radiation (03CH01-KS)
Antenna Mast	MF	MF7802	N/A	1 m~4 m	NCR	Feb. 20, 2015	NCR	Radiation (03CH01-KS)
EMI Receiver	R&S	ESCI7	100768	9kHz~7GHz;	May 04, 2014	Feb. 11, 2015	May 03, 2015	Conduction (CO01-KS)
AC LISN	MessTec	AN3016	060103	9kHz~30MHz	Oct. 25, 2014	Feb. 11, 2015	Oct. 24, 2015	Conduction (CO01-KS)
AC LISN (for auxiliary equipment)	MessTec	AN3016	060105	9kHz~30MHz	Oct. 25, 2014	Feb. 11, 2015	Oct. 24, 2015	Conduction (CO01-KS)
AC Power Source	Chroma	61602	ABP000000811	AC 0V~300V, 45Hz~1000Hz	Oct. 25, 2014	Feb. 11, 2015	Oct. 24, 2015	Conduction (CO01-KS)



5 Uncertainty of Evaluation

Uncertainty of Conducted Emission Measurement (150kHz ~ 30MHz)

Measuring Uncertainty for a Level of Confidence of 95% ($U = 2Uc(y)$)	2.3 dB
---	--------

Uncertainty of Radiated Emission Measurement (30 MHz ~ 1000 MHz)

Measuring Uncertainty for a Level of Confidence of 95% ($U = 2Uc(y)$)	2.5 dB
---	--------



Appendix A. Conducted Test Results

Test Engineer:	Issac Song	Temperature:	24~25	°C
Test Date:	2015/2/13~2015/2/20	Relative Humidity:	49~51	%

TEST RESULTS DATA
6dB OBW

Band IV							
Mod.	Data Rate	NTX	CH.	Freq. (MHz)	6 dB Bandwidth (MHz)	FCC 6dB Bandwidth Limit (MHz)	Pass/Fail
11a	6Mbps	1	149	5745	16.36	0.5	Pass
11a	6Mbps	1	157	5785	16.36	0.5	Pass
11a	6Mbps	1	165	5825	16.34	0.5	Pass
HT20	MCS0	1	149	5745	17.56	0.5	Pass
HT20	MCS0	1	157	5785	17.56	0.5	Pass
HT20	MCS0	1	165	5825	17.58	0.5	Pass
HT40	MCS0	1	151	5755	35.08	0.5	Pass
HT40	MCS0	1	159	5795	35.32	0.5	Pass

TEST RESULTS DATA
Average Power Table

FCC Band IV										
Mod.	Data Rate	NTX	CH.	Freq. (MHz)	Duty Factor (dB)	Average Conducted Power (dBm)	FCC Conducted Power Limit (dBm)	DG (dBi)		Pass/Fail
11a	6Mbps	1	149	5745	0.59	13.05	30.00	0.00		Pass
11a	6Mbps	1	157	5785	0.59	13.35	30.00	0.00		Pass
11a	6Mbps	1	165	5825	0.59	12.80	30.00	0.00		Pass
HT20	MCS0	1	149	5745	0.62	11.41	30.00	0.00		Pass
HT20	MCS0	1	157	5785	0.62	11.80	30.00	0.00		Pass
HT20	MCS0	1	165	5825	0.62	11.30	30.00	0.00		Pass
HT40	MCS0	1	151	5755	1.17	11.51	30.00	0.00		Pass
HT40	MCS0	1	159	5795	1.17	11.79	30.00	0.00		Pass

TEST RESULTS DATA
Power Spectral Density

Band IV										
Mod.	Data Rate	NTX	CH.	Freq. (MHz)	Duty Factor (dB)	10log (500kHz /RBW) Factor (dB)	Average Power Density (dBm/500kHz)	Average PSD Limit (dBm/500kHz)	DG (dBi)	Pass/Fail
11a	6Mbps	1	149	5745	0.59	2.22	-0.17	30.00	0.00	Pass
11a	6Mbps	1	157	5785	0.59	2.22	-0.51	30.00	0.00	Pass
11a	6Mbps	1	165	5825	0.59	2.22	-0.55	30.00	0.00	Pass
HT20	MCS0	1	149	5745	0.62	2.22	-2.45	30.00	0.00	Pass
HT20	MCS0	1	157	5785	0.62	2.22	-2.42	30.00	0.00	Pass
HT20	MCS0	1	165	5825	0.62	2.22	-2.37	30.00	0.00	Pass
HT40	MCS0	1	151	5755	1.17	2.22	-4.96	30.00	0.00	Pass
HT40	MCS0	1	159	5795	1.17	2.22	-4.48	30.00	0.00	Pass

TEST RESULTS DATA
Frequency Stability

Band IV										
Mod.	Data Rate	Ntx	CH.	Freq. (MHz)	Center Frequency (MHz)	Frequency Deviation (MHz)	Frequency Stability (ppm)	Temperature (°C)	Voltage (V)	Note
11a	6Mbps	1	149	5745	5745.050	0.050	8.70	20	3.5	
11a	6Mbps	1	149	5745	5745.050	0.050	8.70	20	4.35	
11a	6Mbps	1	149	5745	5745.100	0.100	17.41	20	3.8	
11a	6Mbps	1	149	5745	5745.075	0.075	13.05	-30	3.8	
11a	6Mbps	1	149	5745	5745.100	0.100	17.41	55	3.8	



Appendix B. Radiated Spurious Emission

15E Band 4 - 5725~5850MHz

WIFI 802.11a (Band Edge @ 3m)

WIFI	Note	Frequency	Level	Over	Limit	Read	Antenna	Cable	Preamp	Ant	Table	Peak	Pol.
		(MHz)	(dBμV/m)	(dB)	(dBμV/m)	(dBμV)	(dB/m)	(dB)	(dB)	(cm)	(deg)	(P/A)	(H/V)
802.11a CH 149 5745MHz	*	5745	102.27	-	-	93.29	35.52	7.16	33.7	150	117	P	H
	*	5745	91.04	-	-	82.06	35.52	7.16	33.7	150	117	A	H
		5711.08	57.82	-10.48	68.3	48.88	35.51	7.13	33.7	150	118	P	H
		5723.8	69.95	-8.35	78.3	60.99	35.52	7.14	33.7	150	118	P	H
	*	5745	103.19	-	-	94.21	35.52	7.16	33.7	283	0	P	V
	*	5745	91.69	-	-	82.71	35.52	7.16	33.7	283	0	A	V
		5714.84	58.25	-10.05	68.3	49.31	35.51	7.13	33.7	283	0	P	V
		5723.88	72.17	-6.13	78.3	63.21	35.52	7.14	33.7	283	0	P	V
802.11a CH 157 5785MHz	*	5785	103.28	-	-	94.3	35.53	7.15	33.7	150	118	P	H
	*	5785	91.42	-	-	82.44	35.53	7.15	33.7	150	118	A	H
	*	5785	103.1	-	-	94.12	35.53	7.15	33.7	216	315	P	V
	*	5785	91.47	-	-	82.49	35.53	7.15	33.7	216	315	A	V
802.11a CH 165 5825MHz	*	5825	103.78	-	-	94.73	35.55	7.2	33.7	155	120	P	H
	*	5825	92.29	-	-	83.24	35.55	7.2	33.7	155	120	A	H
		5850.64	64.16	-14.14	78.3	55.07	35.56	7.23	33.7	155	120	P	H
		5861.84	58.46	-9.84	68.3	49.35	35.56	7.25	33.7	155	120	P	H
	*	5825	105.62	-	-	96.57	35.55	7.2	33.7	239	355	P	V
	*	5825	93.96	-	-	84.91	35.55	7.2	33.7	239	355	A	V
		5850.8	65.11	-13.19	78.3	56.02	35.56	7.23	33.7	239	355	P	V
		5862.72	58.92	-9.38	68.3	49.81	35.56	7.25	33.7	239	355	P	V
Remark	1. No other spurious found. 2. All results are PASS against Peak and Average limit line.												



15E Band 4 5725~5850MHz
WIFI 802.11a (Harmonic @ 3m)

WIFI	Note	Frequency	Level	Over	Limit	Read	Antenna	Cable	Preamp	Ant	Table	Peak	Pol.
		(MHz)	(dBμV/m)	Limit	Line	Level	Factor	Loss	Factor	Pos	Pos	Avg.	
				(dB)	(dBμV/m)	(dBμV)	(dB/m)	(dB)	(dB)	(cm)	(deg)	(P/A)	(H/V)
802.11a CH 149 5745MHz		11490	34.83	-39.17	74	54.18	4.47	10.18	34	169	83	P	H
		11490	33.63	-40.37	74	52.98	4.47	10.18	34	158	55	P	V
802.11a CH 157 5785MHz		11570	33.62	-40.38	74	53.05	4.38	10.21	34.02	170	85	P	H
		11571	33.5	-40.5	74	52.93	4.38	10.21	34.02	195	66	P	V
802.11a CH 165 5825MHz		11650	34.02	-39.98	74	53.62	4.2	10.25	34.05	178	162	P	H
		11649	33.14	-40.86	74	52.74	4.2	10.25	34.05	185	59	P	V
Remark	1. No other spurious found. 2. All results are PASS against Peak and Average limit line.												



**15E Band 4 5725~5850MHz
WIFI 802.11n HT20 (Band Edge @ 3m)**

WIFI	Note	Frequency	Level	Over	Limit	Read	Antenna	Cable	Preamp	Ant	Table	Peak	Pol.
		(MHz)	(dBμV/m)	(dB)	Limit	Level	Factor	Loss	Factor	Pos	Pos	Avg.	
					Line	(dBμV)	(dB/m)	(dB)	(dB)	(cm)	(deg)	(P/A)	(H/V)
802.11n HT20 CH 149 5745MHz	*	5745	98.57	-	-	89.59	35.52	7.16	33.7	150	78	P	H
	*	5745	85.85	-	-	76.87	35.52	7.16	33.7	150	78	A	H
		5714.68	53.27	-15.03	68.3	44.33	35.51	7.13	33.7	150	71	P	H
		5724.44	59.96	-18.34	78.3	51	35.52	7.14	33.7	150	71	P	H
	*	5745	101.64	-	-	92.66	35.52	7.16	33.7	300	0	P	V
	*	5745	90.92	-	-	81.94	35.52	7.16	33.7	300	0	A	V
		5714.52	56.63	-11.67	68.3	47.69	35.51	7.13	33.7	300	0	P	V
	5724.12	67.71	-10.59	78.3	58.75	35.52	7.14	33.7	300	0	P	V	
802.11n HT20 CH 157 5785MHz	*	5785	100.19	-	-	91.21	35.53	7.15	33.7	150	360	P	H
	*	5785	88.24	-	-	79.26	35.53	7.15	33.7	150	360	A	H
	*	5785	100.68	-	-	91.7	35.53	7.15	33.7	241	312	P	V
	*	5785	89.25	-	-	80.27	35.53	7.15	33.7	241	312	A	V
802.11n HT20 CH 165 5825MHz	*	5825	100.51	-	-	91.46	35.55	7.2	33.7	150	126	P	H
	*	5825	88.51	-	-	79.46	35.55	7.2	33.7	150	126	A	H
		5850.24	60.83	-17.47	78.3	51.74	35.56	7.23	33.7	150	124	P	H
		5862.96	56.44	-11.86	68.3	47.33	35.56	7.25	33.7	150	124	P	H
	*	5825	100.48	-	-	91.43	35.55	7.2	33.7	150	320	P	V
	*	5825	88.29	-	-	79.24	35.55	7.2	33.7	150	320	A	V
		5851.44	58.05	-20.25	78.3	48.96	35.56	7.23	33.7	150	320	P	V
	5860.4	55.32	-12.98	68.3	46.21	35.56	7.25	33.7	150	320	P	V	
Remark	1. No other spurious found. 2. All results are PASS against Peak and Average limit line.												



**15E Band 4 5725~5850MHz
WIFI 802.11n HT20 (Harmonic @ 3m)**

WIFI	Note	Frequency	Level	Over	Limit	Read	Antenna	Cable	Preamp	Ant	Table	Peak	Pol.
		(MHz)	(dBμV/m)	Limit	Line	Level	Factor	Loss	Factor	Pos	Pos	Avg.	
				(dB)	(dBμV/m)	(dBμV)	(dB/m)	(dB)	(dB)	(cm)	(deg)	(P/A)	(H/V)
802.11n HT20 CH 149 5745MHz		11490	34.23	-39.77	74	53.58	4.47	10.18	34	159	65	P	H
		11490	35.65	-38.35	74	55	4.47	10.18	34	150	226	P	V
802.11n HT20 CH 157 5785MHz		11570	34.8	-39.2	74	54.23	4.38	10.21	34.02	168	55	P	H
		11570	33.67	-40.33	74	53.1	4.38	10.21	34.02	169	147	P	V
802.11n HT20 CH 165 5825MHz		11649	34.47	-39.53	74	54.07	4.2	10.25	34.05	150	226	P	H
		11649	33.8	-40.2	74	53.4	4.2	10.25	34.05	185	284	P	V
Remark	1. No other spurious found. 2. All results are PASS against Peak and Average limit line.												



**15E Band 4 5725~5850MHz
WIFI 802.11n HT40 (Band Edge @ 3m)**

WIFI	Note	Frequency	Level	Over	Limit	Read	Antenna	Cable	Preamp	Ant	Table	Peak	Pol.
		(MHz)	(dBμV/m)	(dB)	(dBμV/m)	(dBμV)	(dB/m)	(dB)	(dB)	(cm)	(deg)	(P/A)	(H/V)
802.11n HT40 CH 151 5755MHz	*	5755	98.06	-	-	89.07	35.53	7.16	33.7	226	199	P	H
	*	5755	86.34	-	-	77.35	35.53	7.16	33.7	226	199	A	H
	!	5714.04	63.67	-4.63	68.3	54.73	35.51	7.13	33.7	226	200	P	H
		5723.48	67.62	-10.68	78.3	58.66	35.52	7.14	33.7	226	200	P	H
		5859.44	53.22	-25.08	78.3	44.11	35.56	7.25	33.7	226	200	P	H
		5881.2	52.97	-15.33	68.3	43.82	35.57	7.28	33.7	226	200	P	H
	*	5755	94.61	-	-	85.62	35.53	7.16	33.7	150	118	P	V
	*	5755	83.04	-	-	74.05	35.53	7.16	33.7	150	118	A	V
		5712.68	60.16	-8.14	68.3	51.22	35.51	7.13	33.7	150	118	P	V
		5721.72	65.74	-12.56	78.3	56.78	35.52	7.14	33.7	150	118	P	V
		5857.12	52.72	-25.58	78.3	43.61	35.56	7.25	33.7	150	118	P	V
	5862.8	53.21	-15.09	68.3	44.1	35.56	7.25	33.7	150	118	P	V	
802.11n HT40 CH 159 5795MHz	*	5795	101.14	-	-	92.15	35.54	7.15	33.7	209	193	P	H
	*	5795	89.22	-	-	80.23	35.54	7.15	33.7	209	193	A	H
		5699.8	53.33	-14.97	68.3	44.42	35.5	7.11	33.7	209	193	P	H
		5715.32	53.41	-24.89	78.3	44.47	35.51	7.13	33.7	209	193	P	H
		5852.72	55.64	-22.66	78.3	46.55	35.56	7.23	33.7	209	193	P	H
		5878.96	53.38	-14.92	68.3	44.23	35.57	7.28	33.7	209	193	P	H
	*	5795	101.84	-	-	92.85	35.54	7.15	33.7	285	114	P	V
	*	5795	89.49	-	-	80.5	35.54	7.15	33.7	285	114	A	V
		5703.16	52.56	-15.74	68.3	43.62	35.51	7.13	33.7	285	114	P	V
		5717.64	52.76	-25.54	78.3	43.8	35.52	7.14	33.7	283	114	P	V
		5854.72	53.77	-24.53	78.3	44.66	35.56	7.25	33.7	283	114	P	V
	5876.56	53.47	-14.83	68.3	44.32	35.57	7.28	33.7	283	114	P	V	
Remark	1. No other spurious found. 2. All results are PASS against Peak and Average limit line.												



15E Band 4 5725~5850MHz
WIFI 802.11n HT40 (Harmonic @ 3m)

WIFI	Note	Frequency	Level	Over	Limit	Read	Antenna	Cable	Preamp	Ant	Table	Peak	Pol.
		(MHz)	(dBμV/m)	Limit	Line	Level	Factor	Loss	Factor	Pos	Pos	Avg.	
				(dB)	(dBμV/m)	(dBμV)	(dB/m)	(dB)	(dB)	(cm)	(deg)	(P/A)	(H/V)
802.11n HT40 CH 151 5755MHz		11511	34.48	-39.52	74	53.75	4.53	10.2	34	175	55	P	H
		11511	33.9	-40.1	74	53.17	4.53	10.2	34	300	154	P	V
802.11n HT40 CH 159 5795MHz		11590	34.41	-39.59	74	53.89	4.34	10.21	34.03	200	155	P	H
		11589	33.8	-40.2	74	53.28	4.34	10.21	34.03	154	223	P	V
Remark	1. No other spurious found. 2. All results are PASS against Peak and Average limit line.												



15E Emission below 1GHz

5GHz WIFI 802.11n HT40 (LF @ 3m)

WIFI	Note	Frequency	Level	Over	Limit	Read	Antenna	Cable	Preamp	Ant	Table	Peak	Pol.
		(MHz)	(dBμV/m)	(dB)	(dBμV/m)	(dBμV)	(dB/m)	(dB)	(dB)	(cm)	(deg)	(P/A)	(H/V)
5GHz 802.11n HT40 LF		172.59	30.9	-12.6	43.5	54.25	9.01	1.21	33.57	174	88	P	H
		301.6	21.89	-24.11	46	40.62	13.04	1.6	33.37			P	H
		520.82	23.19	-22.81	46	36.54	17.7	2.04	33.09			P	H
		700.27	23.9	-22.1	46	35.09	19.3	2.39	32.88			P	H
		868.08	26.09	-19.91	46	35.57	20.49	2.67	32.64			P	H
		896.21	26.4	-19.6	46	35.68	20.45	2.71	32.44			P	H
		30	25.86	-14.14	40	40.95	18	0.48	33.57			P	V
		79.47	29.68	-10.32	40	55.99	6.47	0.82	33.6	122	269	P	V
		214.3	25.31	-18.19	43.5	47.78	9.71	1.35	33.53			P	V
		433.52	25.57	-20.43	46	40.65	16.22	1.93	33.23			P	V
		605.21	22.49	-23.51	46	34.57	18.62	2.25	32.95			P	V
	862.26	24.57	-21.43	46	34.08	20.5	2.66	32.67			P	V	
Remark	1. No other spurious found. 2. All results are PASS against limit line.												



Note symbol

*	Fundamental Frequency which can be ignored. However, the level of any unwanted emissions shall not exceed the level of the fundamental frequency per 15.209(c).
!	Test result is over limit line.
P/A	Peak or Average
H/V	Horizontal or Vertical



A calculation example for radiated spurious emission is shown as below:

WIFI	Note	Frequency	Level	Over	Limit	Read	Antenna	Cable	Preamp	Ant	Table	Peak	Pol.
		(MHz)	(dBμV/m)	(dB)	Limit Line	Level	Factor	Loss	Factor	Pos	Pos	Avg.	
					(dBμV/m)	(dBμV)	(dB/m)	(dB)	(dB)	(cm)	(deg)	(P/A)	(H/V)
802.11a		5711.08	57.82	-10.48	68.3	48.88	35.51	7.13	33.7	150	118	P	H
CH 149		5723.8	69.95	-8.35	78.3	60.99	35.52	7.14	33.7	150	118	P	H
5745MHz													

- Level(dBμV/m) =
Antenna Factor(dB/m) + Cable Loss(dB) + Read Level(dBμV) - Preamp Factor(dB)
- Over Limit(dB) = Level(dBμV/m) – Limit Line(dBμV/m)

For Peak Limit @ 5711.08MHz:

- Level(dBμV/m)
= Antenna Factor(dB/m) + Cable Loss(dB) + Read Level(dBμV) - Preamp Factor(dB)
= 35.51 (dB/m) + 7.13 (dB) + 48.88 (dBμV) – 33.7 (dB)
= 57.82 (dBμV/m)
- Over Limit(dB)
= Level(dBμV/m) – Limit Line(dBμV/m)
= 57.82 (dBμV/m) – 68.3 (dBμV/m)
= -10.48 (dB)

For Average Limit @ 5723.8MHz:

- Level(dBμV/m)
= Antenna Factor(dB/m) + Cable Loss(dB) + Read Level(dBμV) - Preamp Factor(dB)
= 35.52 (dB/m) + 7.14 (dB) + 60.99 (dBμV) – 33.7 (dB)
= 69.95 (dBμV/m)
- Over Limit(dB)
= Level(dBμV/m) – Limit Line(dBμV/m)
= 69.95 (dBμV/m) – 78.3 (dBμV/m)
= -8.35(dB)

Both peak and average measured complies with the limit line, so test result is “PASS”.