

FCC SAR Test Report

APPLICANT : TCL Communication Ltd.
EQUIPMENT : Tablet PC
BRAND NAME : ALCATEL ONETOUCH
MODEL NAME : 9007T
MARKETING NAME : ONETOUCH PIXI 3 (7)
FCC ID : 2ACCJB010
STANDARD : FCC 47 CFR Part 2 (2.1093)
ANSI/IEEE C95.1-1992
IEEE 1528-2003

We, SPORTON INTERNATIONAL (SHENZHEN) INC., would like to declare that the tested sample has been evaluated in accordance with the procedures and had been in compliance with the applicable technical standards.

The test results in this report apply exclusively to the tested model / sample. Without written approval of SPORTON INTERNATIONAL (SHENZHEN) INC., the test report shall not be reproduced except in full.

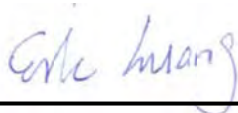

Reviewed by: Eric Huang / Deputy Manager



Approved by: Jones Tsai / Manager



SPORTON INTERNATIONAL (SHENZHEN) INC.
1F & 2F, Building A, Morning Business Center, No. 4003 ShiGu Rd., Xili Town,
Nanshan District, Shenzhen, Guangdong, P. R. China



Table of Contents

1. Statement of Compliance4

2. Administration Data5

3. Guidance Standard5

4. Equipment Under Test (EUT)6

 4.1 General Information6

 4.2 Specification of Accessory6

 4.3 Maximum Tune-up Limit7

 4.4 General LTE SAR Test and Reporting Considerations10

5. Proximity Sensor Triggering Test.....11

6. RF Exposure Limits16

 6.1 Uncontrolled Environment16

 6.2 Controlled Environment16

7. Specific Absorption Rate (SAR).....17

 7.1 Introduction17

 7.2 SAR Definition17

8. System Description and Setup18

9. Measurement Procedures19

 9.1 Spatial Peak SAR Evaluation19

 9.2 Power Reference Measurement20

 9.3 Area Scan20

 9.4 Zoom Scan21

 9.5 Volume Scan Procedures21

 9.6 Power Drift Monitoring21

10. Test Equipment List22

11. System Verification23

 11.1 Tissue Verification23

 11.2 System Performance Check Results24

12. RF Exposure Positions25

 12.1 SAR Testing for Tablet25

13. Conducted RF Output Power (Unit: dBm).....26

14. Antenna Location43

15. SAR Test Results46

 15.1 Body SAR47

 15.2 Repeated SAR Measurement51

16. Simultaneous Transmission Analysis52

 16.1 Tablet Body Exposure Conditions53

 16.2 SPLSR Evaluation and Analysis55

17. Uncertainty Assessment56

18. References58

Appendix A. Plots of System Performance Check

Appendix B. Plots of High SAR Measurement

Appendix C. DASYS Calibration Certificate

Appendix D. Test Setup Photos



1. Statement of Compliance

The maximum results of Specific Absorption Rate (SAR) found during testing for **TCL Communication Ltd., Tablet PC, 9007T**, are as follows.

Equipment Class	Frequency Band	Highest SAR Summary	
		Body 1g SAR (W/kg)	Highest Simultaneous Transmission 1g SAR (W/kg)
PCB	LTE Band 26	0.35	1.59
	LTE Band 25	0.71	
	LTE Band 41	1.38	
DTS	WLAN 2.4GHz Band	1.39	1.54
DSS	Bluetooth		1.59
Date of Testing:		Jul. 17, 2015 ~ Jul. 23, 2015	

This device is in compliance with Specific Absorption Rate (SAR) for general population/uncontrolled exposure limits (1.6 W/kg) specified in FCC 47 CFR part 2 (2.1093) and ANSI/IEEE C95.1-1992, and had been tested in accordance with the measurement methods and procedures specified in IEEE 1528-2003.



2. Administration Data

Testing Laboratory	
Test Site	SPORTON INTERNATIONAL (SHENZHEN) INC.
Test Site Location	1F & 2F, Building A, Morning Business Center, No. 4003 ShiGu Rd., Xili Town, Nanshan District, Shenzhen, Guangdong, P. R. China TEL: +86-755-8637-9589 FAX: +86-755-8637-9595

Applicant	
Company Name	TCL Communication Ltd.
Address	5F, C building, No. 232, Liang Jing Road ZhangJiang High-Tech Park, Pudong Area Shanghai, P. R. China. 201203

Manufacturer	
Company Name	TCL Communication Ltd.
Address	5F, C building, No. 232, Liang Jing Road ZhangJiang High-Tech Park, Pudong Area Shanghai, P. R. China. 201203

3. Guidance Standard

The Specific Absorption Rate (SAR) testing specification, method, and procedure for this device is in accordance with the following standards:

- FCC 47 CFR Part 2 (2.1093)
- ANSI/IEEE C95.1-1992
- IEEE 1528-2003
- FCC KDB 865664 D01 SAR Measurement 100 MHz to 6 GHz v01r03
- FCC KDB 865664 D02 SAR Reporting v01r01
- FCC KDB 447498 D01 General RF Exposure Guidance v05r02
- FCC KDB 248227 D01 802.11 Wi-Fi SAR v02r01
- FCC KDB 616217 D04 SAR for laptop and tablets v01r01
- FCC KDB 941225 D01 3G SAR Procedures v03
- FCC KDB 941225 D05 SAR for LTE Devices v02r03

4. Equipment Under Test (EUT)

4.1 General Information

Product Feature & Specification	
Equipment Name	Tablet PC
Brand Name	ALCATEL ONETOUCH
Model Name	9007T
Marketing Name	ONETOUCH PIXI 3 (7)
FCC ID	2ACCJB010
Wireless Technology and Frequency Range	LTE Band 26: 814.7 MHz ~ 848.3 MHz LTE Band 25: 1850.7 MHz ~ 1914.3 MHz LTE Band 41: 2498.5 MHz ~ 2687.5 MHz WLAN 2.4GHz Band: 2412 MHz ~ 2462 MHz Bluetooth: 2402 MHz ~ 2480 MHz
Mode	<ul style="list-style-type: none"> • LTE • 802.11b/g/n/ HT20 • Bluetooth v3.0+EDR, Bluetooth v4.1 LE
HW Version	V05
SW Version	A2J
EUT Stage	Production Unit
Remark:	
<ol style="list-style-type: none"> 1. This device has no voice function. 2. 802.11n-HT40 is not supported in 2.4GHz WLAN. 	

4.2 Specification of Accessory

Specification of Accessory			
AC Adapter	Brand Name	ALCATELONETOUCH	Model Name UC13US
	Power Rating	I/P: 100-240Vac, 0.5A, O/P: 5Vdc, 2A	
	P/N	CBA0059AG1C1	
Battery	Brand Name	ALCATEL ONETOUCH	Model Name TLp040D2
	Power Rating	3.8V 4000mAh	
	P/N	C4000000C2Y2Z77K	
USB Cable	Brand Name	NA	Model Name NA
	Signal Line Type	1.0meter, shielded cable, without ferrite core	



4.3 Maximum Tune-up Limit

LTE Band 26					
Average Power (dBm)					
Modulation	BW (MHz)	RB size	MPR	Full power mode	Reduced power mode
QPSK	15	≤ 16	0	23.0	15.0
QPSK	15	> 16	0-1	22.0	15.0
16QAM	15	≤ 16	0-1	22.0	15.0
16QAM	15	> 16	0-2	21.0	15.0
QPSK	10	≤ 12	0	23.0	15.0
QPSK	10	> 12	0-1	22.0	15.0
16QAM	10	≤ 12	0-1	22.0	15.0
16QAM	10	> 12	0-2	21.0	15.0
QPSK	5	≤ 8	0	23.0	15.0
QPSK	5	> 8	0-1	22.0	15.0
16QAM	5	≤ 8	0-1	22.0	15.0
16QAM	5	> 8	0-2	21.0	15.0
QPSK	3	≤ 4	0	23.0	15.0
QPSK	3	> 4	0-1	22.0	15.0
16QAM	3	≤ 4	0-1	22.0	15.0
16QAM	3	> 4	0-2	21.0	15.0
QPSK	1.4	≤ 5	0	23.0	15.0
QPSK	1.4	> 5	0-1	22.0	15.0
16QAM	1.4	≤ 5	0-1	22.0	15.0
16QAM	1.4	> 5	0-2	21.0	15.0

LTE Band 25					
Average Power (dBm)					
Modulation	BW (MHz)	RB size	MPR	Full power mode	Reduced power mode
QPSK	20	≤ 18	0	23.5	15.5
QPSK	20	> 18	0-1	22.5	15.5
16QAM	20	≤ 18	0-1	22.5	15.5
16QAM	20	> 18	0-2	21.5	15.5
QPSK	15	≤ 16	0	23.5	15.5
QPSK	15	> 16	0-1	22.5	15.5
16QAM	15	≤ 16	0-1	22.5	15.5
16QAM	15	> 16	0-2	21.5	15.5
QPSK	10	≤ 12	0	23.5	15.5
QPSK	10	> 12	0-1	22.5	15.5
16QAM	10	≤ 12	0-1	22.5	15.5
16QAM	10	> 12	0-2	21.5	15.5
QPSK	5	≤ 8	0	23.5	15.5
QPSK	5	> 8	0-1	22.5	15.5
16QAM	5	≤ 8	0-1	22.5	15.5
16QAM	5	> 8	0-2	21.5	15.5
QPSK	3	≤ 4	0	23.5	15.5
QPSK	3	> 4	0-1	22.5	15.5
16QAM	3	≤ 4	0-1	22.5	15.5
16QAM	3	> 4	0-2	21.5	15.5
QPSK	1.4	≤ 5	0	23.5	15.5
QPSK	1.4	> 5	0-1	22.5	15.5
16QAM	1.4	≤ 5	0-1	22.5	15.5
16QAM	1.4	> 5	0-2	21.5	15.5

LTE Band 41					
Average Power (dBm)					
Modulation	BW (MHz)	RB size	MPR	Full power mode	Reduced power mode
QPSK	20	≤ 18	0	23.0	14.0
QPSK	20	> 18	0-1	23.0	14.0
16QAM	20	≤ 18	0-1	23.0	14.0
16QAM	20	> 18	0-2	23.0	14.0
QPSK	15	≤ 16	0	23.0	14.0
QPSK	15	> 16	0-1	23.0	14.0
16QAM	15	≤ 16	0-1	23.0	14.0
16QAM	15	> 16	0-2	23.0	14.0
QPSK	10	≤ 12	0	23.0	14.0
QPSK	10	> 12	0-1	23.0	14.0
16QAM	10	≤ 12	0-1	23.0	14.0
16QAM	10	> 12	0-2	23.0	14.0
QPSK	5	≤ 8	0	23.0	14.0
QPSK	5	> 8	0-1	23.0	14.0
16QAM	5	≤ 8	0-1	23.0	14.0
16QAM	5	> 8	0-2	23.0	14.0

Mode			Average Power (dBm)
2.4GHz	802.11b	CH 01	14.5
		CH 06	15.0
		CH 11	15.0
	802.11g		14.0
	802.11n-HT20		13.0
Bluetooth v3.0 + EDR			7.0
Bluetooth v4.1 LE			-2.5



4.4 General LTE SAR Test and Reporting Considerations

Summarized necessary items addressed in KDB 941225 D05 v02r03																																							
FCC ID	2ACCJB010																																						
Equipment Name	Tablet PC																																						
Operating Frequency Range of each LTE transmission band	LTE Band 26: 814.7 MHz ~ 848.3 MHz LTE Band 25: 1850.7 MHz ~ 1914.3 MHz LTE Band 41: 2498.5 MHz ~ 2687.5 MHz																																						
Channel Bandwidth	1.4MHz, 3MHz, 5MHz, 10MHz, 15MHz, 20MHz (LTE Band 25) 1.4MHz, 3MHz, 5MHz, 10MHz, 15MHz (LTE Band 26) 5MHz, 10MHz, 15MHz, 20MHz (LTE Band 41)																																						
uplink modulations used	QPSK, and 16QAM																																						
LTE Voice / Data requirements	Data only																																						
LTE MPR permanently built-in by design	<table border="1"> <caption>Table 6.2.3-1: Maximum Power Reduction (MPR) for Power Class 3</caption> <thead> <tr> <th rowspan="2">Modulation</th> <th colspan="6">Channel bandwidth / Transmission bandwidth (RB)</th> <th rowspan="2">MPR (dB)</th> </tr> <tr> <th>1.4 MHz</th> <th>3.0 MHz</th> <th>5 MHz</th> <th>10 MHz</th> <th>15 MHz</th> <th>20 MHz</th> </tr> </thead> <tbody> <tr> <td>QPSK</td> <td>> 5</td> <td>> 4</td> <td>> 8</td> <td>> 12</td> <td>> 16</td> <td>> 18</td> <td>≤ 1</td> </tr> <tr> <td>16 QAM</td> <td>≤ 5</td> <td>≤ 4</td> <td>≤ 8</td> <td>≤ 12</td> <td>≤ 16</td> <td>≤ 18</td> <td>≤ 1</td> </tr> <tr> <td>16 QAM</td> <td>> 5</td> <td>> 4</td> <td>> 8</td> <td>> 12</td> <td>> 16</td> <td>> 18</td> <td>≤ 2</td> </tr> </tbody> </table>	Modulation	Channel bandwidth / Transmission bandwidth (RB)						MPR (dB)	1.4 MHz	3.0 MHz	5 MHz	10 MHz	15 MHz	20 MHz	QPSK	> 5	> 4	> 8	> 12	> 16	> 18	≤ 1	16 QAM	≤ 5	≤ 4	≤ 8	≤ 12	≤ 16	≤ 18	≤ 1	16 QAM	> 5	> 4	> 8	> 12	> 16	> 18	≤ 2
Modulation	Channel bandwidth / Transmission bandwidth (RB)						MPR (dB)																																
	1.4 MHz	3.0 MHz	5 MHz	10 MHz	15 MHz	20 MHz																																	
QPSK	> 5	> 4	> 8	> 12	> 16	> 18	≤ 1																																
16 QAM	≤ 5	≤ 4	≤ 8	≤ 12	≤ 16	≤ 18	≤ 1																																
16 QAM	> 5	> 4	> 8	> 12	> 16	> 18	≤ 2																																
Release and Category	Rel 9, Cat 4																																						
LTE Carrier Aggregation Combinations	Not Supported																																						
LTE A-MPR	In the base station simulator configuration, Network Setting value is set to NS_01 to disable A-MPR during SAR testing and the LTE SAR tests was transmitting on all TTI frames (Maximum TTI)																																						
Spectrum plots for RB configuration	A properly configured base station simulator was used for the SAR and power measurement; therefore, spectrum plots for each RB allocation and offset configuration are not included in the SAR report.																																						
Power reduction applied to satisfy SAR compliance	Yes, proximity sensor.																																						

Transmission (H, M, L) channel numbers and frequencies in each LTE band												
LTE Band 26												
	Bandwidth 1.4 MHz		Bandwidth 3 MHz		Bandwidth 5 MHz		Bandwidth 10 MHz		Bandwidth 15 MHz			
	Ch. #	Freq. (MHz)	Ch. #	Freq. (MHz)	Ch. #	Freq. (MHz)	Ch. #	Freq. (MHz)	Ch. #	Freq. (MHz)		
L	26697	814.7	26705	815.5	26715	816.5	26740	819	26765	821.5		
M	26865	831.5	26865	831.5	26865	831.5	26865	831.5	26865	831.5		
H	27033	848.3	27025	847.5	27015	846.5	26990	844	26965	841.5		
LTE Band 25												
	Bandwidth 1.4 MHz		Bandwidth 3 MHz		Bandwidth 5 MHz		Bandwidth 10 MHz		Bandwidth 15 MHz		Bandwidth 20 MHz	
	Ch. #	Freq. (MHz)	Ch. #	Freq. (MHz)	Ch. #	Freq. (MHz)	Ch. #	Freq. (MHz)	Ch. #	Freq. (MHz)	Ch. #	Freq. (MHz)
L	26047	1850.7	26055	1851.5	26065	1852.5	26090	1855	26115	1857.5	26140	1860
M	26340	1880	26340	1880	26340	1880	26340	1880	26340	1880	26340	1880
H	26683	1914.3	26675	1913.5	26665	1912.5	26640	1910	26615	1907.5	26590	1905
LTE Band 41												
	Bandwidth 5 MHz		Bandwidth 10 MHz		Bandwidth 15 MHz		Bandwidth 20 MHz					
	Ch. #	Freq. (MHz)	Ch. #	Freq. (MHz)	Ch. #	Freq. (MHz)	Ch. #	Freq. (MHz)	Ch. #	Freq. (MHz)		
L	39675	2498.5	39700	2501	39725	2503.5	39750	2506				
L	40148	2545.8	40160	2547	40173	2548.3	40185	2549.5				
M	40620	2593	40620	2590	40620	2593	40620	2593				
H	41093	2640.3	41080	2639	41068	2637.8	41055	2636.5				
H	41565	2687.5	41540	2685	41515	2682.5	41490	2680				

5. Proximity Sensor Triggering Test

<Proximity Sensor Triggering Distance (KDB 616217 D04 section 6.2)>:

Proximity sensor triggering distance testing was performed according to the procedures outlined in KDB 616217 D04 section 6.2, and EUT moving further away from the flat phantom and EUT moving toward the flat phantom were both assessed. The details are illustrated in the exhibit “P-Sensor operational description”, and the shortest triggering distances were reported and used for SAR assessment.

In the preliminary triggering distance testing, the tissue-equivalent medium for different frequency bands were used for verification; no other frequency bands tissue-equivalent medium was found to result in shortest triggering distance than that for 1900MHz, and the tissue-equivalent medium for 1900MHz was used for formal proximity sensor triggering testing.

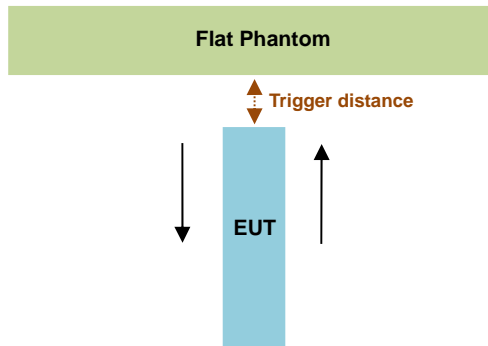

Proximity Sensor Trigger Distance (mm)		
Position	Bottom Face	Edge 1
Minimum	24	19

<Proximity Sensor Triggering Coverage (KDB 616217 D04 section 6.3)>:

If a sensor is spatially offset from the antenna(s), it is necessary to verify sensor triggering for conditions where the antenna is next to the user but the sensor is laterally further away to ensure sensor coverage is sufficient for reducing the power to maintain compliance. For p-sensor coverage testing, the device is moved and “along the direction of maximum antenna and sensor offset”.

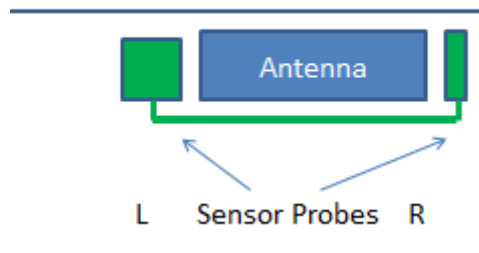

<Tablet Tilt angle influences to proximity sensor triggering (KDB 616217 D04 section 6.4)>:

The influence of table tilt angles to proximity sensor triggering was determined by positioning each tablet edge that contains a transmitting antenna, perpendicular to the flat phantom, at 19 mm separation. Rotating the tablet around the edge next to the phantom in $\leq 10^\circ$ increments until the tablet is $\pm 45^\circ$ from the vertical position at 0° , and the maximum output power remains in the reduced mode.

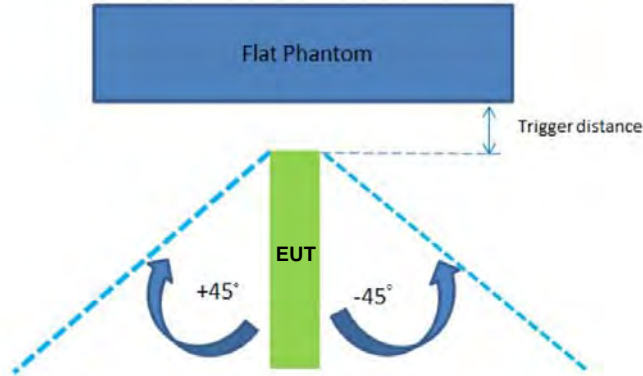

The Sensor Trigger Distance (mm)	
Position	Edge 1
Minimum	19

<Proximity sensor power reduction>

Exposure Position / wireless mode	Bottom Face ⁽¹⁾	Edge 1 ⁽¹⁾	Edge 2	Edge 3	Edge 4
LTE Band 26 (BW15, RB Size 1, RB Offset 0)	8 dB	8 dB	0 dB	0 dB	0 dB
LTE Band 25 (BW20, RB Size 1, RB Offset 0)	8 dB	8 dB	0 dB	0 dB	0 dB
LTE Band 41(BW20, RB Size 1, RB Offset 0)	9 dB	9 dB	0 dB	0 dB	0 dB

Remark:

1. ⁽¹⁾: Reduced maximum limit applied by activation of proximity sensor.
2. Power reduction is not applicable for WLAN and Bluetooth.
3. Tests were performed in accordance with KDB 616217 D04 section 6.1, 6.2, 6.3, 6.4 and 6.5.
4. For verification of compliance of power reduction scheme, additional SAR testing with EUT transmitting at full RF power at a conservative trigger distance was performed:
 - Bottom Face: 13 mm
 - Edge1: 13 mm

<Power Measurement during Sensor Trigger distance testing>

Band/Mode	Ch #	Measured power reduction (dBm)		Reduction Levels
		w/o power back-off	w/ power back-off	(dB)
LTE Band 26 (BW15, RB Size 1, RB Offset 0)	26865	22.56	14.59	7.97
LTE Band 25 (BW20, RB Size 1, RB Offset 0)	26340	22.93	14.97	7.96
LTE Band 41(BW20, RB Size 1, RB Offset 0)	40620	22.50	13.77	8.73

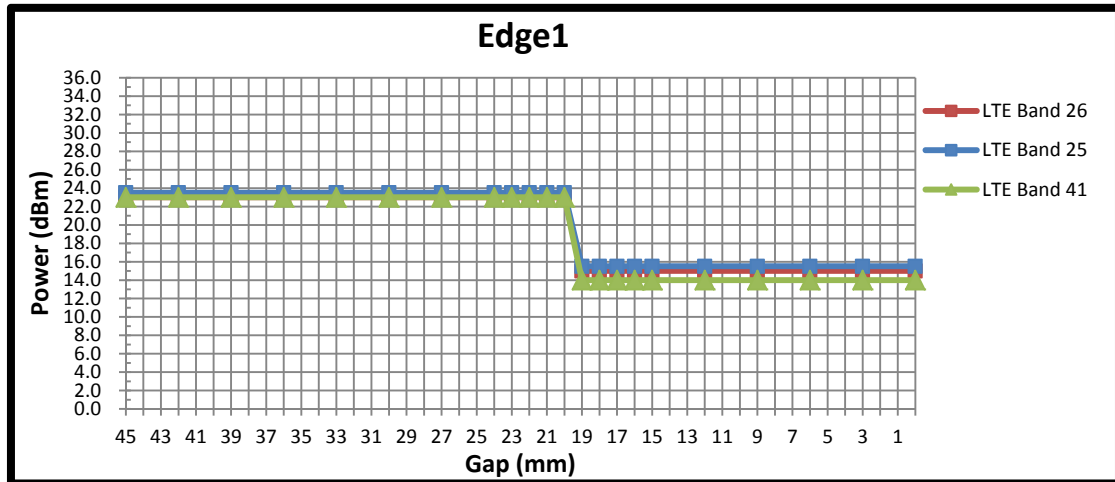
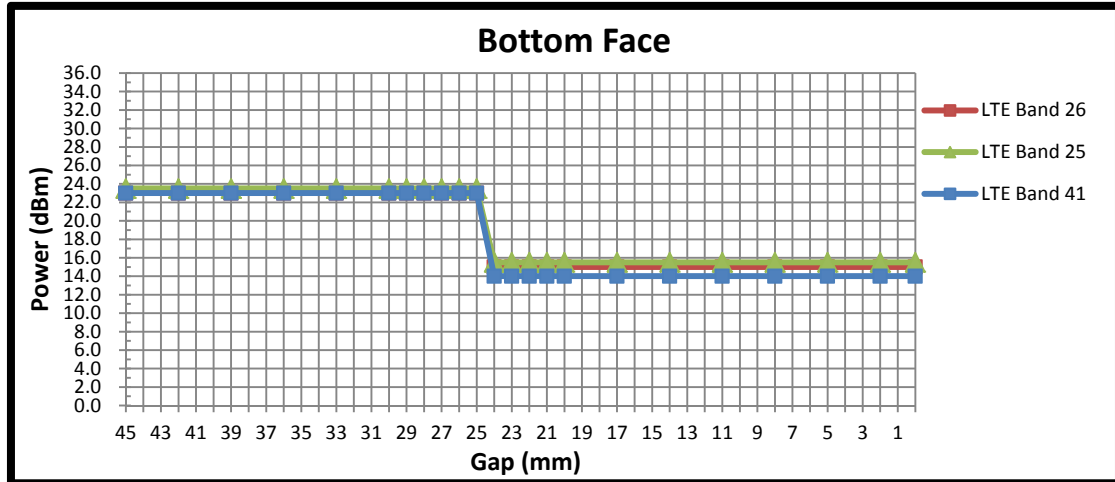

6. RF Exposure Limits

6.1 Uncontrolled Environment

Uncontrolled Environments are defined as locations where there is the exposure of individuals who have no knowledge or control of their exposure. The general population/uncontrolled exposure limits are applicable to situations in which the general public may be exposed or in which persons who are exposed as a consequence of their employment may not be made fully aware of the potential for exposure or cannot exercise control over their exposure. Members of the general public would come under this category when exposure is not employment-related; for example, in the case of a wireless transmitter that exposes persons in its vicinity.

6.2 Controlled Environment

Controlled Environments are defined as locations where there is exposure that may be incurred by persons who are aware of the potential for exposure, (i.e. as a result of employment or occupation). In general, occupational/controlled exposure limits are applicable to situations in which persons are exposed as a consequence of their employment, who have been made fully aware of the potential for exposure and can exercise control over their exposure. The exposure category is also applicable when the exposure is of a transient nature due to incidental passage through a location where the exposure levels may be higher than the general population/uncontrolled limits, but the exposed person is fully aware of the potential for exposure and can exercise control over his or her exposure by leaving the area or by some other appropriate means.

Limits for Occupational/Controlled Exposure (W/kg)

Whole-Body	Partial-Body	Hands, Wrists, Feet and Ankles
0.4	8.0	20.0

Limits for General Population/Uncontrolled Exposure (W/kg)

Whole-Body	Partial-Body	Hands, Wrists, Feet and Ankles
0.08	1.6	4.0

Whole-Body SAR is averaged over the entire body, partial-body SAR is averaged over any 1gram of tissue defined as a tissue volume in the shape of a cube. SAR for hands, wrists, feet and ankles is averaged over any 10 grams of tissue defined as a tissue volume in the shape of a cube.

7. Specific Absorption Rate (SAR)

7.1 Introduction

SAR is related to the rate at which energy is absorbed per unit mass in an object exposed to a radio field. The SAR distribution in a biological body is complicated and is usually carried out by experimental techniques or numerical modeling. The standard recommends limits for two tiers of groups, occupational/controlled and general population/uncontrolled, based on a person's awareness and ability to exercise control over his or her exposure. In general, occupational/controlled exposure limits are higher than the limits for general population/uncontrolled.

7.2 SAR Definition

The SAR definition is the time derivative (rate) of the incremental energy (dW) absorbed by (dissipated in) an incremental mass (dm) contained in a volume element (dv) of a given density (ρ). The equation description is as below:

$$SAR = \frac{d}{dt} \left(\frac{dW}{dm} \right) = \frac{d}{dt} \left(\frac{dW}{\rho dv} \right)$$

SAR is expressed in units of Watts per kilogram (W/kg)

$$SAR = \frac{\sigma |E|^2}{\rho}$$

Where: σ is the conductivity of the tissue, ρ is the mass density of the tissue and E is the RMS electrical field strength.

8. System Description and Setup

The DASY system used for performing compliance tests consists of the following items:

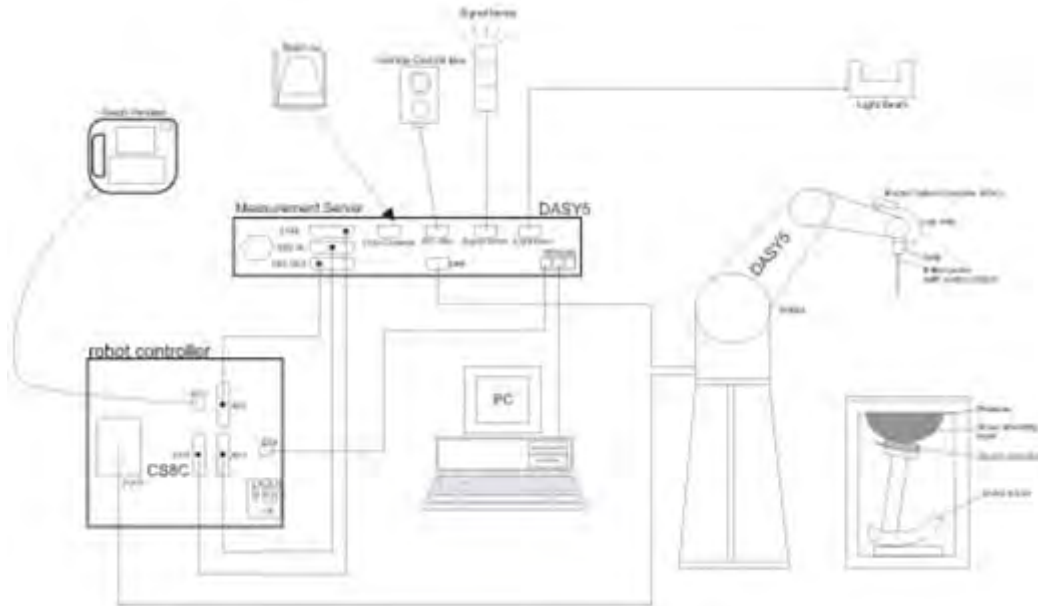

- A standard high precision 6-axis robot with controller, teach pendant and software. An arm extension for accommodating the data acquisition electronics (DAE).
- An isotropic Field probe optimized and calibrated for the targeted measurement.
- A data acquisition electronics (DAE) which performs the signal amplification, signal multiplexing, AD-conversion, offset measurements, mechanical surface detection, collision detection, etc. The unit is battery powered with standard or rechargeable batteries. The signal is optically transmitted to the EOC.
- The Electro-optical converter (EOC) performs the conversion from optical to electrical signals for the digital communication to the DAE. To use optical surface detection, a special version of the EOC is required. The EOC signal is transmitted to the measurement server.
- The function of the measurement server is to perform the time critical tasks such as signal filtering, control of the robot operation and fast movement interrupts.
- The Light Beam used is for probe alignment. This improves the (absolute) accuracy of the probe positioning.
- A computer running WinXP or Win7 and the DASY5 software.
- Remote control and teach pendant as well as additional circuitry for robot safety such as warning lamps, etc.
- The phantom, the device holder and other accessories according to the targeted measurement.

9. Measurement Procedures

The measurement procedures are as follows:

<Conducted power measurement>

- (a) For WWAN power measurement, use base station simulator to configure EUT WWAN transmission in conducted connection with RF cable, at maximum power in each supported wireless interface and frequency band.
- (b) Read the WWAN RF power level from the base station simulator.
- (c) For WLAN/BT power measurement, use engineering software to configure EUT WLAN/BT continuously transmission, at maximum RF power in each supported wireless interface and frequency band
- (d) Connect EUT RF port through RF cable to the power meter, and measure WLAN/BT output power

<SAR measurement>

- (a) Use base station simulator to configure EUT WWAN transmission in radiated connection, and engineering software to configure EUT WLAN/BT continuously transmission, at maximum RF power, in the highest power channel.
- (b) Place the EUT in the positions as Appendix D demonstrates.
- (c) Set scan area, grid size and other setting on the DASY software.
- (d) Measure SAR results for the highest power channel on each testing position.
- (e) Find out the largest SAR result on these testing positions of each band
- (f) Measure SAR results for other channels in worst SAR testing position if the reported SAR of highest power channel is larger than 0.8 W/kg

According to the test standard, the recommended procedure for assessing the peak spatial-average SAR value consists of the following steps:

- (a) Power reference measurement
- (b) Area scan
- (c) Zoom scan
- (d) Power drift measurement

9.1 Spatial Peak SAR Evaluation

The procedure for spatial peak SAR evaluation has been implemented according to the test standard. It can be conducted for 1g and 10g, as well as for user-specific masses. The DASY software includes all numerical procedures necessary to evaluate the spatial peak SAR value.

The base for the evaluation is a "cube" measurement. The measured volume must include the 1g and 10g cubes with the highest averaged SAR values. For that purpose, the center of the measured volume is aligned to the interpolated peak SAR value of a previously performed area scan.

The entire evaluation of the spatial peak values is performed within the post-processing engine (SEMCAD). The system always gives the maximum values for the 1g and 10g cubes. The algorithm to find the cube with highest averaged SAR is divided into the following stages:

- (a) Extraction of the measured data (grid and values) from the Zoom Scan
- (b) Calculation of the SAR value at every measurement point based on all stored data (A/D values and measurement parameters)
- (c) Generation of a high-resolution mesh within the measured volume
- (d) Interpolation of all measured values from the measurement grid to the high-resolution grid
- (e) Extrapolation of the entire 3-D field distribution to the phantom surface over the distance from sensor to surface
- (f) Calculation of the averaged SAR within masses of 1g and 10g

9.2 Power Reference Measurement

The Power Reference Measurement and Power Drift Measurements are for monitoring the power drift of the device under test in the batch process. The minimum distance of probe sensors to surface determines the closest measurement point to phantom surface. This distance cannot be smaller than the distance of sensor calibration points to probe tip as defined in the probe properties.

9.3 Area Scan

The area scan is used as a fast scan in two dimensions to find the area of high field values, before doing a fine measurement around the hot spot. The sophisticated interpolation routines implemented in DASY software can find the maximum found in the scanned area, within a range of the global maximum. The range (in dB0 is specified in the standards for compliance testing. For example, a 2 dB range is required in IEEE standard 1528 and IEC 62209 standards, whereby 3 dB is a requirement when compliance is assessed in accordance with the ARIB standard (Japan), if only one zoom scan follows the area scan, then only the absolute maximum will be taken as reference. For cases where multiple maximums are detected, the number of zoom scans has to be increased accordingly.

Area scan parameters extracted from FCC KDB 865664 D01v01r03 SAR measurement 100 MHz to 6 GHz.

	≤ 3 GHz	> 3 GHz
Maximum distance from closest measurement point (geometric center of probe sensors) to phantom surface	5 ± 1 mm	$\frac{1}{2} \cdot \delta \cdot \ln(2) \pm 0.5$ mm
Maximum probe angle from probe axis to phantom surface normal at the measurement location	30° ± 1°	20° ± 1°
Maximum area scan spatial resolution: $\Delta x_{Area}, \Delta y_{Area}$	≤ 2 GHz: ≤ 15 mm 2 – 3 GHz: ≤ 12 mm	3 – 4 GHz: ≤ 12 mm 4 – 6 GHz: ≤ 10 mm
	When the x or y dimension of the test device, in the measurement plane orientation, is smaller than the above, the measurement resolution must be ≤ the corresponding x or y dimension of the test device with at least one measurement point on the test device.	

9.4 Zoom Scan

Zoom scans are used assess the peak spatial SAR values within a cubic averaging volume containing 1 gram and 10 gram of simulated tissue. The zoom scan measures points (refer to table below) within a cube shoes base faces are centered on the maxima found in a preceding area scan job within the same procedure. When the measurement is done, the zoom scan evaluates the averaged SAR for 1 gram and 10 gram and displays these values next to the job's label.

Zoom scan parameters extracted from FCC KDB 865664 D01v01r03 SAR measurement 100 MHz to 6 GHz.

		≤ 3 GHz	> 3 GHz	
Maximum zoom scan spatial resolution: $\Delta x_{Zoom}, \Delta y_{Zoom}$		≤ 2 GHz: ≤ 8 mm 2 – 3 GHz: ≤ 5 mm*	3 – 4 GHz: ≤ 5 mm* 4 – 6 GHz: ≤ 4 mm*	
Maximum zoom scan spatial resolution, normal to phantom surface	uniform grid: $\Delta z_{Zoom}(n)$	≤ 5 mm	3 – 4 GHz: ≤ 4 mm 4 – 5 GHz: ≤ 3 mm 5 – 6 GHz: ≤ 2 mm	
	graded grid	$\Delta z_{Zoom}(1)$: between 1 st two points closest to phantom surface	≤ 4 mm	3 – 4 GHz: ≤ 3 mm 4 – 5 GHz: ≤ 2.5 mm 5 – 6 GHz: ≤ 2 mm
		$\Delta z_{Zoom}(n>1)$: between subsequent points	$\leq 1.5 \cdot \Delta z_{Zoom}(n-1)$	
Minimum zoom scan volume	x, y, z	≥ 30 mm	3 – 4 GHz: ≥ 28 mm 4 – 5 GHz: ≥ 25 mm 5 – 6 GHz: ≥ 22 mm	
Note: δ is the penetration depth of a plane-wave at normal incidence to the tissue medium; see draft standard IEEE P1528-2011 for details. * When zoom scan is required and the <i>reported</i> SAR from the <i>area scan based 1-g SAR estimation</i> procedures of KDB 447498 is ≤ 1.4 W/kg, ≤ 8 mm, ≤ 7 mm and ≤ 5 mm zoom scan resolution may be applied, respectively, for 2 GHz to 3 GHz, 3 GHz to 4 GHz and 4 GHz to 6 GHz.				

9.5 Volume Scan Procedures

The volume scan is used for assess overlapping SAR distributions for antennas transmitting in different frequency bands. It is equivalent to an oversized zoom scan used in standalone measurements. The measurement volume will be used to enclose all the simultaneous transmitting antennas. For antennas transmitting simultaneously in different frequency bands, the volume scan is measured separately in each frequency band. In order to sum correctly to compute the 1g aggregate SAR, the EUT remain in the same test position for all measurements and all volume scan use the same spatial resolution and grid spacing. When all volume scan were completed, the software, SEMCAD postprocessor can combine and subsequently superpose these measurement data to calculating the multiband SAR.

9.6 Power Drift Monitoring

All SAR testing is under the EUT install full charged battery and transmit maximum output power. In DASY measurement software, the power reference measurement and power drift measurement procedures are used for monitoring the power drift of EUT during SAR test. Both these procedures measure the field at a specified reference position before and after the SAR testing. The software will calculate the field difference in dB. If the power drifts more than 5%, the SAR will be retested.



10. Test Equipment List

Manufacturer	Name of Equipment	Type/Model	Serial Number	Calibration	
				Last Cal.	Due Date
SPEAG	835MHz System Validation Kit	D835V2	4d091	Nov. 21, 2014	Nov. 20, 2015
SPEAG	1900MHz System Validation Kit	D1900V2	5d118	Nov. 21, 2014	Nov. 20, 2015
SPEAG	2450MHz System Validation Kit	D2450V2	840	Nov. 19, 2014	Nov. 18, 2015
SPEAG	2600MHz System Validation Kit	D2600V2	1061	Nov. 19, 2014	Nov. 18, 2015
SPEAG	Data Acquisition Electronics	DAE4	1303	Dec. 11, 2014	Dec. 10, 2015
SPEAG	Dosimetric E-Field Probe	EX3DV4	3819	Nov. 13, 2014	Nov. 12, 2015
SPEAG	ELI4 Phantom	QD OVA 002 AA	1149	NCR	NCR
SPEAG	Phone Positioner	N/A	N/A	NCR	NCR
Anritsu	Radio communication analyzer	MT8820C	6201432827	Jan. 15, 2015	Jan. 14, 2016
R&S	Bluetooth Tester	CBT	100783	Aug. 11, 2014	Aug. 10, 2015
R&S	Network Analyzer	ZVB8	100106	Sep. 29, 2014	Sep. 28, 2015
Speag	Dielectric Assessment Kit	DAK-3.5	1032	NCR	NCR
R&S	Signal Generator	SMBV100A	258305	Jan. 23, 2015	Jan. 22, 2016
Anritsu	Power Meter	ML2495A	1218010	Jan. 28, 2015	Jan. 27, 2016
Anritsu	Power Sensor	MA2411B	1207253	Jan. 28, 2015	Jan. 27, 2016
ARRA	Power Divider	A3200-2	N/A	NA	NA
R&S	Spectrum Analyzer	FSP30	101362	Sep. 29, 2014	Sep. 28, 2015
Agilent	Dual Directional Coupler	778D	50422	Note1	
Woken	Attenuator 1	WK0602-XX	N/A	Note1	
PE	Attenuator 2	PE7005-10	N/A	Note1	
PE	Attenuator 3	PE7005- 3	N/A	Note1	
AR	Power Amplifier	5S1G4M2	0328767	Note1	
Mini-Circuits	Power Amplifier	ZVE-3W	162601250	Note1	
Mini-Circuits	Power Amplifier	ZHL-42W+	13440021344	Note1	

General Note:

1. Prior to system verification and validation, the path loss from the signal generator to the system check source and the power meter, which includes the amplifier, cable, attenuator and directional coupler, was measured by the network analyzer. The reading of the power meter was offset by the path loss difference between the path to the power meter and the path to the system check source to monitor the actual power level fed to the system check source.

11. System Verification

11.1 Tissue Verification

The following tissue formulations are provided for reference only as some of the parameters have not been thoroughly verified. The composition of ingredients may be modified accordingly to achieve the desired target tissue parameters required for routine SAR evaluation.

Frequency (MHz)	Water (%)	Sugar (%)	Cellulose (%)	Salt (%)	Preventol (%)	DGBE (%)	Conductivity (σ)	Permittivity (ϵ_r)
For Head								
835	40.3	57.9	0.2	1.4	0.2	0	0.90	41.5
1800, 1900, 2000	55.2	0	0	0.3	0	44.5	1.40	40.0
2450	55.0	0	0	0	0	45.0	1.80	39.2
2600	54.8	0	0	0.1	0	45.1	1.96	39.0
For Body								
835	50.8	48.2	0	0.9	0.1	0	0.97	55.2
1800, 1900, 2000	70.2	0	0	0.4	0	29.4	1.52	53.3
2450	68.6	0	0	0	0	31.4	1.95	52.7
2600	68.1	0	0	0.1	0	31.8	2.16	52.5

<Tissue Dielectric Parameter Check Results>

Frequency (MHz)	Tissue Type	Liquid Temp. (°C)	Conductivity (σ)	Permittivity (ϵ_r)	Conductivity Target (σ)	Permittivity Target (ϵ_r)	Delta (σ) (%)	Delta (ϵ_r) (%)	Limit (%)	Date
835	Body	22.8	0.974	54.266	0.97	55.20	0.41	-1.69	±5	Jul. 23, 2015
1900	Body	22.8	1.576	54.215	1.52	53.30	3.68	1.72	±5	Jul. 22, 2015
2450	Body	22.7	1.992	52.291	1.95	52.70	2.15	-0.78	±5	Jul. 20, 2015
2600	Body	22.8	2.165	53.823	2.16	52.50	0.23	2.52	±5	Jul. 17, 2015
2600	Body	22.9	2.209	51.123	2.16	52.50	2.27	-2.62	±5	Jul. 19, 2015

11.2 System Performance Check Results

Comparing to the original SAR value provided by SPEAG, the verification data should be within its specification of 10 %. Below table shows the target SAR and measured SAR after normalized to 1W input power. The table below indicates the system performance check can meet the variation criterion and the plots can be referred to Appendix A of this report.

Date	Frequency (MHz)	Tissue Type	Input Power (mW)	Dipole S/N	Probe S/N	DAE S/N	Measured SAR (W/kg)	Targeted SAR (W/kg)	Normalized SAR (W/kg)	Deviation (%)
Jul. 23, 2015	835	Body	250	4d091	3819	1303	2.56	9.60	10.24	6.67
Jul. 22, 2015	1900	Body	250	5d118	3819	1303	10.40	40.00	41.6	4.00
Jul. 20, 2015	2450	Body	250	840	3819	1303	12.90	51.00	51.6	1.18
Jul. 17, 2015	2600	Body	250	1061	3819	1303	14.40	54.90	57.6	4.92
Jul. 19, 2015	2600	Body	250	1061	3819	1303	14.50	54.90	58	5.65

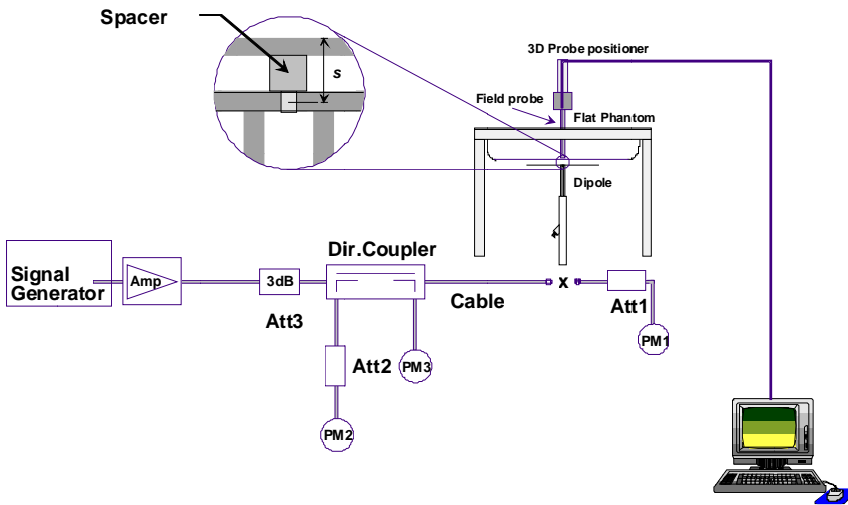

Fig 8.3.1 System Performance Check Setup



Fig 8.3.2 Setup Photo



12. RF Exposure Positions

12.1 SAR Testing for Tablet

This device can be used also in full sized tablet exposure conditions, due to its size. Per FCC KDB 616217, the back surface and edges of the tablet should be tested for SAR compliance with the tablet touching the phantom. The SAR exclusion threshold in KDB 447498 D01v05r02 can be applied to determine SAR test exclusion for adjacent edge configurations. The closest distance from the antenna to an adjacent tablet edge is used to determine if SAR testing is required for the adjacent edges, with the adjacent edge positioned against the phantom and the edge containing the antenna positioned perpendicular to the phantom.

This EUT was tested in five different positions. They are bottom-face of tablet PC, Edge1, Edge2, Edge3, Edge4. EUT has proximity sensor function, it would be on bottom-face, Edge1, the sensor trigger distance is 13mm for bottom-face, Edge1, EUT transmitting with reduced power was performed. Additionally the surface of EUT is tested with phantom 13 mm for bottom-face, Edge1 with full power.



13. Conducted RF Output Power (Unit: dBm)

<LTE Conducted Power>

General Note:

1. Anritsu MT8820C base station simulator was used to setup the connection with EUT; the frequency band, channel bandwidth, RB allocation configuration, modulation type are set in the base station simulator to configure EUT transmitting at maximum power and at different configurations which are requested to be reported to FCC, for conducted power measurement and SAR testing.
2. Per KDB 941225 D05v02r03, when a properly configured base station simulator is used for the SAR and power measurements, spectrum plots for each RB allocation and offset configuration is not required.
3. Per KDB 941225 D05v02r03, start with the largest channel bandwidth and measure SAR for QPSK with 1 RB allocation, using the RB offset and required test channel combination with the highest maximum output power for RB offsets at the upper edge, middle and lower edge of each required test channel.
4. Per KDB 941225 D05v02r03, 50% RB allocation for QPSK SAR testing follows 1RB QPSK allocation procedure.
5. Per KDB 941225 D05v02r03, For QPSK with 100% RB allocation, SAR is not required when the highest maximum output power for 100 % RB allocation is less than the highest maximum output power in 50% and 1 RB allocations and the highest reported SAR for 1 RB and 50% RB allocation are ≤ 0.8 W/kg. Otherwise, SAR is measured for the highest output power channel; and if the reported SAR is > 1.45 W/kg, the remaining required test channels must also be tested.
6. Per KDB 941225 D05v02r03, 16QAM output power for each RB allocation configuration is $>$ not $\frac{1}{2}$ dB higher than the same configuration in QPSK and the reported SAR for the QPSK configuration is ≤ 1.45 W/kg; Per KDB 941225 D05v02r03, 16QAM SAR testing is not required.
7. Per KDB 941225 D05v02r03, Smaller bandwidth output power for each RB allocation configuration is $>$ not $\frac{1}{2}$ dB higher than the same configuration in the largest supported bandwidth, and the reported SAR for the largest supported bandwidth is ≤ 1.45 W/kg; Per KDB 941225 D05v02r03, smaller bandwidth SAR testing is not required.
8. Tests were performed when EUT operating without power back-off and operating with power back-off in accordance with general note 3, 4, 5, 6, 7 as above.



Maximum Average RF Power (Proximity Sensor Inactive)

<FDD LTE Band 26>

BW [MHz]	Modulation	RB Size	RB Offset	Power Low Ch. / Freq.	Power Middle Ch. / Freq.	Power High Ch. / Freq.	Tune up Limit (dBm)	MPR (dB)
Channel				26765	26865	26965		
Frequency (MHz)				821.5	831.5	841.5		
15	QPSK	1	0	22.40	22.56	22.50		
15	QPSK	1	37	22.13	22.44	22.28	23.0	0
15	QPSK	1	74	21.96	22.45	22.32		
15	QPSK	36	0	21.33	21.60	21.46		
15	QPSK	36	18	21.15	21.48	21.26	22.0	0-1
15	QPSK	36	37	21.22	21.50	21.29		
15	QPSK	75	0	21.21	21.52	21.25		
15	16QAM	1	0	21.33	21.33	21.95	22.0	0-1
15	16QAM	1	37	20.89	21.31	21.76		
15	16QAM	1	74	20.77	21.47	21.58		
15	16QAM	36	0	20.22	20.56	20.55	21.0	0-2
15	16QAM	36	18	20.08	20.55	20.38		
15	16QAM	36	37	20.28	20.60	20.50		
15	16QAM	75	0	20.03	20.53	20.37		
Channel				26740	26865	26990	Tune up Limit (dBm)	MPR (dB)
Frequency (MHz)				819	831.5	844		
10	QPSK	1	0	22.18	22.34	22.47		
10	QPSK	1	24	22.30	22.45	22.46	23.0	0
10	QPSK	1	49	21.95	22.36	22.48		
10	QPSK	25	0	21.11	21.52	21.49		
10	QPSK	25	12	21.23	21.51	21.35	22.0	0-1
10	QPSK	25	24	21.19	21.53	21.38		
10	QPSK	50	0	21.20	21.49	21.38		
10	16QAM	1	0	21.58	21.74	21.51	22.0	0-1
10	16QAM	1	24	21.49	21.82	21.72		
10	16QAM	1	49	21.40	21.50	21.65		
10	16QAM	25	0	20.21	20.49	20.37	21.0	0-2
10	16QAM	25	12	20.21	20.55	20.36		
10	16QAM	25	24	20.17	20.42	20.36		
10	16QAM	50	0	20.11	20.48	20.40		
Channel				26715	26865	27015	Tune up Limit (dBm)	MPR (dB)
Frequency (MHz)				816.5	831.5	846.5		
5	QPSK	1	0	22.35	22.39	22.46		
5	QPSK	1	12	22.22	22.41	22.47	23.0	0
5	QPSK	1	24	22.04	22.31	22.22		
5	QPSK	12	0	21.24	21.50	21.40		
5	QPSK	12	6	21.09	21.54	21.46	22.0	0-1
5	QPSK	12	11	21.07	21.49	21.34		
5	QPSK	25	0	21.07	21.50	21.37		
5	16QAM	1	0	21.99	21.95	21.65	22.0	0-1
5	16QAM	1	12	21.41	21.93	21.90		
5	16QAM	1	24	21.40	21.76	21.62		
5	16QAM	12	0	20.20	20.65	20.38	21.0	0-2
5	16QAM	12	6	20.02	20.41	20.29		
5	16QAM	12	11	20.11	20.60	20.40		
5	16QAM	25	0	20.08	20.53	20.34		



Channel				26705	26865	27025	Tune up Limit (dBm)	MPR (dB)
Frequency (MHz)				815.5	831.5	847.5		
3	QPSK	1	0	22.33	22.41	22.25	23.0	0
3	QPSK	1	7	22.17	22.47	22.47		
3	QPSK	1	14	21.94	22.38	22.32		
3	QPSK	8	0	21.15	21.51	21.41	22.0	0-1
3	QPSK	8	4	21.08	21.40	21.50		
3	QPSK	8	7	21.12	21.36	21.37		
3	QPSK	15	0	21.15	21.44	21.38		
3	16QAM	1	0	21.50	21.92	21.87	22.0	0-1
3	16QAM	1	7	21.77	21.89	21.72		
3	16QAM	1	14	21.21	21.85	21.53		
3	16QAM	8	0	20.16	20.54	20.17	21.0	0-2
3	16QAM	8	4	20.20	20.63	20.14		
3	16QAM	8	7	20.26	20.58	20.37		
3	16QAM	8	7	20.26	20.58	20.37		
3	16QAM	15	0	20.12	20.49	20.27		
Channel				26697	26865	27033	Tune up Limit (dBm)	MPR (dB)
Frequency (MHz)				814.7	831.5	848.3		
1.4	QPSK	1	0	22.28	22.19	22.27	23.0	0
1.4	QPSK	1	2	22.20	22.35	22.18		
1.4	QPSK	1	5	22.11	22.32	22.14		
1.4	QPSK	3	0	22.37	22.49	22.31		
1.4	QPSK	3	1	22.35	22.46	22.41		
1.4	QPSK	3	2	22.25	22.35	22.38		
1.4	QPSK	6	0	21.26	21.42	21.47	22.0	0-1
1.4	16QAM	1	0	21.27	21.37	21.80	22.0	0-1
1.4	16QAM	1	2	21.36	21.36	21.32		
1.4	16QAM	1	5	21.14	21.40	21.45		
1.4	16QAM	3	0	21.18	21.48	21.71		
1.4	16QAM	3	1	21.18	21.53	21.50		
1.4	16QAM	3	2	21.41	21.46	21.67		
1.4	16QAM	6	0	20.13	20.34	20.16	21.0	0-2



<FDD LTE Band 25>

BW [MHz]	Modulation	RB Size	RB Offset	Power Low Ch. / Freq.	Power Middle Ch. / Freq.	Power High Ch. / Freq.	Tune up Limit (dBm)	MPR (dB)
Channel				26140	26340	26590		
Frequency (MHz)				1860	1880	1905		
20	QPSK	1	0	23.11	22.93	23.00	23.5	0
20	QPSK	1	49	22.92	22.87	22.87		
20	QPSK	1	99	22.64	22.88	22.85		
20	QPSK	50	0	22.15	22.05	21.94	22.5	0-1
20	QPSK	50	24	21.92	21.98	21.81		
20	QPSK	50	49	21.93	22.02	21.88		
20	QPSK	100	0	22.05	22.02	21.85	22.5	0-1
20	16QAM	1	0	22.45	22.44	22.39		
20	16QAM	1	49	22.41	22.27	22.48		
20	16QAM	1	99	22.20	22.15	21.97	21.5	0-2
20	16QAM	50	0	20.85	20.81	20.64		
20	16QAM	50	24	20.77	20.91	20.83		
20	16QAM	50	49	20.85	20.81	20.83	21.5	0-2
20	16QAM	100	0	20.93	20.84	20.85		
Channel				26115	26340	26615	Tune up Limit (dBm)	MPR (dB)
Frequency (MHz)				1857.5	1880	1907.5		
15	QPSK	1	0	23.06	22.85	22.81	23.5	0
15	QPSK	1	37	23.05	22.79	22.89		
15	QPSK	1	74	22.95	22.66	22.73		
15	QPSK	36	0	21.90	22.00	21.80	22.5	0-1
15	QPSK	36	18	21.91	21.94	21.80		
15	QPSK	36	37	21.95	21.87	21.74		
15	QPSK	75	0	21.83	21.84	21.78	22.5	0-1
15	16QAM	1	0	21.85	22.41	22.18		
15	16QAM	1	37	22.05	22.45	22.22		
15	16QAM	1	74	21.99	22.13	22.13	21.5	0-2
15	16QAM	36	0	20.74	20.90	20.77		
15	16QAM	36	18	20.76	20.87	20.75		
15	16QAM	36	37	20.86	20.84	20.72	21.5	0-2
15	16QAM	75	0	20.82	20.84	20.68		
Channel				26090	26340	26640	Tune up Limit (dBm)	MPR (dB)
Frequency (MHz)				1855	1880	1910		
10	QPSK	1	0	22.97	22.90	22.87	23.5	0
10	QPSK	1	24	22.90	22.86	22.84		
10	QPSK	1	49	22.88	22.84	22.80		
10	QPSK	25	0	21.88	21.92	21.82	22.5	0-1
10	QPSK	25	12	21.88	21.93	21.75		
10	QPSK	25	24	21.88	21.98	21.84		
10	QPSK	50	0	21.88	21.89	21.79	22.5	0-1
10	16QAM	1	0	22.43	22.20	22.41		
10	16QAM	1	24	22.46	22.50	22.32		
10	16QAM	1	49	22.24	22.10	22.39	21.5	0-2
10	16QAM	25	0	20.92	20.87	20.88		
10	16QAM	25	12	20.78	20.87	20.71		
10	16QAM	25	24	20.81	20.85	20.78	21.5	0-2
10	16QAM	50	0	20.71	20.78	20.78		



Channel				26065	26340	26665	Tune up Limit (dBm)	MPR (dB)
Frequency (MHz)				1852.5	1880	1912.5		
5	QPSK	1	0	22.74	22.87	22.63	23.5	0
5	QPSK	1	12	22.75	22.87	22.77		
5	QPSK	1	24	22.65	22.75	22.71		
5	QPSK	12	0	21.93	21.94	21.75	22.5	0-1
5	QPSK	12	6	21.81	21.84	21.64		
5	QPSK	12	11	21.90	21.84	21.69		
5	QPSK	25	0	21.92	21.81	21.70		
5	16QAM	1	0	22.25	21.82	22.09	22.5	0-1
5	16QAM	1	12	22.01	22.42	22.41		
5	16QAM	1	24	22.34	21.40	21.87		
5	16QAM	12	0	20.93	20.83	20.63	21.5	0-2
5	16QAM	12	6	20.84	20.96	20.64		
5	16QAM	12	11	20.66	20.73	20.88		
5	16QAM	25	0	20.84	20.82	20.80		
Channel				26055	26340	26675	Tune up Limit (dBm)	MPR (dB)
Frequency (MHz)				1851.5	1880	1913.5		
3	QPSK	1	0	22.78	22.78	22.69	23.5	0
3	QPSK	1	7	22.72	22.89	22.67		
3	QPSK	1	14	22.76	22.86	22.58		
3	QPSK	8	0	21.87	21.96	21.90	22.5	0-1
3	QPSK	8	4	21.99	22.02	21.84		
3	QPSK	8	7	21.93	21.96	21.87		
3	QPSK	15	0	21.83	21.99	21.77		
3	16QAM	1	0	22.14	22.36	22.06	22.5	0-1
3	16QAM	1	7	22.11	21.98	21.85		
3	16QAM	1	14	22.26	22.24	21.75		
3	16QAM	8	0	20.63	20.96	20.62	21.5	0-2
3	16QAM	8	4	20.74	20.84	20.68		
3	16QAM	8	7	20.85	20.91	20.53		
3	16QAM	15	0	20.83	21.05	20.65		
Channel				26047	26340	26683	Tune up Limit (dBm)	MPR (dB)
Frequency (MHz)				1850.7	1880	1914.3		
1.4	QPSK	1	0	22.85	22.80	22.73	23.5	0
1.4	QPSK	1	2	22.93	22.76	22.69		
1.4	QPSK	1	5	22.82	22.91	22.63		
1.4	QPSK	3	0	22.86	22.85	22.68		
1.4	QPSK	3	1	22.87	22.90	22.72		
1.4	QPSK	3	2	22.84	22.88	22.65		
1.4	QPSK	6	0	21.86	21.85	21.59	22.5	0-1
1.4	16QAM	1	0	21.52	22.19	22.07	22.5	0-1
1.4	16QAM	1	2	21.56	22.45	22.35		
1.4	16QAM	1	5	22.06	22.45	22.30		
1.4	16QAM	3	0	21.81	22.00	21.78		
1.4	16QAM	3	1	22.04	22.14	21.94		
1.4	16QAM	3	2	21.83	21.98	21.96		
1.4	16QAM	6	0	20.65	20.81	20.73	21.5	0-2



Reduced Average RF Power (Proximity Sensor Active)
<FDD LTE Band 26>

BW [MHz]	Modulation	RB Size	RB Offset	Power Low Ch. / Freq.	Power Middle Ch. / Freq.	Power High Ch. / Freq.	Tune up Limit (dBm)	MPR (dB)
Channel				26765	26865	26965	15.0	0
Frequency (MHz)				821.5	831.5	841.5		
15	QPSK	1	0	14.44	14.59	14.58	15.0	0
15	QPSK	1	37	14.32	14.48	14.49		
15	QPSK	1	74	14.30	14.51	14.53		
15	QPSK	36	0	14.35	14.53	14.52	15.0	0-1
15	QPSK	36	18	14.27	14.42	14.45		
15	QPSK	36	37	14.23	14.41	14.45		
15	QPSK	75	0	14.30	14.51	14.49	15.0	0-1
15	16QAM	1	0	14.16	14.39	14.36		
15	16QAM	1	37	14.15	14.38	14.11		
15	16QAM	1	74	13.86	14.17	14.00	15.0	0-2
15	16QAM	36	0	13.99	14.23	14.34		
15	16QAM	36	18	13.98	14.15	14.18		
15	16QAM	36	37	14.00	14.28	14.30	15.0	0-2
15	16QAM	36	74	14.01	14.27	14.29		
Channel				26740	26865	26990		
Frequency (MHz)				819	831.5	844		
10	QPSK	1	0	14.29	14.29	14.28	15.0	0
10	QPSK	1	24	14.28	14.38	14.38		
10	QPSK	1	49	14.05	14.23	14.40		
10	QPSK	25	0	14.16	14.34	14.33	15.0	0-1
10	QPSK	25	12	14.19	14.23	14.36		
10	QPSK	25	24	14.24	14.18	14.37		
10	QPSK	50	0	14.25	14.25	14.31	15.0	0-1
10	16QAM	1	0	13.79	14.37	14.41		
10	16QAM	1	24	13.87	14.28	14.40		
10	16QAM	1	49	13.89	14.24	14.37	15.0	0-2
10	16QAM	25	0	13.88	14.31	14.39		
10	16QAM	25	12	13.78	14.32	14.42		
10	16QAM	25	24	13.76	14.28	14.14	15.0	0-2
10	16QAM	25	49	13.73	14.22	14.26		
Channel				26715	26865	27015		
Frequency (MHz)				816.5	831.5	846.5		
5	QPSK	1	0	14.28	14.38	14.39	15.0	0
5	QPSK	1	12	14.31	14.39	14.36		
5	QPSK	1	24	14.17	14.29	14.33		
5	QPSK	12	0	14.31	14.38	14.42	15.0	0-1
5	QPSK	12	6	14.23	14.37	14.37		
5	QPSK	12	11	14.24	14.36	14.38		
5	QPSK	25	0	14.21	14.35	14.39	15.0	0-1
5	16QAM	1	0	14.10	14.38	14.40		
5	16QAM	1	12	14.07	14.42	14.41		
5	16QAM	1	24	14.00	14.41	14.38	15.0	0-2
5	16QAM	12	0	14.03	14.30	14.33		
5	16QAM	12	6	13.87	14.33	14.20		
5	16QAM	12	11	13.84	14.33	14.37	15.0	0-2
5	16QAM	12	24	13.85	14.37	14.38		



Channel				26705	26865	27025	Tune up Limit (dBm)	MPR (dB)
Frequency (MHz)				815.5	831.5	847.5		
3	QPSK	1	0	14.12	14.40	14.41	15.0	0
3	QPSK	1	7	14.30	14.33	14.38		
3	QPSK	1	14	13.97	14.26	14.33		
3	QPSK	8	0	13.78	14.36	14.40	15.0	0-1
3	QPSK	8	4	13.83	14.34	14.36		
3	QPSK	8	7	13.84	14.36	14.33		
3	QPSK	15	0	14.23	14.41	14.33		
3	16QAM	1	0	14.33	14.43	14.43	15.0	0-1
3	16QAM	1	7	14.28	14.41	14.45		
3	16QAM	1	14	14.26	14.35	14.47		
3	16QAM	8	0	14.02	14.11	14.50	15.0	0-2
3	16QAM	8	4	13.80	14.09	14.40		
3	16QAM	8	7	13.96	14.24	14.38		
3	16QAM	15	0	14.31	14.42	14.49		
Channel				26697	26865	27033	Tune up Limit (dBm)	MPR (dB)
Frequency (MHz)				814.7	831.5	848.3		
1.4	QPSK	1	0	14.16	14.40	14.47	15.0	0
1.4	QPSK	1	2	14.26	14.39	14.50		
1.4	QPSK	1	5	14.05	14.35	14.44		
1.4	QPSK	3	0	14.20	14.35	14.49		
1.4	QPSK	3	1	14.29	14.36	14.49		
1.4	QPSK	3	2	14.30	14.38	14.49	15.0	0-1
1.4	QPSK	6	0	14.28	14.34	14.49		
1.4	16QAM	1	0	14.31	14.36	14.51	15.0	0-1
1.4	16QAM	1	2	14.30	14.42	14.49		
1.4	16QAM	1	5	14.30	14.40	14.50		
1.4	16QAM	3	0	14.29	14.36	14.46		
1.4	16QAM	3	1	14.28	14.41	14.37		
1.4	16QAM	3	2	14.24	14.38	14.39		
1.4	16QAM	6	0	14.32	14.43	14.44	15.0	0-2



<FDD LTE Band 25>

BW [MHz]	Modulation	RB Size	RB Offset	Power Low Ch. / Freq.	Power Middle Ch. / Freq.	Power High Ch. / Freq.	Tune up Limit (dBm)	MPR (dB)
Channel				26140	26340	26590		
Frequency (MHz)				1860	1880	1905		
20	QPSK	1	0	14.99	14.97	14.94	15.5	0
20	QPSK	1	49	14.90	14.95	14.86		
20	QPSK	1	99	14.58	14.73	14.72		
20	QPSK	50	0	14.83	14.82	14.80	15.5	0-1
20	QPSK	50	24	14.59	14.80	14.70		
20	QPSK	50	49	14.65	14.81	14.71		
20	QPSK	100	0	14.78	14.75	14.75	15.5	0-1
20	16QAM	1	0	14.74	14.77	14.56		
20	16QAM	1	49	14.82	14.78	14.47		
20	16QAM	1	99	14.48	14.53	14.56	15.5	0-2
20	16QAM	50	0	14.68	14.59	14.78		
20	16QAM	50	24	14.57	14.76	14.75		
20	16QAM	50	49	14.43	14.71	14.65	15.5	0-2
20	16QAM	100	0	14.65	14.75	14.66		
Channel				26115	26340	26615	Tune up Limit (dBm)	MPR (dB)
Frequency (MHz)				1857.5	1880	1907.5		
15	QPSK	1	0	14.78	14.93	14.58	15.5	0
15	QPSK	1	37	14.77	14.88	14.66		
15	QPSK	1	74	14.75	14.92	14.58		
15	QPSK	36	0	14.66	14.87	14.63	15.5	0-1
15	QPSK	36	18	14.60	14.82	14.54		
15	QPSK	36	37	14.66	14.79	14.53		
15	QPSK	75	0	14.55	14.82	14.58	15.5	0-1
15	16QAM	1	0	14.67	14.80	14.55		
15	16QAM	1	37	14.63	14.77	14.43		
15	16QAM	1	74	14.42	14.96	14.64	15.5	0-2
15	16QAM	36	0	14.58	14.73	14.50		
15	16QAM	36	18	14.57	14.95	14.41		
15	16QAM	36	37	14.57	14.84	14.66	15.5	0-2
15	16QAM	75	0	14.63	14.63	14.51		
Channel				26090	26340	26640	Tune up Limit (dBm)	MPR (dB)
Frequency (MHz)				1855	1880	1910		
10	QPSK	1	0	14.20	14.64	14.72	15.5	0
10	QPSK	1	24	14.85	14.76	14.71		
10	QPSK	1	49	14.33	14.64	14.47		
10	QPSK	25	0	14.59	14.68	14.57	15.5	0-1
10	QPSK	25	12	14.62	14.72	14.65		
10	QPSK	25	24	14.38	14.70	14.70		
10	QPSK	50	0	14.58	14.66	14.66	15.5	0-1
10	16QAM	1	0	14.73	14.95	14.78		
10	16QAM	1	24	14.81	14.95	14.77		
10	16QAM	1	49	14.59	14.93	14.71	15.5	0-2
10	16QAM	25	0	14.66	14.62	14.60		
10	16QAM	25	12	14.77	14.80	14.61		
10	16QAM	25	24	14.56	14.79	14.62	15.5	0-2
10	16QAM	50	0	14.57	14.80	14.42		



Channel				26065	26340	26665	Tune up Limit (dBm)	MPR (dB)
Frequency (MHz)				1852.5	1880	1912.5		
5	QPSK	1	0	14.43	14.62	14.38	15.5	0
5	QPSK	1	12	14.54	14.69	14.74		
5	QPSK	1	24	14.28	14.63	14.48		
5	QPSK	12	0	14.29	14.55	14.62	15.5	0-1
5	QPSK	12	6	14.41	14.57	14.60		
5	QPSK	12	11	14.49	14.69	14.63		
5	QPSK	25	0	14.51	14.63	14.57		
5	16QAM	1	0	14.43	14.80	14.31	15.5	0-1
5	16QAM	1	12	13.91	14.45	14.32		
5	16QAM	1	24	14.69	14.43	14.38		
5	16QAM	12	0	14.56	14.65	14.52	15.5	0-2
5	16QAM	12	6	14.36	14.67	14.62		
5	16QAM	12	11	14.34	14.65	14.52		
5	16QAM	25	0	14.29	14.65	14.55		
Channel				26055	26340	26675	Tune up Limit (dBm)	MPR (dB)
Frequency (MHz)				1851.5	1880	1913.5		
3	QPSK	1	0	14.54	14.66	14.66	15.5	0
3	QPSK	1	7	14.62	14.69	14.78		
3	QPSK	1	14	14.23	14.77	14.45		
3	QPSK	8	0	14.49	14.63	14.67	15.5	0-1
3	QPSK	8	4	14.52	14.58	14.75		
3	QPSK	8	7	14.53	14.66	14.69		
3	QPSK	15	0	14.43	14.60	14.63		
3	16QAM	1	0	14.73	14.95	14.79	15.5	0-1
3	16QAM	1	7	14.69	14.93	14.60		
3	16QAM	1	14	14.59	14.94	14.58		
3	16QAM	8	0	14.29	14.53	14.56	15.5	0-2
3	16QAM	8	4	14.29	14.83	14.52		
3	16QAM	8	7	14.29	14.54	14.48		
3	16QAM	15	0	14.10	14.19	14.48		
Channel				26047	26340	26683	Tune up Limit (dBm)	MPR (dB)
Frequency (MHz)				1850.7	1880	1914.3		
1.4	QPSK	1	0	14.61	14.56	14.70	15.5	0
1.4	QPSK	1	2	14.54	14.80	14.82		
1.4	QPSK	1	5	14.29	14.43	14.61		
1.4	QPSK	3	0	14.33	14.61	14.80		
1.4	QPSK	3	1	14.49	14.73	14.71		
1.4	QPSK	3	2	14.34	14.74	14.69		
1.4	QPSK	6	0	14.57	14.65	14.71	15.5	0-1
1.4	16QAM	1	0	14.68	14.79	14.88	15.5	0-1
1.4	16QAM	1	2	14.61	14.78	14.78		
1.4	16QAM	1	5	14.60	14.52	14.68		
1.4	16QAM	3	0	13.98	14.42	14.82		
1.4	16QAM	3	1	14.29	14.78	14.83		
1.4	16QAM	3	2	14.63	14.76	14.87		
1.4	16QAM	6	0	14.36	14.69	14.43	15.5	0-2

<TDD LTE SAR Measurement>

TDD LTE configuration setup for SAR measurement

SAR was tested with a fixed periodic duty factor according to the highest transmission duty factor implemented for the device and supported by 3GPP.

- a. 3GPP TS 36.211 section 4.2 for Type 2 Frame Structure and Table 4.2-2 for uplink-downlink configurations
- b. "special subframe S" contains both uplink and downlink transmissions, it has been taken into consideration to determine the transmission duty factor according to the worst case uplink and downlink cyclic prefix requirements for UpPTS
- c. Establishing connections with base station simulators ensure a consistent means for testing SAR and recommended for evaluating SAR. The Anritsu MT8820C (firmware: #22.52#004) was used for LTE output power measurements and SAR testing.

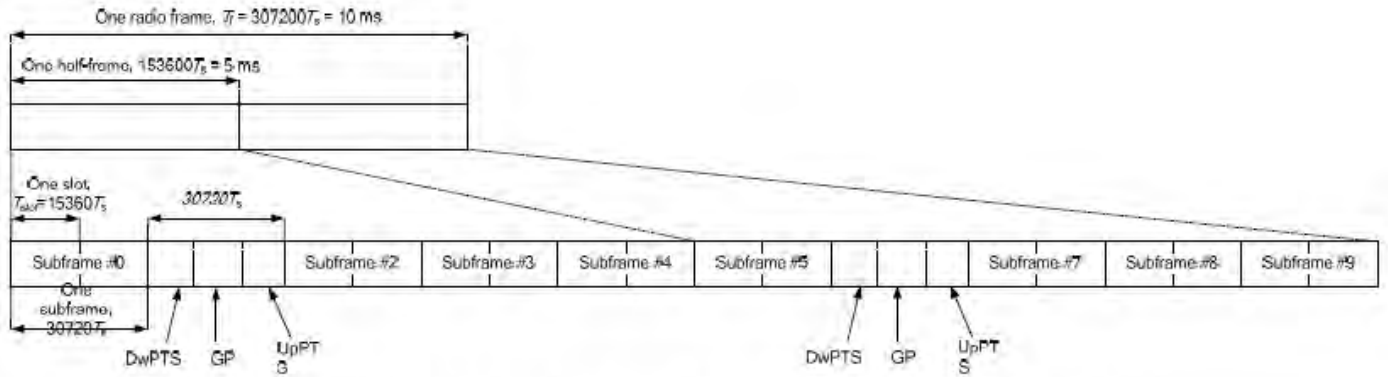

Figure 4.2-1: Frame structure type 2 (for 5 ms switch-point periodicity).

Table 4.2-2: Uplink-downlink configurations.

Uplink-downlink configuration	Downlink-to-Uplink Switch-point periodicity	Subframe number									
		0	1	2	3	4	5	6	7	8	9
0	5 ms	D	S	U	U	U	D	S	U	U	U
1	5 ms	D	S	U	U	D	D	S	U	U	D
2	5 ms	D	S	U	D	D	D	S	U	D	D
3	10 ms	D	S	U	U	U	D	D	D	D	D
4	10 ms	D	S	U	U	D	D	D	D	D	D
5	10 ms	D	S	U	D	D	D	D	D	D	D
6	5 ms	D	S	U	U	U	D	S	U	U	D

Table 4.2-1: Configuration of special subframe (lengths of DwPTS/GP/UpPTS).

Special subframe configuration	Normal cyclic prefix in downlink			Extended cyclic prefix in downlink		
	DwPTS	UpPTS		DwPTS	UpPTS	
		Normal cyclic prefix in uplink	Extended cyclic prefix in uplink		Normal cyclic prefix in uplink	Extended cyclic prefix in uplink
0	$6592 \cdot T_s$	$2192 \cdot T_s$	$2560 \cdot T_s$	$7680 \cdot T_s$	$2192 \cdot T_s$	$2560 \cdot T_s$
1	$19760 \cdot T_s$			$20480 \cdot T_s$		
2	$21952 \cdot T_s$			$23040 \cdot T_s$		
3	$24144 \cdot T_s$			$25600 \cdot T_s$		
4	$26336 \cdot T_s$	$4384 \cdot T_s$	$5120 \cdot T_s$	$7680 \cdot T_s$	$4384 \cdot T_s$	$5120 \cdot T_s$
5	$6592 \cdot T_s$			$20480 \cdot T_s$		
6	$19760 \cdot T_s$			$23040 \cdot T_s$		
7	$21952 \cdot T_s$			$12800 \cdot T_s$		
8	$24144 \cdot T_s$			-		
9	$13168 \cdot T_s$	-	-	-	-	-

Special subframe (30720·T_s): Normal cyclic prefix in downlink (UpPTS)			
	Special subframe configuration	Normal cyclic prefix in uplink	Extended cyclic prefix in uplink
Uplink duty factor in one special subframe	0~4	7.13%	8.33%
	5~9	14.3%	16.7%

Special subframe(30720·T_s): Extended cyclic prefix in downlink (UpPTS)			
	Special subframe configuration	Normal cyclic prefix in uplink	Extended cyclic prefix in uplink
Uplink duty factor in one special subframe	0~3	7.13%	8.33%
	4~7	14.3%	16.7%

The highest duty factor is resulted from:

- i. Uplink-downlink configuration: 0. In a half-frame consisted of 5 subframes, uplink operation is in 3 uplink subframes and 1 special subframe.
- ii. special subframe configuration: 5-9 for normal cyclic prefix in downlink, 4-7 for extended cyclic prefix in downlink
- iii. for special subframe with extended cyclic prefix in uplink, the total uplink duty factor in one half-frame is:
 $(3+0.167)/5 = 63.3\%$
- iv. for special subframe with normal cyclic prefix in uplink, the total uplink duty factor in one half-frame is:
 $(3+0.143)/5 = 62.9\%$
- v. For TDD LTE SAR measurement, the duty cycle 1:1.59 (62.9 %) was used perform testing and considering the theoretical duty cycle of 63.3% for extended cyclic prefix in the uplink, and the theoretical duty cycle of 62.9% for normal cyclic prefix in uplink, a scaling factor of extended cyclic prefix $63.3\%/62.9\% = 1.006$ is applied to scale-up the measured SAR result. The scaled TDD LTE SAR = measured SAR (W/kg)* Tune-up Scaling Factor* scaling factor for extended cyclic prefix.



Maximum Average RF Power (Proximity Sensor Inactive)

<TDD LTE Band 41>

BW [MHz]	Modulation	RB Size	RB Offset	Power Low Ch. / Freq.	Power Low Middle Ch. / Freq.	Power Middle Ch. / Freq.	Power Middle High Ch. / Freq.	Power High Ch. / Freq.	Tune up Limit (dBm)	MPR (dB)
Channel				39750	40185	40620	41055	41490		
Frequency (MHz)				2506	2549.5	2593	2636.5	2680		
20	QPSK	1	0	22.81	22.89	22.50	22.49	22.87	23.0	0
20	QPSK	1	49	22.75	22.62	22.34	22.33	22.32		
20	QPSK	1	99	22.65	22.72	22.31	22.24	22.18		
20	QPSK	50	0	22.77	22.85	22.47	22.32	22.74	23.0	0-1
20	QPSK	50	24	22.74	22.75	22.29	22.23	22.66		
20	QPSK	50	49	22.68	22.72	22.27	22.20	22.54		
20	QPSK	100	0	22.74	22.77	22.35	22.26	22.72	23.0	0-1
20	16QAM	1	0	22.79	22.85	22.28	22.32	22.67		
20	16QAM	1	49	22.80	22.81	22.34	22.31	22.39		
20	16QAM	1	99	22.74	22.83	22.26	22.29	22.56	23.0	0-2
20	16QAM	50	0	22.52	22.84	22.38	22.21	22.74		
20	16QAM	50	24	22.65	22.74	22.35	22.23	22.51		
20	16QAM	50	49	22.71	22.70	22.17	22.18	22.43	23.0	0-2
20	16QAM	100	0	22.69	22.78	22.27	22.21	22.39		
Channel				39725	40173	40620	41068	41515		
Frequency (MHz)				2503.5	2548.3	2593	2637.8	2682.5		
15	QPSK	1	0	22.61	22.81	22.15	21.97	22.55	23.0	0
15	QPSK	1	37	22.65	22.62	22.18	22.18	22.16		
15	QPSK	1	74	22.47	22.72	22.21	22.01	22.15		
15	QPSK	36	0	22.64	22.61	22.38	22.13	22.60	23.0	0-1
15	QPSK	36	18	22.57	22.59	22.30	21.90	22.32		
15	QPSK	36	37	22.62	22.62	22.30	21.99	22.41		
15	QPSK	75	0	22.51	22.60	22.28	22.00	22.62	23.0	0-1
15	16QAM	1	0	22.78	22.87	22.37	22.28	22.60		
15	16QAM	1	37	22.76	22.84	22.27	22.36	22.18		
15	16QAM	1	74	22.77	22.82	22.32	22.33	22.53	23.0	0-2
15	16QAM	36	0	22.64	22.79	22.13	21.98	22.58		
15	16QAM	36	18	22.53	22.76	22.06	21.98	22.25		
15	16QAM	36	37	22.61	22.59	22.05	21.89	22.41	23.0	0-2
15	16QAM	75	0	22.52	22.75	22.16	21.96	22.24		



BW [MHz]	Modulation	RB Size	RB Offset	Power Low Ch. / Freq.	Power Low Middle Ch. / Freq.	Power Middle Ch. / Freq.	Power Middle High Ch. / Freq.	Power High Ch. / Freq.	Tune up Limit (dBm)	MPR (dB)
Channel				39700	40160	40620	41080	41540		
Frequency (MHz)				2501	2547	2593	2639	2685		
10	QPSK	1	0	22.50	22.76	22.25	22.15	22.55	23.0	0
10	QPSK	1	24	22.57	22.63	22.26	22.22	22.48		
10	QPSK	1	49	22.36	22.53	22.07	22.06	22.00		
10	QPSK	25	0	22.55	22.70	22.33	22.10	22.45	23.0	0-1
10	QPSK	25	12	22.63	22.68	22.26	22.17	22.37		
10	QPSK	25	24	22.43	22.56	22.26	22.04	22.37		
10	QPSK	50	0	22.54	22.67	22.32	22.17	22.44	23.0	0-1
10	16QAM	1	0	22.60	22.72	22.21	22.30	22.71		
10	16QAM	1	24	22.58	22.83	22.31	22.33	22.48		
10	16QAM	1	49	22.43	22.85	22.30	22.31	22.29	23.0	0-2
10	16QAM	25	0	22.45	22.67	22.18	22.12	22.62		
10	16QAM	25	12	22.54	22.68	22.22	22.11	22.55		
10	16QAM	25	24	22.36	22.51	22.19	22.13	22.37	23.0	0-2
10	16QAM	50	0	22.44	22.65	22.22	22.12	22.35		
Channel				39675	40148	40620	41093	41565		
Frequency (MHz)				2498.5	2545.8	2593	2640.3	2687.5		
5	QPSK	1	0	22.46	22.58	22.11	22.15	22.23	23.0	0
5	QPSK	1	12	22.45	22.60	22.30	22.23	22.26		
5	QPSK	1	24	22.47	22.46	22.14	22.12	22.11		
5	QPSK	12	0	22.49	22.61	22.16	22.05	22.11	23.0	0-1
5	QPSK	12	6	22.48	22.52	22.21	22.08	22.32		
5	QPSK	12	11	22.43	22.54	22.20	22.09	22.33		
5	QPSK	25	0	22.38	22.53	22.25	22.00	22.34	23.0	0-1
5	16QAM	1	0	22.53	22.85	22.35	22.31	22.27		
5	16QAM	1	12	22.51	22.84	22.21	22.33	22.24		
5	16QAM	1	24	22.60	22.66	22.21	22.30	22.18	23.0	0-2
5	16QAM	12	0	22.44	22.66	22.00	22.02	22.00		
5	16QAM	12	6	22.38	22.68	21.99	22.08	22.32		
5	16QAM	12	11	22.33	22.64	21.99	22.12	22.17	23.0	0-2
5	16QAM	25	0	22.41	22.65	22.06	22.19	22.28		

Note:

TDD LTE Band41 has 5 required test channels was according to KDB 447498 D01v05r02.

Reduced Average RF Power (Proximity Sensor Active)
<TDD LTE Band 41>

BW [MHz]	Modulation	RB Size	RB Offset	Power Low Ch. / Freq.	Power Low Middle Ch. / Freq.	Power Middle Ch. / Freq.	Power Middle High Ch. / Freq.	Power High Ch. / Freq.	Tune up Limit (dBm)	MPR (dB)
Channel				39750	40185	40620	41055	41490		
Frequency (MHz)				2506	2549.5	2593	2636.5	2680		
20	QPSK	1	0	13.91	13.97	13.77	13.78	13.87	14.0	0
20	QPSK	1	49	13.57	13.96	13.11	13.54	13.76		
20	QPSK	1	99	13.76	13.66	13.32	13.52	13.52		
20	QPSK	50	0	13.88	13.89	13.73	13.67	13.82	14.0	0-1
20	QPSK	50	24	13.86	13.87	13.42	13.47	13.65		
20	QPSK	50	49	13.72	13.83	13.26	13.48	13.51		
20	QPSK	100	0	13.82	13.85	13.38	13.40	13.72		
20	16QAM	1	0	13.86	13.94	13.40	13.43	13.83	14.0	0-1
20	16QAM	1	49	13.88	13.95	13.46	13.58	13.81		
20	16QAM	1	99	13.56	13.94	13.10	13.46	13.58		
20	16QAM	50	0	13.86	13.89	13.42	13.49	13.78	14.0	0-2
20	16QAM	50	24	13.75	13.77	13.29	13.40	13.61		
20	16QAM	50	49	13.80	13.83	13.44	13.39	13.51		
20	16QAM	100	0	13.79	13.83	13.33	13.52	13.58		
Channel				39725	40173	40620	41068	41515	Tune up Limit (dBm)	MPR (dB)
Frequency (MHz)				2503.5	2548.3	2593	2637.8	2682.5		
15	QPSK	1	0	13.66	13.91	13.35	13.30	13.59	14.0	0
15	QPSK	1	37	13.63	13.92	13.27	13.50	13.46		
15	QPSK	1	74	13.84	13.79	13.30	13.34	13.39		
15	QPSK	36	0	13.79	13.89	13.34	13.30	13.51	14.0	0-1
15	QPSK	36	18	13.76	13.78	13.25	13.28	13.44		
15	QPSK	36	37	13.82	13.72	13.25	13.27	13.36		
15	QPSK	75	0	13.73	13.80	13.25	13.29	13.43		
15	16QAM	1	0	13.48	13.94	13.44	13.56	13.82	14.0	0-1
15	16QAM	1	37	13.41	13.95	13.35	13.58	13.80		
15	16QAM	1	74	13.55	13.94	13.40	13.59	13.78		
15	16QAM	36	0	13.56	13.85	13.21	13.30	13.61	14.0	0-2
15	16QAM	36	18	13.48	13.82	13.11	13.35	13.39		
15	16QAM	36	37	13.84	13.80	13.13	13.23	13.40		
15	16QAM	75	0	13.70	13.89	13.24	13.25	13.46		



BW [MHz]	Modulation	RB Size	RB Offset	Power Low Ch. / Freq.	Power Low Middle Ch. / Freq.	Power Middle Ch. / Freq.	Power Middle High Ch. / Freq.	Power High Ch. / Freq.	Tune up Limit (dBm)	MPR (dB)
Channel				39700	40160	40620	41080	41540		
Frequency (MHz)				2501	2547	2593	2639	2685		
10	QPSK	1	0	13.49	13.82	13.28	13.53	13.46	14.0	0
10	QPSK	1	24	13.76	13.92	13.43	13.40	13.53		
10	QPSK	1	49	13.52	13.82	13.32	13.30	13.32		
10	QPSK	25	0	13.61	13.81	13.25	13.44	13.50	14.0	0-1
10	QPSK	25	12	13.73	13.82	13.29	13.46	13.39		
10	QPSK	25	24	13.63	13.69	13.23	13.34	13.35		
10	QPSK	50	0	13.72	13.79	13.28	13.42	13.42		
10	16QAM	1	0	13.57	13.92	13.22	13.58	13.47	14.0	0-1
10	16QAM	1	24	13.84	13.87	13.42	13.53	13.53		
10	16QAM	1	49	13.49	13.82	13.18	13.56	13.40		
10	16QAM	25	0	13.61	13.79	13.39	13.57	13.70	14.0	0-2
10	16QAM	25	12	13.65	13.80	13.44	13.43	13.74		
10	16QAM	25	24	13.64	13.83	13.39	13.30	13.49		
10	16QAM	50	0	13.70	13.82	13.20	13.50	13.46		
Channel				39675	40148	40620	41093	41565	Tune up Limit (dBm)	MPR (dB)
Frequency (MHz)				2498.5	2545.8	2593	2640.3	2687.5		
5	QPSK	1	0	13.55	13.68	13.24	13.34	13.42	14.0	0
5	QPSK	1	12	13.64	13.86	13.27	13.43	13.40		
5	QPSK	1	24	13.60	13.76	13.27	13.41	13.21		
5	QPSK	12	0	13.66	13.79	13.33	13.44	13.38	14.0	0-1
5	QPSK	12	6	13.66	13.72	13.23	13.36	13.34		
5	QPSK	12	11	13.71	13.78	13.24	13.41	13.26		
5	QPSK	25	0	13.65	13.80	13.30	13.43	13.36		
5	16QAM	1	0	13.70	13.90	13.42	13.54	13.50	14.0	0-1
5	16QAM	1	12	13.68	13.82	13.34	13.46	13.36		
5	16QAM	1	24	13.73	13.91	13.37	13.56	13.24		
5	16QAM	12	0	13.60	13.69	13.18	13.33	13.26	14.0	0-2
5	16QAM	12	6	13.63	13.61	13.17	13.26	13.29		
5	16QAM	12	11	13.69	13.67	13.18	13.32	13.15		
5	16QAM	25	0	13.67	13.70	13.25	13.33	13.47		

Note:

TDD LTE Band41 has 5 required test channels was according to KDB 447498 D01v05r02.

<WLAN Conducted Power>

General Note:

1. Per KDB 248227 D01v02r01, SAR test reduction is determined according to 802.11 transmission mode configurations and certain exposure conditions with multiple test positions. In the 2.4 GHz band, separate SAR procedures are applied to DSSS and OFDM configurations to simplify DSSS test requirements. For OFDM, in both 2.4 and 5 GHz bands, an initial test configuration must be determined for each standalone and aggregated frequency band, according to the transmission mode configuration with the highest maximum output power specified for production units to perform SAR measurements. If the same highest maximum output power applies to different combinations of channel bandwidths, modulations and data rates, additional procedures are applied to determine which test configurations require SAR measurement. When applicable, an initial test position may be applied to reduce the number of SAR measurements required for next to the ear, UMPC mini-tablet or hotspot mode configurations with multiple test positions.
2. For 2.4 GHz 802.11b DSSS, either the initial test position procedure for multiple exposure test positions or the DSSS procedure for fixed exposure position is applied; these are mutually exclusive. For 2.4 GHz and 5 GHz OFDM configurations, the initial test configuration is applied to measure SAR using either the initial test position procedure for multiple exposure test position configurations or the initial test configuration procedures for fixed exposure test conditions. Based on the reported SAR of the measured configurations and maximum output power of the transmission mode configurations that are not included in the initial test configuration, the subsequent test configuration and initial test position procedures are applied to determine if SAR measurements are required for the remaining OFDM transmission configurations. In general, the number of test channels that require SAR measurement is minimized based on maximum output power measured for the test sample(s).
3. For OFDM transmission configurations in the 2.4 GHz and 5 GHz bands, When the same maximum power is specified for multiple transmission modes in a frequency band, the largest channel bandwidth, lowest order modulation, lowest data rate and lowest order 802.11a/g/n/ac mode is used for SAR measurement, on the highest measured output power channel for each frequency band.
4. DSSS and OFDM configurations are considered separately according to the required SAR procedures. SAR is measured in the initial test position using the 802.11 transmission mode configuration required by the DSSS procedure or initial test configuration and subsequent test configuration(s) according to the OFDM procedures.18 The initial test position procedure is described in the following:
 - a. When the reported SAR of the initial test position is ≤ 0.4 W/kg, further SAR measurement is not required for the other test positions in that exposure configuration and 802.11 transmission mode combinations within the frequency band or aggregated band.
 - b. When the reported SAR of the test position is > 0.4 W/kg, SAR is repeated for the 802.11 transmission mode configuration tested in the initial test position to measure the subsequent next closet/smallest test separation distance and maximum coupling test position on the highest maximum output power channel, until the report SAR is ≤ 0.8 W/kg or all required test position are tested.
 - c. For all positions/configurations, when the reported SAR is > 0.8 W/kg, SAR is measured for these test positions/configurations on the subsequent next highest measured output power channel(s) until the reported SAR is ≤ 1.2 W/kg or all required channels are tested.

	Mode	Channel	Frequency (MHz)	Data Rate	Average power (dBm)	Duty Cycle (%)
2.4GHz WLAN	802.11b	CH 01	2412	1Mbps	13.85	97.92
		CH 06	2437		14.74	
		CH 11	2462		14.80	
	802.11g	CH 01	2412	6Mbps	13.41	87.21
		CH 06	2437		13.81	
		CH 11	2462		13.42	
	802.11n HT20	CH 01	2412	MCS0	12.51	86.11
		CH 06	2437		12.92	
		CH 11	2462		12.44	



<Bluetooth Conducted Power>

Mode	Channel	Frequency (MHz)	Average power (dBm)		
			1Mbps	2Mbps	3Mbps
v3.0 with EDR	CH 00	2402	5.15	4.25	3.52
	CH 39	2441	6.34	5.50	5.58
	CH 78	2480	5.34	5.49	4.56

Mode	Channel	Frequency (MHz)	Average power (dBm)
			GFSK
v4.1 with LE	CH 00	2402	-3.77
	CH 19	2440	-2.58
	CH 39	2480	-3.72

14. Antenna Location

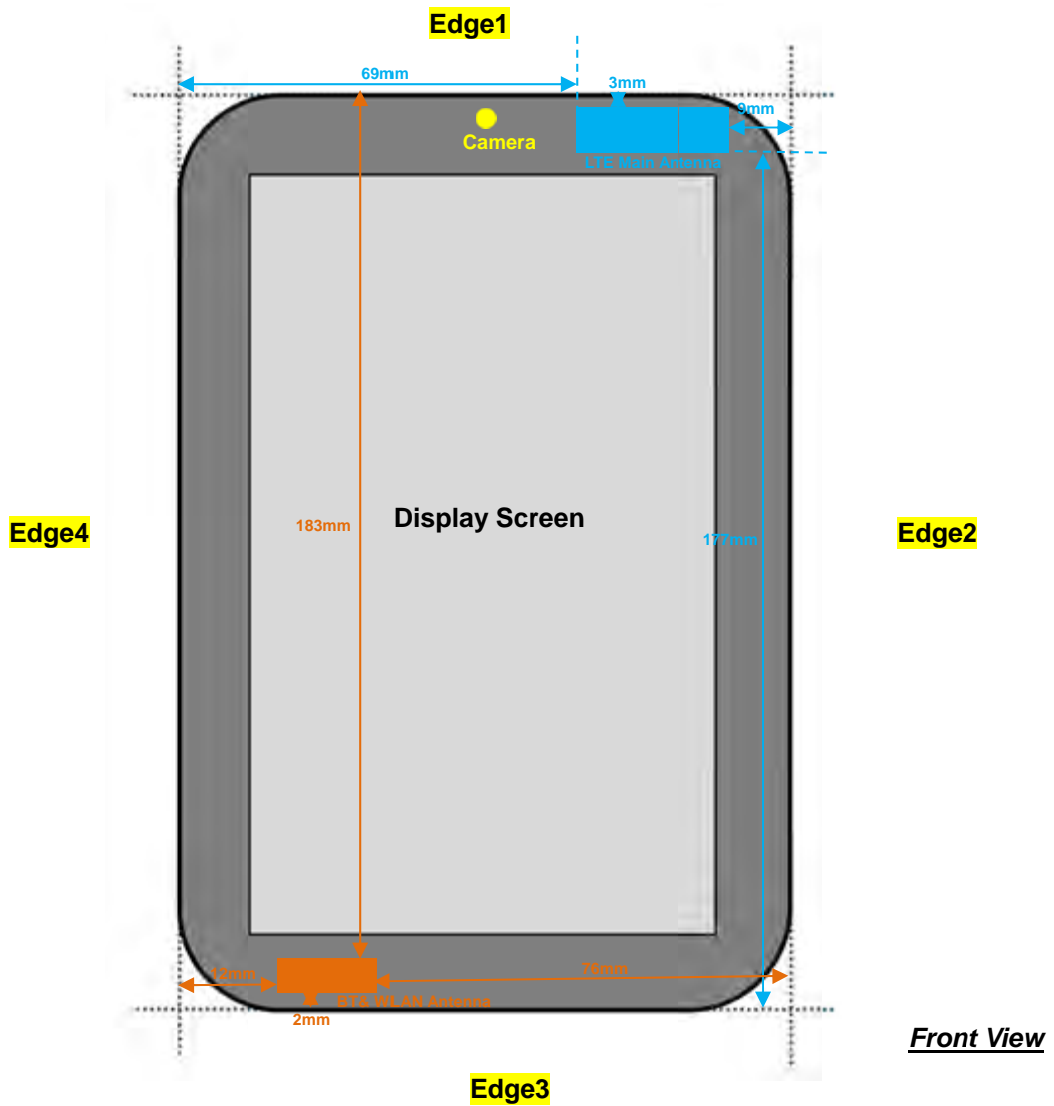

Diagonal Dimension : 212mm



<SAR test exclusion table>

General Note:

1. The below table, when the distance is < 50 mm exclusion threshold is "Ratio", when the distance is > 50 mm exclusion threshold is "mW"
2. Maximum power is the source-based time-average power and represents the maximum RF output power among production units
3. Per KDB 447498 D01v05r02, for larger devices, the test separation distance of adjacent edge configuration is determined by the closest separation between the antenna and the user.
4. Per KDB 447498 D01v05r02, standalone SAR test exclusion threshold is applied; If the test separation distance is < 5mm, 5mm is used to determine SAR exclusion threshold.
5. Per KDB 447498 D01v05r02, the 1-g and 10-g SAR test exclusion thresholds for 100 MHz to 6 GHz at *test separation distances* ≤ 50 mm are determined by:
 - $[(max. power of channel, including tune-up tolerance, mW)/(min. test separation distance, mm)] \cdot [\sqrt{f(GHz)}] \leq 3.0$ for 1-g SAR and ≤ 7.5 for 10-g extremity SAR
 - f(GHz) is the RF channel transmit frequency in GHz
 - Power and distance are rounded to the nearest mW and mm before calculation
 - The result is rounded to one decimal place for comparison
6. Per KDB 447498 D01v05r02, at 100 MHz to 6 GHz and for *test separation distances* > 50 mm, the SAR test exclusion threshold is determined according to the following
 - a) [Threshold at 50 mm in step 1) + (test separation distance - 50 mm)·(f(MHz)/150)] mW, at 100 MHz to 1500 MHz
 - b) [Threshold at 50 mm in step 1) + (test separation distance - 50 mm)·10] mW at > 1500 MHz and ≤ 6 GHz

SAR test exclusion table distance is ≤ 50mm

Exposure Position	Wireless Interface	LTE Band 26	LTE Band 25	LTE Band 41	WLAN 2.4GHz 802.11b	BT 2.4GHz
	Calculated Frequency (MHz)	848.3	1914.3	2687.5	2462	2480
	Tune-up Maximum power (dBm)	23.0	23.5	23.0	15.0	7.0
Bottom Face	Antenna to user (mm)	0			0	
	SAR exclusion threshold	36.8	62.0	73.5	10.0	1.6
	SAR testing required?	Yes	Yes	Yes	Yes	No
Edge 1	Antenna to user (mm)	3				
	SAR exclusion threshold	36.8	62.0	73.5		
	SAR testing required?	Yes	Yes	Yes		
Edge 2	Antenna to user (mm)	9				
	SAR exclusion threshold	20.5	34.4	40.8		
	SAR testing required?	Yes	Yes	Yes		
Edge 3	Antenna to user (mm)				2	
	SAR exclusion threshold				10.0	1.6
	SAR testing required?				Yes	No
Edge 4	Antenna to user (mm)				12	
	SAR exclusion threshold				4.2	0.7
	SAR testing required?				Yes	No



SAR test exclusion table distance is >50mm

Exposure Position	Wireless Interface	LTE Band 26	LTE Band 25	LTE Band 41	WLAN 2.4GHz 802.11b	BT 2.4GHz
	Calculated Frequency (MHz)	848.3	1914.3	2687.5	2462	2480
	Tune-up Maximum power (dBm)	23.0	23.5	23.0	15.0	7.0
	Tune-up Maximum rated power (mW)	200.0	224.0	224.0	32.0	5.0
Edge 1	Antenna to user (mm)	183				
	SAR exclusion threshold (mW)				1426.0	1425.0
	SAR testing required?				No	No
Edge 2	Antenna to user (mm)	76				
	SAR exclusion threshold (mW)				356.0	355.0
	SAR testing required?				No	No
Edge 3	Antenna to user (mm)	177				
	SAR exclusion threshold (mW)	881.0	1378.0	1361.0		
	SAR testing required?	No	No	No		
Edge 4	Antenna to user (mm)	69				
	SAR exclusion threshold (mW)	270.0	298.0	281.0		
	SAR testing required?	No	No	No		

15. SAR Test Results

General Note:

1. Per KDB 447498 D01v05r02, the reported SAR is the measured SAR value adjusted for maximum tune-up tolerance.
 - a. Tune-up scaling Factor = tune-up limit power (mW) / EUT RF power (mW), where tune-up limit is the maximum rated power among all production units
 - b. For SAR testing of WLAN signal with non-100% duty cycle, the measured SAR is scaled-up by the duty cycle scaling factor which is equal to "1/(duty cycle)"
 - c. Duty cycle of TDD was fixed, therefore not require scaled to 100% of duty cycle. For SAR system, the crest factor 1:1.59 (62.9%) was used perform testing. Considering the theoretical duty cycle of 63.3% for extended cyclic prefix in the uplink, and the theoretical duty cycle of 62.9% for normal cyclic prefix in uplink, a scaling factor of extended cyclic prefix $63.3\%/62.9\% = 1.006$ is applied to scale-up the measured SAR result.
 - d. For WWAN: Reported SAR(W/kg)= Measured SAR(W/kg)*Tune-up Scaling Factor
 - e. For WLAN: Reported SAR(W/kg)= Measured SAR(W/kg)* Duty Cycle scaling factor * Tune-up scaling factor
 - f. For TDD LTE Band: Reported SAR(W/kg)= Measured SAR(W/kg)* scaling factor for extended cyclic prefix * Tune-up scaling factor
2. Per KDB 447498 D01v05r02, for each exposure position, testing of other required channels within the operating mode of a frequency band is not required when the *reported* 1-g or 10-g SAR for the mid-band or highest output power channel is:
 - ≤ 0.8 W/kg or 2.0 W/kg, for 1-g or 10-g respectively, when the transmission band is ≤ 100 MHz
 - ≤ 0.6 W/kg or 1.5 W/kg, for 1-g or 10-g respectively, when the transmission band is between 100 MHz and 200 MHz
 - ≤ 0.4 W/kg or 1.0 W/kg, for 1-g or 10-g respectively, when the transmission band is ≥ 200 MHz

Tablet Note:

1. For the exposure positions that proximity sensor power reduction is applied for SAR compliance, additional SAR testing with EUT transmitting full power in normal mode was performed; 13mm for bottom face, edge 1 and curved surface of edge1.
2. According to the setup photo radius dimension (X=2.40mm, Y=2.76mm, Z=1.55mm for LTE, X=2.75mm, Y=1.75mm, Z=1.45mm for WLAN), for X>Z and Y>Z, that complied curved test condition. Per KDB 616217 D04v01r01, SAR at the curved surface is necessary.

LTE Note:

1. Anritsu MT8820C base station simulator was used to setup the connection with EUT; the frequency band, channel bandwidth, RB allocation configuration, modulation type are set in the base station simulator to configure EUT transmitting at maximum power and at different configurations which are requested to be reported to FCC, for conducted power measurement and SAR testing.
2. Per KDB 941225 D05v02r03, when a properly configured base station simulator is used for the SAR and power measurements, spectrum plots for each RB allocation and offset configuration is not required.
3. Per KDB 941225 D05v02r03, start with the largest channel bandwidth and measure SAR for QPSK with 1 RB allocation, using the RB offset and required test channel combination with the highest maximum output power for RB offsets at the upper edge, middle and lower edge of each required test channel.
4. Per KDB 941225 D05v02r03, 50% RB allocation for QPSK SAR testing follows 1RB QPSK allocation procedure.
5. Per KDB 941225 D05v02r03, For QPSK with 100% RB allocation, SAR is not required when the highest maximum output power for 100 % RB allocation is less than the highest maximum output power in 50% and 1 RB allocations and the highest reported SAR for 1 RB and 50% RB allocation are ≤ 0.8 W/kg. Otherwise, SAR is measured for the highest output power channel; and if the reported SAR is > 1.45 W/kg, the remaining required test channels must also be tested.
6. Per KDB 941225 D05v02r03, 16QAM output power for each RB allocation configuration is $> \text{not } \frac{1}{2}$ dB higher than the same configuration in QPSK and the reported SAR for the QPSK configuration is ≤ 1.45 W/kg; Per KDB 941225 D05v02r03, 16QAM SAR testing is not required.
7. Per KDB 941225 D05v02r03, smaller bandwidth output power for each RB allocation configuration is $> \text{not } \frac{1}{2}$ dB higher than the same configuration in the largest supported bandwidth, and the reported SAR for the largest supported bandwidth is ≤ 1.45 W/kg; Per KDB 941225 D05v02r03, smaller bandwidth SAR testing is not required.
8. Tests were performed when EUT operating without power back-off and operating with power back-off in accordance with general note 3, 4, 5, 6, 7 as above.



WLAN Note:

1. Per KDB 248227 D01v02r01, for 2.4GHz 802.11g/n SAR testing is not required when the highest reported SAR for DSSS is adjusted by the ratio of OFDM to DSSS specified maximum output power and the adjusted SAR is ≤ 1.2 W/kg.
2. When the reported SAR of the test position is > 0.4 W/kg, SAR is repeated for the 802.11 transmission mode configuration tested in the initial test position to measure the subsequent next closet/smallest test separation distance and maximum coupling test position on the highest maximum output power channel, until the report SAR is ≤ 0.8 W/kg or all required test position are tested.
3. For all positions / configurations, when the reported SAR is > 0.8 W/kg, SAR is measured for these test positions / configurations on the subsequent next highest measured output power channel(s) until the reported SAR is ≤ 1.2 W/kg or all required channels are tested.
4. During SAR testing the WLAN transmission was verified using a spectrum analyzer.

15.1 Body SAR

<FDD LTE SAR>

Plot No.	Band	BW (MHz)	RB Size	RB Offset	Mode	Test Position	Gap (mm)	Power Back-off	Ch.	Freq. (MHz)	Average Power (dBm)	Tune-Up Limit (dBm)	Tune-up Scaling Factor	Power Drift (dB)	Measured 1g SAR (W/kg)	Reported 1g SAR (W/kg)
	LTE Band 26	15M	1	0	QPSK	Bottom Face	0	On	26865	831.5	14.59	15.00	1.099	-0.1	0.278	0.306
	LTE Band 26	15M	36	0	QPSK	Bottom Face	0	On	26865	831.5	14.53	15.00	1.114	-0.06	0.289	0.322
	LTE Band 26	15M	1	0	QPSK	Edge 1	0	On	26865	831.5	14.59	15.00	1.099	-0.11	0.103	0.113
	LTE Band 26	15M	36	0	QPSK	Edge 1	0	On	26865	831.5	14.53	15.00	1.114	-0.06	0.142	0.158
	LTE Band 26	15M	1	0	QPSK	Curved surface of Edge 1	0	On	26865	831.5	14.59	15.00	1.099	-0.05	0.174	0.191
	LTE Band 26	15M	36	0	QPSK	Curved surface of Edge 1	0	On	26865	831.5	14.53	15.00	1.114	-0.06	0.231	0.257
	LTE Band 26	15M	1	0	QPSK	Bottom Face	13	Off	26865	831.5	22.56	23.00	1.107	-0.04	0.287	0.318
	LTE Band 26	15M	36	0	QPSK	Bottom Face	13	Off	26865	831.5	21.60	22.00	1.096	-0.1	0.232	0.254
	LTE Band 26	15M	1	0	QPSK	Edge 1	13	Off	26865	831.5	22.56	23.00	1.107	-0.08	0.187	0.207
	LTE Band 26	15M	36	0	QPSK	Edge 1	13	Off	26865	831.5	21.60	22.00	1.096	-0.02	0.157	0.172
#01	LTE Band 26	15M	1	0	QPSK	Edge 2	0	Off	26865	831.5	22.56	23.00	1.107	-0.09	0.319	0.353
	LTE Band 26	15M	36	0	QPSK	Edge 2	0	Off	26865	831.5	21.60	22.00	1.096	-0.05	0.264	0.289
	LTE Band 26	15M	1	0	QPSK	Curved surface of Edge 1	13	Off	26865	831.5	22.56	23.00	1.107	-0.19	0.230	0.255
	LTE Band 26	15M	36	0	QPSK	Curved surface of Edge 1	13	Off	26865	831.5	21.60	22.00	1.096	-0.03	0.189	0.207
	LTE Band 25	20M	1	0	QPSK	Bottom Face	0	On	26140	1860	14.99	15.50	1.125	-0.16	0.402	0.452
	LTE Band 25	20M	50	0	QPSK	Bottom Face	0	On	26140	1860	14.83	15.50	1.167	-0.08	0.423	0.494
	LTE Band 25	20M	1	0	QPSK	Edge 1	0	On	26140	1860	14.99	15.50	1.125	-0.02	0.347	0.390
	LTE Band 25	20M	50	0	QPSK	Edge 1	0	On	26140	1860	14.83	15.50	1.167	-0.03	0.319	0.372
	LTE Band 25	20M	1	0	QPSK	Curved surface of Edge 1	0	On	26140	1860	14.99	15.50	1.125	-0.03	0.401	0.451
	LTE Band 25	20M	50	0	QPSK	Curved surface of Edge 1	0	On	26140	1860	14.83	15.50	1.167	0.13	0.415	0.484
	LTE Band 25	20M	1	0	QPSK	Bottom Face	13	Off	26140	1860	23.11	23.50	1.094	-0.09	0.188	0.206
	LTE Band 25	20M	50	0	QPSK	Bottom Face	13	Off	26140	1860	22.15	22.50	1.084	-0.03	0.158	0.171
	LTE Band 25	20M	1	0	QPSK	Edge 1	13	Off	26140	1860	23.11	23.50	1.094	-0.09	0.153	0.167
	LTE Band 25	20M	50	0	QPSK	Edge 1	13	Off	26140	1860	22.15	22.50	1.084	-0.17	0.121	0.131
#02	LTE Band 25	20M	1	0	QPSK	Edge 2	0	Off	26140	1860	23.11	23.50	1.094	-0.09	0.650	0.711
	LTE Band 25	20M	50	0	QPSK	Edge 2	0	Off	26140	1860	22.15	22.50	1.084	-0.08	0.522	0.566
	LTE Band 25	20M	1	0	QPSK	Curved surface of Edge 1	13	Off	26140	1860	23.11	23.50	1.094	-0.01	0.138	0.151
	LTE Band 25	20M	50	0	QPSK	Curved surface of Edge 1	13	Off	26140	1860	22.15	22.50	1.084	-0.09	0.111	0.120



<TDD LTE SAR>

Plot No.	Band	BW (MHz)	RB Size	RB offset	Mode	Test Position	Gap (mm)	Power Back-off	Ch.	Freq. (MHz)	Average Power (dBm)	Tune-Up Limit (dBm)	Tune-up Scaling Factor	Duty Cycle %	Duty Cycle Scaling Factor	Power Drift (dB)	Measured 1g SAR (W/kg)	Reported 1g SAR (W/kg)
	LTE Band 41	20M	1	0	QPSK	Bottom Face	0	On	40185	2549.5	13.97	14.00	1.007	62.9	1.006	0.04	0.601	0.609
	LTE Band 41	20M	1	0	QPSK	Bottom Face	0	On	39750	2506	13.91	14.00	1.021	62.9	1.006	0.02	0.542	0.557
	LTE Band 41	20M	1	0	QPSK	Bottom Face	0	On	40620	2593	13.77	14.00	1.054	62.9	1.006	0.01	0.660	0.700
	LTE Band 41	20M	1	0	QPSK	Bottom Face	0	On	41055	2636.5	13.78	14.00	1.052	62.9	1.006	-0.04	0.679	0.719
	LTE Band 41	20M	1	0	QPSK	Bottom Face	0	On	41490	2680	13.87	14.00	1.030	62.9	1.006	0.01	0.607	0.629
	LTE Band 41	20M	50	0	QPSK	Bottom Face	0	On	40185	2549.5	13.89	14.00	1.026	62.9	1.006	-0.04	0.647	0.668
	LTE Band 41	20M	50	0	QPSK	Bottom Face	0	On	39750	2506	13.88	14.00	1.028	62.9	1.006	-0.07	0.558	0.577
	LTE Band 41	20M	50	0	QPSK	Bottom Face	0	On	40620	2593	13.73	14.00	1.064	62.9	1.006	-0.01	0.683	0.731
	LTE Band 41	20M	50	0	QPSK	Bottom Face	0	On	41055	2636.5	13.67	14.00	1.079	62.9	1.006	-0.08	0.685	0.744
	LTE Band 41	20M	50	0	QPSK	Bottom Face	0	On	41490	2680	13.82	14.00	1.042	62.9	1.006	0.03	0.674	0.707
	LTE Band 41	20M	100	0	QPSK	Bottom Face	0	On	40185	2549.5	13.85	14.00	1.035	62.9	1.006	-0.01	0.635	0.661
	LTE Band 41	20M	1	0	QPSK	Edge 1	0	On	40185	2549.5	13.97	14.00	1.007	62.9	1.006	0.07	0.622	0.630
	LTE Band 41	20M	1	0	QPSK	Edge 1	0	On	39750	2506	13.91	14.00	1.021	62.9	1.006	0.07	0.602	0.618
	LTE Band 41	20M	1	0	QPSK	Edge 1	0	On	40620	2593	13.77	14.00	1.054	62.9	1.006	0.09	0.780	0.827
	LTE Band 41	20M	1	0	QPSK	Edge 1	0	On	41055	2636.5	13.78	14.00	1.052	62.9	1.006	0.09	0.789	0.835
	LTE Band 41	20M	1	0	QPSK	Edge 1	0	On	41490	2680	13.87	14.00	1.030	62.9	1.006	-0.02	0.856	0.887
	LTE Band 41	20M	50	0	QPSK	Edge 1	0	On	40185	2549.5	13.89	14.00	1.026	62.9	1.006	-0.05	0.699	0.721
	LTE Band 41	20M	50	0	QPSK	Edge 1	0	On	39750	2506	13.88	14.00	1.028	62.9	1.006	0.07	0.599	0.619
	LTE Band 41	20M	50	0	QPSK	Edge 1	0	On	40620	2593	13.73	14.00	1.064	62.9	1.006	-0.04	0.823	0.881
	LTE Band 41	20M	50	0	QPSK	Edge 1	0	On	41055	2636.5	13.67	14.00	1.079	62.9	1.006	-0.03	0.804	0.873
	LTE Band 41	20M	50	0	QPSK	Edge 1	0	On	41490	2680	13.82	14.00	1.042	62.9	1.006	-0.03	0.956	1.002
	LTE Band 41	20M	100	0	QPSK	Edge 1	0	On	40185	2549.5	13.85	14.00	1.035	62.9	1.006	-0.05	0.716	0.746
	LTE Band 41	20M	1	0	QPSK	Curved surface of Edge 1	0	On	40185	2549.5	13.97	14.00	1.007	62.9	1.006	0.05	1.020	1.033
	LTE Band 41	20M	1	0	QPSK	Curved surface of Edge 1	0	On	39750	2506	13.91	14.00	1.021	62.9	1.006	-0.02	0.884	0.908
	LTE Band 41	20M	1	0	QPSK	Curved surface of Edge 1	0	On	40620	2593	13.77	14.00	1.054	62.9	1.006	-0.02	1.190	1.262
	LTE Band 41	20M	1	0	QPSK	Curved surface of Edge 1	0	On	41055	2636.5	13.78	14.00	1.052	62.9	1.006	0.07	1.230	1.302
	LTE Band 41	20M	1	0	QPSK	Curved surface of Edge 1	0	On	41490	2680	13.87	14.00	1.030	62.9	1.006	0.09	1.240	1.285
	LTE Band 41	20M	50	0	QPSK	Curved surface of Edge 1	0	On	40185	2549.5	13.89	14.00	1.026	62.9	1.006	0.02	1.110	1.145
	LTE Band 41	20M	50	0	QPSK	Curved surface of Edge 1	0	On	39750	2506	13.88	14.00	1.028	62.9	1.006	0.03	0.899	0.930
	LTE Band 41	20M	50	0	QPSK	Curved surface of Edge 1	0	On	40620	2593	13.73	14.00	1.064	62.9	1.006	0.09	1.250	1.338
	LTE Band 41	20M	50	0	QPSK	Curved surface of Edge 1	0	On	41055	2636.5	13.67	14.00	1.079	62.9	1.006	0.08	1.230	1.335
	LTE Band 41	20M	50	0	QPSK	Curved surface of Edge 1	0	On	41490	2680	13.82	14.00	1.042	62.9	1.006	0.08	1.280	1.342
	LTE Band 41	20M	100	0	QPSK	Curved surface of Edge 1	0	On	40185	2549.5	13.85	14.00	1.035	62.9	1.006	0.08	1.040	1.083
	LTE Band 41	20M	1	0	QPSK	Bottom Face	13	Off	40185	2549.5	22.89	23.00	1.026	62.9	1.006	-0.03	0.707	0.729
	LTE Band 41	20M	1	0	QPSK	Bottom Face	13	Off	39750	2506	22.81	23.00	1.045	62.9	1.006	-0.05	0.676	0.710
	LTE Band 41	20M	1	0	QPSK	Bottom Face	13	Off	40620	2593	22.50	23.00	1.122	62.9	1.006	-0.04	0.722	0.815
	LTE Band 41	20M	1	0	QPSK	Bottom Face	13	Off	41055	2636.5	22.49	23.00	1.125	62.9	1.006	-0.09	0.679	0.768
	LTE Band 41	20M	1	0	QPSK	Bottom Face	13	Off	41490	2680	22.87	23.00	1.030	62.9	1.006	-0.04	0.722	0.748
	LTE Band 41	20M	50	0	QPSK	Bottom Face	13	Off	40185	2549.5	22.85	23.00	1.035	62.9	1.006	-0.04	0.790	0.823
	LTE Band 41	20M	50	0	QPSK	Bottom Face	13	Off	39750	2506	22.77	23.00	1.054	62.9	1.006	-0.08	0.696	0.738
	LTE Band 41	20M	50	0	QPSK	Bottom Face	13	Off	40620	2593	22.47	23.00	1.130	62.9	1.006	-0.09	0.861	0.979
	LTE Band 41	20M	50	0	QPSK	Bottom Face	13	Off	41055	2636.5	22.32	23.00	1.169	62.9	1.006	-0.02	0.807	0.949
	LTE Band 41	20M	50	0	QPSK	Bottom Face	13	Off	41490	2680	22.74	23.00	1.062	62.9	1.006	-0.01	0.799	0.853
	LTE Band 41	20M	100	0	QPSK	Bottom Face	13	Off	40185	2549.5	22.77	23.00	1.054	62.9	1.006	-0.01	0.784	0.832



Plot No.	Band	BW (MHz)	RB Size	RB offset	Mode	Test Position	Gap (mm)	Power Back-off	Ch.	Freq. (MHz)	Average Power (dBm)	Tune-Up Limit (dBm)	Tune-up Scaling Factor	Duty Cycle %	Duty Cycle Scaling Factor	Power Drift (dB)	Measured 1g SAR (W/kg)	Reported 1g SAR (W/kg)
	LTE Band 41	20M	1	0	QPSK	Edge 1	13	Off	40185	2549.5	22.89	23.00	1.026	62.9	1.006	-0.06	1.020	1.052
	LTE Band 41	20M	1	0	QPSK	Edge 1	13	Off	39750	2506	22.81	23.00	1.045	62.9	1.006	-0.04	1.020	1.072
	LTE Band 41	20M	1	0	QPSK	Edge 1	13	Off	40620	2593	22.50	23.00	1.122	62.9	1.006	-0.03	1.170	1.321
	LTE Band 41	20M	1	0	QPSK	Edge 1	13	Off	41055	2636.5	22.49	23.00	1.125	62.9	1.006	-0.01	1.200	1.358
#03	LTE Band 41	20M	1	0	QPSK	Edge 1	13	Off	41490	2680	22.87	23.00	1.030	62.9	1.006	-0.03	1.330	1.379
	LTE Band 41	20M	50	0	QPSK	Edge 1	13	Off	40185	2549.5	22.85	23.00	1.035	62.9	1.006	-0.05	0.988	1.029
	LTE Band 41	20M	50	0	QPSK	Edge 1	13	Off	39750	2506	22.77	23.00	1.054	62.9	1.006	-0.05	0.843	0.894
	LTE Band 41	20M	50	0	QPSK	Edge 1	13	Off	40620	2593	22.47	23.00	1.130	62.9	1.006	-0.03	1.110	1.262
	LTE Band 41	20M	50	0	QPSK	Edge 1	13	Off	41055	2636.5	22.32	23.00	1.169	62.9	1.006	-0.02	1.170	1.377
	LTE Band 41	20M	50	0	QPSK	Edge 1	13	Off	41490	2680	22.74	23.00	1.062	62.9	1.006	-0.05	1.290	1.378
	LTE Band 41	20M	100	0	QPSK	Edge 1	13	Off	40185	2549.5	22.77	23.00	1.054	62.9	1.006	-0.07	1.000	1.061
	LTE Band 41	20M	1	0	QPSK	Edge 2	0	Off	40185	2549.5	22.89	23.00	1.026	62.9	1.006	-0.12	1.090	1.125
	LTE Band 41	20M	1	0	QPSK	Edge 2	0	Off	39750	2506	22.81	23.00	1.045	62.9	1.006	0.05	1.130	1.188
	LTE Band 41	20M	1	0	QPSK	Edge 2	0	Off	40620	2593	22.50	23.00	1.122	62.9	1.006	0.01	1.070	1.208
	LTE Band 41	20M	1	0	QPSK	Edge 2	0	Off	41055	2636.5	22.49	23.00	1.125	62.9	1.006	0.07	0.869	0.983
	LTE Band 41	20M	1	0	QPSK	Edge 2	0	Off	41490	2680	22.87	23.00	1.030	62.9	1.006	-0.13	0.646	0.670
	LTE Band 41	20M	50	0	QPSK	Edge 2	0	Off	40185	2549.5	22.85	23.00	1.035	62.9	1.006	0.1	1.100	1.145
	LTE Band 41	20M	50	0	QPSK	Edge 2	0	Off	39750	2506	22.77	23.00	1.054	62.9	1.006	-0.02	1.110	1.177
	LTE Band 41	20M	50	0	QPSK	Edge 2	0	Off	40620	2593	22.47	23.00	1.130	62.9	1.006	0.03	1.070	1.216
	LTE Band 41	20M	50	0	QPSK	Edge 2	0	Off	41055	2636.5	22.32	23.00	1.169	62.9	1.006	0.04	0.832	0.979
	LTE Band 41	20M	50	0	QPSK	Edge 2	0	Off	41490	2680	22.74	23.00	1.062	62.9	1.006	-0.05	0.627	0.670
	LTE Band 41	20M	100	0	QPSK	Edge 2	0	Off	40185	2549.5	22.77	23.00	1.054	62.9	1.006	0.06	0.762	0.808
	LTE Band 41	20M	1	0	QPSK	Curved surface of Edge 1	13	Off	40185	2549.5	22.89	23.00	1.026	62.9	1.006	-0.06	1.060	1.094
	LTE Band 41	20M	1	0	QPSK	Curved surface of Edge 1	13	Off	39750	2506	22.81	23.00	1.045	62.9	1.006	0.04	0.942	0.990
	LTE Band 41	20M	1	0	QPSK	Curved surface of Edge 1	13	Off	40620	2593	22.50	23.00	1.122	62.9	1.006	0.06	1.080	1.219
	LTE Band 41	20M	1	0	QPSK	Curved surface of Edge 1	13	Off	41055	2636.5	22.49	23.00	1.125	62.9	1.006	-0.09	1.160	1.312
	LTE Band 41	20M	1	0	QPSK	Curved surface of Edge 1	13	Off	41490	2680	22.87	23.00	1.030	62.9	1.006	0.04	1.230	1.275
	LTE Band 41	20M	50	0	QPSK	Curved surface of Edge 1	13	Off	40185	2549.5	22.85	23.00	1.035	62.9	1.006	0.04	1.100	1.145
	LTE Band 41	20M	50	0	QPSK	Curved surface of Edge 1	13	Off	39750	2506	22.77	23.00	1.054	62.9	1.006	0.04	0.931	0.988
	LTE Band 41	20M	50	0	QPSK	Curved surface of Edge 1	13	Off	40620	2593	22.47	23.00	1.130	62.9	1.006	0.01	1.210	1.375
	LTE Band 41	20M	50	0	QPSK	Curved surface of Edge 1	13	Off	41055	2636.5	22.32	23.00	1.169	62.9	1.006	0.01	1.160	1.365
	LTE Band 41	20M	50	0	QPSK	Curved surface of Edge 1	13	Off	41490	2680	22.74	23.00	1.062	62.9	1.006	0.05	1.100	1.175
	LTE Band 41	20M	100	0	QPSK	Curved surface of Edge 1	13	Off	40185	2549.5	22.77	23.00	1.054	62.9	1.006	0.01	0.973	1.032



<DTS WLAN SAR>

Plot No.	Band	Mode	Test Position	Gap (mm)	Ch.	Freq. (MHz)	Average Power (dBm)	Tune-Up Limit (dBm)	Tune-up Scaling Factor	Duty Cycle %	Duty Cycle Scaling Factor	Power Drift (dB)	Measured 1g SAR (W/kg)	Reported 1g SAR (W/kg)
	WLAN 2.4GHz	802.11b_1Mbps	Bottom Face	0	11	2462	14.80	15.00	1.047	97.92	1.021	0.01	0.917	0.980
	WLAN 2.4GHz	802.11b_1Mbps	Bottom Face	0	1	2412	13.85	14.50	1.161	97.92	1.021	0.02	0.884	1.048
	WLAN 2.4GHz	802.11b_1Mbps	Bottom Face	0	6	2437	14.74	15.00	1.061	97.92	1.021	-0.02	0.750	0.813
	WLAN 2.4GHz	802.11b_1Mbps	Edge 3	0	11	2462	14.80	15.00	1.047	97.92	1.021	-0.09	0.963	1.030
	WLAN 2.4GHz	802.11b_1Mbps	Edge 3	0	1	2412	13.85	14.50	1.161	97.92	1.021	0.17	0.771	0.914
	WLAN 2.4GHz	802.11b_1Mbps	Edge 3	0	6	2437	14.74	15.00	1.061	97.92	1.021	-0.05	0.692	0.750
	WLAN 2.4GHz	802.11b_1Mbps	Edge 4	0	11	2462	14.80	15.00	1.047	97.92	1.021	-0.08	0.328	0.351
#04	WLAN 2.4GHz	802.11b_1Mbps	Curved surface of Edge 3	0	11	2462	14.80	15.00	1.047	97.92	1.021	0.01	1.300	1.390
	WLAN 2.4GHz	802.11b_1Mbps	Curved surface of Edge 3	0	1	2412	13.85	14.50	1.161	97.92	1.021	0.01	1.040	1.233
	WLAN 2.4GHz	802.11b_1Mbps	Curved surface of Edge 3	0	6	2437	14.74	15.00	1.061	97.92	1.021	0.02	1.000	1.084



15.2 Repeated SAR Measurement

General Note:

- 1. Per KDB 865664 D01v01r03, for each frequency band, repeated SAR measurement is required only when the measured SAR is ≥0.8W/kg
2. Per KDB 865664 D01v01r03, if the ratio among the repeated measurement is ≤ 1.2 and the measured SAR <1.45W/kg, only one repeated measurement is required.
3. The ratio is the difference in percentage between original and repeated measured SAR.
4. All measurement SAR result is scaled-up to account for tune-up tolerance and is compliant.

Table with 20 columns: No., Band, BW (MHz), RB Size, RB offset, Mode, Test Position, Gap (mm), Power Back-off, Ch., Freq. (MHz), Average Power (dBm), Tune-Up Limit (dBm), Tune-up Scaling Factor, Duty Cycle %, Duty Cycle Scaling Factor, Power Drift (dB), Measured 1g SAR (W/kg), Ratio, Reported 1g SAR (W/kg). It contains 4 rows of test data for LTE and WLAN bands.

16. Simultaneous Transmission Analysis

NO.	Simultaneous Transmission Configurations	Body
1.	LTE(data) + WLAN2.4GHz(data)	Yes
2.	LTE(data) + Bluetooth(data)	Yes

General Note:

1. For simultaneous transmission analysis for exposure position of bottom face 13mm, WLAN SAR tested at 0mm separation is worse and the test data is used for conservative SAR summation.
2. WLAN and Bluetooth share the same antenna, and cannot transmit simultaneously.
3. The reported SAR summation is calculated based on the same configuration and test position.
4. Per KDB 447498 D01v05r02, simultaneous transmission SAR is compliant if,
 - i) Scalar SAR summation < 1.6W/kg.
 - ii) $SPLSR = (SAR_1 + SAR_2)^{1.5} / (min. \text{ separation distance, mm})$, and the peak separation distance is determined from the square root of $[(x_1-x_2)^2 + (y_1-y_2)^2 + (z_1-z_2)^2]$, where (x_1, y_1, z_1) and (x_2, y_2, z_2) are the coordinates of the extrapolated peak SAR locations in the zoom scan.
 - iii) If $SPLSR \leq 0.04$, simultaneously transmission SAR measurement is not necessary.
 - iv) Simultaneously transmission SAR measurement, and the reported multi-band SAR < 1.6W/kg.
 - v) The SPLSR calculated results please refer to section 16.2.
5. For simultaneous transmission analysis, Bluetooth SAR is estimated per KDB 447498 D01v05r02 based on the formula below.
 - i) $(max. \text{ power of channel, including tune-up tolerance, mW}) / (min. \text{ test separation distance, mm}) \cdot [\sqrt{f(\text{GHz})} / x] \text{ W/kg}$ for test separation distances $\leq 50 \text{ mm}$; where $x = 7.5$ for 1-g SAR, and $x = 18.75$ for 10-g SAR.
 - ii) When the minimum separation distance is < 5mm, the distance is used 5mm to determine SAR test exclusion.
 - iii) 0.4 W/kg for 1-g SAR and 1.0 W/kg for 10-g SAR, when the test separation distances is > 50 mm.
 - iv) Bluetooth estimated SAR is conservatively determined by 5mm separation, for all applicable exposure positions.

Bluetooth Max Power	Exposure Position	All Positions
7 dBm	Estimated SAR (W/kg)	0.210 W/kg



16.1 Tablet Body Exposure Conditions

<WWAN PCB + WLAN DTS>

WWAN Band	Exposure Position	WWAN PCB	WLAN DTS	Summed SAR (W/kg)	SPLSR	Case No	
		Max. WWAN SAR (W/kg)	Max. WLAN SAR (W/kg)				
LTE	Band 26	Bottom Face at 0mm	0.322	1.048	1.37		
		Edge 1 at 0mm	0.158		0.16		
		Curved surface of Edge 1 at 0mm	0.257		0.26		
		Bottom Face at 13mm	0.318	1.048	1.37		
		Edge 1 at 13mm	0.207		0.21		
		Edge2 at 0mm	0.353		0.35		
		Edge3 at 0mm		1.030	1.03		
		Edge4 at 0mm		0.351	0.35		
	Band 25	Curved surface of Edge 1 at 13mm	0.255		0.26		
		Curved surface of Edge 3 at 0mm		1.390	1.39		
		Bottom Face at 0mm	0.494	1.048	1.54		
		Edge 1 at 0mm	0.390		0.39		
		Curved surface of Edge 1 at 0mm	0.484		0.48		
		Bottom Face at 13mm	0.206	1.048	1.25		
		Edge 1 at 13mm	0.167		0.17		
		Edge2 at 0mm	0.711		0.71		
	Band 41	Edge3 at 0mm		1.030	1.03		
		Edge4 at 0mm		0.351	0.35		
		Curved surface of Edge 1 at 13mm	0.151		0.15		
		Curved surface of Edge 3 at 0mm		1.390	1.39		
		Bottom Face at 0mm	0.744	1.048	1.79	0.01	#1
		Edge 1 at 0mm	1.002		1.00		
		Curved surface of Edge 1 at 0mm	1.342		1.34		
		Bottom Face at 13mm	0.979	1.048	2.03	0.02	#2
	Edge 1 at 13mm	1.379		1.38			
	Edge2 at 0mm	1.216		1.22			
	Edge3 at 0mm		1.030	1.03			
	Edge4 at 0mm		0.351	0.35			
Curved surface of Edge 1 at 13mm	1.375		1.38				
Curved surface of Edge 3 at 0mm		1.390	1.39				

<WWAN PCB + Bluetooth DSS>

WWAN Band		Exposure Position	WWAN PCB	Bluetooth DSS	Summed SAR (W/kg)	SPLSR	Case No
			Max. WWAN SAR (W/kg)	Estimated SAR (W/kg)			
LTE	Band 26	Bottom Face at 0mm	0.322	0.210	0.53		
		Edge 1 at 0mm	0.158	0.210	0.37		
		Curved surface of Edge 1 at 0mm	0.257	0.210	0.47		
		Bottom Face at 13mm	0.318	0.210	0.53		
		Edge 1 at 13mm	0.207	0.210	0.42		
		Edge2 at 0mm	0.353	0.210	0.56		
		Curved surface of Edge 1 at 13mm	0.255	0.210	0.47		
	Band 25	Bottom Face at 0mm	0.494	0.210	0.70		
		Edge 1 at 0mm	0.390	0.210	0.60		
		Curved surface of Edge 1 at 0mm	0.484	0.210	0.69		
		Bottom Face at 13mm	0.206	0.210	0.42		
		Edge 1 at 13mm	0.167	0.210	0.38		
		Edge2 at 0mm	0.711	0.210	0.92		
		Curved surface of Edge 1 at 13mm	0.151	0.210	0.36		
	Band 41	Bottom Face at 0mm	0.744	0.210	0.95		
		Edge 1 at 0mm	1.002	0.210	1.21		
		Curved surface of Edge 1 at 0mm	1.342	0.210	1.55		
		Bottom Face at 13mm	0.979	0.210	1.19		
		Edge 1 at 13mm	1.379	0.210	1.59		
		Edge2 at 0mm	1.216	0.210	1.43		
		Curved surface of Edge 1 at 13mm	1.375	0.210	1.59		

16.2 SPLSR Evaluation and Analysis

General Note: $SPLSR = (SAR_1 + SAR_2)^{1.5} / (min. \text{ separation distance, mm})$. If $SPLSR \leq 0.04$, simultaneously transmission SAR measurement is not necessary.

Case No #1	Band	SAR (W/kg)	Gap (mm)	SAR peak location (m)			3D distance (mm)	Pair SAR sum (W/kg)	SPLSR	Simultaneous SAR
				X	Y	Z				
Bottom Face	LTE Band 41	0.744	0	-0.0312	0.0848	-0.181	178.8	1.79	0.01	Not required
	WLAN 2.4GHz	1.048	0	0.0372	-0.0804	-0.181				

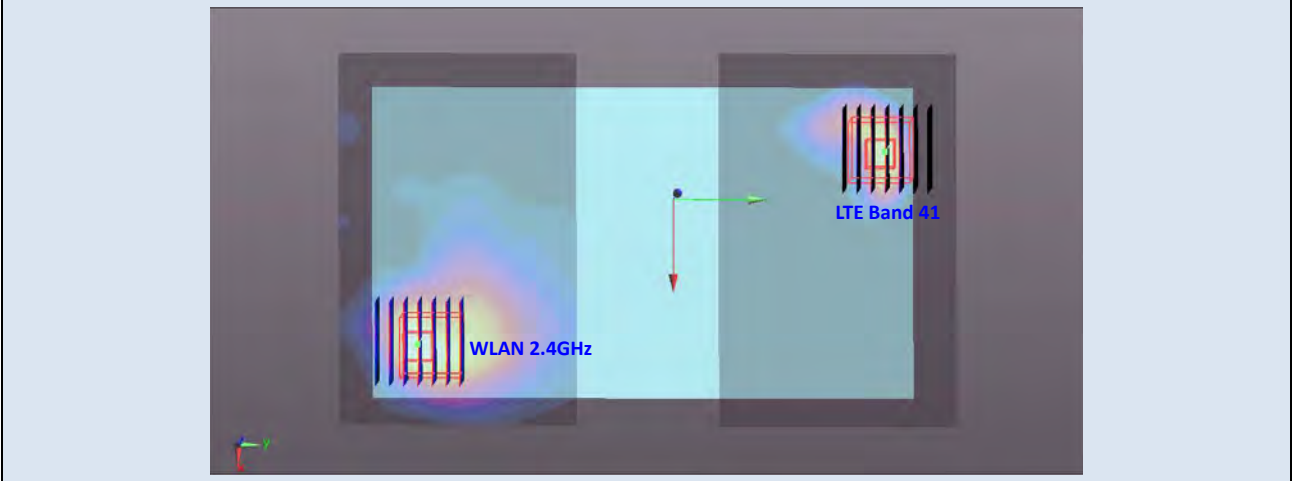

Case No #2	Band	SAR (W/kg)	Gap (mm)	SAR peak location (m)			3D distance (mm)	Pair SAR sum (W/kg)	SPLSR	Simultaneous SAR
				X	Y	Z				
Bottom Face	LTE Band 41	0.979	13	-0.0336	0.0948	-0.182	189.0	2.03	0.02	Not required
	WLAN 2.4GHz	1.048	0	0.0372	-0.0804	-0.181				

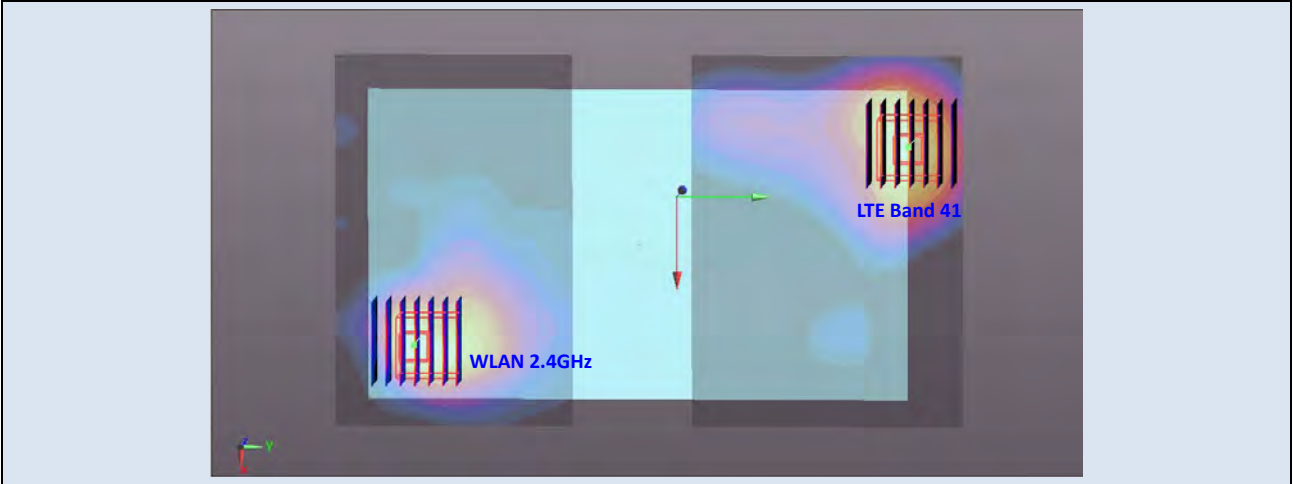

Test Engineer : Luke Lu

17. Uncertainty Assessment

The component of uncertainty may generally be categorized according to the methods used to evaluate them. The evaluation of uncertainty by the statistical analysis of a series of observations is termed a Type A evaluation of uncertainty. The evaluation of uncertainty by means other than the statistical analysis of a series of observation is termed a Type B evaluation of uncertainty. Each component of uncertainty, however evaluated, is represented by an estimated standard deviation, termed standard uncertainty, which is determined by the positive square root of the estimated variance.

A Type A evaluation of standard uncertainty may be based on any valid statistical method for treating data. This includes calculating the standard deviation of the mean of a series of independent observations; using the method of least squares to fit a curve to the data in order to estimate the parameter of the curve and their standard deviations; or carrying out an analysis of variance in order to identify and quantify random effects in certain kinds of measurement.

A type B evaluation of standard uncertainty is typically based on scientific judgment using all of the relevant information available. These may include previous measurement data, experience, and knowledge of the behavior and properties of relevant materials and instruments, manufacture’s specification, data provided in calibration reports and uncertainties assigned to reference data taken from handbooks. Broadly speaking, the uncertainty is either obtained from an outdoor source or obtained from an assumed distribution, such as the normal distribution, rectangular or triangular distributions indicated in table below.

Uncertainty Distributions	Normal	Rectangular	Triangular	U-Shape
Multi-plying Factor ^(a)	1/k ^(b)	1/√3	1/√6	1/√2

(a) standard uncertainty is determined as the product of the multiplying factor and the estimated range of variations in the measured quantity

(b) κ is the coverage factor

Table 17.1. Standard Uncertainty for Assumed Distribution

The combined standard uncertainty of the measurement result represents the estimated standard deviation of the result. It is obtained by combining the individual standard uncertainties of both Type A and Type B evaluation using the usual “root-sum-squares” (RSS) methods of combining standard deviations by taking the positive square root of the estimated variances.

Expanded uncertainty is a measure of uncertainty that defines an interval about the measurement result within which the measured value is confidently believed to lie. It is obtained by multiplying the combined standard uncertainty by a coverage factor. Typically, the coverage factor ranges from 2 to 3. Using a coverage factor allows the true value of a measured quantity to be specified with a defined probability within the specified uncertainty range. For purpose of this document, a coverage factor two is used, which corresponds to confidence interval of about 95 %. The DASY uncertainty Budget is shown in the following tables.

Error Description	Uncertainty Value (±%)	Probability Distribution	Divisor	Ci (1g)	Ci (10g)	Standard Uncertainty (1g)	Standard Uncertainty (10g)
Measurement System							
Probe Calibration	6.0	Normal	1	1	1	± 6.0 %	± 6.0 %
Axial Isotropy	4.7	Rectangular	√3	0.7	0.7	± 1.9 %	± 1.9 %
Hemispherical Isotropy	9.6	Rectangular	√3	0.7	0.7	± 3.9 %	± 3.9 %
Boundary Effects	1.0	Rectangular	√3	1	1	± 0.6 %	± 0.6 %
Linearity	4.7	Rectangular	√3	1	1	± 2.7 %	± 2.7 %
System Detection Limits	1.0	Rectangular	√3	1	1	± 0.6 %	± 0.6 %
Readout Electronics	0.3	Normal	1	1	1	± 0.3 %	± 0.3 %
Response Time	0.8	Rectangular	√3	1	1	± 0.5 %	± 0.5 %
Integration Time	2.6	Rectangular	√3	1	1	± 1.5 %	± 1.5 %
RF Ambient Noise	3.0	Rectangular	√3	1	1	± 1.7 %	± 1.7 %
RF Ambient Reflections	3.0	Rectangular	√3	1	1	± 1.7 %	± 1.7 %
Probe Positioner	0.4	Rectangular	√3	1	1	± 0.2 %	± 0.2 %
Probe Positioning	2.9	Rectangular	√3	1	1	± 1.7 %	± 1.7 %
Max. SAR Eval.	1.0	Rectangular	√3	1	1	± 0.6 %	± 0.6 %
Test Sample Related							
Device Positioning	2.9	Normal	1	1	1	± 2.9 %	± 2.9 %
Device Holder	3.6	Normal	1	1	1	± 3.6 %	± 3.6 %
Power Drift	5.0	Rectangular	√3	1	1	± 2.9 %	± 2.9 %
Phantom and Setup							
Phantom Uncertainty	4.0	Rectangular	√3	1	1	± 2.3 %	± 2.3 %
Liquid Conductivity (Target)	5.0	Rectangular	√3	0.64	0.43	± 1.8 %	± 1.2 %
Liquid Conductivity (Meas.)	2.5	Normal	1	0.64	0.43	± 1.6 %	± 1.1 %
Liquid Permittivity (Target)	5.0	Rectangular	√3	0.6	0.49	± 1.7 %	± 1.4 %
Liquid Permittivity (Meas.)	2.5	Normal	1	0.6	0.49	± 1.5 %	± 1.2 %
Combined Standard Uncertainty						± 11.0 %	± 10.8 %
Coverage Factor for 95 %						K=2	
Expanded Uncertainty						± 22.0 %	± 21.5 %

Table 17.2. Uncertainty Budget for frequency range 300 MHz to 3 GHz



18. References

- [1] FCC 47 CFR Part 2 "Frequency Allocations and Radio Treaty Matters; General Rules and Regulations".
- [2] ANSI/IEEE Std. C95.1-1992, "IEEE Standard for Safety Levels with Respect to Human Exposure to Radio Frequency Electromagnetic Fields, 3 kHz to 300 GHz", September 1992.
- [3] ANSI/IEEE C95.3-2002, IEEE Recommended Practice for the Measurement of Potentially Hazardous Electromagnetic Fields - RF and Microwave, New York: IEEE, December 2002.
- [4] IEEE Std. 1528-2003, "Recommended Practice for Determining the Peak Spatial-Average Specific Absorption Rate (SAR) in the Human Head from Wireless Communications Devices: Measurement Techniques", December 2003.
- [5] SPEAG DASY System Handbook.
- [6] FCC KDB 865664 D01 v01r03 "SAR Measurement Requirements for 100 MHz to 6 GHz", February 2014.
- [7] FCC KDB 865664 D02 v01r01, "RF Exposure Compliance Reporting and Documentation Considerations", May 2013.
- [8] FCC KDB 447498 D01 v05r02 General RF Exposure Guidance "Mobile and Portable Device RF Exposure Procedures and Equipment Authorization Policies", February 2014.
- [9] FCC KDB 248227 D01 v02r01, "SAR Guidance for IEEE 802.11 (WiFi) Transmitters", June 2015.
- [10] FCC KDB 616217 D04 v01r01, "SAR Evaluation Considerations for Laptop, Notebook, Netbook and Tablet Computers", May 2013.
- [11] FCC KDB 941225 D01 3G SAR Procedures v03, "3G SAR measurement procedures", October 2014.
- [12] FCC KDB 941225 D05 v02r03, "SAR Evaluation Considerations for LTE Devices", December 2013



Appendix A. Plots of System Performance Check

The plots are shown as follows.

System Check_Body_835MHz_150723

DUT: D835V2 - SN: 4d091

Communication System: UID 0, CW; Frequency: 835 MHz;Duty Cycle: 1:1
Medium: MSL_835_150723 Medium parameters used: $f = 835$ MHz; $\sigma = 0.974$ S/m; $\epsilon_r = 54.266$; $\rho = 1000$ kg/m³

Ambient Temperature: 23.5 °C ; Liquid Temperature: 22.8 °C

DASY5 Configuration:

- Probe: EX3DV4 - SN3819; ConvF(9.49, 9.49, 9.49); Calibrated: 2014.11.13;
- Sensor-Surface: 2mm (Mechanical Surface Detection)
- Electronics: DAE4 Sn1303; Calibrated: 2014.12.11
- Phantom: SAM3; Type: QDOVA002AA; Serial: TP:1149
- Measurement SW: DASY52, Version 52.8 (7);SEMCAD X Version 14.6.10 (7164)

Pin=250mW/Area Scan (61x61x1): Interpolated grid: dx=15mm, dy=15mm

Maximum value of SAR (interpolated) = 2.76 W/kg

Pin=250mW/Zoom Scan (5x5x7)/Cube 0: Measurement grid: dx=8mm, dy=8mm, dz=5mm

Reference Value = 53.211 V/m; Power Drift = 0.02 dB

Peak SAR (extrapolated) = 3.78 W/kg

SAR(1 g) = 2.56 W/kg; SAR(10 g) = 1.69 W/kg

Maximum value of SAR (measured) = 2.75 W/kg

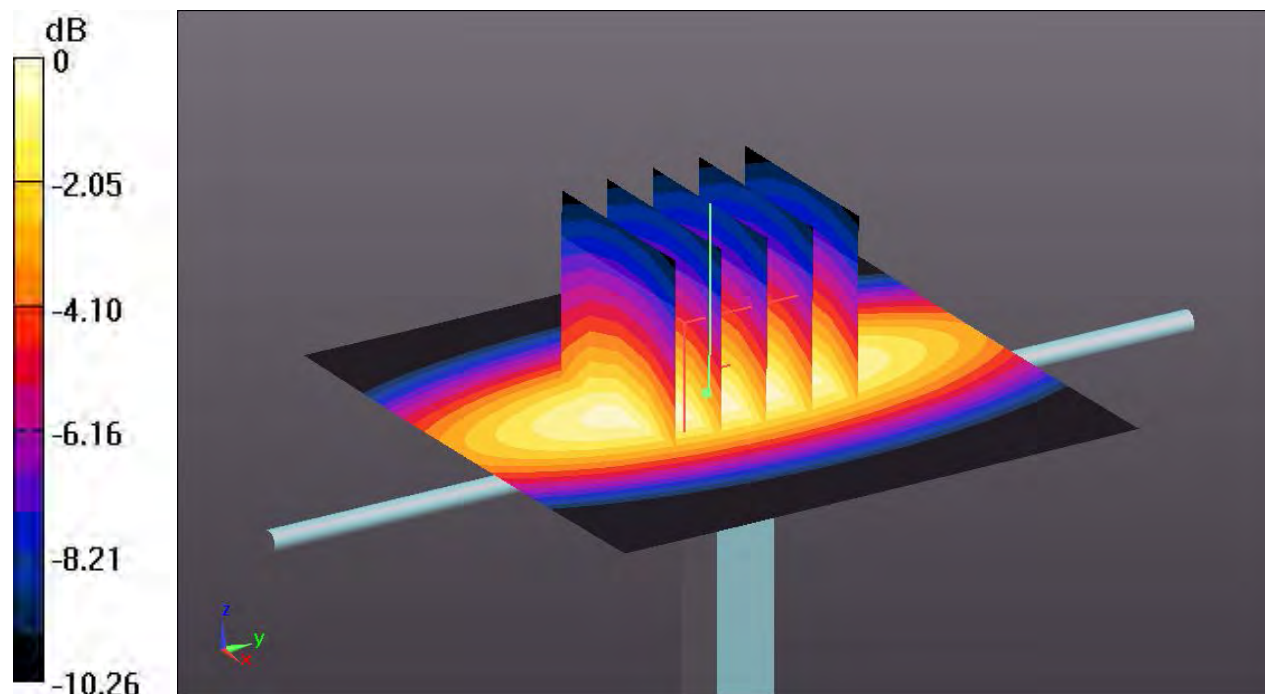

0 dB = 2.76 W/kg

System Check_Body_1900MHz_150722

DUT: D1900V2 - SN: 5d118

Communication System: UID 0, CW; Frequency: 1900 MHz; Duty Cycle: 1:1

Medium: MSL_1900_150722 Medium parameters used: $f = 1900$ MHz; $\sigma = 1.576$ S/m; $\epsilon_r = 54.215$;
 $\rho = 1000$ kg/m³

Ambient Temperature: 23.4 °C ; Liquid Temperature: 22.8 °C

DASY5 Configuration:

- Probe: EX3DV4 - SN3819; ConvF(7.39, 7.39, 7.39); Calibrated: 2014.11.13;
- Sensor-Surface: 2mm (Mechanical Surface Detection)
- Electronics: DAE4 Sn1303; Calibrated: 2014.12.11
- Phantom: SAM3; Type: QDOVA002AA; Serial: TP:1149
- Measurement SW: DASY52, Version 52.8 (7); SEMCAD X Version 14.6.10 (7164)

Pin=250mW/Area Scan (61x61x1): Interpolated grid: dx=15mm, dy=15mm

Maximum value of SAR (interpolated) = 16.2 W/kg

Pin=250mW/Zoom Scan (5x5x7)/Cube 0: Measurement grid: dx=8mm, dy=8mm, dz=5mm

Reference Value = 89.497 V/m; Power Drift = 0.03 dB

Peak SAR (extrapolated) = 20.5 W/kg

SAR(1 g) = 10.4 W/kg; SAR(10 g) = 5.39 W/kg

Maximum value of SAR (measured) = 16.2 W/kg

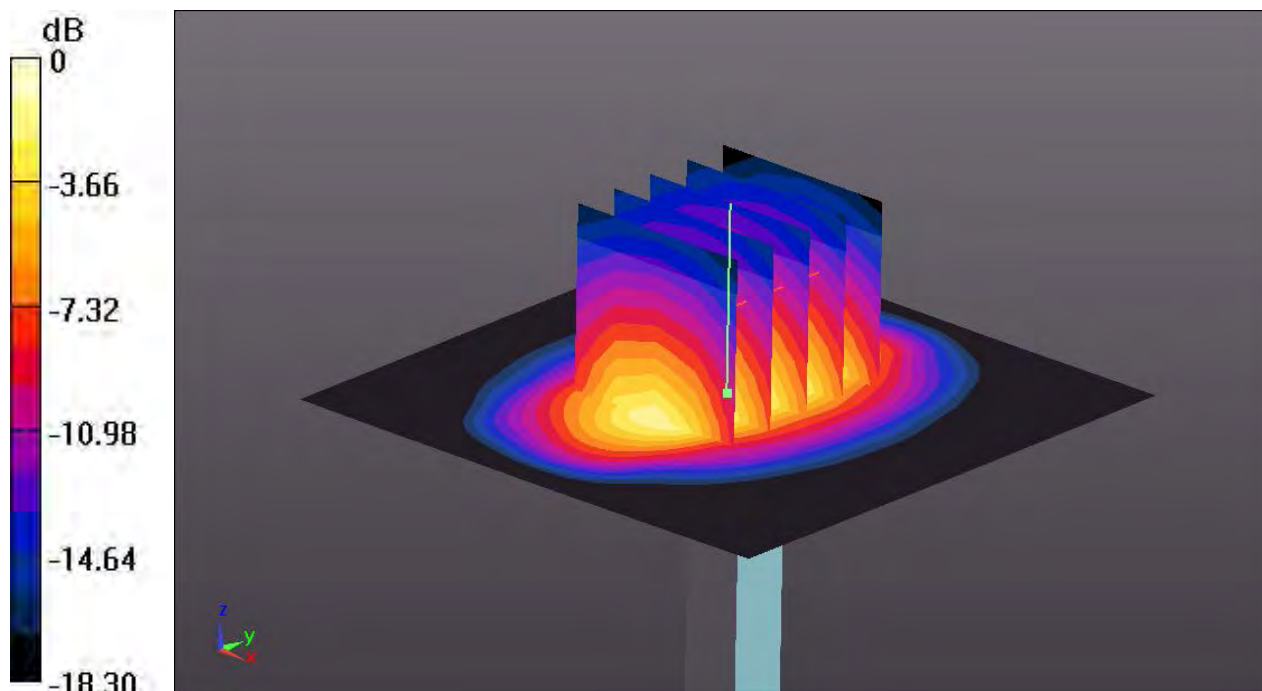

0 dB = 16.2 W/kg

System Check_Body_2450MHz_150720

DUT: D2450V2 - SN: 840

Communication System: UID 0, CW; Frequency: 2450 MHz;Duty Cycle: 1:1
Medium: MSL_2450_150720 Medium parameters used: $f = 2450$ MHz; $\sigma = 1.992$ S/m; $\epsilon_r = 52.291$;
 $\rho = 1000$ kg/m³

Ambient Temperature: 23.3 °C ; Liquid Temperature: 22.7 °C

DASY5 Configuration:

- Probe: EX3DV4 - SN3819; ConvF(6.95, 6.95, 6.95); Calibrated: 2014.11.13;
- Sensor-Surface: 2mm (Mechanical Surface Detection)
- Electronics: DAE4 Sn1303; Calibrated: 2014.12.11
- Phantom: SAM3; Type: QDOVA002AA; Serial: TP:1149
- Measurement SW: DASY52, Version 52.8 (7);SEMCAD X Version 14.6.10 (7164)

Pin=250mW/Area Scan (81x81x1): Interpolated grid: dx=12mm, dy=12mm

Maximum value of SAR (interpolated) = 22.9 W/kg

Pin=250mW/Zoom Scan (7x7x7)/Cube 0: Measurement grid: dx=5mm, dy=5mm, dz=5mm

Reference Value = 91.931 V/m; Power Drift = 0.02 dB

Peak SAR (extrapolated) = 30.8 W/kg

SAR(1 g) = 12.9 W/kg; SAR(10 g) = 5.84 W/kg

Maximum value of SAR (measured) = 22.8 W/kg

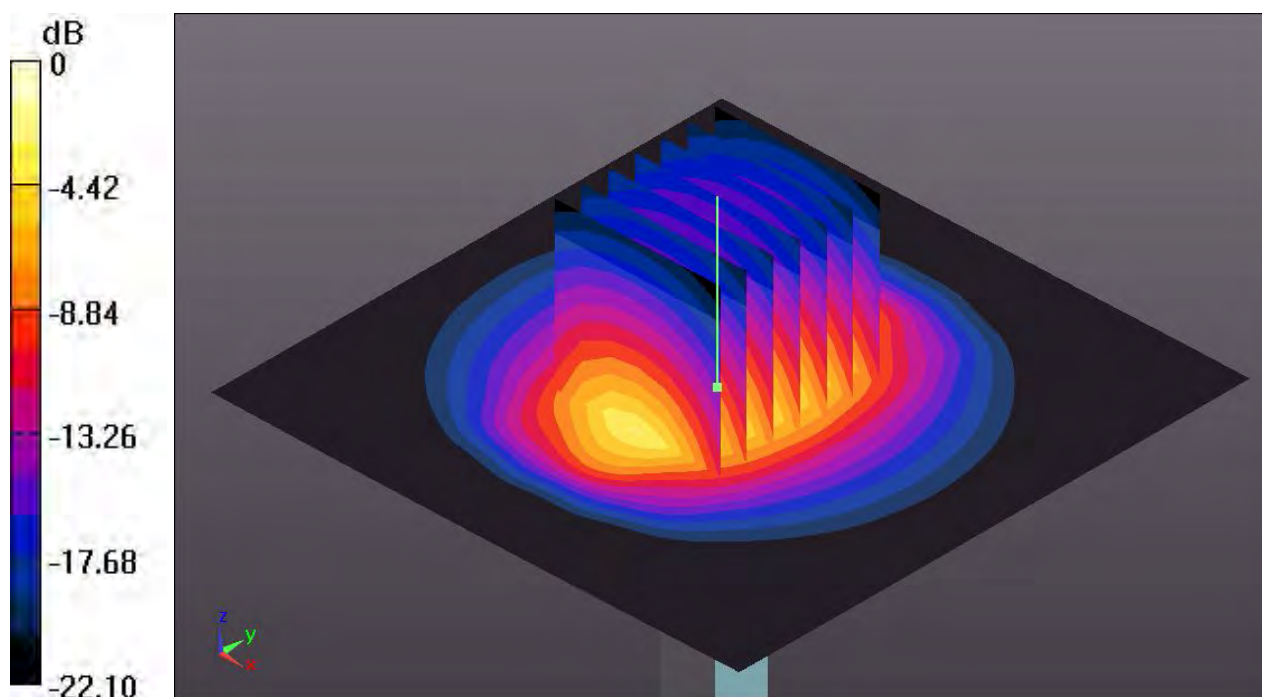

0 dB = 22.9 W/kg

System Check_Body_2600MHz_150717

DUT: D2600V2 - SN: 1061

Communication System: UID 0, CW; Frequency: 2600 MHz;Duty Cycle: 1:1

Medium: MSL_2600_150717 Medium parameters used: $f = 2600$ MHz; $\sigma = 2.165$ S/m; $\epsilon_r = 53.823$; $\rho = 1000$ kg/m³

Ambient Temperature: 23.3 °C ; Liquid Temperature: 22.8 °C

DASY5 Configuration:

- Probe: EX3DV4 - SN3819; ConvF(6.8, 6.8, 6.8); Calibrated: 2014.11.13;
- Sensor-Surface: 2mm (Mechanical Surface Detection)
- Electronics: DAE4 Sn1303; Calibrated: 2014.12.11
- Phantom: SAM3; Type: QDOVA002AA; Serial: TP:1149
- Measurement SW: DASY52, Version 52.8 (7);SEMCAD X Version 14.6.10 (7164)

Pin=250mW/Area Scan (61x61x1): Interpolated grid: dx=12mm, dy=12mm

Maximum value of SAR (interpolated) = 22.3 W/kg

Pin=250mW/Zoom Scan (7x7x7)/Cube 0: Measurement grid: dx=5mm, dy=5mm, dz=5mm

Reference Value = 104.2 V/m; Power Drift = -0.03 dB

Peak SAR (extrapolated) = 30.0 W/kg

SAR(1 g) = 14.4 W/kg; SAR(10 g) = 6.52 W/kg

Maximum value of SAR (measured) = 22.1 W/kg

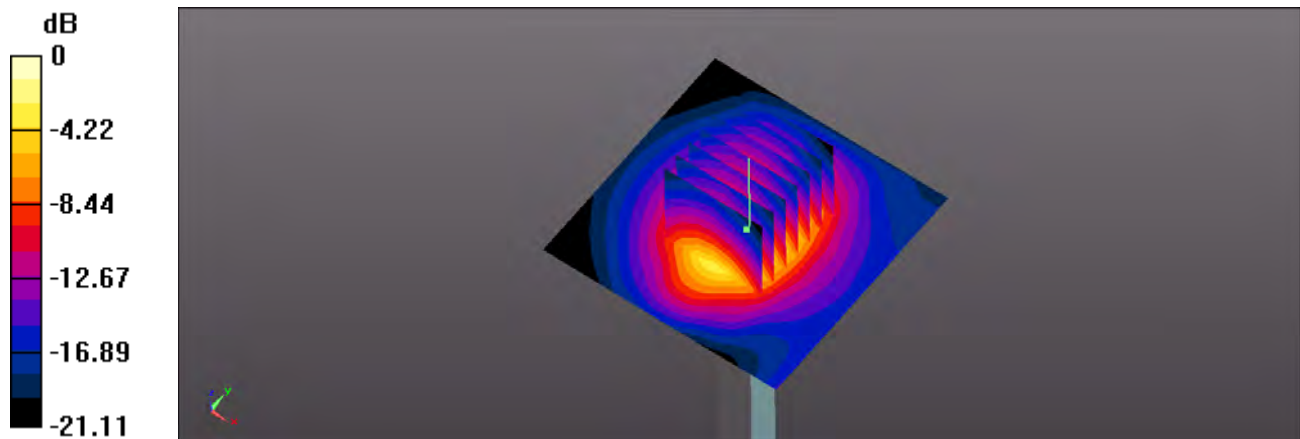

0 dB = 22.3 W/kg

System Check_Body_2600MHz_150719

DUT: D2600V2 - SN: 1061

Communication System: UID 0, CW; Frequency: 2600 MHz;Duty Cycle: 1:1

Medium: MSL_2600_150719 Medium parameters used: $f = 2600$ MHz; $\sigma = 2.209$ S/m; $\epsilon_r = 51.123$;
 $\rho = 1000$ kg/m³

Ambient Temperature: 23.3 °C ; Liquid Temperature: 22.9 °C

DASY5 Configuration:

- Probe: EX3DV4 - SN3819; ConvF(6.8, 6.8, 6.8); Calibrated: 2014.11.13;
- Sensor-Surface: 2mm (Mechanical Surface Detection)
- Electronics: DAE4 Sn1303; Calibrated: 2014.12.11
- Phantom: SAM3; Type: QDOVA002AA; Serial: TP:1149
- Measurement SW: DASY52, Version 52.8 (7);SEMCAD X Version 14.6.10 (7164)

Pin=250mW/Area Scan (61x61x1): Interpolated grid: dx=12mm, dy=12mm

Maximum value of SAR (interpolated) = 22.8 W/kg

Pin=250mW/Zoom Scan (7x7x7)/Cube 0: Measurement grid: dx=5mm, dy=5mm, dz=5mm

Reference Value = 104.2 V/m; Power Drift = -0.09 dB

Peak SAR (extrapolated) = 30.6 W/kg

SAR(1 g) = 14.5 W/kg; SAR(10 g) = 6.59 W/kg

Maximum value of SAR (measured) = 22.7 W/kg

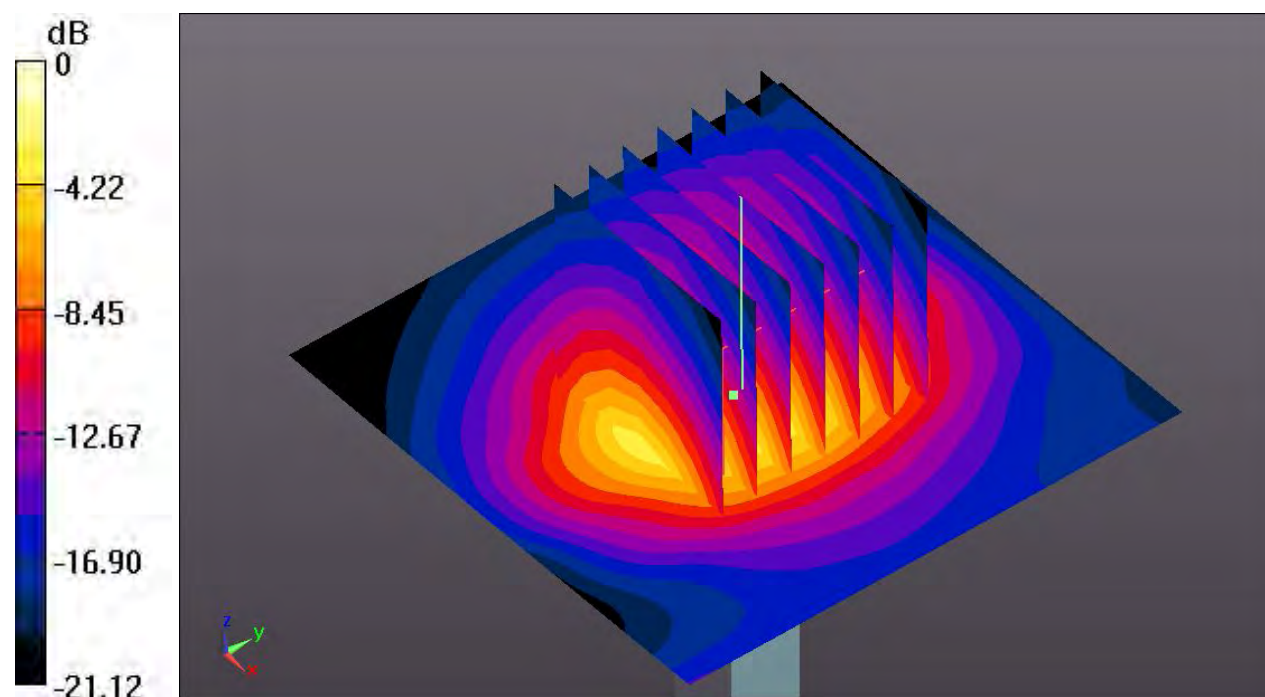

0 dB = 22.8 W/kg



Appendix B. Plots of High SAR Measurement

The plots are shown as follows.

%23_LTE Band 26_15M_QPSK_1RB_0Offset_Edge 2_0mm_Ch26865_Sensor Off

Communication System: UID 0, LTE (0); Frequency: 831.5 MHz;Duty Cycle: 1:1
Medium: MSL_835_150723 Medium parameters used: $f = 831.5$ MHz; $\sigma = 0.971$ S/m; $\epsilon_r = 54.289$;
 $\rho = 1000$ kg/m³
Ambient Temperature: 23.5 °C ; Liquid Temperature: 22.8 °C

DASY5 Configuration:

- Probe: EX3DV4 - SN3819; ConvF(9.49, 9.49, 9.49); Calibrated: 2014.11.13;
- Sensor-Surface: 2mm (Mechanical Surface Detection)
- Electronics: DAE4 Sn1303; Calibrated: 2014.12.11
- Phantom: SAM3; Type: QDOVA002AA; Serial: TP:1149
- Measurement SW: DASY52, Version 52.8 (7);SEMCAD X Version 14.6.10 (7164)

Ch26865/Area Scan (41x151x1): Interpolated grid: dx=15mm, dy=15mm
Maximum value of SAR (interpolated) = 0.454 W/kg

Ch26865/Zoom Scan (5x5x7)/Cube 0: Measurement grid: dx=8mm, dy=8mm, dz=5mm
Reference Value = 2.673 V/m; Power Drift = -0.09 dB
Peak SAR (extrapolated) = 0.563 W/kg
SAR(1 g) = 0.319 W/kg; SAR(10 g) = 0.185 W/kg
Maximum value of SAR (measured) = 0.448 W/kg

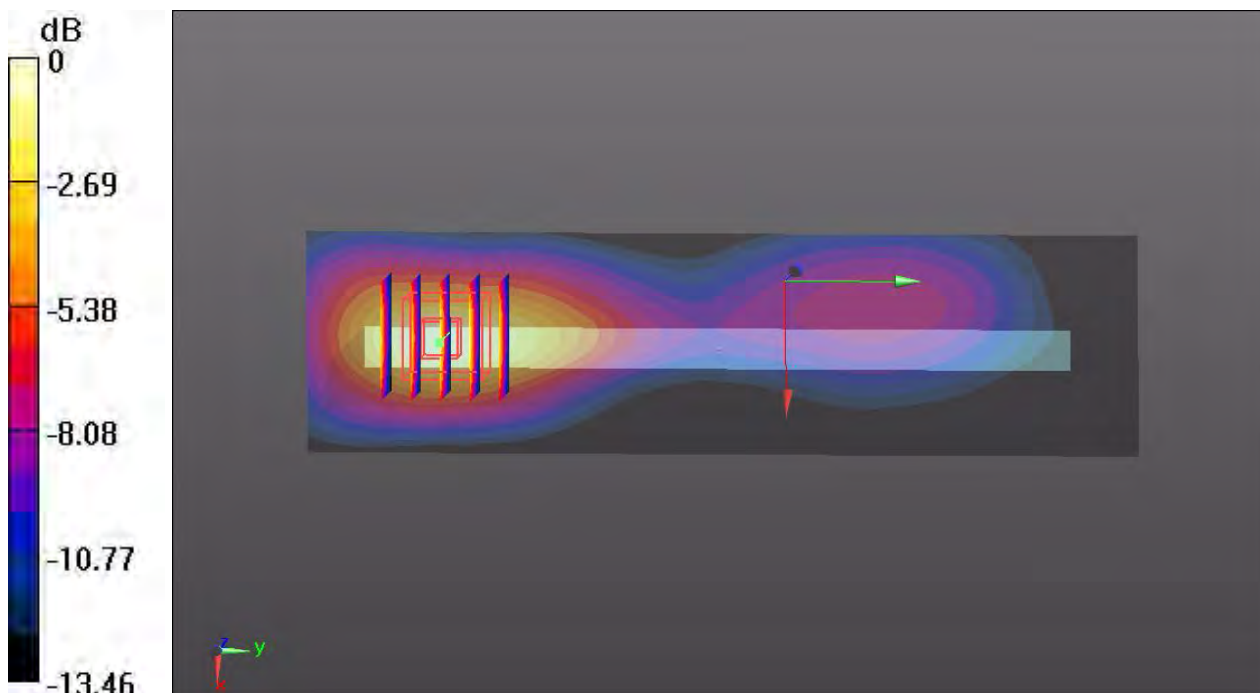

0 dB = 0.454 W/kg

#02_LTE Band 25_20M_QPSK_1RB_0Offset_Edge 2_0mm_Ch26140_Sensor Off

Communication System: UID 0, LTE (0); Frequency: 1860 MHz;Duty Cycle: 1:1

Medium: MSL_1900_150722 Medium parameters used: $f = 1860$ MHz; $\sigma = 1.532$ S/m; $\epsilon_r = 54.365$; $\rho = 1000$ kg/m³

Ambient Temperature: 23.4 °C ; **Liquid Temperature:** 22.8 °C

DASY5 Configuration:

- Probe: EX3DV4 - SN3819; ConvF(7.39, 7.39, 7.39); Calibrated: 2014.11.13;
- Sensor-Surface: 2mm (Mechanical Surface Detection)
- Electronics: DAE4 Sn1303; Calibrated: 2014.12.11
- Phantom: SAM3; Type: QDOVA002AA; Serial: TP:1149
- Measurement SW: DASY52, Version 52.8 (7);SEMCAD X Version 14.6.10 (7164)

Ch26140/Area Scan (41x151x1): Interpolated grid: dx=15mm, dy=15mm

Maximum value of SAR (interpolated) = 0.965 W/kg

Ch26140/Zoom Scan (5x5x7)/Cube 0: Measurement grid: dx=8mm, dy=8mm, dz=5mm

Reference Value = 2.350 V/m; Power Drift = -0.09 dB

Peak SAR (extrapolated) = 1.16 W/kg

SAR(1 g) = 0.650 W/kg; SAR(10 g) = 0.344 W/kg

Maximum value of SAR (measured) = 0.909 W/kg

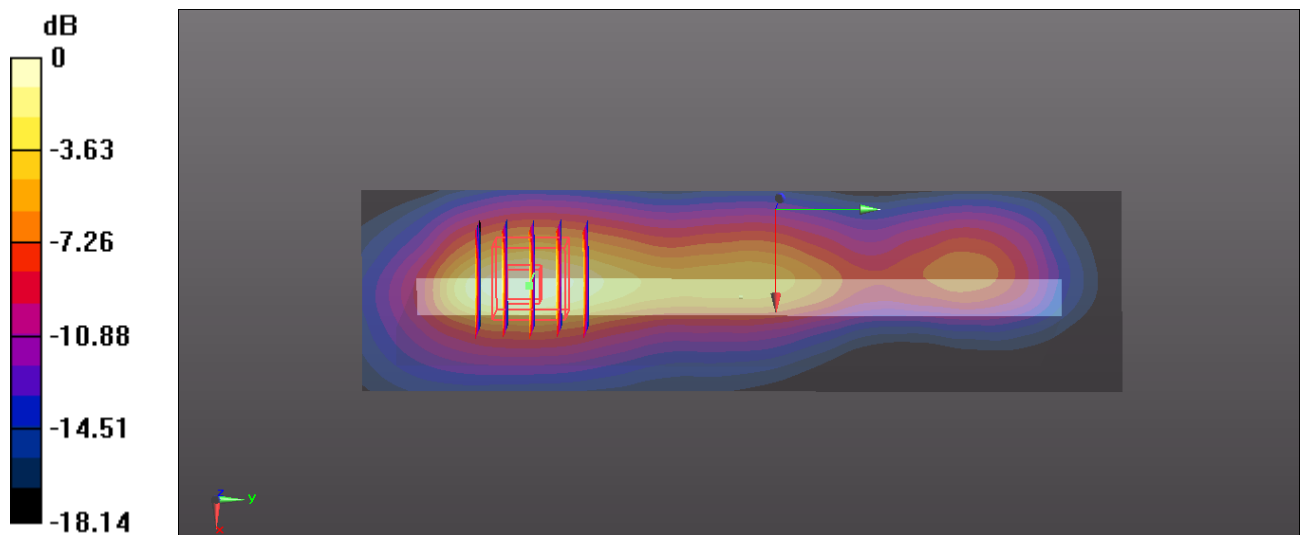

0 dB = 0.965 W/kg

#03_LTE Band 41_20M_QPSK_1RB_0Offset_Edge 1_13mm_Ch41490_Sensor Off

Communication System: UID 0, LTE (0); Frequency: 2680 MHz;Duty Cycle: 1:1.59
Medium: MSL_2600_150717 Medium parameters used: $f = 2680$ MHz; $\sigma = 2.201$ S/m; $\epsilon_r = 53.572$;
 $\rho = 1000$ kg/m³
Ambient Temperature: 23.3 °C ; Liquid Temperature: 22.8 °C

DASY5 Configuration:

- Probe: EX3DV4 - SN3819; ConvF(6.8, 6.8, 6.8); Calibrated: 2014.11.13;
- Sensor-Surface: 2mm (Mechanical Surface Detection)
- Electronics: DAE4 Sn1303; Calibrated: 2014.12.11
- Phantom: SAM3; Type: QDOVA002AA; Serial: TP:1149
- Measurement SW: DASY52, Version 52.8 (7);SEMCAD X Version 14.6.10 (7164)

Ch41490/Area Scan (41x111x1): Interpolated grid: dx=12mm, dy=12mm
Maximum value of SAR (interpolated) = 2.07 W/kg

Ch41490/Zoom Scan (7x7x7)/Cube 0: Measurement grid: dx=5mm, dy=5mm, dz=5mm
Reference Value = 7.327 V/m; Power Drift = -0.03 dB
Peak SAR (extrapolated) = 2.80 W/kg
SAR(1 g) = 1.330 W/kg; SAR(10 g) = 0.701 W/kg
Maximum value of SAR (measured) = 2.05 W/kg

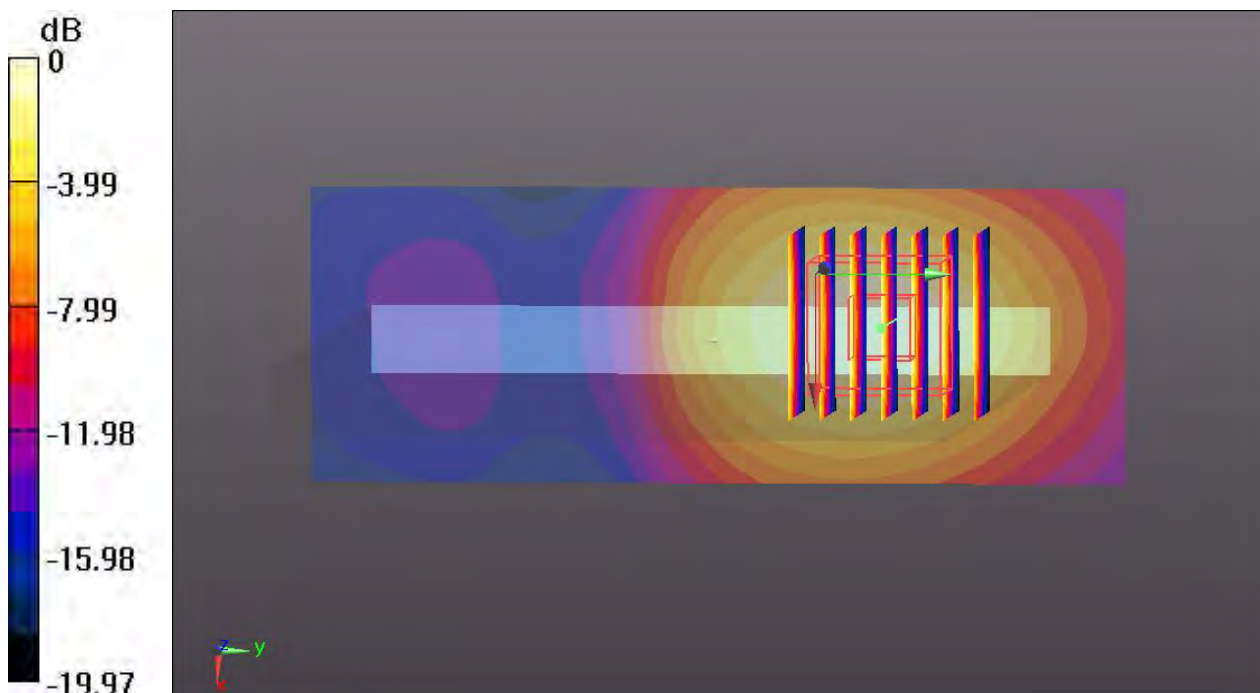

0 dB = 2.07 W/kg

#04_WLAN2.4GHz_802.11b 1Mbps_Curved surface of Edge 3_0mm_Ch11

Communication System: UID 0, WIFI (0); Frequency: 2462 MHz;Duty Cycle: 1:1.021
Medium: MSL_2450_150720 Medium parameters used: $f = 2462$ MHz; $\sigma = 2.012$ S/m; $\epsilon_r = 52.217$;
 $\rho = 1000$ kg/m³

Ambient Temperature: 23.3 °C ; **Liquid Temperature:** 22.7 °C

DASY5 Configuration:

- Probe: EX3DV4 - SN3819; ConvF(6.95, 6.95, 6.95); Calibrated: 2014.11.13;
- Sensor-Surface: 2mm (Mechanical Surface Detection)
- Electronics: DAE4 Sn1303; Calibrated: 2014.12.11
- Phantom: SAM3; Type: QDOVA002AA; Serial: TP:1149
- Measurement SW: DASY52, Version 52.8 (7);SEMCAD X Version 14.6.10 (7164)

Ch11/Area Scan (111x61x1): Interpolated grid: dx=12mm, dy=12mm

Maximum value of SAR (interpolated) = 2.32 W/kg

Ch11/Zoom Scan (7x7x7)/Cube 0: Measurement grid: dx=5mm, dy=5mm, dz=5mm

Reference Value = 0 V/m; Power Drift = 0.01 dB

Peak SAR (extrapolated) = 3.31 W/kg

SAR(1 g) = 1.300 W/kg; SAR(10 g) = 0.487 W/kg

Maximum value of SAR (measured) = 2.26 W/kg

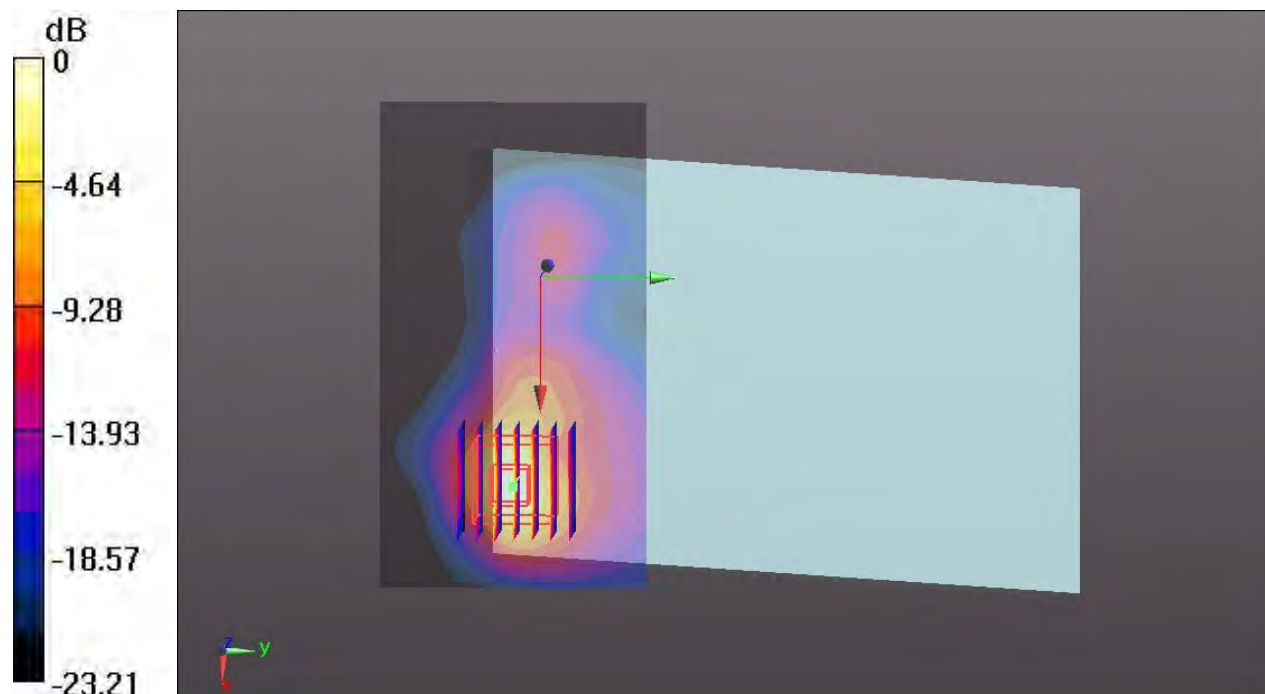

0 dB = 2.32 W/kg



Appendix C. DASYS Calibration Certificate

The DASYS calibration certificates are shown as follows.



Accredited by the Swiss Accreditation Service (SAS)
The Swiss Accreditation Service is one of the signatories to the EA
Multilateral Agreement for the recognition of calibration certificates

Accreditation No.: **SCS 108**

Client **Sporton-CN (Auden)**

Certificate No: **D835V2-4d091_Nov14**

CALIBRATION CERTIFICATE

Object **D835V2 - SN: 4d091**

Calibration procedure(s) **QA CAL-05.v9
Calibration procedure for dipole validation kits above 700 MHz**

Calibration date: **November 21, 2014**

This calibration certificate documents the traceability to national standards, which realize the physical units of measurements (SI).
The measurements and the uncertainties with confidence probability are given on the following pages and are part of the certificate.

All calibrations have been conducted in the closed laboratory facility: environment temperature (22 ± 3)°C and humidity < 70%.

Calibration Equipment used (M&TE critical for calibration)

Primary Standards	ID #	Cal Date (Certificate No.)	Scheduled Calibration
Power meter EPM-442A	GB37480704	07-Oct-14 (No. 217-02020)	Oct-15
Power sensor HP 8481A	US37292783	07-Oct-14 (No. 217-02020)	Oct-15
Power sensor HP 8481A	MY41092317	07-Oct-14 (No. 217-02021)	Oct-15
Reference 20 dB Attenuator	SN: 5058 (20k)	03-Apr-14 (No. 217-01918)	Apr-15
Type-N mismatch combination	SN: 5047.2 / 06327	03-Apr-14 (No. 217-01921)	Apr-15
Reference Probe ES3DV3	SN: 3205	30-Dec-13 (No. ES3-3205_Dec13)	Dec-14
DAE4	SN: 601	18-Aug-14 (No. DAE4-601_Aug14)	Aug-15

Secondary Standards	ID #	Check Date (in house)	Scheduled Check
RF generator R&S SMT-06	100005	04-Aug-99 (in house check Oct-13)	In house check: Oct-16
Network Analyzer HP 8753E	US37390585 S4206	18-Oct-01 (in house check Oct-14)	In house check: Oct-15

Calibrated by: **Name** Michael Weber **Function** Laboratory Technician

Signature

Approved by: **Name** Katja Pokovic **Function** Technical Manager

Issued: November 21, 2014

This calibration certificate shall not be reproduced except in full without written approval of the laboratory.



Accredited by the Swiss Accreditation Service (SAS)
The Swiss Accreditation Service is one of the signatories to the EA
Multilateral Agreement for the recognition of calibration certificates

Accreditation No.: **SCS 108**

Glossary:

TSL	tissue simulating liquid
ConvF	sensitivity in TSL / NORM x,y,z
N/A	not applicable or not measured

Calibration is Performed According to the Following Standards:

- IEEE Std 1528-2013, "IEEE Recommended Practice for Determining the Peak Spatial-Averaged Specific Absorption Rate (SAR) in the Human Head from Wireless Communications Devices: Measurement Techniques", June 2013
- IEC 62209-1, "Procedure to measure the Specific Absorption Rate (SAR) for hand-held devices used in close proximity to the ear (frequency range of 300 MHz to 3 GHz)", February 2005
- KDB 865664, "SAR Measurement Requirements for 100 MHz to 6 GHz"

Additional Documentation:

- DASY4/5 System Handbook

Methods Applied and Interpretation of Parameters:

- Measurement Conditions:* Further details are available from the Validation Report at the end of the certificate. All figures stated in the certificate are valid at the frequency indicated.
- Antenna Parameters with TSL:* The dipole is mounted with the spacer to position its feed point exactly below the center marking of the flat phantom section, with the arms oriented parallel to the body axis.
- Feed Point Impedance and Return Loss:* These parameters are measured with the dipole positioned under the liquid filled phantom. The impedance stated is transformed from the measurement at the SMA connector to the feed point. The Return Loss ensures low reflected power. No uncertainty required.
- Electrical Delay:* One-way delay between the SMA connector and the antenna feed point. No uncertainty required.
- SAR measured:* SAR measured at the stated antenna input power.
- SAR normalized:* SAR as measured, normalized to an input power of 1 W at the antenna connector.
- SAR for nominal TSL parameters:* The measured TSL parameters are used to calculate the nominal SAR result.

The reported uncertainty of measurement is stated as the standard uncertainty of measurement multiplied by the coverage factor $k=2$, which for a normal distribution corresponds to a coverage probability of approximately 95%.

Measurement Conditions

DASY system configuration, as far as not given on page 1.

DASY Version	DASY5	V52.8.8
Extrapolation	Advanced Extrapolation	
Phantom	Modular Flat Phantom	
Distance Dipole Center - TSL	15 mm	with Spacer
Zoom Scan Resolution	dx, dy, dz = 5 mm	
Frequency	835 MHz \pm 1 MHz	

Head TSL parameters

The following parameters and calculations were applied.

	Temperature	Permittivity	Conductivity
Nominal Head TSL parameters	22.0 °C	41.5	0.90 mho/m
Measured Head TSL parameters	(22.0 \pm 0.2) °C	41.2 \pm 6 %	0.91 mho/m \pm 6 %
Head TSL temperature change during test	< 0.5 °C	----	----

SAR result with Head TSL

SAR averaged over 1 cm³ (1 g) of Head TSL	Condition	
SAR measured	250 mW input power	2.30 W/kg
SAR for nominal Head TSL parameters	normalized to 1W	9.11 W/kg \pm 17.0 % (k=2)

SAR averaged over 10 cm³ (10 g) of Head TSL	condition	
SAR measured	250 mW input power	1.50 W/kg
SAR for nominal Head TSL parameters	normalized to 1W	5.95 W/kg \pm 16.5 % (k=2)

Body TSL parameters

The following parameters and calculations were applied.

	Temperature	Permittivity	Conductivity
Nominal Body TSL parameters	22.0 °C	55.2	0.97 mho/m
Measured Body TSL parameters	(22.0 \pm 0.2) °C	54.5 \pm 6 %	1.01 mho/m \pm 6 %
Body TSL temperature change during test	< 0.5 °C	----	----

SAR result with Body TSL

SAR averaged over 1 cm³ (1 g) of Body TSL	Condition	
SAR measured	250 mW input power	2.48 W/kg
SAR for nominal Body TSL parameters	normalized to 1W	9.60 W/kg \pm 17.0 % (k=2)

SAR averaged over 10 cm³ (10 g) of Body TSL	condition	
SAR measured	250 mW input power	1.62 W/kg
SAR for nominal Body TSL parameters	normalized to 1W	6.31 W/kg \pm 16.5 % (k=2)

Appendix (Additional assessments outside the scope of SCS108)

Antenna Parameters with Head TSL

Impedance, transformed to feed point	51.7 Ω - 1.8 j Ω
Return Loss	- 32.2 dB

Antenna Parameters with Body TSL

Impedance, transformed to feed point	46.7 Ω - 4.2 j Ω
Return Loss	- 25.2 dB

General Antenna Parameters and Design

Electrical Delay (one direction)	1.394 ns
----------------------------------	----------

After long term use with 100W radiated power, only a slight warming of the dipole near the feedpoint can be measured.

The dipole is made of standard semirigid coaxial cable. The center conductor of the feeding line is directly connected to the second arm of the dipole. The antenna is therefore short-circuited for DC-signals. On some of the dipoles, small end caps are added to the dipole arms in order to improve matching when loaded according to the position as explained in the "Measurement Conditions" paragraph. The SAR data are not affected by this change. The overall dipole length is still according to the Standard.

No excessive force must be applied to the dipole arms, because they might bend or the soldered connections near the feedpoint may be damaged.

Additional EUT Data

Manufactured by	SPEAG
Manufactured on	September 15, 2009

DASY5 Validation Report for Head TSL

Date: 19.11.2014

Test Laboratory: SPEAG, Zurich, Switzerland

DUT: Dipole 835 MHz; Type: D835V2; Serial: D835V2 - SN: 4d091

Communication System: UID 0 - CW; Frequency: 835 MHz

Medium parameters used: $f = 835$ MHz; $\sigma = 0.91$ S/m; $\epsilon_r = 41.2$; $\rho = 1000$ kg/m³

Phantom section: Flat Section

Measurement Standard: DASY5 (IEEE/IEC/ANSI C63.19-2011)

DASY52 Configuration:

- Probe: ES3DV3 - SN3205; ConvF(6.22, 6.22, 6.22); Calibrated: 30.12.2013;
- Sensor-Surface: 3mm (Mechanical Surface Detection)
- Electronics: DAE4 Sn601; Calibrated: 18.08.2014
- Phantom: Flat Phantom 4.9L; Type: QD000P49AA; Serial: 1001
- DASY52 52.8.8(1222); SEMCAD X 14.6.10(7331)

Dipole Calibration for Head Tissue/Pin=250 mW, d=15mm/Zoom Scan (7x7x7)/Cube 0:

Measurement grid: dx=5mm, dy=5mm, dz=5mm

Reference Value = 56.46 V/m; Power Drift = -0.04 dB

Peak SAR (extrapolated) = 3.43 W/kg

SAR(1 g) = 2.3 W/kg; SAR(10 g) = 1.5 W/kg

Maximum value of SAR (measured) = 2.69 W/kg

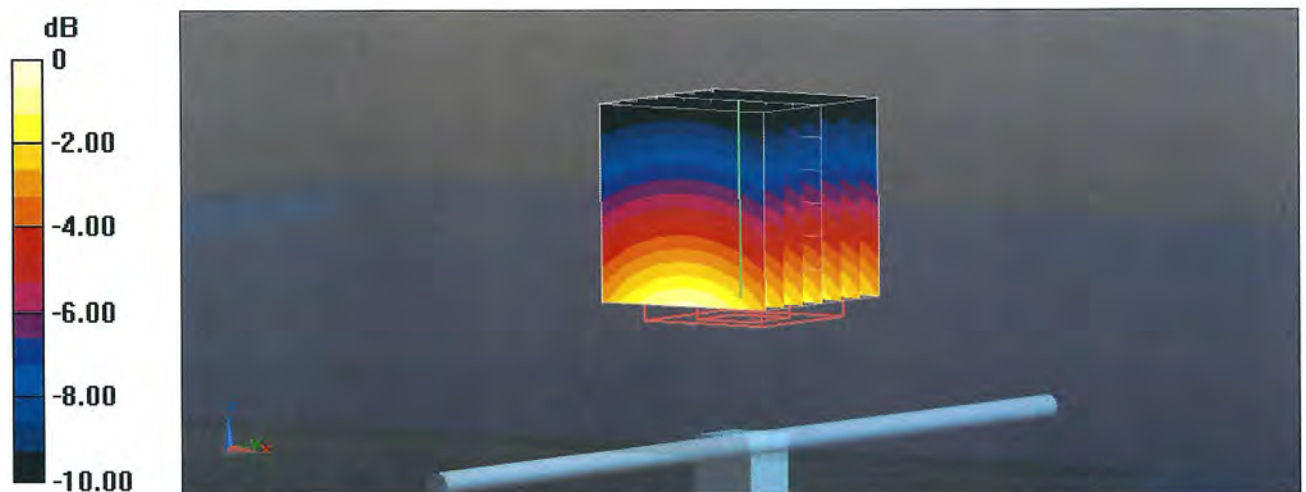

Impedance Measurement Plot for Head TSL

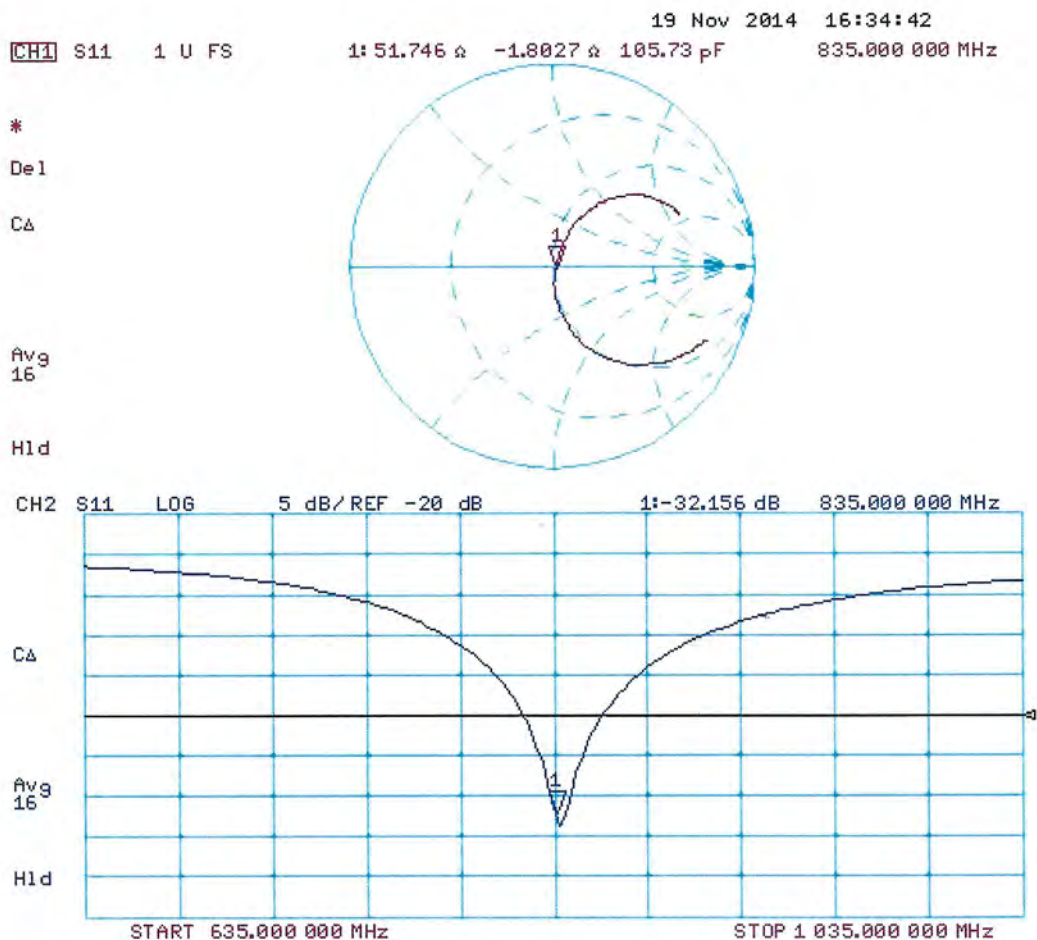

DASY5 Validation Report for Body TSL

Date: 21.11.2014

Test Laboratory: SPEAG, Zurich, Switzerland

DUT: Dipole 835 MHz; Type: D835V2; Serial: D835V2 - SN: 4d091

Communication System: UID 0 - CW; Frequency: 835 MHz

Medium parameters used: $f = 835$ MHz; $\sigma = 1.01$ S/m; $\epsilon_r = 54.5$; $\rho = 1000$ kg/m³

Phantom section: Flat Section

Measurement Standard: DASY5 (IEEE/IEC/ANSI C63.19-2011)

DASY52 Configuration:

- Probe: ES3DV3 - SN3205; ConvF(6.09, 6.09, 6.09); Calibrated: 30.12.2013;
- Sensor-Surface: 3mm (Mechanical Surface Detection)
- Electronics: DAE4 Sn601; Calibrated: 18.08.2014
- Phantom: Flat Phantom 4.9L; Type: QD000P49AA; Serial: 1001
- DASY52 52.8.8(1222); SEMCAD X 14.6.10(7331)

Dipole Calibration for Body Tissue/Pin=250 mW, d=15mm/Zoom Scan (7x7x7)/Cube 0:

Measurement grid: dx=5mm, dy=5mm, dz=5mm

Reference Value = 55.36 V/m; Power Drift = 0.00 dB

Peak SAR (extrapolated) = 3.64 W/kg

SAR(1 g) = 2.48 W/kg; SAR(10 g) = 1.62 W/kg

Maximum value of SAR (measured) = 2.89 W/kg

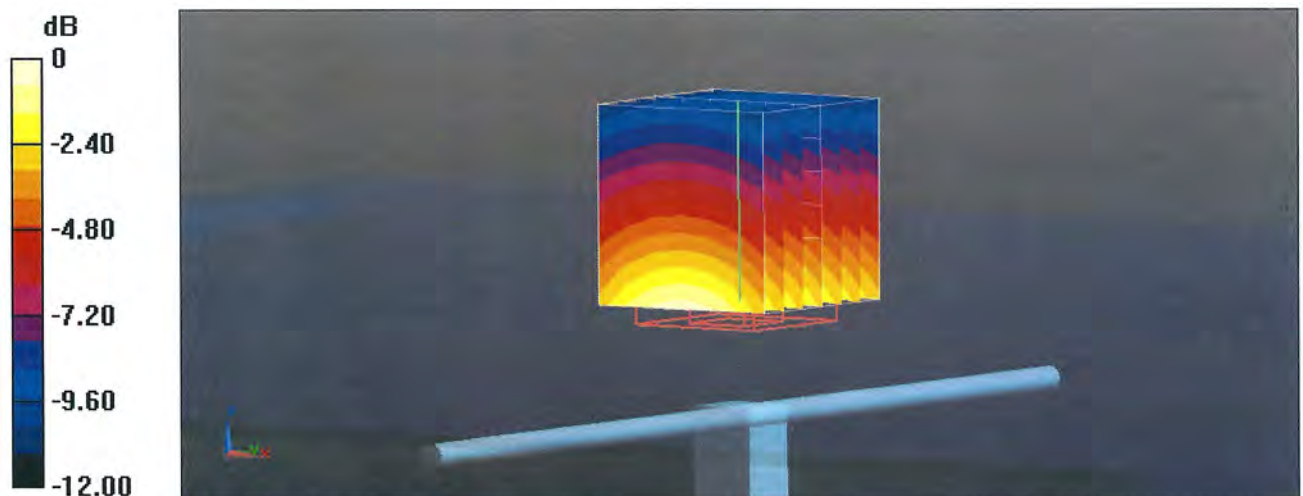

Impedance Measurement Plot for Body TSL

21 Nov 2014 13:55:09

CH1 S11 1 U FS

1: 46.666 Ω -4.1563 Ω 45.860 pF

835.000 000 MHz

*
De1
Cor

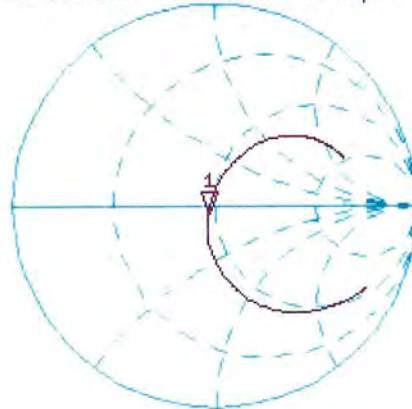

Avg
16

H1d

CH2 S11 LOG 5 dB/REF -20 dB 1:-25.184 dB 835.000 000 MHz

Cor

Avg
16

H1d

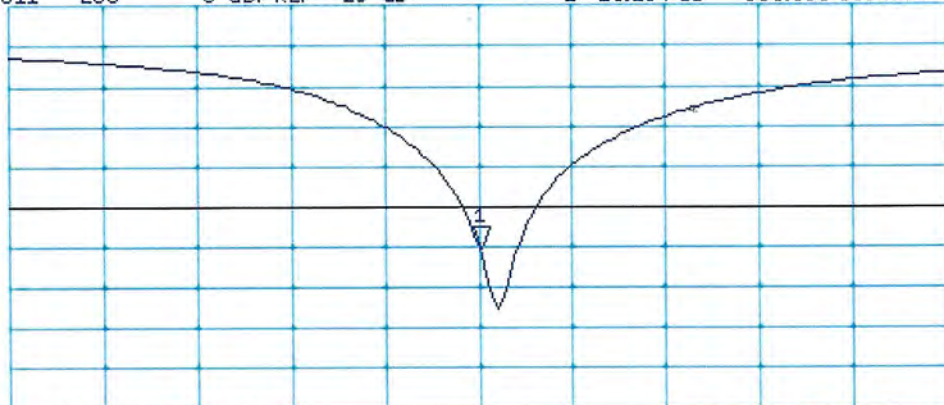

START 635.000 000 MHz

STOP 1 035.000 000 MHz



Accredited by the Swiss Accreditation Service (SAS)
The Swiss Accreditation Service is one of the signatories to the EA
Multilateral Agreement for the recognition of calibration certificates

Accreditation No.: **SCS 108**

Client **Sporton-CN (Auden)**

Certificate No: **D1900V2-5d118_Nov14**

CALIBRATION CERTIFICATE

Object **D1900V2 - SN: 5d118**

Calibration procedure(s) **QA CAL-05.v9
Calibration procedure for dipole validation kits above 700 MHz**

Calibration date: **November 21, 2014**

This calibration certificate documents the traceability to national standards, which realize the physical units of measurements (SI).
The measurements and the uncertainties with confidence probability are given on the following pages and are part of the certificate.

All calibrations have been conducted in the closed laboratory facility: environment temperature (22 ± 3)°C and humidity < 70%.

Calibration Equipment used (M&TE critical for calibration)

Primary Standards	ID #	Cal Date (Certificate No.)	Scheduled Calibration
Power meter EPM-442A	GB37480704	07-Oct-14 (No. 217-02020)	Oct-15
Power sensor HP 8481A	US37292783	07-Oct-14 (No. 217-02020)	Oct-15
Power sensor HP 8481A	MY41092317	07-Oct-14 (No. 217-02021)	Oct-15
Reference 20 dB Attenuator	SN: 5058 (20k)	03-Apr-14 (No. 217-01918)	Apr-15
Type-N mismatch combination	SN: 5047.2 / 06327	03-Apr-14 (No. 217-01921)	Apr-15
Reference Probe ES3DV3	SN: 3205	30-Dec-13 (No. ES3-3205_Dec13)	Dec-14
DAE4	SN: 601	18-Aug-14 (No. DAE4-601_Aug14)	Aug-15
Secondary Standards	ID #	Check Date (in house)	Scheduled Check
RF generator R&S SMT-06	100005	04-Aug-99 (in house check Oct-13)	In house check: Oct-16
Network Analyzer HP 8753E	US37390585 S4206	18-Oct-01 (in house check Oct-14)	In house check: Oct-15

Calibrated by: **Michael Weber** Name: Michael Weber Function: Laboratory Technician

Signature:

Approved by: **Katja Pokovic** Name: Katja Pokovic Function: Technical Manager

Signature:

Issued: November 21, 2014

This calibration certificate shall not be reproduced except in full without written approval of the laboratory.



Accredited by the Swiss Accreditation Service (SAS)

The Swiss Accreditation Service is one of the signatories to the EA
Multilateral Agreement for the recognition of calibration certificates

Accreditation No.: **SCS 108**

Glossary:

TSL	tissue simulating liquid
ConvF	sensitivity in TSL / NORM x,y,z
N/A	not applicable or not measured

Calibration is Performed According to the Following Standards:

- IEEE Std 1528-2013, "IEEE Recommended Practice for Determining the Peak Spatial-Averaged Specific Absorption Rate (SAR) in the Human Head from Wireless Communications Devices: Measurement Techniques", June 2013
- IEC 62209-1, "Procedure to measure the Specific Absorption Rate (SAR) for hand-held devices used in close proximity to the ear (frequency range of 300 MHz to 3 GHz)", February 2005
- KDB 865664, "SAR Measurement Requirements for 100 MHz to 6 GHz"

Additional Documentation:

- DASY4/5 System Handbook

Methods Applied and Interpretation of Parameters:

- Measurement Conditions:* Further details are available from the Validation Report at the end of the certificate. All figures stated in the certificate are valid at the frequency indicated.
- Antenna Parameters with TSL:* The dipole is mounted with the spacer to position its feed point exactly below the center marking of the flat phantom section, with the arms oriented parallel to the body axis.
- Feed Point Impedance and Return Loss:* These parameters are measured with the dipole positioned under the liquid filled phantom. The impedance stated is transformed from the measurement at the SMA connector to the feed point. The Return Loss ensures low reflected power. No uncertainty required.
- Electrical Delay:* One-way delay between the SMA connector and the antenna feed point. No uncertainty required.
- SAR measured:* SAR measured at the stated antenna input power.
- SAR normalized:* SAR as measured, normalized to an input power of 1 W at the antenna connector.
- SAR for nominal TSL parameters:* The measured TSL parameters are used to calculate the nominal SAR result.

The reported uncertainty of measurement is stated as the standard uncertainty of measurement multiplied by the coverage factor $k=2$, which for a normal distribution corresponds to a coverage probability of approximately 95%.

Measurement Conditions

DASY system configuration, as far as not given on page 1.

DASY Version	DASY5	V52.8.8
Extrapolation	Advanced Extrapolation	
Phantom	Modular Flat Phantom	
Distance Dipole Center - TSL	10 mm	with Spacer
Zoom Scan Resolution	dx, dy, dz = 5 mm	
Frequency	1900 MHz \pm 1 MHz	

Head TSL parameters

The following parameters and calculations were applied.

	Temperature	Permittivity	Conductivity
Nominal Head TSL parameters	22.0 °C	40.0	1.40 mho/m
Measured Head TSL parameters	(22.0 \pm 0.2) °C	40.1 \pm 6 %	1.39 mho/m \pm 6 %
Head TSL temperature change during test	< 0.5 °C	----	----

SAR result with Head TSL

SAR averaged over 1 cm³ (1 g) of Head TSL	Condition	
SAR measured	250 mW input power	9.97 W/kg
SAR for nominal Head TSL parameters	normalized to 1W	40.1 W/kg \pm 17.0 % (k=2)

SAR averaged over 10 cm³ (10 g) of Head TSL	condition	
SAR measured	250 mW input power	5.24 W/kg
SAR for nominal Head TSL parameters	normalized to 1W	21.0 W/kg \pm 16.5 % (k=2)

Body TSL parameters

The following parameters and calculations were applied.

	Temperature	Permittivity	Conductivity
Nominal Body TSL parameters	22.0 °C	53.3	1.52 mho/m
Measured Body TSL parameters	(22.0 \pm 0.2) °C	53.3 \pm 6 %	1.52 mho/m \pm 6 %
Body TSL temperature change during test	< 0.5 °C	----	----

SAR result with Body TSL

SAR averaged over 1 cm³ (1 g) of Body TSL	Condition	
SAR measured	250 mW input power	10.0 W/kg
SAR for nominal Body TSL parameters	normalized to 1W	40.0 W/kg \pm 17.0 % (k=2)

SAR averaged over 10 cm³ (10 g) of Body TSL	condition	
SAR measured	250 mW input power	5.34 W/kg
SAR for nominal Body TSL parameters	normalized to 1W	21.4 W/kg \pm 16.5 % (k=2)

Appendix (Additional assessments outside the scope of SCS108)

Antenna Parameters with Head TSL

Impedance, transformed to feed point	52.3 Ω + 6.8 j Ω
Return Loss	- 23.1 dB

Antenna Parameters with Body TSL

Impedance, transformed to feed point	47.5 Ω + 7.1 j Ω
Return Loss	- 22.3 dB

General Antenna Parameters and Design

Electrical Delay (one direction)	1.201 ns
----------------------------------	----------

After long term use with 100W radiated power, only a slight warming of the dipole near the feedpoint can be measured.

The dipole is made of standard semirigid coaxial cable. The center conductor of the feeding line is directly connected to the second arm of the dipole. The antenna is therefore short-circuited for DC-signals. On some of the dipoles, small end caps are added to the dipole arms in order to improve matching when loaded according to the position as explained in the "Measurement Conditions" paragraph. The SAR data are not affected by this change. The overall dipole length is still according to the Standard.

No excessive force must be applied to the dipole arms, because they might bend or the soldered connections near the feedpoint may be damaged.

Additional EUT Data

Manufactured by	SPEAG
Manufactured on	August 21, 2009

DASY5 Validation Report for Head TSL

Date: 21.11.2014

Test Laboratory: SPEAG, Zurich, Switzerland

DUT: Dipole 1900 MHz; Type: D1900V2; Serial: D1900V2 - SN: 5d118

Communication System: UID 0 - CW; Frequency: 1900 MHz

Medium parameters used: $f = 1900$ MHz; $\sigma = 1.39$ S/m; $\epsilon_r = 40.1$; $\rho = 1000$ kg/m³

Phantom section: Flat Section

Measurement Standard: DASY5 (IEEE/IEC/ANSI C63.19-2011)

DASY52 Configuration:

- Probe: ES3DV3 - SN3205; ConvF(5.06, 5.06, 5.06); Calibrated: 30.12.2013;
- Sensor-Surface: 3mm (Mechanical Surface Detection)
- Electronics: DAE4 Sn601; Calibrated: 18.08.2014
- Phantom: Flat Phantom 5.0 (front); Type: QD000P50AA; Serial: 1001
- DASY52 52.8.8(1222); SEMCAD X 14.6.10(7331)

Dipole Calibration for Head Tissue/Pin=250 mW, d=10mm/Zoom Scan (7x7x7)/Cube 0:

Measurement grid: dx=5mm, dy=5mm, dz=5mm

Reference Value = 98.04 V/m; Power Drift = 0.03 dB

Peak SAR (extrapolated) = 18.2 W/kg

SAR(1 g) = 9.97 W/kg; SAR(10 g) = 5.24 W/kg

Maximum value of SAR (measured) = 12.6 W/kg

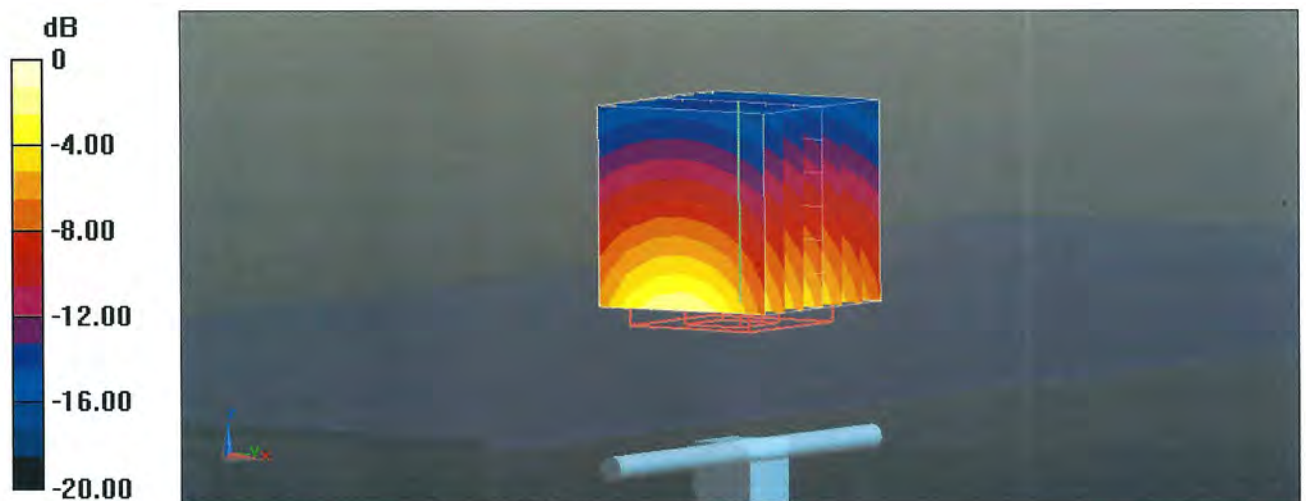

0 dB = 12.6 W/kg = 11.00 dBW/kg

Impedance Measurement Plot for Head TSL

21 Nov 2014 12:34:52

CH1 S11 1 U FS

1: 52.277 Ω 6.8418 Ω 573.11 pF

1 900.000 000 MHz

*
De1

CA

Avg
16

H1d

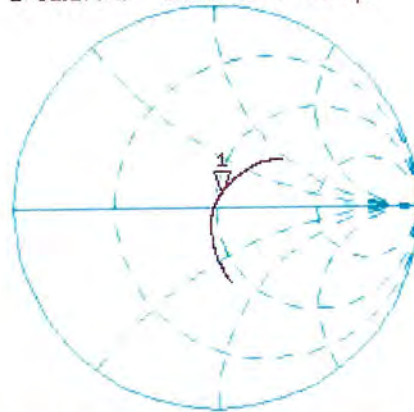

CH2 S11 LOG 5 dB/REF -20 dB 1:-23.051 dB 1 900.000 000 MHz

CA

Avg
16

H1d

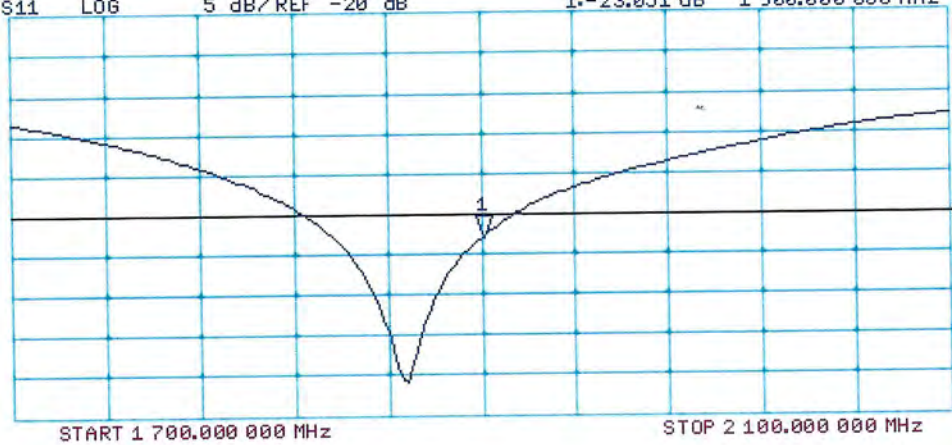

DASY5 Validation Report for Body TSL

Date: 21.11.2014

Test Laboratory: SPEAG, Zurich, Switzerland

DUT: Dipole 1900 MHz; Type: D1900V2; Serial: D1900V2 - SN: 5d118

Communication System: UID 0 - CW; Frequency: 1900 MHz

Medium parameters used: $f = 1900$ MHz; $\sigma = 1.52$ S/m; $\epsilon_r = 53.3$; $\rho = 1000$ kg/m³

Phantom section: Flat Section

Measurement Standard: DASY5 (IEEE/IEC/ANSI C63.19-2011)

DASY52 Configuration:

- Probe: ES3DV3 - SN3205; ConvF(4.76, 4.76, 4.76); Calibrated: 30.12.2013;
- Sensor-Surface: 3mm (Mechanical Surface Detection)
- Electronics: DAE4 Sn601; Calibrated: 18.08.2014
- Phantom: Flat Phantom 5.0 (back); Type: QD000P50AA; Serial: 1002
- DASY52 52.8.8(1222); SEMCAD X 14.6.10(7331)

Dipole Calibration for Body Tissue/Pin=250 mW, d=10mm/Zoom Scan (7x7x7)/Cube 0:

Measurement grid: dx=5mm, dy=5mm, dz=5mm

Reference Value = 95.09 V/m; Power Drift = 0.01 dB

Peak SAR (extrapolated) = 17.5 W/kg

SAR(1 g) = 10 W/kg; SAR(10 g) = 5.34 W/kg

Maximum value of SAR (measured) = 12.7 W/kg

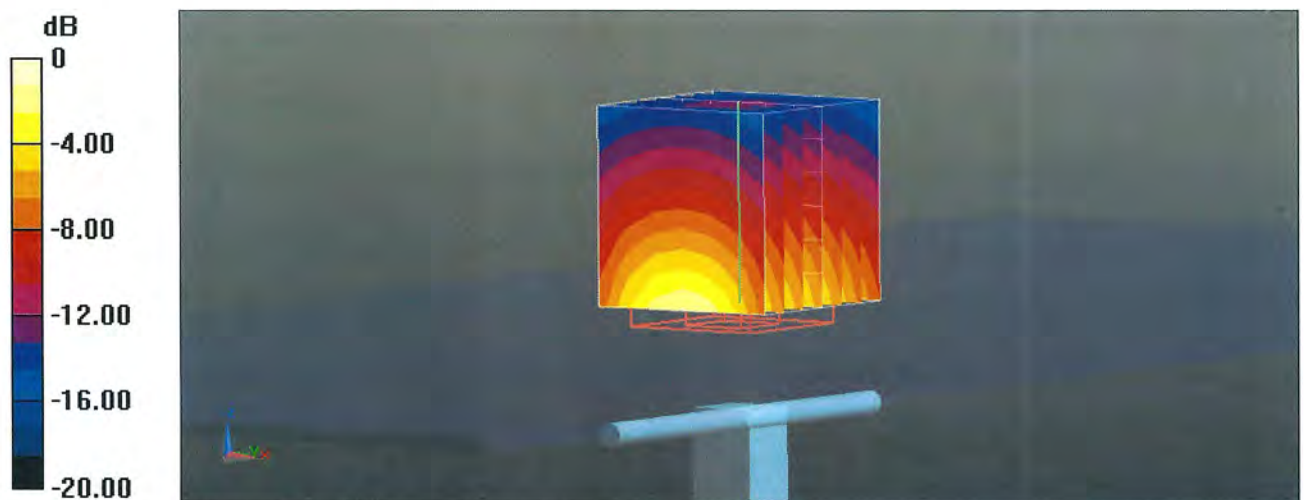

0 dB = 12.7 W/kg = 11.04 dBW/kg

Impedance Measurement Plot for Body TSL

21 Nov 2014 12:34:24

CH1 S11 1 U FS 1: 47.516 Ω 7.0566 Ω 591.10 pF 1 900.000 000 MHz

*
De1
CA

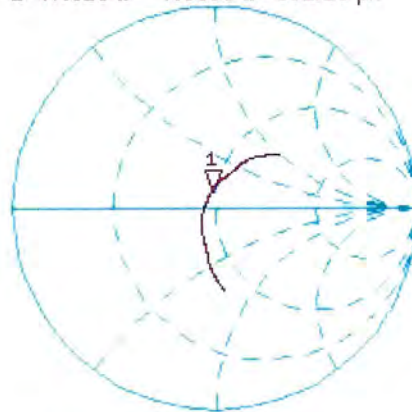

Avg
16
H1d

CH2 S11 LOG 5 dB/REF -20 dB 1: -22.324 dB 1 900.000 000 MHz

CA
Avg
16
H1d





Accredited by the Swiss Accreditation Service (SAS)
The Swiss Accreditation Service is one of the signatories to the EA
Multilateral Agreement for the recognition of calibration certificates

Accreditation No.: **SCS 108**

Client **Sporton-CN (Auden)**

Certificate No: **D2450V2-840_Nov14**

CALIBRATION CERTIFICATE

Object **D2450V2 - SN: 840**

Calibration procedure(s) **QA CAL-05.v9
Calibration procedure for dipole validation kits above 700 MHz**

Calibration date: **November 19, 2014**

This calibration certificate documents the traceability to national standards, which realize the physical units of measurements (SI).
The measurements and the uncertainties with confidence probability are given on the following pages and are part of the certificate.

All calibrations have been conducted in the closed laboratory facility: environment temperature (22 ± 3)°C and humidity < 70%.

Calibration Equipment used (M&TE critical for calibration)

Primary Standards	ID #	Cal Date (Certificate No.)	Scheduled Calibration
Power meter EPM-442A	GB37480704	07-Oct-14 (No. 217-02020)	Oct-15
Power sensor HP 8481A	US37292783	07-Oct-14 (No. 217-02020)	Oct-15
Power sensor HP 8481A	MY41092317	07-Oct-14 (No. 217-02021)	Oct-15
Reference 20 dB Attenuator	SN: 5058 (20k)	03-Apr-14 (No. 217-01918)	Apr-15
Type-N mismatch combination	SN: 5047.2 / 06327	03-Apr-14 (No. 217-01921)	Apr-15
Reference Probe ES3DV3	SN: 3205	30-Dec-13 (No. ES3-3205_Dec13)	Dec-14
DAE4	SN: 601	18-Aug-14 (No. DAE4-601_Aug14)	Aug-15
Secondary Standards	ID #	Check Date (in house)	Scheduled Check
RF generator R&S SMT-06	100005	04-Aug-99 (in house check Oct-13)	In house check: Oct-16
Network Analyzer HP 8753E	US37390585 S4206	18-Oct-01 (in house check Oct-14)	In house check: Oct-15

	Name	Function	Signature
Calibrated by:	Jeton Kastrati	Laboratory Technician	
Approved by:	Katja Pokovic	Technical Manager	

Issued: November 20, 2014

This calibration certificate shall not be reproduced except in full without written approval of the laboratory.



Accredited by the Swiss Accreditation Service (SAS)

The Swiss Accreditation Service is one of the signatories to the EA
Multilateral Agreement for the recognition of calibration certificates

Accreditation No.: **SCS 108**

Glossary:

TSL	tissue simulating liquid
ConvF	sensitivity in TSL / NORM x,y,z
N/A	not applicable or not measured

Calibration is Performed According to the Following Standards:

- IEEE Std 1528-2013, "IEEE Recommended Practice for Determining the Peak Spatial-Averaged Specific Absorption Rate (SAR) in the Human Head from Wireless Communications Devices: Measurement Techniques", June 2013
- IEC 62209-1, "Procedure to measure the Specific Absorption Rate (SAR) for hand-held devices used in close proximity to the ear (frequency range of 300 MHz to 3 GHz)", February 2005
- KDB 865664, "SAR Measurement Requirements for 100 MHz to 6 GHz"

Additional Documentation:

- DASY4/5 System Handbook

Methods Applied and Interpretation of Parameters:

- Measurement Conditions:** Further details are available from the Validation Report at the end of the certificate. All figures stated in the certificate are valid at the frequency indicated.
- Antenna Parameters with TSL:** The dipole is mounted with the spacer to position its feed point exactly below the center marking of the flat phantom section, with the arms oriented parallel to the body axis.
- Feed Point Impedance and Return Loss:** These parameters are measured with the dipole positioned under the liquid filled phantom. The impedance stated is transformed from the measurement at the SMA connector to the feed point. The Return Loss ensures low reflected power. No uncertainty required.
- Electrical Delay:** One-way delay between the SMA connector and the antenna feed point. No uncertainty required.
- SAR measured:** SAR measured at the stated antenna input power.
- SAR normalized:** SAR as measured, normalized to an input power of 1 W at the antenna connector.
- SAR for nominal TSL parameters:** The measured TSL parameters are used to calculate the nominal SAR result.

The reported uncertainty of measurement is stated as the standard uncertainty of measurement multiplied by the coverage factor $k=2$, which for a normal distribution corresponds to a coverage probability of approximately 95%.

Measurement Conditions

DASY system configuration, as far as not given on page 1.

DASY Version	DASY5	V52.8.8
Extrapolation	Advanced Extrapolation	
Phantom	Modular Flat Phantom	
Distance Dipole Center - TSL	10 mm	with Spacer
Zoom Scan Resolution	dx, dy, dz = 5 mm	
Frequency	2450 MHz ± 1 MHz	

Head TSL parameters

The following parameters and calculations were applied.

	Temperature	Permittivity	Conductivity
Nominal Head TSL parameters	22.0 °C	39.2	1.80 mho/m
Measured Head TSL parameters	(22.0 ± 0.2) °C	39.0 ± 6 %	1.86 mho/m ± 6 %
Head TSL temperature change during test	< 0.5 °C	----	----

SAR result with Head TSL

SAR averaged over 1 cm³ (1 g) of Head TSL	Condition	
SAR measured	250 mW input power	13.3 W/kg
SAR for nominal Head TSL parameters	normalized to 1W	52.3 W/kg ± 17.0 % (k=2)

SAR averaged over 10 cm³ (10 g) of Head TSL	condition	
SAR measured	250 mW input power	6.21 W/kg
SAR for nominal Head TSL parameters	normalized to 1W	24.6 W/kg ± 16.5 % (k=2)

Body TSL parameters

The following parameters and calculations were applied.

	Temperature	Permittivity	Conductivity
Nominal Body TSL parameters	22.0 °C	52.7	1.95 mho/m
Measured Body TSL parameters	(22.0 ± 0.2) °C	50.9 ± 6 %	2.03 mho/m ± 6 %
Body TSL temperature change during test	< 0.5 °C	----	----

SAR result with Body TSL

SAR averaged over 1 cm³ (1 g) of Body TSL	Condition	
SAR measured	250 mW input power	13.1 W/kg
SAR for nominal Body TSL parameters	normalized to 1W	51.0 W/kg ± 17.0 % (k=2)

SAR averaged over 10 cm³ (10 g) of Body TSL	condition	
SAR measured	250 mW input power	6.00 W/kg
SAR for nominal Body TSL parameters	normalized to 1W	23.6 W/kg ± 16.5 % (k=2)

Appendix (Additional assessments outside the scope of SCS108)

Antenna Parameters with Head TSL

Impedance, transformed to feed point	54.7 Ω + 2.8 j Ω
Return Loss	- 25.6 dB

Antenna Parameters with Body TSL

Impedance, transformed to feed point	50.9 Ω + 4.4 j Ω
Return Loss	- 27.0 dB

General Antenna Parameters and Design

Electrical Delay (one direction)	1.162 ns
----------------------------------	----------

After long term use with 100W radiated power, only a slight warming of the dipole near the feedpoint can be measured.

The dipole is made of standard semirigid coaxial cable. The center conductor of the feeding line is directly connected to the second arm of the dipole. The antenna is therefore short-circuited for DC-signals. On some of the dipoles, small end caps are added to the dipole arms in order to improve matching when loaded according to the position as explained in the "Measurement Conditions" paragraph. The SAR data are not affected by this change. The overall dipole length is still according to the Standard.

No excessive force must be applied to the dipole arms, because they might bend or the soldered connections near the feedpoint may be damaged.

Additional EUT Data

Manufactured by	SPEAG
Manufactured on	July 20, 2009

DASY5 Validation Report for Head TSL

Date: 19.11.2014

Test Laboratory: SPEAG, Zurich, Switzerland

DUT: Dipole 2450 MHz; Type: D2450V2; Serial: D2450V2 - SN: 840

Communication System: UID 0 - CW; Frequency: 2450 MHz

Medium parameters used: $f = 2450$ MHz; $\sigma = 1.86$ S/m; $\epsilon_r = 39$; $\rho = 1000$ kg/m³

Phantom section: Flat Section

Measurement Standard: DASY5 (IEEE/IEC/ANSI C63.19-2011)

DASY52 Configuration:

- Probe: ES3DV3 - SN3205; ConvF(4.53, 4.53, 4.53); Calibrated: 30.12.2013;
- Sensor-Surface: 3mm (Mechanical Surface Detection)
- Electronics: DAE4 Sn601; Calibrated: 18.08.2014
- Phantom: Flat Phantom 5.0 (front); Type: QD000P50AA; Serial: 1001
- DASY52 52.8.8(1222); SEMCAD X 14.6.10(7331)

Dipole Calibration for Head Tissue/Pin=250 mW, d=10mm/Zoom Scan (7x7x7)/Cube 0:

Measurement grid: dx=5mm, dy=5mm, dz=5mm

Reference Value = 100.9 V/m; Power Drift = 0.02 dB

Peak SAR (extrapolated) = 27.3 W/kg

SAR(1 g) = 13.3 W/kg; SAR(10 g) = 6.21 W/kg

Maximum value of SAR (measured) = 17.5 W/kg

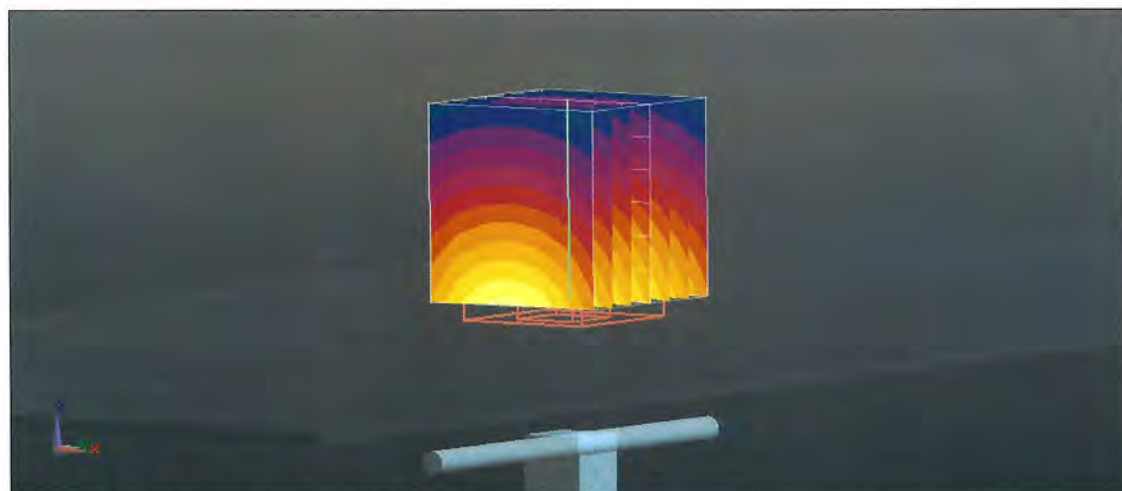
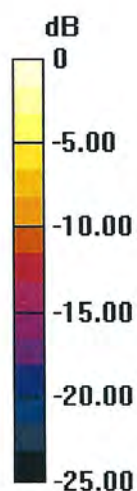

Impedance Measurement Plot for Head TSL

19 Nov 2014 17:06:19

CH1 S11 1 U FS 1: 54.719 Δ 2.7773 Δ 180.42 μ H 2 450.000 000 MHz

*
De1
CA
Avg
16
H1d

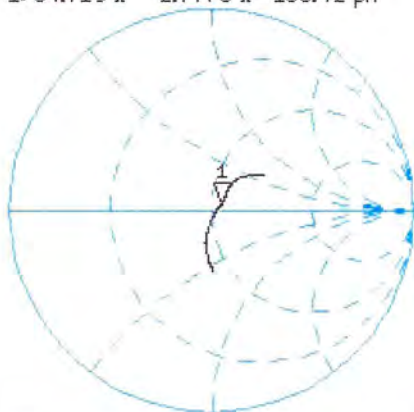

CH2 S11 LOG 5 dB/REF -20 dB 1: -25.634 dB 2 450.000 000 MHz

CA
Avg
16
H1d

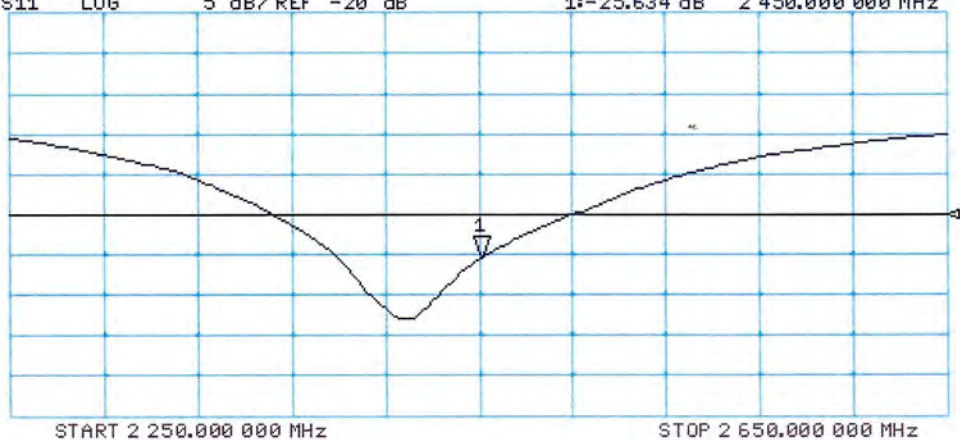

DASY5 Validation Report for Body TSL

Date: 19.11.2014

Test Laboratory: SPEAG, Zurich, Switzerland

DUT: Dipole 2450 MHz; Type: D2450V2; Serial: D2450V2 - SN: 840

Communication System: UID 0 - CW; Frequency: 2450 MHz

Medium parameters used: $f = 2450$ MHz; $\sigma = 2.03$ S/m; $\epsilon_r = 50.9$; $\rho = 1000$ kg/m³

Phantom section: Flat Section

Measurement Standard: DASY5 (IEEE/IEC/ANSI C63.19-2011)

DASY52 Configuration:

- Probe: ES3DV3 - SN3205; ConvF(4.35, 4.35, 4.35); Calibrated: 30.12.2013;
- Sensor-Surface: 3mm (Mechanical Surface Detection)
- Electronics: DAE4 Sn601; Calibrated: 18.08.2014
- Phantom: Flat Phantom 5.0 (back); Type: QD000P50AA; Serial: 1002
- DASY52 52.8.8(1222); SEMCAD X 14.6.10(7331)

Dipole Calibration for Body Tissue/Pin=250 mW, d=10mm/Zoom Scan (7x7x7)/Cube 0:

Measurement grid: dx=5mm, dy=5mm, dz=5mm

Reference Value = 95.80 V/m; Power Drift = -0.03 dB

Peak SAR (extrapolated) = 27.6 W/kg

SAR(1 g) = 13.1 W/kg; SAR(10 g) = 6 W/kg

Maximum value of SAR (measured) = 17.3 W/kg

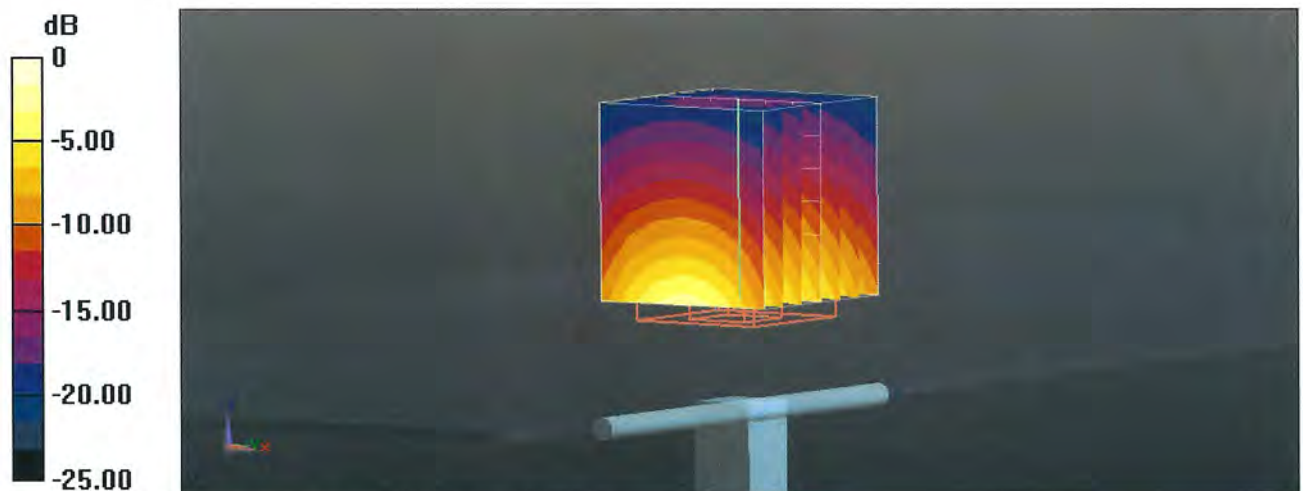

Impedance Measurement Plot for Body TSL

19 Nov 2014 17:05:53

CH1 S11 1 U FS

1: 50.891 $\hat{\omega}$ 4.4375 $\hat{\omega}$ 288.27 μH

2 450.000 000 MHz

*
De1

CΔ

Avg
16

H1d

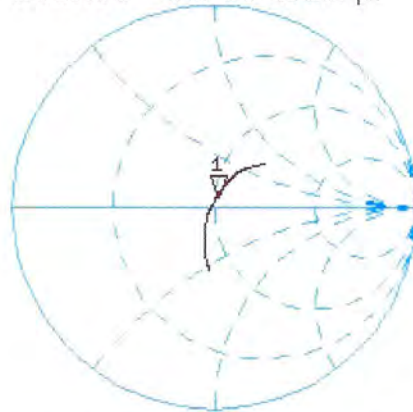

CH2 S11 LOG

5 dB/REF -20 dB

1: -26.967 dB

2 450.000 000 MHz

CΔ

Avg
16

H1d

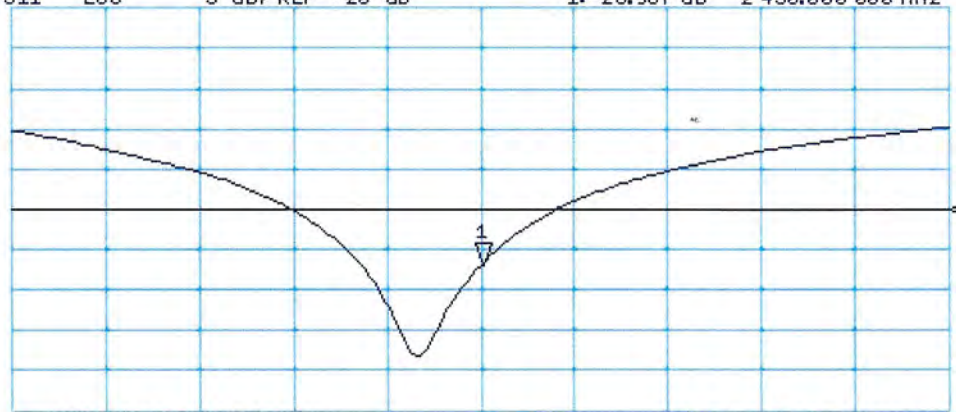

START 2 250.000 000 MHz

STOP 2 650.000 000 MHz



Accredited by the Swiss Accreditation Service (SAS)
The Swiss Accreditation Service is one of the signatories to the EA
Multilateral Agreement for the recognition of calibration certificates

Accreditation No.: **SCS 108**

Client **Sporton-CN (Auden)**

Certificate No: **D2600V2-1061_Nov14**

CALIBRATION CERTIFICATE

Object: **D2600V2 - SN: 1061**

Calibration procedure(s): **QA CAL-05.v9
Calibration procedure for dipole validation kits above 700 MHz**

Calibration date: **November 19, 2014**

This calibration certificate documents the traceability to national standards, which realize the physical units of measurements (SI).
The measurements and the uncertainties with confidence probability are given on the following pages and are part of the certificate.

All calibrations have been conducted in the closed laboratory facility: environment temperature (22 ± 3)°C and humidity < 70%.

Calibration Equipment used (M&TE critical for calibration)

Primary Standards	ID #	Cal Date (Certificate No.)	Scheduled Calibration
Power meter EPM-442A	GB37480704	07-Oct-14 (No. 217-02020)	Oct-15
Power sensor HP 8481A	US37292783	07-Oct-14 (No. 217-02020)	Oct-15
Power sensor HP 8481A	MY41092317	07-Oct-14 (No. 217-02021)	Oct-15
Reference 20 dB Attenuator	SN: 5058 (20k)	03-Apr-14 (No. 217-01918)	Apr-15
Type-N mismatch combination	SN: 5047.2 / 06327	03-Apr-14 (No. 217-01921)	Apr-15
Reference Probe ES3DV3	SN: 3205	30-Dec-13 (No. ES3-3205_Dec13)	Dec-14
DAE4	SN: 601	18-Aug-14 (No. DAE4-601_Aug14)	Aug-15
Secondary Standards	ID #	Check Date (in house)	Scheduled Check
RF generator R&S SMT-06	100005	04-Aug-99 (in house check Oct-13)	In house check: Oct-16
Network Analyzer HP 8753E	US37390585 S4206	18-Oct-01 (in house check Oct-14)	In house check: Oct-15

Calibrated by:	Name Jeton Kastrati	Function Laboratory Technician	Signature
Approved by:	Name Katja Pokovic	Function Technical Manager	Signature

Issued: November 19, 2014

This calibration certificate shall not be reproduced except in full without written approval of the laboratory.



Accredited by the Swiss Accreditation Service (SAS)

The Swiss Accreditation Service is one of the signatories to the EA
Multilateral Agreement for the recognition of calibration certificates

Accreditation No.: **SCS 108**

Glossary:

TSL	tissue simulating liquid
ConvF	sensitivity in TSL / NORM x,y,z
N/A	not applicable or not measured

Calibration is Performed According to the Following Standards:

- IEEE Std 1528-2013, "IEEE Recommended Practice for Determining the Peak Spatial-Averaged Specific Absorption Rate (SAR) in the Human Head from Wireless Communications Devices: Measurement Techniques", June 2013
- IEC 62209-1, "Procedure to measure the Specific Absorption Rate (SAR) for hand-held devices used in close proximity to the ear (frequency range of 300 MHz to 3 GHz)", February 2005
- KDB 865664, "SAR Measurement Requirements for 100 MHz to 6 GHz"

Additional Documentation:

- DASY4/5 System Handbook

Methods Applied and Interpretation of Parameters:

- Measurement Conditions:** Further details are available from the Validation Report at the end of the certificate. All figures stated in the certificate are valid at the frequency indicated.
- Antenna Parameters with TSL:** The dipole is mounted with the spacer to position its feed point exactly below the center marking of the flat phantom section, with the arms oriented parallel to the body axis.
- Feed Point Impedance and Return Loss:** These parameters are measured with the dipole positioned under the liquid filled phantom. The impedance stated is transformed from the measurement at the SMA connector to the feed point. The Return Loss ensures low reflected power. No uncertainty required.
- Electrical Delay:** One-way delay between the SMA connector and the antenna feed point. No uncertainty required.
- SAR measured:** SAR measured at the stated antenna input power.
- SAR normalized:** SAR as measured, normalized to an input power of 1 W at the antenna connector.
- SAR for nominal TSL parameters:** The measured TSL parameters are used to calculate the nominal SAR result.

The reported uncertainty of measurement is stated as the standard uncertainty of measurement multiplied by the coverage factor $k=2$, which for a normal distribution corresponds to a coverage probability of approximately 95%.

Measurement Conditions

DASY system configuration, as far as not given on page 1.

DASY Version	DASY5	V52.8.8
Extrapolation	Advanced Extrapolation	
Phantom	Modular Flat Phantom	
Distance Dipole Center - TSL	10 mm	with Spacer
Zoom Scan Resolution	dx, dy, dz = 5 mm	
Frequency	2600 MHz \pm 1 MHz	

Head TSL parameters

The following parameters and calculations were applied.

	Temperature	Permittivity	Conductivity
Nominal Head TSL parameters	22.0 °C	39.0	1.96 mho/m
Measured Head TSL parameters	(22.0 \pm 0.2) °C	38.4 \pm 6 %	2.03 mho/m \pm 6 %
Head TSL temperature change during test	< 0.5 °C	----	----

SAR result with Head TSL

SAR averaged over 1 cm³ (1 g) of Head TSL	Condition	
SAR measured	250 mW input power	14.5 W/kg
SAR for nominal Head TSL parameters	normalized to 1W	56.9 W/kg \pm 17.0 % (k=2)

SAR averaged over 10 cm³ (10 g) of Head TSL	condition	
SAR measured	250 mW input power	6.49 W/kg
SAR for nominal Head TSL parameters	normalized to 1W	25.7 W/kg \pm 16.5 % (k=2)

Body TSL parameters

The following parameters and calculations were applied.

	Temperature	Permittivity	Conductivity
Nominal Body TSL parameters	22.0 °C	52.5	2.16 mho/m
Measured Body TSL parameters	(22.0 \pm 0.2) °C	50.5 \pm 6 %	2.21 mho/m \pm 6 %
Body TSL temperature change during test	< 0.5 °C	----	----

SAR result with Body TSL

SAR averaged over 1 cm³ (1 g) of Body TSL	Condition	
SAR measured	250 mW input power	14.0 W/kg
SAR for nominal Body TSL parameters	normalized to 1W	54.9 W/kg \pm 17.0 % (k=2)

SAR averaged over 10 cm³ (10 g) of Body TSL	condition	
SAR measured	250 mW input power	6.17 W/kg
SAR for nominal Body TSL parameters	normalized to 1W	24.4 W/kg \pm 16.5 % (k=2)

Appendix (Additional assessments outside the scope of SCS108)

Antenna Parameters with Head TSL

Impedance, transformed to feed point	49.9 Ω - 5.7 $j\Omega$
Return Loss	- 25.0 dB

Antenna Parameters with Body TSL

Impedance, transformed to feed point	46.9 Ω - 5.2 $j\Omega$
Return Loss	- 24.1 dB

General Antenna Parameters and Design

Electrical Delay (one direction)	1.162 ns
----------------------------------	----------

After long term use with 100W radiated power, only a slight warming of the dipole near the feedpoint can be measured.

The dipole is made of standard semirigid coaxial cable. The center conductor of the feeding line is directly connected to the second arm of the dipole. The antenna is therefore short-circuited for DC-signals. On some of the dipoles, small end caps are added to the dipole arms in order to improve matching when loaded according to the position as explained in the "Measurement Conditions" paragraph. The SAR data are not affected by this change. The overall dipole length is still according to the Standard.

No excessive force must be applied to the dipole arms, because they might bend or the soldered connections near the feedpoint may be damaged.

Additional EUT Data

Manufactured by	SPEAG
Manufactured on	August 14, 2012

DASY5 Validation Report for Head TSL

Date: 19.11.2014

Test Laboratory: SPEAG, Zurich, Switzerland

DUT: Dipole 2600 MHz; Type: D2600V2; Serial: D2600V2 - SN: 1061

Communication System: UID 0 - CW; Frequency: 2600 MHz

Medium parameters used: $f = 2600$ MHz; $\sigma = 2.03$ S/m; $\epsilon_r = 38.4$; $\rho = 1000$ kg/m³

Phantom section: Flat Section

Measurement Standard: DASY5 (IEEE/IEC/ANSI C63.19-2011)

DASY52 Configuration:

- Probe: ES3DV3 - SN3205; ConvF(4.46, 4.46, 4.46); Calibrated: 30.12.2013;
- Sensor-Surface: 3mm (Mechanical Surface Detection)
- Electronics: DAE4 Sn601; Calibrated: 18.08.2014
- Phantom: Flat Phantom 5.0 (front); Type: QD000P50AA; Serial: 1001
- DASY52 52.8.8(1222); SEMCAD X 14.6.10(7331)

Dipole Calibration for Head Tissue/Pin=250 mW, d=10mm/Zoom Scan (7x7x7)/Cube 0:

Measurement grid: dx=5mm, dy=5mm, dz=5mm

Reference Value = 101.3 V/m; Power Drift = 0.04 dB

Peak SAR (extrapolated) = 30.5 W/kg

SAR(1 g) = 14.5 W/kg; SAR(10 g) = 6.49 W/kg

Maximum value of SAR (measured) = 19.0 W/kg

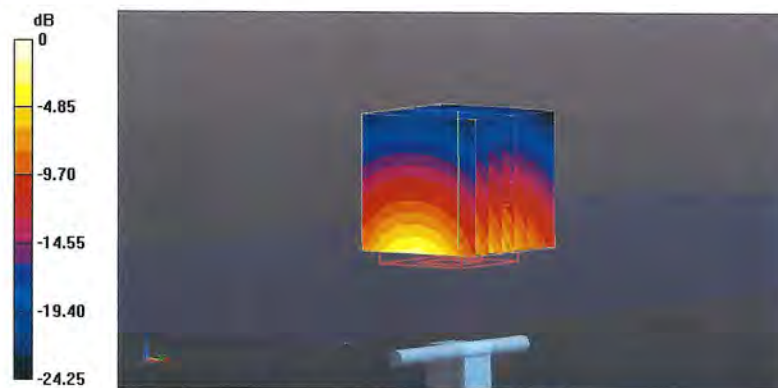

0 dB = 19.0 W/kg = 12.79 dBW/kg

Impedance Measurement Plot for Head TSL

19 Nov 2014 17:09:02
[CH1] S11 1 U FS 2: 49.871 Δ -5.6523 Δ 10.830 pF 2 600.000 000 MHz

*
De1
CA
Avg
16
H1d

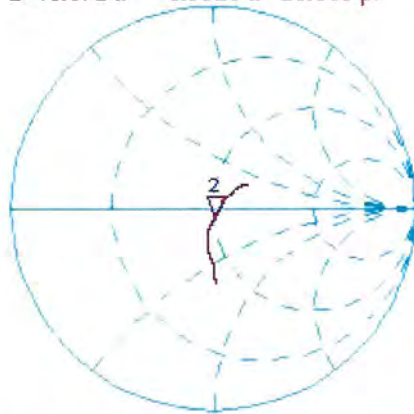

CH2 S11 LOG 5 dB/REF -20 dB 2:-24.952 dB 2 600.000 000 MHz

CA
Avg
16
H1d

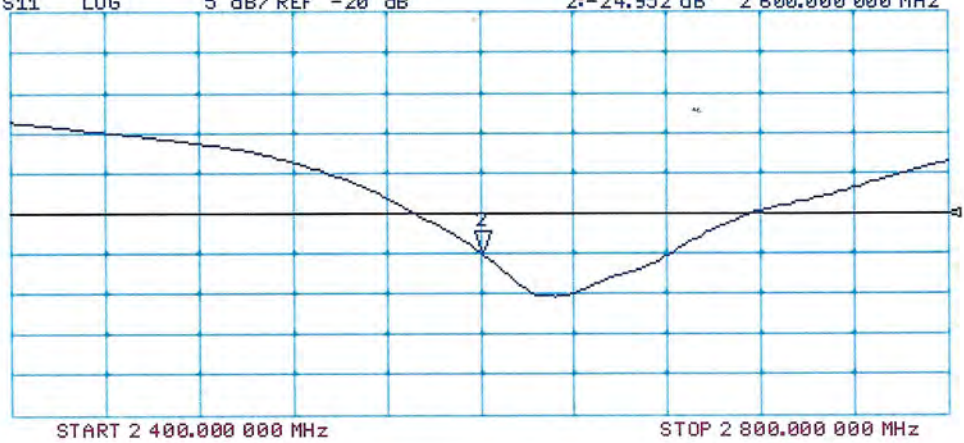

DASY5 Validation Report for Body TSL

Date: 19.11.2014

Test Laboratory: SPEAG, Zurich, Switzerland

DUT: Dipole 2600 MHz; Type: D2600V2; Serial: D2600V2 - SN: 1061

Communication System: UID 0 - CW; Frequency: 2600 MHz

Medium parameters used: $f = 2600$ MHz; $\sigma = 2.21$ S/m; $\epsilon_r = 50.5$; $\rho = 1000$ kg/m³

Phantom section: Flat Section

Measurement Standard: DASY5 (IEEE/IEC/ANSI C63.19-2011)

DASY52 Configuration:

- Probe: ES3DV3 - SN3205; ConvF(4.24, 4.24, 4.24); Calibrated: 30.12.2013;
- Sensor-Surface: 3mm (Mechanical Surface Detection)
- Electronics: DAE4 Sn601; Calibrated: 18.08.2014
- Phantom: Flat Phantom 5.0 (back); Type: QD000P50AA; Serial: 1002
- DASY52 52.8.8(1222); SEMCAD X 14.6.10(7331)

Dipole Calibration for Body Tissue/Pin=250 mW, d=10mm/Zoom Scan (7x7x7)/Cube 0:

Measurement grid: dx=5mm, dy=5mm, dz=5mm

Reference Value = 95.86 V/m; Power Drift = 0.03 dB

Peak SAR (extrapolated) = 30.4 W/kg

SAR(1 g) = 14 W/kg; SAR(10 g) = 6.17 W/kg

Maximum value of SAR (measured) = 18.8 W/kg

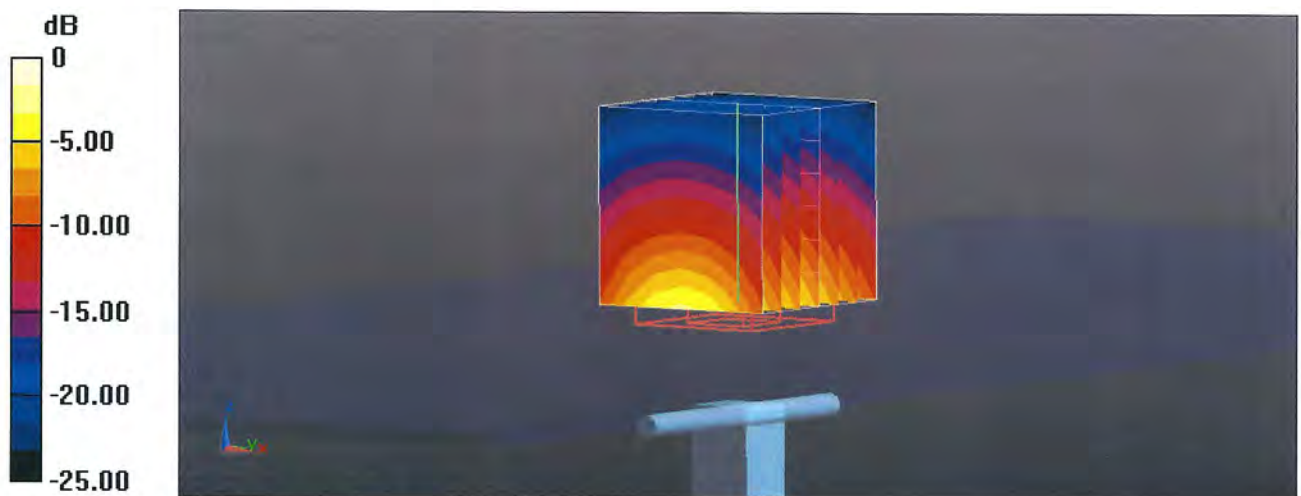

0 dB = 18.8 W/kg = 12.74 dBW/kg

Impedance Measurement Plot for Body TSL

19 Nov 2014 17:08:29
[CH1] S11 1 U FS 2: 46.893 Ω -5.2090 Ω 11.752 pF 2 600.000 000 MHz

*
De1
C Δ
Avg
16
H1d

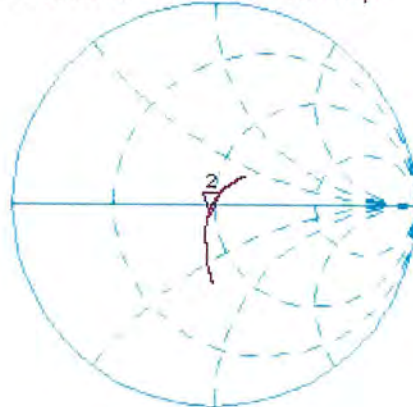

CH2 S11 LOG 5 dB/REF -20 dB 2:-24.085 dB 2 600.000 000 MHz



IMPORTANT NOTICE

USAGE OF THE DAE 4

The DAE unit is a delicate, high precision instrument and requires careful treatment by the user. There are no serviceable parts inside the DAE. Special attention shall be given to the following points:

Battery Exchange: The battery cover of the DAE4 unit is closed using a screw, over tightening the screw may cause the threads inside the DAE to wear out.

Shipping of the DAE: Before shipping the DAE to SPEAG for calibration, remove the batteries and pack the DAE in an antistatic bag. This antistatic bag shall then be packed into a larger box or container which protects the DAE from impacts during transportation. The package shall be marked to indicate that a fragile instrument is inside.

E-Stop Failures: Touch detection may be malfunctioning due to broken magnets in the E-stop. Rough handling of the E-stop may lead to damage of these magnets. Touch and collision errors are often caused by dust and dirt accumulated in the E-stop. To prevent E-stop failure, the customer shall always mount the probe to the DAE carefully and keep the DAE unit in a non-dusty environment if not used for measurements.

Repair: Minor repairs are performed at no extra cost during the annual calibration. However, SPEAG reserves the right to charge for any repair especially if rough unprofessional handling caused the defect.

DASY Configuration Files: Since the exact values of the DAE input resistances, as measured during the calibration procedure of a DAE unit, are not used by the DASY software, a nominal value of 200 MOhm is given in the corresponding configuration file.

Important Note:

Warranty and calibration is void if the DAE unit is disassembled partly or fully by the Customer.

Important Note:

Never attempt to grease or oil the E-stop assembly. Cleaning and readjusting of the E-stop assembly is allowed by certified SPEAG personnel only and is part of the annual calibration procedure.

Important Note:

To prevent damage of the DAE probe connector pins, use great care when installing the probe to the DAE. Carefully connect the probe with the connector notch oriented in the mating position. Avoid any rotational movement of the probe body versus the DAE while turning the locking nut of the connector. The same care shall be used when disconnecting the probe from the DAE.



Accredited by the Swiss Accreditation Service (SAS)
The Swiss Accreditation Service is one of the signatories to the EA
Multilateral Agreement for the recognition of calibration certificates

Accreditation No.: **SCS 108**

Client **Sporton-SZ (Auden)**

Certificate No: **DAE4-1303_Dec14**

CALIBRATION CERTIFICATE

Object **DAE4 - SD 000 D04 BM - SN: 1303**

Calibration procedure(s) **QA CAL-06.v28
Calibration procedure for the data acquisition electronics (DAE)**

Calibration date: **December 11, 2014**

This calibration certificate documents the traceability to national standards, which realize the physical units of measurements (SI).
The measurements and the uncertainties with confidence probability are given on the following pages and are part of the certificate.

All calibrations have been conducted in the closed laboratory facility: environment temperature (22 ± 3)°C and humidity < 70%.

Calibration Equipment used (M&TE critical for calibration)

Primary Standards	ID #	Cal Date (Certificate No.)	Scheduled Calibration
Keithley Multimeter Type 2001	SN: 0810278	03-Oct-14 (No:15573)	Oct-15
Secondary Standards	ID #	Check Date (in house)	Scheduled Check
Auto DAE Calibration Unit	SE UWS 053 AA 1001	07-Jan-14 (in house check)	In house check: Jan-15
Calibrator Box V2.1	SE UMS 006 AA 1002	07-Jan-14 (in house check)	In house check: Jan-15

	Name	Function	Signature
Calibrated by:	Dominique Steffen	Technician	
Approved by:	Fin Bornholt	Deputy Technical Manager	

Issued: December 11, 2014

This calibration certificate shall not be reproduced except in full without written approval of the laboratory.



Accredited by the Swiss Accreditation Service (SAS)
The Swiss Accreditation Service is one of the signatories to the EA
Multilateral Agreement for the recognition of calibration certificates

Accreditation No.: **SCS 108**

Glossary

DAE data acquisition electronics
Connector angle information used in DASY system to align probe sensor X to the robot coordinate system.

Methods Applied and Interpretation of Parameters

- *DC Voltage Measurement*: Calibration Factor assessed for use in DASY system by comparison with a calibrated instrument traceable to national standards. The figure given corresponds to the full scale range of the voltmeter in the respective range.
- *Connector angle*: The angle of the connector is assessed measuring the angle mechanically by a tool inserted. Uncertainty is not required.
- The following parameters as documented in the Appendix contain technical information as a result from the performance test and require no uncertainty.
 - *DC Voltage Measurement Linearity*: Verification of the Linearity at +10% and -10% of the nominal calibration voltage. Influence of offset voltage is included in this measurement.
 - *Common mode sensitivity*: Influence of a positive or negative common mode voltage on the differential measurement.
 - *Channel separation*: Influence of a voltage on the neighbor channels not subject to an input voltage.
 - *AD Converter Values with inputs shorted*: Values on the internal AD converter corresponding to zero input voltage
 - *Input Offset Measurement*: Output voltage and statistical results over a large number of zero voltage measurements.
 - *Input Offset Current*: Typical value for information; Maximum channel input offset current, not considering the input resistance.
 - *Input resistance*: Typical value for information: DAE input resistance at the connector, during internal auto-zeroing and during measurement.
 - *Low Battery Alarm Voltage*: Typical value for information. Below this voltage, a battery alarm signal is generated.
 - *Power consumption*: Typical value for information. Supply currents in various operating modes.

DC Voltage Measurement

A/D - Converter Resolution nominal

High Range: 1LSB = 6.1 μ V, full range = -100...+300 mV

Low Range: 1LSB = 61nV, full range = -1.....+3mV

DASY measurement parameters: Auto Zero Time: 3 sec; Measuring time: 3 sec

Calibration Factors	X	Y	Z
High Range	405.582 \pm 0.02% (k=2)	403.473 \pm 0.02% (k=2)	404.923 \pm 0.02% (k=2)
Low Range	3.96551 \pm 1.50% (k=2)	3.99166 \pm 1.50% (k=2)	3.98776 \pm 1.50% (k=2)

Connector Angle

Connector Angle to be used in DASY system	186.0 $^{\circ}$ \pm 1 $^{\circ}$
---	-------------------------------------

Appendix (Additional assessments outside the scope of SCS108)

1. DC Voltage Linearity

High Range	Reading (μV)	Difference (μV)	Error (%)
Channel X + Input	200032.42	0.17	0.00
Channel X + Input	20006.44	2.48	0.01
Channel X - Input	-20003.75	1.42	-0.01
Channel Y + Input	200033.90	1.88	0.00
Channel Y + Input	20003.42	-0.41	-0.00
Channel Y - Input	-20004.48	0.84	-0.00
Channel Z + Input	200035.95	4.02	0.00
Channel Z + Input	20001.57	-2.14	-0.01
Channel Z - Input	-20006.48	-1.03	0.01

Low Range	Reading (μV)	Difference (μV)	Error (%)
Channel X + Input	2000.63	0.09	0.00
Channel X + Input	201.55	0.94	0.47
Channel X - Input	-199.12	0.32	-0.16
Channel Y + Input	2000.86	0.46	0.02
Channel Y + Input	200.23	-0.19	-0.10
Channel Y - Input	-199.83	-0.23	0.11
Channel Z + Input	1999.80	-0.49	-0.02
Channel Z + Input	199.09	-1.38	-0.69
Channel Z - Input	-200.32	-0.71	0.35

2. Common mode sensitivity

DASY measurement parameters: Auto Zero Time: 3 sec; Measuring time: 3 sec

	Common mode Input Voltage (mV)	High Range Average Reading (μV)	Low Range Average Reading (μV)
Channel X	200	8.67	7.40
	- 200	-5.53	-7.23
Channel Y	200	6.03	5.93
	- 200	-7.02	-6.90
Channel Z	200	-4.66	-4.55
	- 200	1.56	1.76

3. Channel separation

DASY measurement parameters: Auto Zero Time: 3 sec; Measuring time: 3 sec

	Input Voltage (mV)	Channel X (μV)	Channel Y (μV)	Channel Z (μV)
Channel X	200	-	1.77	-4.82
Channel Y	200	8.18	-	1.73
Channel Z	200	9.79	5.56	-

4. AD-Converter Values with inputs shorted

DASY measurement parameters: Auto Zero Time: 3 sec; Measuring time: 3 sec

	High Range (LSB)	Low Range (LSB)
Channel X	15917	16559
Channel Y	15625	16454
Channel Z	16119	13095

5. Input Offset Measurement

DASY measurement parameters: Auto Zero Time: 3 sec; Measuring time: 3 sec

Input 10M Ω

	Average (μ V)	min. Offset (μ V)	max. Offset (μ V)	Std. Deviation (μ V)
Channel X	-0.80	-1.98	0.43	0.53
Channel Y	-0.05	-2.62	1.86	0.61
Channel Z	-0.54	-2.21	1.34	0.55

6. Input Offset Current

Nominal Input circuitry offset current on all channels: <25 fA

7. Input Resistance (Typical values for information)

	Zeroing (kOhm)	Measuring (MOhm)
Channel X	200	200
Channel Y	200	200
Channel Z	200	200

8. Low Battery Alarm Voltage (Typical values for information)

Typical values	Alarm Level (VDC)
Supply (+ Vcc)	+7.9
Supply (- Vcc)	-7.6

9. Power Consumption (Typical values for information)

Typical values	Switched off (mA)	Stand by (mA)	Transmitting (mA)
Supply (+ Vcc)	+0.01	+6	+14
Supply (- Vcc)	-0.01	-8	-9



Accredited by the Swiss Accreditation Service (SAS)
The Swiss Accreditation Service is one of the signatories to the EA
Multilateral Agreement for the recognition of calibration certificates

Accreditation No.: **SCS 108**

Client **Sporton-SZ (Auden)**

Certificate No: **EX3-3819_Nov14**

CALIBRATION CERTIFICATE

Object **EX3DV4 - SN:3819**

Calibration procedure(s) **QA CAL-01.v9, QA CAL-14.v4, QA CAL-23.v5, QA CAL-25.v6
Calibration procedure for dosimetric E-field probes**

Calibration date: **November 13, 2014**

This calibration certificate documents the traceability to national standards, which realize the physical units of measurements (SI).
The measurements and the uncertainties with confidence probability are given on the following pages and are part of the certificate.

All calibrations have been conducted in the closed laboratory facility: environment temperature $(22 \pm 3)^\circ\text{C}$ and humidity $< 70\%$.

Calibration Equipment used (M&TE critical for calibration)

Primary Standards	ID	Cal Date (Certificate No.)	Scheduled Calibration
Power meter E4419B	GB41293874	03-Apr-14 (No. 217-01911)	Apr-15
Power sensor E4412A	MY41498087	03-Apr-14 (No. 217-01911)	Apr-15
Reference 3 dB Attenuator	SN: S5054 (3c)	03-Apr-14 (No. 217-01915)	Apr-15
Reference 20 dB Attenuator	SN: S5277 (20x)	03-Apr-14 (No. 217-01919)	Apr-15
Reference 30 dB Attenuator	SN: S5129 (30b)	03-Apr-14 (No. 217-01920)	Apr-15
Reference Probe ES3DV2	SN: 3013	30-Dec-13 (No. ES3-3013_Dec13)	Dec-14
DAE4	SN: 660	13-Dec-13 (No. DAE4-660_Dec13)	Dec-14
Secondary Standards	ID	Check Date (in house)	Scheduled Check
RF generator HP 8648C	US3642U01700	4-Aug-99 (in house check Apr-13)	In house check: Apr-16
Network Analyzer HP 8753E	US37390585	18-Oct-01 (in house check Oct-14)	In house check: Oct-15

Calibrated by:	Name Claudio Leubler	Function Laboratory Technician	Signature
Approved by:	Name Katja Pokovic	Function Technical Manager	Signature

Issued: November 14, 2014

This calibration certificate shall not be reproduced except in full without written approval of the laboratory.



Accredited by the Swiss Accreditation Service (SAS)

Accreditation No.: **SCS 108**

The Swiss Accreditation Service is one of the signatories to the EA
Multilateral Agreement for the recognition of calibration certificates

Glossary:

TSL	tissue simulating liquid
NORM _{x,y,z}	sensitivity in free space
ConvF	sensitivity in TSL / NORM _{x,y,z}
DCP	diode compression point
CF	crest factor (1/duty_cycle) of the RF signal
A, B, C, D	modulation dependent linearization parameters
Polarization φ	φ rotation around probe axis
Polarization ϑ	ϑ rotation around an axis that is in the plane normal to probe axis (at measurement center), i.e., $\vartheta = 0$ is normal to probe axis
Connector Angle	information used in DASY system to align probe sensor X to the robot coordinate system

Calibration is Performed According to the Following Standards:

- IEEE Std 1528-2013, "IEEE Recommended Practice for Determining the Peak Spatial-Averaged Specific Absorption Rate (SAR) in the Human Head from Wireless Communications Devices: Measurement Techniques", June 2013
- IEC 62209-1, "Procedure to measure the Specific Absorption Rate (SAR) for hand-held devices used in close proximity to the ear (frequency range of 300 MHz to 3 GHz)", February 2005

Methods Applied and Interpretation of Parameters:

- NORM_{x,y,z}**: Assessed for E-field polarization $\vartheta = 0$ ($f \leq 900$ MHz in TEM-cell; $f > 1800$ MHz: R22 waveguide). NORM_{x,y,z} are only intermediate values, i.e., the uncertainties of NORM_{x,y,z} does not affect the E^2 -field uncertainty inside TSL (see below ConvF).
- NORM(f)_{x,y,z}** = NORM_{x,y,z} * frequency_response (see Frequency Response Chart). This linearization is implemented in DASY4 software versions later than 4.2. The uncertainty of the frequency response is included in the stated uncertainty of ConvF.
- DCP_{x,y,z}**: DCP are numerical linearization parameters assessed based on the data of power sweep with CW signal (no uncertainty required). DCP does not depend on frequency nor media.
- PAR**: PAR is the Peak to Average Ratio that is not calibrated but determined based on the signal characteristics
- A_{x,y,z}; B_{x,y,z}; C_{x,y,z}; D_{x,y,z}; VR_{x,y,z}**: A, B, C, D are numerical linearization parameters assessed based on the data of power sweep for specific modulation signal. The parameters do not depend on frequency nor media. VR is the maximum calibration range expressed in RMS voltage across the diode.
- ConvF and Boundary Effect Parameters**: Assessed in flat phantom using E-field (or Temperature Transfer Standard for $f \leq 800$ MHz) and inside waveguide using analytical field distributions based on power measurements for $f > 800$ MHz. The same setups are used for assessment of the parameters applied for boundary compensation (alpha, depth) of which typical uncertainty values are given. These parameters are used in DASY4 software to improve probe accuracy close to the boundary. The sensitivity in TSL corresponds to NORM_{x,y,z} * ConvF whereby the uncertainty corresponds to that given for ConvF. A frequency dependent ConvF is used in DASY version 4.4 and higher which allows extending the validity from ± 50 MHz to ± 100 MHz.
- Spherical isotropy (3D deviation from isotropy)**: in a field of low gradients realized using a flat phantom exposed by a patch antenna.
- Sensor Offset**: The sensor offset corresponds to the offset of virtual measurement center from the probe tip (on probe axis). No tolerance required.
- Connector Angle**: The angle is assessed using the information gained by determining the NORM_x (no uncertainty required).

Probe EX3DV4

SN:3819

Manufactured:	September 2, 2011
Repaired:	November 4, 2014
Calibrated:	November 13, 2014

Calibrated for DASY/EASY Systems
(Note: non-compatible with DASY2 system!)

DASY/EASY - Parameters of Probe: EX3DV4 - SN:3819

Basic Calibration Parameters

	Sensor X	Sensor Y	Sensor Z	Unc (k=2)
Norm ($\mu\text{V}/(\text{V}/\text{m})^2$) ^A	0.47	0.41	0.47	$\pm 10.1 \%$
DCP (mV) ^B	100.5	101.6	100.9	

Modulation Calibration Parameters

UID	Communication System Name		A dB	B dB $\sqrt{\mu\text{V}}$	C	D dB	VR mV	Unc ^E (k=2)
0	CW	X	0.0	0.0	1.0	0.00	154.0	$\pm 3.8 \%$
		Y	0.0	0.0	1.0		146.8	
		Z	0.0	0.0	1.0		155.0	

The reported uncertainty of measurement is stated as the standard uncertainty of measurement multiplied by the coverage factor k=2, which for a normal distribution corresponds to a coverage probability of approximately 95%.

^A The uncertainties of Norm X,Y,Z do not affect the E²-field uncertainty inside TSL (see Pages 5 and 6)

^B Numerical linearization parameter; uncertainty not required.

^E Uncertainty is determined using the max. deviation from linear response applying rectangular distribution and is expressed for the square of the field value.

DASY/EASY - Parameters of Probe: EX3DV4 - SN:3819

Calibration Parameter Determined in Head Tissue Simulating Media

f (MHz) ^C	Relative Permittivity ^F	Conductivity (S/m) ^F	ConvF X	ConvF Y	ConvF Z	Alpha ^G	Depth ^G (mm)	Unct. (k=2)
750	41.9	0.89	9.94	9.94	9.94	0.28	1.20	± 12.0 %
835	41.5	0.90	9.48	9.48	9.48	0.58	0.80	± 12.0 %
900	41.5	0.97	9.24	9.24	9.24	0.39	0.95	± 12.0 %
1750	40.1	1.37	8.01	8.01	8.01	0.80	0.58	± 12.0 %
1900	40.0	1.40	7.66	7.66	7.66	0.33	0.91	± 12.0 %
2000	40.0	1.40	7.73	7.73	7.73	0.39	0.81	± 12.0 %
2300	39.5	1.67	7.30	7.30	7.30	0.35	0.85	± 12.0 %
2450	39.2	1.80	7.01	7.01	7.01	0.49	0.73	± 12.0 %
2600	39.0	1.96	6.92	6.92	6.92	0.50	0.74	± 12.0 %
5200	36.0	4.66	5.25	5.25	5.25	0.30	1.80	± 13.1 %
5300	35.9	4.76	5.01	5.01	5.01	0.30	1.80	± 13.1 %
5600	35.5	5.07	4.52	4.52	4.52	0.40	1.80	± 13.1 %
5800	35.3	5.27	4.50	4.50	4.50	0.40	1.80	± 13.1 %

^C Frequency validity above 300 MHz of ± 100 MHz only applies for DASY v4.4 and higher (see Page 2), else it is restricted to ± 50 MHz. The uncertainty is the RSS of the ConvF uncertainty at calibration frequency and the uncertainty for the indicated frequency band. Frequency validity below 300 MHz is ± 10, 25, 40, 50 and 70 MHz for ConvF assessments at 30, 64, 128, 150 and 220 MHz respectively. Above 5 GHz frequency validity can be extended to ± 110 MHz.

^F At frequencies below 3 GHz, the validity of tissue parameters (ϵ and σ) can be relaxed to ± 10% if liquid compensation formula is applied to measured SAR values. At frequencies above 3 GHz, the validity of tissue parameters (ϵ and σ) is restricted to ± 5%. The uncertainty is the RSS of the ConvF uncertainty for indicated target tissue parameters.

^G Alpha/Depth are determined during calibration. SPEAG warrants that the remaining deviation due to the boundary effect after compensation is always less than ± 1% for frequencies below 3 GHz and below ± 2% for frequencies between 3-6 GHz at any distance larger than half the probe tip diameter from the boundary.

DASY/EASY - Parameters of Probe: EX3DV4 - SN:3819

Calibration Parameter Determined in Body Tissue Simulating Media

f (MHz) ^C	Relative Permittivity ^F	Conductivity (S/m) ^F	ConvF X	ConvF Y	ConvF Z	Alpha ^G	Depth ^G (mm)	Unct. (k=2)
750	55.5	0.96	9.55	9.55	9.55	0.26	1.23	± 12.0 %
835	55.2	0.97	9.49	9.49	9.49	0.52	0.78	± 12.0 %
900	55.0	1.05	9.24	9.24	9.24	0.70	0.68	± 12.0 %
1750	53.4	1.49	7.74	7.74	7.74	0.78	0.63	± 12.0 %
1900	53.3	1.52	7.39	7.39	7.39	0.45	0.80	± 12.0 %
2000	53.3	1.52	7.46	7.46	7.46	0.39	0.93	± 12.0 %
2300	52.9	1.81	7.21	7.21	7.21	0.67	0.69	± 12.0 %
2450	52.7	1.95	6.95	6.95	6.95	0.80	0.60	± 12.0 %
2600	52.5	2.16	6.80	6.80	6.80	0.80	0.57	± 12.0 %
5200	49.0	5.30	4.52	4.52	4.52	0.40	1.90	± 13.1 %
5300	48.9	5.42	4.37	4.37	4.37	0.40	1.90	± 13.1 %
5600	48.5	5.77	3.86	3.86	3.86	0.45	1.90	± 13.1 %
5800	48.2	6.00	4.07	4.07	4.07	0.50	1.90	± 13.1 %

^C Frequency validity above 300 MHz of ± 100 MHz only applies for DASY v4.4 and higher (see Page 2), else it is restricted to ± 50 MHz. The uncertainty is the RSS of the ConvF uncertainty at calibration frequency and the uncertainty for the indicated frequency band. Frequency validity below 300 MHz is ± 10, 25, 40, 50 and 70 MHz for ConvF assessments at 30, 64, 128, 150 and 220 MHz respectively. Above 5 GHz frequency validity can be extended to ± 110 MHz.

^F At frequencies below 3 GHz, the validity of tissue parameters (ϵ and σ) can be relaxed to ± 10% if liquid compensation formula is applied to measured SAR values. At frequencies above 3 GHz, the validity of tissue parameters (ϵ and σ) is restricted to ± 5%. The uncertainty is the RSS of the ConvF uncertainty for indicated target tissue parameters.

^G Alpha/Depth are determined during calibration. SPEAG warrants that the remaining deviation due to the boundary effect after compensation is always less than ± 1% for frequencies below 3 GHz and below ± 2% for frequencies between 3-6 GHz at any distance larger than half the probe tip diameter from the boundary.

Frequency Response of E-Field (TEM-Cell:ifi110 EXX, Waveguide: R22)

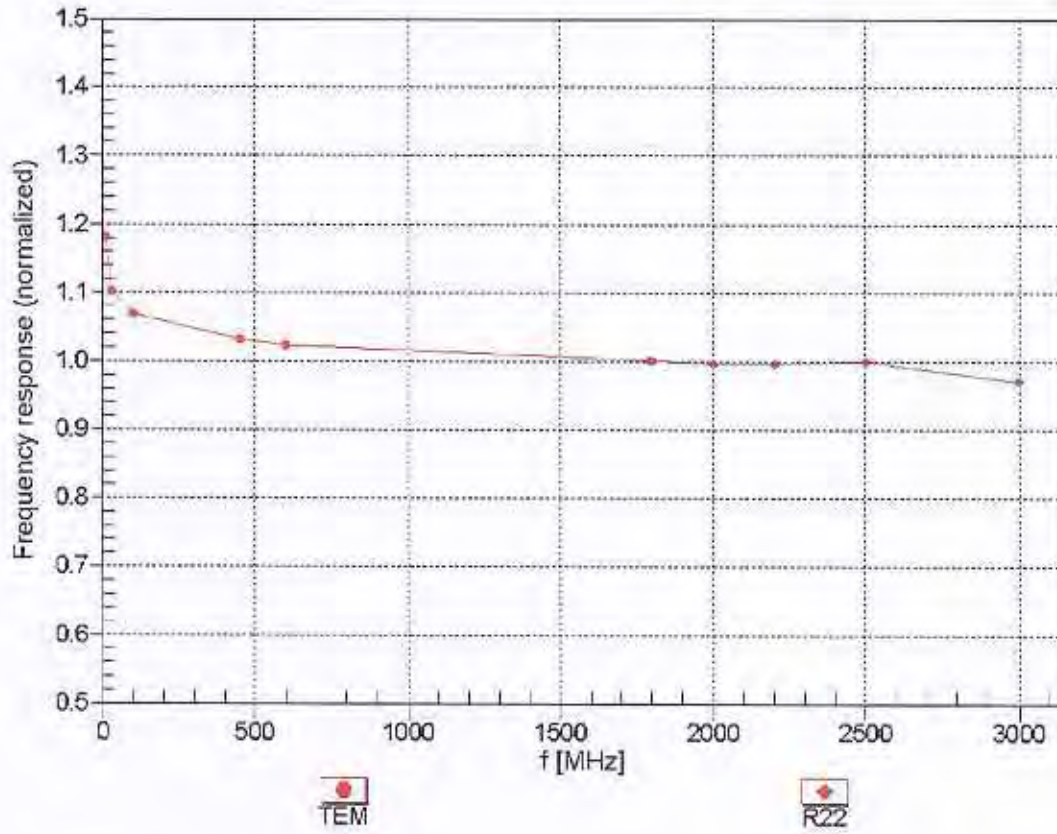

Uncertainty of Frequency Response of E-field: $\pm 6.3\%$ ($k=2$)

Receiving Pattern (ϕ), $\vartheta = 0^\circ$

f=600 MHz, TEM

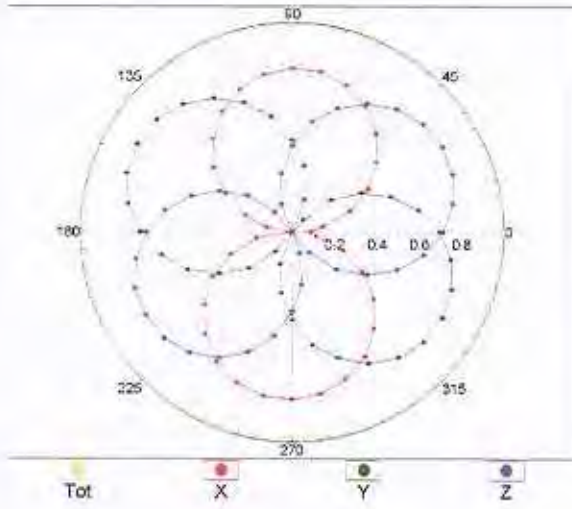

f=1800 MHz, R22

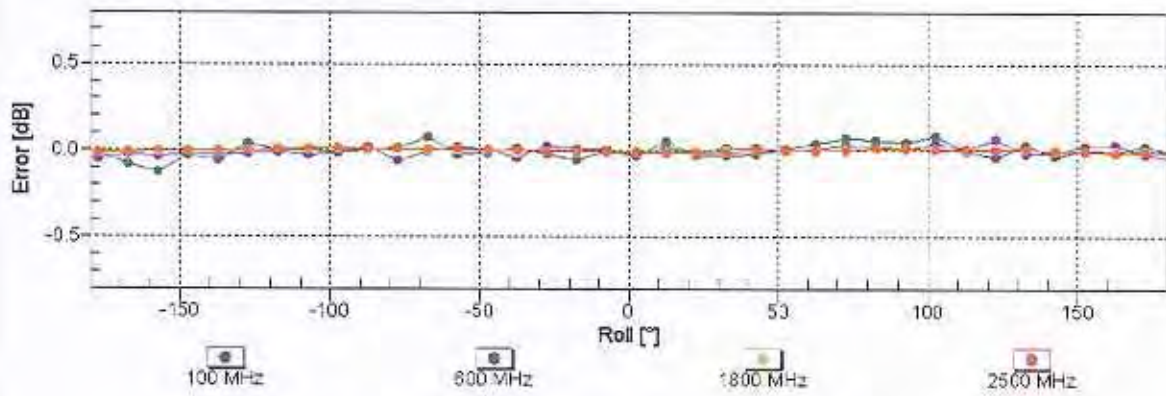
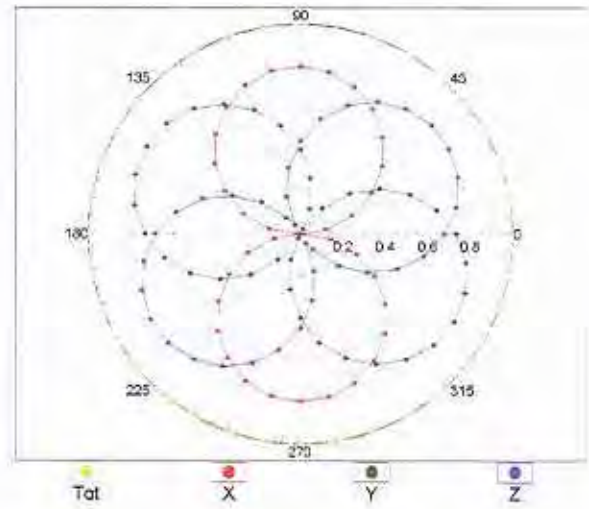

Uncertainty of Axial Isotropy Assessment: $\pm 0.5\%$ (k=2)

Dynamic Range $f(SAR_{head})$ (TEM cell, $f_{eval} = 1900$ MHz)

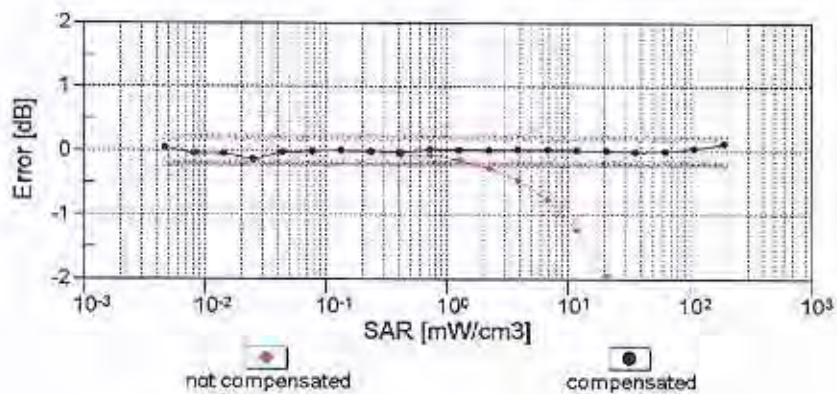
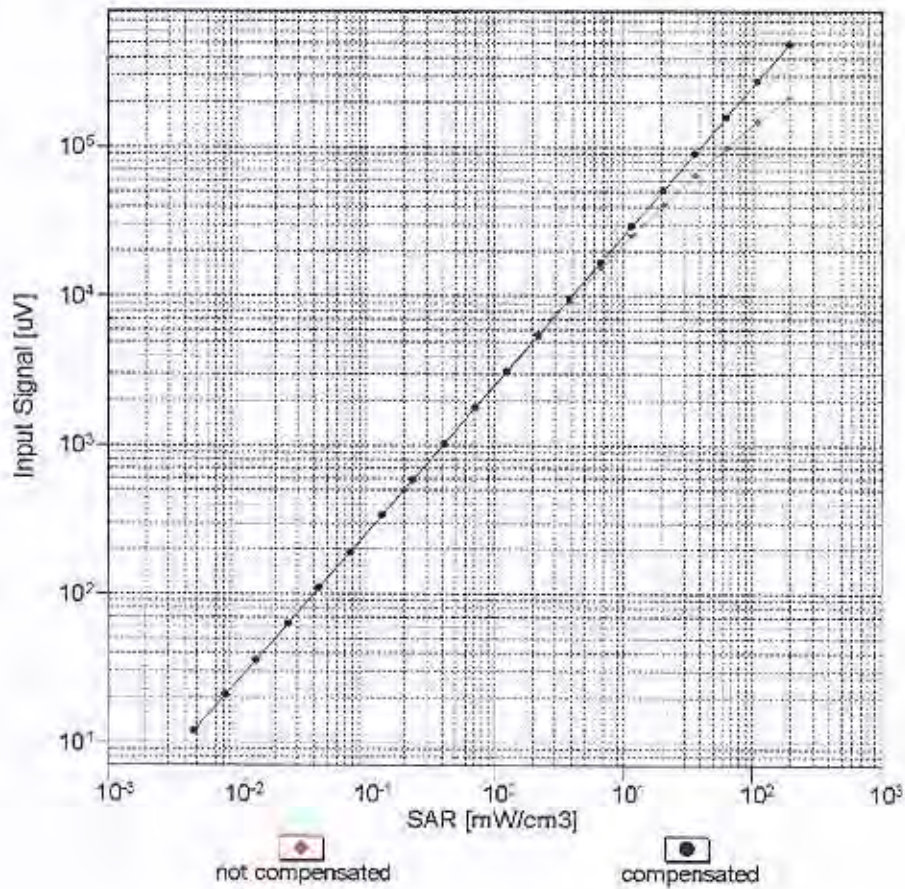

Uncertainty of Linearity Assessment: $\pm 0.6\%$ ($k=2$)

Conversion Factor Assessment

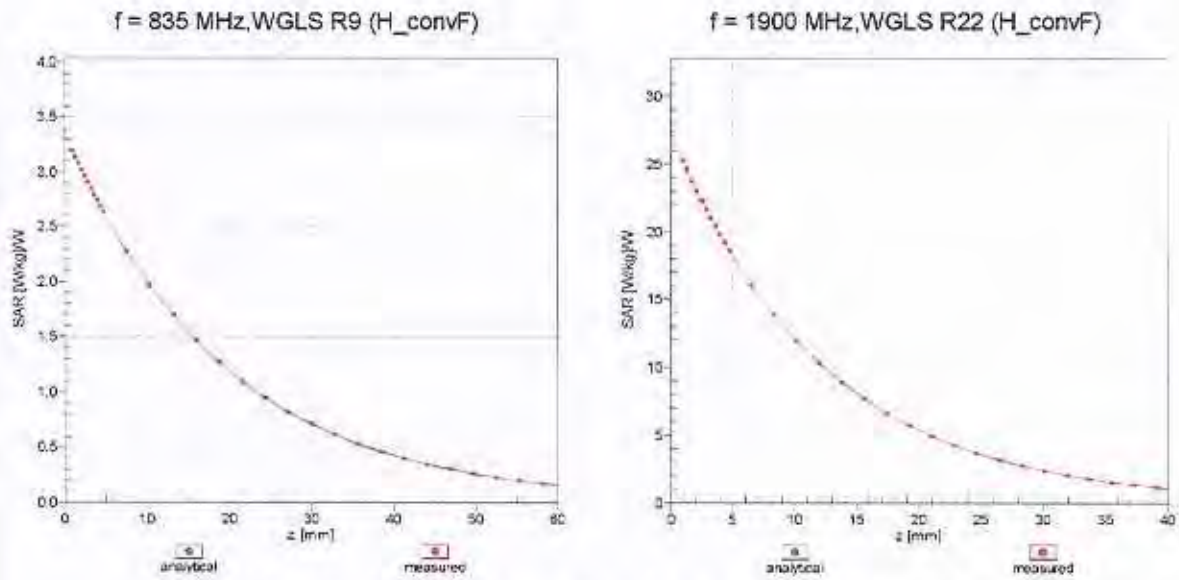

Deviation from Isotropy in Liquid Error (ϕ, θ), f = 900 MHz

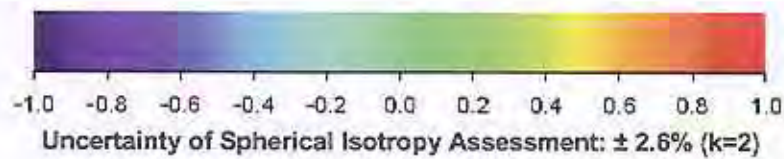
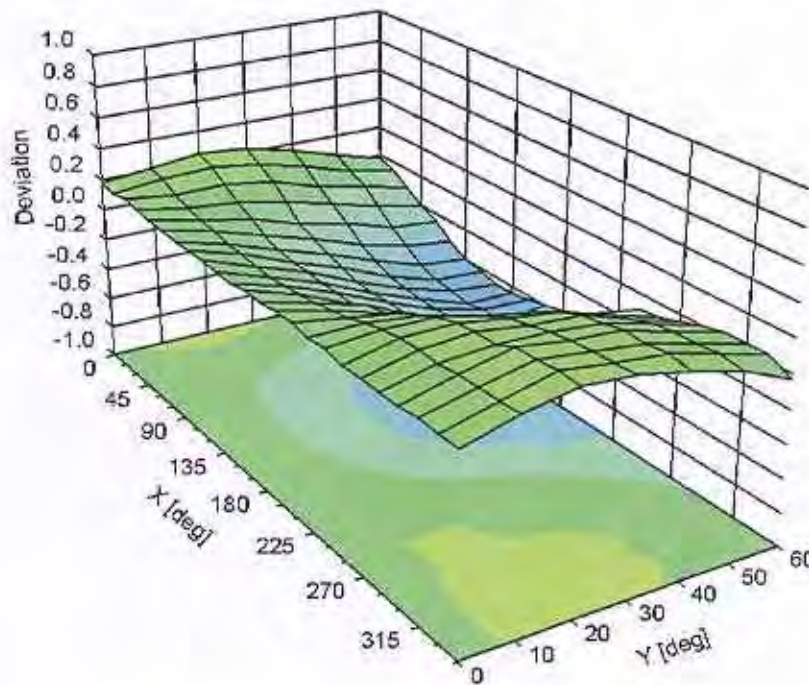

DASY/EASY - Parameters of Probe: EX3DV4 - SN:3819

Other Probe Parameters

Sensor Arrangement	Triangular
Connector Angle (°)	-67.4
Mechanical Surface Detection Mode	enabled
Optical Surface Detection Mode	disabled
Probe Overall Length	337 mm
Probe Body Diameter	10 mm
Tip Length	9 mm
Tip Diameter	2.5 mm
Probe Tip to Sensor X Calibration Point	1 mm
Probe Tip to Sensor Y Calibration Point	1 mm
Probe Tip to Sensor Z Calibration Point	1 mm
Recommended Measurement Distance from Surface	1.4 mm