

FCC SAR Test Report

Product Name : VOS 5G Dongle

Model No. : VOS5-GC-1

Applicant : Tri Cascade Inc

Address : 19200 Von Karman Ave, Ste 400, Irvine, CA 92612

Date of Receipt : 2022/09/16

Issued Date : 2022/12/16

Report No. : 2290522R-SAUSSARV02-A

Report Version : V1.0



The test results relate only to the samples tested.

The test results shown in the test report are traceable to the national/international standard through the calibration report of the equipment and evaluated measurement uncertainty herein.

This report must not be used to claim product endorsement by TAF or any agency of the government.

The test report shall not be reproduced without the written approval of DEKRA Testing and Certification Co., Ltd.

Measurement uncertainties evaluated for each testing system and associated connections are given here to provide the system information for reference. Compliance determinations do not take into account measurement uncertainties for each testing system, but are based on the results of the compliance measurement.

Test Report

Issued Date: 2022/12/16

Report No.: 2290522R-SAUSSARV02-A



Product Name : VOS 5G Dongle
 Applicant : Tri Cascade Inc
 Address : 19200 Von Karman Ave, Ste 400, Irvine, CA 92612
 Manufacturer : Tri Cascade Inc
 Model No. : VOS5-GC-1
 Trade Name : VOS
 FCC ID : 2ACARSG500M2
 Applicable Standard : IEEE 1528-2013
 KDB 447498 D01 v06
 KDB 865664 D01 v01r04
 Measurement : 47CFR § 2.1093
 Procedures : KDB 447498 D02 v02r01
 KDB 941225 D01 v03r01
 KDB 941225 D05 v02r05
 KDB 941225 D05A v01r02
 Test Result : Max. SAR Measurement (1g)
 WWAN: **1.107** W/kg
 Application Type : Certification

The above equipment has been tested by DEKRA, and found compliance with the requirement of the above standards. The test record, data evaluation & Equipment Under Test (EUT) configurations represented herein are true and accurate accounts of the measurements of the sample's SAR characteristics under the conditions specified in this report.

Documented By : Jinn Chen
 (Supervisor / Jinn Chen)

Tested By : Luke Cheng
 (Senior Engineer / Luke Cheng)

Approved By : San Lin
 (Supervisor / San Lin)

TABLE OF CONTENTS

Description	Page
1. General Information	5
1.1 EUT Description	5
1.2 Antenna List	6
1.3 Test Environment.....	7
2. SAR Measurement System	8
2.1 DASY5 System Description	8
2.1.1 Applications	9
2.1.2 Area Scans.....	9
2.1.3 Zoom Scan (Cube Scan Averaging)	9
2.1.4 Uncertainty of Inter-/Extrapolation and Averaging	9
2.2 DASY5 E-Field Probe.....	10
2.2.1 Isotropic E-Field Probe Specification.....	10
2.3 Boundary Detection Unit and Probe Mounting Device	11
2.4 DATA Acquisition Electronics (DAE) and Measurement Server	11
2.5 Robot.....	12
2.6 Light Beam Unit.....	12
2.7 Device Holder	13
2.8 SAM Twin Phantom.....	13
3. Tissue Simulating Liquid	14
3.1 The composition of the tissue simulating liquid	14
3.2 Tissue Calibration Result.....	14
3.3 Tissue Dielectric Parameters for Head and Body Phantoms	18
4. SAR Measurement Procedure	19
4.1 SAR System Check.....	19
4.1.1 Dipoles	19
4.1.2 System Check Result	20
4.2 SAR Measurement Procedure.....	22
5. SAR Exposure Limits	23
6. Test Equipment List	24
7. Measurement Uncertainty	25
8. Conducted Power Measurement (Including tolerance allowed for production unit)	27
9. Test Results	86
9.1 SAR Test Results Summary	86
10. SAR measurement variability	106
Appendix	
Appendix A. SAR System Check Data	
Appendix B. SAR measurement Data	
Appendix C. Test Setup Photographs	
Appendix D. Probe Calibration Data	
Appendix E. Dipole Calibration Data	
Appendix F. Product Photos-Please refer to the file: 2290522R-Product Photos	

Revision History

Report No.	Version	Description	Issued Date
2290522R-SAUSSARV02-A	V1.0	Initial issue of report.	2022/12/16

1. General Information

1.1 EUT Description

Product Name	VOS 5G Dongle
Trade Name	VOS
Model No.	VOS5-GC-1
FCC ID	2ACARSG500M2
Frequency Range (Licensed)	WCDMA Band 2/LTE Band 2/NR n2: 1850-1910MHz WCDMA Band 4/LTE Band 4: 1710-1755MHz WCDMA Band 5/LTE Band 5/NR n5: 824-849MHz LTE Band 7: 2500-2570MHz, LTE Band 12: 699-716MHz LTE Band 13: 777-787MHz, LTE Band 14: 788-798MHz LTE Band 25: 1850-1915MHz, LTE Band 26: 824-849MHz LTE Band 30: 2305-2315MHz, LTE Band 41: 2496-2690MHz LTE Band 48: 3550-3700MHz, LTE Band 66/NR n66: 1710-1780MHz LTE Band 71/NR n71: 663-698MHz
Type of Modulation	WCDMA: RMC 12.2Kbps/HSDPA/HSUPA LTE: QPSK/16QAM/64QAM/256QAM NR: CP-OFDM/DFT-s-OFDM/PI/2 BPSK/QPSK/16QAM/64QAM/256QAM
Device Category	Portable
RF Exposure Environment	Uncontrolled
Summary of test result – Reported Body 1g SAR (W/Kg)	
Test configuration	Licensed
Standalone	1.107

1.2 Antenna List

Antenna	Manufacturer	Antenna type	TX Bands
ANT0	INPAQ	Dipole	WCDMA B2/B4/B5 LTE Band 2/4/5/7/12/13/14/25/26/30/41/66/71 NR n2/n5/n66/n71
ANT2		Dipole	LTE Band 5/12/13/14/26/41/48/71 NR n5/n71

Note: The above EUT information by host manufacturer.

1.3 Test Environment

Ambient conditions in the laboratory:

Test Date: 2022/11/08– 2022/11/20

Items	Required	Actual
Temperature (°C)	18-25	22.8 ±2
Humidity (%RH)	30-70	50 ±20

USA : **FCC Registration Number: TW0033**

Canada : **CAB Identifier Number: TW3023 / Company Number: 26930**

Site Description : Accredited by TAF
Accredited Number: 3023

Test Laboratory : DEKRA Testing and Certification Co., Ltd
Address : No. 26, Huaya 1st Rd., Guishan Dist.,
Taoyuan City 333411, Taiwan, R.O.C.

Phone Number : 886-3-275-7255

Fax Number : 886-3-327-8031

Email Address : info.tw@dekra.com

Website : <http://www.dekra.com.tw>

2. SAR Measurement System

2.1 DASY5 System Description

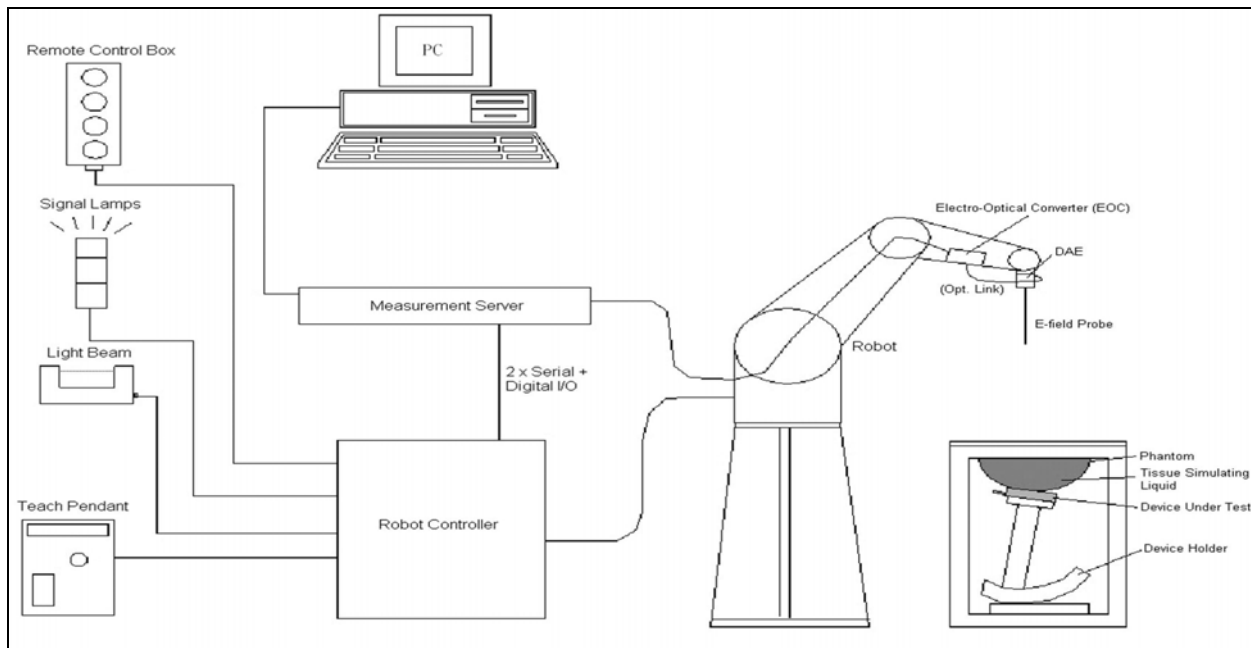

The DASY5 system for performing compliance tests consists of the following items:

- A standard high precision 6-axis robot with controller, teach pendant and software. An arm extension for accommodating the data acquisition electronics (DAE).
- A data acquisition electronics (DAE) which performs the signal amplification, signal multiplexing, AD-conversion, offset measurements, mechanical surface detection, collision detection, etc. The unit is battery powered with standard or rechargeable batteries. The signal is optically transmitted to the EOC.
- The Electro-optical converter (EOC) performs the conversion from optical to electrical signals for the digital communication to the DAE. To use optical surface detection, a special version of the EOC is required. The EOC signal is transmitted to the measurement server.
- The Light Beam used is for probe alignment. This improves the (absolute) accuracy of the probe positioning.
- A computer running WinXP and the DASY5 software.
- Remote control and teach pendant as well as additional circuitry for robot safety such as warning lamps, etc.
- The phantom, the device holder and other accessories according to the targeted measurement.

2.1.1 Applications

Predefined procedures and evaluations for automated compliance testing with all worldwide standards, e.g., IEEE 1528, OET 65, IEC 62209-1, IEC 62209-2, EN 50360, EN 50383 and others.

2.1.2 Area Scans

Area scans are defined prior to the measurement process being executed with a user defined variable spacing between each measurement point (integral) allowing low uncertainty measurements to be conducted. Scans defined for FCC applications utilize a 10mm² step integral, with 1mm interpolation used to locate the peak SAR area used for zoom scan assessments.

When an Area Scan has measured all reachable points, it computes the field maxima found in the scanned area, within a range of the global maximum. The range (in dB) is specified in the standards for compliance testing. For example, a 2 dB range is required in IEEE 1528-2013, EN 50361 and IEC 62209 standards, whereby 3 dB is a requirement when compliance is assessed in accordance with the ARIB standard (Japan).

2.1.3 Zoom Scan (Cube Scan Averaging)

Zoom Scans are used to assess the peak spatial SAR values within a cubic averaging volume containing 1 g and 10 g of simulated tissue. A density of 1000 kg/m³ is used to represent the head and body tissue density and not the phantom liquid density, in order to be consistent with the definition of the liquid dielectric properties, i.e. the side length of the 1 g cube is 10mm, with the side length of the 10 g cube 21,5mm.

The zoom scan integer steps can be user defined so as to reduce uncertainty, but normal practice for typical test applications (including FCC) utilize a physical step of 5x5x7 (8mmx8mmx5mm) providing a volume of 32mm in the X & Y axis, and 30mm in the Z axis.

2.1.4 Uncertainty of Inter-/Extrapolation and Averaging

In order to evaluate the uncertainty of the interpolation, extrapolation and averaged SAR calculation algorithms of the Postprocessor, DASY5 allows the generation of measurement grids which are artificially predefined by analytically based test functions. Therefore, the grids of area scans and zoom scans can be filled with uncertainty test data, according to the SAR benchmark functions of IEEE 1528. The three analytical functions shown in equations as below are used to describe the possible range of the expected SAR

distributions for the tested handsets. The field gradients are covered by the spatially flat distribution f1, the spatially steep distribution f3 and f2 accounts for H-field cancellation on the phantom/tissue surface.

$$f_1(x, y, z) = Ae^{-\frac{z}{2a}} \cos^2 \left(\frac{\pi \sqrt{x'^2 + y'^2}}{2 \cdot 5a} \right)$$

$$f_2(x, y, z) = Ae^{-\frac{z}{a}} \frac{a^2}{a^2 + x'^2} \left(3 - e^{-\frac{2z}{a}} \right) \cos^2 \left(\frac{\pi y'}{2 \cdot 3a} \right)$$

$$f_3(x, y, z) = A \frac{a^2}{\frac{a^2}{4} + x'^2 + y'^2} \left(e^{-\frac{2z}{a}} + \frac{a^2}{2(a + 2z)^2} \right)$$

2.2 DASYS E-Field Probe

The SAR measurement is conducted with the dosimetric probe manufactured by SPEAG. The probe is specially designed and calibrated for use in liquid with high permittivity. The dosimetric probe has special calibration in liquid at different frequency.

SPEAG conducts the probe calibration in compliance with international and national standards (e.g. IEEE 1528, EN 62209-1, IEC 62209, etc.) under ISO 17025. The calibration data are in Appendix D.

2.2.1 Isotropic E-Field Probe Specification

Model	Ex3DV4	
Construction	Symmetrical design with triangular core Built-in shielding against static charges PEEK enclosure material (resistant to organic solvents, e.g., DGBE)	
Frequency	10 MHz to 6 GHz Linearity: ± 0.2 dB (30 MHz to 6 GHz)	
Directivity	± 0.3 dB in HSL (rotation around probe axis) ± 0.5 dB in tissue material (rotation normal to probe axis)	
Dynamic Range	10 μ W/g to 100 mW/g Linearity: ± 0.2 dB (noise: typically < 1 μ W/g)	
Dimensions	Overall length: 330 mm (Tip: 20 mm) Tip diameter: 2.5 mm (Body: 12 mm) Typical distance from probe tip to dipole centers: 1 mm	
Application	High precision dosimetric measurements in any exposure scenario (e.g., very strong gradient fields). Only probe which enables compliance testing for frequencies up to 6 GHz with precision of better 30%.	

2.3 Boundary Detection Unit and Probe Mounting Device

The DASY probes use a precise connector and an additional holder for the probe, consisting of a plastic tube and a flexible silicon ring to center the probe. The connector at the DAE is flexibly mounted and held in the default position with magnets and springs. Two switching systems in the connector mount detect frontal and lateral probe collisions and trigger the necessary software response.

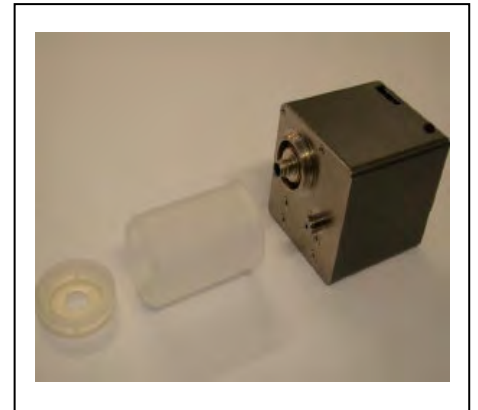

2.4 DATA Acquisition Electronics (DAE) and Measurement Server

The data acquisition electronics (DAE) consists of a highly sensitive electrometer-grade preamplifier with auto-zeroing, a channel and gain-switching multiplexer, a fast 16 bit AD-converter and a command decoder and control logic unit.

Transmission to the measurement server is accomplished through an optical downlink for data and status information as well as an optical uplink for commands and the clock.

The input impedance of the DAE4 is 200M Ohm; the inputs are symmetrical and floating. Common mode rejection is above 80dB.



The DASY5 measurement server is based on a PC/104 CPU board with a 400MHz intel ULV Celeron, 128MB chipdisk and 128MB RAM. The necessary circuits for communication with the DAE electronics box, as well as the 16 bit AD converter system for optical detection and digital I/O interface are contained on the DASY5 I/O board, which is directly connected to the PC/104 bus of the CPU board.



2.5 Robot

The DASY5 system uses the high precision robots TX90 XL type out of the newer series from Stäubli SA (France). For the 6-axis controller DASY5 system, the CS8C robot controller version from Stäubli is used.

The XL robot series have many features that are important for our application:

- High precision (repeatability 0.02 mm)
- High reliability (industrial design)
- Jerk-free straight movements
- Low ELF interference (the closed metallic construction shields against motor control fields)
- 6-axis controller



2.6 Light Beam Unit

The light beam switch allows automatic "tooling" of the probe. During the process, the actual position of the probe tip with respect to the robot arm is measured, as well as the probe length and the horizontal probe offset. The software then corrects all movements, such that the robot coordinates are valid for the probe tip.

The repeatability of this process is better than 0.1 mm. If a position has been taught with an aligned probe, the same position will be reached with another aligned probe within 0.1 mm, even if the other probe has different dimensions. During probe rotations, the probe tip will keep its actual position.



2.7 Device Holder

The DASY5 device holder is designed to cope with different positions given in the standard. It has two scales for the device rotation (with respect to the body axis) and the device inclination (with respect to the line between the ear reference points). The rotation center for both scales is the ear reference point (EPR).

Thus the device needs no repositioning when changing the angles.

The DASY5 device holder has been made out of low-loss POM material having the following dielectric parameters: relative permittivity $\epsilon_r = 3$ and loss tangent $\delta = 0.02$. The amount of dielectric material has been reduced in the closest vicinity of the device, since measurements have suggested that the influence of the clamp on the test results could thus be lowered.



2.8 SAM Twin Phantom

The SAM twin phantom is a fiberglass shell phantom with 2mm shell thickness (except the ear region where shell thickness increases to 6mm). It has three measurement areas:

- Left head
- Right head
- Flat phantom



The bottom plate contains three pair of bolts for locking the device holder. The device holder positions are adjusted to the standard measurement positions in the three sections. A white cover is provided to tap the phantom during off-periods to prevent water evaporation and changes in the liquid parameters. On the phantom top, three reference markers are provided to identify the phantom position with respect to the robot.

3. Tissue Simulating Liquid

3.1 The composition of the tissue simulating liquid

The following tissue formulation is for reference only. The composition of the ingredients may be modified accordingly to achieve the target tissue parameters required for routine SAR evaluation.

INGREDIENT (% Weight)	750MHz Head	1750MHz Head	1900MHz Head	2600MHz Head	3GHz Head
Water	40.45	52.55	54.90	44.53	67.63
Salt	1.45	0.34	0.18	0.17	0
Sugar	57.60	0	0	0	0
HEC	0.40	0	0	0	0
Preventol	0.10	0	0	0	0
DGBE	0	47.50	44.92	55.30	3.38
Triton X-100	0	0	0	0	28.99

3.2 Tissue Calibration Result

The dielectric parameters of the liquids were verified prior to the SAR evaluation, using Dielectric Probe Kit and Vector Network Analyzer.

Head Tissue Simulate Measurement				
Frequency [MHz]	Description	Dielectric Parameters		Tissue Temp. [°C]
		ϵ_r	σ [s/m]	
750 MHz	Reference result ± 5% window	41.9 39.81 to 44	0.89 0.85 to 0.93	N/A
	08-Nov-22	41.89	0.87	22.1
826.4 MHz	Channel 4132	40.85	0.91	22.1
829 MHz	Channel 20450	40.81	0.91	22.1
834 MHz	Channel 166800	40.75	0.91	22.1
836.5 MHz	Channel 167300	40.71	0.91	22.1
836.5 MHz	Channel 20525	40.71	0.91	22.1
836.6 MHz	Channel 4183	40.71	0.91	22.1
839 MHz	Channel 167800	40.62	0.92	22.1
844 MHz	Channel 20600	40.61	0.92	22.1
846.6 MHz	Channel 4233	40.57	0.92	22.1

Head Tissue Simulate Measurement				
Frequency [MHz]	Description	Dielectric Parameters		Tissue Temp. [°C]
		ϵ_r	σ [s/m]	
750 MHz	Reference result ± 5% window	41.9 39.81 to 44	0.89 0.85 to 0.93	N/A
	10-Nov-22	41.91	0.88	21.8
704 MHz	Channel 23060	42.41	0.86	21.8
707.5 MHz	Channel 23095	42.37	0.87	21.8
711 MHz	Channel 23130	42.33	0.87	21.8
782 MHz	Channel 23230	41.54	0.89	21.8
793 MHz	Channel 23330	41.42	0.90	21.8

Head Tissue Simulate Measurement				
Frequency [MHz]	Description	Dielectric Parameters		Tissue Temp. [°C]
		ϵ_r	σ [s/m]	
750 MHz	Reference result ± 5% window	41.9 39.81 to 44	0.89 0.85 to 0.93	N/A
	11-Nov-22	41.87	0.89	21.9
673 MHz	Channel 133222	42.91	0.87	21.9
673 MHz	Channel 134600	42.91	0.87	21.9
680.5 MHz	Channel 133297	42.81	0.87	21.9
680.5 MHz	Channel 136100	42.81	0.87	21.9
688 MHz	Channel 133372	42.71	0.88	21.9
688 MHz	Channel 137600	42.71	0.88	21.9

Head Tissue Simulate Measurement				
Frequency [MHz]	Description	Dielectric Parameters		Tissue Temp. [°C]
		ϵ_r	σ [s/m]	
750 MHz	Reference result ± 5% window	41.9 39.81 to 44	0.89 0.85 to 0.93	N/A
	14-Nov-22	41.93	0.88	22.2
831.5 MHz	Channel 26865	40.82	0.91	22.2
836.5 MHz	Channel 26915	40.75	0.91	22.2
841.5 MHz	Channel 26965	40.68	0.92	22.2

Head Tissue Simulate Measurement				
Frequency [MHz]	Description	Dielectric Parameters		Tissue Temp. [°C]
		ϵ_r	σ [s/m]	
1750 MHz	Reference result ± 5% window	40.1 38.1 to 42.11	1.37 1.30 to 1.44	N/A
	19-Nov-22	40.15	1.37	21.6
1712.4 MHz	Channel 1312	40.64	1.36	21.6
1720 MHz	Channel 132072	40.54	1.36	21.6
1730 MHz	Channel 346000	40.41	1.39	21.6
1732.6 MHz	Channel 1413	40.38	1.36	21.6
1745 MHz	Channel 132322	40.22	1.37	21.6
1745 MHz	Channel 349000	40.22	1.37	21.6
1752.6 MHz	Channel 1513	40.12	1.37	21.6
1760 MHz	Channel 352000	40.02	1.41	21.6
1770 MHz	Channel 132572	39.89	1.38	21.6

Head Tissue Simulate Measurement				
Frequency [MHz]	Description	Dielectric Parameters		Tissue Temp. [°C]
		ϵ_r	σ [s/m]	
1900 MHz	Reference result ± 5% window	40 38 to 42	1.4 1.33 to 1.47	N/A
	20-Nov-22	40.69	1.38	22.1
1852.4 MHz	Channel 9262	41.25	1.36	22.1
1860 MHz	Channel 18700	41.16	1.36	22.1
1860 MHz	Channel 26140	41.16	1.36	22.1
1860 MHz	Channel 372000	41.16	1.36	22.1
1880 MHz	Channel 9400	40.93	1.37	22.1
1880 MHz	Channel 18900	40.93	1.37	22.1
1880 MHz	Channel 376000	40.93	1.37	22.1
1882.5 MHz	Channel 26365	40.91	1.37	22.1
1900 MHz	Channel 19100	40.69	1.38	22.1
1900 MHz	Channel 380000	40.69	1.38	22.1
1905 MHz	Channel 26590	40.63	1.38	22.1
1907.6 MHz	Channel 9538	40.61	1.38	22.1

Head Tissue Simulate Measurement				
Frequency [MHz]	Description	Dielectric Parameters		Tissue Temp. [°C]
		ϵ_r	σ [s/m]	
2300 MHz	Reference result ± 5% window	39.5 37.53 to 41.48	1.67 1.59 to 1.75	N/A
	09-Nov-22	39.58	1.67	22.1
2310 MHz	Channel 27710	39.33	1.66	22.1

Head Tissue Simulate Measurement				
Frequency [MHz]	Description	Dielectric Parameters		Tissue Temp. [°C]
		ϵ_r	σ [s/m]	
2600 MHz	Reference result ± 5% window	39 37.05 to 40.95	N/A	N/A
	09-Nov-22	38.99	1.97	22.1
2506 MHz	Channel 39750	40.12	1.92	22.1
2510 MHz	Channel 20850	40.07	1.92	22.1
2535 MHz	Channel 21100	39.77	1.94	22.1
2593 MHz	Channel 40620	39.08	1.96	22.1
2560 MHz	Channel 21350	39.47	1.95	22.1
2680 MHz	Channel 41490	38.04	2.01	22.1

Head Tissue Simulate Measurement				
Frequency [MHz]	Description	Dielectric Parameters		Tissue Temp. [°C]
		ϵ_r	σ [s/m]	
3700 MHz	Reference result ± 5% window	37.7 35.81 to 39.59	3.11 2.96 to 3.27	N/A
	20-Nov-22	37.48	3.13	22.1
3560 MHz	Channel 55340	38.95	3.01	22.1
3625 MHz	Channel 55590	38.27	3.07	22.1
3690 MHz	Channel 56640	37.59	3.12	22.1

3.3 Tissue Dielectric Parameters for Head and Body Phantoms

The head tissue dielectric parameters recommended by the IEC 62209-1 have been incorporated in the following table. These head parameters are derived from planar layer models simulating the highest expected SAR for the dielectric properties and tissue thickness variations in a human head. Other head tissue parameters that have not been specified are interpolated according to the head parameters specified in IEC 62209-1

Target Frequency (MHz)	Head	
	ϵ_r	σ (S/m)
300	45.3	0.87
450	43.5	0.87
750	41.9	0.89
835	41.5	0.90
900	41.5	0.97
1450	40.5	1.20
1640	40.2	1.31
1750	40.1	1.37
1800 – 2000	40.0	1.40
2450	39.2	1.80
3000	38.5	2.40
5000	36.2	4.45
5200	36.0	4.66
5400	35.8	4.86
5600	35.3	5.27
5800	35.3	5.27
6000	35.1	5.48

(ϵ_r = relative permittivity, σ = conductivity and $\rho = 1000 \text{ kg/m}^3$)

4. SAR Measurement Procedure

4.1 SAR System Check

4.1.1 Dipoles

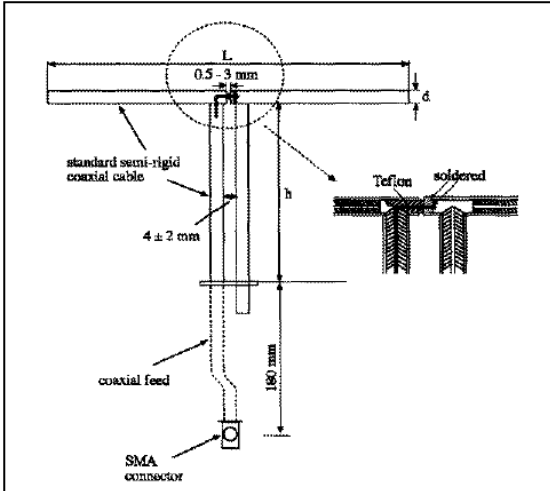

The dipoles used is based on the IEEE-1528 standard, and is complied with mechanical and electrical specifications in line with the requirements of both IEEE and FCC Supplement C. the table below provides details for the mechanical and electrical specifications for the dipoles.

Frequency	L (mm)	h (mm)	d (mm)
750MHz	176.0	100.0	6.35
1750MHz	75.2	42.9	3.6
1900MHz	68.0	39.5	3.6
2300MHz	55.5	32.6	3.6
2600MHz	48.5	28.8	3.6
3700MHz	34.7	26.4	3.6

4.1.2 System Check Result

System Performance Check at 750MHz, 1750MHz, 1950MHz				
Dipole Kit: D750V3				
Frequency [MHz]	Description	SAR [w/kg] 1g	SAR [w/kg] 10g	Tissue Temp. [°C]
750 MHz	Reference result ± 10% window	8.58 7.72 to 9.44	5.61 5.05 to 6.17	N/A
	08-Nov-22	8.72	5.68	22.1
	10-Nov-22	8.92	5.84	21.8
	11-Nov-22	8.64	5.64	21.9
	14-Nov-22	8.48	5.52	22.2
Dipole Kit: D1750V2				
Frequency [MHz]	Description	SAR [w/kg] 1g	SAR [w/kg] 10g	Tissue Temp. [°C]
1750 MHz	Reference result ± 10% window	37.30 33.57 to 41.03	19.6 17.64 to 21.56	N/A
	19-Nov-22	35.84	18.84	21.6
Dipole Kit: D1900V2				
Frequency [MHz]	Description	SAR [w/kg] 1g	SAR [w/kg] 10g	Tissue Temp. [°C]
1900 MHz	Reference result ± 10% window	39.8 35.82 to 43.78	20.8 18.72 to 22.88	N/A
	20-Nov-22	37.96	19.52	22.1
Note: (1) The power level is used 250mW (2) All SAR values are normalized to 1W forward power. (3) The reference result is from Appendix E.				

System Performance Check at 2300MHz, 2600MHz
Dipole Kit: D2300V2

Frequency [MHz]	Description	SAR [w/kg] 1g	SAR [w/kg] 10g	Tissue Temp. [°C]
2300 MHz	Reference result ± 10% window	48.6 43.74 to 53.46	23.2 20.88 to 25.52	N/A
	09-Nov-22	49.2	23.36	22.1

Dipole Kit: ALS-D-2600-S-2

Frequency [MHz]	Description	SAR [w/kg] 1g	SAR [w/kg] 10g	Tissue Temp. [°C]
2600 MHz	Reference result ± 10% window	57.9 52.11 to 63.69	25.7 23.13 to 28.27	N/A
	09-Nov-22	56.8	25.56	22.1

Note: (1) The power level is used 250mW
 (2) All SAR values are normalized to 1W forward power.
 (3) The reference result is from Appendix E.

System Performance Check at 3700MHz
Dipole Kit: D3700V2

Frequency [MHz]	Description	SAR [w/kg] 1g	SAR [w/kg] 10g	Tissue Temp. [°C]
3700 MHz	Reference result ± 10% window	67.2 60.48 to 73.92	24.2 21.78 to 26.62	N/A
	20-Nov-22	65	23.3	22.1

Note: (1) The power level is used 100mW
 (2) All SAR values are normalized to 1W forward power.
 (3) The reference result is from Appendix E.

4.2 SAR Measurement Procedure

The Dasy5 calculates SAR using the following equation,

$$SAR = \frac{\sigma |E|^2}{\rho}$$

σ : represents the simulated tissue conductivity

ρ : represents the tissue density

The EUT is set to transmit at the required power in line with product specification, at each frequency relating to the LOW, MID, and HIGH channel settings.

Pre-scans are made on the device to establish the location for the transmitting antenna, using a large area scan in either air or tissue simulation fluid.

The EUT is placed against the Universal Phantom where the maximum area scan dimensions are larger than the physical size of the resonating antenna. When the scan size is not large enough to cover the peak SAR distribution, it is modified by either extending the area scan size in both the X and Y directions, or the device is shifted within the predefined area.

The area scan is then run to establish the peak SAR location (interpolated resolution set at 1mm²) which is then used to orient the center of the zoom scan. The zoom scan is then executed and the 1g and 10g averages are derived from the zoom scan volume (interpolated resolution set at 1mm³).

5. SAR Exposure Limits

SAR assessments have been made in line with the requirements of IEEE-1528, FCC Supplement C, and comply with ANSI/IEEE C95.1-1992 “Uncontrolled Environments” limits. These limits apply to a location which is deemed as “Uncontrolled Environment” which can be described as a situation where the general public may be exposed to an RF source with no prior knowledge or control over their exposure.

Limits for General Population/Uncontrolled Exposure (W/kg)

Type Exposure	Uncontrolled Environment Limit
Spatial Peak SAR (1g cube tissue for brain or body)	1.60 W/kg
Spatial Average SAR (whole body)	0.08 W/kg
Spatial Peak SAR (10g for hands, feet, ankles and wrist)	4.00 W/kg

6. Test Equipment List

Instrument	Manufacturer	Model No.	Serial No.	Last Calibration	Next Calibration
Reference Dipole 750MHz	Speag	D750V3	1031	2020/05/27	2023/05/26
Reference Dipole 1750MHz	Speag	D1750V2	1113	2019/11/21	2022/11/20
Reference Dipole 1900MHz	Speag	D1900V2	5d184	2022/05/23	2025/05/22
Reference Dipole 2300MHz	Speag	D2300V2	1045	2022/05/25	2025/05/24
Reference Dipole 2600MHz	Apral	ALS-D-2600-S-2	QTK-225	2022/05/25	2025/05/24
Reference Dipole 3700MHz	Speag	D3700V2	1090	2021/02/04	2024/02/03
Device Holder	Speag	N/A	N/A	N/A	N/A
Data Acquisition Electronic	Speag	DAE4	1207	2021/11/22	2022/11/21
E-Field Probe	Speag	EX3DV4	3698	2021/11/24	2022/11/23
Power Amplifier	Mini-Circuit	ZHL-42	D051404-20	N/A	N/A
Power Amplifier	Mini-Circuit	ZVE-8G	541100241	N/A	N/A
Directional Coupler	Agilent	87300C	MY44300353	N/A	N/A ¹
Attenuator	Woken	WATT-218FS-10	N/A	N/A	N/A ¹
Attenuator	Mini-Circuit	BW-S20W2+	N/A	N/A	N/A ¹
Universal Radio Communication	R&S	CMW500	157304	2021/11/29	2022/11/28
Vector Network Analyzer	Agilent	E5071C	MY46108013	2022/02/25	2023/02/24
Signal Generator	Anritsu	MG3694A	041902	2022/08/30	2023/08/29
Power Meter	Anritsu	ML2487A	6K00001447	2022/10/31	2023/10/30
Power Sensor	Anritsu	MA2411B	1339194	2022/10/31	2023/10/30

Note: 1. System Check, the path loss measured by the network analyzer, includes the signal generator, amplifier, cable, attenuator and directional coupler.

7. Measurement Uncertainty

Measurement uncertainty for 30 MHz to 3 GHz								
Error Description	Uncert. value	Prob. Dist.	Div.	(ci) 1g	(ci) 10g	Std. Unc. (1g)	Std. Unc. (10g)	(vi) V _{eff}
Measurement System								
Probe Calibration	±6%	N	1	1	1	±6.0%	±6.0%	∞
Axial Isotropy	±4.7%	R	$\sqrt{3}$	0.7	0.7	±1.9%	±1.9%	∞
Hemispherical Isotropy	±9.6%	R	$\sqrt{3}$	0.7	0.7	±3.9%	±3.9%	∞
Boundary Effects	±1.0%	R	$\sqrt{3}$	1	1	±0.6%	±0.6%	∞
Linearity	±4.7%	R	$\sqrt{3}$	1	1	±2.7%	±2.7%	∞
System Detection Limits	±1.0%	R	$\sqrt{3}$	1	1	±0.6%	±0.6%	∞
Modulation Response	±2.4%	R	$\sqrt{3}$	1	1	±1.4%	±1.4%	∞
Readout Electronics	±0.3%	N	1	1	1	±0.3%	±0.3%	∞
Response Time	±0.8%	R	$\sqrt{3}$	1	1	±0.5%	±0.5%	∞
Integration Time	±2.6%	R	$\sqrt{3}$	1	1	±1.5%	±1.5%	∞
RF Ambient Noise	±3.0%	R	$\sqrt{3}$	1	1	±1.7%	±1.7%	∞
RF Ambient Reflections	±3.0%	R	$\sqrt{3}$	1	1	±1.7%	±1.7%	∞
Probe Positioner	±0.4%	R	$\sqrt{3}$	1	1	±0.2%	±0.2%	∞
Probe Positioning	±2.9%	R	$\sqrt{3}$	1	1	±1.7%	±1.7%	∞
Max. SAR Eval.	±4.0%	R	$\sqrt{3}$	1	1	±1.2%	±1.2%	∞
Test Sample Related								
Device Positioning	±2.9%	N	1	1	1	±2.9%	±2.9%	145
Device Holder	±3.6%	N	1	1	1	±3.6%	±3.6%	5
Power Drift	±5.0%	R	$\sqrt{3}$	1	1	±2.9%	±2.9%	∞
Power Scaling	±0%	R	$\sqrt{3}$	1	1	±0.0%	±0.0%	
Phantom and Setup								
Phantom Uncertainty	±6.1%	R	$\sqrt{3}$	1	1	±3.5%	±3.5%	∞
SAR correction	±1.9%	R	$\sqrt{3}$	1	0.84	±1.1%	±0.9%	∞
Liquid Conductivity (meas.)	±2.5%	R	$\sqrt{3}$	0.78	0.71	±1.1%	±1.0%	∞
Liquid Permittivity (meas.)	±2.5%	R	$\sqrt{3}$	0.26	0.26	±0.3%	±0.4%	∞
Temp. unc. - Conductivity	±3.4%	R	$\sqrt{3}$	0.78	0.71	±1.5%	±1.4%	∞
Temp. unc. - Permittivity	±0.4%	R	$\sqrt{3}$	0.23	0.26	±0.1%	±0.1%	∞
Combined Std. Uncertainty						±11.2%	±11.1%	361
Expanded STD Uncertainty						±22.3%	±22.2%	

Measurement uncertainty for 3GHz to 6 GHz								
Error Description	Uncert. value	Prob. Dist.	Div.	(ci) 1g	(ci) 10g	Std. Unc. (1g)	Std. Unc. (10g)	(vi) V _{eff}
Measurement System								
Probe Calibration	±6.55%	N	1	1	1	±6.55%	±6.55%	∞
Axial Isotropy	±4.7%	R	√3	0.7	0.7	±1.9%	±1.9%	∞
Hemispherical Isotropy	±9.6%	R	√3	0.7	0.7	±3.9%	±3.9%	∞
Boundary Effects	±2.0%	R	√3	1	1	±1.2%	±1.2%	∞
Linearity	±4.7%	R	√3	1	1	±2.7%	±2.7%	∞
System Detection Limits	±1.0%	R	√3	1	1	±0.6%	±0.6%	∞
Modulation Response	±2.4%	R	√3	1	1	±1.4%	±1.4%	∞
Readout Electronics	±0.3%	N	1	1	1	±0.3%	±0.3%	∞
Response Time	±0.8%	R	√3	1	1	±0.5%	±0.5%	∞
Integration Time	±2.6%	R	√3	1	1	±1.5%	±1.5%	∞
RF Ambient Noise	±3.0%	R	√3	1	1	±1.7%	±1.7%	∞
RF Ambient Reflections	±3.0%	R	√3	1	1	±1.7%	±1.7%	∞
Probe Positioner	±0.8%	R	√3	1	1	±0.5%	±0.5%	∞
Probe Positioning	±6.7%	R	√3	1	1	±3.9%	±3.9%	∞
Post-processing	±4.0%	R	√3	1	1	±2.3%	±2.3%	∞
Test Sample Related								
Device Positioning	±2.9%	N	1	1	1	±2.9%	±2.9%	145
Device Holder	±3.6%	N	1	1	1	±3.6%	±3.6%	5
Power Drift	±5.0%	R	√3	1	1	±2.9%	±2.9%	∞
Power Scaling	±0%	R	√3	1	1	±0.0%	±0.0%	
Phantom and Setup								
Phantom Uncertainty	±6.6%	R	√3	1	1	±3.8%	±3.8%	∞
SAR correction	±1.9%	R	√3	1	1	±1.1%	±0.9%	∞
Liquid Conductivity (meas.)	±2.5%	R	√3	1	0.84	±1.1%	±1.0%	∞
Liquid Permittivity (meas.)	±2.5%	R	√3	0.26	0.26	±0.3%	±0.4%	∞
Temp. unc. - Conductivity	±3.4%	R	√3	0.78	0.71	±1.5%	±1.4%	∞
Temp. unc. - Permittivity	±0.4%	R	√3	0.23	0.26	±0.1%	±0.1%	∞
Combined Std. Uncertainty						±12.3%	±12.2%	748
Expanded STD Uncertainty						±24.6%	±24.5%	

8. Conducted Power Measurement (Including tolerance allowed for production unit)

Mode		Maximum Output Power (Including tolerance) (dBm)
		G-sensor Triggered
WCDMA Band 2	RMC	23
WCDMA Band 4	RMC	22.5
WCDMA Band 5	RMC	25
LTE Band 2	QPSK	23
LTE Band 5	QPSK	24
LTE Band 7	QPSK	18.5
LTE Band 12	QPSK	24
LTE Band 13	QPSK	24
LTE Band 14	QPSK	24
LTE Band 25	QPSK	23
LTE Band 26	QPSK	24
LTE Band 30	QPSK	19
LTE Band 41_ANT0	QPSK	16
LTE Band 41_ANT2	QPSK	13.5
LTE Band 48	QPSK	14
LTE Band 66(4)	QPSK	23
LTE Band 71	QPSK	24
NR n2	QPSK	24
NR n5	QPSK	24
NR n66	QPSK	23
NR n71	QPSK	24

Band	WCDMA B2			WCDMA B4			WCDMA B5		
CHANNEL	9262	9400	9538	1312	1413	1513	4132	4183	4233
RMC	21.87	22.11	21.83	21.55	21.66	21.64	23.15	23.56	23.06
HSDPA Set 1	21.32	21.39	21.27	21.15	21.16	21.09	21.97	22.05	21.92
HSDPA Set 2	21.35	21.4	21.26	21.2	21.05	21.24	22.01	22.11	21.99
HSDPA Set 3	21.02	21.41	21.33	21.09	21.13	21.21	22.04	22.01	22.07
HSDPA Set 4	21.28	21.38	21.2	21.11	21.11	21.18	22.10	21.98	22.01
HSUPA Set 1	21.15	21.33	21.09	21.29	21.39	21.21	21.47	21.49	21.33
HSUPA Set 2	19.18	19.39	19.28	19.08	19.48	19.37	20.09	19.97	20.17
HSUPA Set 3	20.68	20.75	20.72	20.71	20.66	20.56	20.14	20.38	20.44
HSUPA Set 4	19.56	19.59	19.4	19.59	19.78	19.73	20.03	20.01	19.98
HSUPA Set 5	21.17	21.14	21.19	21.25	21.31	21.13	21.44	21.34	21.40

Note: Unit : dBm

Channel	Modulation	RB No.	RB Offset	LTE Band 2_ANT0					
				Maximum Conducted Output Power					
				1.4M	3M	5M	10M	15M	20M
Low	QPSK	1	#0	21.54	21.44	21.52	21.48	21.55	21.85
		1	#Mid	21.41	21.45	21.45	21.43	21.48	21.57
		1	#Max	21.35	21.42	21.48	21.41	21.46	21.55
		50%	#0	21.41	21.50	21.45	21.45	21.51	21.84
		50%	#Mid	21.45	21.53	21.46	21.34	21.47	21.60
		50%	#Max	21.42	21.45	21.44	21.41	21.53	21.61
		100%	--	21.44	21.52	21.38	21.35	21.37	21.64
	16QAM	1	#0	21.51	21.54	21.48	21.41	21.50	21.57
		1	#Mid	21.52	21.53	21.49	21.33	21.45	21.55
		1	#Max	21.49	21.51	21.51	21.31	21.44	21.54
		50%	#0	21.47	21.49	21.38	21.34	21.38	21.54
		50%	#Mid	21.46	21.44	21.37	21.35	21.46	21.51
		50%	#Max	21.47	21.42	21.33	21.33	21.38	21.52
		100%	--	21.48	21.44	21.37	21.27	21.45	21.51
	64QAM	1	#0	21.42	21.51	21.39	21.43	21.38	21.56
		1	#Mid	21.37	21.49	21.25	21.35	21.45	21.55
		1	#Max	21.39	21.35	21.34	21.38	21.33	21.43
		50%	#0	20.62	20.58	20.68	20.63	20.43	20.74
		50%	#Mid	20.57	20.60	20.68	20.66	20.45	20.70
		50%	#Max	20.53	20.52	20.61	20.61	20.42	20.71
		100%	--	20.48	20.54	21.44	20.62	20.47	20.71
Mid	QPSK	1	#0	21.50	21.62	21.53	21.55	21.80	21.88
		1	#Mid	21.48	21.68	21.45	21.42	21.73	21.84
		1	#Max	21.43	21.63	21.53	21.51	21.76	21.86
		50%	#0	21.45	21.63	21.34	21.49	21.62	21.85
		50%	#Mid	21.42	21.64	21.32	21.42	21.68	21.76
		50%	#Max	21.43	21.66	21.34	21.46	21.64	21.75
		100%	--	21.47	21.68	21.52	21.38	21.67	21.85
	16QAM	1	#0	21.45	21.51	21.23	21.49	21.69	21.82
		1	#Mid	21.48	21.51	21.29	21.43	21.71	21.80
		1	#Max	21.46	21.57	21.24	21.45	21.67	21.76

		50%	#0	21.35	21.38	21.44	21.43	21.28	21.79	
		50%	#Mid	21.39	21.45	21.48	21.37	21.30	21.72	
		50%	#Max	21.32	21.46	21.46	21.33	21.33	21.58	
		100%	--	21.34	21.35	21.50	21.34	21.29	21.71	
	64QAM	1	#0	21.50	21.48	21.52	21.30	21.36	21.83	
		1	#Mid	21.52	21.51	21.36	21.28	21.57	21.80	
		1	#Max	21.49	21.59	21.43	21.24	21.63	21.79	
		50%	#0	20.46	20.34	20.57	20.55	20.35	20.82	
		50%	#Mid	20.43	20.48	20.65	20.43	20.33	20.73	
		50%	#Max	20.42	20.41	20.71	20.48	20.41	20.54	
		100%	--	20.31	20.41	20.47	20.35	20.31	20.68	
	High	QPSK	1	#0	21.48	21.62	21.55	21.57	21.61	21.84
			1	#Mid	21.43	21.54	21.52	21.53	21.52	21.55
1			#Max	21.41	21.50	21.49	21.52	21.55	21.59	
50%			#0	21.38	21.51	21.29	21.55	21.54	21.82	
50%			#Mid	21.26	21.54	21.24	21.54	21.59	21.62	
50%			#Max	21.37	21.41	21.25	21.56	21.55	21.58	
100%			--	21.29	21.37	21.26	21.49	21.56	21.64	
16QAM		1	#0	21.51	21.55	21.53	21.54	21.56	21.61	
		1	#Mid	21.46	21.52	21.51	21.47	21.52	21.53	
		1	#Max	21.36	21.46	21.44	21.45	21.49	21.51	
		50%	#0	21.25	21.47	21.41	21.44	21.27	21.52	
		50%	#Mid	21.30	21.50	21.47	21.42	21.22	21.52	
		50%	#Max	21.28	21.51	21.46	21.38	21.35	21.50	
		100%	--	21.33	21.40	21.44	21.34	21.28	21.48	
64QAM		1	#0	21.36	21.22	21.17	21.34	21.40	21.57	
		1	#Mid	21.38	21.32	21.33	21.28	21.01	21.42	
		1	#Max	21.45	21.47	21.39	21.22	21.37	21.48	
		50%	#0	20.61	20.24	20.33	20.76	20.09	20.88	
		50%	#Mid	20.49	20.33	20.36	20.84	19.91	20.89	
		50%	#Max	20.55	20.34	20.40	20.57	19.71	20.69	
		100%	--	20.27	20.25	20.32	20.53	19.94	20.76	

Channel	Modulation	RB No.	RB Offset	LTE Band 4_ANT0					
				Maximum Conducted Output Power					
				1.4M	3M	5M	10M	15M	20M
Low	QPSK	1	#0	22.43	22.44	22.41	22.35	22.43	22.50
		1	#Mid	22.34	22.42	22.20	22.26	22.35	22.43
		1	#Max	22.38	22.41	22.25	22.20	22.23	22.40
		50%	#0	22.34	22.35	22.20	22.14	22.17	22.41
		50%	#Mid	22.27	22.15	22.19	22.18	22.18	22.29
		50%	#Max	22.17	22.15	22.18	22.11	22.16	22.23
		100%	--	22.21	22.14	22.17	22.13	22.18	22.28
	16QAM	1	#0	22.34	22.32	22.33	22.33	22.32	22.42
		1	#Mid	22.35	22.30	22.37	22.30	22.41	22.48
		1	#Max	22.34	22.33	22.37	22.29	22.36	22.45
		50%	#0	22.36	21.36	21.32	21.29	21.29	21.41
		50%	#Mid	21.35	21.36	21.29	21.30	21.32	21.41
		50%	#Max	21.34	21.36	21.26	21.18	21.30	21.37
		100%	--	21.30	21.33	21.29	21.24	21.28	21.36
	64QAM	1	#0	21.49	21.44	21.40	21.40	21.45	21.52
		1	#Mid	21.46	21.43	21.41	21.52	21.51	21.54
		1	#Max	21.44	21.48	21.47	21.49	21.48	21.51
		50%	#0	20.37	20.32	20.34	20.27	20.30	20.39
		50%	#Mid	20.33	20.31	20.32	20.34	20.31	20.40
		50%	#Max	20.35	20.36	20.30	20.19	20.28	20.37
		100%	--	20.24	20.29	20.26	20.26	20.26	20.35
Mid	QPSK	1	#0	22.48	22.49	22.47	22.47	22.49	22.52
		1	#Mid	22.41	22.48	22.42	22.39	22.46	22.48
		1	#Max	22.40	22.44	22.42	22.44	22.37	22.46
		50%	#0	22.40	22.43	22.44	22.42	22.42	22.45
		50%	#Mid	22.39	22.43	22.41	22.37	22.45	22.46
		50%	#Max	22.37	22.40	22.42	22.43	22.36	22.44
		100%	--	22.36	22.38	22.44	22.39	22.43	22.45
	16QAM	1	#0	22.28	22.46	22.46	22.38	22.47	22.51
		1	#Mid	22.35	22.45	22.32	22.45	22.44	22.46
		1	#Max	22.37	22.40	22.38	22.26	22.36	22.48

		50%	#0	21.53	21.57	21.63	21.61	21.62	21.64	
		50%	#Mid	21.56	21.52	21.58	21.57	21.55	21.60	
		50%	#Max	21.46	21.43	21.49	21.34	21.48	21.52	
		100%	--	21.52	21.46	21.49	21.53	21.53	21.55	
	64QAM	1	#0	21.75	21.74	21.72	21.74	21.73	21.83	
		1	#Mid	21.71	21.71	21.75	21.75	21.76	21.77	
		1	#Max	21.63	21.65	21.61	21.67	21.66	21.68	
		50%	#0	20.62	20.64	20.63	20.64	20.64	20.66	
		50%	#Mid	20.55	20.53	20.52	20.55	20.58	20.59	
		50%	#Max	20.44	20.47	20.46	20.35	20.47	20.48	
		100%	--	20.45	20.44	20.46	20.41	20.39	20.47	
	High	QPSK	1	#0	22.35	22.38	22.38	22.32	22.38	22.41
			1	#Mid	22.31	22.36	22.36	22.29	22.36	22.37
1			#Max	22.21	22.33	22.32	22.24	22.30	22.38	
50%			#0	22.28	22.29	22.31	22.25	22.28	22.35	
50%			#Mid	22.29	22.31	22.26	22.27	22.26	22.39	
50%			#Max	22.30	22.32	22.25	22.38	22.31	22.34	
100%			--	22.27	22.34	22.23	22.24	22.35	22.38	
16QAM		1	#0	22.21	22.28	22.28	22.28	22.28	22.40	
		1	#Mid	22.25	22.26	22.22	22.27	22.25	22.32	
		1	#Max	22.25	22.23	22.27	22.26	22.17	22.39	
		50%	#0	21.71	21.72	21.69	21.74	21.68	21.77	
		50%	#Mid	21.70	21.66	21.68	21.71	21.67	21.72	
		50%	#Max	21.63	21.62	21.66	21.50	21.61	21.68	
		100%	--	21.55	21.59	21.61	21.57	21.63	21.65	
64QAM		1	#0	21.83	21.86	21.87	21.85	21.82	21.88	
		1	#Mid	21.84	21.82	21.76	21.81	21.79	21.85	
		1	#Max	21.72	21.75	21.77	21.73	21.74	21.78	
		50%	#0	20.63	20.68	20.65	20.67	20.65	20.69	
		50%	#Mid	20.71	20.66	20.68	20.69	20.70	20.72	
		50%	#Max	20.63	20.64	20.60	20.50	20.59	20.66	
		100%	--	20.59	20.54	20.55	20.58	20.61	20.62	

Channel	Modulation	RB No.	RB Offset	LTE Band 5_ANT0					
				Maximum Conducted Output Power					
				1.4M	3M	5M	10M	15M	20M
Low	QPSK	1	#0	23.02	23.01	22.98	23.06	--	--
		1	#Mid	22.83	22.79	22.84	22.85	--	--
		1	#Max	22.73	22.72	22.77	22.79	--	--
		50%	#0	21.77	21.72	21.76	21.82	--	--
		50%	#Mid	21.64	21.62	21.68	21.71	--	--
		50%	#Max	21.79	21.75	21.73	21.80	--	--
		100%	--	21.75	21.73	21.72	21.76	--	--
	16QAM	1	#0	22.32	22.74	22.71	22.77	--	--
		1	#Mid	22.30	22.51	22.31	22.56	--	--
		1	#Max	22.55	22.49	22.52	22.56	--	--
		50%	#0	21.25	21.26	21.33	21.43	--	--
		50%	#Mid	21.34	21.30	21.25	21.40	--	--
		50%	#Max	21.22	21.23	21.23	21.24	--	--
		100%	--	21.25	21.26	21.18	21.28	--	--
	64QAM	1	#0	20.97	21.21	21.22	21.24	--	--
		1	#Mid	21.47	20.97	21.51	21.54	--	--
		1	#Max	21.40	21.09	21.51	21.53	--	--
		50%	#0	20.47	20.46	20.45	20.55	--	--
		50%	#Mid	20.44	20.30	20.35	20.48	--	--
		50%	#Max	20.37	20.15	20.23	20.39	--	--
		100%	--	20.19	20.34	20.32	20.42	--	--
Mid	QPSK	1	#0	23.01	23.05	23.03	23.07	--	--
		1	#Mid	22.92	22.95	22.93	22.97	--	--
		1	#Max	22.95	22.93	22.98	23.05	--	--
		50%	#0	21.86	21.85	21.82	21.87	--	--
		50%	#Mid	21.84	21.82	21.79	21.84	--	--
		50%	#Max	21.83	21.80	21.84	21.85	--	--
		100%	--	21.77	21.75	21.77	21.81	--	--
	16QAM	1	#0	22.29	22.52	22.13	22.67	--	--
		1	#Mid	22.39	22.54	22.66	22.73	--	--
		1	#Max	22.21	21.99	22.61	22.66	--	--

		50%	#0	21.22	21.14	21.27	21.31	--	--	
		50%	#Mid	21.23	21.21	21.20	21.26	--	--	
		50%	#Max	22.13	21.21	21.19	21.22	--	--	
		100%	--	20.98	21.06	21.17	21.18	--	--	
	64QAM	1	#0	21.34	21.49	21.32	21.55	--	--	
		1	#Mid	21.03	21.56	21.56	21.57	--	--	
		1	#Max	21.14	21.13	20.98	21.21	--	--	
		50%	#0	20.24	20.17	20.28	20.27	--	--	
		50%	#Mid	20.34	20.32	20.30	20.36	--	--	
		50%	#Max	20.23	20.17	20.27	20.31	--	--	
	100%	--	19.99	20.02	20.06	20.13	--	--		
	High	QPSK	1	#0	22.86	22.83	22.81	22.88	--	--
			1	#Mid	22.79	22.81	22.77	22.82	--	--
1			#Max	22.85	22.75	22.78	22.87	--	--	
50%			#0	21.73	21.77	21.75	21.81	--	--	
50%			#Mid	21.74	21.75	21.78	21.82	--	--	
50%			#Max	21.72	21.76	21.74	21.80	--	--	
100%			--	21.62	21.65	21.64	21.75	--	--	
16QAM		1	#0	22.15	22.32	22.03	22.57	--	--	
		1	#Mid	22.52	22.48	21.98	22.54	--	--	
		1	#Max	22.19	22.28	22.49	22.51	--	--	
		50%	#0	21.18	21.02	21.11	21.22	--	--	
		50%	#Mid	20.99	21.05	21.07	21.11	--	--	
		50%	#Max	21.01	21.05	21.02	21.06	--	--	
		100%	--	20.95	21.13	21.08	21.14	--	--	
64QAM		1	#0	21.30	21.38	21.41	21.53	--	--	
		1	#Mid	21.09	21.12	21.08	21.36	--	--	
		1	#Max	21.20	21.03	21.29	21.34	--	--	
		50%	#0	20.17	20.11	20.21	20.22	--	--	
		50%	#Mid	20.13	20.17	20.02	20.19	--	--	
		50%	#Max	19.95	20.06	20.01	20.10	--	--	
		100%	--	19.87	20.14	20.05	20.15	--	--	

Channel	Modulation	RB No.	RB Offset	LTE Band 5_ANT2					
				Maximum Conducted Output Power					
				1.4M	3M	5M	10M	15M	20M
Low	QPSK	1	#0	22.94	22.93	22.96	22.97	--	--
		1	#Mid	22.81	22.82	22.84	22.86	--	--
		1	#Max	22.71	22.75	22.72	22.77	--	--
		50%	#0	21.75	21.76	21.71	21.77	--	--
		50%	#Mid	21.64	21.69	21.67	21.72	--	--
		50%	#Max	21.69	21.70	21.65	21.71	--	--
		100%	--	21.71	21.74	21.72	21.78	--	--
	16QAM	1	#0	22.35	21.48	22.51	22.55	--	--
		1	#Mid	22.40	22.45	22.36	22.54	--	--
		1	#Max	22.48	22.46	22.51	22.56	--	--
		50%	#0	21.33	21.27	21.35	21.42	--	--
		50%	#Mid	21.28	21.31	21.27	21.35	--	--
		50%	#Max	22.20	21.25	21.26	21.27	--	--
		100%	--	21.27	21.21	21.24	21.25	--	--
	64QAM	1	#0	21.17	21.23	21.22	21.26	--	--
		1	#Mid	21.11	20.96	21.08	21.19	--	--
		1	#Max	21.08	21.07	21.05	21.14	--	--
		50%	#0	20.39	20.44	20.44	20.45	--	--
		50%	#Mid	20.34	20.35	20.37	20.38	--	--
		50%	#Max	20.23	20.28	20.26	20.29	--	--
		100%	--	20.22	20.36	20.32	20.37	--	--
Mid	QPSK	1	#0	22.93	22.97	22.94	23.03	--	--
		1	#Mid	22.91	22.94	22.91	22.95	--	--
		1	#Max	22.87	22.93	22.94	22.97	--	--
		50%	#0	21.75	21.76	21.77	21.78	--	--
		50%	#Mid	21.70	21.73	21.71	21.76	--	--
		50%	#Max	21.71	21.71	21.70	21.73	--	--
		100%	--	21.73	21.76	21.74	21.81	--	--
	16QAM	1	#0	22.60	22.55	22.57	22.69	--	--
		1	#Mid	22.42	22.61	22.45	22.68	--	--
		1	#Max	22.57	22.58	22.55	22.63	--	--

		50%	#0	22.24	21.16	21.27	21.34	--	--	
		50%	#Mid	22.15	21.25	21.21	21.31	--	--	
		50%	#Max	22.25	21.30	21.23	21.35	--	--	
		100%	--	20.94	21.06	21.17	21.20	--	--	
	64QAM	1	#0	21.33	21.41	21.31	21.45	--	--	
		1	#Mid	21.35	21.38	21.41	21.44	--	--	
		1	#Max	21.13	21.16	20.97	21.18	--	--	
		50%	#0	20.15	20.19	20.24	20.28	--	--	
		50%	#Mid	20.10	20.11	20.22	20.24	--	--	
		50%	#Max	20.11	20.19	20.18	20.22	--	--	
	100%	--	20.01	20.06	20.06	20.13	--	--		
	High	QPSK	1	#0	22.76	22.74	22.67	22.85	--	--
			1	#Mid	22.75	22.68	22.76	22.78	--	--
1			#Max	22.77	22.67	22.71	22.82	--	--	
50%			#0	21.57	21.55	21.59	21.61	--	--	
50%			#Mid	21.48	21.52	21.47	21.54	--	--	
50%			#Max	21.43	21.39	21.46	21.48	--	--	
100%			--	21.24	21.28	21.26	21.32	--	--	
16QAM		1	#0	22.41	22.46	22.42	22.58	--	--	
		1	#Mid	22.45	22.44	22.43	22.47	--	--	
		1	#Max	22.21	22.27	22.24	22.31	--	--	
		50%	#0	21.13	21.06	21.18	21.22	--	--	
		50%	#Mid	21.15	21.07	21.08	21.17	--	--	
		50%	#Max	21.05	21.01	21.03	21.13	--	--	
		100%	--	20.90	21.10	21.06	21.16	--	--	
64QAM		1	#0	21.32	21.42	21.44	21.46	--	--	
		1	#Mid	21.28	21.21	21.22	21.33	--	--	
		1	#Max	21.21	21.28	21.32	21.34	--	--	
		50%	#0	20.17	20.15	20.23	20.28	--	--	
		50%	#Mid	20.16	20.11	20.07	20.17	--	--	
		50%	#Max	20.09	20.05	20.01	20.13	--	--	
		100%	--	20.06	20.03	20.04	20.09	--	--	

Channel	Modulation	RB No.	RB Offset	LTE Band 7_ANT0					
				Maximum Conducted Output Power					
				1.4M	3M	5M	10M	15M	20M
Low	QPSK	1	#0	--	--	17.07	17.08	17.06	17.12
		1	#Mid	--	--	17.03	17.07	17.02	17.08
		1	#Max	--	--	16.92	16.97	17.02	17.04
		50%	#0	--	--	17.01	16.93	17.05	17.09
		50%	#Mid	--	--	16.97	17.01	16.98	17.03
		50%	#Max	--	--	17.02	17.03	17.01	17.05
		100%	--	--	--	16.91	16.95	16.94	16.98
	16QAM	1	#0	--	--	16.82	16.85	16.83	16.86
		1	#Mid	--	--	16.83	16.82	16.84	16.88
		1	#Max	--	--	16.76	16.80	16.78	16.82
		50%	#0	--	--	16.77	16.81	16.82	16.85
		50%	#Mid	--	--	16.78	16.81	16.84	16.87
		50%	#Max	--	--	16.81	16.79	16.83	16.86
		100%	--	--	--	16.84	16.83	16.87	16.88
	64QAM	1	#0	--	--	16.80	16.82	16.79	16.84
		1	#Mid	--	--	16.77	16.75	16.76	16.81
		1	#Max	--	--	16.75	16.77	16.81	16.83
		50%	#0	--	--	16.81	16.80	16.83	16.85
		50%	#Mid	--	--	16.77	16.79	16.74	16.82
		50%	#Max	--	--	16.79	16.80	16.82	16.83
		100%	--	--	--	16.73	16.82	16.79	16.85
Mid	QPSK	1	#0	--	--	17.51	17.47	17.50	17.55
		1	#Mid	--	--	17.46	17.44	17.43	17.49
		1	#Max	--	--	17.38	17.42	17.41	17.44
		50%	#0	--	--	17.14	17.12	17.13	17.28
		50%	#Mid	--	--	17.21	17.15	17.16	17.25
		50%	#Max	--	--	17.16	17.13	17.12	17.21
		100%	--	--	--	17.07	17.02	17.03	17.13
	16QAM	1	#0	--	--	17.42	17.38	17.44	17.47
		1	#Mid	--	--	17.43	17.41	17.41	17.48
		1	#Max	--	--	17.37	17.38	17.36	17.42

		50%	#0	--	--	17.07	17.08	17.12	17.14	
		50%	#Mid	--	--	17.12	17.13	17.11	17.18	
		50%	#Max	--	--	17.04	17.06	17.10	17.15	
		100%	--	--	--	17.14	17.12	17.15	17.19	
	64QAM	1	#0	--	--	17.28	17.30	17.32	17.35	
		1	#Mid	--	--	17.34	17.33	17.34	17.39	
		1	#Max	--	--	17.25	17.37	17.35	17.41	
		50%	#0	--	--	17.13	17.17	17.15	17.22	
		50%	#Mid	--	--	17.11	17.12	17.15	17.17	
		50%	#Max	--	--	17.03	17.05	17.08	17.13	
		100%	--	--	--	16.99	16.98	17.01	17.08	
	High	QPSK	1	#0	--	--	17.43	17.37	17.42	17.45
			1	#Mid	--	--	17.32	17.31	17.31	17.38
1			#Max	--	--	17.35	17.36	17.34	17.36	
50%			#0	--	--	17.18	17.21	17.24	17.27	
50%			#Mid	--	--	17.22	17.13	17.21	17.25	
50%			#Max	--	--	17.18	17.20	17.21	17.22	
100%			--	--	--	17.09	17.06	17.08	17.11	
16QAM		1	#0	--	--	17.35	17.29	17.31	17.38	
		1	#Mid	--	--	17.28	17.27	17.33	17.35	
		1	#Max	--	--	17.33	17.33	17.38	17.39	
		50%	#0	--	--	17.17	17.21	17.18	17.26	
		50%	#Mid	--	--	17.22	17.16	17.21	17.24	
		50%	#Max	--	--	17.11	17.24	17.21	17.25	
		100%	--	--	--	17.05	17.05	17.03	17.08	
64QAM		1	#0	--	--	17.33	17.23	17.35	17.37	
		1	#Mid	--	--	17.21	17.29	17.28	17.33	
		1	#Max	--	--	17.25	17.26	17.27	17.31	
		50%	#0	--	--	17.15	17.12	17.11	17.17	
		50%	#Mid	--	--	17.08	17.12	17.13	17.15	
		50%	#Max	--	--	17.05	17.08	17.10	17.13	
		100%	--	--	--	17.05	17.06	17.01	17.09	

Channel	Modulation	RB No.	RB Offset	LTE Band 12_ANT0					
				Maximum Conducted Output Power					
				1.4M	3M	5M	10M	15M	20M
Low	QPSK	1	#0	22.41	22.43	22.48	22.51	--	--
		1	#Mid	22.33	22.37	22.46	22.50	--	--
		1	#Max	22.36	22.38	22.33	22.40	--	--
		50%	#0	21.38	21.34	21.38	21.47	--	--
		50%	#Mid	21.37	21.35	21.37	21.45	--	--
		50%	#Max	21.36	21.38	21.41	21.43	--	--
		100%	--	21.72	21.66	21.68	21.75	--	--
	16QAM	1	#0	22.16	22.13	22.18	22.20	--	--
		1	#Mid	22.17	22.18	22.21	22.25	--	--
		1	#Max	21.95	21.97	22.02	22.05	--	--
		50%	#0	20.73	20.79	20.81	20.83	--	--
		50%	#Mid	20.72	20.75	20.73	20.77	--	--
		50%	#Max	21.78	20.79	20.83	20.88	--	--
		100%	--	20.73	20.75	20.72	20.80	--	--
	64QAM	1	#0	20.94	20.97	20.94	21.03	--	--
		1	#Mid	21.05	21.02	20.97	21.06	--	--
		1	#Max	20.83	21.01	20.96	21.09	--	--
		50%	#0	19.89	19.94	19.91	19.95	--	--
		50%	#Mid	19.72	19.76	19.78	19.80	--	--
		50%	#Max	19.70	19.73	19.71	19.75	--	--
		100%	--	19.77	19.78	19.74	19.85	--	--
Mid	QPSK	1	#0	22.60	22.57	22.62	22.64	--	--
		1	#Mid	22.55	22.52	22.54	22.56	--	--
		1	#Max	22.41	22.45	22.48	22.51	--	--
		50%	#0	21.47	21.48	21.46	21.49	--	--
		50%	#Mid	21.35	21.39	21.41	21.43	--	--
		50%	#Max	21.37	21.38	21.32	21.41	--	--
		100%	--	21.41	21.38	21.34	21.43	--	--
	16QAM	1	#0	22.04	22.00	22.05	22.11	--	--
		1	#Mid	22.15	22.11	22.21	22.26	--	--
		1	#Max	22.09	22.15	22.13	22.18	--	--

		50%	#0	20.74	20.73	20.78	20.81	--	--	
		50%	#Mid	20.68	20.71	20.66	20.73	--	--	
		50%	#Max	20.66	20.69	20.71	20.74	--	--	
		100%	--	20.71	20.73	20.76	20.78	--	--	
	64QAM	1	#0	20.96	20.95	20.97	20.99	--	--	
		1	#Mid	20.91	20.93	20.98	21.01	--	--	
		1	#Max	20.85	20.92	20.96	20.97	--	--	
		50%	#0	19.84	19.86	19.78	19.88	--	--	
		50%	#Mid	19.76	19.79	19.76	19.80	--	--	
		50%	#Max	19.78	19.83	19.75	19.85	--	--	
		100%	--	19.72	19.76	19.79	19.80	--	--	
	High	QPSK	1	#0	22.47	22.48	22.47	22.62	--	--
			1	#Mid	22.37	22.42	22.41	22.43	--	--
1			#Max	22.42	22.41	22.35	22.46	--	--	
50%			#0	21.43	21.44	21.46	21.47	--	--	
50%			#Mid	21.33	21.36	21.35	21.43	--	--	
50%			#Max	21.35	21.33	21.37	21.42	--	--	
100%			--	21.29	21.28	21.31	21.33	--	--	
16QAM		1	#0	21.99	22.00	21.93	22.09	--	--	
		1	#Mid	21.87	21.85	21.88	21.92	--	--	
		1	#Max	21.69	21.73	21.72	21.76	--	--	
		50%	#0	20.71	20.73	20.75	20.78	--	--	
		50%	#Mid	20.67	20.71	20.73	20.77	--	--	
		50%	#Max	20.76	20.75	20.73	20.80	--	--	
		100%	--	20.67	20.61	20.64	20.69	--	--	
64QAM		1	#0	20.86	20.85	20.84	20.90	--	--	
		1	#Mid	20.92	20.92	20.88	20.95	--	--	
		1	#Max	20.81	20.83	20.84	20.86	--	--	
		50%	#0	19.75	19.77	19.76	19.80	--	--	
		50%	#Mid	19.68	19.69	19.67	19.72	--	--	
		50%	#Max	19.77	19.74	19.76	19.81	--	--	
		100%	--	19.69	19.75	19.70	19.77	--	--	

LTE Band 12_ANT2

Channel	Modulation	RB No.	RB Offset	LTE Band 12_ANT2					
				Maximum Conducted Output Power					
				1.4M	3M	5M	10M	15M	20M
Low	QPSK	1	#0	22.28	22.13	22.21	22.32	--	--
		1	#Mid	22.16	22.17	22.15	22.24	--	--
		1	#Max	22.17	22.11	22.14	22.28	--	--
		50%	#0	21.17	21.69	21.25	21.27	--	--
		50%	#Mid	21.13	21.15	21.22	21.24	--	--
		50%	#Max	21.15	21.17	21.16	21.22	--	--
		100%	--	21.27	21.21	21.26	21.34	--	--
	16QAM	1	#0	22.15	22.13	22.21	22.23	--	--
		1	#Mid	22.01	22.01	22.05	22.13	--	--
		1	#Max	21.93	22.00	22.02	22.04	--	--
		50%	#0	20.91	20.94	20.87	20.95	--	--
		50%	#Mid	20.81	20.84	20.76	20.86	--	--
		50%	#Max	20.78	20.83	20.86	20.88	--	--
		100%	--	20.81	20.77	20.73	20.82	--	--
	64QAM	1	#0	20.91	21.02	20.96	21.06	--	--
		1	#Mid	21.06	21.02	20.93	21.07	--	--
		1	#Max	20.93	20.94	20.97	21.12	--	--
		50%	#0	19.92	19.94	19.93	19.95	--	--
		50%	#Mid	19.72	19.76	19.78	19.81	--	--
		50%	#Max	19.82	19.83	19.85	19.86	--	--
		100%	--	19.77	19.79	19.72	19.82	--	--
Mid	QPSK	1	#0	22.44	22.35	22.41	22.49	--	--
		1	#Mid	22.38	22.24	22.37	22.42	--	--
		1	#Max	22.25	22.33	22.35	22.39	--	--
		50%	#0	21.27	21.28	21.26	21.34	--	--
		50%	#Mid	21.25	21.29	21.25	21.31	--	--
		50%	#Max	21.28	21.27	21.31	21.32	--	--
		100%	--	21.36	21.38	21.43	21.44	--	--
	16QAM	1	#0	22.05	22.12	22.11	22.13	--	--
		1	#Mid	22.13	22.17	22.25	22.21	--	--
		1	#Max	22.08	22.16	22.13	22.17	--	--

		50%	#0	20.77	20.74	20.77	20.83	--	--	
		50%	#Mid	20.65	20.63	20.66	20.71	--	--	
		50%	#Max	20.76	20.71	20.65	20.78	--	--	
		100%	--	20.68	20.70	20.71	20.74	--	--	
	64QAM	1	#0	20.83	20.91	20.84	20.94	--	--	
		1	#Mid	20.94	20.93	20.91	20.95	--	--	
		1	#Max	20.87	20.89	20.91	20.93	--	--	
		50%	#0	19.86	19.88	19.77	19.93	--	--	
		50%	#Mid	19.84	19.83	19.82	19.88	--	--	
		50%	#Max	19.82	19.71	19.74	19.84	--	--	
		100%	--	19.75	19.76	19.73	19.81	--	--	
	High	QPSK	1	#0	22.44	22.40	22.40	22.45	--	--
			1	#Mid	22.41	22.31	22.28	22.42	--	--
1			#Max	22.35	22.11	22.15	22.39	--	--	
50%			#0	21.25	21.16	21.21	21.27	--	--	
50%			#Mid	21.19	21.21	21.16	21.26	--	--	
50%			#Max	21.13	21.14	21.17	21.27	--	--	
100%			--	21.29	21.22	21.26	21.32	--	--	
16QAM		1	#0	21.91	22.06	21.93	22.11	--	--	
		1	#Mid	21.85	21.87	21.91	21.93	--	--	
		1	#Max	21.75	21.69	21.71	21.77	--	--	
		50%	#0	21.68	20.71	20.65	20.74	--	--	
		50%	#Mid	20.64	20.69	20.72	20.75	--	--	
		50%	#Max	20.76	20.75	20.72	20.81	--	--	
		100%	--	20.66	20.62	20.65	20.70	--	--	
64QAM		1	#0	20.84	20.89	20.87	20.91	--	--	
		1	#Mid	20.91	20.92	20.95	21.04	--	--	
		1	#Max	20.83	20.91	20.94	20.96	--	--	
		50%	#0	19.81	19.87	19.82	19.88	--	--	
		50%	#Mid	19.66	19.67	19.71	19.73	--	--	
		50%	#Max	19.79	19.77	19.73	19.82	--	--	
		100%	--	19.69	19.71	19.71	19.79	--	--	

Channel	Modulation	RB No.	RB Offset	LTE Band 13_ANT0					
				Maximum Conducted Output Power					
				1.4M	3M	5M	10M	15M	20M
Low	QPSK	1	#0	--	--	22.53	--	--	--
		1	#Mid	--	--	22.49	--	--	--
		1	#Max	--	--	22.31	--	--	--
		50%	#0	--	--	21.45	--	--	--
		50%	#Mid	--	--	21.32	--	--	--
		50%	#Max	--	--	21.31	--	--	--
		100%	--	--	--	21.41	--	--	--
	16QAM	1	#0	--	--	22.21	--	--	--
		1	#Mid	--	--	22.31	--	--	--
		1	#Max	--	--	22.33	--	--	--
		50%	#0	--	--	21.07	--	--	--
		50%	#Mid	--	--	21.12	--	--	--
		50%	#Max	--	--	21.13	--	--	--
		100%	--	--	--	21.10	--	--	--
	64QAM	1	#0	--	--	21.13	--	--	--
		1	#Mid	--	--	21.28	--	--	--
		1	#Max	--	--	21.30	--	--	--
		50%	#0	--	--	20.12	--	--	--
		50%	#Mid	--	--	20.16	--	--	--
		50%	#Max	--	--	20.11	--	--	--
		100%	--	--	--	20.13	--	--	--
Mid	QPSK	1	#0	--	--	22.59	22.69	--	--
		1	#Mid	--	--	22.42	22.51	--	--
		1	#Max	--	--	22.32	22.34	--	--
		50%	#0	--	--	21.47	21.51	--	--
		50%	#Mid	--	--	21.33	21.42	--	--
		50%	#Max	--	--	21.27	21.36	--	--
		100%	--	--	--	21.43	21.52	--	--
	16QAM	1	#0	--	--	22.23	22.29	--	--
		1	#Mid	--	--	22.33	22.35	--	--
		1	#Max	--	--	22.30	22.31	--	--

		50%	#0	--	--	20.98	21.01	--	--	
		50%	#Mid	--	--	20.95	21.02	--	--	
		50%	#Max	--	--	21.02	21.08	--	--	
		100%	--	--	--	21.07	21.09	--	--	
	64QAM	1	#0	--	--	20.97	21.05	--	--	
		1	#Mid	--	--	21.18	21.25	--	--	
		1	#Max	--	--	21.13	21.16	--	--	
		50%	#0	--	--	19.94	20.03	--	--	
		50%	#Mid	--	--	19.97	20.08	--	--	
		50%	#Max	--	--	20.04	20.14	--	--	
		100%	--	--	--	19.92	19.98	--	--	
	High	QPSK	1	#0	--	--	22.34	--	--	--
			1	#Mid	--	--	22.37	--	--	--
1			#Max	--	--	22.30	--	--	--	
50%			#0	--	--	21.41	--	--	--	
50%			#Mid	--	--	21.37	--	--	--	
50%			#Max	--	--	21.27	--	--	--	
100%			--	--	--	21.43	--	--	--	
16QAM		1	#0	--	--	22.30	--	--	--	
		1	#Mid	--	--	22.36	--	--	--	
		1	#Max	--	--	22.30	--	--	--	
		50%	#0	--	--	21.07	--	--	--	
		50%	#Mid	--	--	21.09	--	--	--	
		50%	#Max	--	--	21.11	--	--	--	
		100%	--	--	--	21.12	--	--	--	
64QAM		1	#0	--	--	21.34	--	--	--	
		1	#Mid	--	--	21.32	--	--	--	
		1	#Max	--	--	21.31	--	--	--	
		50%	#0	--	--	20.10	--	--	--	
		50%	#Mid	--	--	20.08	--	--	--	
		50%	#Max	--	--	20.09	--	--	--	
		100%	--	--	--	20.14	--	--	--	

Channel	Modulation	RB No.	RB Offset	LTE Band 13_ANT2					
				Maximum Conducted Output Power					
				1.4M	3M	5M	10M	15M	20M
Low	QPSK	1	#0	--	--	22.87	--	--	--
		1	#Mid	--	--	22.92	--	--	--
		1	#Max	--	--	22.84	--	--	--
		50%	#0	--	--	21.55	--	--	--
		50%	#Mid	--	--	21.50	--	--	--
		50%	#Max	--	--	21.13	--	--	--
		100%	--	--	--	21.19	--	--	--
	16QAM	1	#0	--	--	22.21	--	--	--
		1	#Mid	--	--	22.31	--	--	--
		1	#Max	--	--	22.33	--	--	--
		50%	#0	--	--	21.07	--	--	--
		50%	#Mid	--	--	21.12	--	--	--
		50%	#Max	--	--	21.03	--	--	--
		100%	--	--	--	21.10	--	--	--
	64QAM	1	#0	--	--	21.13	--	--	--
		1	#Mid	--	--	21.28	--	--	--
		1	#Max	--	--	21.30	--	--	--
		50%	#0	--	--	20.12	--	--	--
		50%	#Mid	--	--	20.16	--	--	--
		50%	#Max	--	--	20.11	--	--	--
		100%	--	--	--	20.13	--	--	--
Mid	QPSK	1	#0	--	--	22.89	22.97	--	--
		1	#Mid	--	--	22.91	22.96	--	--
		1	#Max	--	--	22.91	22.94	--	--
		50%	#0	--	--	21.59	21.68	--	--
		50%	#Mid	--	--	21.48	21.52	--	--
		50%	#Max	--	--	21.25	21.33	--	--
		100%	--	--	--	21.24	21.28	--	--
	16QAM	1	#0	--	--	22.23	22.29	--	--
		1	#Mid	--	--	22.17	22.23	--	--
		1	#Max	--	--	22.08	22.15	--	--

		50%	#0	--	--	20.97	21.01	--	--	
		50%	#Mid	--	--	20.94	21.02	--	--	
		50%	#Max	--	--	20.93	21.08	--	--	
		100%	--	--	--	21.02	21.09	--	--	
	64QAM	1	#0	--	--	20.95	21.05	--	--	
		1	#Mid	--	--	21.02	21.07	--	--	
		1	#Max	--	--	21.06	21.16	--	--	
		50%	#0	--	--	19.97	20.03	--	--	
		50%	#Mid	--	--	19.99	20.08	--	--	
		50%	#Max	--	--	20.05	20.14	--	--	
		100%	--	--	--	19.94	19.98	--	--	
	High	QPSK	1	#0	--	--	22.94	--	--	--
			1	#Mid	--	--	22.89	--	--	--
1			#Max	--	--	22.85	--	--	--	
50%			#0	--	--	21.64	--	--	--	
50%			#Mid	--	--	21.61	--	--	--	
50%			#Max	--	--	21.62	--	--	--	
100%			--	--	--	21.18	--	--	--	
16QAM		1	#0	--	--	22.18	--	--	--	
		1	#Mid	--	--	22.16	--	--	--	
		1	#Max	--	--	22.13	--	--	--	
		50%	#0	--	--	21.07	--	--	--	
		50%	#Mid	--	--	21.09	--	--	--	
		50%	#Max	--	--	21.11	--	--	--	
		100%	--	--	--	21.12	--	--	--	
64QAM		1	#0	--	--	21.34	--	--	--	
		1	#Mid	--	--	21.32	--	--	--	
		1	#Max	--	--	21.31	--	--	--	
		50%	#0	--	--	20.10	--	--	--	
		50%	#Mid	--	--	20.08	--	--	--	
		50%	#Max	--	--	20.09	--	--	--	
		100%	--	--	--	20.14	--	--	--	

Channel	Modulation	RB No.	RB Offset	LTE Band 14_ANT0					
				Maximum Conducted Output Power					
				1.4M	3M	5M	10M	15M	20M
Low	QPSK	1	#0	--	--	22.57	--	--	--
		1	#Mid	--	--	22.42	--	--	--
		1	#Max	--	--	22.44	--	--	--
		50%	#0	--	--	21.56	--	--	--
		50%	#Mid	--	--	21.51	--	--	--
		50%	#Max	--	--	21.44	--	--	--
		100%	--	--	--	21.48	--	--	--
	16QAM	1	#0	--	--	22.29	--	--	--
		1	#Mid	--	--	22.29	--	--	--
		1	#Max	--	--	22.30	--	--	--
		50%	#0	--	--	21.11	--	--	--
		50%	#Mid	--	--	21.11	--	--	--
		50%	#Max	--	--	21.07	--	--	--
		100%	--	--	--	21.09	--	--	--
	64QAM	1	#0	--	--	21.16	--	--	--
		1	#Mid	--	--	21.27	--	--	--
		1	#Max	--	--	21.24	--	--	--
		50%	#0	--	--	20.13	--	--	--
		50%	#Mid	--	--	20.20	--	--	--
		50%	#Max	--	--	20.11	--	--	--
		100%	--	--	--	20.10	--	--	--
Mid	QPSK	1	#0	--	--	22.77	22.81	--	--
		1	#Mid	--	--	22.68	22.72	--	--
		1	#Max	--	--	22.64	22.70	--	--
		50%	#0	--	--	21.55	21.63	--	--
		50%	#Mid	--	--	21.57	21.61	--	--
		50%	#Max	--	--	21.52	21.57	--	--
		100%	--	--	--	21.48	21.56	--	--
	16QAM	1	#0	--	--	22.25	22.40	--	--
		1	#Mid	--	--	22.28	22.31	--	--
		1	#Max	--	--	22.12	22.18	--	--

		50%	#0	--	--	20.98	21.00	--	--	
		50%	#Mid	--	--	20.94	21.03	--	--	
		50%	#Max	--	--	21.03	21.04	--	--	
		100%	--	--	--	20.96	21.01	--	--	
	64QAM	1	#0	--	--	21.14	21.20	--	--	
		1	#Mid	--	--	21.17	21.24	--	--	
		1	#Max	--	--	21.11	21.16	--	--	
		50%	#0	--	--	20.01	20.05	--	--	
		50%	#Mid	--	--	19.98	20.06	--	--	
		50%	#Max	--	--	19.92	20.07	--	--	
		100%	--	--	--	19.97	20.05	--	--	
	High	QPSK	1	#0	--	--	22.54	--	--	--
			1	#Mid	--	--	22.42	--	--	--
1			#Max	--	--	22.48	--	--	--	
50%			#0	--	--	21.59	--	--	--	
50%			#Mid	--	--	21.53	--	--	--	
50%			#Max	--	--	21.52	--	--	--	
100%			--	--	--	21.46	--	--	--	
16QAM		1	#0	--	--	22.29	--	--	--	
		1	#Mid	--	--	22.27	--	--	--	
		1	#Max	--	--	22.25	--	--	--	
		50%	#0	--	--	21.02	--	--	--	
		50%	#Mid	--	--	21.07	--	--	--	
		50%	#Max	--	--	21.07	--	--	--	
		100%	--	--	--	20.99	--	--	--	
64QAM		1	#0	--	--	21.21	--	--	--	
		1	#Mid	--	--	21.25	--	--	--	
		1	#Max	--	--	21.24	--	--	--	
		50%	#0	--	--	20.05	--	--	--	
		50%	#Mid	--	--	20.12	--	--	--	
		50%	#Max	--	--	20.10	--	--	--	
		100%	--	--	--	20.04	--	--	--	

Channel	Modulation	RB No.	RB Offset	LTE Band 14_ANT2					
				Maximum Conducted Output Power					
				1.4M	3M	5M	10M	15M	20M
Low	QPSK	1	#0	--	--	22.35	--	--	--
		1	#Mid	--	--	22.20	--	--	--
		1	#Max	--	--	22.25	--	--	--
		50%	#0	--	--	21.51	--	--	--
		50%	#Mid	--	--	21.53	--	--	--
		50%	#Max	--	--	20.95	--	--	--
		100%	--	--	--	20.98	--	--	--
	16QAM	1	#0	--	--	22.29	--	--	--
		1	#Mid	--	--	22.19	--	--	--
		1	#Max	--	--	22.13	--	--	--
		50%	#0	--	--	21.15	--	--	--
		50%	#Mid	--	--	21.17	--	--	--
		50%	#Max	--	--	20.91	--	--	--
		100%	--	--	--	20.94	--	--	--
	64QAM	1	#0	--	--	21.18	--	--	--
		1	#Mid	--	--	21.12	--	--	--
		1	#Max	--	--	21.27	--	--	--
		50%	#0	--	--	20.15	--	--	--
		50%	#Mid	--	--	20.21	--	--	--
		50%	#Max	--	--	20.13	--	--	--
		100%	--	--	--	20.11	--	--	--
Mid	QPSK	1	#0	--	--	22.40	22.77	--	--
		1	#Mid	--	--	22.13	22.65	--	--
		1	#Max	--	--	22.14	22.58	--	--
		50%	#0	--	--	21.57	21.68	--	--
		50%	#Mid	--	--	21.51	21.62	--	--
		50%	#Max	--	--	20.93	21.07	--	--
		100%	--	--	--	20.96	21.03	--	--
	16QAM	1	#0	--	--	22.25	22.39	--	--
		1	#Mid	--	--	22.15	22.28	--	--
		1	#Max	--	--	22.16	22.19	--	--

		50%	#0	--	--	21.06	21.12	--	--
		50%	#Mid	--	--	20.94	21.02	--	--
		50%	#Max	--	--	21.02	21.13	--	--
		100%	--	--	--	20.97	21.07	--	--
	64QAM	1	#0	--	--	21.04	21.12	--	--
		1	#Mid	--	--	21.16	21.21	--	--
		1	#Max	--	--	21.12	21.17	--	--
		50%	#0	--	--	20.02	20.06	--	--
		50%	#Mid	--	--	20.05	20.11	--	--
		50%	#Max	--	--	20.01	20.07	--	--
	100%	--	--	--	19.97	20.03	--	--	
High	QPSK	1	#0	--	--	22.22	--	--	--
		1	#Mid	--	--	21.02	--	--	--
		1	#Max	--	--	22.18	--	--	--
		50%	#0	--	--	21.58	--	--	--
		50%	#Mid	--	--	21.49	--	--	--
		50%	#Max	--	--	20.89	--	--	--
		100%	--	--	--	20.92	--	--	--
	16QAM	1	#0	--	--	21.29	--	--	--
		1	#Mid	--	--	22.27	--	--	--
		1	#Max	--	--	22.33	--	--	--
		50%	#0	--	--	21.06	--	--	--
		50%	#Mid	--	--	21.07	--	--	--
		50%	#Max	--	--	21.11	--	--	--
		100%	--	--	--	20.55	--	--	--
	64QAM	1	#0	--	--	21.21	--	--	--
		1	#Mid	--	--	21.15	--	--	--
		1	#Max	--	--	20.98	--	--	--
		50%	#0	--	--	20.17	--	--	--
		50%	#Mid	--	--	20.19	--	--	--
		50%	#Max	--	--	20.12	--	--	--
		100%	--	--	--	20.07	--	--	--

Channel	Modulation	RB No.	RB Offset	LTE Band 25_ANT0					
				Maximum Conducted Output Power					
				1.4M	3M	5M	10M	15M	20M
Low	QPSK	1	#0	21.41	21.38	21.29	21.35	21.51	21.71
		1	#Mid	21.47	21.25	21.21	21.31	21.39	21.66
		1	#Max	21.29	21.22	21.20	21.32	21.30	21.63
		50%	#0	21.39	21.26	21.25	21.25	21.31	21.84
		50%	#Mid	21.47	21.24	21.24	21.23	21.35	21.57
		50%	#Max	21.42	21.26	21.24	21.25	21.48	21.49
		100%	--	21.38	21.29	21.25	21.22	21.45	21.54
	16QAM	1	#0	21.42	21.32	21.33	21.40	21.47	21.63
		1	#Mid	21.34	21.33	21.21	21.35	21.46	21.61
		1	#Max	21.36	21.22	21.25	21.17	21.33	21.66
		50%	#0	21.26	21.15	21.22	21.15	21.48	21.54
		50%	#Mid	21.25	21.19	21.15	21.15	21.51	21.55
		50%	#Max	21.26	21.13	21.17	21.44	21.46	21.47
		100%	--	21.33	21.13	21.22	21.33	21.48	21.53
	64QAM	1	#0	21.34	21.30	21.13	21.37	21.39	21.44
		1	#Mid	21.37	21.33	21.20	21.34	21.41	21.46
		1	#Max	21.31	21.27	21.24	21.15	21.42	21.48
		50%	#0	20.32	20.56	20.57	20.60	20.66	20.67
		50%	#Mid	20.35	20.59	20.60	20.60	20.60	20.63
		50%	#Max	20.43	20.54	20.52	20.56	20.51	20.57
		100%	--	20.53	20.55	20.55	20.57	20.57	20.59
Mid	QPSK	1	#0	21.45	21.37	21.25	21.33	21.61	21.87
		1	#Mid	21.27	21.31	21.11	21.35	21.53	21.75
		1	#Max	21.26	21.34	21.15	21.20	21.59	21.72
		50%	#0	21.25	21.31	21.15	21.36	21.43	21.85
		50%	#Mid	21.35	21.39	21.14	21.20	21.49	21.74
		50%	#Max	21.33	21.38	21.20	21.15	21.42	21.43
		100%	--	21.35	21.35	21.18	21.23	21.40	21.79
	16QAM	1	#0	21.25	21.25	21.05	21.26	21.47	21.70
		1	#Mid	21.35	21.33	21.09	21.30	21.35	21.67
		1	#Max	21.31	21.35	21.15	21.33	21.25	21.66

		50%	#0	21.28	21.35	21.30	21.35	21.38	21.45	
		50%	#Mid	21.39	21.26	21.33	21.42	21.47	21.48	
		50%	#Max	21.32	21.24	21.16	21.38	21.40	21.42	
		100%	--	21.37	21.21	21.21	21.42	21.36	21.44	
	64QAM	1	#0	21.44	21.23	21.17	21.43	21.49	21.51	
		1	#Mid	21.35	21.25	21.10	21.38	21.44	21.49	
		1	#Max	21.43	21.30	21.19	21.36	21.43	21.45	
		50%	#0	20.45	20.34	20.41	20.36	20.44	20.48	
		50%	#Mid	20.38	20.45	20.48	20.49	20.50	20.53	
		50%	#Max	20.27	20.33	20.37	20.42	20.40	20.45	
		100%	--	20.37	20.42	20.42	20.44	20.45	20.48	
	High	QPSK	1	#0	21.27	21.23	21.25	21.36	21.41	21.58
			1	#Mid	21.18	21.12	21.26	21.24	21.29	21.35
1			#Max	21.16	21.17	21.15	21.16	21.18	21.21	
50%			#0	21.77	21.76	21.68	21.71	21.75	21.84	
50%			#Mid	21.66	21.67	21.65	21.68	21.64	21.74	
50%			#Max	21.69	21.67	21.65	21.68	21.71	21.75	
100%			--	21.68	21.63	21.66	21.61	21.64	21.71	
16QAM		1	#0	21.14	21.31	21.33	21.12	21.37	21.44	
		1	#Mid	21.16	21.27	21.25	21.32	21.22	21.42	
		1	#Max	21.13	21.25	21.28	21.33	21.35	21.40	
		50%	#0	21.22	21.23	21.32	21.34	21.45	21.46	
		50%	#Mid	21.33	21.23	21.37	21.41	21.44	21.42	
		50%	#Max	21.35	21.34	21.33	21.36	21.43	21.44	
		100%	--	21.25	21.25	21.29	21.37	21.35	21.41	
64QAM		1	#0	20.92	20.79	21.11	21.43	21.31	21.51	
		1	#Mid	21.12	20.68	21.22	21.70	21.57	21.47	
		1	#Max	20.87	20.31	20.94	21.16	21.22	21.33	
		50%	#0	21.19	20.13	20.47	20.45	20.53	20.47	
		50%	#Mid	21.10	20.08	20.49	20.49	20.45	20.56	
		50%	#Max	20.85	19.92	20.34	20.53	20.49	20.46	
		100%	--	20.16	20.06	20.39	20.47	20.46	20.45	

Channel	Modulation	RB No.	RB Offset	LTE Band 26_ANT0					
				Maximum Conducted Output Power					
				1.4M	3M	5M	10M	15M	20M
Low	QPSK	1	#0	22.39	22.36	22.38	22.42	22.52	--
		1	#Mid	22.21	22.31	22.37	22.33	22.48	--
		1	#Max	22.25	22.34	22.36	22.38	22.45	--
		50%	#0	22.29	22.33	22.36	22.34	22.41	--
		50%	#Mid	22.33	22.35	22.30	22.37	22.42	--
		50%	#Max	22.38	22.39	22.41	22.44	22.51	--
		100%	--	22.27	22.36	22.37	22.38	22.41	--
	16QAM	1	#0	22.29	22.28	22.26	22.23	22.34	--
		1	#Mid	22.31	22.28	22.25	22.26	22.38	--
		1	#Max	22.22	22.29	22.31	22.23	22.32	--
		50%	#0	21.58	21.57	21.55	21.59	21.69	--
		50%	#Mid	21.56	21.55	21.57	21.59	21.68	--
		50%	#Max	21.57	21.55	21.50	21.53	21.63	--
		100%	--	21.61	21.63	21.68	21.64	21.71	--
	64QAM	1	#0	21.72	21.64	21.63	21.62	21.75	--
		1	#Mid	21.77	21.79	21.76	21.71	21.81	--
		1	#Max	21.64	21.69	21.64	21.61	21.72	--
		50%	#0	20.72	20.64	20.66	20.68	20.75	--
		50%	#Mid	20.52	20.56	20.51	20.58	20.64	--
		50%	#Max	20.62	20.57	20.53	20.61	20.65	--
		100%	--	20.62	20.60	20.58	20.57	20.66	--
Mid	QPSK	1	#0	22.32	22.36	22.38	22.33	22.53	--
		1	#Mid	22.33	22.32	22.32	22.34	22.46	--
		1	#Max	22.35	22.39	22.35	22.39	22.51	--
		50%	#0	21.57	21.53	21.54	21.55	21.80	--
		50%	#Mid	21.43	21.48	21.45	21.40	21.56	--
		50%	#Max	21.43	21.46	21.44	21.49	21.51	--
		100%	--	21.47	21.46	21.41	21.49	21.57	--
	16QAM	1	#0	21.69	21.60	21.66	21.65	21.76	--
		1	#Mid	21.66	21.69	21.66	21.68	21.76	--
		1	#Max	21.68	21.67	21.62	21.68	21.77	--

		50%	#0	20.64	20.69	20.66	20.65	20.77	--	
		50%	#Mid	20.57	20.62	20.52	20.55	20.68	--	
		50%	#Max	20.52	20.50	20.51	20.55	20.60	--	
		100%	--	20.61	20.68	20.63	20.66	20.71	--	
	64QAM	1	#0	21.62	21.69	21.63	21.64	21.78	--	
		1	#Mid	21.72	21.77	21.73	21.76	21.82	--	
		1	#Max	21.77	21.71	21.78	21.72	21.82	--	
		50%	#0	20.72	20.66	20.71	20.69	20.75	--	
		50%	#Mid	20.53	20.58	20.54	20.59	20.67	--	
		50%	#Max	20.57	20.55	20.57	20.56	20.66	--	
	100%	--	20.54	20.61	20.59	20.55	20.65	--		
	High	QPSK	1	#0	22.22	22.26	22.27	22.24	22.44	--
			1	#Mid	22.13	22.14	22.21	22.18	22.29	--
1			#Max	22.21	22.28	22.26	22.24	22.35	--	
50%			#0	22.21	22.26	22.25	22.29	22.33	--	
50%			#Mid	22.19	22.27	22.24	22.27	22.32	--	
50%			#Max	22.16	22.23	22.24	22.27	22.33	--	
100%			--	22.21	22.25	22.29	22.31	22.34	--	
16QAM		1	#0	21.72	21.77	21.75	21.83	21.88	--	
		1	#Mid	21.82	21.83	21.80	21.81	21.92	--	
		1	#Max	21.80	21.73	21.70	21.76	21.83	--	
		50%	#0	20.79	20.77	20.72	20.76	20.88	--	
		50%	#Mid	20.84	20.75	20.84	20.73	20.89	--	
		50%	#Max	20.75	20.72	20.75	20.70	20.79	--	
		100%	--	20.79	20.73	20.78	20.81	20.84	--	
64QAM		1	#0	21.84	21.79	21.80	21.82	21.95	--	
		1	#Mid	21.81	21.77	21.84	21.81	21.99	--	
		1	#Max	21.88	21.87	21.82	21.82	21.90	--	
		50%	#0	20.76	20.68	20.73	20.74	20.86	--	
		50%	#Mid	20.85	20.80	20.85	20.89	20.90	--	
		50%	#Max	20.74	20.76	20.73	20.70	20.80	--	
		100%	--	20.76	20.74	20.75	20.73	20.81	--	

Channel	Modulation	RB No.	RB Offset	LTE Band 26_ANT2					
				Maximum Conducted Output Power					
				1.4M	3M	5M	10M	15M	20M
Low	QPSK	1	#0	22.32	22.35	22.36	22.41	22.48	--
		1	#Mid	22.31	22.36	22.34	22.38	22.47	--
		1	#Max	22.38	22.37	22.36	22.42	22.46	--
		50%	#0	21.61	21.63	21.65	21.67	21.74	--
		50%	#Mid	21.60	21.62	21.67	21.65	21.73	--
		50%	#Max	21.61	21.61	21.66	21.67	21.71	--
		100%	--	21.35	21.37	21.39	22.42	22.48	--
	16QAM	1	#0	22.33	22.29	22.21	22.24	22.38	--
		1	#Mid	22.24	22.28	22.15	22.16	22.37	--
		1	#Max	22.15	21.98	22.13	22.24	22.35	--
		50%	#0	21.64	21.58	21.44	21.49	21.69	--
		50%	#Mid	21.70	21.39	21.69	21.67	21.72	--
		50%	#Max	21.72	21.60	21.65	21.65	21.75	--
		100%	--	21.63	21.61	21.58	21.53	21.65	--
	64QAM	1	#0	21.66	21.67	21.66	21.65	21.72	--
		1	#Mid	21.65	21.68	21.63	21.66	21.73	--
		1	#Max	21.61	21.65	21.64	21.60	21.72	--
		50%	#0	20.72	20.70	20.66	20.68	20.75	--
		50%	#Mid	20.61	20.58	20.55	20.53	20.64	--
		50%	#Max	20.61	20.66	20.63	20.57	20.69	--
		100%	--	20.62	20.63	20.56	20.54	20.66	--
Mid	QPSK	1	#0	22.41	22.43	22.55	22.58	22.62	--
		1	#Mid	22.38	22.39	22.42	22.48	22.56	--
		1	#Max	22.39	22.31	22.45	22.42	22.51	--
		50%	#0	21.58	21.63	21.74	21.73	21.76	--
		50%	#Mid	21.49	21.48	21.64	21.63	21.66	--
		50%	#Max	21.39	21.37	21.46	21.48	21.51	--
		100%	--	21.49	21.55	21.63	21.64	21.67	--
	16QAM	1	#0	21.71	21.73	21.74	21.72	21.77	--
		1	#Mid	21.70	21.69	21.66	21.68	21.72	--
		1	#Max	21.69	21.73	21.72	21.75	21.77	--

		50%	#0	20.72	20.71	20.67	20.73	20.76	--	
		50%	#Mid	20.63	20.61	20.63	20.55	20.66	--	
		50%	#Max	20.68	20.66	20.67	20.69	20.72	--	
		100%	--	20.51	20.55	20.59	20.57	20.61	--	
	64QAM	1	#0	21.31	21.55	21.64	21.65	21.78	--	
		1	#Mid	21.22	21.65	21.73	21.72	21.82	--	
		1	#Max	21.67	21.72	21.68	21.68	21.75	--	
		50%	#0	20.72	20.62	20.67	20.68	20.77	--	
		50%	#Mid	20.64	20.55	20.54	20.49	20.67	--	
		50%	#Max	20.61	20.57	20.47	20.48	20.63	--	
	100%	--	20.62	20.54	20.49	20.45	20.65	--		
	High	QPSK	1	#0	21.99	21.88	21.77	21.96	22.31	--
			1	#Mid	21.83	21.71	21.76	21.83	22.29	--
1			#Max	21.75	21.68	21.62	21.63	22.28	--	
50%			#0	21.65	21.66	21.65	21.62	21.73	--	
50%			#Mid	21.62	21.67	21.61	21.68	21.71	--	
50%			#Max	21.63	21.60	21.62	21.63	21.71	--	
100%			--	21.59	21.55	21.63	21.62	21.63	--	
16QAM		1	#0	21.85	21.85	21.90	21.82	21.96	--	
		1	#Mid	21.81	21.82	21.73	21.79	21.85	--	
		1	#Max	21.75	21.73	21.75	21.79	21.83	--	
		50%	#0	20.76	20.79	20.77	21.76	20.87	--	
		50%	#Mid	20.94	20.75	20.88	20.93	20.98	--	
		50%	#Max	20.73	20.72	20.74	20.74	20.75	--	
		100%	--	20.79	20.81	20.78	20.80	20.83	--	
64QAM		1	#0	21.86	21.85	21.86	21.82	21.91	--	
		1	#Mid	21.71	21.77	21.79	21.81	21.92	--	
		1	#Max	21.88	21.87	21.89	21.82	21.90	--	
		50%	#0	20.83	20.78	20.74	20.72	20.86	--	
		50%	#Mid	20.86	20.89	20.87	20.82	20.92	--	
		50%	#Max	20.77	20.77	20.75	20.73	20.83	--	
		100%	--	20.74	20.74	20.76	20.73	20.81	--	

Channel	Modulation	RB No.	RB Offset	LTE Band 30_ANT0					
				Maximum Conducted Output Power					
				1.4M	3M	5M	10M	15M	20M
Low	QPSK	1	#0	--	--	18.44	--	--	--
		1	#Mid	--	--	18.33	--	--	--
		1	#Max	--	--	18.21	--	--	--
		50%	#0	--	--	18.35	--	--	--
		50%	#Mid	--	--	18.36	--	--	--
		50%	#Max	--	--	18.15	--	--	--
		100%	--	--	--	18.22	--	--	--
	16QAM	1	#0	--	--	18.39	--	--	--
		1	#Mid	--	--	18.25	--	--	--
		1	#Max	--	--	18.22	--	--	--
		50%	#0	--	--	18.15	--	--	--
		50%	#Mid	--	--	18.14	--	--	--
		50%	#Max	--	--	18.16	--	--	--
		100%	--	--	--	18.17	--	--	--
	64QAM	1	#0	--	--	18.25	--	--	--
		1	#Mid	--	--	18.15	--	--	--
		1	#Max	--	--	18.24	--	--	--
		50%	#0	--	--	18.23	--	--	--
		50%	#Mid	--	--	18.21	--	--	--
		50%	#Max	--	--	18.26	--	--	--
		100%	--	--	--	17.99	--	--	--
Mid	QPSK	1	#0	--	--	18.47	18.69	--	--
		1	#Mid	--	--	18.34	18.54	--	--
		1	#Max	--	--	18.25	18.50	--	--
		50%	#0	--	--	18.33	18.52	--	--
		50%	#Mid	--	--	18.46	18.51	--	--
		50%	#Max	--	--	18.35	18.46	--	--
		100%	--	--	--	18.38	18.48	--	--
	16QAM	1	#0	--	--	18.45	18.59	--	--
		1	#Mid	--	--	18.45	18.57	--	--
		1	#Max	--	--	18.42	18.52	--	--

		50%	#0	--	--	18.38	18.48	--	--	
		50%	#Mid	--	--	18.46	18.56	--	--	
		50%	#Max	--	--	18.43	18.63	--	--	
		100%	--	--	--	18.45	18.55	--	--	
	64QAM	1	#0	--	--	18.43	18.53	--	--	
		1	#Mid	--	--	18.44	18.54	--	--	
		1	#Max	--	--	18.47	18.57	--	--	
		50%	#0	--	--	18.46	18.56	--	--	
		50%	#Mid	--	--	18.41	18.51	--	--	
		50%	#Max	--	--	18.42	18.59	--	--	
		100%	--	--	--	18.42	18.52	--	--	
	High	QPSK	1	#0	--	--	18.37	--	--	--
			1	#Mid	--	--	18.25	--	--	--
1			#Max	--	--	18.21	--	--	--	
50%			#0	--	--	18.25	--	--	--	
50%			#Mid	--	--	18.32	--	--	--	
50%			#Max	--	--	18.25	--	--	--	
100%			--	--	--	18.22	--	--	--	
16QAM		1	#0	--	--	18.24	--	--	--	
		1	#Mid	--	--	18.15	--	--	--	
		1	#Max	--	--	18.22	--	--	--	
		50%	#0	--	--	18.05	--	--	--	
		50%	#Mid	--	--	18.19	--	--	--	
		50%	#Max	--	--	18.16	--	--	--	
		100%	--	--	--	18.17	--	--	--	
64QAM		1	#0	--	--	18.31	--	--	--	
		1	#Mid	--	--	18.15	--	--	--	
		1	#Max	--	--	18.18	--	--	--	
		50%	#0	--	--	18.28	--	--	--	
		50%	#Mid	--	--	18.21	--	--	--	
		50%	#Max	--	--	18.22	--	--	--	
		100%	--	--	--	17.99	--	--	--	

Channel	Modulation	RB No.	RB Offset	LTE Band 41_ANT0					
				Maximum Conducted Output Power					
				1.4M	3M	5M	10M	15M	20M
Low	QPSK	1	#0	--	--	15.63	15.68	15.58	15.74
		1	#Mid	--	--	15.58	15.56	15.62	15.66
		1	#Max	--	--	15.55	15.52	15.59	15.63
		50%	#0	--	--	15.51	15.58	15.54	15.67
		50%	#Mid	--	--	15.57	15.53	15.56	15.62
		50%	#Max	--	--	15.55	15.52	15.53	15.57
		100%	--	--	--	15.53	15.55	15.57	15.62
	16QAM	1	#0	--	--	15.50	15.55	15.54	15.58
		1	#Mid	--	--	15.46	15.51	15.53	15.55
		1	#Max	--	--	15.55	15.52	15.49	15.57
		50%	#0	--	--	15.48	15.44	15.51	15.54
		50%	#Mid	--	--	15.49	15.54	15.51	15.59
		50%	#Max	--	--	15.47	15.41	15.45	15.55
		100%	--	--	--	15.42	15.44	15.46	15.52
	64QAM	1	#0	--	--	15.41	15.43	15.46	15.55
		1	#Mid	--	--	15.54	15.52	15.53	15.57
		1	#Max	--	--	15.44	15.48	15.52	15.55
		50%	#0	--	--	15.42	15.47	15.50	15.53
		50%	#Mid	--	--	15.43	15.44	15.48	15.54
		50%	#Max	--	--	15.42	15.46	15.49	15.52
		100%	--	--	--	15.44	15.46	15.43	15.50
Mid	QPSK	1	#0	--	--	15.61	15.66	15.55	15.77
		1	#Mid	--	--	15.52	15.53	15.52	15.63
		1	#Max	--	--	15.55	15.52	15.56	15.60
		50%	#0	--	--	15.52	15.51	15.53	15.68
		50%	#Mid	--	--	15.47	15.48	15.51	15.58
		50%	#Max	--	--	15.44	15.46	15.52	15.57
		100%	--	--	--	15.55	15.56	15.58	15.71
	16QAM	1	#0	--	--	15.55	15.54	15.57	15.63
		1	#Mid	--	--	15.42	15.46	15.42	15.54
		1	#Max	--	--	15.48	15.43	15.46	15.56

		50%	#0	--	--	15.44	15.42	15.48	15.58	
		50%	#Mid	--	--	15.44	15.45	15.47	15.52	
		50%	#Max	--	--	15.47	15.42	15.48	15.53	
		100%	--	--	--	15.56	15.51	15.57	15.61	
	64QAM	1	#0	--	--	15.55	15.53	15.52	15.67	
		1	#Mid	--	--	15.47	15.44	15.48	15.58	
		1	#Max	--	--	15.42	15.45	15.46	15.56	
		50%	#0	--	--	15.44	15.48	15.42	15.55	
		50%	#Mid	--	--	15.42	15.46	15.48	15.53	
		50%	#Max	--	--	15.46	15.43	15.41	15.54	
		100%	--	--	--	15.42	15.43	15.44	15.51	
	High	QPSK	1	#0	--	--	15.56	15.59	15.57	15.68
			1	#Mid	--	--	15.52	15.53	15.58	15.63
1			#Max	--	--	15.52	15.57	15.56	15.61	
50%			#0	--	--	15.55	15.52	15.57	15.58	
50%			#Mid	--	--	15.50	15.52	15.53	15.57	
50%			#Max	--	--	15.55	15.56	15.52	15.56	
100%			--	--	--	15.55	15.54	15.53	15.62	
16QAM		1	#0	--	--	15.41	15.46	15.48	15.56	
		1	#Mid	--	--	15.44	15.44	15.46	15.58	
		1	#Max	--	--	15.45	15.46	15.48	15.58	
		50%	#0	--	--	15.44	15.48	15.43	15.56	
		50%	#Mid	--	--	15.49	15.47	15.46	15.55	
		50%	#Max	--	--	15.45	15.43	15.47	15.52	
		100%	--	--	--	15.44	15.48	15.43	15.57	
64QAM		1	#0	--	--	15.56	15.53	15.57	15.61	
		1	#Mid	--	--	15.43	15.42	15.46	15.56	
		1	#Max	--	--	15.42	15.44	15.47	15.57	
		50%	#0	--	--	15.43	15.45	15.47	15.57	
		50%	#Mid	--	--	15.49	15.47	15.44	15.53	
		50%	#Max	--	--	15.46	15.45	15.43	15.54	
		100%	--	--	--	15.44	15.48	15.45	15.57	

Channel	Modulation	RB No.	RB Offset	LTE Band 41_ANT2					
				Maximum Conducted Output Power					
				1.4M	3M	5M	10M	15M	20M
Low	QPSK	1	#0	--	--	12.63	12.70	12.75	12.81
		1	#Mid	--	--	12.58	12.66	12.67	12.75
		1	#Max	--	--	12.55	12.62	12.72	12.73
		50%	#0	--	--	11.88	11.84	11.89	11.96
		50%	#Mid	--	--	11.91	11.92	11.93	11.95
		50%	#Max	--	--	11.81	11.86	11.87	11.94
		100%	--	--	--	11.92	12.01	12.05	12.48
	16QAM	1	#0	--	--	12.63	12.68	12.75	12.78
		1	#Mid	--	--	12.56	12.65	12.68	12.76
		1	#Max	--	--	12.55	12.61	12.62	12.72
		50%	#0	--	--	11.82	11.88	11.86	11.94
		50%	#Mid	--	--	11.85	11.83	11.81	11.95
		50%	#Max	--	--	11.95	11.93	11.91	12.05
		100%	--	--	--	12.15	12.17	12.11	12.42
	64QAM	1	#0	--	--	12.64	12.63	12.66	12.70
		1	#Mid	--	--	12.59	12.62	12.57	12.67
		1	#Max	--	--	12.53	12.55	12.52	12.69
		50%	#0	--	--	11.93	11.92	11.88	11.96
		50%	#Mid	--	--	12.55	12.59	12.55	12.68
		50%	#Max	--	--	12.61	12.61	12.53	12.73
		100%	--	--	--	12.02	12.05	12.01	12.17
Mid	QPSK	1	#0	--	--	12.65	12.71	12.73	12.85
		1	#Mid	--	--	12.62	12.64	12.67	12.73
		1	#Max	--	--	12.62	12.64	12.58	12.70
		50%	#0	--	--	12.41	12.48	12.45	12.83
		50%	#Mid	--	--	12.51	12.53	12.61	12.63
		50%	#Max	--	--	12.61	12.58	12.52	12.68
		100%	--	--	--	12.12	12.18	12.15	12.58
	16QAM	1	#0	--	--	12.68	12.63	12.65	12.71
		1	#Mid	--	--	12.62	12.58	12.62	12.64
		1	#Max	--	--	12.58	12.63	12.57	12.66

		50%	#0	--	--	12.53	12.52	12.53	12.58	
		50%	#Mid	--	--	12.54	12.55	12.58	12.59	
		50%	#Max	--	--	12.47	12.44	12.48	12.52	
		100%	--	--	--	12.11	12.09	12.08	12.16	
	64QAM	1	#0	--	--	12.59	12.63	12.61	12.67	
		1	#Mid	--	--	12.51	12.55	12.58	12.61	
		1	#Max	--	--	12.55	12.56	12.58	12.60	
		50%	#0	--	--	12.46	12.49	12.51	12.55	
		50%	#Mid	--	--	12.43	12.47	12.49	12.53	
		50%	#Max	--	--	12.63	12.57	12.53	12.65	
		100%	--	--	--	12.16	12.11	12.07	12.51	
	High	QPSK	1	#0	--	--	12.66	12.71	12.73	12.84
			1	#Mid	--	--	12.52	12.66	12.68	12.73
1			#Max	--	--	12.62	12.62	12.66	12.79	
50%			#0	--	--	12.59	12.62	12.63	12.81	
50%			#Mid	--	--	12.63	12.61	12.52	12.72	
50%			#Max	--	--	12.57	12.67	12.58	12.67	
100%			--	--	--	12.13	12.24	12.17	12.25	
16QAM		1	#0	--	--	12.68	12.69	12.66	12.71	
		1	#Mid	--	--	12.53	12.53	12.65	12.68	
		1	#Max	--	--	12.55	12.57	12.58	12.61	
		50%	#0	--	--	12.52	12.55	12.53	12.56	
		50%	#Mid	--	--	12.53	12.51	12.55	12.58	
		50%	#Max	--	--	12.47	12.52	12.48	12.55	
		100%	--	--	--	12.15	12.11	12.04	12.19	
64QAM		1	#0	--	--	12.55	12.56	12.54	12.61	
		1	#Mid	--	--	12.63	12.62	12.57	12.67	
		1	#Max	--	--	12.55	12.51	12.50	12.55	
		50%	#0	--	--	12.49	12.52	12.53	12.58	
		50%	#Mid	--	--	12.51	12.43	12.47	12.53	
		50%	#Max	--	--	12.41	12.44	12.37	12.48	
		100%	--	--	--	12.23	12.15	12.17	12.25	

Channel	Modulation	RB No.	RB Offset	LTE Band 48_ANT2					
				Maximum Conducted Output Power					
				1.4M	3M	5M	10M	15M	20M
Low	QPSK	1	#0	--	--	13.66	13.70	13.77	13.81
		1	#Mid	--	--	13.58	13.66	13.72	13.75
		1	#Max	--	--	13.55	13.62	13.71	13.77
		50%	#0	--	--	13.54	13.61	13.66	13.68
		50%	#Mid	--	--	13.51	13.52	12.57	13.62
		50%	#Max	--	--	12.51	13.57	12.55	13.67
		100%	--	--	--	12.49	12.52	13.25	13.38
	16QAM	1	#0	--	--	13.64	13.68	13.72	13.77
		1	#Mid	--	--	13.62	13.65	13.68	13.72
		1	#Max	--	--	12.57	13.62	12.64	13.67
		50%	#0	--	--	13.51	13.55	13.61	13.66
		50%	#Mid	--	--	13.52	12.55	12.59	13.63
		50%	#Max	--	--	13.58	12.53	12.57	13.61
		100%	--	--	--	13.44	13.47	13.51	13.55
	64QAM	1	#0	--	--	13.62	13.69	13.67	13.72
		1	#Mid	--	--	13.58	12.63	13.62	13.68
		1	#Max	--	--	13.55	12.62	12.65	13.67
		50%	#0	--	--	13.52	13.57	12.54	13.61
		50%	#Mid	--	--	13.48	13.59	12.55	13.63
		50%	#Max	--	--	12.53	12.56	12.57	13.62
		100%	--	--	--	13.47	13.44	13.48	13.52
Mid	QPSK	1	#0	--	--	13.68	13.72	13.78	13.82
		1	#Mid	--	--	13.62	13.66	13.67	13.75
		1	#Max	--	--	13.65	13.68	13.73	13.79
		50%	#0	--	--	13.43	13.42	13.48	13.51
		50%	#Mid	--	--	13.57	13.55	13.51	13.62
		50%	#Max	--	--	13.53	13.51	13.47	13.55
		100%	--	--	--	13.32	13.34	13.38	13.41
	16QAM	1	#0	--	--	13.68	13.66	13.67	13.71
		1	#Mid	--	--	13.59	13.54	13.58	13.64
		1	#Max	--	--	13.58	13.61	13.62	13.66

		50%	#0	--	--	13.63	13.58	13.62	13.68	
		50%	#Mid	--	--	13.54	13.55	13.57	13.62	
		50%	#Max	--	--	13.57	13.52	13.61	13.64	
		100%	--	--	--	13.41	13.49	13.51	13.53	
	64QAM	1	#0	--	--	13.62	13.52	13.65	13.67	
		1	#Mid	--	--	13.53	13.52	13.57	13.61	
		1	#Max	--	--	13.55	13.54	13.58	13.60	
		50%	#0	--	--	13.43	13.47	13.51	13.55	
		50%	#Mid	--	--	13.42	13.50	13.49	13.53	
		50%	#Max	--	--	13.63	13.58	13.51	13.65	
		100%	--	--	--	13.32	13.37	13.35	13.41	
	High	QPSK	1	#0	--	--	13.30	13.36	13.40	13.41
			1	#Mid	--	--	13.30	13.31	13.30	13.33
1			#Max	--	--	13.31	13.32	13.32	13.38	
50%			#0	--	--	13.25	13.22	13.28	13.33	
50%			#Mid	--	--	13.25	13.30	13.25	13.35	
50%			#Max	--	--	13.14	13.17	13.12	13.21	
100%			--	--	--	13.18	13.11	13.18	13.22	
16QAM		1	#0	--	--	13.27	13.19	13.28	13.38	
		1	#Mid	--	--	13.28	13.21	13.24	13.32	
		1	#Max	--	--	13.25	13.27	13.31	13.36	
		50%	#0	--	--	13.17	13.15	13.12	13.29	
		50%	#Mid	--	--	13.11	13.21	13.15	13.24	
		50%	#Max	--	--	13.05	13.06	13.13	13.20	
		100%	--	--	--	13.09	13.06	13.02	13.11	
64QAM		1	#0	--	--	13.21	13.26	13.28	13.34	
		1	#Mid	--	--	13.24	13.28	13.31	13.38	
		1	#Max	--	--	13.21	13.27	13.22	13.32	
		50%	#0	--	--	13.11	13.21	13.11	13.28	
		50%	#Mid	--	--	13.18	13.20	13.17	13.29	
		50%	#Max	--	--	13.08	13.19	13.15	13.24	
		100%	--	--	--	13.16	13.15	13.18	13.28	

Channel	Modulation	RB No.	RB Offset	LTE Band 66_ANT0					
				Maximum Conducted Output Power					
				1.4M	3M	5M	10M	15M	20M
Low	QPSK	1	#0	22.43	22.44	22.41	22.35	22.43	22.50
		1	#Mid	22.34	22.42	22.20	22.26	22.35	22.43
		1	#Max	22.38	22.41	22.25	22.20	22.23	22.40
		50%	#0	22.34	22.35	22.20	22.14	22.17	22.41
		50%	#Mid	22.27	22.15	22.19	22.18	22.18	22.29
		50%	#Max	22.17	22.15	22.18	22.11	22.16	22.23
		100%	--	22.21	22.14	22.17	22.13	22.18	22.28
	16QAM	1	#0	22.34	22.32	22.33	22.33	22.32	22.42
		1	#Mid	22.35	22.30	22.37	22.30	22.41	22.48
		1	#Max	22.34	22.33	22.37	22.29	22.36	22.45
		50%	#0	22.36	21.36	21.32	21.29	21.29	21.41
		50%	#Mid	21.35	21.36	21.29	21.30	21.32	21.41
		50%	#Max	21.34	21.36	21.26	21.18	21.30	21.37
		100%	--	21.30	21.33	21.29	21.24	21.28	21.36
	64QAM	1	#0	21.49	21.44	21.40	21.40	21.45	21.52
		1	#Mid	21.46	21.43	21.41	21.52	21.51	21.54
		1	#Max	21.44	21.48	21.47	21.49	21.48	21.51
		50%	#0	20.37	20.32	20.34	20.27	20.30	20.39
		50%	#Mid	20.33	20.31	20.32	20.34	20.31	20.40
		50%	#Max	20.35	20.36	20.30	20.19	20.28	20.37
		100%	--	20.24	20.29	20.26	20.26	20.26	20.35
Mid	QPSK	1	#0	22.47	22.49	22.47	22.47	22.49	22.61
		1	#Mid	22.41	22.48	22.42	22.39	22.46	22.48
		1	#Max	22.40	22.44	22.42	22.44	22.37	22.46
		50%	#0	22.44	22.43	22.44	22.42	22.42	22.45
		50%	#Mid	22.39	22.43	22.41	22.37	22.45	22.46
		50%	#Max	22.37	22.40	22.42	22.43	22.36	22.44
		100%	--	22.36	22.38	22.44	22.39	22.43	22.45
	16QAM	1	#0	22.28	22.46	22.46	22.38	22.47	22.51
		1	#Mid	22.35	22.45	22.32	22.45	22.44	22.46
		1	#Max	22.37	22.40	22.38	22.26	22.36	22.48

		50%	#0	21.53	21.57	21.63	21.61	21.62	21.64	
		50%	#Mid	21.56	21.52	21.58	21.57	21.55	21.60	
		50%	#Max	21.46	21.43	21.49	21.34	21.48	21.52	
		100%	--	21.52	21.46	21.49	21.53	21.53	21.55	
	64QAM	1	#0	21.75	21.74	21.72	21.74	21.73	21.83	
		1	#Mid	21.71	21.71	21.75	21.75	21.76	21.77	
		1	#Max	21.63	21.65	21.61	21.67	21.66	21.68	
		50%	#0	20.62	20.64	20.63	20.64	20.64	20.66	
		50%	#Mid	20.55	20.53	20.52	20.55	20.58	20.59	
		50%	#Max	20.44	20.47	20.46	20.35	20.47	20.48	
		100%	--	20.45	20.44	20.46	20.41	20.39	20.47	
	High	QPSK	1	#0	22.35	22.38	22.38	22.32	22.38	22.41
			1	#Mid	22.31	22.36	22.36	22.29	22.36	22.37
1			#Max	22.21	22.33	22.32	22.24	22.30	22.38	
50%			#0	22.28	22.35	22.37	22.25	22.28	22.44	
50%			#Mid	22.29	22.31	22.26	22.27	22.26	22.41	
50%			#Max	22.30	22.32	22.25	22.38	22.31	22.34	
100%			--	22.27	22.34	22.23	22.24	22.35	22.38	
16QAM		1	#0	22.21	22.28	22.28	22.28	22.28	22.40	
		1	#Mid	22.25	22.26	22.22	22.27	22.25	22.32	
		1	#Max	22.25	22.23	22.27	22.26	22.17	22.39	
		50%	#0	21.71	21.72	21.69	21.74	21.68	21.77	
		50%	#Mid	21.70	21.66	21.68	21.71	21.67	21.72	
		50%	#Max	21.63	21.62	21.66	21.50	21.61	21.68	
		100%	--	21.55	21.59	21.61	21.57	21.63	21.65	
64QAM		1	#0	21.83	21.86	21.87	21.85	21.82	21.88	
		1	#Mid	21.84	21.82	21.76	21.81	21.79	21.85	
		1	#Max	21.72	21.75	21.77	21.73	21.74	21.78	
		50%	#0	20.63	20.68	20.65	20.67	20.65	20.69	
		50%	#Mid	20.71	20.66	20.68	20.69	20.70	20.72	
		50%	#Max	20.63	20.64	20.60	20.50	20.59	20.66	
		100%	--	20.59	20.54	20.55	20.58	20.61	20.62	

Channel	Modulation	RB No.	RB Offset	LTE Band 71_ANT0					
				Maximum Conducted Output Power					
				1.4M	3M	5M	10M	15M	20M
Low	QPSK	1	#0	--	--	22.25	22.22	22.28	22.34
		1	#Mid	--	--	22.21	22.27	22.25	22.31
		1	#Max	--	--	22.16	22.17	22.19	22.28
		50%	#0	--	--	21.41	21.39	21.38	21.47
		50%	#Mid	--	--	21.31	21.35	21.38	21.44
		50%	#Max	--	--	21.38	21.40	21.41	21.45
		100%	--	--	--	21.24	21.21	21.28	21.33
	16QAM	1	#0	--	--	22.18	22.14	22.17	22.28
		1	#Mid	--	--	22.22	22.16	22.18	22.24
		1	#Max	--	--	22.07	22.16	22.19	22.21
		50%	#0	--	--	21.22	21.26	21.29	21.35
		50%	#Mid	--	--	21.24	21.28	22.21	21.33
		50%	#Max	--	--	21.29	21.25	21.20	21.35
		100%	--	--	--	21.17	21.15	21.21	21.28
	64QAM	1	#0	--	--	21.31	21.28	21.25	21.36
		1	#Mid	--	--	21.22	21.29	21.26	21.34
		1	#Max	--	--	21.26	21.28	21.22	21.33
		50%	#0	--	--	21.16	21.14	21.18	21.22
		50%	#Mid	--	--	21.23	21.24	21.28	21.30
		50%	#Max	--	--	21.18	21.15	21.19	21.27
		100%	--	--	--	21.16	21.13	21.17	21.22
Mid	QPSK	1	#0	--	--	22.45	22.43	22.48	22.51
		1	#Mid	--	--	22.34	22.38	22.41	22.49
		1	#Max	--	--	22.25	22.21	22.29	22.32
		50%	#0	--	--	21.32	21.36	21.37	21.47
		50%	#Mid	--	--	21.38	21.32	21.37	21.44
		50%	#Max	--	--	21.32	21.36	21.34	21.40
		100%	--	--	--	21.15	21.11	21.18	21.22
	16QAM	1	#0	--	--	22.31	22.38	22.35	22.44
		1	#Mid	--	--	22.33	22.29	22.28	22.35
		1	#Max	--	--	22.21	22.28	22.25	22.31

		50%	#0	--	--	22.31	22.38	22.35	21.42	
		50%	#Mid	--	--	21.34	21.39	21.37	21.43	
		50%	#Max	--	--	21.38	21.35	21.31	21.41	
		100%	--	--	--	21.08	21.05	21.02	21.11	
	64QAM	1	#0	--	--	21.31	21.38	21.40	21.46	
		1	#Mid	--	--	21.13	21.18	21.15	21.23	
		1	#Max	--	--	21.17	21.18	21.17	21.22	
		50%	#0	--	--	21.18	21.12	21.21	21.27	
		50%	#Mid	--	--	21.15	21.13	21.18	21.25	
		50%	#Max	--	--	21.08	21.17	21.13	21.22	
		100%	--	--	--	21.00	21.08	21.01	21.12	
	High	QPSK	1	#0	--	--	22.35	22.37	22.40	22.43
			1	#Mid	--	--	22.24	22.25	22.27	22.31
1			#Max	--	--	22.21	22.29	22.35	22.37	
50%			#0	--	--	21.92	21.95	21.98	22.05	
50%			#Mid	--	--	21.95	22.05	22.01	22.15	
50%			#Max	--	--	22.05	22.13	22.18	22.26	
100%			--	--	--	22.01	22.05	22.11	22.12	
16QAM		1	#0	--	--	22.38	22.35	22.34	22.41	
		1	#Mid	--	--	22.26	22.31	22.27	22.38	
		1	#Max	--	--	22.13	22.12	22.18	22.21	
		50%	#0	--	--	22.18	22.16	22.15	22.28	
		50%	#Mid	--	--	22.24	22.28	22.23	22.31	
		50%	#Max	--	--	22.06	22.07	22.05	22.12	
		100%	--	--	--	21.97	22.03	22.08	22.11	
64QAM		1	#0	--	--	22.23	22.27	22.25	22.33	
		1	#Mid	--	--	22.25	22.22	22.27	22.31	
		1	#Max	--	--	22.18	22.15	22.21	22.26	
		50%	#0	--	--	22.05	22.08	22.11	22.15	
		50%	#Mid	--	--	21.98	22.03	22.08	22.16	
		50%	#Max	--	--	22.07	22.12	22.17	22.20	
		100%	--	--	--	21.95	21.92	21.98	22.01	

Channel	Modulation	RB No.	RB Offset	LTE Band 71_ANT2					
				Maximum Conducted Output Power					
				1.4M	3M	5M	10M	15M	20M
Low	QPSK	1	#0	--	--	22.17	22.18	22.21	22.28
		1	#Mid	--	--	22.13	22.16	22.19	22.25
		1	#Max	--	--	22.17	22.13	22.19	22.24
		50%	#0	--	--	21.26	21.23	21.28	21.32
		50%	#Mid	--	--	21.26	21.28	21.33	21.37
		50%	#Max	--	--	21.33	21.36	21.32	21.40
		100%	--	--	--	21.12	21.16	21.17	21.22
	16QAM	1	#0	--	--	22.13	22.19	22.16	22.23
		1	#Mid	--	--	22.11	22.17	22.15	22.21
		1	#Max	--	--	22.14	22.18	22.13	22.25
		50%	#0	--	--	21.11	21.16	21.14	21.28
		50%	#Mid	--	--	21.13	21.10	21.17	21.21
		50%	#Max	--	--	21.09	21.15	21.21	21.26
		100%	--	--	--	21.11	21.16	21.08	21.22
	64QAM	1	#0	--	--	22.29	22.24	21.25	21.32
		1	#Mid	--	--	22.22	22.18	21.26	21.28
		1	#Max	--	--	22.15	22.23	21.22	21.31
		50%	#0	--	--	22.05	21.22	21.12	21.15
		50%	#Mid	--	--	22.11	21.30	21.14	21.25
		50%	#Max	--	--	22.18	21.27	21.19	21.27
		100%	--	--	--	22.00	21.22	21.13	21.18
Mid	QPSK	1	#0	--	--	22.35	22.31	22.38	22.41
		1	#Mid	--	--	22.27	22.31	22.34	22.38
		1	#Max	--	--	22.25	22.23	22.27	22.32
		50%	#0	--	--	21.21	21.26	21.28	21.34
		50%	#Mid	--	--	21.23	21.24	21.27	21.31
		50%	#Max	--	--	21.14	21.11	21.15	21.28
		100%	--	--	--	21.11	21.18	21.13	21.22
	16QAM	1	#0	--	--	22.26	22.24	22.28	22.32
		1	#Mid	--	--	22.12	22.18	22.21	22.27
		1	#Max	--	--	22.11	22.16	22.15	22.21

		50%	#0	--	--	21.25	21.23	21.28	21.32	
		50%	#Mid	--	--	21.15	21.23	21.27	21.31	
		50%	#Max	--	--	21.22	21.26	21.24	21.32	
		100%	--	--	--	20.95	20.98	21.01	21.07	
	64QAM	1	#0	--	--	21.31	21.36	21.35	21.42	
		1	#Mid	--	--	21.06	21.05	21.09	21.15	
		1	#Max	--	--	21.08	21.08	21.11	21.16	
		50%	#0	--	--	21.02	21.11	21.13	21.18	
		50%	#Mid	--	--	21.04	21.06	21.09	21.16	
		50%	#Max	--	--	21.07	21.06	21.04	21.17	
		100%	--	--	--	20.93	20.97	20.95	21.08	
	High	QPSK	1	#0	--	--	22.26	22.27	22.32	22.37
			1	#Mid	--	--	22.18	22.21	22.25	22.29
1			#Max	--	--	22.21	22.27	22.29	22.35	
50%			#0	--	--	21.85	21.88	21.91	21.95	
50%			#Mid	--	--	21.95	21.93	21.94	22.01	
50%			#Max	--	--	22.07	22.06	22.04	22.13	
100%			--	--	--	21.93	21.95	21.97	22.06	
16QAM		1	#0	--	--	22.31	22.29	22.33	22.37	
		1	#Mid	--	--	22.25	22.21	22.27	22.34	
		1	#Max	--	--	22.06	22.08	22.11	22.17	
		50%	#0	--	--	22.11	22.17	22.15	22.23	
		50%	#Mid	--	--	22.21	22.18	22.24	22.27	
		50%	#Max	--	--	21.95	21.98	22.02	22.06	
		100%	--	--	--	21.94	21.93	21.95	22.07	
64QAM		1	#0	--	--	22.16	22.15	22.20	22.27	
		1	#Mid	--	--	22.13	22.14	22.17	22.24	
		1	#Max	--	--	22.11	22.15	22.17	22.21	
		50%	#0	--	--	22.08	22.06	22.05	22.12	
		50%	#Mid	--	--	21.97	21.93	21.95	22.08	
		50%	#Max	--	--	21.99	21.08	21.05	22.10	
		100%	--	--	--	21.84	21.88	21.86	21.97	

LTE Intra-Band Up-Link Carrier Aggregation

Number	Combination
1	5B
2	7C
3	41C

2UL_CA_5B Maximum Average Output Power											
Channel	PCC					SCC					Total Power (dBm)
	BW (MHz)	Channel	Frquency (MHz)	RB No.	RB offest	BW (MHz)	Channel	Frquency (MHz)	RB No.	RB offest	QPSK
Low	10	20450	829	1	0	10	20549	838.9	1	0	22.99
Mid	10	20476	831.6	1	0	10	20575	841.5	1	0	23.02
High	10	20501	834.1	1	0	10	20600	844	1	0	22.98
2UL_CA_7C Maximum Average Output Power											
Channel	PCC					SCC					Total Power (dBm)
	BW (MHz)	Channel	Frquency (MHz)	RB No.	RB offest	BW (MHz)	Channel	Frquency (MHz)	RB No.	RB offest	QPSK
Low	20	20850	2510	1	0	20	21048	2529.8	1	0	17.32
Mid	20	21001	2525.1	1	0	20	21199	2544.9	1	0	17.44
High	20	21152	2540.2	1	0	20	21350	2560	1	0	17.31
2UL_CA_41C Maximum Average Output Power											
Channel	PCC					SCC					Total Power (dBm)
	BW (MHz)	Channel	Frquency (MHz)	RB No.	RB offest	BW (MHz)	Channel	Frquency (MHz)	RB No.	RB offest	QPSK
Low	20	39750	2506	1	0	20	39948	2525.8	1	0	15.37
Mid	20	40521	2583.1	1	0	20	40719	2602.9	1	0	15.42
High	20	41292	2660.2	1	0	20	41490	2680	1	0	15.33

LTE Down-Link Carrier Aggregation

The tables show the supported frequency bands of the device for DL Inter-band and DL Intra-band combinations.

Index	2CC	Restriction	Completely Covered by Measurement Superset	Index	3CC	Restriction	Completely Covered by Measurement Superset
2CC #1	CA_2A-2A		3CC #1	3CC #1	CA_2A-2A-4A		No
2CC #2	CA_2A-4A		3CC #6	3CC #2	CA_2A-2A-12A		No
2CC #3	CA_2A-5A		3CC #12	3CC #3	CA_2A-2A-14A		No
2CC #4	CA_2A-12A		3CC #16	3CC #4	CA_2A-2A-30A		No
2CC #5	CA_2A-14A		3CC #19	3CC #5	CA_2A-2A-66A		No
2CC #6	CA_2A-29A	B29 SCC Only	3CC #21	3CC #6	CA_2A-4A-4A		No
2CC #7	CA_2A-30A		3CC #22	3CC #7	CA_2A-4A-5A		No
2CC #8	CA_2A-46A	B46 SCC Only	3CC #23	3CC #8	CA_2A-4A-7A		No
2CC #9	CA_2A-48A		3CC #26	3CC #9	CA_2A-4A-12A		No
2CC #10	CA_2A-66A		3CC #27	3CC #10	CA_2A-4A-29A	B29 SCC Only	No
2CC #11	CA_4A-4A		3CC #29	3CC #11	CA_2A-4A-30A		No
2CC #12	CA_4A-5A		3CC #31	3CC #12	CA_2A-5A-30A		No
2CC #13	CA_4A-7A		3CC #32	3CC #13	CA_2A-5A-66A		No
2CC #14	CA_4A-12A		3CC #34	3CC #14	CA_2A-7A-7A		No
2CC #15	CA_4A-13A		No	3CC #15	CA_2A-7A-12A		No
2CC #16	CA_4A-29A	B29 SCC Only	3CC #36	3CC #16	CA_2A-12A-30A		No
2CC #17	CA_4A-30A		3CC #36	3CC #17	CA_2A-12A-66A		No
2CC #18	CA_4A-46A	B46 SCC Only	3CC #37	3CC #18	CA_2A-13A-66A		No
2CC #19	CA_5A-12A		No	3CC #19	CA_2A-14A-30A		No
2CC #20	CA_5A-29A	B29 SCC Only	No	3CC #20	CA_2A-14A-66A		No
2CC #21	CA_5A-30A		3CC #40	3CC #21	CA_2A-29A-30A	B29 SCC Only	No
2CC #22	CA_5A-66A		3CC #41	3CC #22	CA_2A-30A-66A		No
2CC #23	CA_5B		3CC #43	3CC #23	CA_2A-46A-46A	B46 SCC Only	No
2CC #24	CA_7A-7A		No	3CC #24	CA_2A-46A-66A	B46 SCC Only	No
2CC #25	CA_7C		No	3CC #25	CA_2A-46C	B46 SCC Only	No
2CC #26	CA_12A-30A		3CC #45	3CC #26	CA_2A-48A-66A		No
2CC #27	CA_12A-66A		3CC #46	3CC #27	CA_2A-66A-66A		No
2CC #28	CA_14A-30A		3CC #50	3CC #28	CA_2A-66C		No
2CC #29	CA_14A-66A		3CC #51	3CC #29	CA_4A-4A-5A		No

2CC #30	CA_29A-30A	B29 SCC Only	3CC #52	3CC #30	CA_4A-4A-12A		No
2CC #31	CA_29A-66A	B29 SCC Only	3CC #53	3CC #31	CA_4A-5A-30A		No
2CC #32	CA_30A-66A		3CC #54	3CC #32	CA_4A-7A-7A		No
2CC #33	CA_41C		No	3CC #33	CA_4A-7A-12A		No
2CC #34	CA_48A-48A		3CC #56	3CC #34	CA_4A-12A-30A		No
2CC #35	CA_48A-66A		3CC #56	3CC #35	CA_4A-12B		No
2CC #36	CA_48C		3CC #58	3CC #36	CA_4A-29A-30A	B29 SCC Only	No
2CC #37	CA_66B		3CC #62	3CC #37	CA_4A-46A-46A	B46 SCC Only	No
2CC #38	CA_66C		3CC #62	3CC #38	CA_4A-46C	B46 SCC Only	No
				3CC #39	CA_5A-5A-66A		No
				3CC #40	CA_5A-30A-66A		No
				3CC #41	CA_5A-66A-66A		No
				3CC #42	CA_5A-66C		No
				3CC #43	CA_5B-66A		No
				3CC #44	CA_7A-66A-66A		No
				3CC #45	CA_12A-30A-66A		No
				3CC #46	CA_12A-66A-66A		No
				3CC #47	CA_12A-66C		No
				3CC #48	CA_13A-66A-66A		No
				3CC #49	CA_13A-66C		No
				3CC #50	CA_14A-30A-66A		No
				3CC #51	CA_14A-66A-66A		No
				3CC #52	CA_29A-30A-66A	B29 SCC Only	No
				3CC #53	CA_29A-66A-66A	B29 SCC Only	No
				3CC #54	CA_30A-66A-66A		No
				3CC #55	CA_46C-66A	B46 SCC Only	No
				3CC #56	CA_48A-48A-66A		No
				3CC #57	CA_48A-66C		No
				3CC #58	CA_48C-66A		No
				3CC #59	CA_48D		No
				3CC #60	CA_66A-66A-66A		No
				3CC #61	CA_66A-66C		No
				3CC #62	CA_66D		No

Two Component Carrier Maximum Couducted Power													
PCC							SCC				TX Power (dBm)		Configurations
Band	BW (MHz)	Modulation	RB No.	RB offest	Channel	Frquency (MHz)	Band	BW (MHz)	Channel	Frquency (MHz)	CA Active	CA Inactive	
LTE B4	20	QPSK	1	0	20175	1732.5	LTE B13	10	5230	751	22.50	22.52	CA_4A-13A
LTE B5	10	QPSK	1	0	20525	836.5	LTE B12	10	5130	741	23.01	23.07	CA_5A-12A
LTE B5	10	QPSK	1	0	20525	836.5	LTE B29	20	3100	2655	23.00	23.07	CA_5A-29A
LTE B7	20	QPSK	1	0	21100	2535	LTE B7	20	3350	2680	17.50	17.55	CA_7A-7A
LTE B7	20	QPSK	1	0	21001	2525.1	LTE B7	20	3199	2664.9	17.09	17.44	CA_7C
LTE B41	20	QPSK	1	0	40521	2583.1	LTE B41	20	40719	2602.9	15.32	15.42	CA_41C

Three Component Carrier Maximum Conducted Power																	
PCC						SCC				SCC				TX Power (dBm)		Configurations	
Band	BW (MHz)	Modulation	RB No.	RB offset	Channel	Frquency (MHz)	Band	BW (MHz)	Channel	Frquency (MHz)	Band	BW (MHz)	Channel	Frquency (MHz)	CA Active		CA Inactive
LTE B2	20	QPSK	1	0	18900	1880	LTE B2	20	1100	1980	LTE B4	20	2175	2132.5	21.86		21.88
LTE B2	20	QPSK	1	0	18900	1880	LTE B2	20	1100	1980	LTE B12	10	5155	743.5	21.86	21.88	CA_2A-2A-12A
LTE B2	20	QPSK	1	0	18900	1880	LTE B2	20	1100	1980	LTE B14	10	5330	763	21.85	21.88	CA_2A-2A-14A
LTE B2	20	QPSK	1	0	18900	1880	LTE B2	20	1100	1980	LTE B30	10	9820	2355	21.84	21.88	CA_2A-2A-30A
LTE B2	20	QPSK	1	0	18900	1880	LTE B2	20	1100	1980	LTE B66	20	66786	2145	21.87	21.88	CA_2A-2A-66A
LTE B2	20	QPSK	1	0	18900	1880	LTE B4	20	2300	2145	LTE B4	20	2300	2145	21.86	21.88	CA_2A-4A-4A
LTE B2	20	QPSK	1	0	18900	1880	LTE B4	20	2175	2132.5	LTE B5	10	2575	886.5	21.85	21.88	CA_2A-4A-5A
LTE B2	20	QPSK	1	0	18700	1860	LTE B4	20	2175	2132.5	LTE B7	20	3100	2655	21.82	21.85	CA_2A-4A-7A
LTE B2	20	QPSK	1	0	18700	1860	LTE B4	20	2175	2132.5	LTE B12	10	5155	743.5	21.81	21.85	CA_2A-4A-12A
LTE B2	20	QPSK	1	0	18700	1860	LTE B4	20	2175	2132.5	LTE B29	10	9715	722.5	21.83	21.85	CA_2A-4A-29A
LTE B2	20	QPSK	1	0	18700	1860	LTE B4	20	2175	2132.5	LTE B30	10	9820	2355	21.84	21.85	CA_2A-4A-30A
LTE B2	20	QPSK	1	0	18700	1860	LTE B5	10	2575	886.5	LTE B30	10	9820	2355	21.83	21.85	CA_2A-5A-30A
LTE B2	20	QPSK	1	0	18900	1880	LTE B5	10	2575	886.5	LTE B66	20	66786	2145	21.85	21.88	CA_2A-5A-66A
LTE B2	20	QPSK	1	0	18900	1880	LTE B7	20	2850	2630	LTE B7	20	3350	2680	21.87	21.88	CA_2A-7A-7A
LTE B2	20	QPSK	1	0	18900	1880	LTE B7	20	3100	2655	LTE B12	10	5155	743.5	21.85	21.88	CA_2A-7A-12A
LTE B2	20	QPSK	1	0	18900	1880	LTE B12	10	5155	743.5	LTE B30	10	9820	2355	21.85	21.88	CA_2A-12A-30A
LTE B2	20	QPSK	1	0	18900	1880	LTE B12	10	5155	743.5	LTE B66	20	66786	2145	21.84	21.88	CA_2A-12A-66A
LTE B2	20	QPSK	1	0	18900	1880	LTE B13	10	5230	751	LTE B66	20	66786	2145	21.84	21.88	CA_2A-13A-66A
LTE B2	20	QPSK	1	0	18900	1880	LTE B14	10	5330	763	LTE B30	10	9820	2355	21.80	21.88	CA_2A-14A-30A
LTE B2	20	QPSK	1	0	18900	1880	LTE B14	10	5330	763	LTE B66	20	66786	2145	21.86	21.88	CA_2A-14A-66A
LTE B2	20	QPSK	1	0	18900	1880	LTE B29	10	9715	722.5	LTE B30	10	9820	2355	21.81	21.88	CA_2A-29A-30A
LTE B2	20	QPSK	1	0	18900	1880	LTE B30	10	9820	2355	LTE B66	20	66786	2145	21.84	21.88	CA_2A-30A-66A
LTE B2	20	QPSK	1	0	18900	1880	LTE B46	20	46890	5160	LTE B46	20	54340	5905	21.83	21.88	CA_2A-46A-46A
LTE B2	20	QPSK	1	0	18900	1880	LTE B46	20	50690	5540	LTE B66	20	66985	2164.9	21.83	21.88	CA_2A-46A-66A
LTE B2	20	QPSK	1	0	18900	1880	LTE B46	20	54142	5885.2	LTE B46	20	54340	5905	21.85	21.88	CA_2A-46C
LTE B2	20	QPSK	1	0	18900	1880	LTE B48	20	55990	3625	LTE B66	20	66786	2145	21.85	21.88	CA_2A-48A-66A
LTE B2	20	QPSK	1	0	18900	1880	LTE B66	20	66985	2164.9	LTE B66	20	66985	2164.9	21.80	21.88	CA_2A-66A-66A
LTE B2	20	QPSK	1	0	18900	1880	LTE B66	20	67038	2170.2	LTE B66	20	67236	2190	21.83	21.88	CA_2A-66C
LTE B4	20	QPSK	1	0	20175	1732.5	LTE B4	20	2300	2145	LTE B5	10	2525	881.5	22.49	22.52	CA_4A-4A-5A
LTE B4	20	QPSK	1	0	20175	1732.5	LTE B4	20	2300	2145	LTE B12	10	5155	743.5	22.50	22.52	CA_4A-4A-12A

LTE B4	20	QPSK	1	0	20175	1732.5	LTE B5	10	2575	886.5	LTE B30	10	9820	2355	22.50	22.52	CA_4A-5A-30A
LTE B4	20	QPSK	1	0	20175	1732.5	LTE B7	20	2850	2630	LTE B7	20	3350	2680	22.48	22.52	CA_4A-7A-7A
LTE B4	20	QPSK	1	0	20175	1732.5	LTE B7	20	3100	2655	LTE B12	10	5155	743.5	22.51	22.52	CA_4A-7A-12A
LTE B4	20	QPSK	1	0	20175	1732.5	LTE B12	10	5155	743.5	LTE B30	10	9820	2355	22.51	22.52	CA_4A-12A-30A
LTE B4	20	QPSK	1	0	20175	1732.5	LTE B12	10	5048	732.8	LTE B12	10	5120	740	22.49	22.52	CA_4A-12B
LTE B4	20	QPSK	1	0	20175	1732.5	LTE B29	10	9715	722.5	LTE B30	10	9820	2355	22.50	22.52	CA_4A-29A-30A
LTE B4	20	QPSK	1	0	20175	1732.5	LTE B46	20	46890	5160	LTE B46	20	54340	5905	22.48	22.52	CA_4A-46A-46A
LTE B4	20	QPSK	1	0	20175	1732.5	LTE B46	20	54142	5885.2	LTE B46	20	54340	5905	22.47	22.52	CA_4A-46C
LTE B5	10	QPSK	1	0	20525	836.5	LTE B30	10	9820	2355	LTE B66	20	66786	2145	23.01	23.07	CA_5A-30A-66A
LTE B5	10	QPSK	1	0	20525	836.5	LTE B5	10	2575	886.5	LTE B66	20	66786	2145	23.05	23.07	CA_5A-5A-66A
LTE B5	10	QPSK	1	0	20525	836.5	LTE B66	20	66786	2145	LTE B66	20	66786	2145	23.05	23.07	CA_5A-66A-66A
LTE B5	10	QPSK	1	0	20525	836.5	LTE B66	20	67038	2170.2	LTE B66	20	67236	2190	23.04	23.07	CA_5A-66C
LTE B5	10	QPSK	1	0	20450	829	LTE B5	10	2476	876.6	LTE B66	20	66786	2145	23.03	23.06	CA_5B-66A
LTE B7	20	QPSK	1	0	21100	2535	LTE B66	20	66786	2145	LTE B66	20	66786	2145	17.50	17.55	CA_7A-66A-66A
LTE B12	10	QPSK	1	0	23095	707.5	LTE B30	10	9820	2355	LTE B66	20	66786	2145	22.61	22.64	CA_12A-30A-66A
LTE B12	10	QPSK	1	0	23095	707.5	LTE B66	20	67038	2170.2	LTE B66	20	67236	2190	22.61	22.64	CA_12A-66C
LTE B12	10	QPSK	1	0	23095	707.5	LTE B66	20	66786	2145	LTE B66	20	66786	2145	22.63	22.64	CA_12A-66A-66A
LTE B13	10	QPSK	1	0	23230	782	LTE B66	20	66786	2145	LTE B66	20	66786	2145	22.65	22.69	CA_13A-66A-66A
LTE B13	10	QPSK	1	0	23230	782	LTE B66	20	67038	2170.2	LTE B66	20	67236	2190	22.66	22.69	CA_13A-66C
LTE B14	10	QPSK	1	0	23330	793	LTE B30	10	9820	2355	LTE B66	20	66786	2145	22.80	22.81	CA_14A-30A-66A
LTE B14	10	QPSK	1	0	23330	793	LTE B66	20	66786	2145	LTE B66	20	66786	2145	22.79	22.81	CA_14A-66A-66A
LTE B30	10	QPSK	1	0	27710	2310	LTE B29	10	9715	722.5	LTE B66	20	66786	2145	18.66	18.69	CA_29A-30A-66A
LTE B66	20	QPSK	1	0	132322	1745	LTE B29	10	9715	722.5	LTE B66	20	66786	2145	22.49	22.61	CA_29A-66A-66A
LTE B30	10	QPSK	1	0	27710	2310	LTE B66	20	66786	2145	LTE B66	20	66786	2145	18.67	18.69	CA_30A-66A-66A
LTE B66	20	QPSK	1	0	132072	1720	LTE B46	20	54142	5885.2	LTE B46	20	54340	5905	22.40	22.50	CA_46C-66A
LTE B48	20	QPSK	1	0	55990	3625	LTE B48	20	55990	3625	LTE B66	20	66786	2145	13.79	13.82	CA_48A-48A-66A
LTE B48	20	QPSK	1	0	55990	3625	LTE B66	20	67038	2170.2	LTE B66	20	67236	2190	13.80	13.82	CA_48A-66C
LTE B66	20	QPSK	1	0	132072	1720	LTE B48	20	55891	3615.1	LTE B48	20	56089	3634.9	22.41	22.50	CA_48C-66A
LTE B48	20	QPSK	1	0	55990	3625	LTE B48	20	55792	3605.2	LTE B48	20	56188	3644.8	13.80	13.82	CA_48D
LTE B66	20	QPSK	1	0	132072	1720	LTE B66	20	66786	2145	LTE B66	20	66786	2145	22.41	22.50	CA_66A-66A-66A
LTE B66	20	QPSK	1	0	132072	1720	LTE B66	20	67038	2170.2	LTE B66	20	67236	2190	22.40	22.50	CA_66A-66C
LTE B66	20	QPSK	1	0	132224	1735.2	LTE B66	20	66886	2155	LTE B66	20	67084	2174.8	22.40	22.61	CA_66D

NR n2				ANT0				
BW (MHz)	Modulation	Channel		372000	376000	380000	MPR	Tine-up Limit (dBm)
		Frequency (MHz)		1860	1880	1900		
		RB No.	RB Offset	Measured Power (dBm)				
20M	PI/2 BPSK	1	#1	23.12	22.98	23.06	0	24
	QPSK	1	#1	23.56	23.61	23.50	0	24
		1	#Mid	23.07	22.94	22.98	0	24
		1	#Max	23.03	23.08	23.02	0	24
		50%	#0	23.05	22.91	22.74	0.5	23.5
		50%	#Mid	23.05	23.49	23.01	0	24
		50%	#Max	22.05	22.02	21.57	0.5	23.5
		100%	--	22.08	23.11	21.83	0.5	23.5
	16QAM	1	#1	21.96	21.93	21.97	1	23
	64QAM	1	#1	20.21	20.15	20.23	2.5	21.5
	256QAM	1	#1	18.56	18.55	18.57	4.5	19.5
	CP-OFDM QPSK	1	#1	22.35	22.47	22.31	1.5	22.5
BW (MHz)	Modulation	Channel		371500	376000	380500	MPR	Tine-up Limit (dBm)
		Frequency (MHz)		1857.5	1880	1902.5		
		RB No.	RB Offset	Measured Power (dBm)				
15M	PI/2 BPSK	1	#1	23.08	22.95	23.01	0	24
	QPSK	1	#1	23.18	22.97	23.03	0	24
		1	#Mid	23.03	22.91	22.92	0	24
		1	#Max	23.15	23.14	22.77	0	24
		50%	#0	21.98	21.88	21.91	0.5	23.5
		50%	#Mid	23.02	22.95	22.93	0	24
		50%	#Max	22.07	21.98	21.55	0.5	23.5
		100%	--	22.04	21.98	21.81	0.5	23.5
	16QAM	1	#1	21.91	21.92	21.94	1	23
	64QAM	1	#1	20.20	20.18	20.20	2.5	21.5
	256QAM	1	#1	18.58	18.46	18.47	4.5	19.5
	CP-OFDM QPSK	1	#1	22.11	22.14	22.13	1.5	22.5

BW (MHz)	Modulation	Channel		371000	376000	381000	MPR	Tine-up Limit (dBm)
		Frequency (MHz)		1855	1880	1905		
		RB No.	RB Offset	Measured Power (dBm)				
10M	PI/2 BPSK	1	#1	23.04	22.95	22.94	0	24
	QPSK	1	#1	23.08	23.14	23.04	0	24
		1	#Mid	23.03	22.90	22.97	0	24
		1	#Max	23.01	23.05	22.92	0	24
		50%	#0	22.01	21.96	22.04	0.5	23.5
		50%	#Mid	23.02	23.05	22.78	0	24
		50%	#Max	22.05	22.06	21.47	0.5	23.5
		100%	--	22.07	21.98	21.74	0.5	23.5
	16QAM	1	#1	21.95	21.90	21.93	1	23
	64QAM	1	#1	20.17	20.11	20.20	2.5	21.5
	256QAM	1	#1	18.44	18.49	18.46	4.5	19.5
	CP-OFDM QPSK	1	#1	22.09	22.12	22.07	1.5	22.5
BW (MHz)	Modulation	Channel		370500	376000	381500	MPR	Tine-up Limit (dBm)
		Frequency (MHz)		1852.5	1880	1907.5		
		RB No.	RB Offset	Measured Power (dBm)				
5M	PI/2 BPSK	1	#1	23.01	22.94	22.95	0	24
	QPSK	1	#1	23.07	23.18	23.02	0	24
		1	#Mid	23.05	22.89	22.91	0	24
		1	#Max	23.02	22.97	22.91	0	24
		50%	#0	22.04	21.99	21.95	0.5	23.5
		50%	#Mid	23.01	22.97	22.76	0	24
		50%	#Max	22.04	21.98	21.55	0.5	23.5
		100%	--	21.96	21.92	21.80	0.5	23.5
	16QAM	1	#1	21.90	21.92	21.91	1	23
	64QAM	1	#1	20.25	20.10	20.20	2.5	21.5
	256QAM	1	#1	18.51	18.54	15.54	4.5	19.5
	CP-OFDM QPSK	1	#1	22.05	22.08	22.03	1.5	22.5

NR n5				ANT0					ANT2				
BW (MHz)	Modulation	Channel		166800	167300	167800	MPR	Tine-up Limit (dBm)	166800	167300	167800	MPR	Tine-up Limit (dBm)
		Frequency (MHz)		834	836.5	839			834	836.5	839		
		RB No.	RB Offset	Measured Power (dBm)					Measured Power (dBm)				
20M	PI/2 BPSK	1	#1	23.14	23.09	23.05	0	24	22.91	22.84	22.86	0	24
	QPSK	1	#1	23.18	23.22	23.15	0	24	23.02	23.03	22.98	0	24
		1	#Mid	22.55	22.54	22.58	0	24	22.91	22.94	22.84	0	24
		1	#Max	23.02	23.08	23.04	0	24	22.85	22.87	22.83	0	24
		50%	#0	22.14	22.15	22.13	0.5	23.5	22.10	22.13	22.11	0.5	23.5
		50%	#Mid	22.24	22.55	22.21	0	24	22.84	22.85	22.87	0	24
		50%	#Max	22.14	22.18	22.16	0.5	23.5	21.95	21.91	21.94	0.5	23.5
		100%	--	22.31	22.37	22.32	0.5	23.5	21.54	21.58	21.56	0.5	23.5
	16QAM	1	#1	22.21	22.26	22.18	1	23	22.19	22.01	21.98	1	23
	64QAM	1	#1	20.43	20.41	20.32	2.5	21.5	20.68	20.52	20.48	2.5	21.5
	256QAM	1	#1	18.75	18.64	18.65	4.5	19.5	18.67	18.55	18.51	4.5	19.5
CP-OFDM QPSK	1	#1	22.27	22.35	22.26	1.5	22.5	22.25	22.31	22.22	1.5	22.5	
BW (MHz)	Modulation	Channel		166300	167300	168300	MPR	Tine-up Limit (dBm)	166300	167300	168300	MPR	Tine-up Limit (dBm)
		Frequency (MHz)		831.5	836.5	841.5			831.5	836.5	841.5		
		RB No.	RB Offset	Measured Power (dBm)					Measured Power (dBm)				
15M	PI/2 BPSK	1	#1	23.12	23.01	23.01	0	24	22.73	22.75	22.72	0	24
	QPSK	1	#1	23.13	23.14	23.02	0	24	22.97	22.92	22.86	0	24
		1	#Mid	22.49	22.50	22.48	0	24	22.88	22.92	22.81	0	24
		1	#Max	22.98	23.05	22.97	0	24	22.81	22.84	22.79	0	24
		50%	#0	22.08	22.12	22.11	0.5	23.5	22.06	22.07	22.05	0.5	23.5
		50%	#Mid	22.24	22.25	22.14	0	24	22.74	22.76	22.77	0	24
		50%	#Max	22.11	22.14	22.13	0.5	23.5	21.94	21.88	21.92	0.5	23.5
		100%	--	22.26	22.27	22.28	0.5	23.5	21.52	21.55	21.51	0.5	23.5
	16QAM	1	#1	22.17	22.17	22.16	1	23	22.15	22.00	21.94	1	23
	64QAM	1	#1	20.41	20.31	20.35	2.5	21.5	20.53	20.51	20.36	2.5	21.5
	256QAM	1	#1	18.70	18.66	18.59	4.5	19.5	18.55	18.66	18.54	4.5	19.5
CP-OFDM QPSK	1	#1	22.22	22.33	22.18	1.5	22.5	22.18	22.28	22.14	1.5	22.5	

BW (MHz)	Modulation	Channel		165800	167300	168800	MPR	Tine-up Limit (dBm)	165800	167300	168800	MPR	Tine-up Limit (dBm)
		Frequency (MHz)		829	836.5	844			829	836.5	844		
		RB No.	RB Offset	Measured Power (dBm)					Measured Power (dBm)				
10M	PI/2 BPSK	1	#1	23.01	23.05	22.94	0	24	22.76	22.77	22.75	0	24
	QPSK	1	#1	23.06	23.08	22.98	0	24	22.92	22.87	22.82	0	24
		1	#Mid	22.45	22.50	22.51	0	24	22.89	22.85	22.78	0	24
		1	#Max	22.94	22.92	22.95	0	24	22.83	22.81	22.73	0	24
		50%	#0	22.11	22.15	21.98	0.5	23.5	21.98	22.09	21.92	0.5	23.5
		50%	#Mid	22.13	22.35	22.14	0	24	22.73	22.74	22.71	0	24
		50%	#Max	22.12	21.98	21.39	0.5	23.5	21.91	21.89	21.90	0.5	23.5
		100%	--	22.18	22.08	22.24	0.5	23.5	21.54	21.53	21.52	0.5	23.5
	16QAM	1	#1	22.23	22.17	22.04	1	23	22.11	21.99	21.96	1	23
	64QAM	1	#1	20.42	20.37	20.28	2.5	21.5	20.49	20.39	20.28	2.5	21.5
	256QAM	1	#1	18.71	18.69	18.52	4.5	19.5	18.59	18.50	18.41	4.5	19.5
CP-OFDM QPSK	1	#1	22.14	22.25	22.10	1.5	22.5	22.11	22.25	22.13	1.5	22.5	
BW (MHz)	Modulation	Channel		165300	167300	169300	MPR	Tine-up Limit (dBm)	165300	167300	169300	MPR	Tine-up Limit (dBm)
		Frequency (MHz)		826.5	836.5	846.5			826.5	836.5	846.5		
		RB No.	RB Offset	Measured Power (dBm)					Measured Power (dBm)				
5M	PI/2 BPSK	1	#1	23.02	23.01	23.03	0	24	22.66	22.67	22.71	0	24
	QPSK	1	#1	22.44	22.51	22.49	0	24	22.96	22.78	22.69	0	24
		1	#Mid	22.45	22.93	22.52	0	24	22.89	22.85	22.92	0	24
		1	#Max	23.01	22.93	22.90	0	24	22.84	22.86	22.81	0	24
		50%	#0	22.14	22.18	22.05	0.5	23.5	22.03	22.04	22.01	0.5	23.5
		50%	#Mid	23.15	22.36	22.97	0	24	22.75	22.77	22.73	0	24
		50%	#Max	22.00	22.07	21.92	0.5	23.5	21.88	21.86	21.84	0.5	23.5
		100%	--	22.12	22.14	21.97	0.5	23.5	21.52	21.55	21.53	0.5	23.5
	16QAM	1	#1	22.14	22.15	22.14	1	23	22.13	21.95	21.93	1	23
	64QAM	1	#1	20.47	20.41	20.12	2.5	21.5	20.66	20.49	20.44	2.5	21.5
	256QAM	1	#1	18.72	18.68	18.56	4.5	19.5	18.61	18.49	18.43	4.5	19.5
CP-OFDM QPSK	1	#1	21.83	21.92	21.82	1.5	22.5	22.09	22.24	22.12	1.5	22.5	

NR n66				ANT0				
BW (MHz)	Modulation	Channel		346000	349000	352000	MPR	Tine-up Limit (dBm)
		Frequency (MHz)		1730	1745	1760		
		RB No.	RB Offset	Measured Power (dBm)				
40M	PI/2 BPSK	1	#1	22.28	22.38	22.38	0	23
	QPSK	1	#1	22.39	22.55	22.51	0	23
		1	#Mid	22.22	22.15	22.11	0	23
		1	#Max	22.38	22.13	21.99	0	23
		50%	#0	22.04	22.00	21.95	0.5	22.5
		50%	#Mid	22.30	22.32	22.00	0	23
		50%	#Max	22.08	21.81	21.85	0.5	22.5
		100%	--	21.28	21.36	21.15	0.5	22.5
	16QAM	1	#1	21.83	21.87	21.81	1	22
	64QAM	1	#1	20.34	20.35	20.36	2.5	20.5
	256QAM	1	#1	18.33	18.35	18.32	4.5	18.5
	CP-OFDM QPSK	1	#1	21.13	21.25	21.10	1.5	21.5
BW (MHz)	Modulation	Channel		344000	349000	354000	MPR	Tine-up Limit (dBm)
		Frequency (MHz)		1720	1745	1770		
		RB No.	RB Offset	Measured Power (dBm)				
20M	PI/2 BPSK	1	#1	22.25	22.26	22.17	0	23
	QPSK	1	#1	22.25	22.15	22.03	0	23
		1	#Mid	22.17	22.12	21.88	0	23
		1	#Max	22.14	22.11	21.35	0	23
		50%	#0	22.01	21.96	21.76	0.5	22.5
		50%	#Mid	22.09	21.92	21.81	0	23
		50%	#Max	22.04	21.74	21.59	0.5	22.5
		100%	--	22.15	21.29	21.10	0.5	22.5
	16QAM	1	#1	21.76	21.77	21.72	1	22
	64QAM	1	#1	20.25	20.27	20.23	2.5	20.5
	256QAM	1	#1	18.15	18.16	18.13	4.5	18.5
	CP-OFDM QPSK	1	#1	20.95	21.16	20.97	1.5	21.5

BW (MHz)	Modulation	Channel		343500	349000	354500	MPR	Tine-up Limit (dBm)
		Frequency (MHz)		1717.5	1745	1772.5		
		RB No.	RB Offset	Measured Power (dBm)				
15M	PI/2 BPSK	1	#1	22.28	22.35	22.33	0	23
	QPSK	1	#1	22.29	22.16	22.14	0	23
		1	#Mid	22.14	22.10	22.07	0	23
		1	#Max	22.33	22.11	21.79	0	23
		50%	#0	22.01	21.98	21.86	0.5	22.5
		50%	#Mid	22.10	21.99	21.72	0	23
		50%	#Max	22.03	21.75	21.59	0.5	22.5
		100%	--	21.18	21.26	21.11	0.5	22.5
	16QAM	1	#1	21.73	21.71	21.72	1	22
	64QAM	1	#1	20.22	20.25	20.23	2.5	20.5
	256QAM	1	#1	18.21	18.25	18.21	4.5	18.5
CP-OFDM QPSK	1	#1	20.92	20.98	20.94	1.5	21.5	
BW (MHz)	Modulation	Channel		343000	349000	355000	MPR	Tine-up Limit (dBm)
		Frequency (MHz)		1715	1745	1775		
		RB No.	RB Offset	Measured Power (dBm)				
10M	PI/2 BPSK	1	#1	22.24	22.23	22.05	0	23
	QPSK	1	#1	22.03	22.03	22.01	0	23
		1	#Mid	22.06	22.07	21.98	0	23
		1	#Max	22.24	22.12	21.85	0	23
		50%	#0	21.92	21.95	21.91	0.5	22.5
		50%	#Mid	22.04	22.05	21.71	0	23
		50%	#Max	22.08	21.71	21.69	0.5	22.5
		100%	--	21.20	21.16	21.08	0.5	22.5
	16QAM	1	#1	21.74	21.75	21.72	1	22
	64QAM	1	#1	20.21	20.27	20.25	2.5	20.5
	256QAM	1	#1	18.17	18.21	18.16	4.5	18.5
CP-OFDM QPSK	1	#1	20.91	20.96	20.89	1.5	21.5	

BW (MHz)	Modulation	Channel		342500	349000	355500	MPR	Tine-up Limit (dBm)
		Frequency (MHz)		1712.5	1745	1777.5		
		RB No.	RB Offset	Measured Power (dBm)				
5M	PI/2 BPSK	1	#1	22.12	22.15	22.07	0	23
	QPSK	1	#1	22.19	21.78	21.94	0	23
		1	#Mid	22.21	21.89	21.61	0	23
		1	#Max	22.15	21.83	21.43	0	23
		50%	#0	22.03	21.97	21.92	0.5	22.5
		50%	#Mid	22.11	21.01	21.75	0	23
		50%	#Max	22.09	21.70	21.74	0.5	22.5
		100%	--	21.02	21.05	21.13	0.5	22.5
	16QAM	1	#1	21.76	21.78	21.77	1	22
	64QAM	1	#1	20.25	20.28	20.22	2.5	20.5
	256QAM	1	#1	18.05	18.12	18.07	4.5	18.5
	CP-OFDM QPSK	1	#1	20.77	20.85	20.76	1.5	21.5

NR n71				ANT0					ANT2				
BW (MHz)	Modulation	Channel		134600	136100	137600	MPR	Tine-up Limit (dBm)	134600	136100	137600	MPR	Tine-up Limit (dBm)
		Frequency (MHz)		673	680.5	688			673	680.5	688		
		RB No.	RB Offset	Measured Power (dBm)					Measured Power (dBm)				
20M	PI/2 BPSK	1	#1	22.28	22.37	22.34	0	24	22.26	22.16	22.11	0	24
	QPSK	1	#1	22.65	22.75	22.62	0	24	22.56	22.57	22.48	0	24
		1	#Mid	22.59	22.49	22.33	0	24	22.50	22.56	22.45	0	24
		1	#Max	22.56	22.54	22.56	0	24	22.55	22.35	22.12	0	24
		50%	#0	21.75	21.70	21.66	0.5	23.5	21.76	21.63	21.51	0.5	23.5
		50%	#Mid	22.63	22.64	22.61	0	24	22.54	22.54	22.39	0	24
		50%	#Max	22.04	22.03	22.05	0.5	23.5	22.14	22.17	22.13	0.5	23.5
		100%	--	21.66	21.68	21.65	0.5	23.5	22.04	22.08	22.06	0.5	23.5
	16QAM	1	#1	22.01	22.07	21.99	1	23	22.19	22.14	21.94	1	23
	64QAM	1	#1	20.51	20.37	20.32	2.5	21.5	20.68	20.51	20.44	2.5	21.5
	256QAM	1	#1	18.75	18.69	18.66	4.5	19.5	18.67	18.54	18.44	4.5	19.5
CP-OFDM QPSK	1	#1	22.35	22.48	22.33	1.5	22.5	22.34	22.45	22.31	1.5	22.5	
BW (MHz)	Modulation	Channel		134100	136100	138100	MPR	Tine-up Limit (dBm)	134100	136100	138100	MPR	Tine-up Limit (dBm)
		Frequency (MHz)		670.5	680.5	690.5			670.5	680.5	690.5		
		RB No.	RB Offset	Measured Power (dBm)					Measured Power (dBm)				
15M	PI/2 BPSK	1	#1	22.21	22.25	22.21	0	24	22.21	22.12	22.08	0	24
	QPSK	1	#1	22.63	22.64	22.51	0	24	22.44	22.47	22.40	0	24
		1	#Mid	22.52	22.43	22.29	0	24	22.43	22.46	22.35	0	24
		1	#Max	22.41	22.44	22.50	0	24	22.47	22.25	22.02	0	24
		50%	#0	21.70	21.58	21.54	0.5	23.5	21.62	21.60	21.50	0.5	23.5
		50%	#Mid	22.59	22.51	22.48	0	24	22.43	22.44	22.29	0	24
		50%	#Max	22.01	22.01	20.05	0.5	23.5	21.71	21.76	21.73	0.5	23.5
		100%	--	21.64	21.55	21.53	0.5	23.5	21.84	21.91	21.88	0.5	23.5
	16QAM	1	#1	21.99	22.05	21.97	1	23	22.10	22.04	21.84	1	23
	64QAM	1	#1	20.42	20.29	20.22	2.5	21.5	20.55	20.41	20.36	2.5	21.5
	256QAM	1	#1	18.71	18.56	18.47	4.5	19.5	18.56	18.44	18.33	4.5	19.5
CP-OFDM QPSK	1	#1	22.27	22.39	22.25	1.5	22.5	22.24	22.32	22.28	1.5	22.5	

BW (MHz)	Modulation	Channel		133600	136100	138600	MPR	Tine-up Limit (dBm)	133600	136100	138600	MPR	Tine-up Limit (dBm)
		Frequency (MHz)		668	680.5	693			668	680.5	693		
		RB No.	RB Offset	Measured Power (dBm)					Measured Power (dBm)				
10M	PI/2 BPSK	1	#1	22.11	22.15	22.11	0	24	22.10	22.08	22.06	0	24
	QPSK	1	#1	22.53	22.54	22.41	0	24	22.33	22.34	22.33	0	24
		1	#Mid	22.52	22.41	22.19	0	24	22.32	22.33	22.24	0	24
		1	#Max	22.33	22.48	22.40	0	24	22.34	22.16	22.03	0	24
		50%	#0	21.63	21.48	21.44	0.5	23.5	21.53	21.55	21.50	0.5	23.5
		50%	#Mid	22.49	22.41	22.38	0	24	22.35	22.36	22.20	0	24
		50%	#Max	22.04	22.01	22.03	0.5	23.5	21.61	21.68	21.66	0.5	23.5
		100%	--	21.54	21.55	21.56	0.5	23.5	21.75	21.88	21.75	0.5	23.5
	16QAM	1	#1	21.96	22.05	21.91	1	23	21.93	21.94	21.71	1	23
	64QAM	1	#1	20.32	20.19	20.12	2.5	21.5	20.40	20.35	20.26	2.5	21.5
256QAM	1	#1	18.61	18.46	18.37	4.5	19.5	18.46	18.33	18.23	4.5	19.5	
CP-OFDM QPSK	1	#1	22.24	22.34	22.20	1.5	22.5	22.23	22.31	22.25	1.5	22.5	
BW (MHz)	Modulation	Channel		133100	136100	139100	MPR	Tine-up Limit (dBm)	133100	136100	139100	MPR	Tine-up Limit (dBm)
		Frequency (MHz)		665.5	680.5	695.5			665.5	680.5	695.5		
		RB No.	RB Offset	Measured Power (dBm)					Measured Power (dBm)				
5M	PI/2 BPSK	1	#1	22.01	22.05	22.03	0	24	22.06	22.07	22.04	0	24
	QPSK	1	#1	22.43	22.44	22.28	0	24	22.21	22.26	22.25	0	24
		1	#Mid	22.42	22.39	22.06	0	24	22.18	22.21	22.16	0	24
		1	#Max	22.23	22.28	22.27	0	24	22.03	22.08	22.05	0	24
		50%	#0	21.53	21.50	21.52	0.5	23.5	21.53	21.51	21.50	0.5	23.5
		50%	#Mid	22.39	22.31	22.25	0	24	22.23	22.28	22.15	0	24
		50%	#Max	21.94	21.97	21.94	0.5	23.5	21.55	21.60	21.57	0.5	23.5
		100%	--	21.54	21.55	21.53	0.5	23.5	21.72	21.78	21.68	0.5	23.5
	16QAM	1	#1	22.03	21.95	21.78	1	23	21.76	21.81	21.62	1	23
	64QAM	1	#1	20.22	20.09	19.99	2.5	21.5	20.19	20.22	20.20	2.5	21.5
256QAM	1	#1	18.51	18.36	18.24	4.5	19.5	18.20	18.23	18.15	4.5	19.5	
CP-OFDM QPSK	1	#1	22.21	22.28	22.17	1.5	22.5	22.22	22.36	22.22	1.5	22.5	

9. Test Results

9.1 SAR Test Results Summary

WCDMA B2 Body SAR								
SAR MEASUREMENT								
Liquid Temperature (°C): 22.1 ±2					Relative Humidity (%): 51			
Ambient Temperature (°C): 22.6 ±2					Depth of Liquid (cm):>15			
Test Position	Dist (mm)	Frequency		Conducted Power (dBm)		SAR 1g (W/kg)		Plot No.
		Channel	MHz	Measurement	Tune-up Limit	Measurement	Tune-up Scaled	
Test Mode: WCDMA Band 2 RMC_ANT0_5mm								
Front	5	9262	1852.4	21.87	23	0.806	1.046	
Front	5	9400	1880	22.11	23	0.818	1.004	
Front	5	9538	1907.6	21.83	23	0.833	1.091	1
Back	5	9400	1880	22.11	23	0.082	0.101	
Left-side	5	9400	1880	22.11	23	0.136	0.167	
Right-side	5	9262	1852.4	21.87	23	0.730	0.947	
Right-side	5	9400	1880	22.11	23	0.742	0.911	
Right-side	5	9538	1907.6	21.83	23	0.755	0.988	
Tip	5	9400	1880	22.11	23	0.124	0.152	
Note: 1. When the reported SAR of the Mid channel for the exposure configuration is ≤ 0.8 W/kg, no further SAR testing is required in other channel.								

WCDMA B4 Body SAR								
SAR MEASUREMENT								
Liquid Temperature (°C): 21.6 ±2					Relative Humidity (%): 51			
Ambient Temperature (°C): 22.5 ±2					Depth of Liquid (cm):>15			
Test Position	Dist (mm)	Frequency		Conducted Power (dBm)		SAR 1g (W/kg)		Plot No.
		Channel	MHz	Measurement	Tune-up Limit	Measurement	Tune-up Scaled	
Test Mode: WCDMA Band 4 RMC_ANT0_5mm								
Front	5	1312	1712.4	21.55	22.5	0.735	0.915	
Front	5	1413	1732.6	21.66	22.5	0.817	0.991	
Front	5	1513	1752.6	21.64	22.5	0.875	1.067	2
Back	5	1413	1732.6	21.66	22.5	0.192	0.233	
Left-side	5	1413	1732.6	21.66	22.5	0.111	0.135	
Right-side	5	1413	1732.6	21.66	22.5	0.535	0.649	
Tip	5	1413	1732.6	21.66	22.5	0.080	0.097	
Note: 1. When the reported SAR of the Mid channel for the exposure configuration is ≤ 0.8 W/kg, no further SAR testing is required in other channel.								

WCDMA B5 Body SAR								
SAR MEASUREMENT								
Liquid Temperature (°C): 22.1 ±2					Relative Humidity (%): 51			
Ambient Temperature (°C): 22.8 ±2					Depth of Liquid (cm):>15			
Test Position	Dist (mm)	Frequency		Conducted Power (dBm)		SAR 1g (W/kg)		Plot No.
		Channel	MHz	Measurement	Tune-up Limit	Measurement	Tune-up Scaled	
Test Mode: WCDMA Band 5 RMC_ANT0_5mm								
Front	5	4132	826.4	23.15	25	0.702	1.075	3
Front	5	4183	836.6	23.56	25	0.676	0.942	
Front	5	4233	846.6	23.06	25	0.645	1.008	
Back	5	4183	836.6	23.56	25	0.057	0.079	
Left-side	5	4183	836.6	23.56	25	0.034	0.048	
Right-side	5	4183	836.6	23.56	25	0.568	0.791	
Tip	5	4183	836.6	23.56	25	0.140	0.195	
Note: 1. When the reported SAR of the Mid channel for the exposure configuration is ≤ 0.8 W/kg, no further SAR testing is required in other channel.								

LTE Band 2 Body SAR										
SAR MEASUREMENT										
Liquid Temperature (°C): 22.1 ±2							Relative Humidity (%): 51			
Ambient Temperature (°C): 22.6 ±2							Depth of Liquid (cm): >15			
Test Position	Dist (mm)	RB	RB offset	Frequency		Conducted Power (dBm)		SAR 1g (W/Kg)		Plot No.
				Channel	MHz	Measurement	Tune-up Limit	Measurement	Tune-up Scaled	
Test Mode: LTE Band 2 QPSK 20M Ant 0_5mm										
Front	5	1	0	18700	1860	21.85	23	0.794	1.035	
Front	5	1	0	18900	1880	21.88	23	0.826	1.069	4
Front	5	1	0	19100	1900	21.84	23	0.804	1.050	
Front	5	50	0	18700	1860	21.84	23	0.745	0.973	
Front	5	50	0	18900	1880	21.85	23	0.714	0.930	
Front	5	50	0	19100	1900	21.82	23	0.766	1.005	
Front	5	100	0	18900	1880	21.85	23	0.569	0.742	
Back	5	1	0	18900	1880	21.88	23	0.075	0.097	
Left-side	5	1	0	18900	1880	21.88	23	0.142	0.184	
Right-side	5	1	0	18700	1860	21.85	23	0.620	0.808	
Right-side	5	1	0	18900	1880	21.88	23	0.629	0.814	
Right-side	5	1	0	19100	1900	21.84	23	0.638	0.833	
Right-side	5	50	0	18900	1880	21.85	23	0.593	0.773	
Right-side	5	100	0	18900	1880	21.85	23	0.658	0.857	
Tip	5	1	0	18900	1880	21.88	23	0.111	0.144	
Note: 1. When the reported SAR of the Mid channel for the exposure configuration is ≤ 0.8 W/kg, no further SAR testing is required in other channel.										

LTE Band 5 Body SAR										
SAR MEASUREMENT										
Liquid Temperature (°C): 22.1 ±2							Relative Humidity (%): 51			
Ambient Temperature (°C): 22.8 ±2							Depth of Liquid (cm): >15			
Test Position	Dist (mm)	RB	RB offset	Frequency		Conducted Power (dBm)		SAR 1g (W/Kg)		Plot No.
				Channel	MHz	Measurement	Tune-up Limit	Measurement	Tune-up Scaled	
Test Mode: LTE Band 5 QPSK 10M QPSK 20M_ANT0_5mm										
Front	5	1	0	20450	829	23.06	24	0.717	0.890	5
Front	5	1	0	20525	836.5	23.07	24	0.653	0.809	
Front	5	1	0	20600	844	22.88	24	0.678	0.877	
Front	5	25	0	20525	836.5	21.87	23	0.634	0.822	
Front	5	50	0	20525	836.5	21.81	23	0.631	0.830	
Back	5	1	0	20525	836.5	23.07	24	0.056	0.069	
Left-side	5	1	0	20525	836.5	23.07	24	0.041	0.050	
Right-side	5	1	0	20525	836.5	23.07	24	0.543	0.673	
Tip	5	1	0	20525	836.5	23.07	24	0.139	0.172	
Test Mode: LTE Band 5 QPSK 10M QPSK 20M_ANT2_5mm										
Front	5	1	0	20525	836.5	23.03	24	0.055	0.069	
Back	5	1	0	20525	836.5	23.03	24	0.018	0.023	
Left-side	5	1	0	20525	836.5	23.03	24	0.116	0.145	
Left-side	5	25	0	20525	836.5	21.78	23	0.113	0.150	
Right-side	5	1	0	20525	836.5	23.03	24	0.00633	0.008	
Tip	5	1	0	20525	836.5	23.03	24	0.055	0.068	
Test Mode: LTE Band 5B 20M_ANT0_5mm										
Front	5	1	0	20476	836.5	23.02	24	0.587	0.736	
Note: 1. When the reported SAR of the Mid channel for the exposure configuration is ≤ 0.8 W/kg, no further SAR testing is required in other channel.										

LTE Band 7 Body SAR**SAR MEASUREMENT**

Liquid Temperature (°C): 22.1 ±2

Relative Humidity (%): 50

Ambient Temperature (°C): 22.6 ±2

Depth of Liquid (cm): >15

Test Position	Dist (mm)	RB	RB offset	Frequency		Conducted Power (dBm)		SAR 1g (W/Kg)		Plot No.
				Channel	MHz	Measurement	Tune-up Limit	Measurement	Tune-up Scaled	
Test Mode: LTE Band 7 QPSK 20M_ANT0_5mm										
Front	5	1	0	20850	2510	17.12	18.5	0.733	1.007	
Front	5	1	0	21100	2535	17.55	18.5	0.823	1.024	
Front	5	1	0	21350	2560	17.45	18.5	0.867	1.104	6
Front	5	50	0	20850	2510	17.09	18.5	0.712	0.985	
Front	5	50	0	21100	2535	17.28	18.5	0.735	0.973	
Front	5	50	0	21350	2560	17.27	18.5	0.821	1.090	
Front	5	100	0	21100	2535	17.13	18.5	0.792	1.086	
Back	5	1	0	21100	2535	17.55	18.5	0.014	0.018	
Left-side	5	1	0	21100	2535	17.55	18.5	0.028	0.034	
Right-side	5	1	0	21100	2535	17.55	18.5	0.594	0.739	
Tip	5	1	0	21100	2535	17.55	18.5	0.029	0.036	
Test Mode: LTE Band 7C 20M_ANT0_5mm										
Front	5	1	0	21001	2535	17.44	18.5	0.751	0.959	

Note: 1. When the reported SAR of the Mid channel for the exposure configuration is ≤ 0.8 W/kg, no further SAR testing is required in other channel.

LTE Band 12 Body SAR										
SAR MEASUREMENT										
Liquid Temperature (°C): 21.8 ±2							Relative Humidity (%): 50			
Ambient Temperature (°C): 22.6 ±2							Depth of Liquid (cm): >15			
Test Position	Dist (mm)	RB	RB offset	Frequency		Conducted Power (dBm)		SAR 1g (W/Kg)		Plot No.
				Channel	MHz	Measurement	Tune-up Limit	Measurement	Tune-up Scaled	
Test Mode: LTE Band 12 QPSK 10M_ANT0_5mm										
Front	5	1	0	23060	704	22.51	24	0.606	0.854	
Front	5	1	0	23095	707.5	22.64	24	0.625	0.855	7
Front	5	1	0	23130	711	22.62	24	0.619	0.851	
Front	5	25	0	23095	707.5	21.49	23	0.552	0.782	
Back	5	1	0	23095	707.5	22.64	24	0.034	0.047	
Left-side	5	1	0	23095	707.5	22.64	24	0.026	0.035	
Right-side	5	1	0	23095	707.5	22.64	24	0.517	0.707	
Tip	5	1	0	23095	707.5	22.64	24	0.078	0.106	
Test Mode: LTE Band 12 QPSK 10M_ANT2_5mm										
Front	5	1	0	23095	707.5	22.49	24	0.045	0.064	
Back	5	1	0	23095	707.5	22.49	24	0.014	0.020	
Left-side	5	1	0	23095	707.5	22.49	24	0.069	0.097	
Left-side	5	25	0	23095	707.5	21.34	23	0.065	0.095	
Right-side	5	1	0	23095	707.5	22.49	24	0.00614	0.009	
Tip	5	1	0	23095	707.5	22.49	24	0.046	0.065	
Note: 1. When the reported SAR of the Mid channel for the exposure configuration is ≤ 0.8 W/kg, no further SAR testing is required in other channel.										

LTE Band 13 Body SAR										
SAR MEASUREMENT										
Liquid Temperature (°C): 21.8 ±2							Relative Humidity (%): 50			
Ambient Temperature (°C): 22.6 ±2							Depth of Liquid (cm): >15			
Test Position	Dist (mm)	RB	RB offset	Frequency		Conducted Power (dBm)		SAR 1g (W/Kg)		Plot No.
				Channel	MHz	Measurement	Tune-up Limit	Measurement	Tune-up Scaled	
Test Mode: LTE Band 13 QPSK 10M_ANT0_5mm										
Front	5	1	0	23230	782	22.69	24	0.756	1.022	8
Front	5	25	0	23230	782	21.51	23	0.661	0.932	
Front	5	50	0	23230	782	21.52	23	0.668	0.939	
Back	5	1	0	23230	782	22.69	24	0.055	0.074	
Left-side	5	1	0	23230	782	22.69	24	0.041	0.056	
Right-side	5	1	0	23230	782	22.69	24	0.587	0.794	
Tip	5	1	0	23230	782	22.69	24	0.150	0.203	
Test Mode: LTE Band 13 QPSK 10M_ANT2_5mm										
Front	5	1	0	23230	782	22.97	24	0.033	0.042	
Back	5	1	0	23230	782	22.97	24	0.013	0.016	
Left-side	5	1	0	23230	782	22.97	24	0.064	0.081	
Left-side	5	25	0	23230	782	21.68	23	0.077	0.104	
Right-side	5	1	0	23230	782	22.97	24	0.00563	0.007	
Tip	5	1	0	23230	782	22.97	24	0.041	0.052	
Note: 1. When the reported SAR of the Mid channel for the exposure configuration is ≤ 0.8 W/kg, no further SAR testing is required in other channel.										

LTE Band 14 Body SAR										
SAR MEASUREMENT										
Liquid Temperature (°C): 21.8 ±2							Relative Humidity (%): 50			
Ambient Temperature (°C): 22.6 ±2							Depth of Liquid (cm): >15			
Test Position	Dist (mm)	RB	RB offset	Frequency		Conducted Power (dBm)		SAR 1g (W/Kg)		Plot No.
				Channel	MHz	Measurement	Tune-up Limit	Measurement	Tune-up Scaled	
Test Mode: LTE Band 14 QPSK 10M_ANT0_5mm										
Front	5	1	0	23330	793	22.81	24	0.751	0.988	9
Front	5	25	0	23330	793	21.63	23	0.578	0.792	
Front	5	50	0	23330	793	21.56	23	0.565	0.787	
Back	5	1	0	23330	793	22.81	24	0.059	0.077	
Left-side	5	1	0	23330	793	22.81	24	0.041	0.054	
Right-side	5	1	0	23330	793	22.81	24	0.590	0.776	
Tip	5	1	0	23330	793	22.81	24	0.153	0.201	
Test Mode: LTE Band 14 QPSK 10M_ANT2_5mm										
Front	5	1	0	23330	793	22.77	24	0.038	0.050	
Back	5	1	0	23330	793	22.77	24	0.015	0.020	
Left-side	5	1	0	23330	793	22.77	24	0.084	0.112	
Left-side	5	25	0	23330	793	21.68	23	0.073	0.099	
Right-side	5	1	0	23330	793	22.77	24	0.00654	0.009	
Tip	5	1	0	23330	793	22.77	24	0.046	0.061	
Note: 1. When the reported SAR of the Mid channel for the exposure configuration is ≤ 0.8 W/kg, no further SAR testing is required in other channel.										

LTE Band 25 Body SAR										
SAR MEASUREMENT										
Liquid Temperature (°C): 22.1 ±2							Relative Humidity (%): 51			
Ambient Temperature (°C): 22.6 ±2							Depth of Liquid (cm): >15			
Test Position	Dist (mm)	RB	RB offset	Frequency		Conducted Power (dBm)		SAR 1g (W/Kg)		Plot No.
				Channel	MHz	Measurement	Tune-up Limit	Measurement	Tune-up Scaled	
Test Mode: LTE Band 25 QPSK 20M_ANT0_5mm										
Front	5	1	0	26140	1860	21.71	23	0.782	1.052	10
Front	5	1	0	26365	1882.5	21.87	23	0.739	0.959	
Front	5	1	0	26590	1905	21.58	23	0.720	0.998	
Front	5	50	0	26140	1860	21.84	23	0.728	0.951	
Front	5	50	0	26365	1882.5	21.85	23	0.735	0.958	
Front	5	50	0	26590	1905	21.84	23	0.661	0.863	
Front	5	100	0	26365	1882.5	21.79	23	0.720	0.951	
Back	5	1	0	26365	1882.5	21.87	23	0.070	0.091	
Left-side	5	1	0	26365	1882.5	21.87	23	0.056	0.073	
Right-side	5	1	0	26365	1882.5	21.87	23	0.634	0.822	
Tip	5	1	0	26365	1882.5	21.87	23	0.114	0.148	
Note: 1. When the reported SAR of the Mid channel for the exposure configuration is ≤ 0.8 W/kg, no further SAR testing is required in other channel.										

LTE Band 26 Body SAR										
SAR MEASUREMENT										
Liquid Temperature (°C): 22.2 ±2							Relative Humidity (%): 50			
Ambient Temperature (°C): 22.8 ±2							Depth of Liquid (cm): >15			
Test Position	Dist (mm)	RB	RB offset	Frequency		Conducted Power (dBm)		SAR 1g (W/Kg)		Plot No.
				Channel	MHz	Measurement	Tune-up Limit	Measurement	Tune-up Scaled	
Test Mode: LTE Band 26 QPSK 15M_ANT0_5mm										
Front	5	1	0	26865	831.5	22.52	24	0.717	1.008	11
Front	5	1	0	26915	836.5	22.53	24	0.625	0.877	
Front	5	1	0	26965	841.5	22.44	24	0.695	0.995	
Front	5	36	0	26915	836.5	21.80	23	0.597	0.787	
Front	5	75	0	26915	836.5	21.57	23	0.581	0.808	
Back	5	1	0	26915	836.5	22.53	24	0.050	0.070	
Left-side	5	1	0	26915	836.5	22.53	24	0.036	0.051	
Right-side	5	1	0	26915	836.5	22.53	24	0.562	0.788	
Tip	5	1	0	26915	836.5	22.53	24	0.139	0.195	
Test Mode: LTE Band 26 QPSK 15M_ANT2_5mm										
Front	5	1	0	26865	831.5	22.62	24	0.047	0.064	
Back	5	1	0	26915	836.5	22.62	24	0.016	0.022	
Left-side	5	1	0	26965	841.5	22.62	24	0.101	0.139	
Left-side	5	36	0	26915	836.5	21.76	23	0.099	0.131	
Right-side	5	1	0	26915	836.5	22.62	24	0.00591	0.008	
Tip	5	1	0	26915	836.5	22.62	24	0.052	0.071	
Note: 1. When the reported SAR of the Mid channel for the exposure configuration is ≤ 0.8 W/kg, no further SAR testing is required in other channel.										

LTE Band 30 Body SAR										
SAR MEASUREMENT										
Liquid Temperature (°C): 22.1 ±2							Relative Humidity (%): 50			
Ambient Temperature (°C): 22.6 ±2							Depth of Liquid (cm): >15			
Test Position	Dist (mm)	RB	RB offset	Frequency		Conducted Power (dBm)		SAR 1g (W/Kg)		Plot No.
				Channel	MHz	Measurement	Tune-up Limit	Measurement	Tune-up Scaled	
Test Mode: LTE Band 30 QPSK 10M_ANT0_5mm										
Front	5	1	0	27710	2310	18.69	19	0.946	1.016	12
Front	5	25	0	27710	2310	18.52	19	0.901	1.006	
Front	5	50	0	27710	2310	18.48	19	0.897	1.011	
Back	5	1	0	27710	2310	18.69	19	0.031	0.033	
Left-side	5	1	0	27710	2310	18.69	19	0.030	0.032	
Right-side	5	1	0	27710	2310	18.69	19	0.674	0.724	
Tip	5	1	0	27710	2310	18.69	19	0.054	0.058	
Note: 1. When the reported SAR of the Mid channel for the exposure configuration is ≤ 0.8 W/kg, no further SAR testing is required in other channel.										

LTE Band 41 Body SAR										
SAR MEASUREMENT										
Liquid Temperature (°C): 22.1 ±2							Relative Humidity (%): 50			
Ambient Temperature (°C): 22.6 ±2							Depth of Liquid (cm): >15			
Test Position	Dist (mm)	RB	RB offset	Frequency		Conducted Power (dBm)		SAR 1g (W/Kg)		Plot No.
				Channel	MHz	Measurement	Tune-up Limit	Measurement	Tune-up Scaled	
Test Mode: LTE Band 41 QPSK 20M_ANT0_5mm										
Front	5	1	0	39750	2506	15.74	16	0.485	0.515	
Front	5	1	0	40620	2593	15.77	16	0.651	0.686	
Front	5	1	0	41490	2680	15.68	16	0.922	0.993	
Front	5	50	0	39750	2506	15.67	16	0.481	0.519	
Front	5	50	0	40620	2593	15.68	16	0.678	0.730	
Front	5	50	0	41490	2680	15.58	16	0.925	1.019	13
Front	5	100	0	40620	2593	15.71	16	0.703	0.752	
Back	5	1	0	40620	2593	15.77	16	0.014	0.015	
Left-side	5	1	0	40620	2593	15.77	16	0.018	0.019	
Right-side	5	1	0	40620	2593	15.77	16	0.498	0.525	
Tip	5	1	0	40620	2593	15.77	16	0.027	0.029	
Test Mode: LTE Band 41 QPSK 20M_ANT2_5mm										
Front	5	1	0	39750	2506	12.81	13.5	0.574	0.673	
Front	5	1	0	40620	2593	12.85	13.5	0.876	1.017	
Front	5	1	0	41490	2680	12.84	13.5	0.486	0.566	
Front	5	50	0	39750	2506	11.96	13.5	0.510	0.727	
Front	5	50	0	40620	2593	12.83	13.5	0.852	0.994	
Front	5	50	0	41490	2680	12.81	13.5	0.458	0.537	
Front	5	100	0	40620	2593	12.58	13.5	0.816	1.009	
Back	5	1	0	40620	2593	12.85	13.5	0.033	0.038	
Left-side	5	1	0	40620	2593	12.85	13.5	0.411	0.477	
Right-side	5	1	0	40620	2593	12.85	13.5	0.024	0.028	
Tip	5	1	0	40620	2593	12.85	13.5	0.019	0.022	
Test Mode: LTE Band 41C 20M_ANT0_5mm										
Front	5	1	0	40521	2593	15.42	16	0.776	0.887	
Note: 1. When the reported SAR of the Mid channel for the exposure configuration is ≤ 0.8 W/kg, no further SAR testing is required in other channel.										

LTE Band 48 Body SAR										
SAR MEASUREMENT										
Liquid Temperature (°C): 22.1 ±2							Relative Humidity (%): 51			
Ambient Temperature (°C): 22.6 ±2							Depth of Liquid (cm): >15			
Test Position	Dist (mm)	RB	RB offset	Frequency		Conducted Power (dBm)		SAR 1g (W/Kg)		Plot No.
				Channel	MHz	Measurement	Tune-up Limit	Measurement	Tune-up Scaled	
Test Mode: LTE Band 48 QPSK 20M_ANT2_5mm										
Front	5	1	0	55340	3560	13.81	14	0.500	0.522	
Front	5	1	0	55990	3625	13.82	14	0.632	0.659	
Front	5	1	0	56640	3690	13.41	14	0.959	1.099	14
Front	5	50	0	55340	3560	13.68	14	0.533	0.574	
Front	5	50	0	55990	3625	13.51	14	0.664	0.743	
Front	5	50	0	56640	3690	13.33	14	0.854	0.996	
Front	5	100	0	55990	3625	13.41	14	0.609	0.698	
Back	5	1	0	55990	3625	13.82	14	0.040	0.041	
Left-side	5	1	0	55990	3625	13.82	14	0.431	0.449	
Right-side	5	1	0	55990	3625	13.82	14	0.039	0.040	
Tip	5	1	0	55990	3625	13.82	14	0.023	0.024	
Note: 1. When the reported SAR of the Mid channel for the exposure configuration is ≤ 0.8 W/kg, no further SAR testing is required in other channel.										

LTE Band 66 Body SAR										
SAR MEASUREMENT										
Liquid Temperature (°C): 21.6 ±2							Relative Humidity (%): 50			
Ambient Temperature (°C): 22.5 ±2							Depth of Liquid (cm): >15			
Test Position	Dist (mm)	RB	RB offset	Frequency		Conducted Power (dBm)		SAR 1g (W/Kg)		Plot No.
				Channel	MHz	Measurement	Tune-up Limit	Measurement	Tune-up Scaled	
Test Mode: LTE Band 66 QPSK 20M_ANT0_5mm										
Front	5	1	0	132072	1720	22.50	23	0.932	1.046	
Front	5	1	0	132322	1745	22.61	23	0.945	1.034	
Front	5	1	0	132572	1770	22.41	23	0.859	0.984	
Front	5	50	0	132072	1720	22.41	23	0.944	1.081	
Front	5	50	0	132322	1745	22.45	23	0.934	1.060	
Front	5	50	0	132572	1770	22.44	23	0.852	0.969	
Front	5	100	0	132322	1745	22.45	23	0.968	1.099	15
Back	5	1	0	132322	1745	22.61	23	0.255	0.279	
Left-side	5	1	0	132322	1745	22.61	23	0.127	0.139	
Right-side	5	1	0	132322	1745	22.61	23	0.717	0.784	
Tip	5	1	0	132322	1745	22.61	23	0.134	0.147	
Note: 1. When the reported SAR of the Mid channel for the exposure configuration is ≤ 0.8 W/kg, no further SAR testing is required in other channel.										

LTE Band 71 Body SAR										
SAR MEASUREMENT										
Liquid Temperature (°C): 21.9 ±2							Relative Humidity (%): 51			
Ambient Temperature (°C): 22.5 ±2							Depth of Liquid (cm): >15			
Test Position	Dist (mm)	RB	RB offset	Frequency		Conducted Power (dBm)		SAR 1g (W/Kg)		Plot No.
				Channel	MHz	Measurement	Tune-up Limit	Measurement	Tune-up Scaled	
Test Mode: LTE Band 71 QPSK 20M_ANT0_5mm										
Front	5	1	0	133222	673	22.34	24	0.306	0.448	
Front	5	1	0	133297	680.5	22.51	24	0.429	0.605	
Front	5	1	0	133372	688	22.43	24	0.453	0.650	16
Front	5	50	0	133297	680.5	21.47	23	0.354	0.504	
Back	5	1	0	133297	680.5	22.51	24	0.017	0.024	
Left-side	5	1	0	133297	680.5	22.51	24	0.013	0.018	
Right-side	5	1	0	133297	680.5	22.51	24	0.313	0.441	
Tip	5	1	0	133297	680.5	22.51	24	0.042	0.059	
Test Mode: LTE Band 71 QPSK 20M_ANT2_5mm										
Front	5	1	0	133297	680.5	22.41	24	0.043	0.061	
Back	5	1	0	133297	680.5	22.41	24	0.018	0.026	
Left-side	5	1	0	133297	680.5	22.41	24	0.076	0.109	
Left-side	5	50	0	133297	680.5	21.34	23	0.073	0.107	
Right-side	5	1	0	133297	680.5	22.41	24	0.00594	0.009	
Tip	5	1	0	133297	680.5	22.41	24	0.049	0.071	
Note: 1. When the reported SAR of the Mid channel for the exposure configuration is ≤ 0.8 W/kg, no further SAR testing is required in other channel.										

NR n2 Body SAR										
SAR MEASUREMENT										
Liquid Temperature (°C): 22.1 ±2							Relative Humidity (%): 51			
Ambient Temperature (°C): 22.6 ±2							Depth of Liquid (cm): >15			
Test Position	Dist (mm)	RB	RB offset	Frequency		Conducted Power (dBm)		SAR 1g (W/Kg)		Plot No.
				Channel	MHz	Measurement	Tune-up Limit	Measurement	Tune-up Scaled	
Test Mode: NR n2 DFT-s QPSK 20M_ANT0_5mm										
Front	5	1	1	372000	1860	23.56	24	0.852	0.943	
Front	5	1	1	376000	1880	23.61	24	0.963	1.053	17
Front	5	1	1	380000	1900	23.50	24	0.782	0.877	
Front	5	50	28	372000	1860	23.05	24	0.709	0.882	
Front	5	50	28	376000	1880	23.49	24	0.922	1.037	
Front	5	50	28	380000	1900	23.01	24	0.710	0.892	
Front	5	100	0	376000	1880	23.11	23.5	0.917	1.003	
Back	5	1	1	376000	1880	23.61	24	0.087	0.096	
Left-side	5	1	1	376000	1880	23.61	24	0.183	0.200	
Right-side	5	1	1	372000	1860	23.56	24	0.762	0.843	
Right-side	5	1	1	376000	1880	23.61	24	0.961	1.051	
Right-side	5	1	1	380000	1900	23.50	24	0.880	0.987	
Right-side	5	50	28	372000	1860	23.05	24	0.798	0.993	
Right-side	5	50	28	376000	1880	23.49	24	0.921	1.036	
Right-side	5	50	28	380000	1900	23.01	24	0.734	0.922	
Right-side	5	100	0	376000	1880	23.11	23.5	0.953	1.043	
Tip	5	1	1	376000	1880	23.61	24	0.146	0.160	
Note: 1. When the reported SAR of the Mid channel for the exposure configuration is ≤ 0.8 W/kg, no further SAR testing is required in other channel.										

NR n5 Body SAR										
SAR MEASUREMENT										
Liquid Temperature (°C): 22.1 ±2							Relative Humidity (%): 51			
Ambient Temperature (°C): 22.8 ±2							Depth of Liquid (cm): >15			
Test Position	Dist (mm)	RB	RB offset	Frequency		Conducted Power (dBm)		SAR 1g (W/Kg)		Plot No.
				Channel	MHz	Measurement	Tune-up Limit	Measurement	Tune-up Scaled	
Test Mode: NR n5 DFT-s QPSK 20M_ANT0_5mm										
Front	5	1	1	166800	834	23.18	24	0.719	0.868	18
Front	5	1	1	167300	836.5	23.22	24	0.659	0.789	
Front	5	1	1	167800	839	23.15	24	0.709	0.862	
Front	5	50	28	167300	836.5	22.55	24	0.473	0.660	
Front	5	100	0	167300	836.5	22.37	23.5	0.318	0.413	
Back	5	1	1	167300	836.5	23.22	24	0.051	0.061	
Left-side	5	1	1	167300	836.5	23.22	24	0.033	0.039	
Right-side	5	1	1	167300	836.5	23.22	24	0.549	0.657	
Tip	5	1	1	167300	836.5	23.22	24	0.142	0.170	
Test Mode: NR n5 DFT-s QPSK 20M_ANT2_5mm										
Front	5	1	1	167300	836.5	23.03	24	0.049	0.061	
Back	5	1	1	167300	836.5	23.03	24	0.017	0.022	
Left-side	5	1	1	167300	836.5	23.03	24	0.103	0.129	
Left-side	5	50	28	167300	836.5	22.85	24	0.116	0.151	
Right-side	5	1	1	167300	836.5	23.03	24	0.0065	0.008	
Tip	5	1	1	167300	836.5	23.03	24	0.056	0.070	
Note: 1. When the reported SAR of the Mid channel for the exposure configuration is ≤ 0.8 W/kg, no further SAR testing is required in other channel.										

NR n66 Body SAR										
SAR MEASUREMENT										
Liquid Temperature (°C): 21.6 ±2							Relative Humidity (%): 50			
Ambient Temperature (°C): 22.5 ±2							Depth of Liquid (cm): >15			
Test Position	Dist (mm)	RB	RB offset	Frequency		Conducted Power (dBm)		SAR 1g (W/Kg)		Plot No.
				Channel	MHz	Measurement	Tune-up Limit	Measurement	Tune-up Scaled	
Test Mode: NR n66 DFT-s QPSK 40M_ANT0_5mm										
Front	5	1	1	346000	1730	22.39	23	0.922	1.061	
Front	5	1	1	349000	1745	22.55	23	0.998	1.107	19
Front	5	1	1	352000	1760	22.51	23	0.970	1.086	
Front	5	108	54	346000	1730	22.30	23	0.853	1.002	
Front	5	108	54	349000	1745	22.32	23	0.862	1.008	
Front	5	108	54	352000	1760	22.00	23	0.343	0.432	
Front	5	216	54	349000	1745	21.36	22.5	0.417	0.542	
Back	5	1	1	349000	1745	22.55	23	0.253	0.281	
Left-side	5	1	1	349000	1745	22.55	23	0.159	0.176	
Right-side	5	1	1	349000	1745	22.55	23	0.591	0.656	
Tip	5	1	1	349000	1745	22.55	23	0.103	0.114	
Note: 1. When the reported SAR of the Mid channel for the exposure configuration is ≤ 0.8 W/kg, no further SAR testing is required in other channel.										

NR n71 Body SAR**SAR MEASUREMENT**

Liquid Temperature (°C): 21.9 ±2

Relative Humidity (%): 51

Ambient Temperature (°C): 22.5 ±2

Depth of Liquid (cm): >15

Test Position	Dist (mm)	RB	RB offset	Frequency		Conducted Power (dBm)		SAR 1g (W/Kg)		Plot No.
				Channel	MHz	Measurement	Tune-up Limit	Measurement	Tune-up Scaled	
Test Mode: NR n71 DFT-s QPSK 20M_ANT0_5mm										
Front	5	1	1	134600	673	22.65	24	0.494	0.674	
Front	5	1	1	136100	680.5	22.75	24	0.485	0.647	
Front	5	1	1	137600	688	22.62	24	0.548	0.753	
Front	5	50	28	136100	680.5	22.64	24	0.573	0.784	20
Back	5	1	1	136100	680.5	22.75	24	0.024	0.031	
Left-side	5	1	1	136100	680.5	22.75	24	0.018	0.024	
Right-side	5	1	1	136100	680.5	22.75	24	0.403	0.537	
Tip	5	1	1	136100	680.5	22.75	24	0.057	0.076	
Test Mode: NR n71 DFT-s QPSK 20M_ANT2_5mm										
Front	5	1	1	136100	680.5	22.57	24	0.048	0.067	
Back	5	1	1	136100	680.5	22.57	24	0.018	0.025	
Left-side	5	1	1	136100	680.5	22.57	24	0.077	0.107	
Left-side	5	50	28	136100	680.5	22.54	24	0.074	0.103	
Right-side	5	1	1	136100	680.5	22.57	24	0.00565	0.008	
Tip	5	1	1	136100	680.5	22.57	24	0.051	0.071	
Note: 1. When the reported SAR of the Mid channel for the exposure configuration is ≤ 0.8 W/kg, no further SAR testing is required in other channel.										

10. SAR measurement variability

- 1) Repeated measurement is not required when the original highest measured SAR is < 0.80 W/kg; steps 2) through 4) do not apply.
- 2) When the original highest measured SAR is ≥ 0.80 W/kg, repeat that measurement once.
- 3) Perform a second repeated measurement only if the ratio of largest to smallest SAR for the original and first repeated measurements is > 1.20 or when the original or repeated measurement is ≥ 1.45 W/kg (~ 10% from the 1-g SAR limit).
- 4) Perform a third repeated measurement only if the original, first or second repeated measurement is ≥ 1.5 W/kg and the ratio of largest to smallest SAR for the original, first and second repeated measurements is > 1.20 .

Frequency				SAR 1g (W/kg)							
Mode	Band	Channel	MHz	Original	First Repeated		Second Repeated		Third Repeated		
					Value	Ratio	Value	Ratio	Value	Ratio	
WCDMA	B2	9538	1907.6	0.833	0.790	1.054	N/A	N/A	N/A	N/A	
WCDMA	B4	1513	1752.6	0.875	0.851	1.028	N/A	N/A	N/A	N/A	
LTE	B2	18900	1880	0.826	0.809	1.021	N/A	N/A	N/A	N/A	
LTE	B7	21350	2560	0.867	0.856	1.013	N/A	N/A	N/A	N/A	
LTE	B30	27710	2310	0.946	0.914	1.035	N/A	N/A	N/A	N/A	
LTE	B41	41490	2680	0.925	0.922	1.003	N/A	N/A	N/A	N/A	
LTE	B48	56640	3690	0.959	0.909	1.055	N/A	N/A	N/A	N/A	
LTE	B66	132322	1745	0.968	0.961	1.007	N/A	N/A	N/A	N/A	
NR	n2	376000	1880	0.963	0.855	1.126	N/A	N/A	N/A	N/A	
NR	n66	349000	1745	0.998	0.991	1.007	N/A	N/A	N/A	N/A	

Appendix

Appendix A. SAR System Check Data

Appendix B. SAR measurement Data

Appendix C. Test Setup Photographs

Appendix D. Probe Calibration Data

Appendix E. Dipole Calibration Data

Appendix F. Product Photos-Please refer to the file: 2290522R-Product Photos

Appendix A. SAR System Check Data

Test Laboratory: DEKRA

Date: 2022/11/08

System Performance Check_750MHz-Head

DUT: Dipole 750 MHz; Type: D750V3

Communication System: UID 0, CW; Frequency: 750 MHz;

Communication System PAR: 0 dB

Medium parameters used: $f = 750$ MHz; $\sigma = 0.87$ S/m; $\epsilon_r = 41.89$; $\rho = 1000$ kg/m³

Phantom section: Flat Section

Ambient Temperature (°C) : 22.8, Liquid Temperature (°C) : 22.1

Measurement Standard: DASYS (IEEE/IEC/ANSI C63.19-2011)

DASY5 Configuration:

- Probe: EX3DV4 - SN3698; ConvF(9.1, 9.1, 9.1); Calibrated: 2021/11/24;
- Sensor-Surface: 1.4mm (Mechanical Surface Detection)
- Electronics: DAE4 Sn1207; Calibrated: 2021/11/22
- Phantom: SAM with right table; Type: SAM;
- Measurement SW: DASYS2, Version 52.10 (0); SEMCAD X Version 14.6.10 (7417)

Configuration/750MHz Head/Area Scan (8x13x1): Measurement grid: dx=15mm, dy=15mm

Maximum value of SAR (measured) = 2.59 W/kg

Configuration/750MHz Head/Zoom Scan (5x5x7)/Cube 0: Measurement grid: dx=8mm, dy=8mm, dz=5mm

Reference Value = 59.68 V/m; Power Drift = 0.10 dB

Peak SAR (extrapolated) = 3.38 W/kg

SAR(1 g) = 2.18 W/kg; SAR(10 g) = 1.42 W/kg

Maximum value of SAR (measured) = 2.96 W/kg

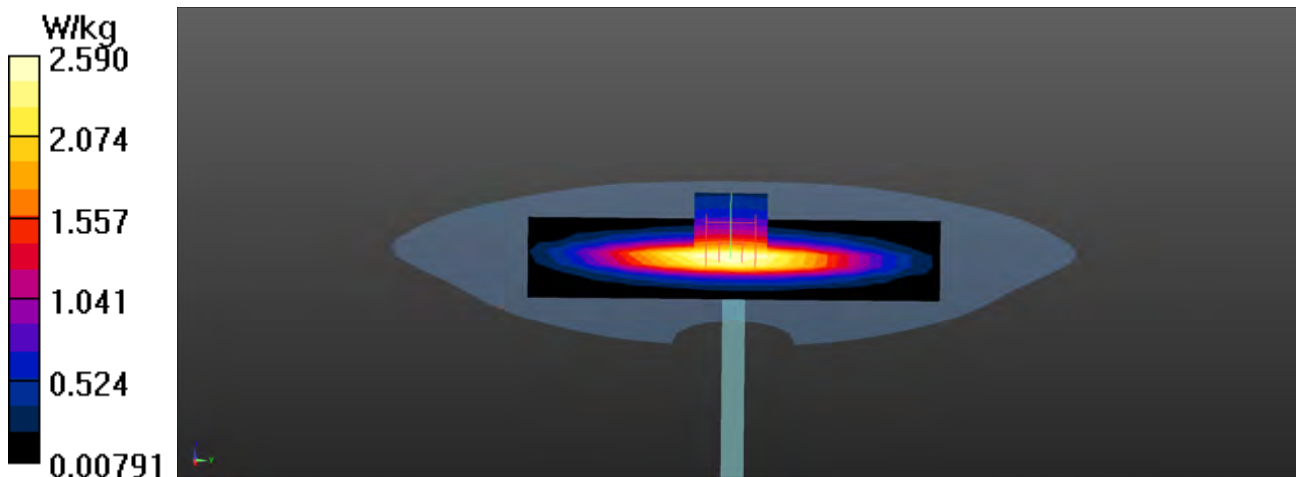

Test Laboratory: DEKRA

Date: 2022/11/10

System Performance Check_750MHz-Head**DUT: Dipole 750 MHz; Type: D750V3**

Communication System: UID 0, CW; Frequency: 750 MHz;

Communication System PAR: 0 dB

Medium parameters used: $f = 750$ MHz; $\sigma = 0.88$ S/m; $\epsilon_r = 41.91$; $\rho = 1000$ kg/m³

Phantom section: Flat Section

Ambient Temperature (°C) : 22.6, Liquid Temperature (°C) : 21.8

Measurement Standard: DASY5 (IEEE/IEC/ANSI C63.19-2011)

DASY5 Configuration:

- Probe: EX3DV4 - SN3698; ConvF(9.1, 9.1, 9.1); Calibrated: 2021/11/24;
- Sensor-Surface: 1.4mm (Mechanical Surface Detection)
- Electronics: DAE4 Sn1207; Calibrated: 2021/11/22
- Phantom: SAM with right table; Type: SAM;
- Measurement SW: DASY52, Version 52.10 (0); SEMCAD X Version 14.6.10 (7417)

Configuration/750MHz Head/Area Scan (8x13x1): Measurement grid: dx=15mm, dy=15mm

Maximum value of SAR (measured) = 2.68 W/kg

Configuration/750MHz Head/Zoom Scan (5x5x7)/Cube 0: Measurement grid: dx=8mm, dy=8mm, dz=5mm

Reference Value = 61.23 V/m; Power Drift = -0.00 dB

Peak SAR (extrapolated) = 3.47 W/kg

SAR(1 g) = 2.23 W/kg; SAR(10 g) = 1.46 W/kg

Maximum value of SAR (measured) = 3.04 W/kg

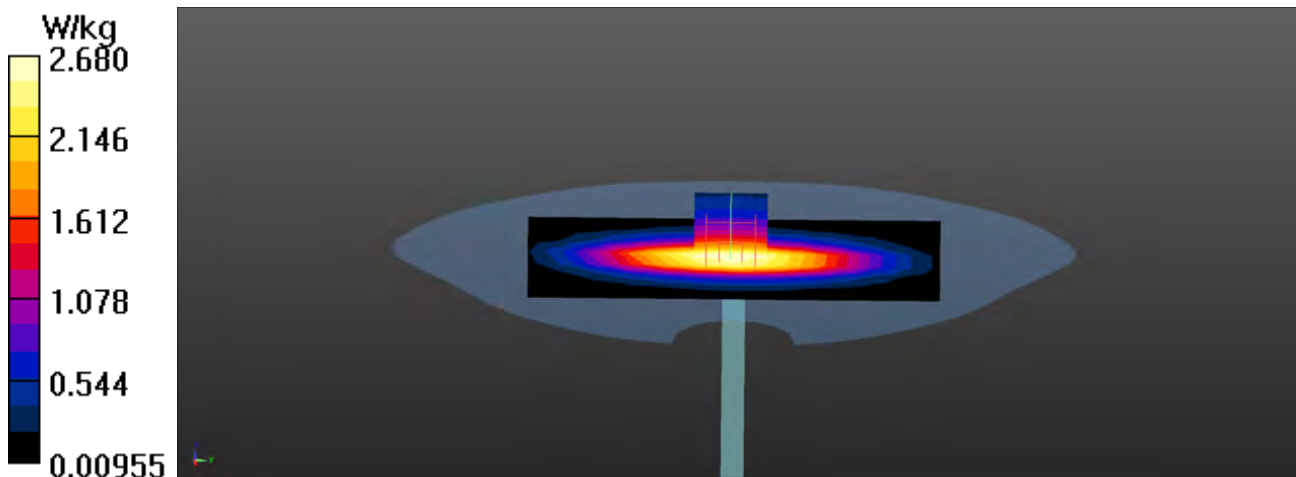

Test Laboratory: DEKRA

Date: 2022/11/11

System Performance Check_750MHz-Head**DUT: Dipole 750 MHz; Type: D750V3**

Communication System: UID 0, CW; Frequency: 750 MHz;

Communication System PAR: 0 dB

Medium parameters used: $f = 750$ MHz; $\sigma = 0.89$ S/m; $\epsilon_r = 41.87$; $\rho = 1000$ kg/m³

Phantom section: Flat Section

Ambient Temperature (°C) : 22.5, Liquid Temperature (°C) : 21.9

Measurement Standard: DASYS (IEEE/IEC/ANSI C63.19-2011)

DASY5 Configuration:

- Probe: EX3DV4 - SN3698; ConvF(9.1, 9.1, 9.1); Calibrated: 2021/11/24;
- Sensor-Surface: 1.4mm (Mechanical Surface Detection)
- Electronics: DAE4 Sn1207; Calibrated: 2021/11/22
- Phantom: SAM with right table; Type: SAM;
- Measurement SW: DASYS2, Version 52.10 (0); SEMCAD X Version 14.6.10 (7417)

Configuration/750MHz Head/Area Scan (8x13x1): Measurement grid: dx=15mm, dy=15mm

Maximum value of SAR (measured) = 2.57 W/kg

Configuration/750MHz Head/Zoom Scan (5x5x7)/Cube 0: Measurement grid: dx=8mm, dy=8mm, dz=5mm

Reference Value = 59.92 V/m; Power Drift = 0.04 dB

Peak SAR (extrapolated) = 3.37 W/kg

SAR(1 g) = 2.16 W/kg; SAR(10 g) = 1.41 W/kg

Maximum value of SAR (measured) = 2.95 W/kg

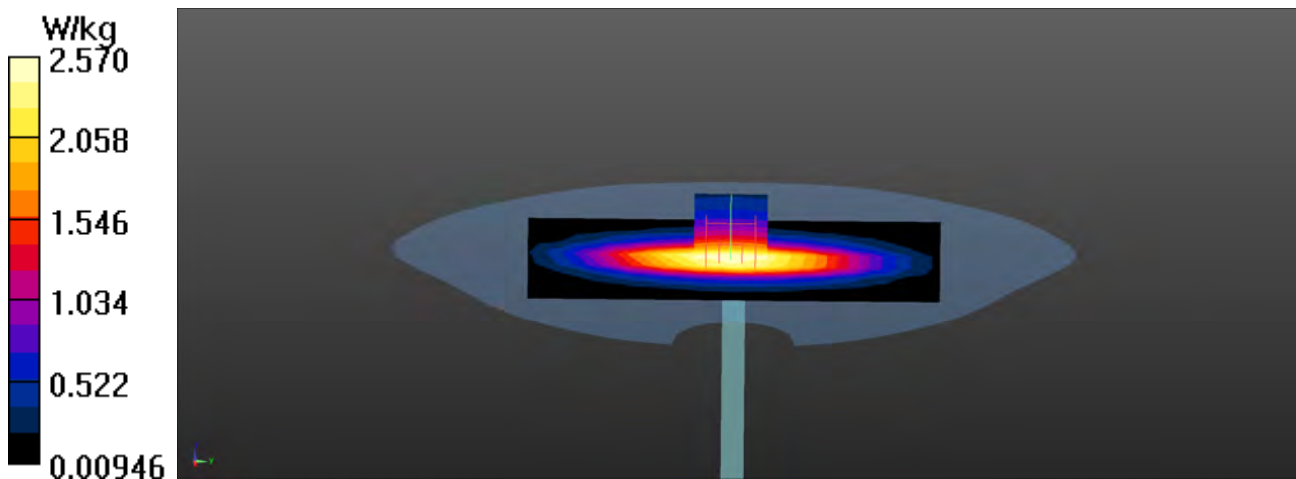

Test Laboratory: DEKRA

Date: 2022/11/14

System Performance Check_750MHz-Head**DUT: Dipole 750 MHz; Type: D750V3**

Communication System: UID 0, CW; Frequency: 750 MHz;

Communication System PAR: 0 dB

Medium parameters used: $f = 750$ MHz; $\sigma = 0.88$ S/m; $\epsilon_r = 41.93$; $\rho = 1000$ kg/m³

Phantom section: Flat Section

Ambient Temperature (°C) : 22.8, Liquid Temperature (°C) : 22.2

Measurement Standard: DASYS (IEEE/IEC/ANSI C63.19-2011)

DASY5 Configuration:

- Probe: EX3DV4 - SN3698; ConvF(9.1, 9.1, 9.1); Calibrated: 2021/11/24;
- Sensor-Surface: 1.4mm (Mechanical Surface Detection)
- Electronics: DAE4 Sn1207; Calibrated: 2021/11/22
- Phantom: SAM with right table; Type: SAM;
- Measurement SW: DASYS2, Version 52.10 (0); SEMCAD X Version 14.6.10 (7417)

Configuration/750MHz Head/Area Scan (8x13x1): Measurement grid: dx=15mm, dy=15mm

Maximum value of SAR (measured) = 2.51 W/kg

Configuration/750MHz Head/Zoom Scan (5x5x7)/Cube 0: Measurement grid: dx=8mm, dy=8mm, dz=5mm

Reference Value = 59.08 V/m; Power Drift = 0.06 dB

Peak SAR (extrapolated) = 3.27 W/kg

SAR(1 g) = 2.12 W/kg; SAR(10 g) = 1.38 W/kg

Maximum value of SAR (measured) = 2.87 W/kg

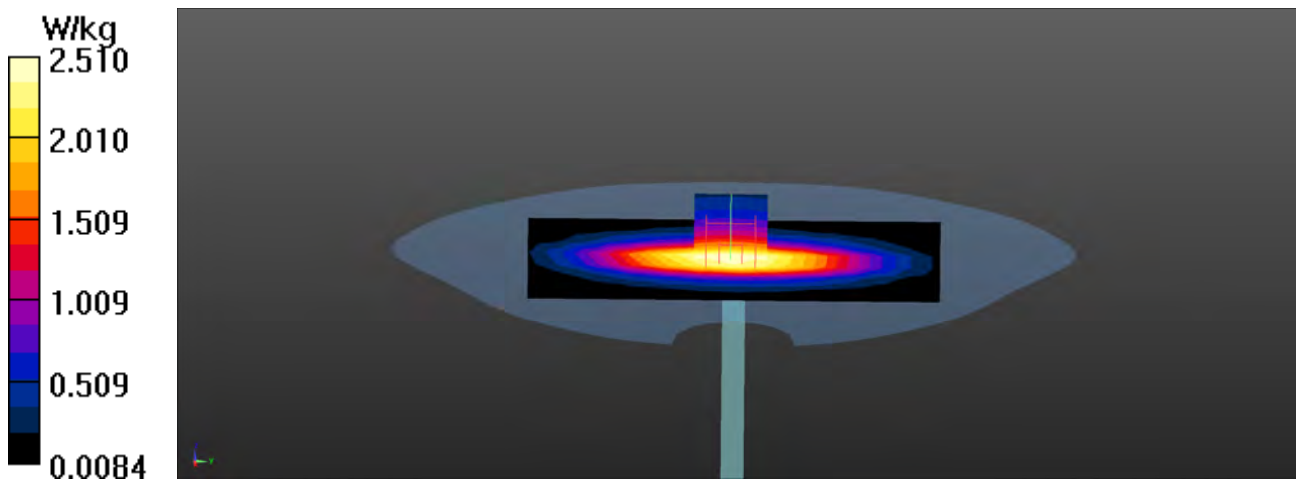

Test Laboratory: DEKRA

Date: 2022/11/19

System Performance Check_1750MHz-Head**DUT: Dipole 1750 MHz; Type: D1750V2**

Communication System: UID 0, CW; Frequency: 1750 MHz;

Communication System PAR: 0 dB

Medium parameters used: $f = 1750$ MHz; $\sigma = 1.37$ S/m; $\epsilon_r = 40.15$; $\rho = 1000$ kg/m³

Phantom section: Flat Section

Ambient Temperature (°C) : 22.5, Liquid Temperature (°C) : 21.6

Measurement Standard: DASYS (IEEE/IEC/ANSI C63.19-2011)

DASY5 Configuration:

- Probe: EX3DV4 - SN3698; ConvF(7.96, 7.96, 7.96); Calibrated: 2021/11/24;
- Sensor-Surface: 1.4mm (Mechanical Surface Detection)
- Electronics: DAE4 Sn1207; Calibrated: 2021/11/22
- Phantom: SAM with right table; Type: SAM;
- Measurement SW: DASYS2, Version 52.10 (0); SEMCAD X Version 14.6.10 (7417)

Configuration/1750MHz Head/Area Scan (8x8x1): Measurement grid: dx=15mm, dy=15mm

Maximum value of SAR (measured) = 10.1 W/kg

Configuration/1750MHz Head/Zoom Scan (5x5x7)/Cube 0: Measurement grid: dx=8mm, dy=8mm, dz=5mm

Reference Value = 103.4 V/m; Power Drift = 0.12 dB

Peak SAR (extrapolated) = 16.9 W/kg

SAR(1 g) = 8.96 W/kg; SAR(10 g) = 4.71 W/kg

Maximum value of SAR (measured) = 14.1 W/kg

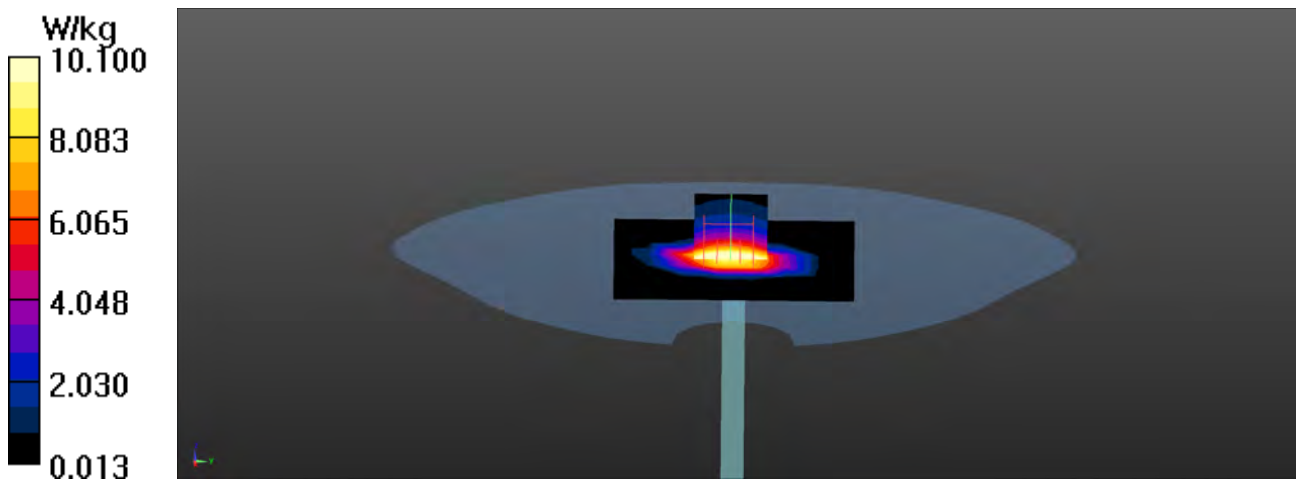

Test Laboratory: DEKRA

Date: 2022/11/20

System Performance Check_1900MHz-Head**DUT: Dipole 1900 MHz; Type: D1900V2**

Communication System: UID 0, CW; Frequency: 1900 MHz;

Communication System PAR: 0 dB

Medium parameters used: $f = 1900$ MHz; $\sigma = 1.38$ S/m; $\epsilon_r = 40.69$; $\rho = 1000$ kg/m³

Phantom section: Flat Section

Measurement Standard: DASYS (IEEE/IEC/ANSI C63.19-2011)

Ambient Temperature (°C) : 22.6, Liquid Temperature (°C) : 22.1

DASY5 Configuration:

- Probe: EX3DV4 - SN3698; ConvF(7.6, 7.6, 7.6); Calibrated: 2021/11/24;
- Sensor-Surface: 4mm (Mechanical Surface Detection)
- Electronics: DAE4 Sn1207; Calibrated: 2021/11/22
- Phantom: SAM with left table; Type: SAM;
- Measurement SW: DASYS2, Version 52.10 (0); SEMCAD X Version 14.6.10 (7417)

Configuration/1900MHz Head/Area Scan (8x8x1): Measurement grid: dx=15mm, dy=15mm

Maximum value of SAR (measured) = 8.72 W/kg

Configuration/1900MHz Head/Zoom Scan (5x5x7)/Cube 0: Measurement grid: dx=8mm, dy=8mm, dz=5mm

Reference Value = 84.91 V/m; Power Drift = 0.14 dB

Peak SAR (extrapolated) = 17.9 W/kg

SAR(1 g) = 9.49 W/kg; SAR(10 g) = 4.88 W/kg

Maximum value of SAR (measured) = 10.6 W/kg

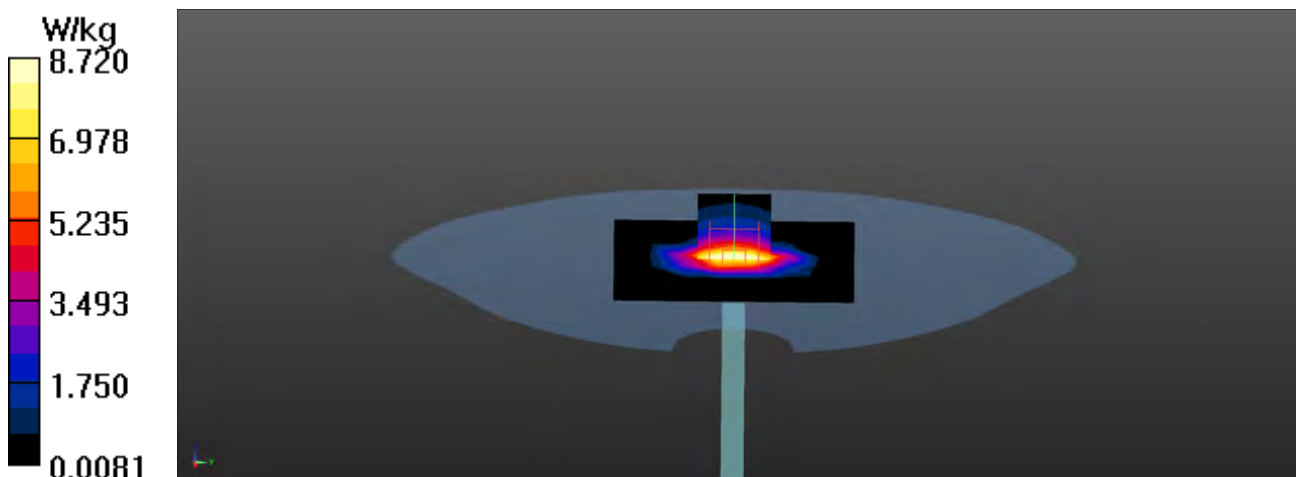

Test Laboratory: DEKRA

Date: 2022/11/09

System Performance Check_2300MHz-Head**DUT: Dipole 2300 MHz; Type: D2300V2**

Communication System: UID 0, CW; Frequency: 2300 MHz;

Communication System PAR: 0 dB

Medium parameters used: $f = 2300$ MHz; $\sigma = 1.67$ S/m; $\epsilon_r = 39.58$; $\rho = 1000$ kg/m³

Phantom section: Flat Section

Ambient Temperature (°C) : 22.6, Liquid Temperature (°C) : 22.1

Measurement Standard: DASY5 (IEEE/IEC/ANSI C63.19-2011)

DASY5 Configuration:

- Probe: EX3DV4 - SN3698; ConvF(7.39, 7.39, 7.39); Calibrated: 2021/11/24;
- Sensor-Surface: 1.4mm (Mechanical Surface Detection)
- Electronics: DAE4 Sn1207; Calibrated: 2021/11/22
- Phantom: SAM with right table; Type: SAM;
- Measurement SW: DASY52, Version 52.10 (0); SEMCAD X Version 14.6.10 (7417)

Configuration/2300MHz_Head/Area Scan (8x9x1): Measurement grid: dx=12mm, dy=12mm

Maximum value of SAR (measured) = 19.5 W/kg

Configuration/2300MHz_Head/Zoom Scan (7x7x7)/Cube 0: Measurement grid: dx=5mm, dy=5mm, dz=5mm

Reference Value = 112.8 V/m; Power Drift = 0.14 dB

Peak SAR (extrapolated) = 25.5 W/kg

SAR(1 g) = 12.3 W/kg; SAR(10 g) = 5.84 W/kg

Maximum value of SAR (measured) = 20.4 W/kg

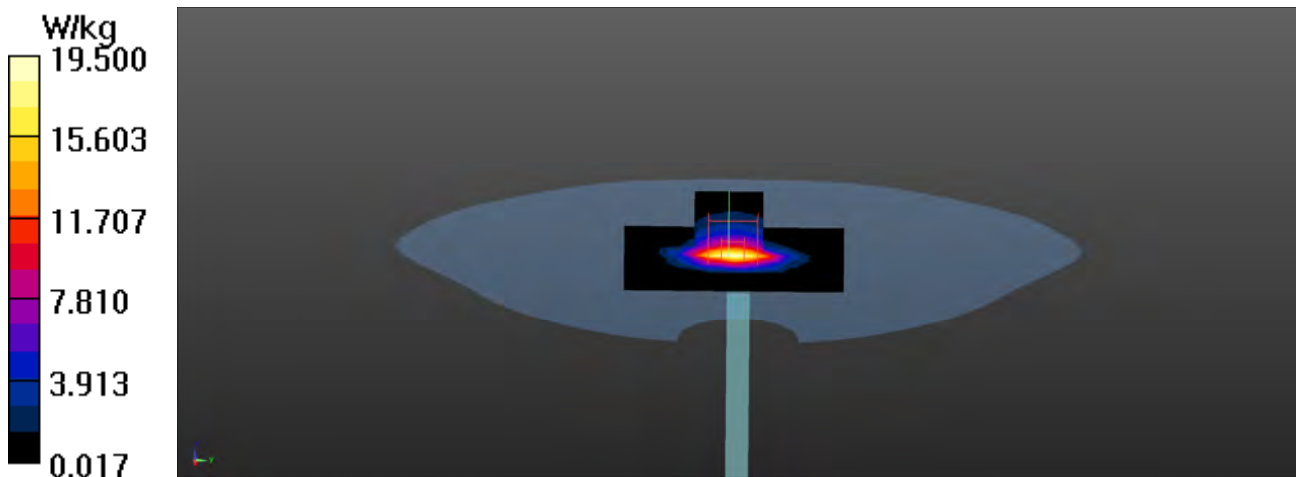

Test Laboratory: DEKRA

Date: 2022/11/09

System Performance Check_2600MHz-Head**DUT: Dipole_2600MHz; Type: ALS-D-2600-S-2**

Communication System: UID 0, CW; Frequency: 2600 MHz;

Communication System PAR: 0 dB

Medium parameters used: $f = 2600$ MHz; $\sigma = 1.97$ S/m; $\epsilon_r = 38.99$; $\rho = 1000$ kg/m³

Phantom section: Flat Section

Ambient Temperature (°C) : 22.6, Liquid Temperature (°C) : 22.1

Measurement Standard: DASYS (IEEE/IEC/ANSI C63.19-2011)

DASY5 Configuration:

- Probe: EX3DV4 - SN3698; ConvF(6.97, 6.97, 6.97); Calibrated: 2021/11/24;
- Sensor-Surface: 4mm (Mechanical Surface Detection), Sensor-Surface: 1.4mm (Mechanical Surface Detection)
- Electronics: DAE4 Sn1207; Calibrated: 2021/11/22
- Phantom: SAM with right table; Type: SAM;
- Measurement SW: DASYS2, Version 52.10 (0); SEMCAD X Version 14.6.10 (7417)

Configuration/2600MHz Body/Area Scan (9x9x1): Measurement grid: dx=12mm, dy=12mm

Maximum value of SAR (measured) = 16.9 W/kg

Configuration/2600MHz Body/Zoom Scan (7x7x7)/Cube 0: Measurement grid: dx=5mm, dy=5mm, dz=5mm

Reference Value = 121.8 V/m; Power Drift = 0.06 dB

Peak SAR (extrapolated) = 32.8 W/kg

SAR(1 g) = 14.2 W/kg; SAR(10 g) = 6.39 W/kg

Maximum value of SAR (measured) = 27.0 W/kg

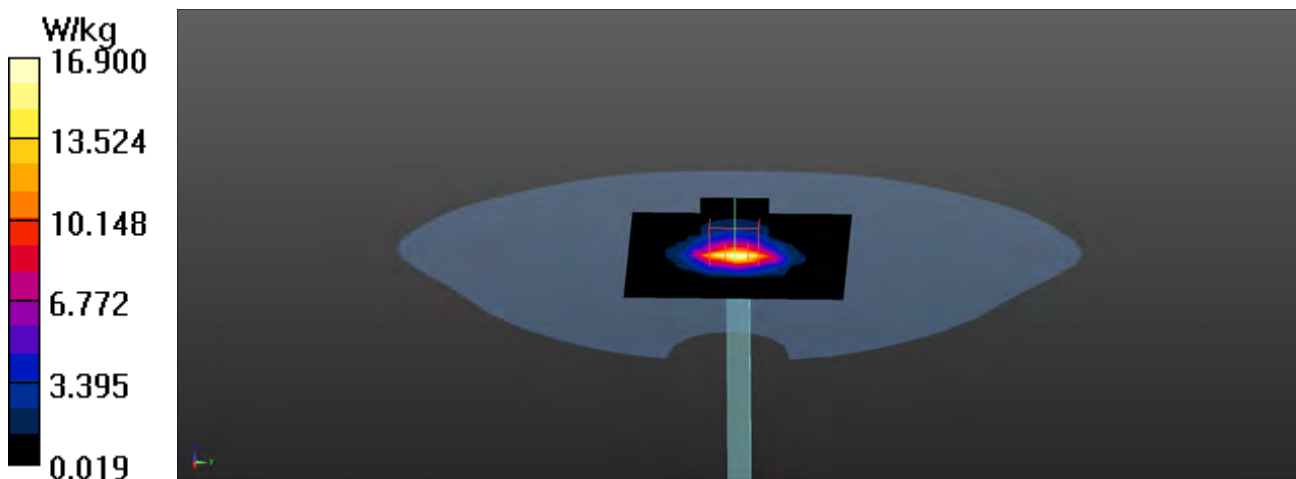

Test Laboratory: DEKRA

Date: 2022/11/20

System Performance Check_3700MHz-Head**DUT: Dipole 3700 MHz; Type: D3700V2**

Communication System: UID 0, CW; Frequency: 3700 MHz;

Communication System PAR: 0 dB

Medium parameters used: $f = 3700$ MHz; $\sigma = 3.13$ S/m; $\epsilon_r = 37.48$; $\rho = 1000$ kg/m³

Phantom section: Flat Section

Ambient Temperature (°C) : 22.6, Liquid Temperature (°C) : 22.1

Measurement Standard: DASYS (IEEE/IEC/ANSI C63.19-2007)

DASY5 Configuration:

- Probe: EX3DV4 - SN3698; ConvF(6.15, 6.15, 6.15); Calibrated: 2021/11/24;
- Sensor-Surface: 1.4mm (Mechanical Surface Detection)
- Electronics: DAE4 Sn1207; Calibrated: 2021/11/22
- Phantom: SAM with right table; Type: SAM;
- Measurement SW: DASYS2, Version 52.10 (0); SEMCAD X Version 14.6.10 (7417)

Configuration/3700MHz/Area Scan (7x7x1): Measurement grid: dx=12mm, dy=12mm

Maximum value of SAR (measured) = 18.8 W/kg

Configuration/3700MHz/Zoom Scan (7x7x7)/Cube 0: Measurement grid: dx=5mm, dy=5mm, dz=1.4mm

Reference Value = 73.76 V/m; Power Drift = 0.05 dB

Peak SAR (extrapolated) =18.9 W/kg

SAR(1 g) = 6.5 W/kg; SAR(10 g) = 2.33 W/kg

Maximum value of SAR (measured) = 24.5 W/kg

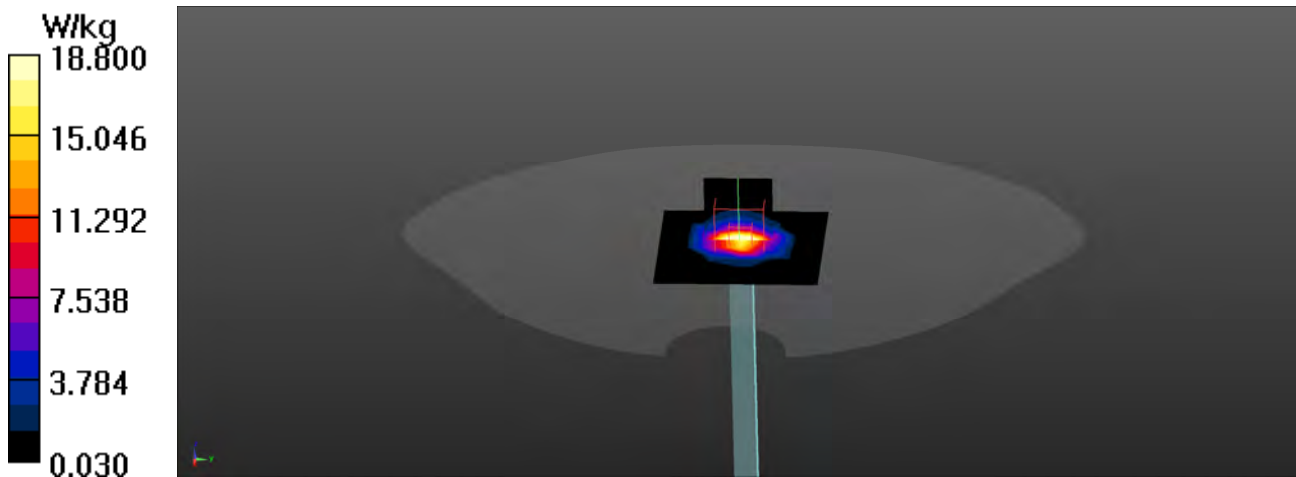

Appendix B. SAR measurement Data

Test Laboratory: DEKRA

Date: 2022/11/20

WCDMA_BAND 2_RMC_9538_Front_ANT 0 5mm

DUT: VOS 5G Dongle; Type: VOS5-GC-1

Communication System: UID 0, FCC WCDMA_Band-2; Frequency: 1907.6 MHz;

Communication System PAR: 0 dB

Medium parameters used: $f = 1907.6$ MHz; $\sigma = 1.38$ S/m; $\epsilon_r = 40.61$; $\rho = 1000$ kg/m³

Phantom section: Flat Section

Ambient Temperature (°C) : 22.6, Liquid Temperature (°C) : 22.1

Measurement Standard: DASYS (IEEE/IEC/ANSI C63.19-2011)

DASY5 Configuration:

- Probe: EX3DV4 - SN3698; ConvF(7.6, 7.6, 7.6); Calibrated: 2021/11/24;
- Sensor-Surface: 1.4mm (Mechanical Surface Detection)
- Electronics: DAE4 Sn1207; Calibrated: 2021/11/22
- Phantom: SAM with right table; Type: SAM;
- Measurement SW: DASYS2, Version 52.10 (0); SEMCAD X Version 14.6.10 (7417)

Configuration/Flat/Area Scan (6x9x1): Measurement grid: dx=15mm, dy=15mm

Maximum value of SAR (measured) = 1.18 W/kg

Configuration/Flat/Zoom Scan (5x5x7)/Cube 0: Measurement grid: dx=8mm, dy=8mm, dz=5mm

Reference Value = 21.23 V/m; Power Drift = -0.18 dB

Peak SAR (extrapolated) = 1.60 W/kg

SAR(1 g) = 0.776 W/kg; SAR(10 g) = 0.415 W/kg

Maximum value of SAR (measured) = 1.22 W/kg

Configuration/Flat/Zoom Scan (5x5x7)/Cube 1: Measurement grid: dx=8mm, dy=8mm, dz=5mm

Reference Value = 21.23 V/m; Power Drift = -0.18 dB

Peak SAR (extrapolated) = 1.99 W/kg

SAR(1 g) = 0.833 W/kg; SAR(10 g) = 0.395 W/kg

Maximum value of SAR (measured) = 1.51 W/kg

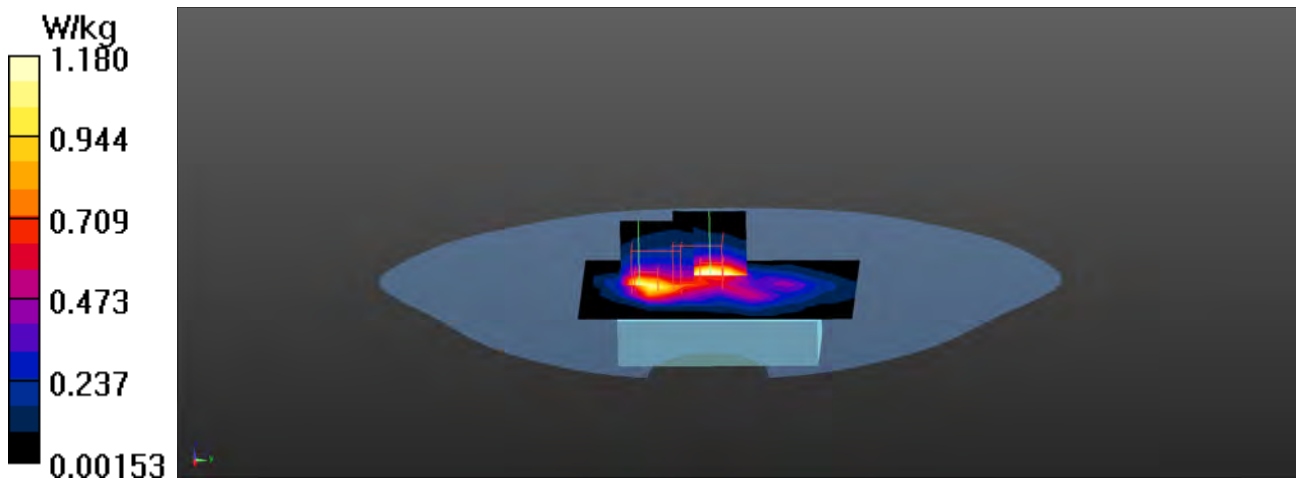

WCDMA Band 2 RMC Front (ANT 0 5mm) Z-Axis plot

Channel: 9538

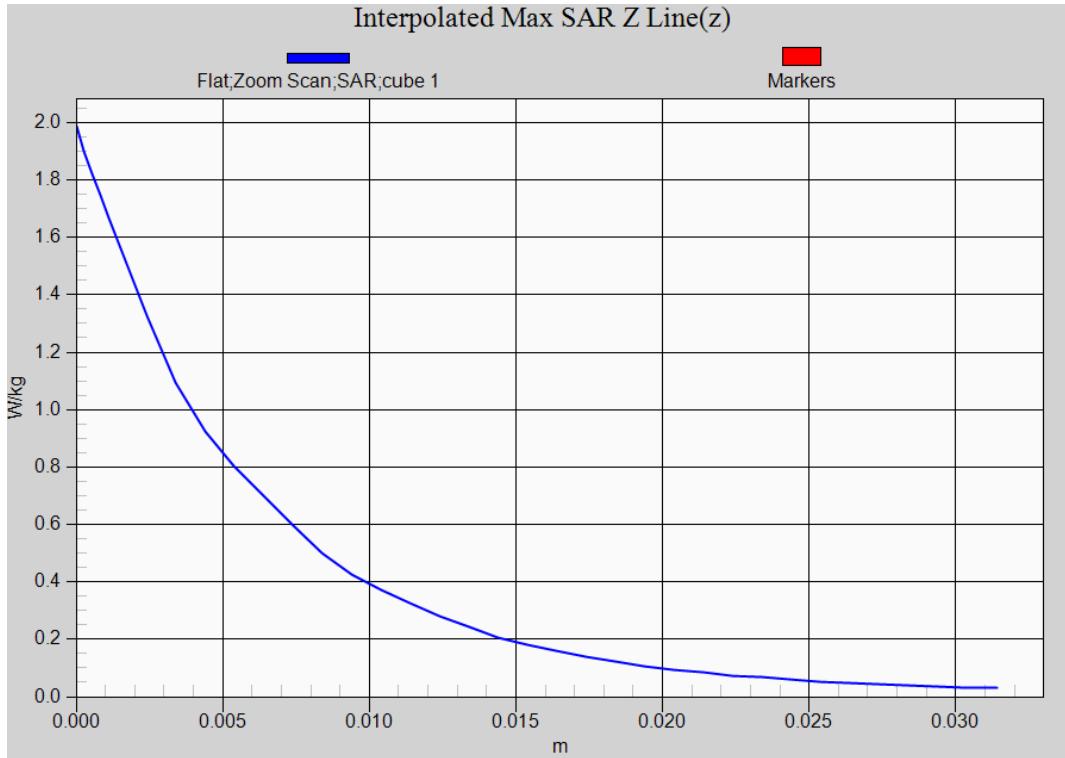

Test Laboratory: DEKRA

Date: 2022/11/19

WCDMA_BAND 4_RMC_1513_Front_ANT 0 5mm**DUT: VOS 5G Dongle; Type: VOS5-GC-1**

Communication System: UID 0, FCC WCDMA_Band 4; Frequency: 1752.6 MHz;

Communication System PAR: 0 dB

Medium parameters used: $f = 1752.6$ MHz; $\sigma = 1.37$ S/m; $\epsilon_r = 40.12$; $\rho = 1000$ kg/m³

Phantom section: Flat Section

Ambient Temperature (°C) : 22.5, Liquid Temperature (°C) : 21.6

Measurement Standard: DASY5 (IEEE/IEC/ANSI C63.19-2011)

DASY5 Configuration:

- Probe: EX3DV4 - SN3698; ConvF(7.96, 7.96, 7.96); Calibrated: 2021/11/24;
- Sensor-Surface: 1.4mm (Mechanical Surface Detection)
- Electronics: DAE4 Sn1207; Calibrated: 2021/11/22
- Phantom: SAM with right table; Type: SAM;
- Measurement SW: DASY52, Version 52.10 (0); SEMCAD X Version 14.6.10 (7417)

Configuration/Flat/Area Scan (6x9x1): Measurement grid: dx=15mm, dy=15mm

Maximum value of SAR (measured) = 1.27 W/kg

Configuration/Flat/Zoom Scan (5x5x7)/Cube 0: Measurement grid: dx=8mm, dy=8mm, dz=5mm

Reference Value = 31.45 V/m; Power Drift = 0.16 dB

Peak SAR (extrapolated) = 1.88 W/kg

SAR(1 g) = 0.875 W/kg; SAR(10 g) = 0.414 W/kg

Maximum value of SAR (measured) = 1.49 W/kg

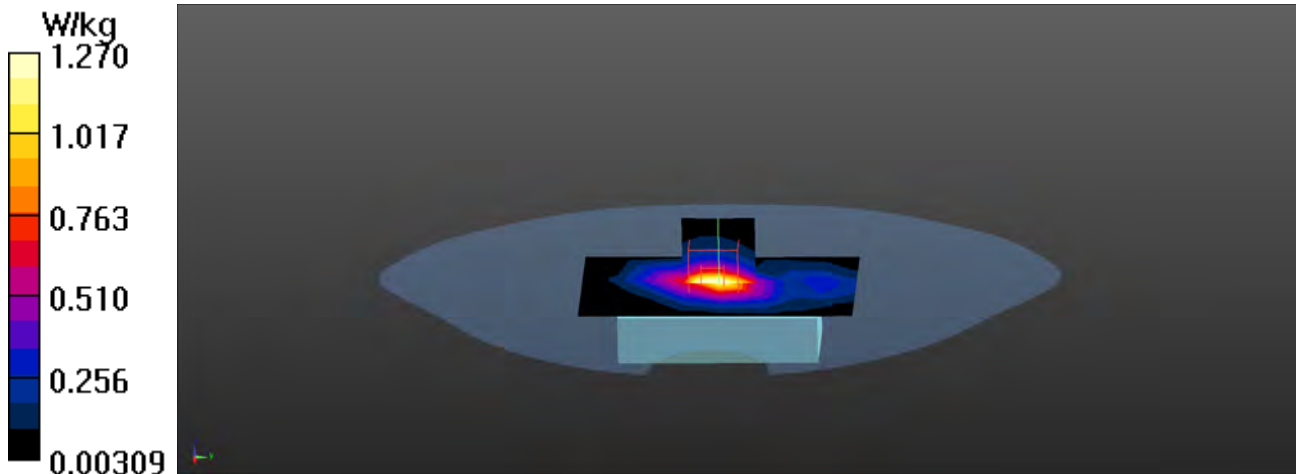

WCDMA Band 4 RMC Front (ANT 0 5mm) Z-Axis plot

Channel: 1513

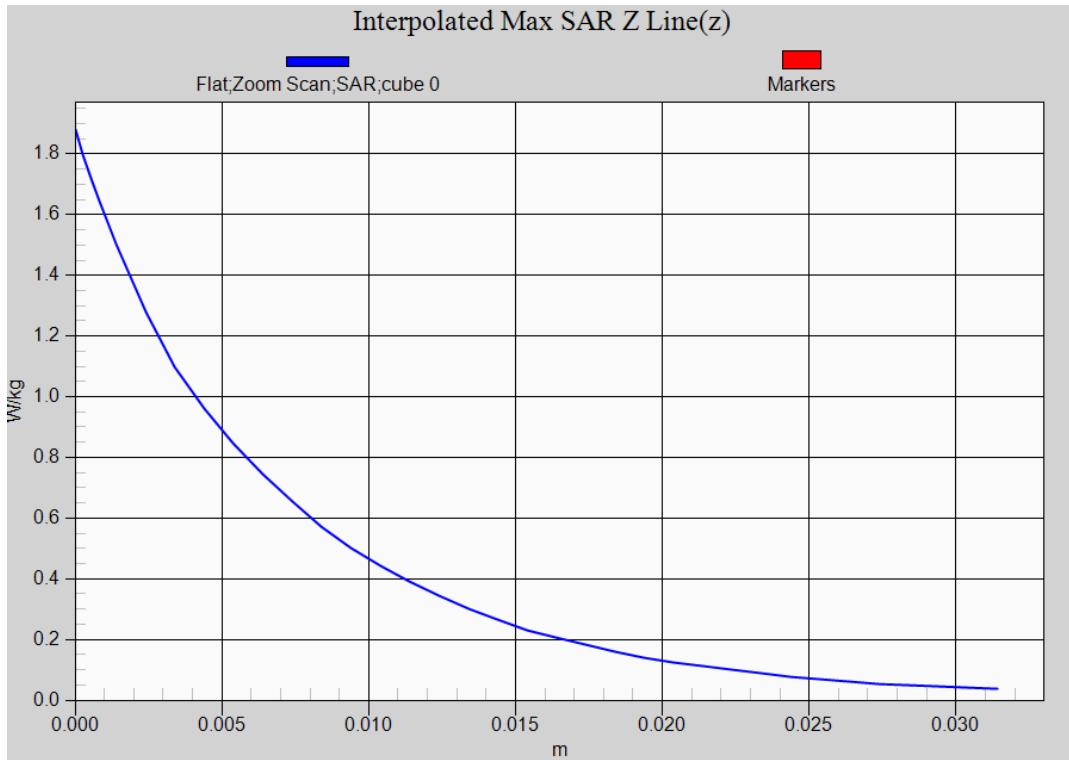

Test Laboratory: DEKRA

Date: 2022/11/08

WCDMA_BAND 5_RMC_4132_Front_ANT 0 5mm**DUT: VOS 5G Dongle; Type: VOS5-GC-1**

Communication System: UID 0, FCC WCDMA_Band-5; Frequency: 826.4 MHz;

Communication System PAR: 0 dB

Medium parameters used: $f = 826.4$ MHz; $\sigma = 0.91$ S/m; $\epsilon_r = 40.85$; $\rho = 1000$ kg/m³

Phantom section: Flat Section

Ambient Temperature (°C) : 22.8, Liquid Temperature (°C) : 22.1

Measurement Standard: DASY5 (IEEE/IEC/ANSI C63.19-2011)

DASY5 Configuration:

- Probe: EX3DV4 - SN3698; ConvF(8.9, 8.9, 8.9); Calibrated: 2021/11/24;
- Sensor-Surface: 1.4mm (Mechanical Surface Detection)
- Electronics: DAE4 Sn1207; Calibrated: 2021/11/22
- Phantom: SAM with right table; Type: SAM;
- Measurement SW: DASY52, Version 52.10 (0); SEMCAD X Version 14.6.10 (7417)

Configuration/Flat/Area Scan (6x9x1): Measurement grid: dx=15mm, dy=15mm

Maximum value of SAR (measured) = 1.16 W/kg

Configuration/Flat/Zoom Scan (5x5x7)/Cube 0: Measurement grid: dx=8mm, dy=8mm, dz=5mm

Reference Value = 20.65 V/m; Power Drift = -0.02 dB

Peak SAR (extrapolated) = 1.51 W/kg

SAR(1 g) = 0.702 W/kg; SAR(10 g) = 0.362 W/kg

Maximum value of SAR (measured) = 1.19 W/kg

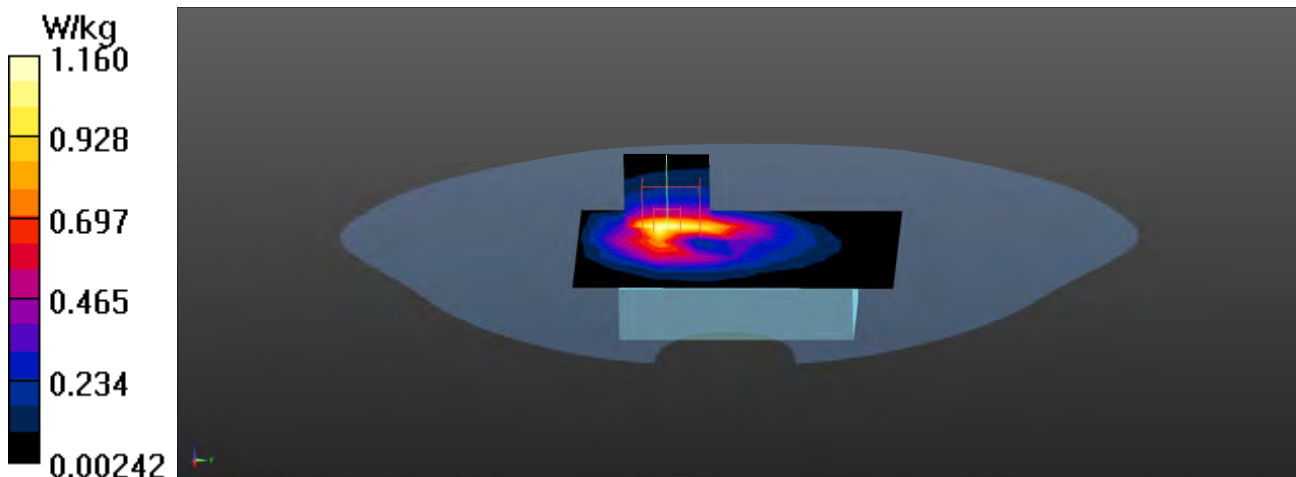

WCDMA Band 5 RMC Front (ANT 0 5mm) Z-Axis plot

Channel: 4132

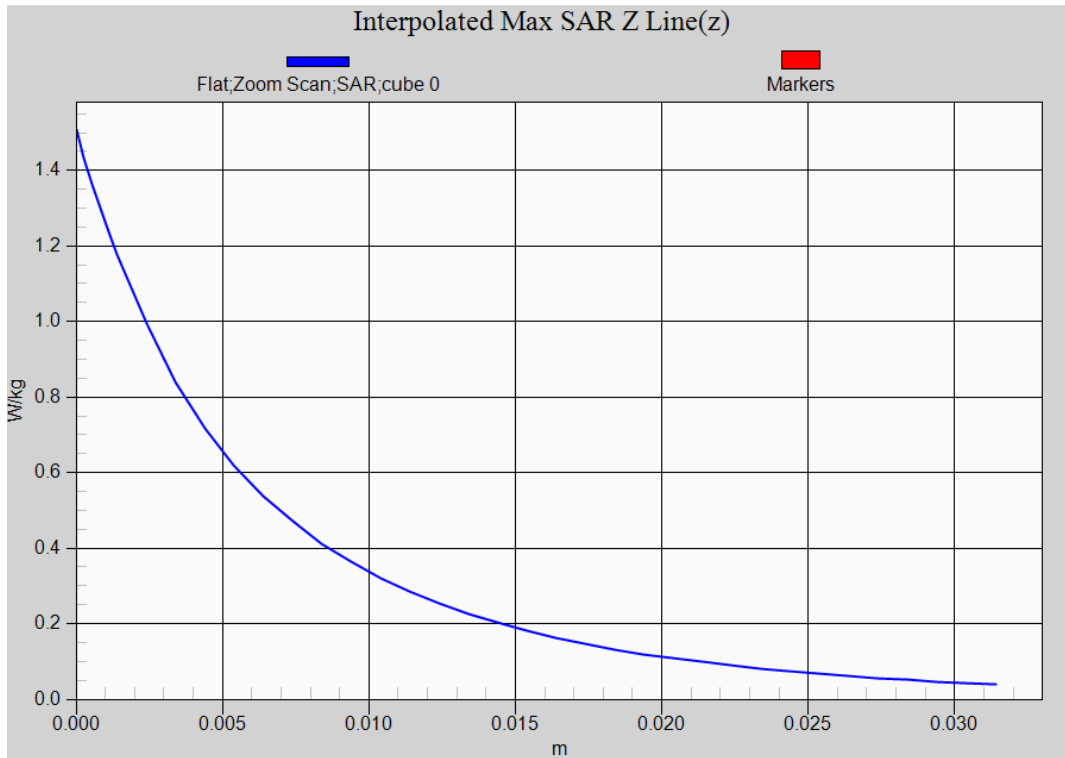

Test Laboratory: DEKRA

Date: 2022/11/20

LTE_Band2_QPSK_20M_18900_1RB-0_Front_ANT 0 5mm**DUT: VOS 5G Dongle; Type: VOS5-GC-1**

Communication System: UID 0, LTE Band2; Frequency: 1880 MHz;

Communication System PAR: 0 dB

Medium parameters used: $f = 1880$ MHz; $\sigma = 1.37$ S/m; $\epsilon_r = 40.93$; $\rho = 1000$ kg/m³

Phantom section: Flat Section

Ambient Temperature (°C) : 22.6, Liquid Temperature (°C) : 22.1

Measurement Standard: DASY5 (IEEE/IEC/ANSI C63.19-2011)

DASY5 Configuration:

- Probe: EX3DV4 - SN3698; ConvF(7.6, 7.6, 7.6); Calibrated: 2021/11/24;
- Sensor-Surface: 1.4mm (Mechanical Surface Detection)
- Electronics: DAE4 Sn1207; Calibrated: 2021/11/22
- Phantom: SAM with right table; Type: SAM;
- Measurement SW: DASY52, Version 52.10 (0); SEMCAD X Version 14.6.10 (7417)

Configuration/Flat/Area Scan (6x9x1): Measurement grid: dx=15mm, dy=15mm

Maximum value of SAR (measured) = 1.33 W/kg

Configuration/Flat/Zoom Scan (5x5x7)/Cube 0: Measurement grid: dx=8mm, dy=8mm, dz=5mm

Reference Value = 22.87 V/m; Power Drift = 0.01 dB

Peak SAR (extrapolated) = 1.82 W/kg

SAR(1 g) = 0.826 W/kg; SAR(10 g) = 0.434 W/kg

Maximum value of SAR (measured) = 1.41 W/kg

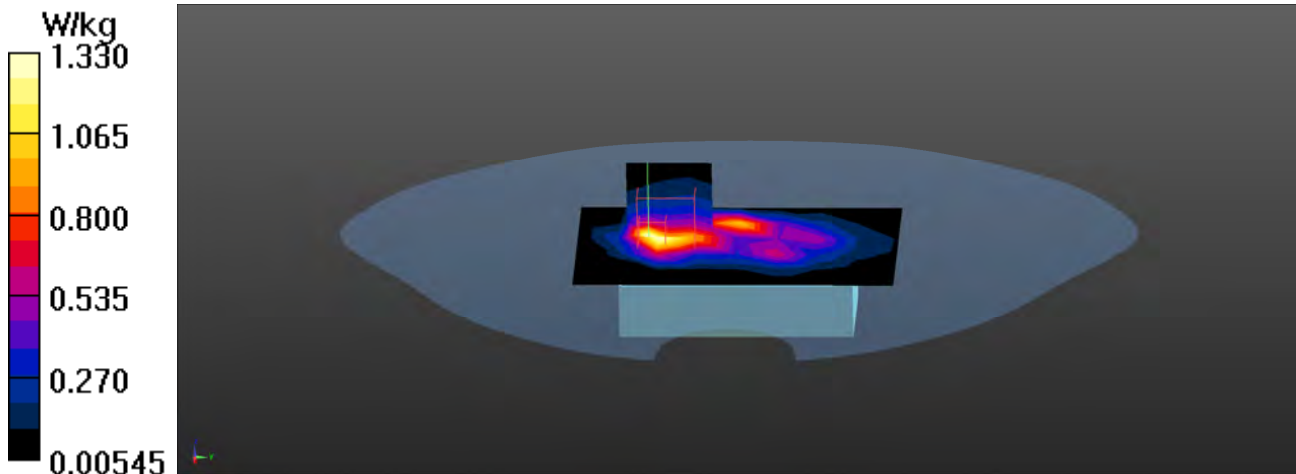

LTE Band 2 20M QPSK 1RB-0 Front (ANT 0 5mm) Z-Axis plot

Channel: 18900

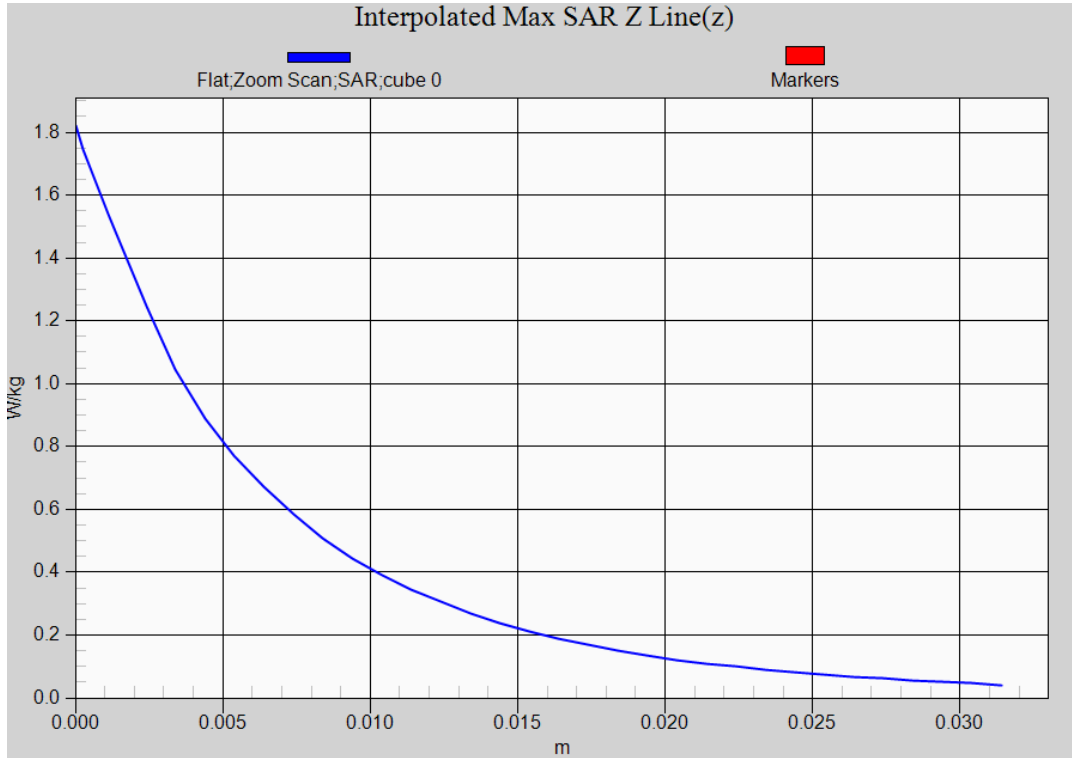

Test Laboratory: DEKRA

Date: 2022/11/08

LTE_Band5_QPSK_10M_20450_1RB-0_Front_ANT 0 5mm**DUT: VOS 5G Dongle; Type: VOS5-GC-1**

Communication System: UID 0, LTE Band5; Frequency: 829 MHz;

Communication System PAR: 0 dB

Medium parameters used: $f = 829$ MHz; $\sigma = 0.91$ S/m; $\epsilon_r = 40.81$; $\rho = 1000$ kg/m³

Phantom section: Flat Section

Ambient Temperature (°C) : 22.8, Liquid Temperature (°C) : 22.1

Measurement Standard: DASYS (IEEE/IEC/ANSI C63.19-2011)

DASY5 Configuration:

- Probe: EX3DV4 - SN3698; ConvF(8.9, 8.9, 8.9); Calibrated: 2021/11/24;
- Sensor-Surface: 1.4mm (Mechanical Surface Detection)
- Electronics: DAE4 Sn1207; Calibrated: 2021/11/22
- Phantom: SAM with right table; Type: SAM;
- Measurement SW: DASYS2, Version 52.10 (0); SEMCAD X Version 14.6.10 (7417)

Configuration/Flat/Area Scan (6x9x1): Measurement grid: dx=15mm, dy=15mm

Maximum value of SAR (measured) = 1.10 W/kg

Configuration/Flat/Zoom Scan (5x5x7)/Cube 0: Measurement grid: dx=8mm, dy=8mm, dz=5mm

Reference Value = 13.15 V/m; Power Drift = 0.00 dB

Peak SAR (extrapolated) = 1.56 W/kg

SAR(1 g) = 0.717 W/kg; SAR(10 g) = 0.367 W/kg

Maximum value of SAR (measured) = 1.24 W/kg

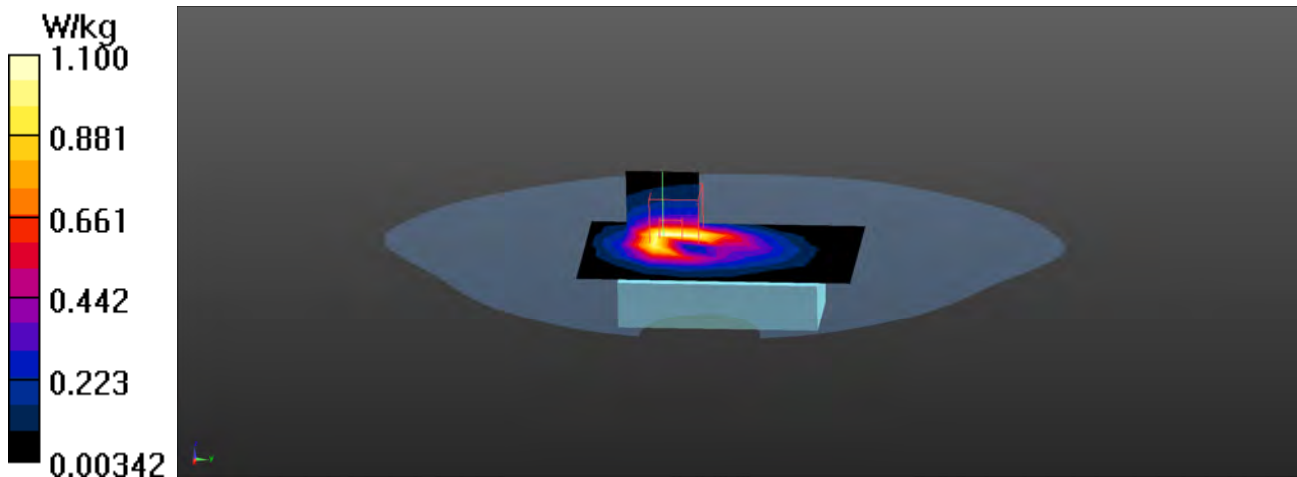

LTE Band 5 10M QPSK 1RB-0 Front (ANT 0 5mm) Z-Axis plot

Channel: 20450

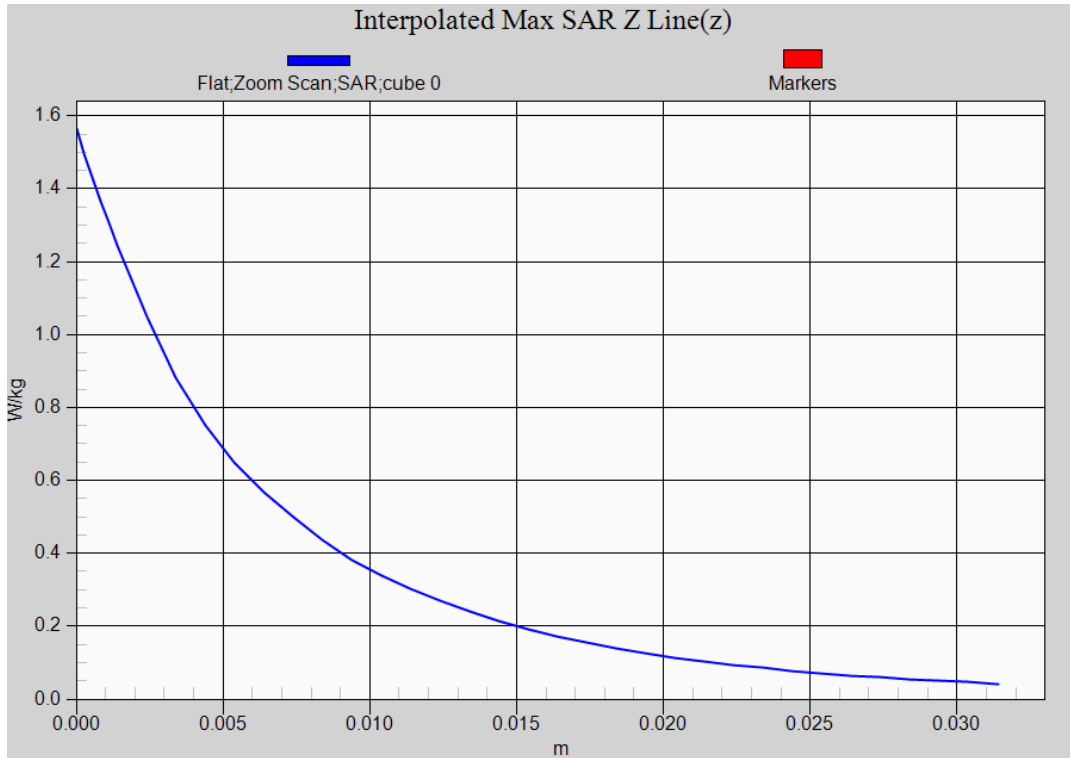

Test Laboratory: DEKRA

Date: 2022/11/09

LTE_Band7_QPSK_20M_21350_1RB-0_Front_ANT 0 5mm**DUT: VOS 5G Dongle; Type: VOS5-GC-1**

Communication System: UID 0, LTE Band7; Frequency: 2560 MHz;

Communication System PAR: 0 dB

Medium parameters used: $f = 2560$ MHz; $\sigma = 1.95$ S/m; $\epsilon_r = 39.47$; $\rho = 1000$ kg/m³

Phantom section: Flat Section

Ambient Temperature (°C) : 22.6, Liquid Temperature (°C) : 22.1

Measurement Standard: DASYS (IEEE/IEC/ANSI C63.19-2011)

DASY5 Configuration:

- Probe: EX3DV4 - SN3698; ConvF(6.97, 6.97, 6.97); Calibrated: 2021/11/24;
- Sensor-Surface: 1.4mm (Mechanical Surface Detection)
- Electronics: DAE4 Sn1207; Calibrated: 2021/11/22
- Phantom: SAM with right table; Type: SAM;
- Measurement SW: DASY52, Version 52.10 (0); SEMCAD X Version 14.6.10 (7417)

Configuration/Flat/Area Scan (7x11x1): Measurement grid: dx=12mm, dy=12mm

Maximum value of SAR (measured) = 1.09 W/kg

Configuration/Flat/Zoom Scan (7x7x7)/Cube 0: Measurement grid: dx=5mm, dy=5mm, dz=5mm

Reference Value = 29.67 V/m; Power Drift = -0.07 dB

Peak SAR (extrapolated) = 2.09 W/kg

SAR(1 g) = 0.867 W/kg; SAR(10 g) = 0.340 W/kg

Maximum value of SAR (measured) = 1.61 W/kg

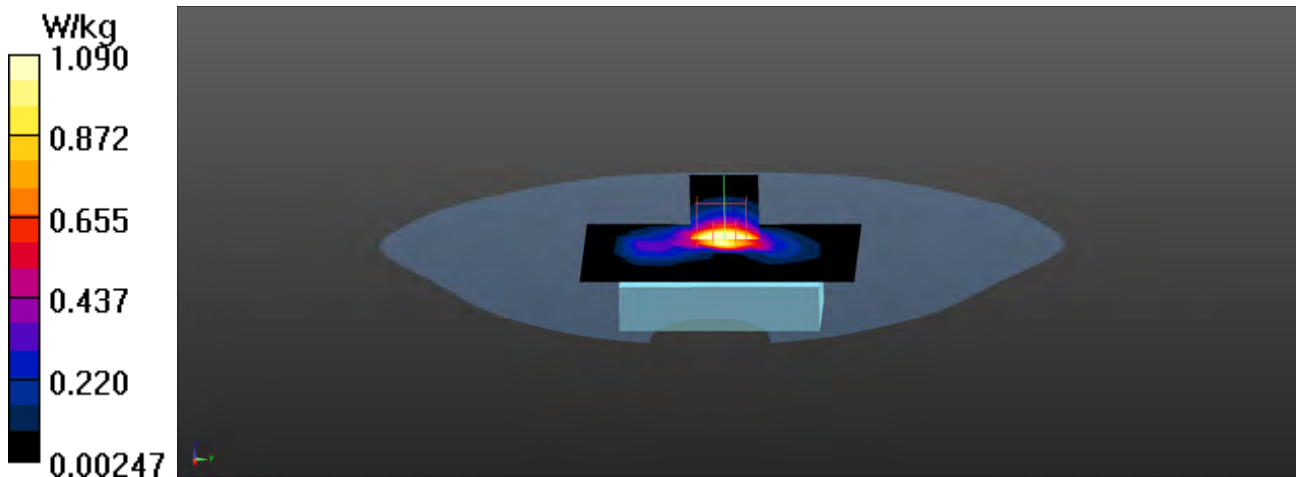

LTE Band 7 20M QPSK 1RB-0 Front (ANT 0 5mm) Z-Axis plot

Channel: 21350

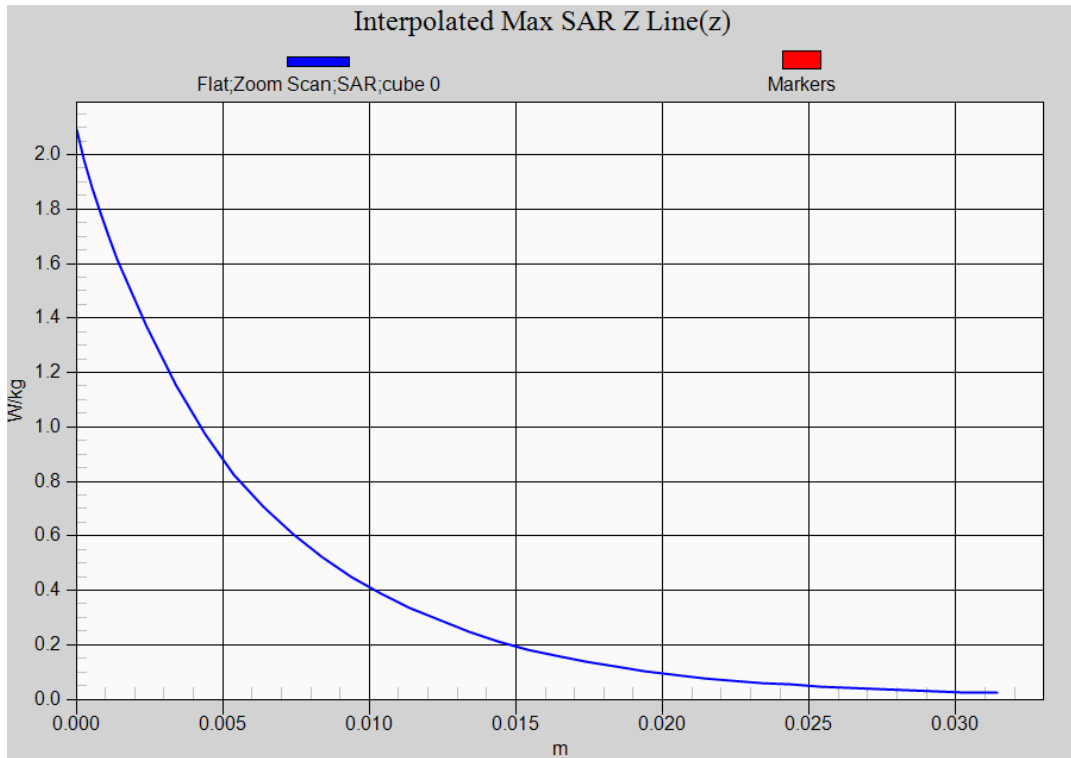

Test Laboratory: DEKRA

Date: 2022/11/10

LTE_Band12_QPSK_10M_23095_1RB-0_Front_ANT 0 5mm**DUT: VOS 5G Dongle; Type: VOS5-GC-1**

Communication System: UID 0, LTE Band12; Frequency: 707.5 MHz;

Communication System PAR: 0 dB

Medium parameters used: $f = 707.5$ MHz; $\sigma = 0.87$ S/m; $\epsilon_r = 42.37$; $\rho = 1000$ kg/m³

Phantom section: Flat Section

Ambient Temperature (°C) : 22.6, Liquid Temperature (°C) : 21.8

Measurement Standard: DASYS (IEEE/IEC/ANSI C63.19-2011)

DASY5 Configuration:

- Probe: EX3DV4 - SN3698; ConvF(9.1, 9.1, 9.1); Calibrated: 2021/11/24;
- Sensor-Surface: 1.4mm (Mechanical Surface Detection)
- Electronics: DAE4 Sn1207; Calibrated: 2021/11/22
- Phantom: SAM with right table; Type: SAM;
- Measurement SW: DASY52, Version 52.10 (0); SEMCAD X Version 14.6.10 (7417)

Configuration/Flat/Area Scan (6x9x1): Measurement grid: dx=15mm, dy=15mm

Maximum value of SAR (measured) = 0.932 W/kg

Configuration/Flat/Zoom Scan (5x5x7)/Cube 0: Measurement grid: dx=8mm, dy=8mm, dz=5mm

Reference Value = 23.20 V/m; Power Drift = 0.09 dB

Peak SAR (extrapolated) = 1.36 W/kg

SAR(1 g) = 0.625 W/kg; SAR(10 g) = 0.327 W/kg

Maximum value of SAR (measured) = 1.06 W/kg

Configuration/Flat/Zoom Scan (5x5x7)/Cube 1: Measurement grid: dx=8mm, dy=8mm, dz=5mm

Reference Value = 23.20 V/m; Power Drift = 0.09 dB

Peak SAR (extrapolated) = 1.59 W/kg

SAR(1 g) = 0.599 W/kg; SAR(10 g) = 0.316 W/kg

Maximum value of SAR (measured) = 1.10 W/kg

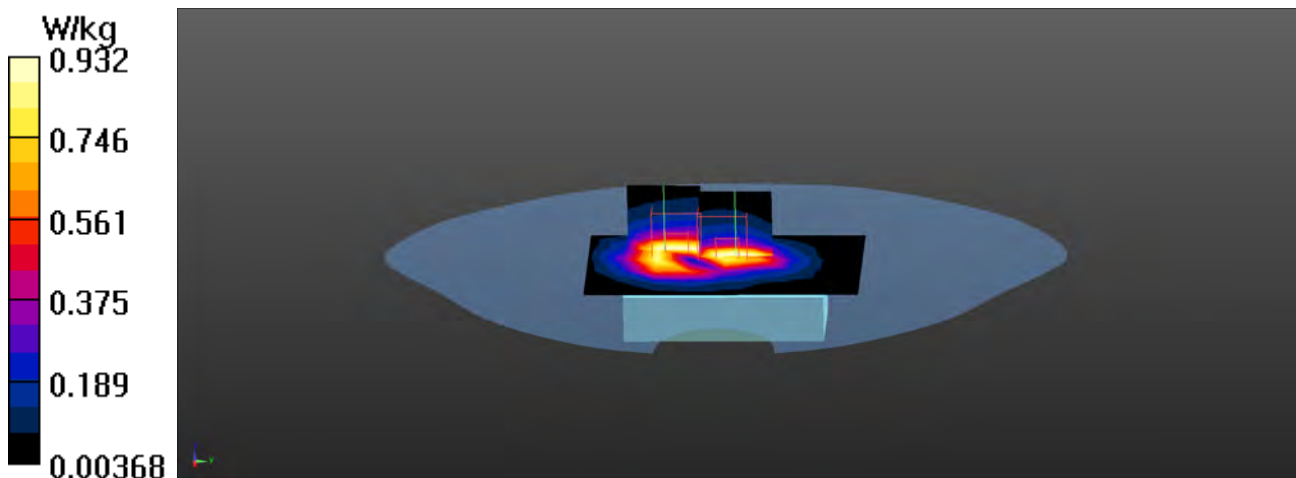

LTE Band 12 10M QPSK 1RB-0 Front (ANT 0 5mm) Z-Axis plot

Channel: 23095

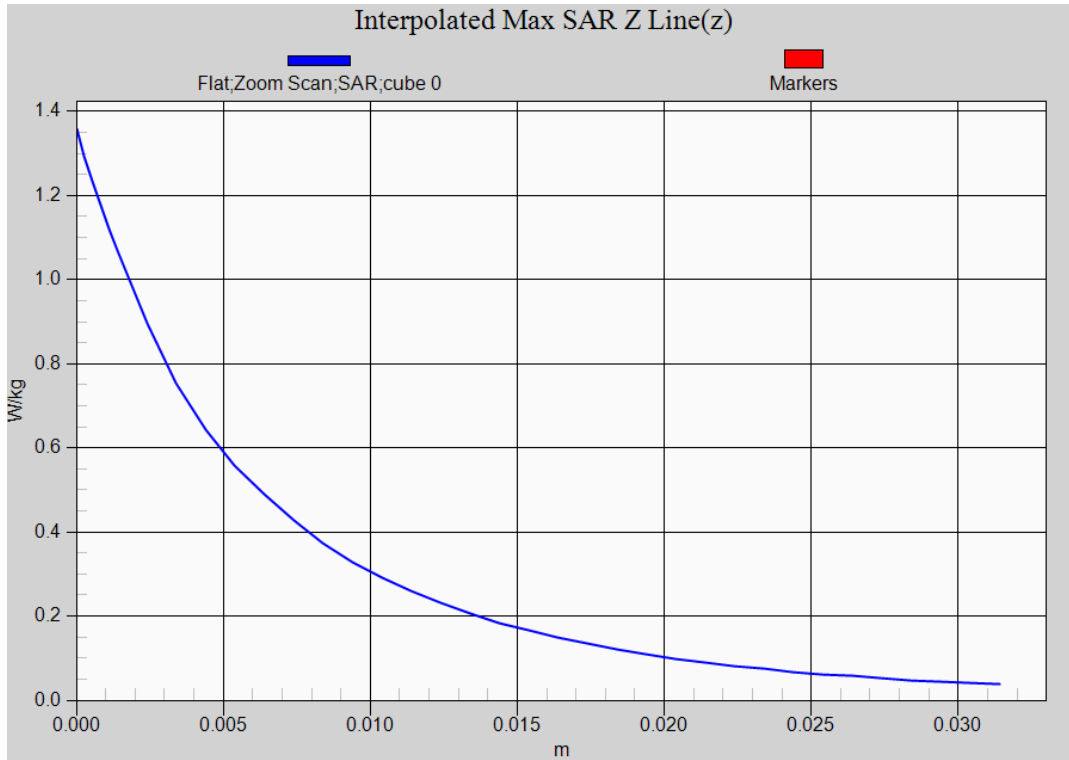

Test Laboratory: DEKRA

Date: 2022/11/10

LTE_Band13_QPSK_10M_23230_1RB-0_Front_ANT 0 5mm**DUT: VOS 5G Dongle; Type: VOS5-GC-1**

Communication System: UID 0, LTE Band13; Frequency: 782 MHz;

Communication System PAR: 0 dB

Medium parameters used: $f = 782$ MHz; $\sigma = 0.89$ S/m; $\epsilon_r = 41.54$; $\rho = 1000$ kg/m³

Phantom section: Flat Section

Ambient Temperature (°C) : 22.6, Liquid Temperature (°C) : 21.8

Measurement Standard: DASYS5 (IEEE/IEC/ANSI C63.19-2011)

DASY5 Configuration:

- Probe: EX3DV4 - SN3698; ConvF(9.1, 9.1, 9.1); Calibrated: 2021/11/24;
- Sensor-Surface: 1.4mm (Mechanical Surface Detection)
- Electronics: DAE4 Sn1207; Calibrated: 2021/11/22
- Phantom: SAM with right table; Type: SAM;
- Measurement SW: DASYS52, Version 52.10 (0); SEMCAD X Version 14.6.10 (7417)

Configuration/Flat/Area Scan (6x9x1): Measurement grid: dx=15mm, dy=15mm

Maximum value of SAR (measured) = 1.17 W/kg

Configuration/Flat/Zoom Scan (5x5x7)/Cube 0: Measurement grid: dx=8mm, dy=8mm, dz=5mm

Reference Value = 24.29 V/m; Power Drift = -0.13 dB

Peak SAR (extrapolated) = 1.64 W/kg

SAR(1 g) = 0.756 W/kg; SAR(10 g) = 0.390 W/kg

Maximum value of SAR (measured) = 1.29 W/kg

Configuration/Flat/Zoom Scan (5x5x7)/Cube 1: Measurement grid: dx=8mm, dy=8mm, dz=5mm

Reference Value = 24.29 V/m; Power Drift = -0.13 dB

Peak SAR (extrapolated) = 1.54 W/kg

SAR(1 g) = 0.596 W/kg; SAR(10 g) = 0.296 W/kg

Maximum value of SAR (measured) = 1.15 W/kg

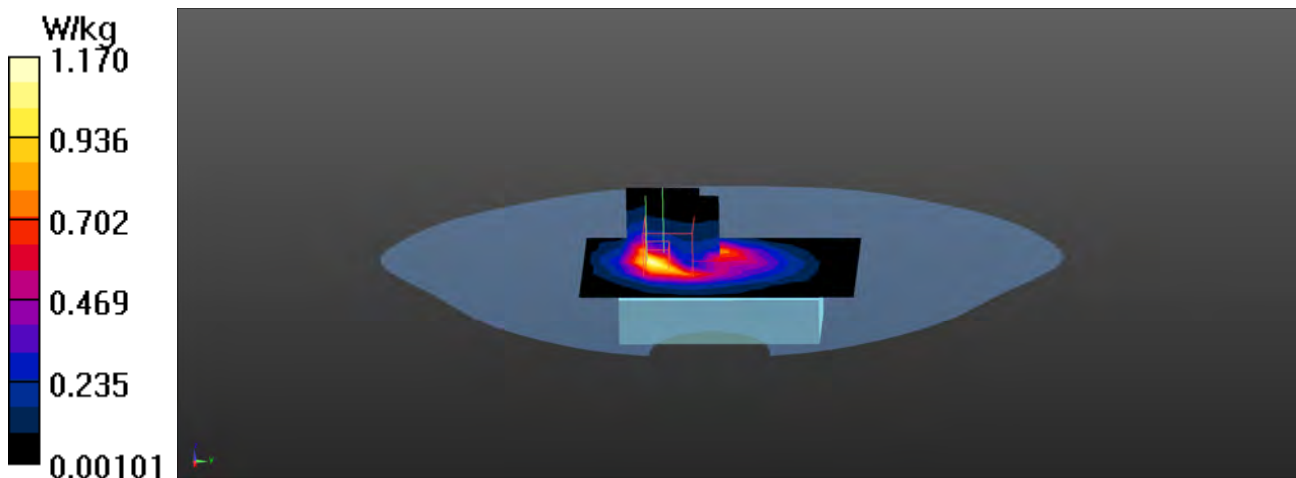

LTE Band 13 10M QPSK 1RB-0 Front (ANT 0 5mm) Z-Axis plot

Channel: 23230

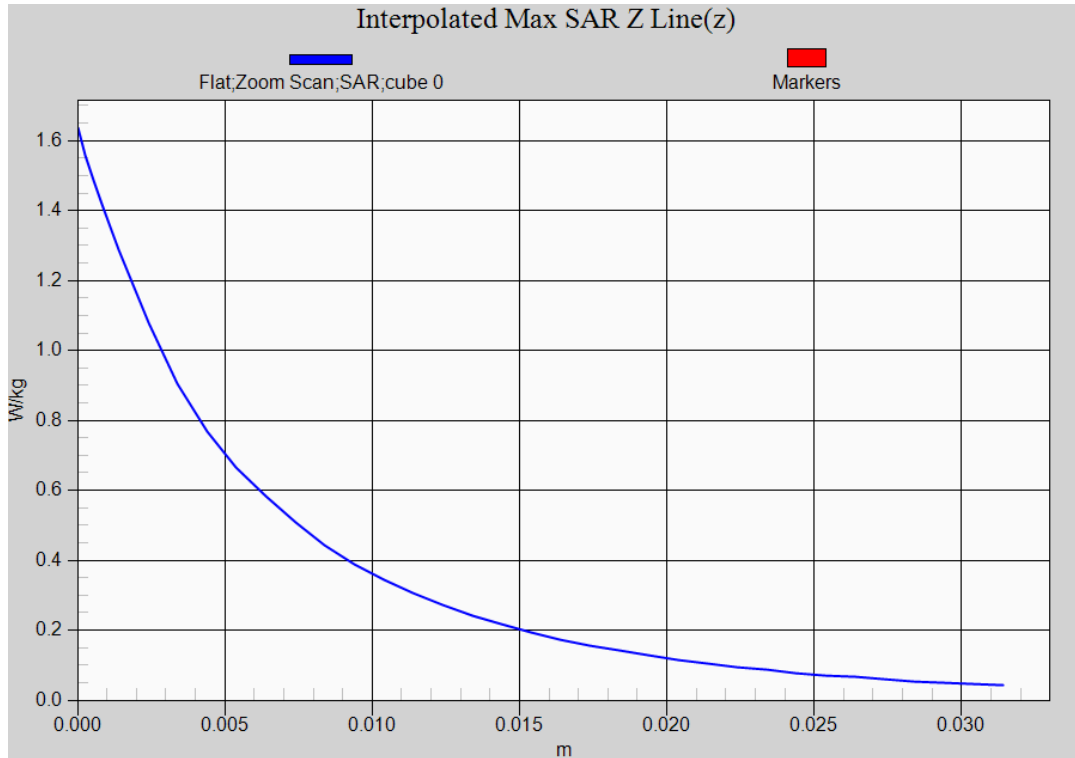

Test Laboratory: DEKRA

Date: 2022/11/10

LTE_Band14_QPSK_10M_23330_1RB-0_Front_ANT 0 5mm**DUT: VOS 5G Dongle; Type: VOS5-GC-1**

Communication System: UID 0, LTE Band14; Frequency: 793 MHz;

Communication System PAR: 0 dB

Medium parameters used: $f = 793$ MHz; $\sigma = 0.9$ S/m; $\epsilon_r = 41.42$; $\rho = 1000$ kg/m³

Phantom section: Flat Section

Ambient Temperature (°C) : 22.6, Liquid Temperature (°C) : 21.8

Measurement Standard: DASYS (IEEE/IEC/ANSI C63.19-2011)

DASY5 Configuration:

- Probe: EX3DV4 - SN3698; ConvF(9.1, 9.1, 9.1); Calibrated: 2021/11/24;
- Sensor-Surface: 1.4mm (Mechanical Surface Detection)
- Electronics: DAE4 Sn1207; Calibrated: 2021/11/22
- Phantom: SAM with right table; Type: SAM;
- Measurement SW: DASYS2, Version 52.10 (0); SEMCAD X Version 14.6.10 (7417)

Configuration/Flat/Area Scan (6x9x1): Measurement grid: dx=15mm, dy=15mm

Maximum value of SAR (measured) = 1.13 W/kg

Configuration/Flat/Zoom Scan (5x5x7)/Cube 0: Measurement grid: dx=8mm, dy=8mm, dz=5mm

Reference Value = 24.69 V/m; Power Drift = -0.15 dB

Peak SAR (extrapolated) = 1.64 W/kg

SAR(1 g) = 0.751 W/kg; SAR(10 g) = 0.387 W/kg

Maximum value of SAR (measured) = 1.29 W/kg

Configuration/Flat/Zoom Scan (5x5x7)/Cube 1: Measurement grid: dx=8mm, dy=8mm, dz=5mm

Reference Value = 24.69 V/m; Power Drift = -0.15 dB

Peak SAR (extrapolated) = 1.51 W/kg

SAR(1 g) = 0.589 W/kg; SAR(10 g) = 0.293 W/kg

Maximum value of SAR (measured) = 1.14 W/kg

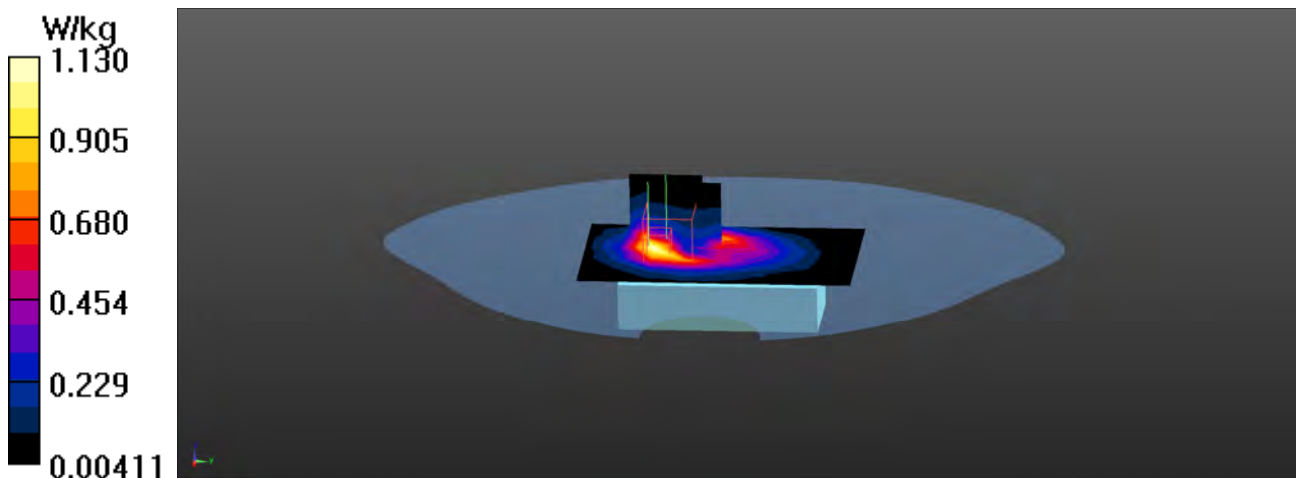

LTE Band 14 10M QPSK 1RB-0 Front (ANT 0 5mm) Z-Axis plot

Channel: 23330

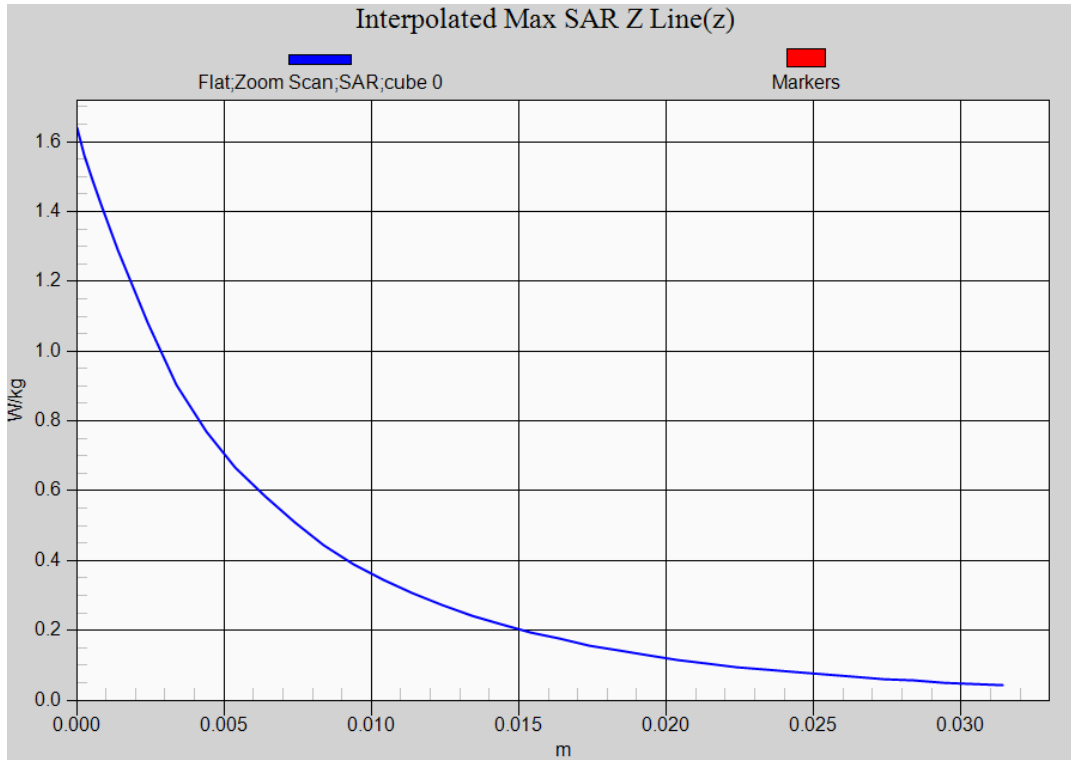

Test Laboratory: DEKRA

Date: 2022/11/20

LTE_Band25_QPSK_20M_26140_1RB-0_Front_ANT 0 5mm**DUT: VOS 5G Dongle; Type: VOS5-GC-1**

Communication System: UID 0, LTE Band25; Frequency: 1860 MHz;

Communication System PAR: 0 dB

Medium parameters used: $f = 1860$ MHz; $\sigma = 1.36$ S/m; $\epsilon_r = 41.16$; $\rho = 1000$ kg/m³

Phantom section: Flat Section

Ambient Temperature (°C) : 22.6, Liquid Temperature (°C) : 22.1

Measurement Standard: DASYS (IEEE/IEC/ANSI C63.19-2011)

DASY5 Configuration:

- Probe: EX3DV4 - SN3698; ConvF(7.6, 7.6, 7.6); Calibrated: 2021/11/24;
- Sensor-Surface: 1.4mm (Mechanical Surface Detection)
- Electronics: DAE4 Sn1207; Calibrated: 2021/11/22
- Phantom: SAM with right table; Type: SAM;
- Measurement SW: DASYS2, Version 52.10 (0); SEMCAD X Version 14.6.10 (7417)

Configuration/Flat/Area Scan (6x9x1): Measurement grid: dx=15mm, dy=15mm

Maximum value of SAR (measured) = 1.17 W/kg

Configuration/Flat/Zoom Scan (5x5x7)/Cube 0: Measurement grid: dx=8mm, dy=8mm, dz=5mm

Reference Value = 30.02 V/m; Power Drift = -0.13 dB

Peak SAR (extrapolated) = 1.75 W/kg

SAR(1 g) = 0.782 W/kg; SAR(10 g) = 0.392 W/kg

Maximum value of SAR (measured) = 1.35 W/kg

Configuration/Flat/Zoom Scan (5x5x7)/Cube 1: Measurement grid: dx=8mm, dy=8mm, dz=5mm

Reference Value = 30.02 V/m; Power Drift = -0.13 dB

Peak SAR (extrapolated) = 1.46 W/kg

SAR(1 g) = 0.552 W/kg; SAR(10 g) = 0.256 W/kg

Maximum value of SAR (measured) = 1.15 W/kg

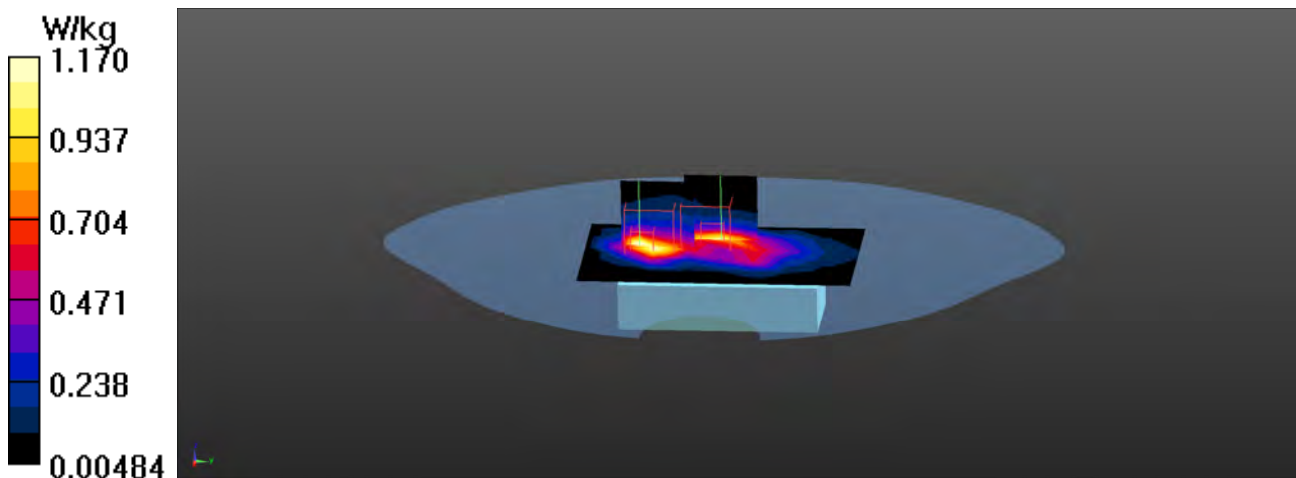

LTE Band 25 20M QPSK 1RB-0 Front (ANT 0 5mm) Z-Axis plot

Channel: 26140

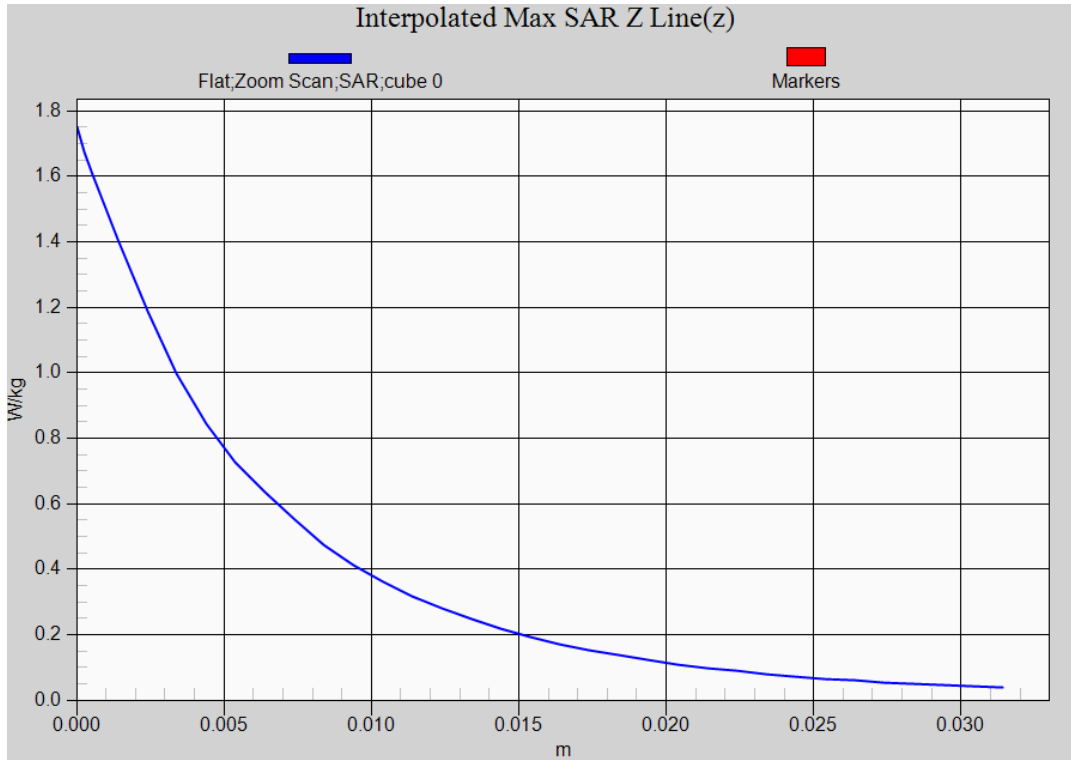

Test Laboratory: DEKRA

Date: 2022/11/14

LTE_Band26_QPSK_15M_26865_1RB-0_Front_ANT 0 5mm**DUT: VOS 5G Dongle; Type: VOS5-GC-1**

Communication System: UID 0, FCC LTE Band26; Frequency: 831.5 MHz;

Communication System PAR: 0 dB

Medium parameters used: $f = 831.5$ MHz; $\sigma = 0.91$ S/m; $\epsilon_r = 40.82$; $\rho = 1000$ kg/m³

Phantom section: Flat Section

Ambient Temperature (°C) : 22.8, Liquid Temperature (°C) : 22.2

Measurement Standard: DASY5 (IEEE/IEC/ANSI C63.19-2011)

DASY5 Configuration:

- Probe: EX3DV4 - SN3698; ConvF(8.9, 8.9, 8.9); Calibrated: 2021/11/24;
- Sensor-Surface: 1.4mm (Mechanical Surface Detection)
- Electronics: DAE4 Sn1207; Calibrated: 2021/11/22
- Phantom: SAM with right table; Type: SAM;
- Measurement SW: DASY52, Version 52.10 (0); SEMCAD X Version 14.6.10 (7417)

Configuration/Flat/Area Scan (6x9x1): Measurement grid: dx=15mm, dy=15mm

Maximum value of SAR (measured) = 1.10 W/kg

Configuration/Flat/Zoom Scan (5x5x7)/Cube 0: Measurement grid: dx=8mm, dy=8mm, dz=5mm

Reference Value = 20.74 V/m; Power Drift = -0.17 dB

Peak SAR (extrapolated) = 1.57 W/kg

SAR(1 g) = 0.717 W/kg; SAR(10 g) = 0.368 W/kg

Maximum value of SAR (measured) = 1.24 W/kg

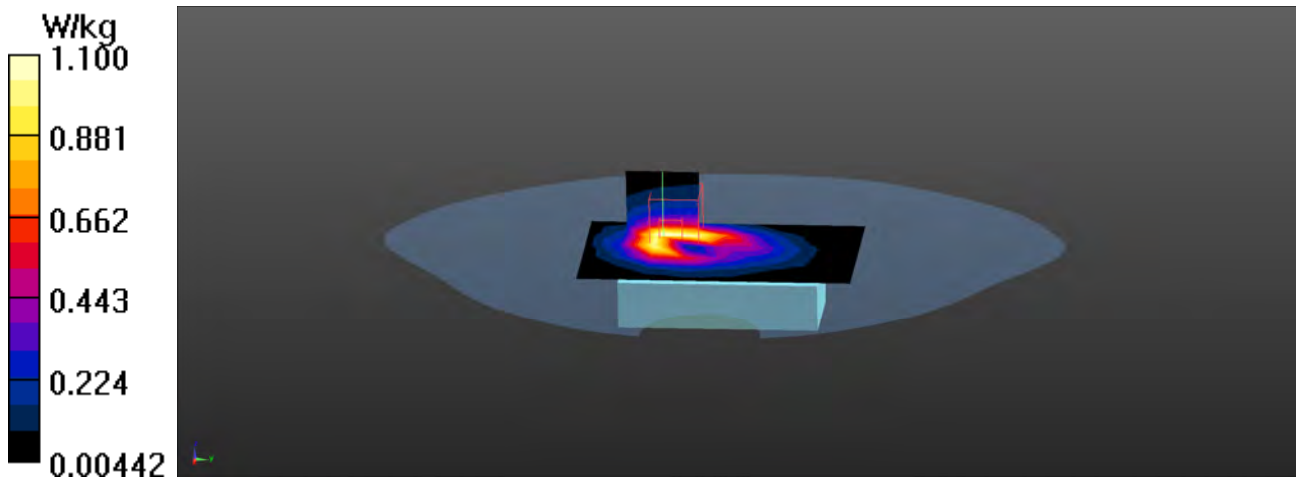

LTE Band 26 15M QPSK 1RB-0 Front (ANT 0 5mm) Z-Axis plot

Channel: 26865

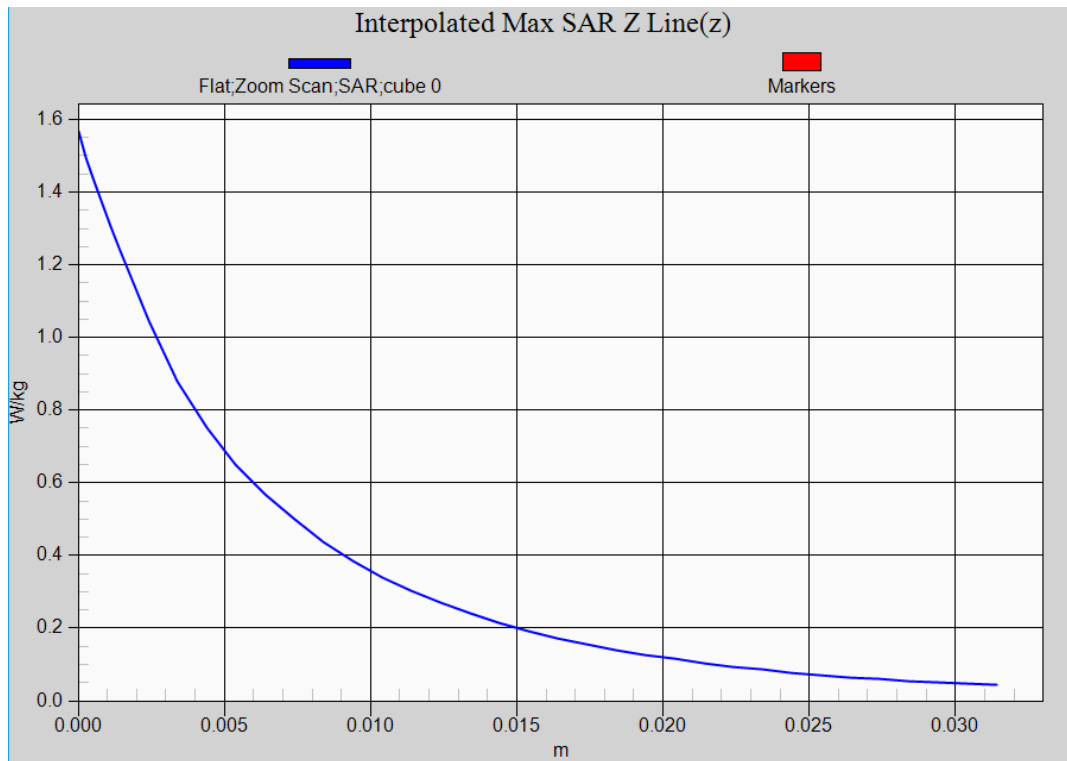

Test Laboratory: DEKRA

Date: 2022/11/09

LTE_Band30_QPSK_10M_27710_1RB-0_Front_ANT 0 5mm**DUT: VOS 5G Dongle; Type: VOS5-GC-1**

Communication System: UID 0, LTE BAND 30; Frequency: 2310 MHz;

Communication System PAR: 0 dB

Medium parameters used: $f = 2310$ MHz; $\sigma = 1.66$ S/m; $\epsilon_r = 39.33$; $\rho = 1000$ kg/m³

Phantom section: Flat Section

Ambient Temperature (°C) : 22.6, Liquid Temperature (°C) : 22.1

Measurement Standard: DASYS (IEEE/IEC/ANSI C63.19-2011)

DASY5 Configuration:

- Probe: EX3DV4 - SN3698; ConvF(7.39, 7.39, 7.39); Calibrated: 2021/11/24;
- Sensor-Surface: 1.4mm (Mechanical Surface Detection)
- Electronics: DAE4 Sn1207; Calibrated: 2021/11/22
- Phantom: SAM with right table; Type: SAM;
- Measurement SW: DASYS2, Version 52.10 (0); SEMCAD X Version 14.6.10 (7417)

Configuration/Flat/Area Scan (7x11x1): Measurement grid: dx=12mm, dy=12mm

Maximum value of SAR (measured) = 1.05 W/kg

Configuration/Flat/Zoom Scan (7x7x7)/Cube 0: Measurement grid: dx=5mm, dy=5mm, dz=5mm

Reference Value = 31.30 V/m; Power Drift = -0.11 dB

Peak SAR (extrapolated) = 2.24 W/kg

SAR(1 g) = 0.946 W/kg; SAR(10 g) = 0.391 W/kg

Maximum value of SAR (measured) = 1.69 W/kg

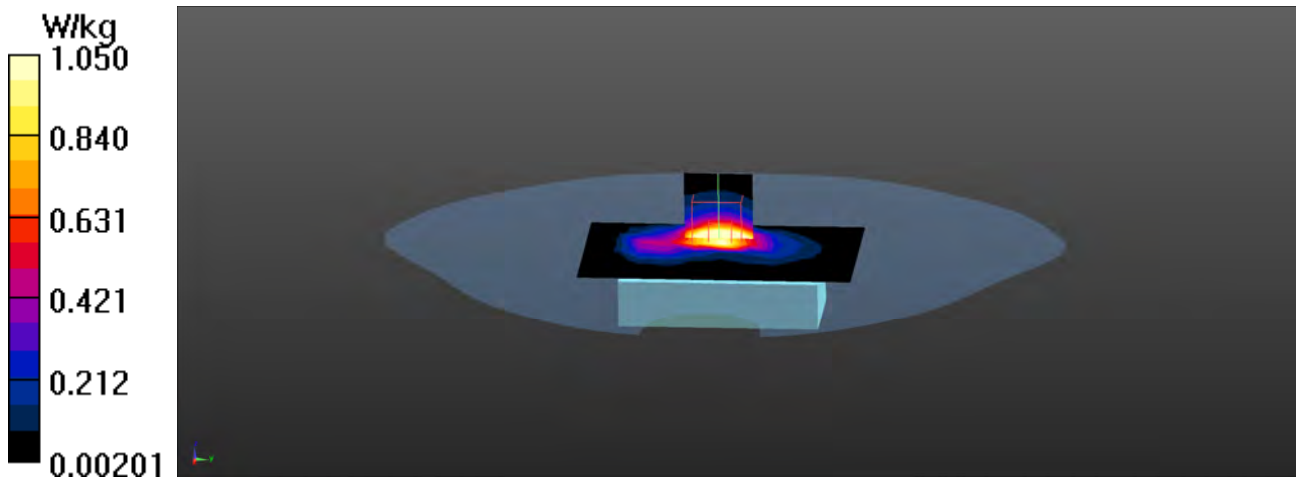

LTE Band 30 10M QPSK 1RB-0 Front (ANT 0 5mm) Z-Axis plot

Channel: 27710

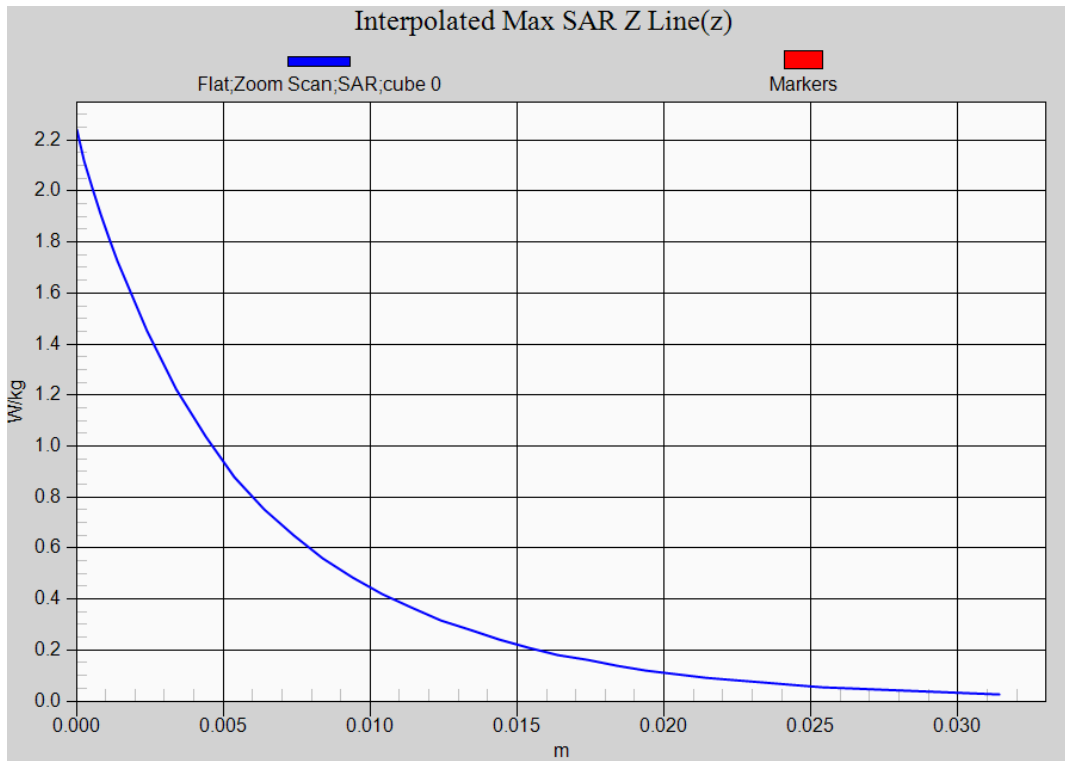

Test Laboratory: DEKRA

Date: 2022/11/09

LTE_Band41_QPSK_20M_41490_PRB-0_Front_ANT 0 5mm**DUT: VOS 5G Dongle; Type: VOS5-GC-1**

Communication System: UID 0, FCC LTE-TDD Band41; Frequency: 2680 MHz;

Communication System PAR: 2.014 dB

Medium parameters used: $f = 2680$ MHz; $\sigma = 2.01$ S/m; $\epsilon_r = 38.04$; $\rho = 1000$ kg/m³

Phantom section: Flat Section

Ambient Temperature (°C) : 22.6, Liquid Temperature (°C) : 22.1

Measurement Standard: DASYS (IEEE/IEC/ANSI C63.19-2011)

DASY5 Configuration:

- Probe: EX3DV4 - SN3698; ConvF(6.97, 6.97, 6.97); Calibrated: 2021/11/24;
- Sensor-Surface: 1.4mm (Mechanical Surface Detection)
- Electronics: DAE4 Sn1207; Calibrated: 2021/11/22
- Phantom: SAM with right table; Type: SAM;
- Measurement SW: DASY52, Version 52.10 (0); SEMCAD X Version 14.6.10 (7417)

Configuration/Flat/Area Scan (7x11x1): Measurement grid: dx=12mm, dy=12mm

Maximum value of SAR (measured) = 1.03 W/kg

Configuration/Flat/Zoom Scan (7x7x7)/Cube 0: Measurement grid: dx=5mm, dy=5mm, dz=5mm

Reference Value = 30.09 V/m; Power Drift = -0.16 dB

Peak SAR (extrapolated) = 2.28 W/kg

SAR(1 g) = 0.925 W/kg; SAR(10 g) = 0.356 W/kg

Maximum value of SAR (measured) = 1.73 W/kg

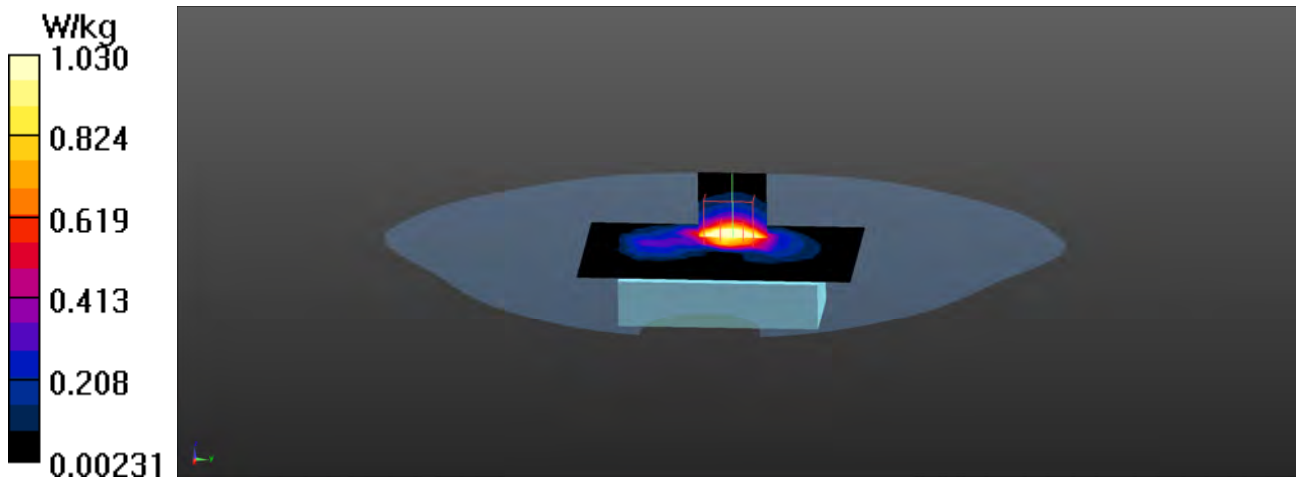

LTE Band 41 20M QPSK PRB-0 Front (ANT 0 5mm) Z-Axis plot

Channel: 41490

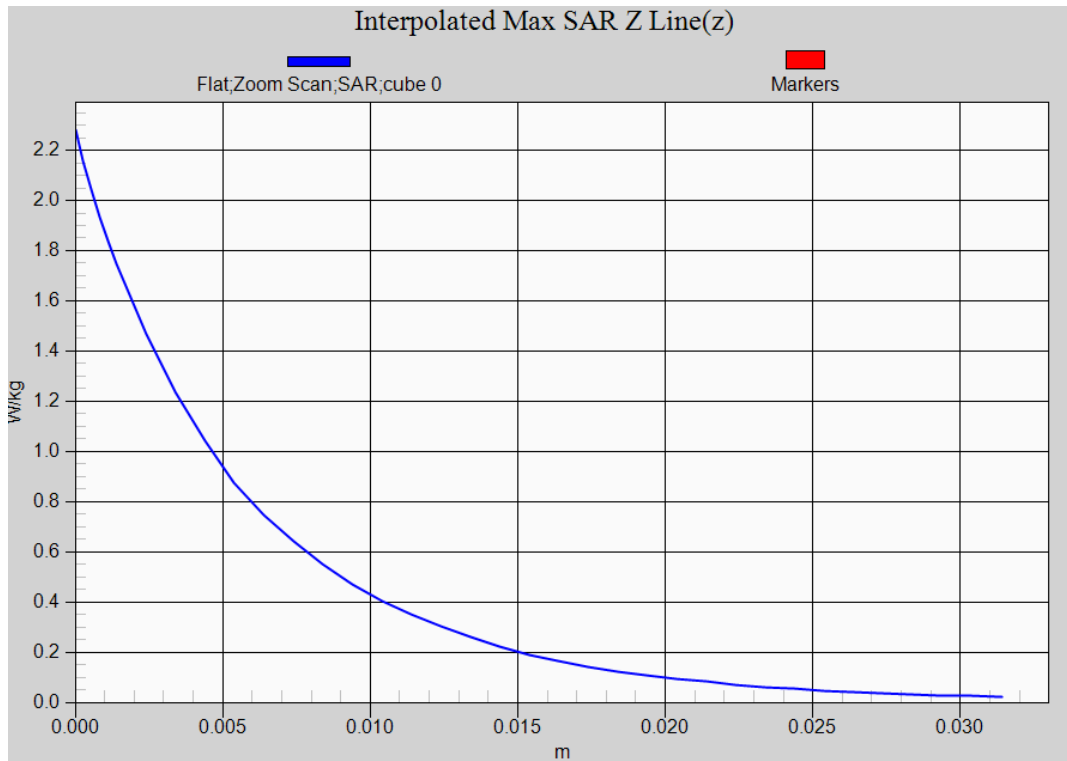

Test Laboratory: DEKRA

Date: 2022/11/20

LTE_Band48_QPSK_20M_56640_1RB-0_Front_ANT 2 5mm**DUT: VOS 5G Dongle; Type: VOS5-GC-1**

Communication System: UID 0, FCC LTE-TDD Band48; Frequency: 3690 MHz;

Communication System PAR: 2.014 dB

Medium parameters used: $f = 3690$ MHz; $\sigma = 3.12$ S/m; $\epsilon_r = 37.59$; $\rho = 1000$ kg/m³

Phantom section: Flat Section

Ambient Temperature (°C) : 22.6, Liquid Temperature (°C) : 22.1

Measurement Standard: DASYS5 (IEEE/IEC/ANSI C63.19-2011)

DASY5 Configuration:

- Probe: EX3DV4 - SN3698; ConvF(6.15, 6.15, 6.15); Calibrated: 2021/11/24;
- Sensor-Surface: 1.4mm (Mechanical Surface Detection)
- Electronics: DAE4 Sn1207; Calibrated: 2021/11/22
- Phantom: SAM with right table; Type: SAM;
- Measurement SW: DASYS2, Version 52.10 (0); SEMCAD X Version 14.6.10 (7417)

Configuration/Flat/Area Scan (7x11x1): Measurement grid: dx=12mm, dy=12mm

Maximum value of SAR (measured) = 1.86 W/kg

Configuration/Flat/Zoom Scan (7x7x7)/Cube 0: Measurement grid: dx=5mm, dy=5mm, dz=1.4mm

Reference Value = 27.13 V/m; Power Drift = 0.03 dB

Peak SAR (extrapolated) = 2.99 W/kg

SAR(1 g) = 0.959 W/kg; SAR(10 g) = 0.312 W/kg

Maximum value of SAR (measured) = 2.05 W/kg

Configuration/Flat/Zoom Scan (7x7x7)/Cube 1: Measurement grid: dx=5mm, dy=5mm, dz=1.4mm

Reference Value = 27.13 V/m; Power Drift = 0.03 dB

Peak SAR (extrapolated) = 2.19 W/kg

SAR(1 g) = 0.740 W/kg; SAR(10 g) = 0.266 W/kg

Maximum value of SAR (measured) = 1.52 W/kg

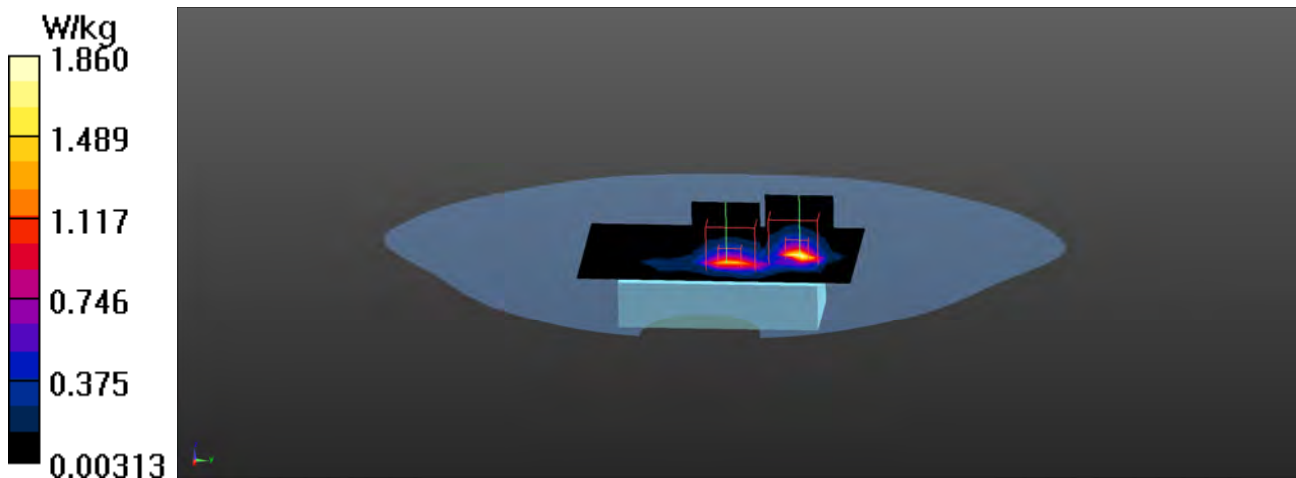

LTE Band 48 20M QPSK 1RB-0 Front (ANT 2 5mm) Z-Axis plot

Channel: 56640

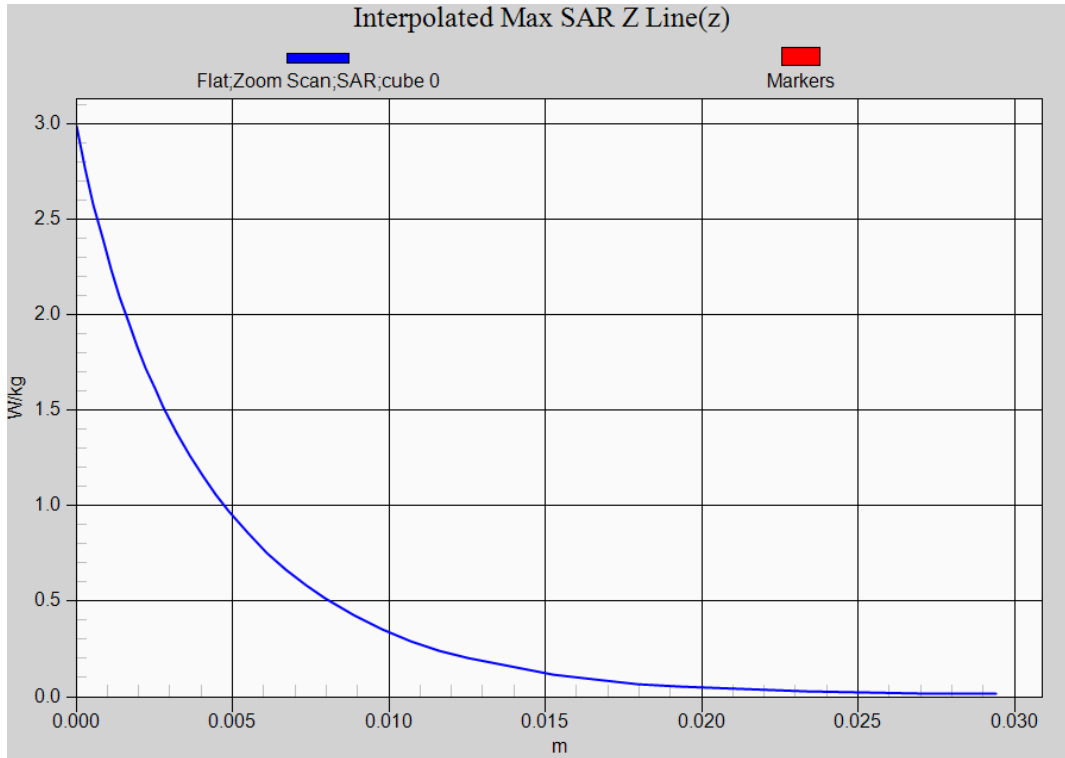

Test Laboratory: DEKRA

Date: 2022/11/19

LTE_Band66_QPSK_20M_132322_FRB-0_Front_ANT 0 5mm**DUT: VOS 5G Dongle; Type: VOS5-GC-1**

Communication System: UID 0, FCC LTE Band66; Frequency: 1745 MHz;

Communication System PAR: 0 dB

Medium parameters used: $f = 1745$ MHz; $\sigma = 1.37$ S/m; $\epsilon_r = 40.22$; $\rho = 1000$ kg/m³

Phantom section: Flat Section

Ambient Temperature (°C) : 22.5, Liquid Temperature (°C) : 21.6

Measurement Standard: DASYS (IEEE/IEC/ANSI C63.19-2011)

DASY5 Configuration:

- Probe: EX3DV4 - SN3698; ConvF(7.96, 7.96, 7.96); Calibrated: 2021/11/24;
- Sensor-Surface: 1.4mm (Mechanical Surface Detection)
- Electronics: DAE4 Sn1207; Calibrated: 2021/11/22
- Phantom: SAM with right table; Type: SAM;
- Measurement SW: DASYS2, Version 52.10 (0); SEMCAD X Version 14.6.10 (7417)

Configuration/Flat/Area Scan (6x9x1): Measurement grid: dx=15mm, dy=15mm

Maximum value of SAR (measured) = 1.49 W/kg

Configuration/Flat/Zoom Scan (5x5x7)/Cube 0: Measurement grid: dx=8mm, dy=8mm, dz=5mm

Reference Value = 34.94 V/m; Power Drift = -0.06 dB

Peak SAR (extrapolated) = 2.09 W/kg

SAR(1 g) = 0.968 W/kg; SAR(10 g) = 0.444 W/kg

Maximum value of SAR (measured) = 1.65 W/kg

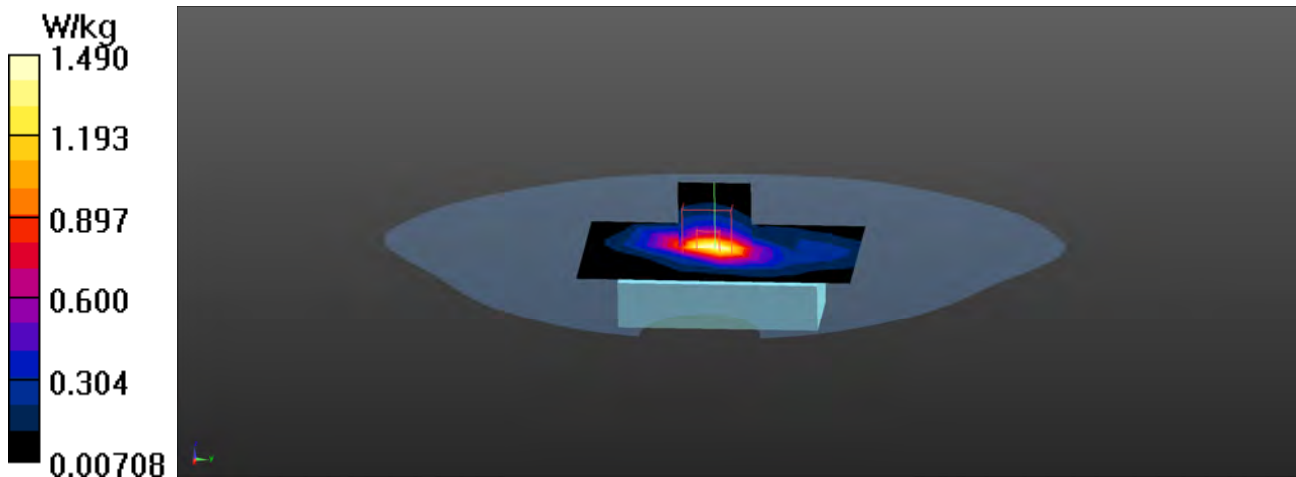

LTE Band 66 20M QPSK FRB-0 Front (ANT 0 5mm) Z-Axis plot

Channel: 132322

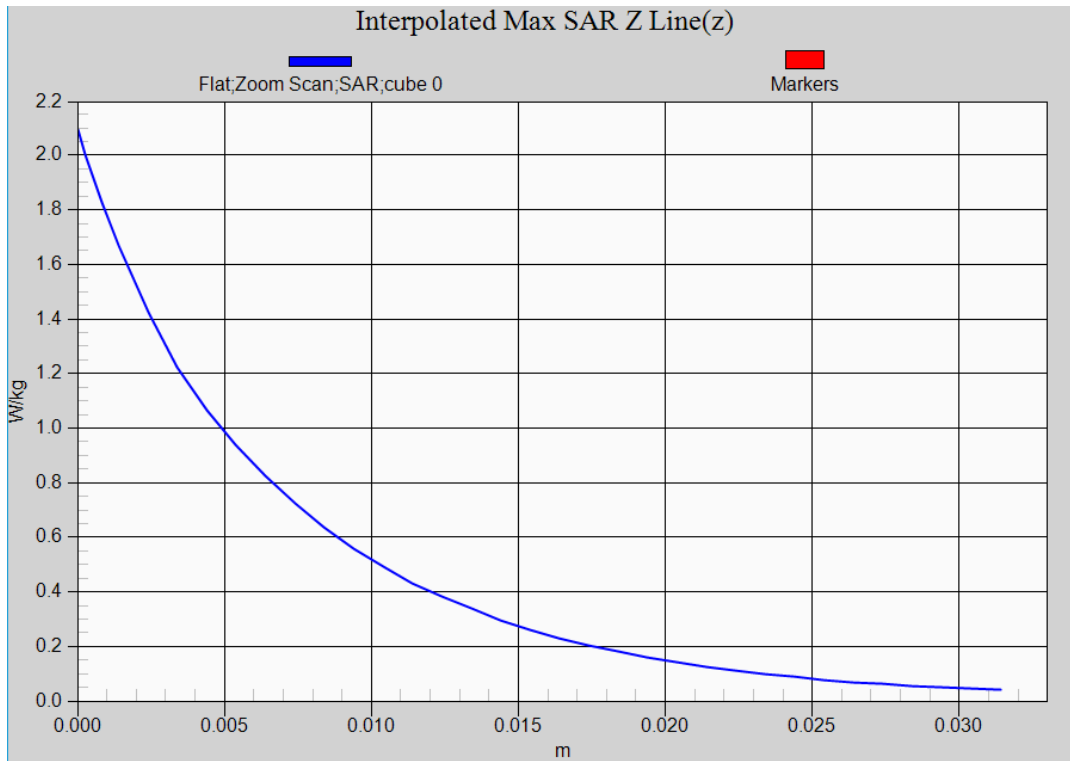

Test Laboratory: DEKRA

Date: 2022/11/11

LTE_Band71_QPSK_20M_133372_1RB-0_Front_ANT 0 5mm**DUT: VOS 5G Dongle; Type: VOS5-GC-1**

Communication System: UID 0, LTE B71; Frequency: 688 MHz;

Communication System PAR: 0 dB

Medium parameters used: $f = 688$ MHz; $\sigma = 0.88$ S/m; $\epsilon_r = 42.71$; $\rho = 1000$ kg/m³

Phantom section: Flat Section

Ambient Temperature (°C) : 22.5, Liquid Temperature (°C) : 21.9

Measurement Standard: DASY5 (IEEE/IEC/ANSI C63.19-2011)

DASY5 Configuration:

- Probe: EX3DV4 - SN3698; ConvF(9.1, 9.1, 9.1); Calibrated: 2021/11/24;
- Sensor-Surface: 1.4mm (Mechanical Surface Detection)
- Electronics: DAE4 Sn1207; Calibrated: 2021/11/22
- Phantom: SAM with right table; Type: SAM;
- Measurement SW: DASY52, Version 52.10 (0); SEMCAD X Version 14.6.10 (7417)

Configuration/Flat/Area Scan (8x10x1): Measurement grid: dx=15mm, dy=15mm

Maximum value of SAR (measured) = 0.884 W/kg

Configuration/Flat/Zoom Scan (5x5x7)/Cube 0: Measurement grid: dx=8mm, dy=8mm, dz=5mm

Reference Value = 33.71 V/m; Power Drift = -0.04 dB

Peak SAR (extrapolated) = 1.34 W/kg

SAR(1 g) = 0.453 W/kg; SAR(10 g) = 0.222 W/kg

Maximum value of SAR (measured) = 0.894 W/kg

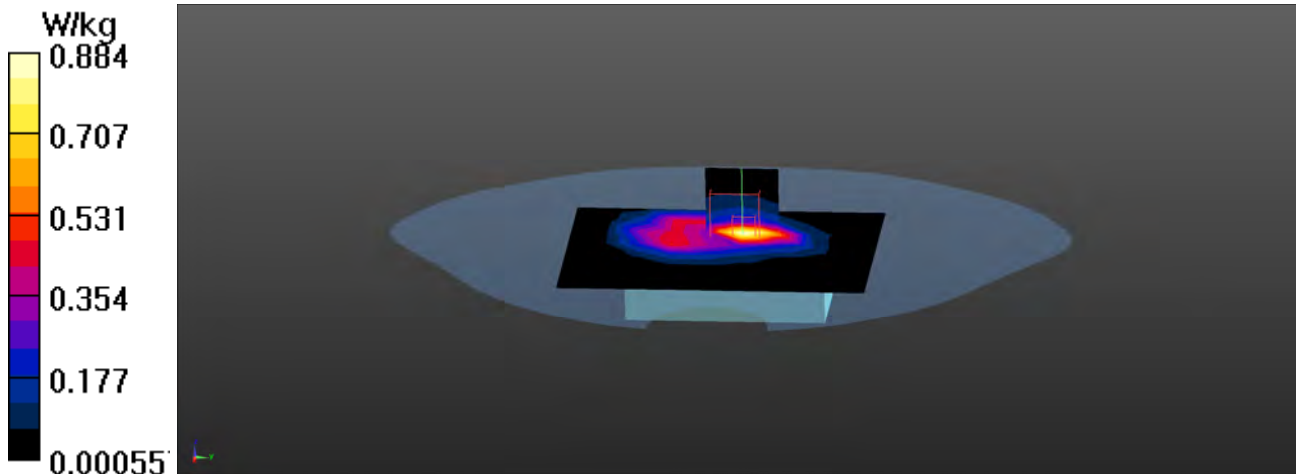

LTE Band 71 20M QPSK 1RB-0 Front (ANT 0 5mm) Z-Axis plot

Channel: 133372

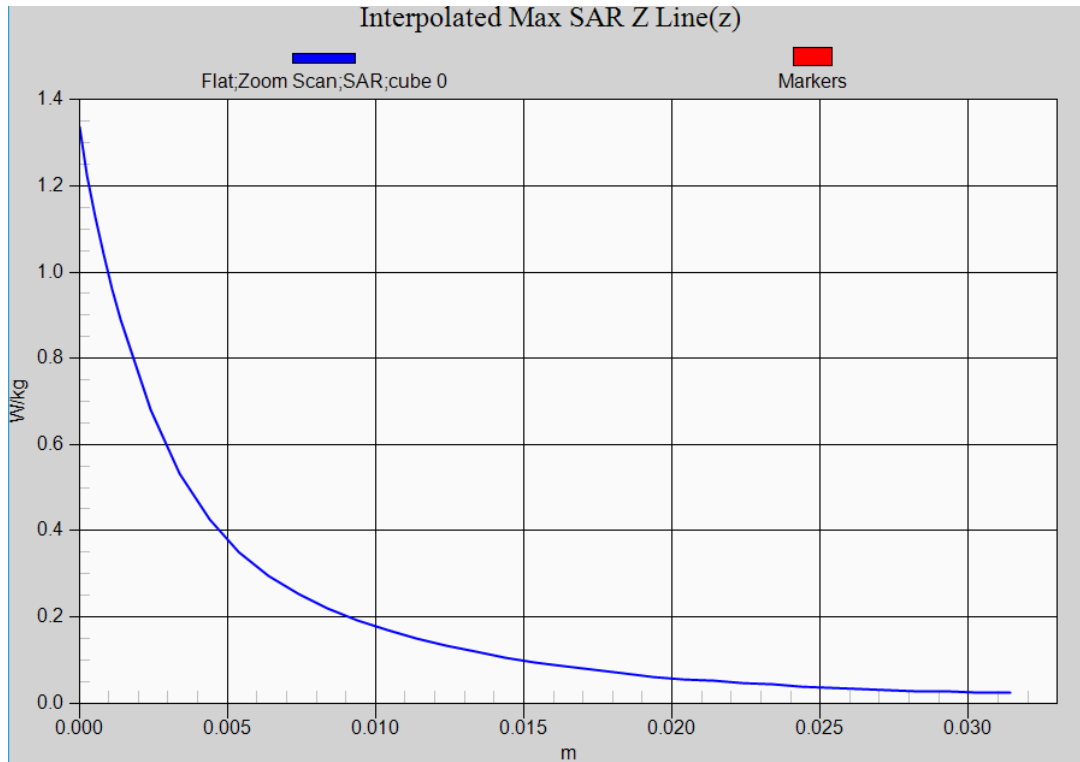

Test Laboratory: DEKRA

Date: 2022/11/20

NRn2_DFT_S_QPSK_20M_376000_1RB-1_Front_ANT 0 5mm**DUT: VOS 5G Dongle; Type: VOS5-GC-1**

Communication System: UID 0, 5G n2; Frequency: 1880 MHz;

Communication System PAR: 0 dB

Medium parameters used: $f = 1880$ MHz; $\sigma = 1.37$ S/m; $\epsilon_r = 40.93$; $\rho = 1000$ kg/m³

Phantom section: Flat Section

Ambient Temperature (°C) : 22.6, Liquid Temperature (°C) : 22.1

Measurement Standard: DASY5 (IEEE/IEC/ANSI C63.19-2011)

DASY5 Configuration:

- Probe: EX3DV4 - SN3698; ConvF(7.6, 7.6, 7.6); Calibrated: 2021/11/24;
- Sensor-Surface: 1.4mm (Mechanical Surface Detection)
- Electronics: DAE4 Sn1207; Calibrated: 2021/11/22
- Phantom: SAM with right table; Type: SAM;
- Measurement SW: DASY52, Version 52.10 (0); SEMCAD X Version 14.6.10 (7417)

Configuration/Flat/Area Scan (6x9x1): Measurement grid: dx=15mm, dy=15mm

Maximum value of SAR (measured) = 1.68 W/kg

Configuration/Flat/Zoom Scan (5x5x7)/Cube 0: Measurement grid: dx=8mm, dy=8mm, dz=5mm

Reference Value = 25.19 V/m; Power Drift = -0.14 dB

Peak SAR (extrapolated) = 1.98 W/kg

SAR(1 g) = 0.963 W/kg; SAR(10 g) = 0.498 W/kg

Maximum value of SAR (measured) = 1.50 W/kg

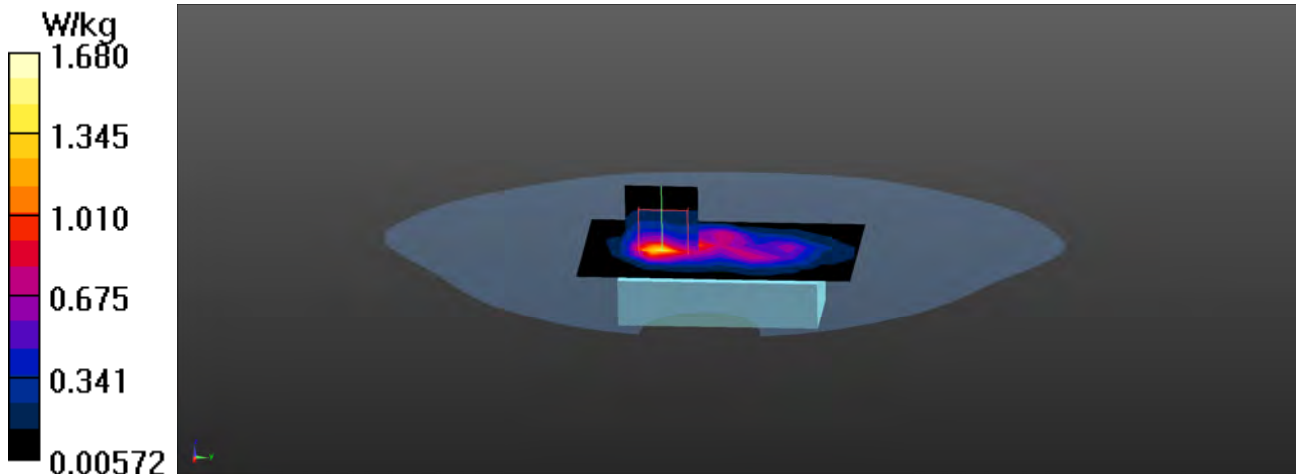

NRn2 20M DFT S QPSK 1RB-0 Front (ANT 0 5mm) Z-Axis plot

Channel: 376000

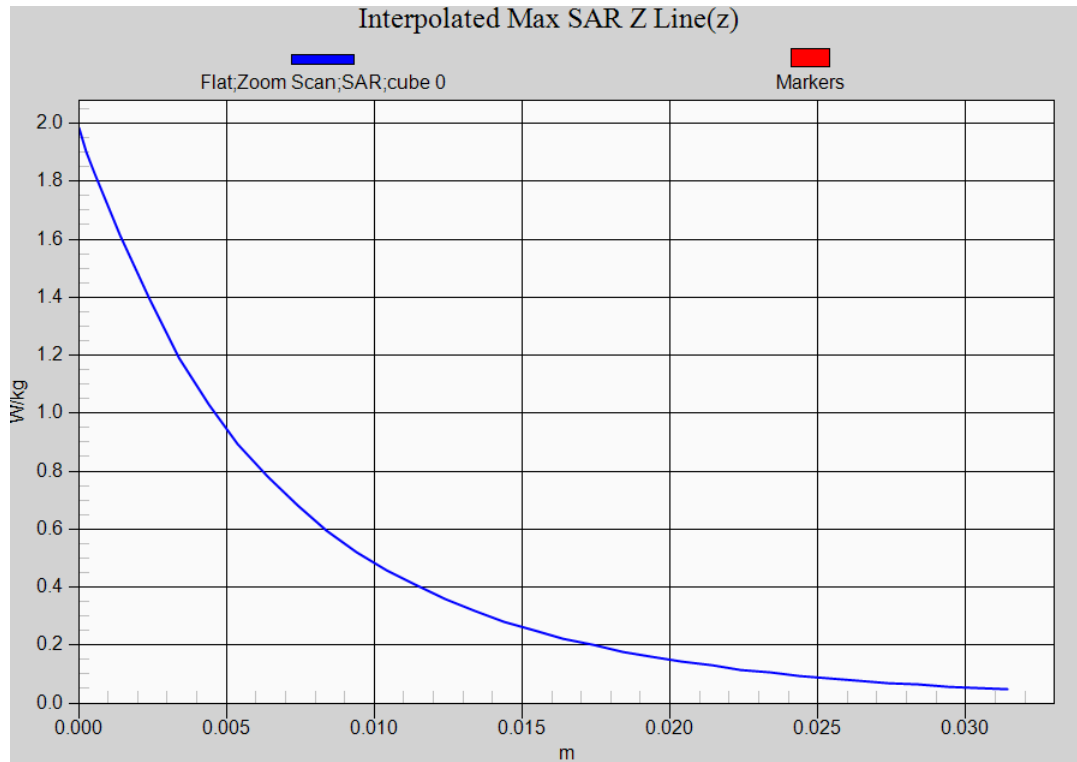

Test Laboratory: DEKRA

Date: 2022/11/08

NRn5_DFT_S_QPSK_20M_166800_1RB-1_Front_ANT 0 5mm**DUT: VOS 5G Dongle; Type: VOS5-GC-1**

Communication System: UID 0, 5G n5; Frequency: 834 MHz;

Communication System PAR: 0 dB

Medium parameters used: $f = 834$ MHz; $\sigma = 0.91$ S/m; $\epsilon_r = 40.75$; $\rho = 1000$ kg/m³

Phantom section: Flat Section

Ambient Temperature (°C) : 22.8, Liquid Temperature (°C) : 22.1

Measurement Standard: DASYS (IEEE/IEC/ANSI C63.19-2011)

DASY5 Configuration:

- Probe: EX3DV4 - SN3698; ConvF(8.9, 8.9, 8.9); Calibrated: 2021/11/24;
- Sensor-Surface: 1.4mm (Mechanical Surface Detection)
- Electronics: DAE4 Sn1207; Calibrated: 2021/11/22
- Phantom: SAM with right table; Type: SAM;
- Measurement SW: DASYS2, Version 52.10 (0); SEMCAD X Version 14.6.10 (7417)

Configuration/Flat/Area Scan (6x9x1): Measurement grid: dx=15mm, dy=15mm

Maximum value of SAR (measured) = 1.09 W/kg

Configuration/Flat/Zoom Scan (5x5x7)/Cube 0: Measurement grid: dx=8mm, dy=8mm, dz=5mm

Reference Value = 29.33 V/m; Power Drift = -0.18 dB

Peak SAR (extrapolated) = 1.57 W/kg

SAR(1 g) = 0.719 W/kg; SAR(10 g) = 0.368 W/kg

Maximum value of SAR (measured) = 1.24 W/kg

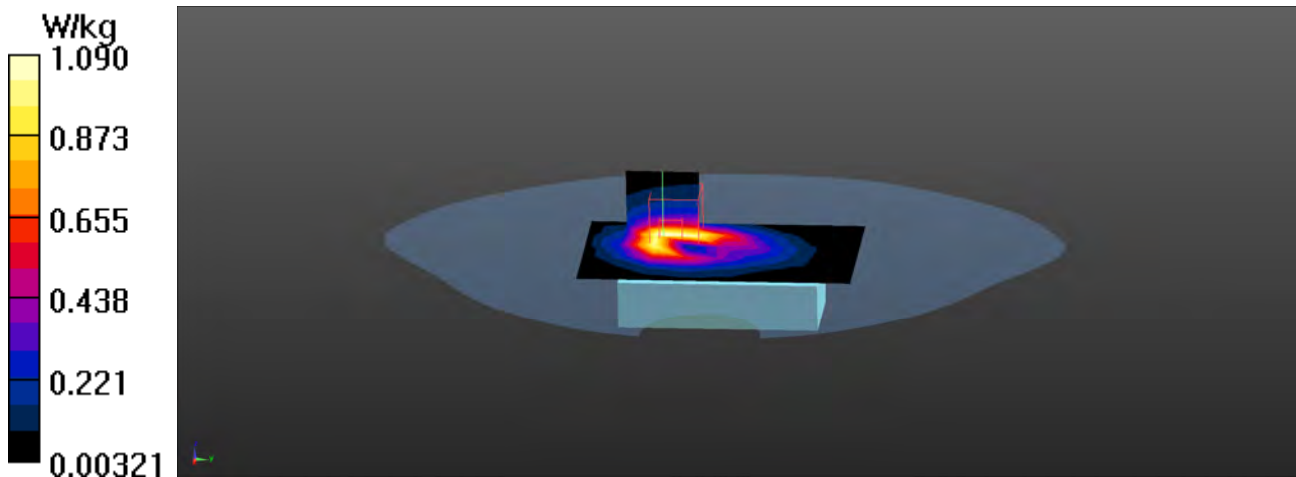

NRn5 20M DFT S QPSK 1RB-1 Front (ANT 0 5mm) Z-Axis plot

Channel: 166800

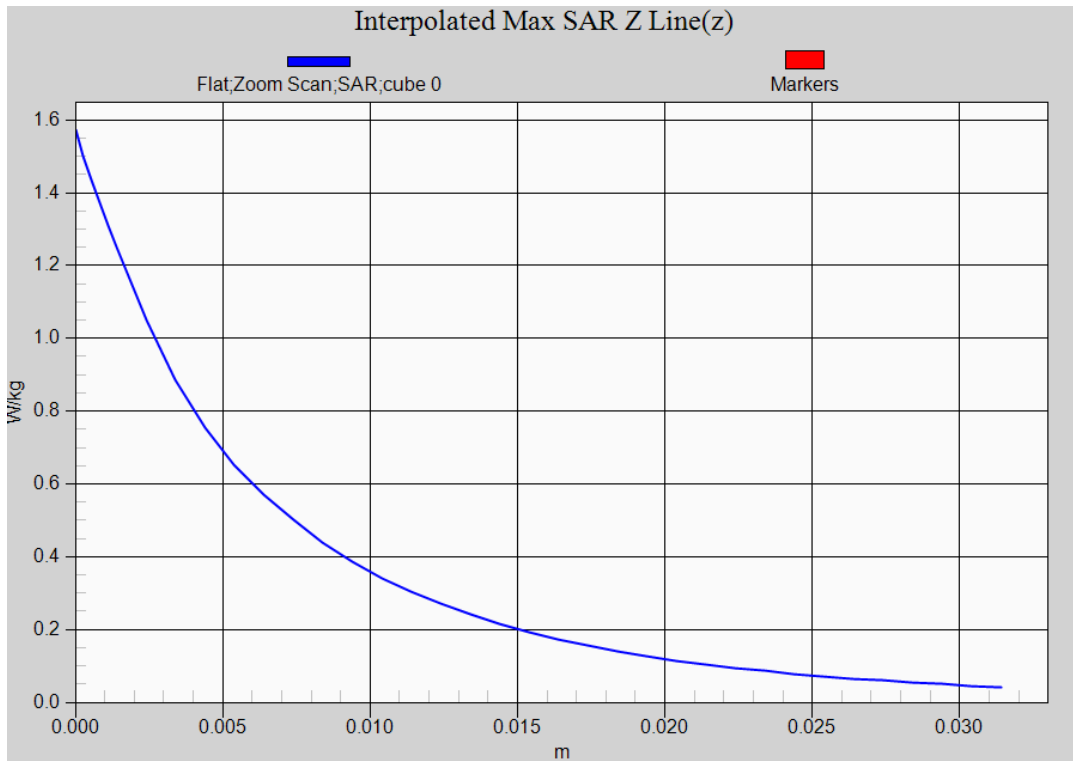

Test Laboratory: DEKRA

Date: 2022/11/19

NRn66_DFT_S_QPSK_40M_349000_1RB-1_Front_ANT 0 5mm**DUT: VOS 5G Dongle; Type: VOS5-GC-1**

Communication System: UID 0, 5G n66; Frequency: 1745 MHz;

Communication System PAR: 0 dB

Medium parameters used: $f = 1745$ MHz; $\sigma = 1.37$ S/m; $\epsilon_r = 40.22$; $\rho = 1000$ kg/m³

Phantom section: Flat Section

Ambient Temperature (°C) : 22.5, Liquid Temperature (°C) : 21.6

Measurement Standard: DASYS (IEEE/IEC/ANSI C63.19-2011)

DASY5 Configuration:

- Probe: EX3DV4 - SN3698; ConvF(7.96, 7.96, 7.96); Calibrated: 2021/11/24;
- Sensor-Surface: 1.4mm (Mechanical Surface Detection)
- Electronics: DAE4 Sn1207; Calibrated: 2021/11/22
- Phantom: SAM with right table; Type: SAM;
- Measurement SW: DASYS2, Version 52.10 (0); SEMCAD X Version 14.6.10 (7417)

Configuration/Flat/Area Scan (6x9x1): Measurement grid: dx=15mm, dy=15mm

Maximum value of SAR (measured) = 1.50 W/kg

Configuration/Flat/Zoom Scan (5x5x7)/Cube 0: Measurement grid: dx=8mm, dy=8mm, dz=5mm

Reference Value = 35.70 V/m; Power Drift = -0.05 dB

Peak SAR (extrapolated) = 2.07 W/kg

SAR(1 g) = 0.998 W/kg; SAR(10 g) = 0.472 W/kg

Maximum value of SAR (measured) = 1.65 W/kg

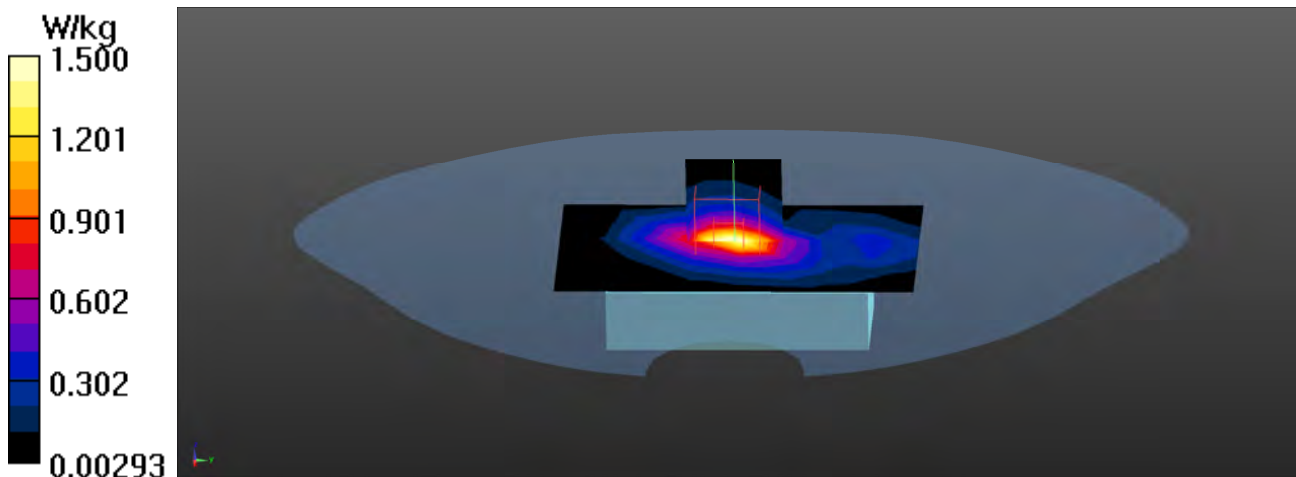

NRn66 40M DFT S QPSK 1RB-1 Front (ANT 0 5mm) Z-Axis plot

Channel: 349000

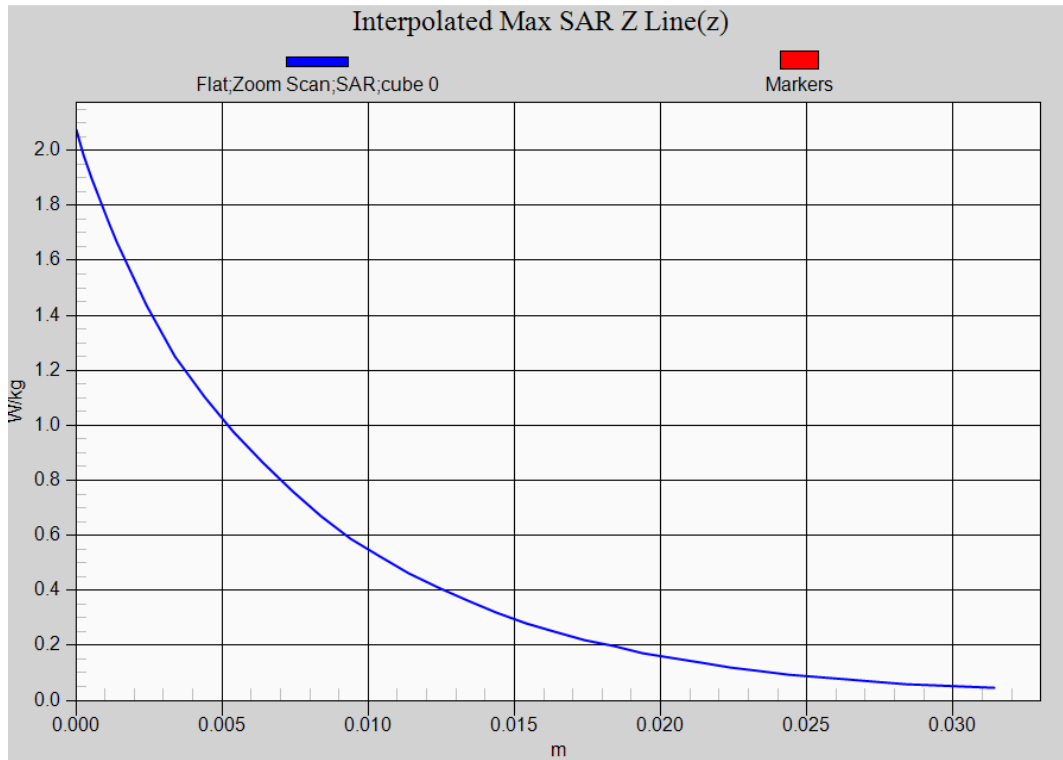

Test Laboratory: DEKRA

Date: 2022/11/11

NRn71_DFT_S_QPSK_20M_136100_PRB-28_Front_ANT 0 5mm**DUT: VOS 5G Dongle; Type: VOS5-GC-1**

Communication System: UID 0, 5G n71; Frequency: 680.5 MHz;

Communication System PAR: 0 dB

Medium parameters used: $f = 680.5$ MHz; $\sigma = 0.87$ S/m; $\epsilon_r = 42.81$; $\rho = 1000$ kg/m³

Phantom section: Flat Section

Ambient Temperature (°C) : 22.5, Liquid Temperature (°C) : 21.9

Measurement Standard: DASYS (IEEE/IEC/ANSI C63.19-2011)

DASY5 Configuration:

- Probe: EX3DV4 - SN3698; ConvF(9.1, 9.1, 9.1); Calibrated: 2021/11/24;
- Sensor-Surface: 1.4mm (Mechanical Surface Detection)
- Electronics: DAE4 Sn1207; Calibrated: 2021/11/22
- Phantom: SAM with right table; Type: SAM;
- Measurement SW: DASY52, Version 52.10 (0); SEMCAD X Version 14.6.10 (7417)

Configuration/Flat/Area Scan (6x9x1): Measurement grid: dx=15mm, dy=15mm

Maximum value of SAR (measured) = 0.784 W/kg

Configuration/Flat/Zoom Scan (5x5x7)/Cube 0: Measurement grid: dx=8mm, dy=8mm, dz=5mm

Reference Value = 21.29 V/m; Power Drift = 0.17 dB

Peak SAR (extrapolated) = 1.08 W/kg

SAR(1 g) = 0.497 W/kg; SAR(10 g) = 0.262 W/kg

Maximum value of SAR (measured) = 0.844 W/kg

Configuration/Flat/Zoom Scan (5x5x7)/Cube 1: Measurement grid: dx=8mm, dy=8mm, dz=5mm

Reference Value = 21.29 V/m; Power Drift = 0.17 dB

Peak SAR (extrapolated) = 1.62 W/kg

SAR(1 g) = 0.573 W/kg; SAR(10 g) = 0.283 W/kg

Maximum value of SAR (measured) = 1.09 W/kg

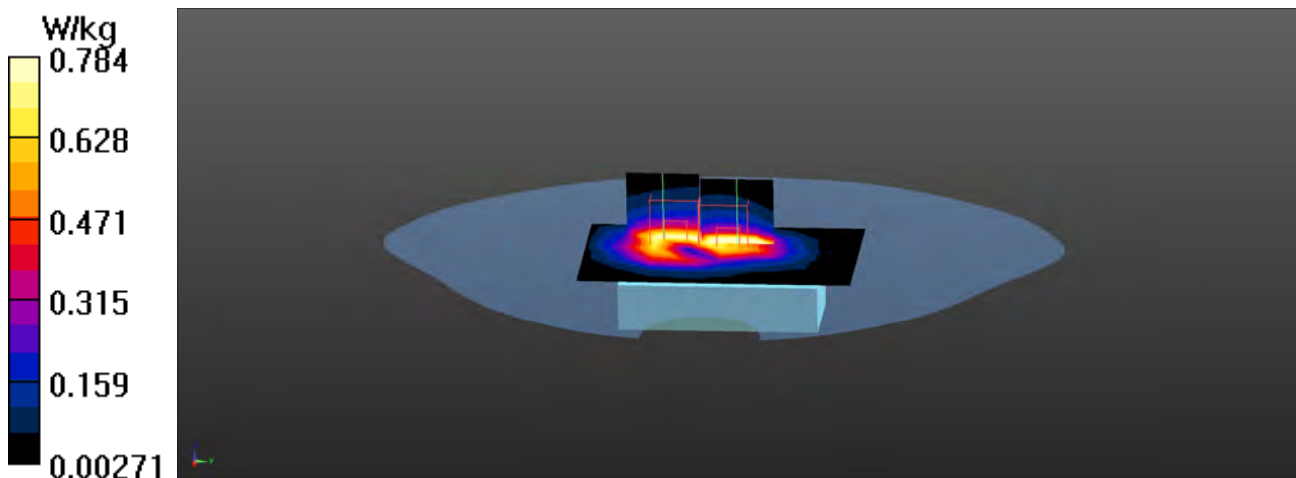

NRn71 20M DFT S QPSK PRB-28 Front (ANT 0 5mm) Z-Axis plot

Channel: 136100

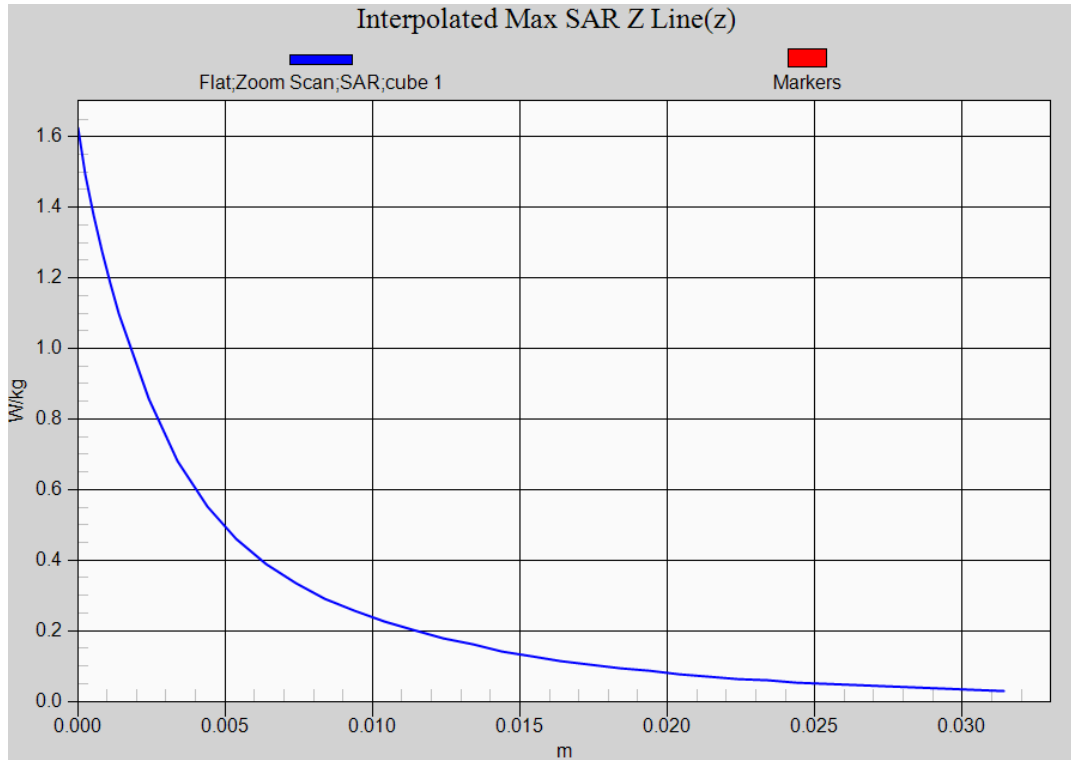

SAR measurement variability

Test Laboratory: DEKRA

Date: 2022/11/20

WCDMA_BAND 2_RMC_9538_Front_ANT 0 5mm-Verify

DUT: VOS 5G Dongle; Type: VOS5-GC-1

Communication System: UID 0, FCC WCDMA_Band-2; Frequency: 1907.6 MHz;

Communication System PAR: 0 dB

Medium parameters used: $f = 1907.6$ MHz; $\sigma = 1.38$ S/m; $\epsilon_r = 40.61$; $\rho = 1000$ kg/m³

Phantom section: Flat Section

Ambient Temperature (°C) : 22.6, Liquid Temperature (°C) : 22.1

Measurement Standard: DASYS (IEEE/IEC/ANSI C63.19-2011)

DASY5 Configuration:

- Probe: EX3DV4 - SN3698; ConvF(7.6, 7.6, 7.6); Calibrated: 2021/11/24;
- Sensor-Surface: 1.4mm (Mechanical Surface Detection)
- Electronics: DAE4 Sn1207; Calibrated: 2021/11/22
- Phantom: SAM with right table; Type: SAM;
- Measurement SW: DASYS2, Version 52.10 (0); SEMCAD X Version 14.6.10 (7417)

Configuration/Flat/Area Scan (6x9x1): Measurement grid: dx=15mm, dy=15mm

Maximum value of SAR (measured) = 1.19 W/kg

Configuration/Flat/Zoom Scan (5x5x7)/Cube 0: Measurement grid: dx=8mm, dy=8mm, dz=5mm

Reference Value = 27.11 V/m; Power Drift = -0.18 dB

Peak SAR (extrapolated) = 1.75 W/kg

SAR(1 g) = 0.790 W/kg; SAR(10 g) = 0.394 W/kg

Maximum value of SAR (measured) = 1.32 W/kg

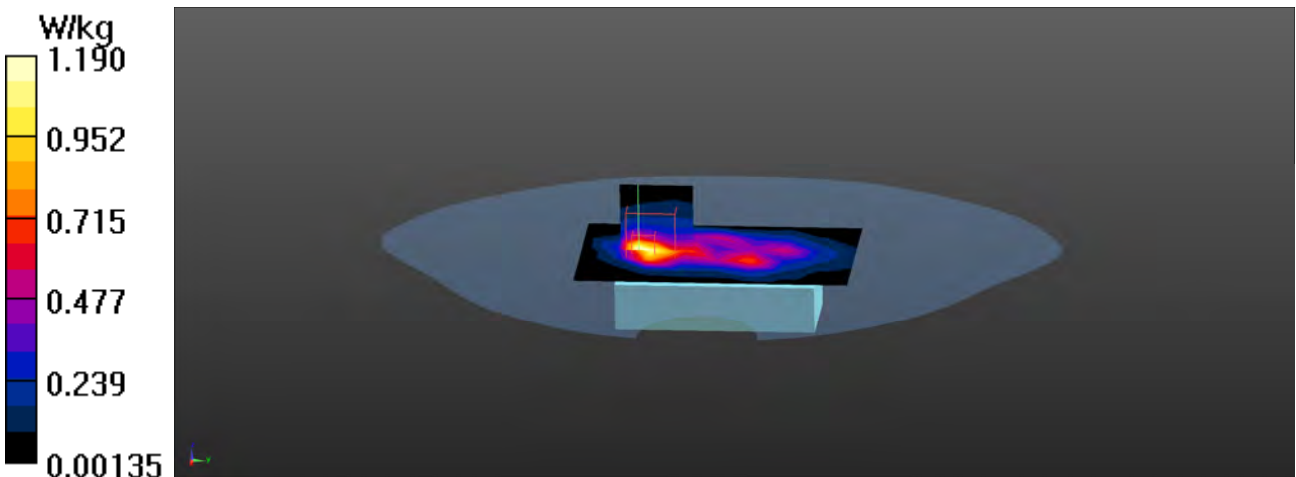

Test Laboratory: DEKRA

Date: 2022/11/19

WCDMA_BAND 4_RMC_1513_Front_ANT 0 5mm-Verify**DUT: VOS 5G Dongle; Type: VOS5-GC-1**

Communication System: UID 0, FCC WCDMA_Band 4; Frequency: 1752.6 MHz;

Communication System PAR: 0 dB

Medium parameters used: $f = 1752.6$ MHz; $\sigma = 1.37$ S/m; $\epsilon_r = 40.12$; $\rho = 1000$ kg/m³

Phantom section: Flat Section

Ambient Temperature (°C) : 22.5, Liquid Temperature (°C) : 21.6

Measurement Standard: DASYS (IEEE/IEC/ANSI C63.19-2011)

DASY5 Configuration:

- Probe: EX3DV4 - SN3698; ConvF(7.96, 7.96, 7.96); Calibrated: 2021/11/24;
- Sensor-Surface: 1.4mm (Mechanical Surface Detection)
- Electronics: DAE4 Sn1207; Calibrated: 2021/11/22
- Phantom: SAM with right table; Type: SAM;
- Measurement SW: DASYS2, Version 52.10 (0); SEMCAD X Version 14.6.10 (7417)

Configuration/Flat/Area Scan (6x9x1): Measurement grid: dx=15mm, dy=15mm

Maximum value of SAR (measured) = 1.35 W/kg

Configuration/Flat/Zoom Scan (5x5x7)/Cube 0: Measurement grid: dx=8mm, dy=8mm, dz=5mm

Reference Value = 30.19 V/m; Power Drift = 0.18 dB

Peak SAR (extrapolated) = 1.77 W/kg

SAR(1 g) = 0.851 W/kg; SAR(10 g) = 0.405 W/kg

Maximum value of SAR (measured) = 1.42 W/kg

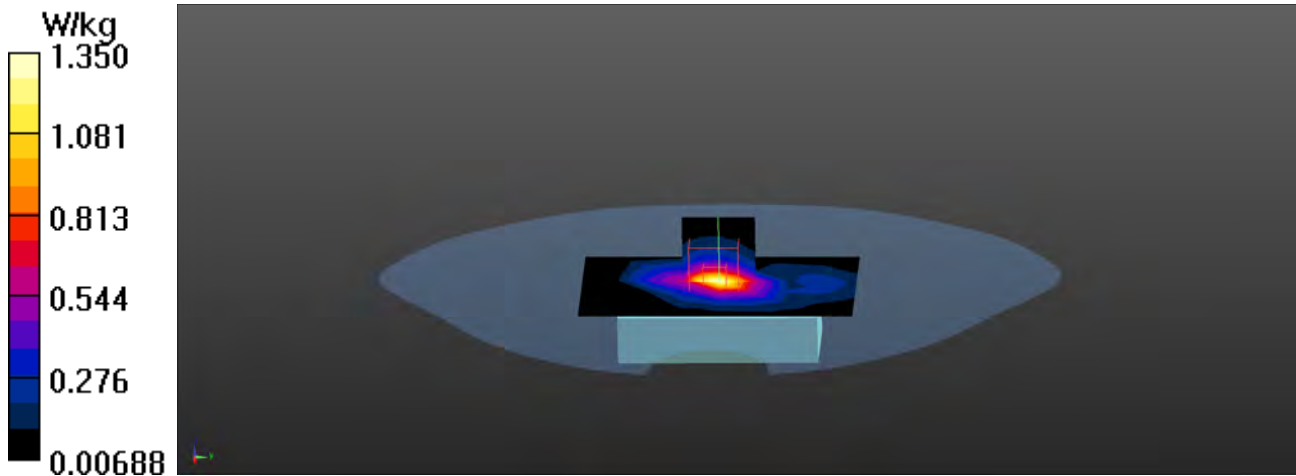

Test Laboratory: DEKRA

Date: 2022/11/20

LTE_Band2_QPSK_20M_18900_1RB-0_Front_ANT 0 5mm-Verify**DUT: VOS 5G Dongle; Type: VOS5-GC-1**

Communication System: UID 0, LTE Band2; Frequency: 1880 MHz;

Communication System PAR: 0 dB

Medium parameters used: $f = 1880$ MHz; $\sigma = 1.37$ S/m; $\epsilon_r = 40.93$; $\rho = 1000$ kg/m³

Phantom section: Flat Section

Ambient Temperature (°C) : 22.6, Liquid Temperature (°C) : 22.1

Measurement Standard: DASYS5 (IEEE/IEC/ANSI C63.19-2011)

DASY5 Configuration:

- Probe: EX3DV4 - SN3698; ConvF(7.6, 7.6, 7.6); Calibrated: 2021/11/24;
- Sensor-Surface: 1.4mm (Mechanical Surface Detection)
- Electronics: DAE4 Sn1207; Calibrated: 2021/11/22
- Phantom: SAM with right table; Type: SAM;
- Measurement SW: DASY52, Version 52.10 (0); SEMCAD X Version 14.6.10 (7417)

Configuration/Flat/Area Scan (6x9x1): Measurement grid: dx=15mm, dy=15mm

Maximum value of SAR (measured) = 1.34 W/kg

Configuration/Flat/Zoom Scan (5x5x7)/Cube 0: Measurement grid: dx=8mm, dy=8mm, dz=5mm

Reference Value = 22.71 V/m; Power Drift = -0.07 dB

Peak SAR (extrapolated) = 1.74 W/kg

SAR(1 g) = 0.809 W/kg; SAR(10 g) = 0.419 W/kg

Maximum value of SAR (measured) = 1.31 W/kg

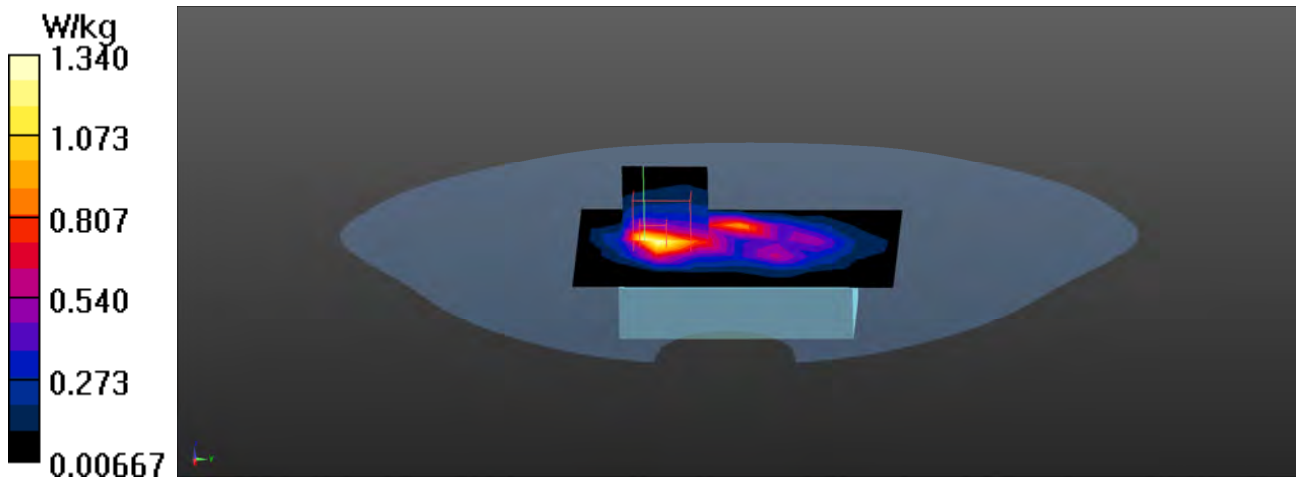

Test Laboratory: DEKRA

Date: 2022/11/09

LTE_Band7_QPSK_20M_21350_1RB-0_Front_ANT 0 5mm-Verify**DUT: Dongle; Type: VOS5-GC-1**

Communication System: UID 0, LTE Band7; Frequency: 2560 MHz;

Communication System PAR: 0 dB

Medium parameters used: $f = 2560$ MHz; $\sigma = 1.95$ S/m; $\epsilon_r = 39.47$; $\rho = 1000$ kg/m³

Phantom section: Flat Section

Ambient Temperature (°C) : 22.6, Liquid Temperature (°C) : 22.1

Measurement Standard: DASYS (IEEE/IEC/ANSI C63.19-2011)

DASY5 Configuration:

- Probe: EX3DV4 - SN3698; ConvF(6.97, 6.97, 6.97); Calibrated: 2021/11/24;
- Sensor-Surface: 1.4mm (Mechanical Surface Detection)
- Electronics: DAE4 Sn1207; Calibrated: 2021/11/22
- Phantom: SAM with right table; Type: SAM;
- Measurement SW: DASY52, Version 52.10 (0); SEMCAD X Version 14.6.10 (7417)

Configuration/Flat/Area Scan (7x11x1): Measurement grid: dx=12mm, dy=12mm

Maximum value of SAR (measured) = 1.08 W/kg

Configuration/Flat/Zoom Scan (7x7x7)/Cube 0: Measurement grid: dx=5mm, dy=5mm, dz=5mm

Reference Value = 29.83 V/m; Power Drift = -0.10 dB

Peak SAR (extrapolated) = 2.06 W/kg

SAR(1 g) = 0.856 W/kg; SAR(10 g) = 0.337 W/kg

Maximum value of SAR (measured) = 1.59 W/kg

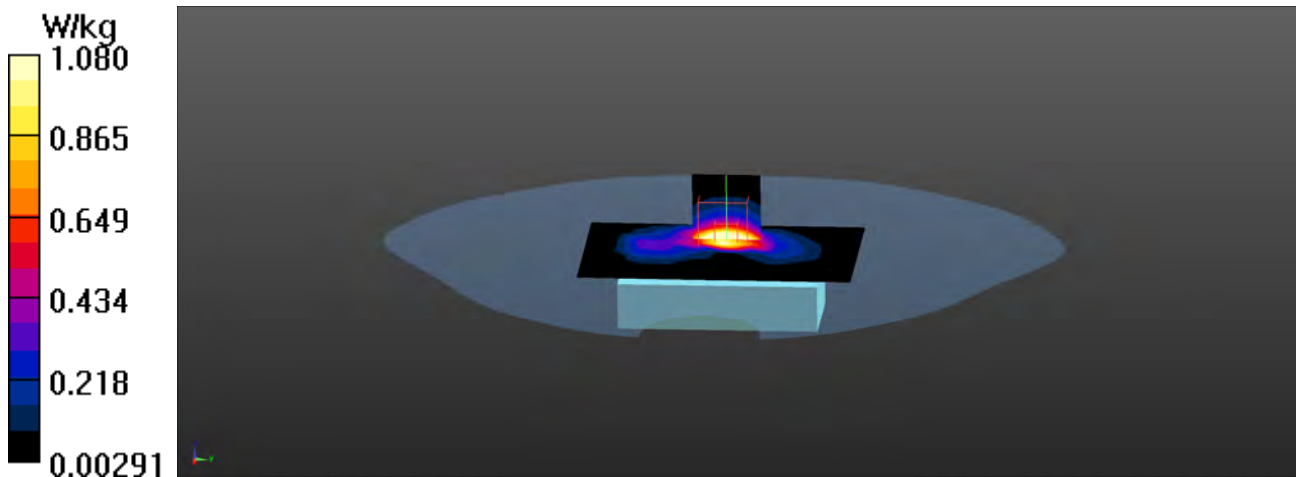

Test Laboratory: DEKRA

Date: 2022/11/09

LTE_Band30_QPSK_10M_27710_1RB-0_Front_ANT 0 5mm-Verify**DUT: VOS 5G Dongle; Type: VOS5-GC-1**

Communication System: UID 0, LTE BAND 30; Frequency: 2310 MHz;

Communication System PAR: 0 dB

Medium parameters used: $f = 2310$ MHz; $\sigma = 1.66$ S/m; $\epsilon_r = 39.33$; $\rho = 1000$ kg/m³

Phantom section: Flat Section

Ambient Temperature (°C) : 22.6, Liquid Temperature (°C) : 22.1

Measurement Standard: DASY5 (IEEE/IEC/ANSI C63.19-2011)

DASY5 Configuration:

- Probe: EX3DV4 - SN3698; ConvF(7.39, 7.39, 7.39); Calibrated: 2021/11/24;
- Sensor-Surface: 1.4mm (Mechanical Surface Detection)
- Electronics: DAE4 Sn1207; Calibrated: 2021/11/22
- Phantom: SAM with right table; Type: SAM;
- Measurement SW: DASY52, Version 52.10 (0); SEMCAD X Version 14.6.10 (7417)

Configuration/Flat/Area Scan (7x11x1): Measurement grid: dx=12mm, dy=12mm

Maximum value of SAR (measured) = 1.14 W/kg

Configuration/Flat/Zoom Scan (7x7x7)/Cube 0: Measurement grid: dx=5mm, dy=5mm, dz=5mm

Reference Value = 32.30 V/m; Power Drift = -0.01 dB

Peak SAR (extrapolated) = 2.15 W/kg

SAR(1 g) = 0.914 W/kg; SAR(10 g) = 0.385 W/kg

Maximum value of SAR (measured) = 1.67 W/kg

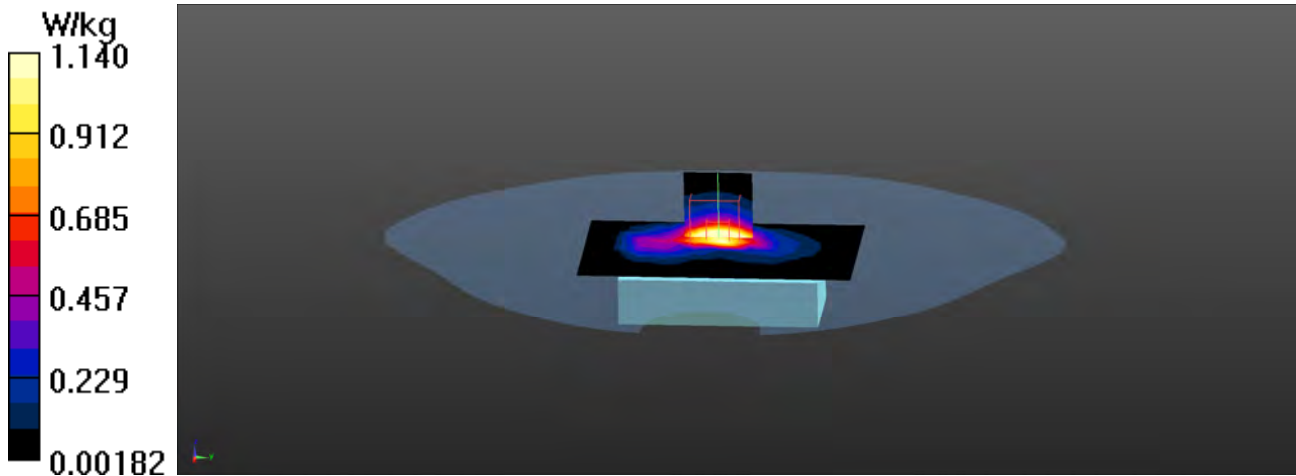

Test Laboratory: DEKRA

Date: 2022/11/09

LTE_Band41_QPSK_20M_41490_PRB-0_Front_ANT 0 5mm-Verify**DUT: VOS 5G Dongle; Type: VOS5-GC-1**

Communication System: UID 0, FCC LTE-TDD Band41; Frequency: 2680 MHz;

Communication System PAR: 2.014 dB

Medium parameters used: $f = 2680$ MHz; $\sigma = 2.01$ S/m; $\epsilon_r = 38.04$; $\rho = 1000$ kg/m³

Phantom section: Flat Section

Ambient Temperature (°C) : 22.6, Liquid Temperature (°C) : 22.1

Measurement Standard: DASY5 (IEEE/IEC/ANSI C63.19-2011)

DASY5 Configuration:

- Probe: EX3DV4 - SN3698; ConvF(6.97, 6.97, 6.97); Calibrated: 2021/11/24;
- Sensor-Surface: 1.4mm (Mechanical Surface Detection)
- Electronics: DAE4 Sn1207; Calibrated: 2021/11/22
- Phantom: SAM with right table; Type: SAM;
- Measurement SW: DASY52, Version 52.10 (0); SEMCAD X Version 14.6.10 (7417)

Configuration/Flat/Area Scan (7x11x1): Measurement grid: dx=12mm, dy=12mm

Maximum value of SAR (measured) = 1.04 W/kg

Configuration/Flat/Zoom Scan (7x7x7)/Cube 0: Measurement grid: dx=5mm, dy=5mm, dz=5mm

Reference Value = 30.11 V/m; Power Drift = -0.16 dB

Peak SAR (extrapolated) = 2.24 W/kg

SAR(1 g) = 0.922 W/kg; SAR(10 g) = 0.357 W/kg

Maximum value of SAR (measured) = 1.69 W/kg

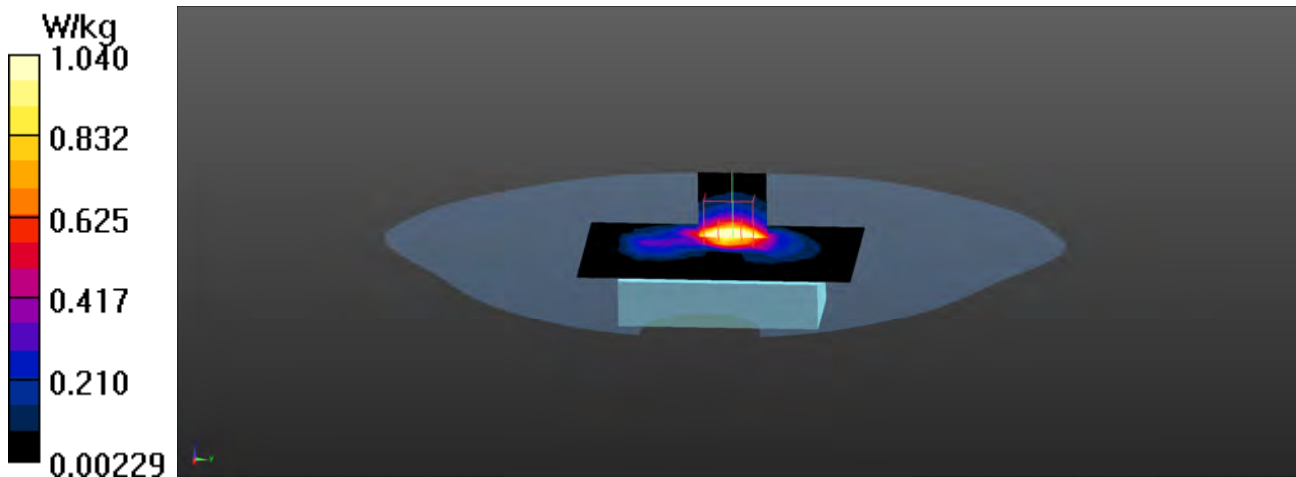

Test Laboratory: DEKRA

Date: 2022/11/20

LTE_Band48_QPSK_20M_56640_1RB-0_Front_ANT 2 5mm-Verify**DUT: VOS 5G Dongle; Type: VOS5-GC-1**

Communication System: UID 0, FCC LTE-TDD Band48; Frequency: 3690 MHz;

Communication System PAR: 2.014 dB

Medium parameters used: $f = 3690$ MHz; $\sigma = 3.12$ S/m; $\epsilon_r = 37.59$; $\rho = 1000$ kg/m³

Phantom section: Flat Section

Ambient Temperature (°C) : 22.6, Liquid Temperature (°C) : 22.1

Measurement Standard: DASYS (IEEE/IEC/ANSI C63.19-2011)

DASY5 Configuration:

- Probe: EX3DV4 - SN3698; ConvF(6.15, 6.15, 6.15); Calibrated: 2021/11/24;
- Sensor-Surface: 1.4mm (Mechanical Surface Detection)
- Electronics: DAE4 Sn1207; Calibrated: 2021/11/22
- Phantom: SAM with right table; Type: SAM;
- Measurement SW: DASY52, Version 52.10 (0); SEMCAD X Version 14.6.10 (7417)

Configuration/Flat/Area Scan (7x11x1): Measurement grid: dx=12mm, dy=12mm

Maximum value of SAR (measured) = 1.24 W/kg

Configuration/Flat/Zoom Scan (7x7x7)/Cube 0: Measurement grid: dx=5mm, dy=5mm, dz=1.4mm

Reference Value = 21.98 V/m; Power Drift = -0.18 dB

Peak SAR (extrapolated) = 2.83 W/kg

SAR(1 g) = 0.909 W/kg; SAR(10 g) = 0.291 W/kg

Maximum value of SAR (measured) = 1.95 W/kg

Configuration/Flat/Zoom Scan (7x7x7)/Cube 1: Measurement grid: dx=5mm, dy=5mm, dz=1.4mm

Reference Value = 21.98 V/m; Power Drift = -0.18 dB

Peak SAR (extrapolated) = 1.96 W/kg

SAR(1 g) = 0.671 W/kg; SAR(10 g) = 0.236 W/kg

Maximum value of SAR (measured) = 1.37 W/kg

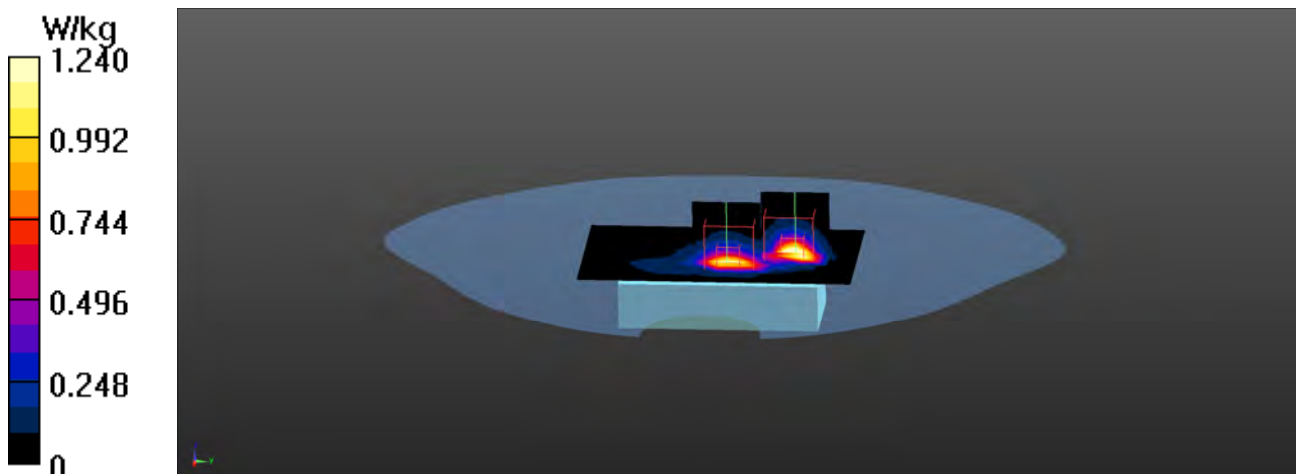

Test Laboratory: DEKRA

Date: 2022/11/19

LTE_Band66_QPSK_20M_132322_FRB-0_Front_ANT 0 5mm-Verify**DUT: VOS 5G Dongle; Type: VOS5-GC-1**

Communication System: UID 0, FCC LTE Band66; Frequency: 1745 MHz;

Communication System PAR: 0 dB

Medium parameters used: $f = 1745$ MHz; $\sigma = 1.37$ S/m; $\epsilon_r = 40.22$; $\rho = 1000$ kg/m³

Phantom section: Flat Section

Ambient Temperature (°C) : 22.5, Liquid Temperature (°C) : 21.6

Measurement Standard: DASYS (IEEE/IEC/ANSI C63.19-2011)

DASY5 Configuration:

- Probe: EX3DV4 - SN3698; ConvF(7.96, 7.96, 7.96); Calibrated: 2021/11/24;
- Sensor-Surface: 1.4mm (Mechanical Surface Detection)
- Electronics: DAE4 Sn1207; Calibrated: 2021/11/22
- Phantom: SAM with right table; Type: SAM;
- Measurement SW: DASYS2, Version 52.10 (0); SEMCAD X Version 14.6.10 (7417)

Configuration/Flat/Area Scan (6x9x1): Measurement grid: dx=15mm, dy=15mm

Maximum value of SAR (measured) = 1.62 W/kg

Configuration/Flat/Zoom Scan (5x5x7)/Cube 0: Measurement grid: dx=8mm, dy=8mm, dz=5mm

Reference Value = 35.82 V/m; Power Drift = -0.08 dB

Peak SAR (extrapolated) = 2.12 W/kg

SAR(1 g) = 0.961 W/kg; SAR(10 g) = 0.447 W/kg

Maximum value of SAR (measured) = 1.69 W/kg

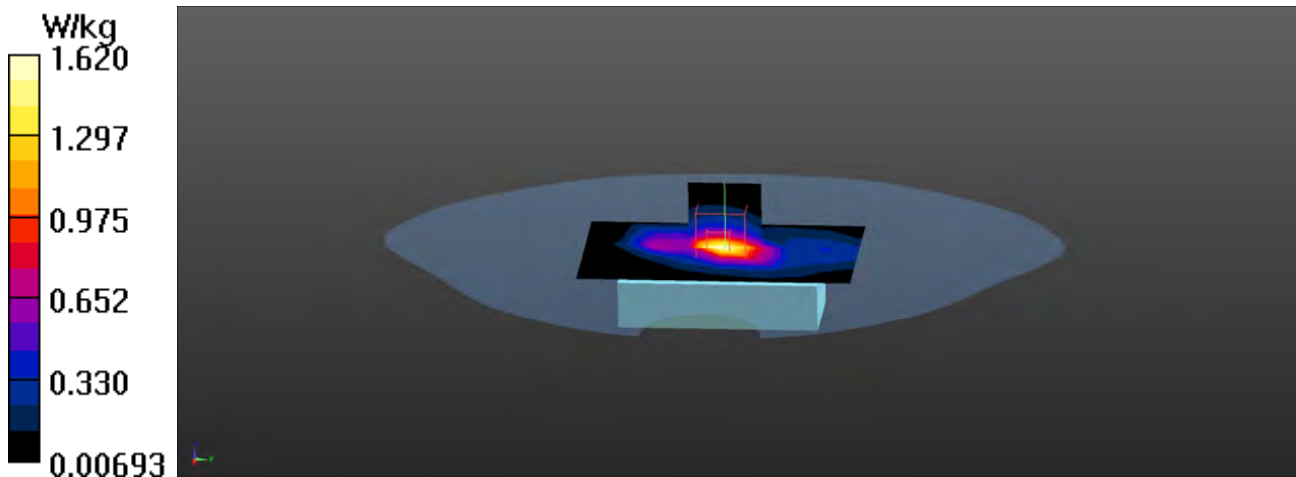

Test Laboratory: DEKRA

Date: 2022/11/20

NRn2_DFT_S_QPSK_20M_376000_1RB-1_Front_ANT 0 5mm-Verify**DUT: VOS 5G Dongle; Type: VOS5-GC-1**

Communication System: UID 0, 5G n2; Frequency: 1880 MHz;

Communication System PAR: 0 dB

Medium parameters used: $f = 1880$ MHz; $\sigma = 1.37$ S/m; $\epsilon_r = 40.93$; $\rho = 1000$ kg/m³

Phantom section: Flat Section

Ambient Temperature (°C) : 22.6, Liquid Temperature (°C) : 22.1

Measurement Standard: DASYS5 (IEEE/IEC/ANSI C63.19-2011)

DASY5 Configuration:

- Probe: EX3DV4 - SN3698; ConvF(7.6, 7.6, 7.6); Calibrated: 2021/11/24;
- Sensor-Surface: 1.4mm (Mechanical Surface Detection)
- Electronics: DAE4 Sn1207; Calibrated: 2021/11/22
- Phantom: SAM with right table; Type: SAM;
- Measurement SW: DASYS52, Version 52.10 (0); SEMCAD X Version 14.6.10 (7417)

Configuration/Flat/Area Scan (6x9x1): Measurement grid: dx=15mm, dy=15mm
Maximum value of SAR (measured) = 1.22 W/kg**Configuration/Flat/Zoom Scan (5x5x7)/Cube 0:** Measurement grid: dx=8mm, dy=8mm, dz=5mm

Reference Value = 22.56 V/m; Power Drift = -0.14 dB

Peak SAR (extrapolated) = 2.05 W/kg

SAR(1 g) = 0.855 W/kg; SAR(10 g) = 0.453 W/kg

Maximum value of SAR (measured) = 1.59 W/kg

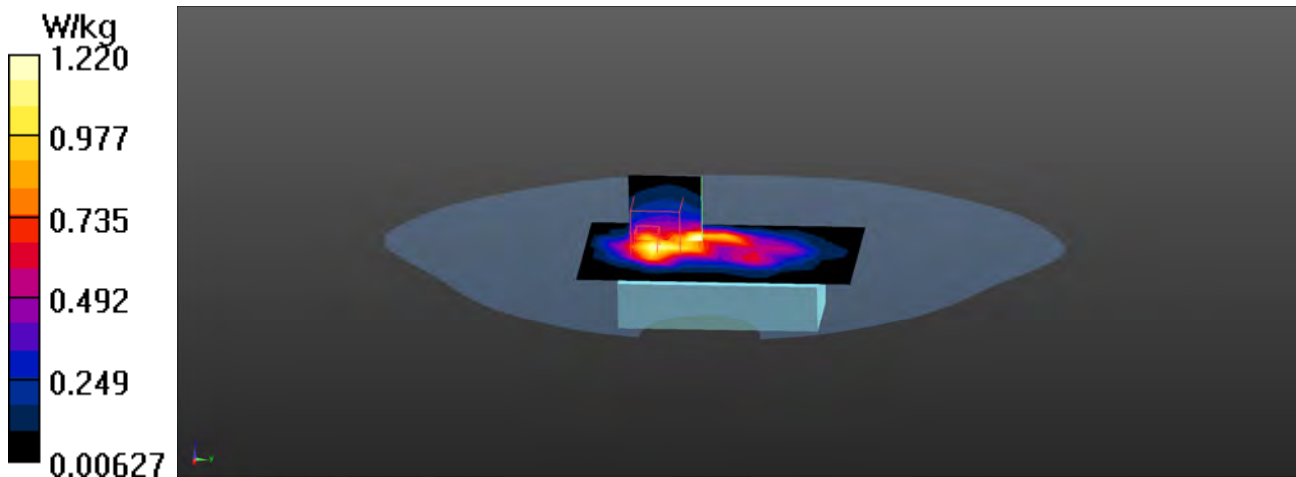

Test Laboratory: DEKRA

Date: 2022/11/19

NRn66_DFT_S_QPSK_40M_349000_1RB-1_Front_ANT 0 5mm-Verify**DUT: VOS 5G Dongle; Type: VOS5-GC-1**

Communication System: UID 0, 5G n66; Frequency: 1745 MHz;

Communication System PAR: 0 dB

Medium parameters used: $f = 1745$ MHz; $\sigma = 1.37$ S/m; $\epsilon_r = 40.22$; $\rho = 1000$ kg/m³

Phantom section: Flat Section

Ambient Temperature (°C) : 22.5, Liquid Temperature (°C) : 21.6

Measurement Standard: DASYS (IEEE/IEC/ANSI C63.19-2011)

DASY5 Configuration:

- Probe: EX3DV4 - SN3698; ConvF(7.96, 7.96, 7.96); Calibrated: 2021/11/24;
- Sensor-Surface: 1.4mm (Mechanical Surface Detection)
- Electronics: DAE4 Sn1207; Calibrated: 2021/11/22
- Phantom: SAM with right table; Type: SAM;
- Measurement SW: DASYS2, Version 52.10 (0); SEMCAD X Version 14.6.10 (7417)

Configuration/Flat/Area Scan (6x9x1): Measurement grid: dx=15mm, dy=15mm
Maximum value of SAR (measured) = 1.51 W/kg**Configuration/Flat/Zoom Scan (5x5x7)/Cube 0:** Measurement grid: dx=8mm, dy=8mm, dz=5mm

Reference Value = 35.56 V/m; Power Drift = -0.13 dB

Peak SAR (extrapolated) = 2.06 W/kg

SAR(1 g) = 0.991 W/kg; SAR(10 g) = 0.470 W/kg

Maximum value of SAR (measured) = 1.63 W/kg

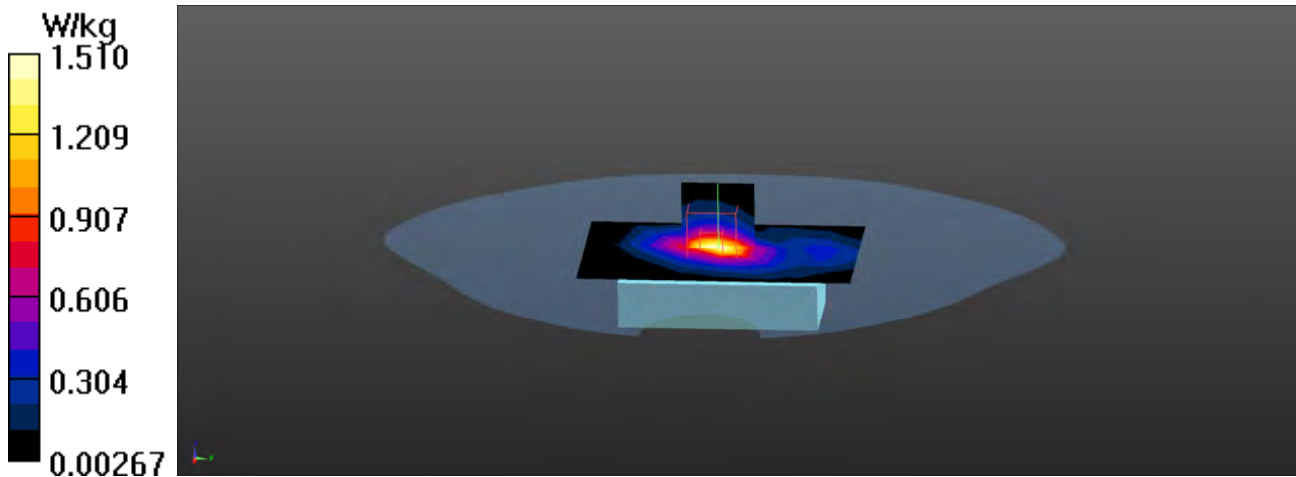



Appendix D. Probe Calibration



Accredited by the Swiss Accreditation Service (SAS)
The Swiss Accreditation Service is one of the signatories to the EA
Multilateral Agreement for the recognition of calibration certificates

Accreditation No.: **SCS 0108**

Client **DEKRA (Auden)**

Certificate No: **EX3-3698_Nov21**

CALIBRATION CERTIFICATE

Object **EX3DV4 - SN:3698**

Calibration procedure(s) **QA CAL-01.v9, QA CAL-12.v9, QA CAL-14.v6, QA CAL-23.v5,
QA CAL-25.v7
Calibration procedure for dosimetric E-field probes**

Calibration date: **November 24, 2021**

This calibration certificate documents the traceability to national standards, which realize the physical units of measurements (SI).
The measurements and the uncertainties with confidence probability are given on the following pages and are part of the certificate.

All calibrations have been conducted in the closed laboratory facility: environment temperature (22 ± 3)°C and humidity < 70%.

Calibration Equipment used (M&TE critical for calibration)

Primary Standards	ID	Cal Date (Certificate No.)	Scheduled Calibration
Power meter NRP	SN: 104778	09-Apr-21 (No. 217-03291/03292)	Apr-22
Power sensor NRP-Z91	SN: 103244	09-Apr-21 (No. 217-03291)	Apr-22
Power sensor NRP-Z91	SN: 103245	09-Apr-21 (No. 217-03292)	Apr-22
Reference 20 dB Attenuator	SN: CC2552 (20x)	09-Apr-21 (No. 217-03343)	Apr-22
DAE4	SN: 660	23-Dec-20 (No. DAE4-660_Dec20)	Dec-21
Reference Probe ES3DV2	SN: 3013	30-Dec-20 (No. ES3-3013_Dec20)	Dec-21
Secondary Standards	ID	Check Date (in house)	Scheduled Check
Power meter E4419B	SN: GB41293874	06-Apr-16 (in house check Jun-20)	In house check: Jun-22
Power sensor E4412A	SN: MY41498087	06-Apr-16 (in house check Jun-20)	In house check: Jun-22
Power sensor E4412A	SN: 000110210	06-Apr-16 (in house check Jun-20)	In house check: Jun-22
RF generator HP 8648C	SN: US3642U01700	04-Aug-99 (in house check Jun-20)	In house check: Jun-22
Network Analyzer E8358A	SN: US41080477	31-Mar-14 (in house check Oct-20)	In house check: Oct-22

	Name	Function	Signature
Calibrated by:	Jeton Kastrati	Laboratory Technician	
Approved by:	Niels Kuster	Quality Manager	

Issued: November 26, 2021

This calibration certificate shall not be reproduced except in full without written approval of the laboratory.



Accredited by the Swiss Accreditation Service (SAS)

Accreditation No.: **SCS 0108**

The Swiss Accreditation Service is one of the signatories to the EA
Multilateral Agreement for the recognition of calibration certificates

Glossary:

TSL	tissue simulating liquid
NORM _{x,y,z}	sensitivity in free space
ConvF	sensitivity in TSL / NORM _{x,y,z}
DCP	diode compression point
CF	crest factor (1/duty_cycle) of the RF signal
A, B, C, D	modulation dependent linearization parameters
Polarization φ	φ rotation around probe axis
Polarization ϑ	ϑ rotation around an axis that is in the plane normal to probe axis (at measurement center), i.e., ϑ = 0 is normal to probe axis
Connector Angle	information used in DASY system to align probe sensor X to the robot coordinate system

Calibration is Performed According to the Following Standards:

- a) IEC/IEEE 62209-1528, "Measurement Procedure For The Assessment Of Specific Absorption Rate Of Human Exposure To Radio Frequency Fields From Hand-Held And Body-Worn Wireless Communication Devices - Part 1528: Human Models, Instrumentation And Procedures (Frequency Range of 4 MHz to 10 GHz)", October 2020.
- b) KDB 865664, "SAR Measurement Requirements for 100 MHz to 6 GHz"

Methods Applied and Interpretation of Parameters:

- *NORM_{x,y,z}*: Assessed for E-field polarization ϑ = 0 (f ≤ 900 MHz in TEM-cell; f > 1800 MHz: R22 waveguide). *NORM_{x,y,z}* are only intermediate values, i.e., the uncertainties of *NORM_{x,y,z}* does not affect the E²-field uncertainty inside TSL (see below *ConvF*).
- *NORM(f)_{x,y,z}* = *NORM_{x,y,z}* * *frequency_response* (see Frequency Response Chart). This linearization is implemented in DASY4 software versions later than 4.2. The uncertainty of the frequency response is included in the stated uncertainty of *ConvF*.
- *DCP_{x,y,z}*: DCP are numerical linearization parameters assessed based on the data of power sweep with CW signal (no uncertainty required). DCP does not depend on frequency nor media.
- *PAR*: *PAR* is the Peak to Average Ratio that is not calibrated but determined based on the signal characteristics
- *A_{x,y,z}*; *B_{x,y,z}*; *C_{x,y,z}*; *D_{x,y,z}*; *VR_{x,y,z}*; *A, B, C, D* are numerical linearization parameters assessed based on the data of power sweep for specific modulation signal. The parameters do not depend on frequency nor media. *VR* is the maximum calibration range expressed in RMS voltage across the diode.
- *ConvF* and *Boundary Effect Parameters*: Assessed in flat phantom using E-field (or Temperature Transfer Standard for f ≤ 800 MHz) and inside waveguide using analytical field distributions based on power measurements for f > 800 MHz. The same setups are used for assessment of the parameters applied for boundary compensation (alpha, depth) of which typical uncertainty values are given. These parameters are used in DASY4 software to improve probe accuracy close to the boundary. The sensitivity in TSL corresponds to *NORM_{x,y,z}* * *ConvF* whereby the uncertainty corresponds to that given for *ConvF*. A frequency dependent *ConvF* is used in DASY version 4.4 and higher which allows extending the validity from ± 50 MHz to ± 100 MHz.
- *Spherical isotropy (3D deviation from isotropy)*: in a field of low gradients realized using a flat phantom exposed by a patch antenna.
- *Sensor Offset*: The sensor offset corresponds to the offset of virtual measurement center from the probe tip (on probe axis). No tolerance required.
- *Connector Angle*: The angle is assessed using the information gained by determining the *NORM_x* (no uncertainty required).

DASY/EASY - Parameters of Probe: EX3DV4 - SN:3698

Basic Calibration Parameters

	Sensor X	Sensor Y	Sensor Z	Unc (k=2)
Norm ($\mu\text{V}/(\text{V}/\text{m})^2$) ^A	0.41	0.34	0.37	$\pm 10.1\%$
DCP (mV) ^B	105.0	101.0	105.0	

Calibration Results for Modulation Response

UID	Communication System Name		A dB	B dB $\sqrt{\mu\text{V}}$	C	D dB	VR mV	Max dev.	Unc ^E (k=2)
0	CW	X	0.0	0.0	1.0	0.00	147.1	$\pm 3.3\%$	$\pm 4.7\%$
		Y	0.0	0.0	1.0		129.5		
		Z	0.0	0.0	1.0		141.3		

The reported uncertainty of measurement is stated as the standard uncertainty of measurement multiplied by the coverage factor $k=2$, which for a normal distribution corresponds to a coverage probability of approximately 95%.

^A The uncertainties of Norm X,Y,Z do not affect the E²-field uncertainty inside TSL (see Page 5).

^B Numerical linearization parameter: uncertainty not required.

^E Uncertainty is determined using the max. deviation from linear response applying rectangular distribution and is expressed for the square of the field value.

DASY/EASY - Parameters of Probe: EX3DV4 - SN:3698

Other Probe Parameters

Sensor Arrangement	Triangular
Connector Angle (°)	-137
Mechanical Surface Detection Mode	enabled
Optical Surface Detection Mode	disabled
Probe Overall Length	337 mm
Probe Body Diameter	10 mm
Tip Length	9 mm
Tip Diameter	2.5 mm
Probe Tip to Sensor X Calibration Point	1 mm
Probe Tip to Sensor Y Calibration Point	1 mm
Probe Tip to Sensor Z Calibration Point	1 mm
Recommended Measurement Distance from Surface	1.4 mm

Note: Measurement distance from surface can be increased to 3-4 mm for an *Area Scan* job.

DASY/EASY - Parameters of Probe: EX3DV4 - SN:3698

Calibration Parameter Determined in Head Tissue Simulating Media

f (MHz) ^c	Relative Permittivity ^F	Conductivity (S/m) ^F	ConvF X	ConvF Y	ConvF Z	Alpha ^G	Depth ^G (mm)	Unc (k=2)
450	43.5	0.87	9.73	9.73	9.73	0.16	1.30	± 13.3 %
750	41.9	0.89	9.10	9.10	9.10	0.46	0.80	± 12.0 %
835	41.5	0.90	8.90	8.90	8.90	0.38	0.96	± 12.0 %
900	41.5	0.97	8.81	8.81	8.81	0.47	0.80	± 12.0 %
1450	40.5	1.20	8.18	8.18	8.18	0.58	0.80	± 12.0 %
1640	40.2	1.31	8.08	8.08	8.08	0.30	0.86	± 12.0 %
1750	40.1	1.37	7.96	7.96	7.96	0.28	0.86	± 12.0 %
1950	40.0	1.40	7.60	7.60	7.60	0.39	0.86	± 12.0 %
2300	39.5	1.67	7.39	7.39	7.39	0.33	0.90	± 12.0 %
2450	39.2	1.80	7.19	7.19	7.19	0.27	0.90	± 12.0 %
2600	39.0	1.96	6.97	6.97	6.97	0.36	0.90	± 12.0 %
3300	38.2	2.71	6.65	6.65	6.65	0.30	1.35	± 13.1 %
3500	37.9	2.91	6.30	6.30	6.30	0.35	1.30	± 13.1 %
3700	37.7	3.12	6.15	6.15	6.15	0.35	1.30	± 13.1 %
5250	35.9	4.71	4.70	4.70	4.70	0.40	1.80	± 13.1 %
5600	35.5	5.07	4.35	4.35	4.35	0.40	1.80	± 13.1 %
5800	35.3	5.27	4.58	4.58	4.58	0.40	1.80	± 13.1 %

^c Frequency validity above 300 MHz of ± 100 MHz only applies for DASY v4.4 and higher (see Page 2), else it is restricted to ± 50 MHz. The uncertainty is the RSS of the ConvF uncertainty at calibration frequency and the uncertainty for the indicated frequency band. Frequency validity below 300 MHz is ± 10, 25, 40, 50 and 70 MHz for ConvF assessments at 30, 64, 128, 150 and 220 MHz respectively. Validity of ConvF assessed at 6 MHz is 4-9 MHz, and ConvF assessed at 13 MHz is 9-19 MHz. Above 5 GHz frequency validity can be extended to ± 110 MHz.

^F At frequencies below 3 GHz, the validity of tissue parameters (ϵ and σ) can be relaxed to ± 10% if liquid compensation formula is applied to measured SAR values. At frequencies above 3 GHz, the validity of tissue parameters (ϵ and σ) is restricted to ± 5%. The uncertainty is the RSS of the ConvF uncertainty for indicated target tissue parameters.

^G Alpha/Depth are determined during calibration. SPEAG warrants that the remaining deviation due to the boundary effect after compensation is always less than ± 1% for frequencies below 3 GHz and below ± 2% for frequencies between 3-6 GHz at any distance larger than half the probe tip diameter from the boundary.

Frequency Response of E-Field (TEM-Cell:ifi110 EXX, Waveguide: R22)

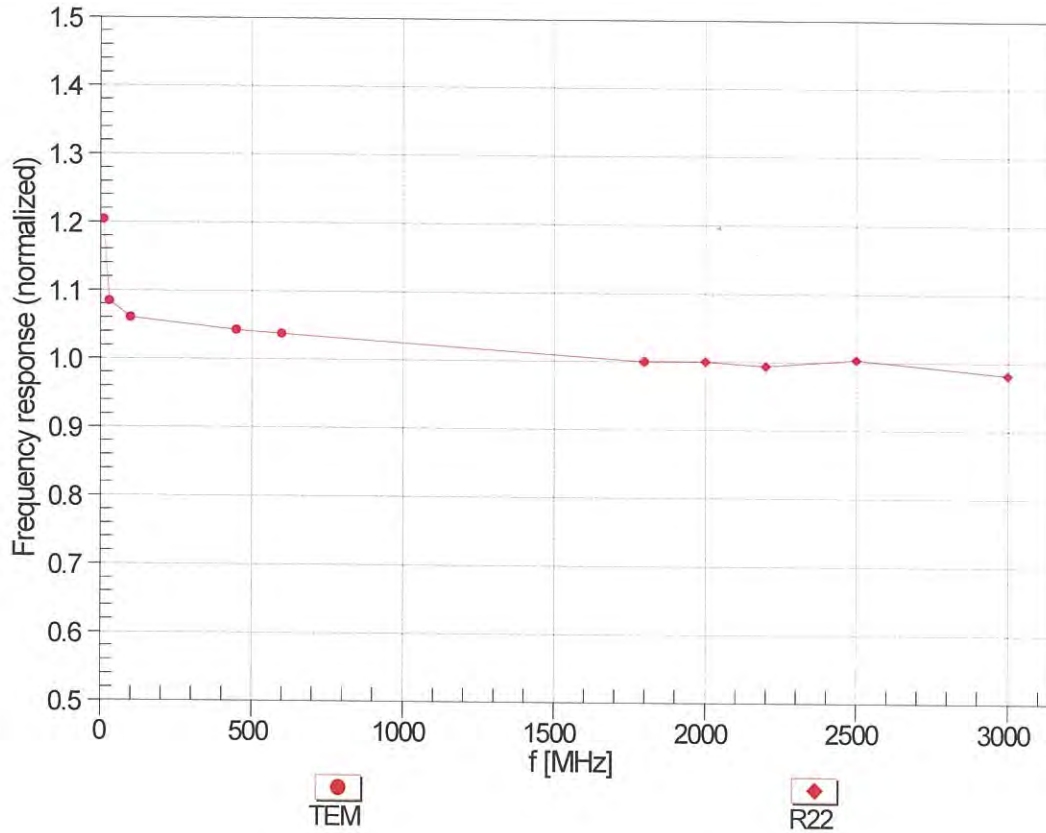

Uncertainty of Frequency Response of E-field: $\pm 6.3\%$ (k=2)

Receiving Pattern (ϕ), $\vartheta = 0^\circ$

f=600 MHz, TEM

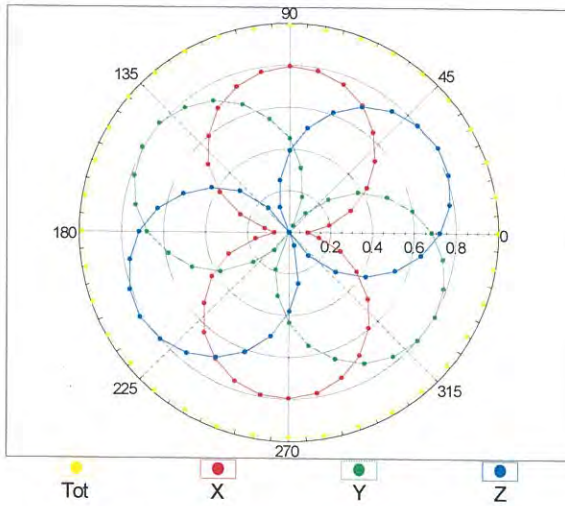

f=1800 MHz, R22

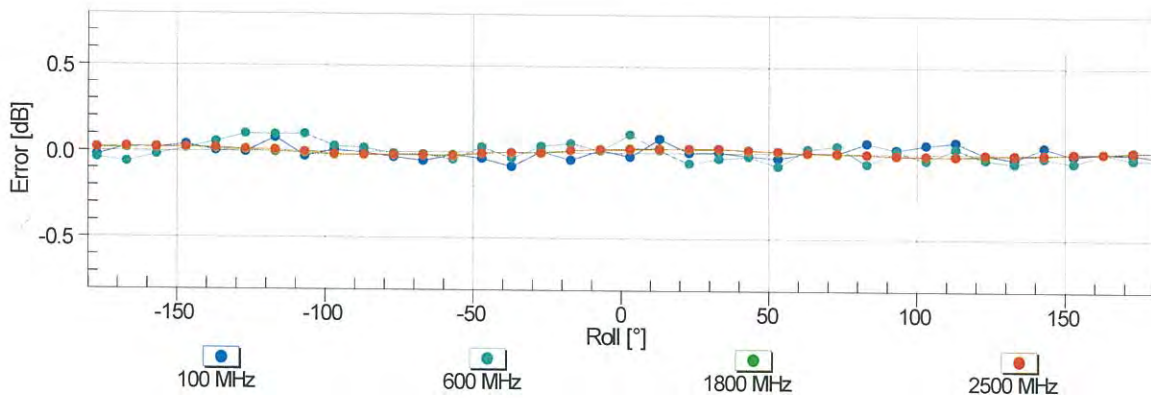
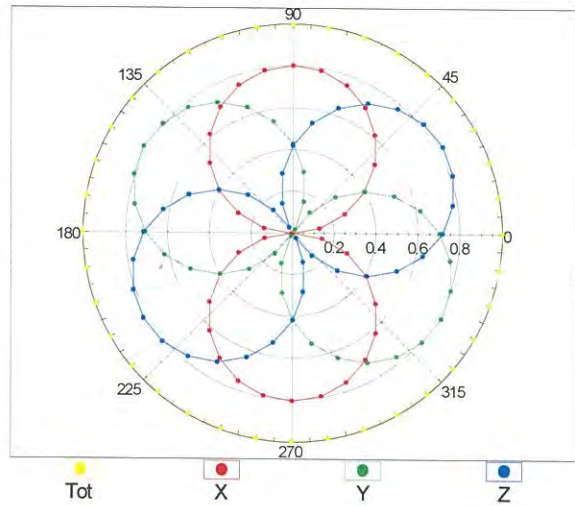

Uncertainty of Axial Isotropy Assessment: $\pm 0.5\%$ (k=2)

Dynamic Range $f(\text{SAR}_{\text{head}})$ (TEM cell , $f_{\text{eval}}= 1900 \text{ MHz}$)

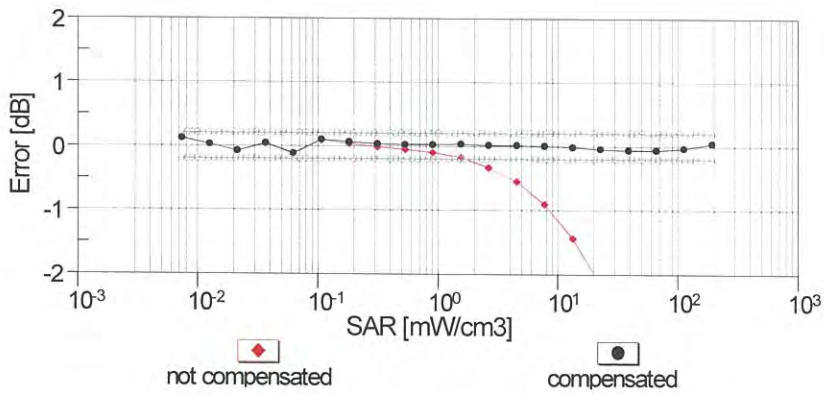
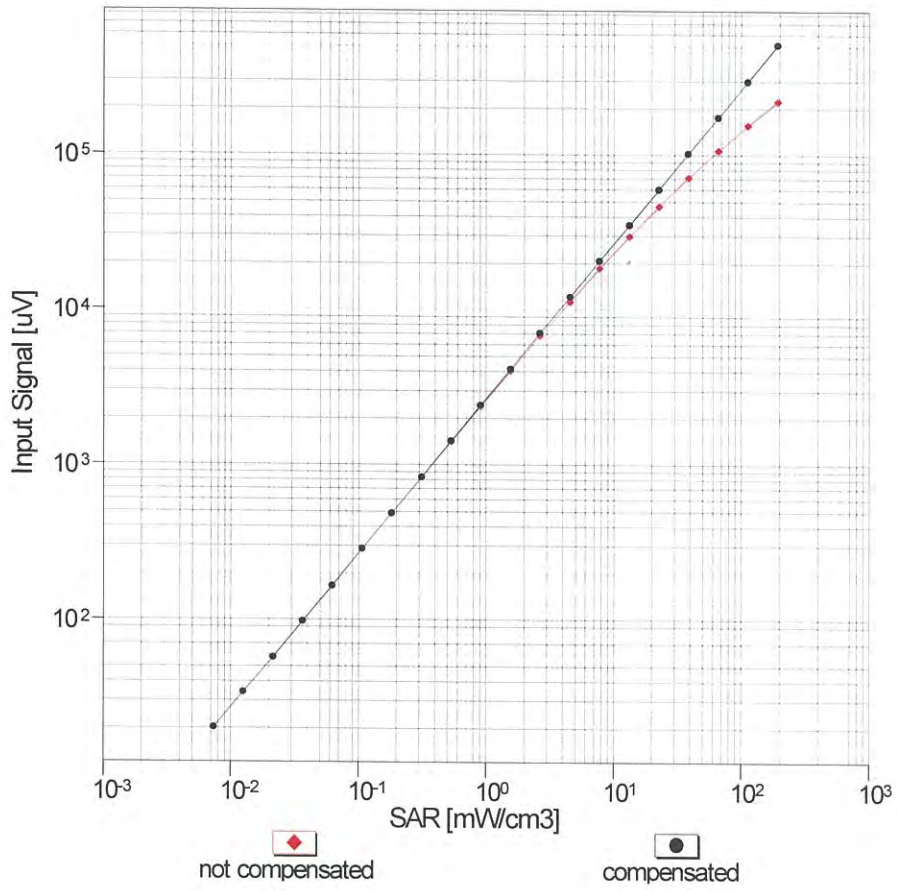

Uncertainty of Linearity Assessment: $\pm 0.6\%$ ($k=2$)

Conversion Factor Assessment

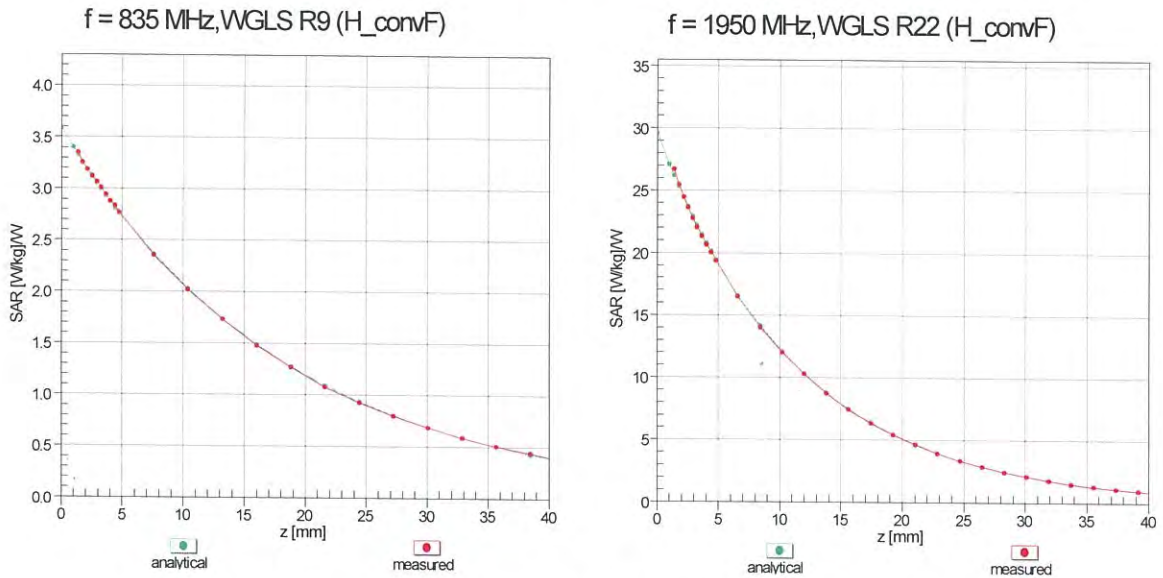

Deviation from Isotropy in Liquid

Error (ϕ, θ), f = 900 MHz

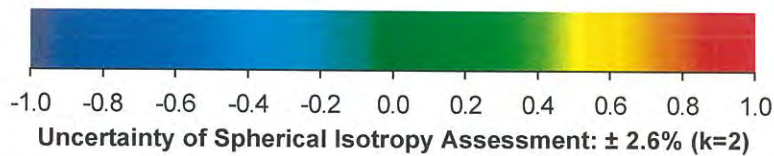
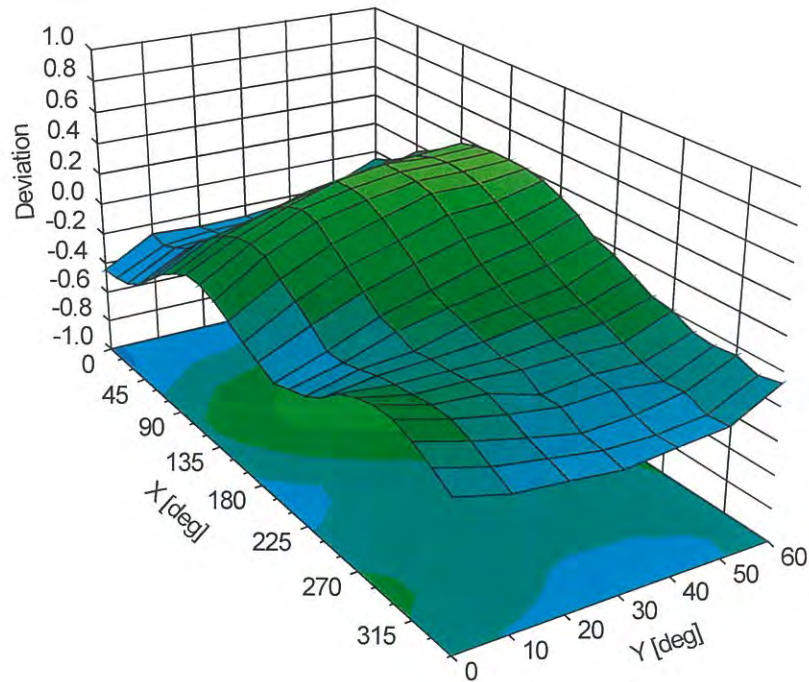



Appendix E. Dipole Calibration



Accredited by the Swiss Accreditation Service (SAS)
The Swiss Accreditation Service is one of the signatories to the EA
Multilateral Agreement for the recognition of calibration certificates

Accreditation No.: **SCS 0108**

Client **DEKRA (Auden)**

Certificate No: **D750V3-1031_May20**

CALIBRATION CERTIFICATE

Object **D750V3 - SN:1031**

Calibration procedure(s) **QA CAL-05.v11
Calibration Procedure for SAR Validation Sources between 0.7-3 GHz**

Calibration date: **May 27, 2020**

This calibration certificate documents the traceability to national standards, which realize the physical units of measurements (SI).
The measurements and the uncertainties with confidence probability are given on the following pages and are part of the certificate.

All calibrations have been conducted in the closed laboratory facility: environment temperature (22 ± 3)°C and humidity < 70%.

Calibration Equipment used (M&TE critical for calibration)

Primary Standards	ID #	Cal Date (Certificate No.)	Scheduled Calibration
Power meter NRP	SN: 104778	01-Apr-20 (No. 217-03100/03101)	Apr-21
Power sensor NRP-Z91	SN: 103244	01-Apr-20 (No. 217-03100)	Apr-21
Power sensor NRP-Z91	SN: 103245	01-Apr-20 (No. 217-03101)	Apr-21
Reference 20 dB Attenuator	SN: BH9394 (20k)	31-Mar-20 (No. 217-03106)	Apr-21
Type-N mismatch combination	SN: 310982 / 06327	31-Mar-20 (No. 217-03104)	Apr-21
Reference Probe EX3DV4	SN: 7349	31-Dec-19 (No. EX3-7349_Dec19)	Dec-20
DAE4	SN: 601	27-Dec-19 (No. DAE4-601_Dec19)	Dec-20
Secondary Standards	ID #	Check Date (in house)	Scheduled Check
Power meter E4419B	SN: GB39512475	30-Oct-14 (in house check Feb-19)	In house check: Oct-20
Power sensor HP 8481A	SN: US37292783	07-Oct-15 (in house check Oct-18)	In house check: Oct-20
Power sensor HP 8481A	SN: MY41092317	07-Oct-15 (in house check Oct-18)	In house check: Oct-20
RF generator R&S SMT-06	SN: 100972	15-Jun-15 (in house check Oct-18)	In house check: Oct-20
Network Analyzer Agilent E8358A	SN: US41080477	31-Mar-14 (in house check Oct-19)	In house check: Oct-20

Calibrated by: **Jeffrey Katzman** Name: Jeffrey Katzman Function: Laboratory Technician

Approved by: **Katja Pokovic** Name: Katja Pokovic Function: Technical Manager

Signature

Issued: May 27, 2020

This calibration certificate shall not be reproduced except in full without written approval of the laboratory.



Accredited by the Swiss Accreditation Service (SAS)

The Swiss Accreditation Service is one of the signatories to the EA
Multilateral Agreement for the recognition of calibration certificates

Accreditation No.: **SCS 0108**

Glossary:

TSL	tissue simulating liquid
ConvF	sensitivity in TSL / NORM x,y,z
N/A	not applicable or not measured

Calibration is Performed According to the Following Standards:

- IEEE Std 1528-2013, "IEEE Recommended Practice for Determining the Peak Spatial-Averaged Specific Absorption Rate (SAR) in the Human Head from Wireless Communications Devices: Measurement Techniques", June 2013
- IEC 62209-1, "Measurement procedure for the assessment of Specific Absorption Rate (SAR) from hand-held and body-mounted devices used next to the ear (frequency range of 300 MHz to 6 GHz)", July 2016
- IEC 62209-2, "Procedure to determine the Specific Absorption Rate (SAR) for wireless communication devices used in close proximity to the human body (frequency range of 30 MHz to 6 GHz)", March 2010
- KDB 865664, "SAR Measurement Requirements for 100 MHz to 6 GHz"

Additional Documentation:

- DASY4/5 System Handbook

Methods Applied and Interpretation of Parameters:

- Measurement Conditions:** Further details are available from the Validation Report at the end of the certificate. All figures stated in the certificate are valid at the frequency indicated.
- Antenna Parameters with TSL:** The dipole is mounted with the spacer to position its feed point exactly below the center marking of the flat phantom section, with the arms oriented parallel to the body axis.
- Feed Point Impedance and Return Loss:** These parameters are measured with the dipole positioned under the liquid filled phantom. The impedance stated is transformed from the measurement at the SMA connector to the feed point. The Return Loss ensures low reflected power. No uncertainty required.
- Electrical Delay:** One-way delay between the SMA connector and the antenna feed point. No uncertainty required.
- SAR measured:** SAR measured at the stated antenna input power.
- SAR normalized:** SAR as measured, normalized to an input power of 1 W at the antenna connector.
- SAR for nominal TSL parameters:** The measured TSL parameters are used to calculate the nominal SAR result.

The reported uncertainty of measurement is stated as the standard uncertainty of measurement multiplied by the coverage factor $k=2$, which for a normal distribution corresponds to a coverage probability of approximately 95%.

Measurement Conditions

DASY system configuration, as far as not given on page 1.

DASY Version	DASY5	V52.10.4
Extrapolation	Advanced Extrapolation	
Phantom	Modular Flat Phantom	
Distance Dipole Center - TSL	15 mm	with Spacer
Zoom Scan Resolution	dx, dy, dz = 5 mm	
Frequency	750 MHz \pm 1 MHz	

Head TSL parameters

The following parameters and calculations were applied.

	Temperature	Permittivity	Conductivity
Nominal Head TSL parameters	22.0 °C	41.9	0.89 mho/m
Measured Head TSL parameters	(22.0 \pm 0.2) °C	42.1 \pm 6 %	0.91 mho/m \pm 6 %
Head TSL temperature change during test	< 0.5 °C	----	----

SAR result with Head TSL

SAR averaged over 1 cm³ (1 g) of Head TSL	Condition	
SAR measured	250 mW input power	2.18 W/kg
SAR for nominal Head TSL parameters	normalized to 1W	8.58 W/kg \pm 17.0 % (k=2)

SAR averaged over 10 cm³ (10 g) of Head TSL	condition	
SAR measured	250 mW input power	1.42 W/kg
SAR for nominal Head TSL parameters	normalized to 1W	5.61 W/kg \pm 16.5 % (k=2)

Appendix (Additional assessments outside the scope of SCS 0108)

Antenna Parameters with Head TSL

Impedance, transformed to feed point	53.8 Ω - 1.9 j Ω
Return Loss	- 27.8 dB

General Antenna Parameters and Design

Electrical Delay (one direction)	1.033 ns
----------------------------------	----------

After long term use with 100W radiated power, only a slight warming of the dipole near the feedpoint can be measured.

The dipole is made of standard semirigid coaxial cable. The center conductor of the feeding line is directly connected to the second arm of the dipole. The antenna is therefore short-circuited for DC-signals. On some of the dipoles, small end caps are added to the dipole arms in order to improve matching when loaded according to the position as explained in the "Measurement Conditions" paragraph. The SAR data are not affected by this change. The overall dipole length is still according to the Standard.

No excessive force must be applied to the dipole arms, because they might bend or the soldered connections near the feedpoint may be damaged.

Additional EUT Data

Manufactured by	SPEAG
-----------------	-------

DASY5 Validation Report for Head TSL

Date: 27.05.2020

Test Laboratory: SPEAG, Zurich, Switzerland

DUT: Dipole 750 MHz; Type: D750V3; Serial: D750V3 - SN:1031

Communication System: UID 0 - CW; Frequency: 750 MHz

Medium parameters used: $f = 750 \text{ MHz}$; $\sigma = 0.91 \text{ S/m}$; $\epsilon_r = 42.1$; $\rho = 1000 \text{ kg/m}^3$

Phantom section: Flat Section

Measurement Standard: DASY5 (IEEE/IEC/ANSI C63.19-2011)

DASY52 Configuration:

- Probe: EX3DV4 - SN7349; ConvF(10.07, 10.07, 10.07) @ 750 MHz; Calibrated: 31.12.2019
- Sensor-Surface: 1.4mm (Mechanical Surface Detection)
- Electronics: DAE4 Sn601; Calibrated: 27.12.2019
- Phantom: Flat Phantom 4.9 (front); Type: QD 00L P49 AA; Serial: 1001
- DASY52 52.10.4(1527); SEMCAD X 14.6.14(7483)

Dipole Calibration for Head Tissue/Pin=250 mW, d=15mm/Zoom Scan (7x7x7)/Cube 0:

Measurement grid: $dx=5\text{mm}$, $dy=5\text{mm}$, $dz=5\text{mm}$

Reference Value = 60.01 V/m; Power Drift = -0.02 dB

Peak SAR (extrapolated) = 3.29 W/kg

SAR(1 g) = 2.18 W/kg; SAR(10 g) = 1.42 W/kg

Smallest distance from peaks to all points 3 dB below = 20 mm

Ratio of SAR at M2 to SAR at M1 = 66%

Maximum value of SAR (measured) = 2.91 W/kg

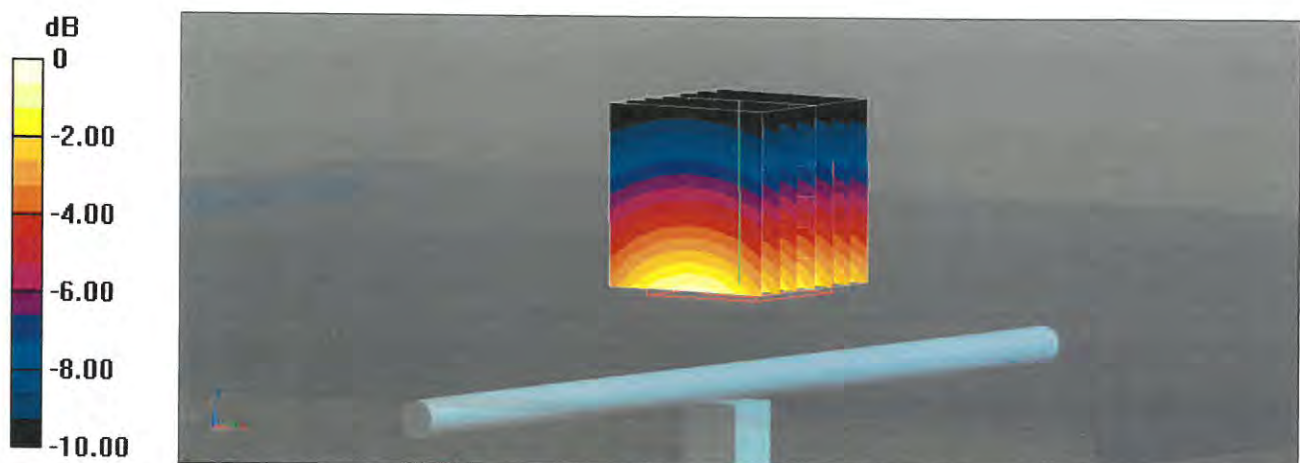

Impedance Measurement Plot for Head TSL

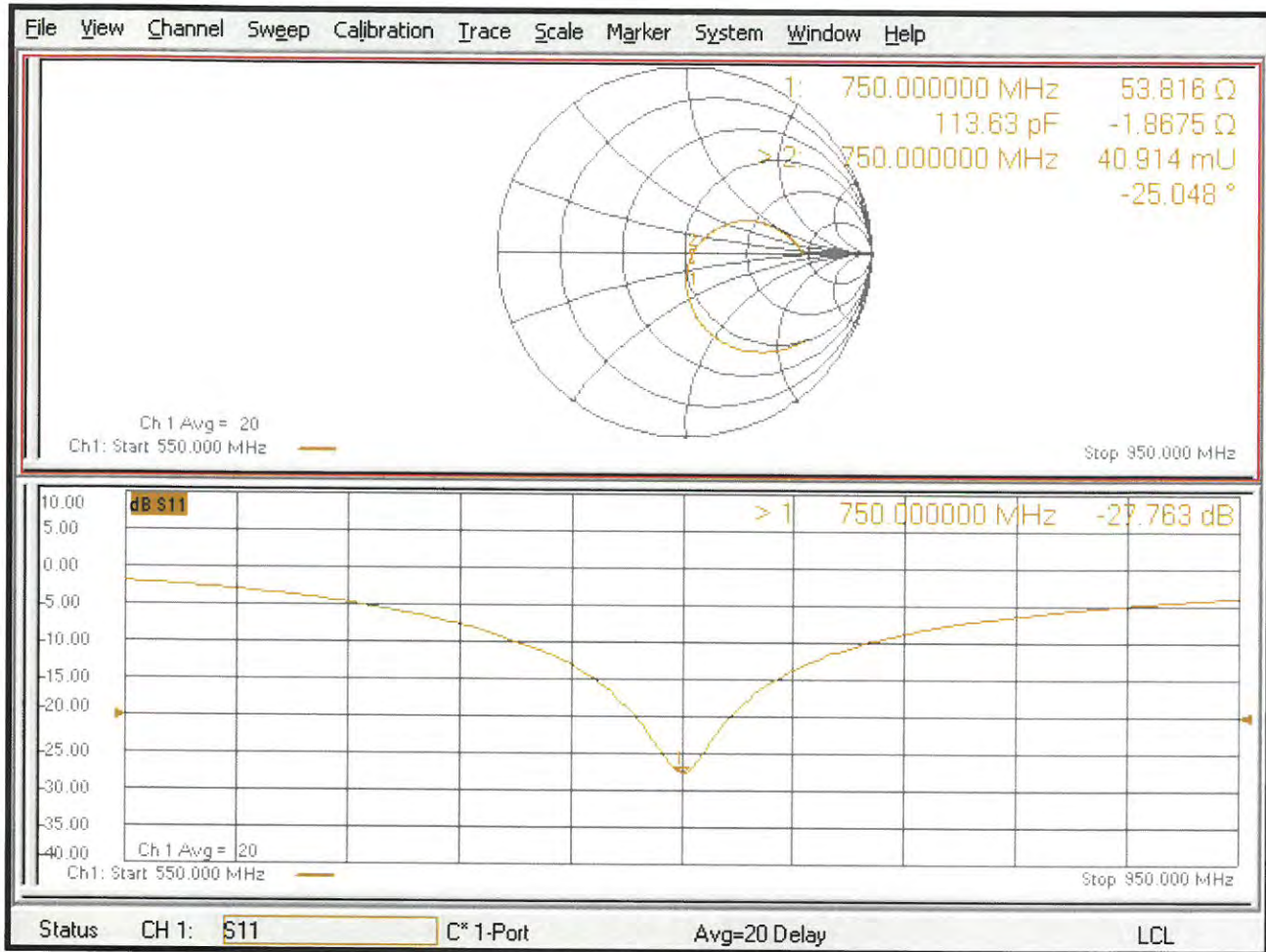

139511

**Calibration Laboratory of
Schmid & Partner
Engineering AG**
Zeughausstrasse 43, 8004 Zurich, Switzerland



S Schweizerischer Kalibrierdienst
C Service suisse d'étalonnage
S Servizio svizzero di taratura
S Swiss Calibration Service

Accredited by the Swiss Accreditation Service (SAS)
The Swiss Accreditation Service is one of the signatories to the EA
Multilateral Agreement for the recognition of calibration certificates

Accreditation No.: **SCS 0108**

Client **DEKRA (Auden)**

Certificate No: **D1750V2-1113_Nov19**

CALIBRATION CERTIFICATE

Object **D1750V2 - SN:1113**

Calibration procedure(s) **QA CAL-05.v11
Calibration Procedure for SAR Validation Sources between 0.7-3 GHz**

Calibration date: **November 21, 2019**

This calibration certificate documents the traceability to national standards, which realize the physical units of measurements (SI).
The measurements and the uncertainties with confidence probability are given on the following pages and are part of the certificate.

All calibrations have been conducted in the closed laboratory facility: environment temperature (22 ± 3)°C and humidity < 70%.

Calibration Equipment used (M&TE critical for calibration)

Primary Standards	ID #	Cal Date (Certificate No.)	Scheduled Calibration
Power meter NRP	SN: 104778	03-Apr-19 (No. 217-02892/02893)	Apr-20
Power sensor NRP-Z91	SN: 103244	03-Apr-19 (No. 217-02892)	Apr-20
Power sensor NRP-Z91	SN: 103245	03-Apr-19 (No. 217-02893)	Apr-20
Reference 20 dB Attenuator	SN: 5058 (20k)	04-Apr-19 (No. 217-02894)	Apr-20
Type-N mismatch combination	SN: 5047.2 / 06327	04-Apr-19 (No. 217-02895)	Apr-20
Reference Probe EX3DV4	SN: 7349	29-May-19 (No. EX3-7349_May19)	May-20
DAE4	SN: 601	30-Apr-19 (No. DAE4-601_Apr19)	Apr-20

Secondary Standards	ID #	Check Date (in house)	Scheduled Check
Power meter E4419B	SN: GB39512475	30-Oct-14 (in house check Feb-19)	In house check: Oct-20
Power sensor HP 8481A	SN: US37292783	07-Oct-15 (in house check Oct-18)	In house check: Oct-20
Power sensor HP 8481A	SN: MY41092317	07-Oct-15 (in house check Oct-18)	In house check: Oct-20
RF generator R&S SMT-06	SN: 100972	15-Jun-15 (in house check Oct-18)	In house check: Oct-20
Network Analyzer Agilent E8358A	SN: US41080477	31-Mar-14 (in house check Oct-19)	In house check: Oct-20

Calibrated by: **Claudio Leubler** **Laboratory Technician**

Signature

Approved by: **Katja Pokovic** **Technical Manager**

Issued: November 25, 2019

This calibration certificate shall not be reproduced except in full without written approval of the laboratory.



Accredited by the Swiss Accreditation Service (SAS)
The Swiss Accreditation Service is one of the signatories to the EA
Multilateral Agreement for the recognition of calibration certificates

Accreditation No.: **SCS 0108**

Glossary:

TSL	tissue simulating liquid
ConvF	sensitivity in TSL / NORM x,y,z
N/A	not applicable or not measured

Calibration is Performed According to the Following Standards:

- IEEE Std 1528-2013, "IEEE Recommended Practice for Determining the Peak Spatial-Averaged Specific Absorption Rate (SAR) in the Human Head from Wireless Communications Devices: Measurement Techniques", June 2013
- IEC 62209-1, "Measurement procedure for the assessment of Specific Absorption Rate (SAR) from hand-held and body-mounted devices used next to the ear (frequency range of 300 MHz to 6 GHz)", July 2016
- IEC 62209-2, "Procedure to determine the Specific Absorption Rate (SAR) for wireless communication devices used in close proximity to the human body (frequency range of 30 MHz to 6 GHz)", March 2010
- KDB 865664, "SAR Measurement Requirements for 100 MHz to 6 GHz"

Additional Documentation:

- DASY4/5 System Handbook

Methods Applied and Interpretation of Parameters:

- Measurement Conditions:* Further details are available from the Validation Report at the end of the certificate. All figures stated in the certificate are valid at the frequency indicated.
- Antenna Parameters with TSL:* The dipole is mounted with the spacer to position its feed point exactly below the center marking of the flat phantom section, with the arms oriented parallel to the body axis.
- Feed Point Impedance and Return Loss:* These parameters are measured with the dipole positioned under the liquid filled phantom. The impedance stated is transformed from the measurement at the SMA connector to the feed point. The Return Loss ensures low reflected power. No uncertainty required.
- Electrical Delay:* One-way delay between the SMA connector and the antenna feed point. No uncertainty required.
- SAR measured:* SAR measured at the stated antenna input power.
- SAR normalized:* SAR as measured, normalized to an input power of 1 W at the antenna connector.
- SAR for nominal TSL parameters:* The measured TSL parameters are used to calculate the nominal SAR result.

The reported uncertainty of measurement is stated as the standard uncertainty of measurement multiplied by the coverage factor $k=2$, which for a normal distribution corresponds to a coverage probability of approximately 95%.

Measurement Conditions

DASY system configuration, as far as not given on page 1.

DASY Version	DASY5	V52.10.3
Extrapolation	Advanced Extrapolation	
Phantom	Modular Flat Phantom	
Distance Dipole Center - TSL	10 mm	with Spacer
Zoom Scan Resolution	dx, dy, dz = 5 mm	
Frequency	1750 MHz \pm 1 MHz	

Head TSL parameters

The following parameters and calculations were applied.

	Temperature	Permittivity	Conductivity
Nominal Head TSL parameters	22.0 °C	40.1	1.37 mho/m
Measured Head TSL parameters	(22.0 \pm 0.2) °C	40.3 \pm 6 %	1.34 mho/m \pm 6 %
Head TSL temperature change during test	< 0.5 °C	----	----

SAR result with Head TSL

SAR averaged over 1 cm³ (1 g) of Head TSL	Condition	
SAR measured	250 mW input power	9.18 W/kg
SAR for nominal Head TSL parameters	normalized to 1W	37.3 W/kg \pm 17.0 % (k=2)

SAR averaged over 10 cm³ (10 g) of Head TSL	condition	
SAR measured	250 mW input power	4.85 W/kg
SAR for nominal Head TSL parameters	normalized to 1W	19.6 W/kg \pm 16.5 % (k=2)

Appendix (Additional assessments outside the scope of SCS 0108)

Antenna Parameters with Head TSL

Impedance, transformed to feed point	51.0 Ω - 1.8 j Ω
Return Loss	- 33.9 dB

General Antenna Parameters and Design

Electrical Delay (one direction)	1.217 ns
----------------------------------	----------

After long term use with 100W radiated power, only a slight warming of the dipole near the feedpoint can be measured.

The dipole is made of standard semirigid coaxial cable. The center conductor of the feeding line is directly connected to the second arm of the dipole. The antenna is therefore short-circuited for DC-signals. On some of the dipoles, small end caps are added to the dipole arms in order to improve matching when loaded according to the position as explained in the "Measurement Conditions" paragraph. The SAR data are not affected by this change. The overall dipole length is still according to the Standard.

No excessive force must be applied to the dipole arms, because they might bend or the soldered connections near the feedpoint may be damaged.

Additional EUT Data

Manufactured by	SPEAG
-----------------	-------

DASY5 Validation Report for Head TSL

Date: 21.11.2019

Test Laboratory: SPEAG, Zurich, Switzerland

DUT: Dipole 1750 MHz; Type: D1750V2; Serial: D1750V2 - SN:1113

Communication System: UID 0 - CW; Frequency: 1750 MHz

Medium parameters used: $f = 1750$ MHz; $\sigma = 1.34$ S/m; $\epsilon_r = 40.3$; $\rho = 1000$ kg/m³

Phantom section: Flat Section

Measurement Standard: DASY5 (IEEE/IEC/ANSI C63.19-2011)

DASY52 Configuration:

- Probe: EX3DV4 - SN7349; ConvF(8.67, 8.67, 8.67) @ 1750 MHz; Calibrated: 29.05.2019
- Sensor-Surface: 1.4mm (Mechanical Surface Detection)
- Electronics: DAE4 Sn601; Calibrated: 30.04.2019
- Phantom: Flat Phantom 5.0 (front); Type: QD 000 P50 AA; Serial: 1001
- DASY52 52.10.3(1513); SEMCAD X 14.6.13(7474)

Dipole Calibration for Head Tissue/Pin=250 mW, d=10mm/Zoom Scan (7x7x7)/Cube 0:

Measurement grid: dx=5mm, dy=5mm, dz=5mm

Reference Value = 107.4 V/m; Power Drift = -0.02 dB

Peak SAR (extrapolated) = 17.0 W/kg

SAR(1 g) = 9.18 W/kg; SAR(10 g) = 4.85 W/kg

Smallest distance from peaks to all points 3 dB below = 10 mm

Ratio of SAR at M2 to SAR at M1 = 54.3%

Maximum value of SAR (measured) = 14.3 W/kg

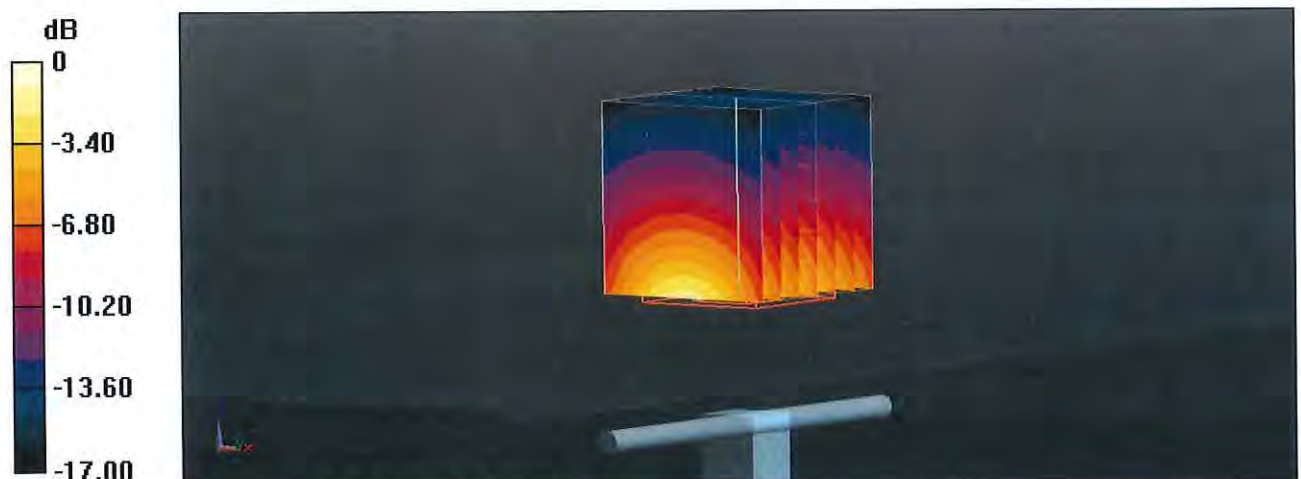

Impedance Measurement Plot for Head TSL

