



### TEST REPORT

#### FCC Part 22 Subpart H / Part 24 Subpart E

**Report Reference No.**.....: **CTL1407291808-WF**

Compiled by

( position+printed name+signature)...: File administrators Jacky Chen

Name of the organization performing the tests

Test Engineer Tracy Qi

( position+printed name+signature)...:

Approved by

( position+printed name+signature)...: Manager Tracy Qi

Date of issue.....: Sept. 13, 2014

**Test Firm**.....: **Shenzhen CTL Testing Technology Co., Ltd.**

Address.....: Floor 1-A, Baisha Technology Park, No. 3011, Shahexi Road, Nanshan, Shenzhen 518055 China.

**Applicant's name**.....: **UOVision Technology (HONGKONG) Co., Ltd**

Address.....: UNIT A3, 9/F SILVER INTERNATIONAL TOWER, 707-713 NATHAN ROAD, MONGKOK, KOWLOON, HONG KONG

**Test specification:**

Standard .....: **FCC CFR Title 47 Part 2, Part 22H, Part 24E**  
**EIA/TIA 603-C: 2004**

Master TRF.....: Dated 2011-01

**Shenzhen CTL Testing Technology Co., Ltd. All rights reserved.**

This publication may be reproduced in whole or in part for non-commercial purposes as long as the Shenzhen CTL Testing Technology Co., Ltd. is acknowledged as copyright owner and source of the material. Shenzhen CTL Testing Technology Co., Ltd. takes no responsibility for and will not assume liability for damages resulting from the reader's interpretation of the reproduced material due to its placement and context.

**Test item description** ..... : **Wireless Infrared Scouting Camera: Code Black (UM565-3G)**

**FCC ID**.....: **2AC8CUM565-3G**

Trade Mark .....: UOVision

Model/Type reference.....: Code Black (UM565-3G)

**GSM/WCDMA**

Transmit .....: 2G:GPRS 850: 824~849MHz, GPRS 1900: 1850~1910MHz  
3G:WCDMA Band II: 1850-1910MHz,  
WCDMA Band V: 824~849MHz

Receive .....: 2G:GPRS 850: 869~894MHz, GPRS 1900: 1930~1990MHz  
3G:WCDMA Band II: 1930~1990MHz,  
WCDMA Band V: 869~894MHz

Release Version .....: 2G:R99

3G:UMTS FDD: Rel-5

Type of modulation .....	2G: GMSK for GPRS, 8PSK for EDGE 3G: QPSK
GPRS Type .....	Class B
GPRS Class .....	Class 12
Antenna Gain .....	2.0 dBi for GPRS850 and WCDMA Band V 2.5 dBi for GPRS1900 and WCDMA Band II
Antenna type .....	External
IMEI .....	012813002121335
Result.....	<b>Positive</b>



**TEST REPORT**

<b>Test Report No. :</b>	<b>CTL1407291808-WF</b>	Sept. 13, 2014
		Date of issue

**Equipment under Test** : **Wireless Infrared Scouting Camera: Code Black (UM565-3G)**

**Model /Type** : Code Black (UM565-3G )

**Applicant** : **UOVision Technology (HONGKONG) Co., Ltd**

**Address** : UNIT A3, 9/F SILVER INTERNATIONAL TOWER, 707-713  
NATHAN ROAD, MONGKOK, KOWLOON, HONG KONG

**Manufacturer** **UOVision Technology (Shenzhen) Co., Ltd.**

**Address** 3rd Floor, East Wing, the 4th Building, ZhongGuan  
HongHualing Industrial Zone, 1268# Liuxian BLVD,  
Nanshan District, Shenzhen, China 518055

<b>Test Result</b> according to the standards on page 5:	<b>Positive</b>
--	-----------------

The test report merely corresponds to the test sample.  
It is not permitted to copy extracts of these test result without the written permission of the test laboratory.

# Contents

<b>1. TEST STANDARDS .....</b>	<b>5</b>
<b>2. SUMMARY .....</b>	<b>6</b>
2.1. General Remarks .....	6
2.2. Equipment Under Test .....	6
2.3. Short description of the Equipment under Test (EUT) .....	6
2.4. EUT operation mode .....	6
2.5. EUT configuration .....	7
2.6. Related Submittal(s) / Grant (s).....	7
2.7. Modifications .....	7
<b>3. TEST ENVIRONMENT .....</b>	<b>8</b>
3.1. Address of the test laboratory .....	8
3.2. Test Facility .....	8
3.3. Environmental conditions .....	8
3.4. Configuration of Tested System .....	8
3.5. EUT Exercise Software .....	9
3.6. Statement of the measurement uncertainty .....	9
3.7. Equipments Used during the Test .....	10
3.8. Summary of Test Result .....	11
<b>4. TEST CONDITIONS AND RESULTS .....</b>	<b>12</b>
4.1. Peak Output Power.....	12
4.2. Modulation Characteristic .....	18
4.3. Occupied Bandwidth.....	19
4.4. Spurious Emission At Antenna Terminals (+/- 1MHz) .....	32
4.5. Spurious Emission .....	39
4.6. Frequency Stability under Temperature & Voltage Variations .....	65
<b>5. TEST SETUP PHOTOS OF THE EUT .....</b>	<b>72</b>
<b>6. EXTERNAL AND INTERNAL PHOTOS OF THE EUT.....</b>	<b>73</b>

## 1. TEST STANDARDS

The tests were performed according to following standards:

[FCC Part 22 Subpart H](#): Public Mobile Services

[FCC Part 24 Subpart E](#): Personal Communications Services

[EIA/TIA 603-C: 2004](#)

[FCC CFR Title 47 Part 2](#)



## 2. SUMMARY

### 2.1. General Remarks

Date of receipt of test sample : Aug. 10, 2014

Testing commenced on : Aug. 10, 2014

Testing concluded on : Sept. 13, 2014

### 2.2. Equipment Under Test

#### Power supply system utilised

Power supply voltage :  120V / 60 Hz  115V / 60Hz  
 12 V DC  24 V DC  
 Other (specified in blank below)

DC 6.0 V from battery

### 2.3. Short description of the Equipment under Test (EUT)

A Wireless Infrared Scouting Camera: Code Black (UM565-3G) with UMTS/GSM function.  
 For more details, refer to the user's manual of the EUT.  
 Serial number: Prototype

### 2.4. EUT operation mode

CTL has verified the construction and function in typical operation. All the test modes were carried out with the EUT in normal operation, which was shown in this test report and defined as:

Test Mode
Mode 1: GPRS850
Mode 2: GPRS1900
Mode 3: EDGE 850
Mode 4: EDGE 1900
Mode 5: WCDMA Band II
Mode 6: WCDMA Band V
Mode 7: HSDPA Band II
Mode 8: HSDPA Band V

#### Note:

1. Regards to the frequency band operation: the lowest, middle and highest frequency of channel were selected to perform the test, then shown on this report.
2. For the ERP/EIRP and radiated emission test, every axis (X, Y, Z) was verified, and show the worst result on this report.
3. Radiated power output working at WCDMA link was higher than that working at HSDPA link, so all of test items were done working at WCDMA mode reported in the report. Refer to peak power output for more details.

## 2.5. EUT configuration

The following peripheral devices and interface cables were connected during the measurement:

o - supplied by the manufacturer

o - supplied by the lab

o  
Manufacturer :  
Model No. :

## 2.6. Related Submittal(s) / Grant (s)

This submittal(s) (test report) is intended for FCC ID: 2AC8CUM565-3G filing to comply with of the FCC Part 22 and Part 24 and Part 27 Rules.

## 2.7. Modifications

No modifications were implemented to meet testing criteria.



### 3. TEST ENVIRONMENT

#### 3.1. Address of the test laboratory

Shenzhen CTL Testing Technology Co., Ltd.  
 Floor 1-A, Baisha Technology Park, No. 3011, Shahexi Road, Nanshan, Shenzhen 518055 China

There is one 3m semi-anechoic chamber and two line conducted labs for final test. The Test Sites meet the requirements in documents ANSI C63.4 and CISPR 22/EN 55022 requirements.

#### 3.2. Test Facility

The test facility is recognized, certified, or accredited by the following organizations:

##### IC Registration No.: 9618B

The 3m alternate test site of Shenzhen CTL Testing Technology Co., Ltd. EMC Laboratory has been registered by Certification and Engineer Bureau of Industry Canada for the performance of with Registration No.: 9618B on November 13, 2013.

##### FCC-Registration No.: 970318

Shenzhen CTL Testing Technology Co., Ltd. EMC Laboratory has been registered and fully described in a report filed with the (FCC) Federal Communications Commission. The acceptance letter from the FCC is maintained in our files. Registration 970318, December 19, 2013.

#### 3.3. Environmental conditions

During the measurement the environmental conditions were within the listed ranges:

Temperature: 15-35 ° C

Humidity: 30-60 %

Atmospheric pressure: 950-1050mbar

#### 3.4. Configuration of Tested System

Fig. 2-1 Configuration of Tested System

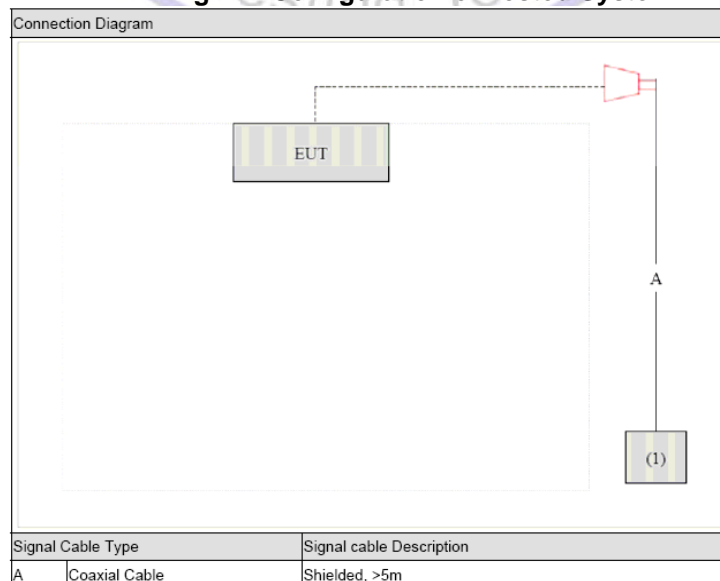



### 3.5. EUT Exercise Software

1. Setup the EUT and simulators as shown on above.
2. Turn on the power of all equipment.
3. EUT Communicate with CMU200, then select channel to test.

### 3.6. Statement of the measurement uncertainty

The data and results referenced in this document are true and accurate. The reader is cautioned that there may be errors within the calibration limits of the equipment and facilities. The measurement uncertainty was calculated for all measurements listed in this test report acc. to CISPR 16 - 4 „Specification for radio disturbance and immunity measuring apparatus and methods – Part 4: Uncertainty in EMC Measurements“ and is documented in the Shenzhen CTL Testing Technology Co., Ltd. quality system acc. to DIN EN ISO/IEC 17025. Furthermore, component and process variability of devices similar to that tested may result in additional deviation. The manufacturer has the sole responsibility of continued compliance of the device.

Hereafter the best measurement capability for CTL laboratory is reported:

Test	Range	Measurement Uncertainty	Notes
Radiated Emission	30~1000MHz	4.10dB	(1)
Radiated Emission	Above 1GHz	4.32dB	(1)
Conducted Disturbance	0.15~30MHz	3.20dB	(1)

- (1) This uncertainty represents an expanded uncertainty expressed at approximately the 95% confidence level using a coverage factor of k=2.

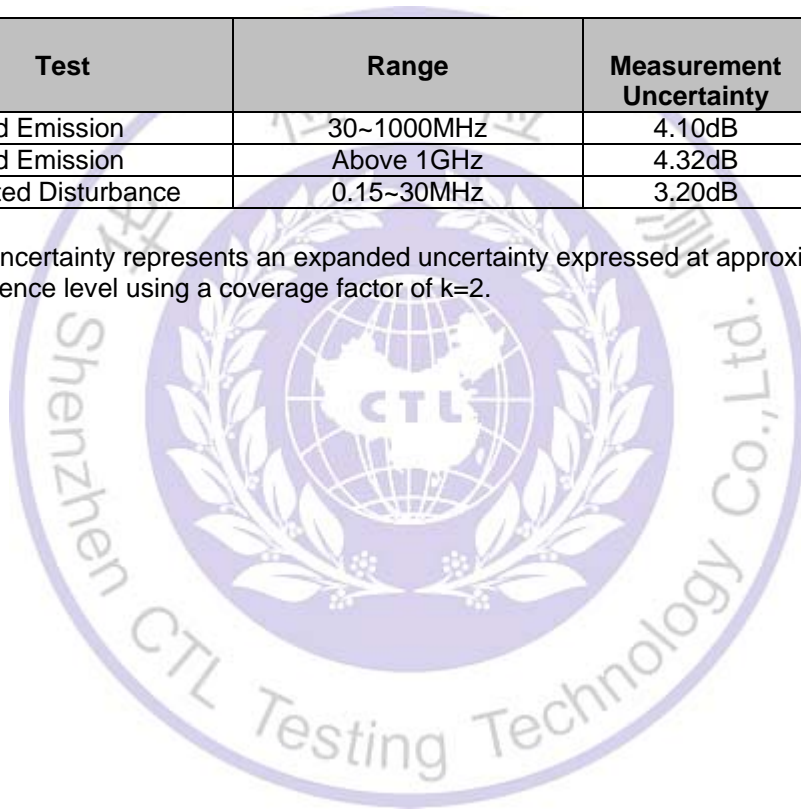

### 3.7. Equipments Used during the Test

Test Equipment	Manufacturer	Model No.	Serial No.	Calibration Date	Calibration Due Date
Bilog Antenna	Sunol Sciences Corp.	JB1	A061713	2014/07/12	2015/07/11
EMI Test Receiver	R&S	ESCI	103710	2014/07/10	2015/07/09
Spectrum Analyzer	Agilent	E4407B	MY45108355	2014/07/06	2015/07/05
Controller	EM Electronics	Controller EM 1000	N/A	2014/07/06	2015/07/05
Horn Antenna	Sunol Sciences Corp.	DRH-118	A062013	2014/07/12	2015/07/11
Horn Antenna	SCHWARZBECK	BBHA9170	1562	2014/07/12	2015/07/11
Active Loop Antenna	SCHWARZBECK	FMZB1519	1519-037	2014/07/12	2015/07/11
LISN	R&S	ENV216	101316	2014/07/10	2015/07/09
LISN	SCHWARZBECK	NSLK8127	8127687	2014/07/10	2015/07/09
Microwave Preamplifier	HP	8349B	3155A00882	2014/07/10	2015/07/09
Amplifier	HP	8447D	3113A07663	2014/07/10	2015/07/09
Transient Limiter	Com-Power	LIT-153	532226	2014/07/10	2015/07/09
Radio Communication Tester	R&S	CMU200	3655A03522	2014/07/06	2015/07/05
Temperature/Humidity Meter	zhicheng	ZC1-2	22522	2014/07/10	2015/07/09
SIGNAL GENERATOR	HP	8647A	3200A00852	2014/07/10	2015/07/09
Wideband Peak Power Meter	Anritsu	ML2495A	220.23.35	2014/07/06	2015/07/05
Climate Chamber	ESPEC	EL-10KA	A20120523	2014/07/06	2015/07/05
High-Pass Filter	K&L	9SH10-2700/X12750-O/O	/	2014/07/06	2015/07/05
High-Pass Filter	K&L	41H10-1375/U12750-O/O	/	2014/07/06	2015/07/05

### 3.8. Summary of Test Result

No deviations from the test standards

For GSM 850/WCDMA Band V (FCC Part 22H & Part 2)

Emission			
Performed Item	Normative References	Test Performed	Deviation
Peak Output Power	FCC Part 22.913(a)(2) and Part 2.1046 EIA/TIA 603-C	Yes	No
Modulation Characteristic	FCC Part 2.1047(d)	Yes	No
Occupied Bandwidth	FCC Part 2.1049	Yes	No
Spurious Emission At Antenna Terminals (+/- 1MHz)	FCC Part 22.917(a) and Part 2.1049	Yes	No
Spurious Emission	FCC Part 22.917(b) and Part 2.1051, 2.1053 EIA/TIA 603-C	Yes	No
Frequency Stability Under Temperature & Voltage Variations	FCC Part 22.355 and 2.1055 EIA/TIA 603-C	Yes	No

For GPRS 1900/WCDMA Band II (FCC Part 24E & Part 2)

Emission			
Performed Item	Normative References	Test Performed	Deviation
Peak Output Power	FCC Part 24.232(b) and Part 2.1046 EIA/TIA 603-C	Yes	No
Modulation Characteristic	FCC Part 2.1047(d)	Yes	No
Occupied Bandwidth	FCC Part 24.238(b) and Part 2.1049	Yes	No
Spurious Emission At Antenna Terminals (+/- 1MHz)	FCC Part 24.238(a) and Part 2.1049	Yes	No
Spurious Emission	FCC Part 24.238(b) and Part 2.1051, 2.1053 EIA/TIA 603-C	Yes	No
Frequency Stability Under Temperature & Voltage Variations	FCC Part 24.235 and 2.1055 EIA/TIA 603-C	Yes	No

## 4. TEST CONDITIONS AND RESULTS

### 4.1. Peak Output Power

#### TEST CONFIGURATION

Conducted Power Measurement:

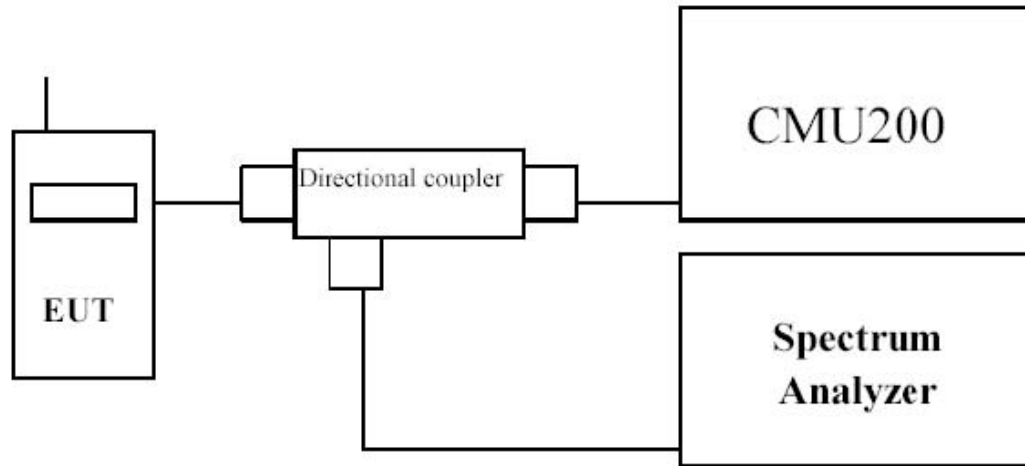

Radiated Power Measurement:

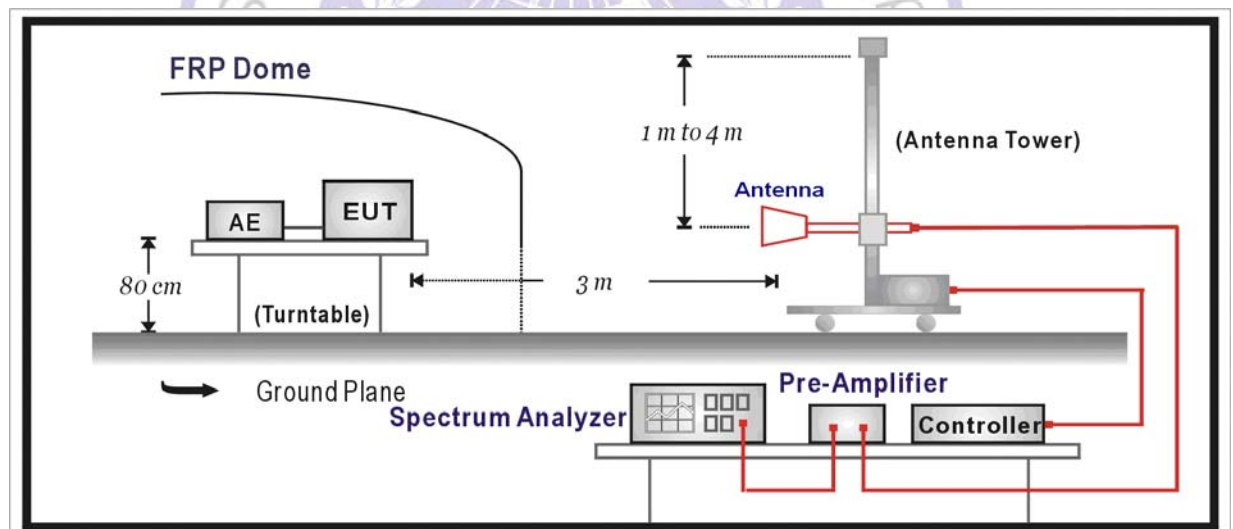

#### TEST PROCEDURE

The EUT was setup according to EIA/TIA 603C

#### **Conducted Power Measurement:**

- Place the EUT on a bench and set it in transmitting mode.
- Connect a low loss RF cable from the antenna port to a spectrum analyzer and CMU200 by a Directional Couple.
- EUT Communicate with CMU200, then select a channel for testing.
- Add a correction factor to the display of spectrum, and then test.

**Radiated Power Measurement:**

- a) The EUT shall be placed at the specified height on a support, and in the position closest to normal use as declared by provider.
- b) The test antenna shall be oriented initially for vertical polarization and shall be chosen to correspond to the frequency of the transmitter
- c) The output of the test antenna shall be connected to the measuring receiver.
- d) The transmitter shall be switched on and the measuring receiver shall be tuned to the frequency of the transmitter under test.
- e) The test antenna shall be raised and lowered through the specified range of height until a maximum signal level is detected by the measuring receiver.
- f) The transmitter shall then be rotated through  $360^{\circ}$  in the horizontal plane, until the maximum signal level is detected by the measuring receiver.
- g) The test antenna shall be raised and lowered again through the specified range of height until a maximum signal level is detected by the measuring receiver.
- h) The maximum signal level detected by the measuring receiver shall be noted.
- i) The transmitter shall be replaced by a substitution antenna.
- j) The substitution antenna shall be orientated for vertical polarization and the length of the substitution antenna shall be adjusted to correspond to the frequency of the transmitter.
- k) The substitution antenna shall be connected to a calibrated signal generator.
- l) If necessary, the input attenuator setting of the measuring receiver shall be adjusted in order to increase the sensitivity of the measuring receiver.
- m) The test antenna shall be raised and lowered through the specified range of height to ensure that the maximum signal is received.
- n) The input signal to the substitution antenna shall be adjusted to the level that produces a level detected by the measuring receiver, that is equal to the level noted while the transmitter radiated power was measured, corrected for the change of input attenuator setting of the measuring receiver.
- o) The measurement shall be repeated with the test antenna and the substitution antenna orientated for horizontal polarization.
- p) The measure of the effective radiated power is the larger of the two levels recorded at the input to the substitution antenna, corrected for gain of the substitution antenna if necessary.
- q) Test site anechoic chamber refer to ANSI C63.4: 2003.

**Base station simulator settings for each test mode:**

1. For GSM/GPRS/EDGE  
Configure R&S CMU200 to support GMSK call respectively, and set one timeslot transmission for GMSK GSM/GPRS, 8PSK EDGE.  
Measure and record power outputs for both modulations.
2. For WCDMA  
Configure the CMU-200 to support all WCDMA tests in respect to the 3GPP 34.121.  
Measure the EUT output power at 826.4MHz, 836.6MHz and 846.6MHz for WCDMA Band V, and 1852.4MHz, 1880MHz and 1907.6MHz for WCDMA Band II.  
For Rel 99
  - Set a Test Mode 1 loop back with a 12.2kbps Reference Measurement Channel (RMC)
  - Set and send continuously Up power control commands to the Gobi2000
  - Measure the power at the Gobi2000 Module antenna connector by using CMU-200.

**LIMIT**

For FCC Part 22.913(a)(2):

The ERP of mobile transmitters and auxiliary test transmitters must not exceed 7 Watts.

For FCC Part 24.232(b):

The EIRP of mobile transmitters and auxiliary test transmitters must not exceed 2 Watts.

For FCC Part 27:

The EIRP of mobile transmitters and auxiliary test transmitters must not exceed 1 Watts.

**TEST RESULTS****Conducted Power Measurement****GPRS/EDGE**

Test Mode	Channel No.	Frequency (MHz)	Modulation	Conducted Power (dBm)
GPRS850	128	824.2	GMSK	32.36
	189	836.4	GMSK	31.89
	251	848.8	GMSK	32.04
GPRS1900	512	1850.2	GMSK	30.16
	661	1880.0	GMSK	30.04
	810	1909.8	GMSK	29.98
EDGE850	128	824.2	8PSK	26.43
	189	836.4	8PSK	26.04
	251	848.8	8PSK	26.21
EDGE1900	512	1850.2	8PSK	25.56
	661	1880.0	8PSK	25.25
	810	1909.8	8PSK	25.03

Note: All conducted measurements are based on a peak detector.

**WCDMA/HSDPA**

Mode	3GPP Subtest	Band II (1900MHz) Channel			MPR
		Conducted Power (dBm)			
		9262	9400	9538	
WCDMA R99	1	22.87	22.72	22.63	N/A
Rel5 HSDPA	1	21.52	21.39	21.20	0
	2	21.49	21.36	21.18	0
	3	21.02	20.91	20.76	0.5
	4	21.01	20.86	20.71	0.5

Mode	3GPP Subtest	Band V (850MHz) Channel			MPR
		Conducted Power (dBm)			
		4132	4182	4233	
WCDMA R99	1	23.60	23.36	23.32	N/A
Rel5 HSDPA	1	22.67	22.58	22.39	0
	2	22.65	22.56	22.34	0
	3	22.16	22.04	21.83	0.5
	4	22.11	22.01	21.81	0.5

Note: All conducted measurements are based on a peak detector.

## ERP/EIRP

## GPRS850

Frequency (MHz)	SA Reading (dBm)	Ant. Pol. (H/V)	SG Reading (dBm)	Cable Loss (dB)	Gain (dBd)	ERP (dBm)	Limit (dBm)	Margin (dB)
Low Channel 128 (824.20MHz)								
824.20	-15.42	H	18.33	1.76	-0.02	16.55	38.50	-21.95
824.20	-0.21	V	34.28	1.76	-0.02	32.50	38.50	-6.00
Middle Channel 189 (836.40MHz)								
836.40	-14.62	H	19.27	1.75	0.10	17.62	38.50	-20.88
836.40	-0.99	V	33.77	1.75	0.10	32.12	38.50	-6.38
High Channel 251 (848.80MHz)								
848.80	-12.93	H	21.08	1.78	0.13	19.43	38.50	-19.07
848.80	-0.65	V	33.96	1.78	0.13	32.31	38.50	-6.19

## GPRS1900

Frequency (MHz)	SA Reading (dBm)	Ant. Pol. (H/V)	SG Reading (dBm)	Cable Loss (dB)	Gain (dBi)	EIRP (dBm)	Limit (dBm)	Margin (dB)
Low Channel 512 (1850.20MHz)								
1850.20	23.94	H	22.54	2.68	10.40	30.26	33.00	-2.74
1850.20	11.85	V	10.26	2.68	10.40	17.98	33.00	-15.02
Middle Channel 661 (1880.00MHz)								
1880.00	23.84	H	22.34	2.68	10.43	30.09	33.00	-2.91
1880.00	21.36	V	19.52	2.68	10.43	27.27	33.00	-5.73
High Channel 810 (1909.80MHz)								
1909.80	23.50	H	22.15	2.70	10.44	29.89	33.00	-3.11
1909.80	19.01	V	17.25	2.70	10.44	24.99	33.00	-8.01



## EDGE 850

Frequency (MHz)	SA Reading (dBm)	Ant. Pol. (H/V)	SG Reading (dBm)	Cable Loss (dB)	Gain (dBd)	ERP (dBm)	Limit (dBm)	Margin (dB)
Low Channel 128 (824.20MHz)								
824.20	-16.33	H	17.42	1.76	-0.02	15.64	38.50	-22.86
824.20	-6.16	V	28.34	1.76	-0.02	26.56	38.50	-11.94
Middle Channel 189 (836.40MHz)								
836.40	-16.61	H	17.28	1.75	0.10	15.63	38.50	-22.87
836.40	-6.97	V	27.79	1.75	0.10	26.14	38.50	-12.36
High Channel 251 (848.80MHz)								
848.80	-17.35	H	16.67	1.78	0.13	15.02	38.50	-23.49
848.80	-6.65	V	27.96	1.78	0.13	26.31	38.50	-12.19

## EDGE1900

Frequency (MHz)	SA Reading (dBm)	Ant .Pol. (H/V)	SG Reading (dBm)	Cable Loss (dB)	Gain (dBi)	EIRP (dBm)	Limit (dBm)	Margin (dB)
Low Channel 512 (1850.20MHz)								
1850.20	18.84	H	17.44	2.68	10.40	25.16	33.00	-7.84
1850.20	9.87	V	8.28	2.68	10.40	16.00	33.00	-17.00
Middle Channel 661 (1880.00MHz)								
1880.00	18.64	H	17.11	2.68	10.43	24.86	33.00	-8.14
1880.00	10.67	V	8.83	2.68	10.43	16.58	33.00	-16.43
High Channel 810 (1909.80MHz)								
1909.80	18.29	H	16.94	2.70	10.44	24.68	33.00	-8.32
1909.80	9.74	V	7.95	2.70	10.44	15.69	33.00	-17.32





## WCDMA Band II

Frequency (MHz)	SA Reading (dBm)	Ant. Pol. (H/V)	SG Reading (dBm)	Cable Loss (dB)	Gain (dBi)	EIRP (dBm)	Limit (dBm)	Margin (dB)
Low Channel 9262 (1852.40MHz)								
1852.40	16.25	H	15.71	3.55	10.40	22.56	33.00	-10.44
1852.40	3.95	V	3.22	3.55	10.40	10.07	33.00	-22.93
Middle Channel 9400 (1880.00MHz)								
1880.00	16.19	H	15.53	3.53	10.43	22.43	33.00	-10.57
1880.00	3.31	V	2.31	3.53	10.43	9.21	33.00	-23.80
High Channel 9538 (1907.60MHz)								
1907.60	16.00	H	15.43	3.56	10.44	22.31	33.00	-10.69
1907.60	4.15	V	3.19	3.56	10.44	10.07	33.00	-22.93

## WCDMA Band V

Frequency (MHz)	SA Reading (dBm)	Ant .Pol. (H/V)	SG Reading (dBm)	Cable Loss (dB)	Gain (dBd)	ERP (dBm)	Limit (dBm)	Margin (dB)
Low Channel 4132 (826.40MHz)								
826.40	-21.86	H	12.69	2.56	-0.02	10.11	38.50	-28.39
826.40	-8.29	V	26.43	2.56	-0.02	23.85	38.50	-14.65
Middle Channel 4182 (836.40MHz)								
836.40	-24.69	H	10.14	2.59	0.10	7.65	38.50	-30.86
836.40	-8.41	V	26.05	2.59	0.10	23.56	38.50	-14.94
High Channel 4233 (846.60MHz)								
846.60	-23.35	H	11.35	2.54	0.13	8.94	38.50	-29.56
846.60	-8.40	V	25.90	2.54	0.13	23.49	38.50	-15.01

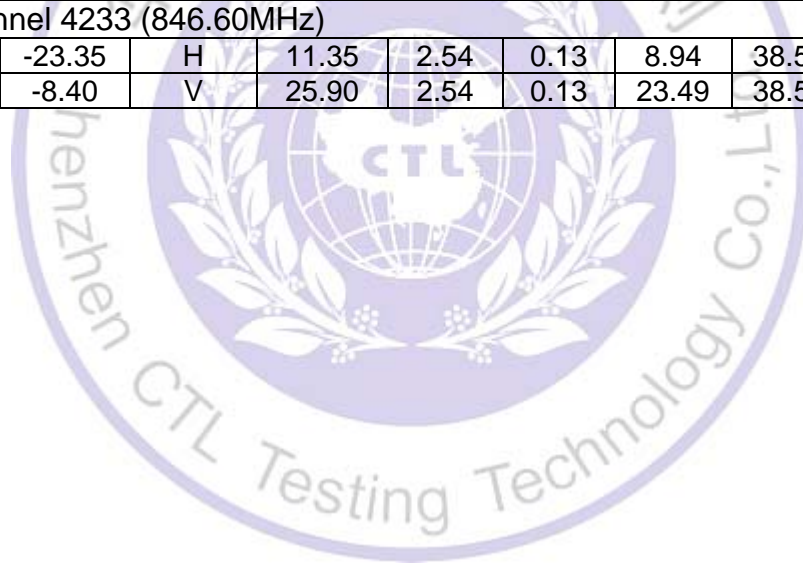

## 4.2. Modulation Characteristic

### TEST CONFIGURATION

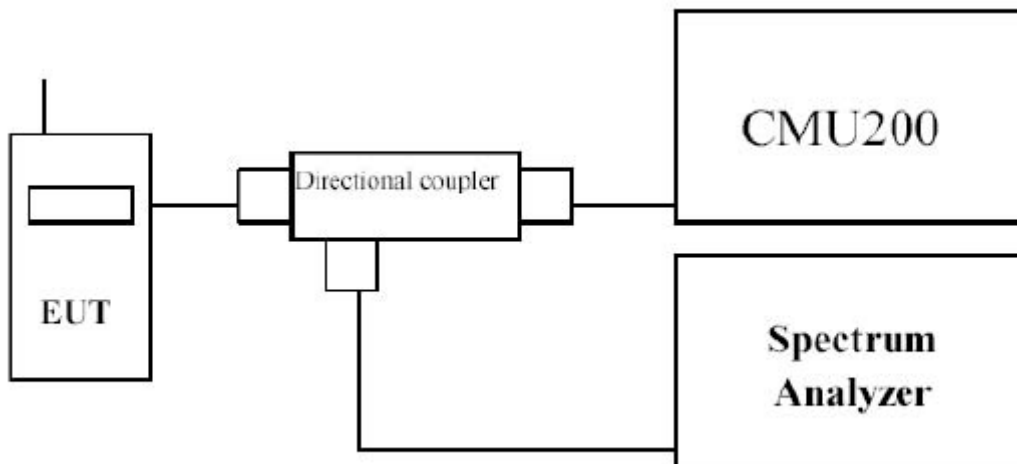

### LIMIT

N/A

### TEST PROCEDURE

GMSK is a form of binary signaling schemes which represent digital states as a shift between discrete sinusoidal frequencies called Frequency Shift Keying (FSK). Minimum Shift Keying (MSK) is continuous phase FSK with the smallest possible modulation index  $h$ . Modulation index is defined as:  
 $h = 2 * F * T_b$   
where  $F$  = Peak frequency deviation in Hz and  $T_b$  = Bit period in seconds

Two discrete frequencies, representing two distinct digital states, with equal phases at switch time  $t = 0$  requires a minimum value of  $h = 0.5$ . The Gaussian part of GMSK describes the fact that the digital pulses are filtered in the time domain. This results in bits which are sinusoidal rather than square. The effective spectrum is then compressed with the average carrier frequency in the center of the passband. This is a great advantage because of the significantly reduced bandwidth. GMSK is utilized because of these bandwidth conservation properties.

The bandwidth for GSM is a 60 MHz up-link at 1850-1910 MHz and down-link at 1930-1990 MHz. The 65 MHz is divided into 299 channels, each of which is 200 kHz wide. Slight spectral spillage is allowed into neighboring channels (which is minimized by GMSK). This separated transmit/receive frequencies scheme under GSM enables easier duplex filtering.

Within the bandwidth, individual channels are subdivided into multiframes (made of 26 frames), frames (made of 8 time slots), and time slots (made of 8 fields). The time slots are 0.57 ms long allowing 156.25 bits of information including overhead.

### TEST RESULTS

The modulation of GPRS/WCDMA was verified and confirmed compliance with requirement.

### 4.3. Occupied Bandwidth

#### TEST CONFIGURATION

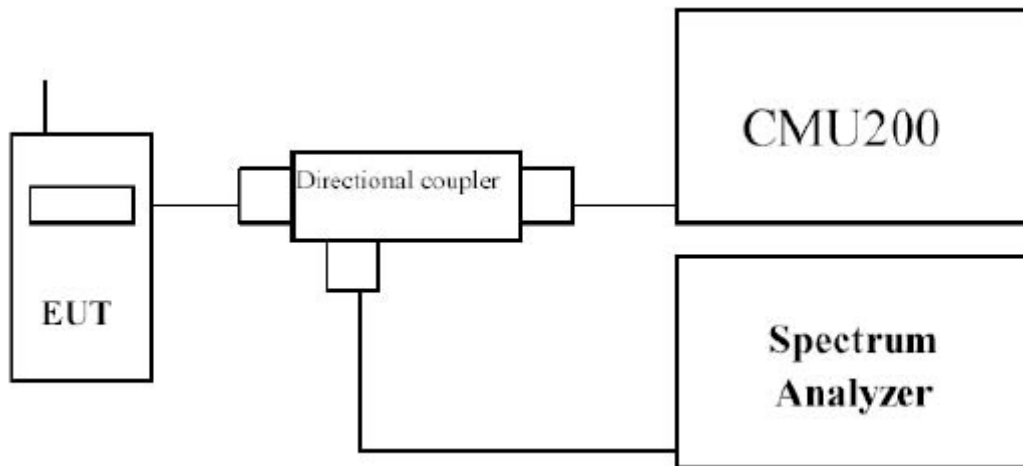

#### TEST PROCEDURE

Using Occupied Bandwidth measurement function of spectrum analyzer, and setting as follows:

For GPRS 850/1900 test --- RBW = 3 kHz and VBW = 10 kHz

For WCDMA FDD Band II/IV/V test --- RBW = 50 kHz and VBW = 200 kHz

#### LIMIT

N/A

#### TEST RESULTS

See next pages.

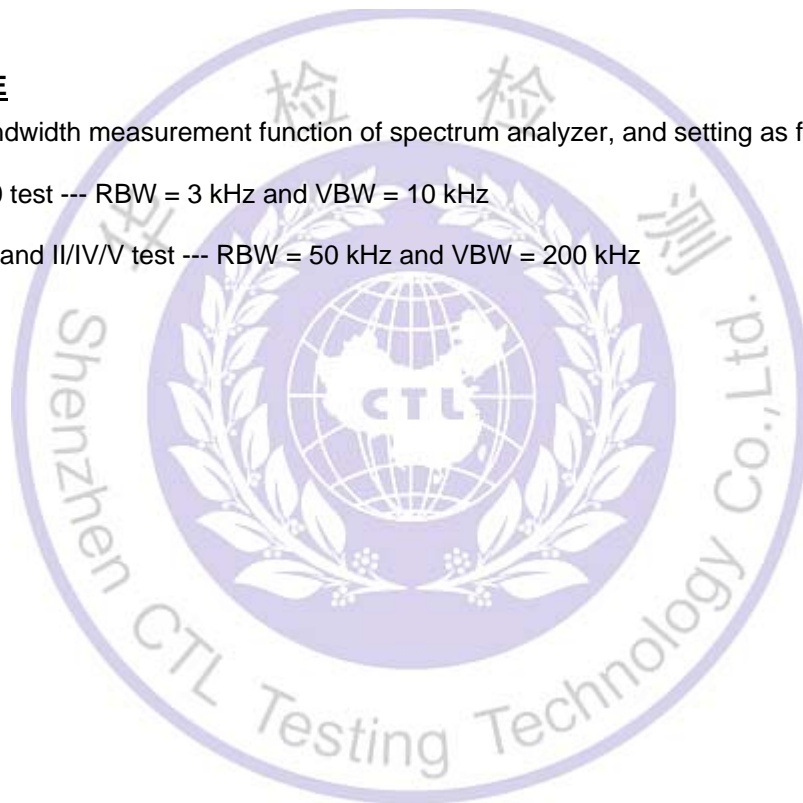

Test Item	Occupied Bandwidth		
Test Mode	Mode 1: GPRS 850 Link		
Date of Test	2014/09/10	Test Site	AC6

Channel No.	Frequency (MHz)	-26dB Occupied Bandwidth (kHz)	99% Occupied Bandwidth (kHz)
128	824.20	313.779	246.661
189	836.40	318.739	245.246
251	848.80	313.508	246.123

Figure Channel 128 (824.20MHz)

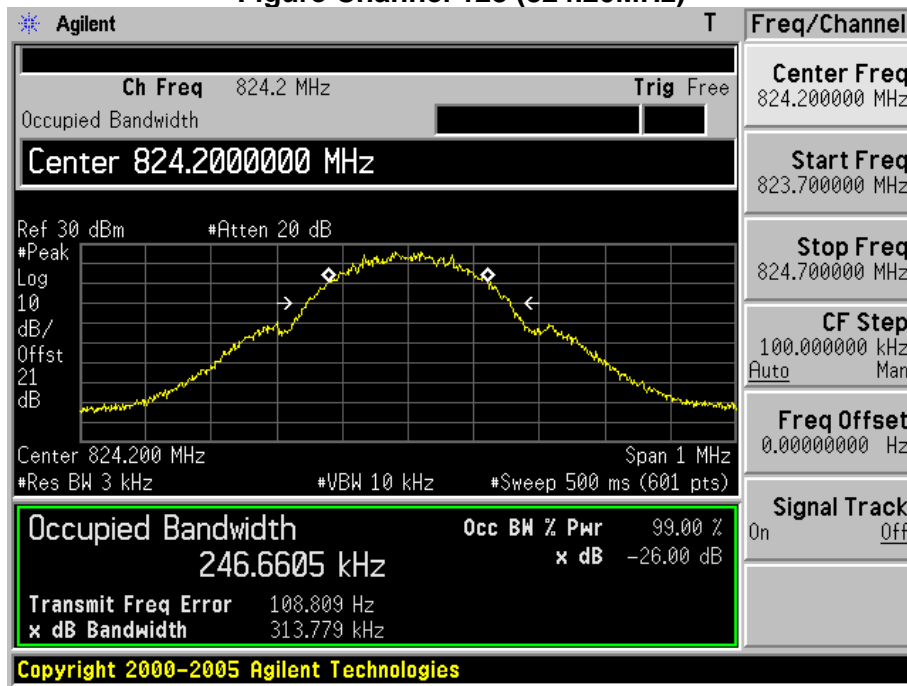

Figure Channel 189 (836.40MHz)

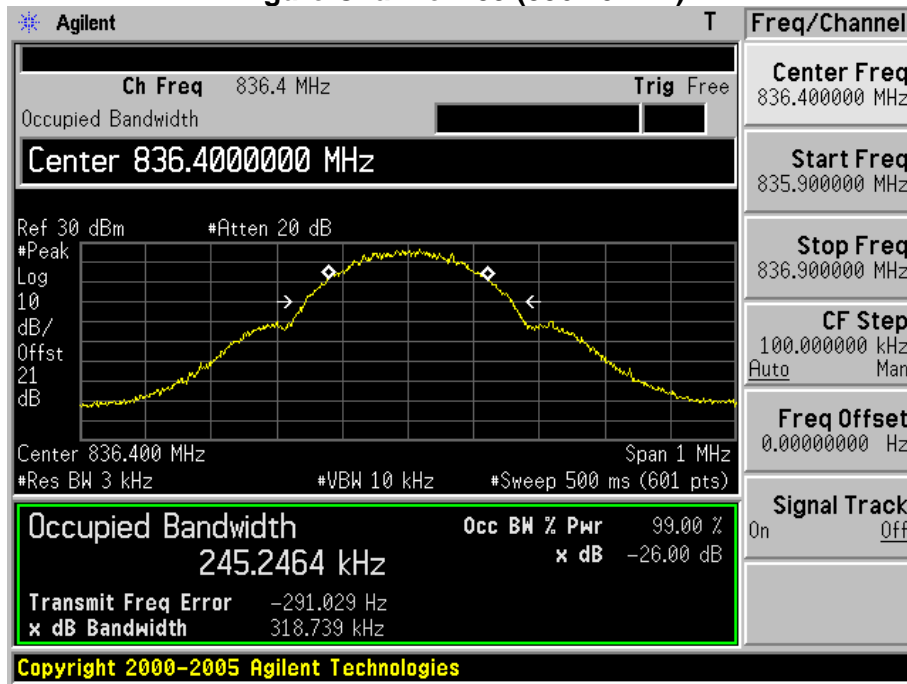
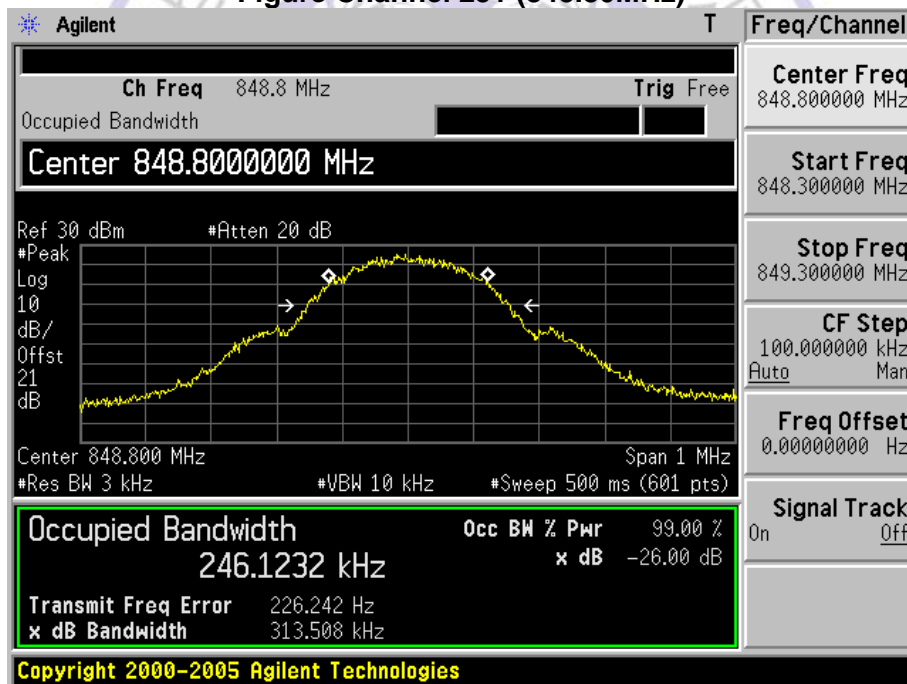

Figure Channel 251 (848.80MHz)



Test Item	Occupied Bandwidth		
Test Mode	Mode 2: GPRS 1900 Link		
Date of Test	2014/09/10	Test Site	AC6

Channel No.	Frequency (MHz)	-26dB Occupied Bandwidth (kHz)	99% Occupied Bandwidth (kHz)
512	1850.20	323.544	245.074
661	1880.00	311.853	244.810
810	1909.80	311.549	243.950

Figure Channel 512 (1850.20MHz)

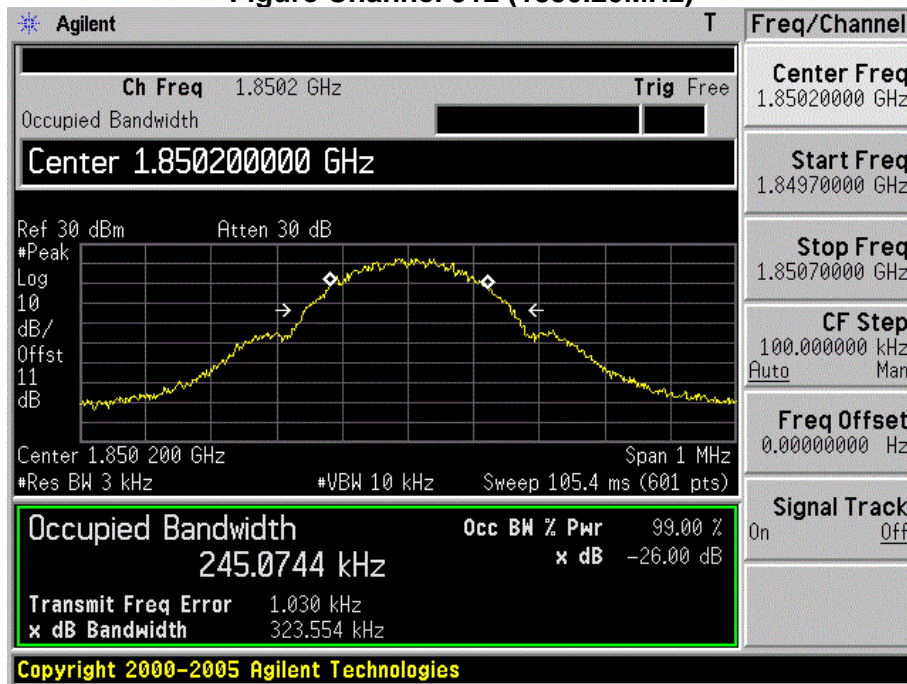

Figure Channel 661 (1880.00MHz)

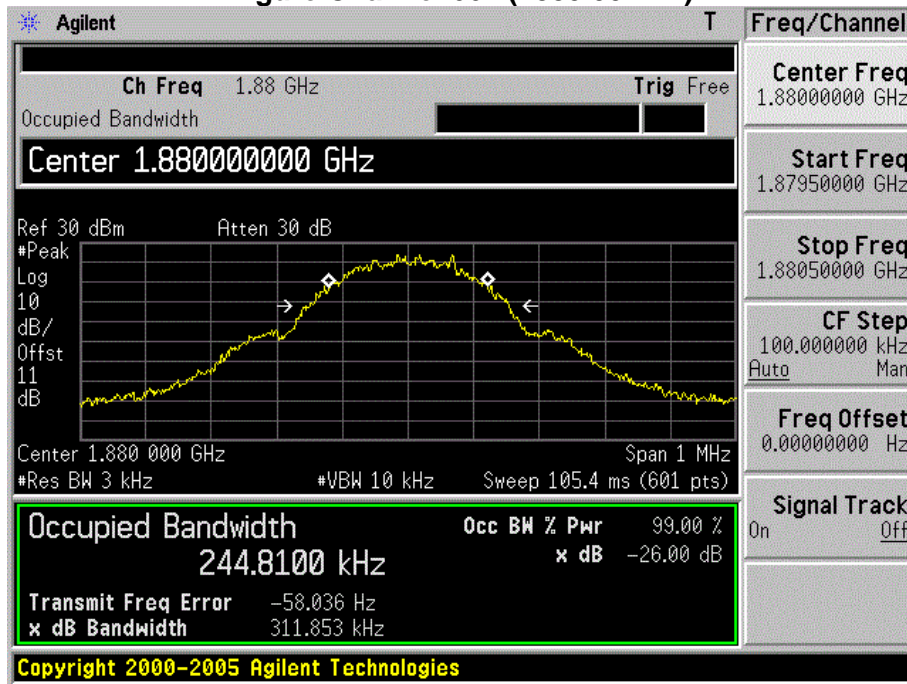

Figure Channel 810 (1909.80MHz)



Test Item	Occupied Bandwidth		
Test Mode	Mode 3: EDGE 850 Link		
Date of Test	2014/09/10	Test Site	AC6

Channel No.	Frequency (MHz)	-26dB Occupied Bandwidth (kHz)	99% Occupied Bandwidth (kHz)
128	824.20	326.934	243.337
189	836.40	313.835	237.084
251	848.80	297.762	236.210

Figure Channel 128 (824.20MHz)

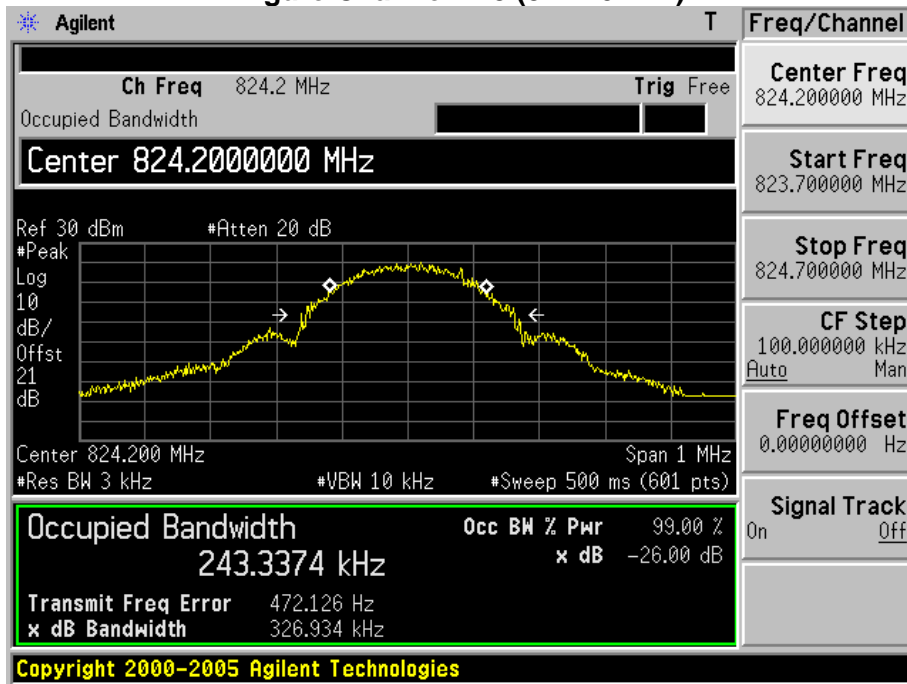



Figure Channel 189 (836.40MHz)

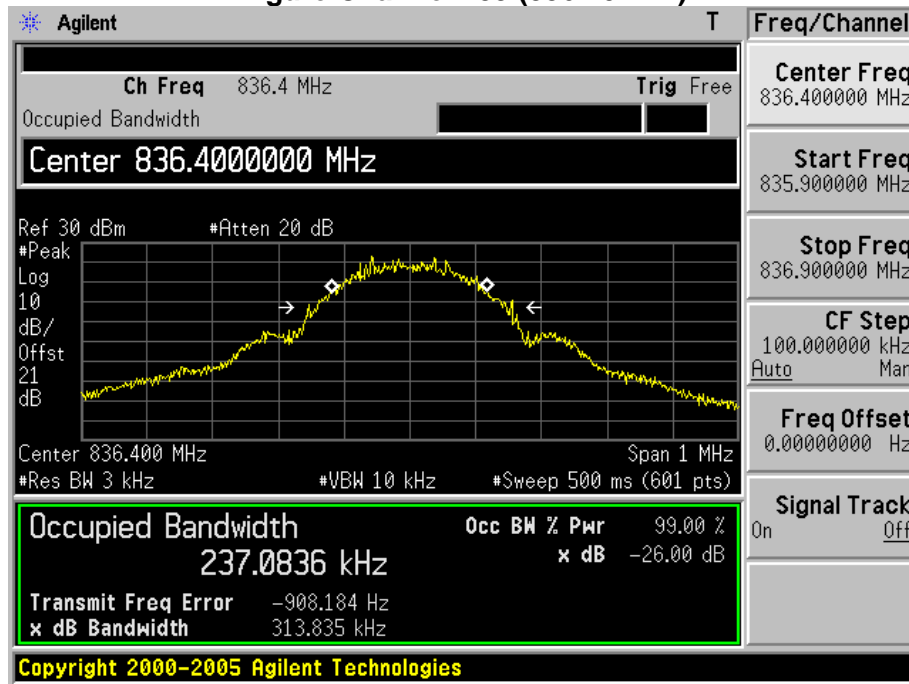
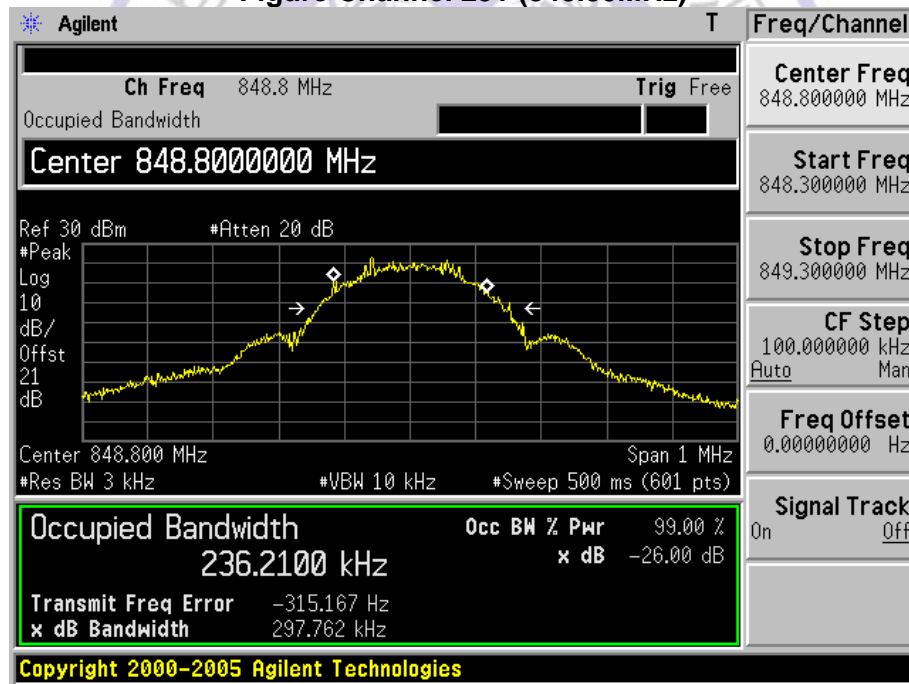

Figure Channel 251 (848.80MHz)



Test Item	Occupied Bandwidth		
Test Mode	Mode 4: EDGE 1900 Link		
Date of Test	2014/09/10	Test Site	AC6

Channel No.	Frequency (MHz)	-26dB Occupied Bandwidth (kHz)	99% Occupied Bandwidth (kHz)
512	1850.20	298.356	240.637
661	1880.00	315.274	245.804
810	1909.80	312.865	242.357

Figure Channel 512 (1850.20MHz)

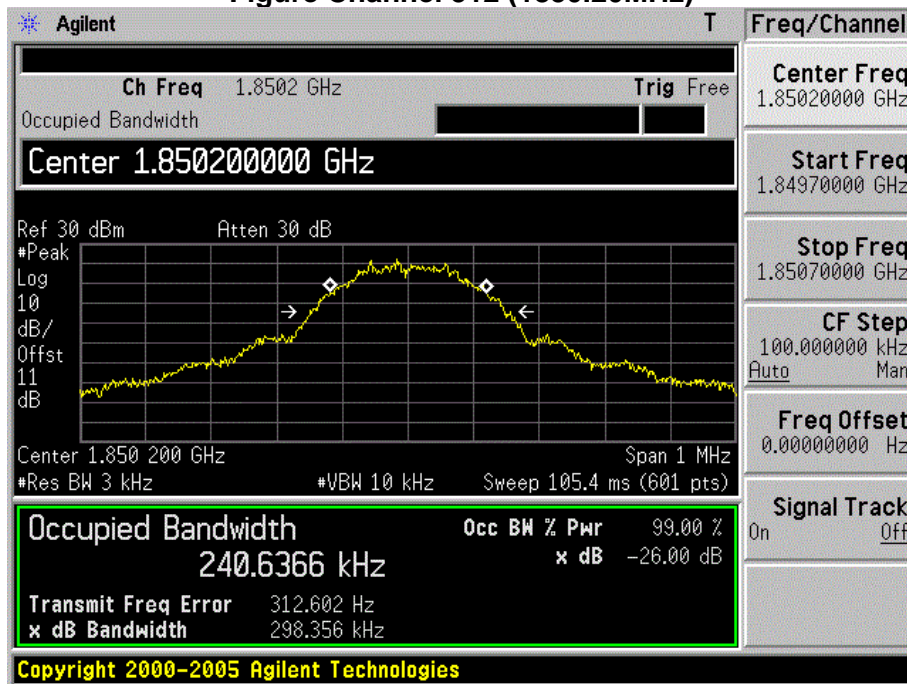

Figure Channel 661 (1880.00MHz)

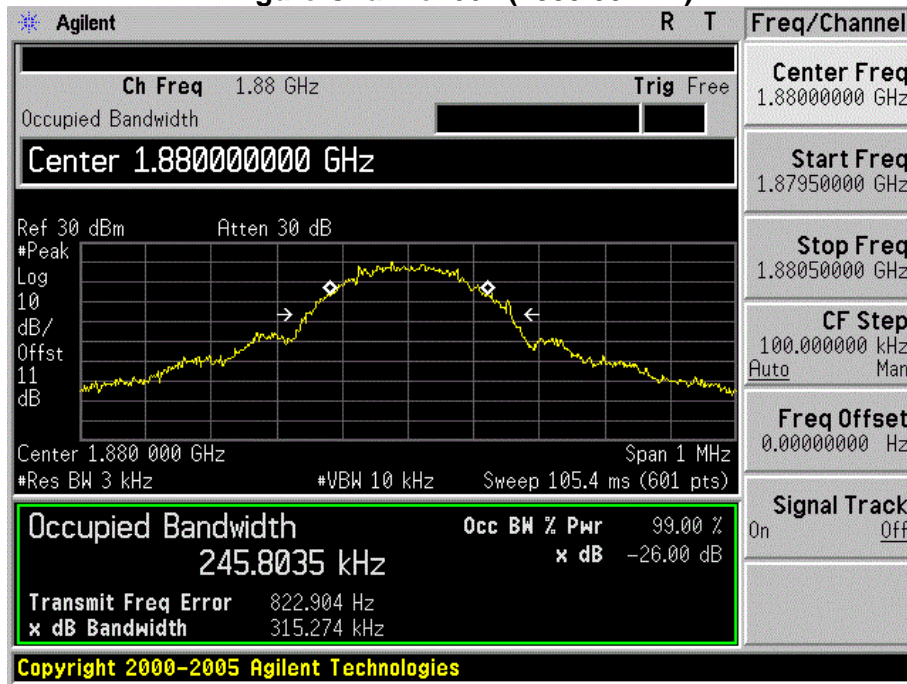
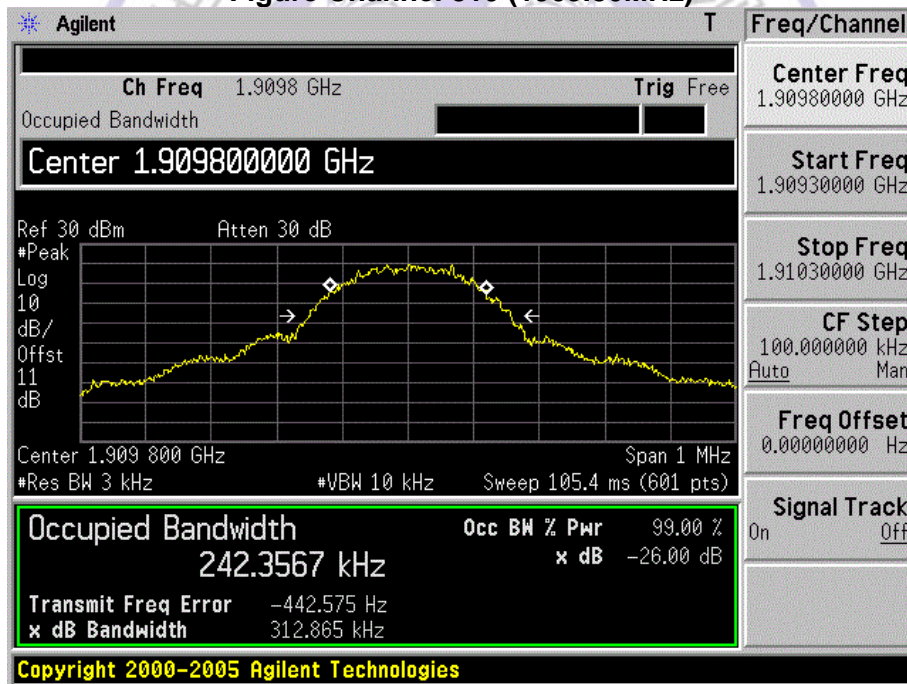

Figure Channel 810 (1909.80MHz)



Test Item	Occupied Bandwidth		
Test Mode	Mode 5: WCDMA Band II Link		
Date of Test	2014/09/10	Test Site	AC6

Channel No.	Frequency (MHz)	-26dB Occupied Bandwidth (kHz)	99% Occupied Bandwidth (kHz)
9262	1852.4	4689.0	4151.1
9400	1880.0	4661.0	4147.5
9538	1907.6	4677.0	4148.0

Figure Channel 9262 (1852.40MHz)

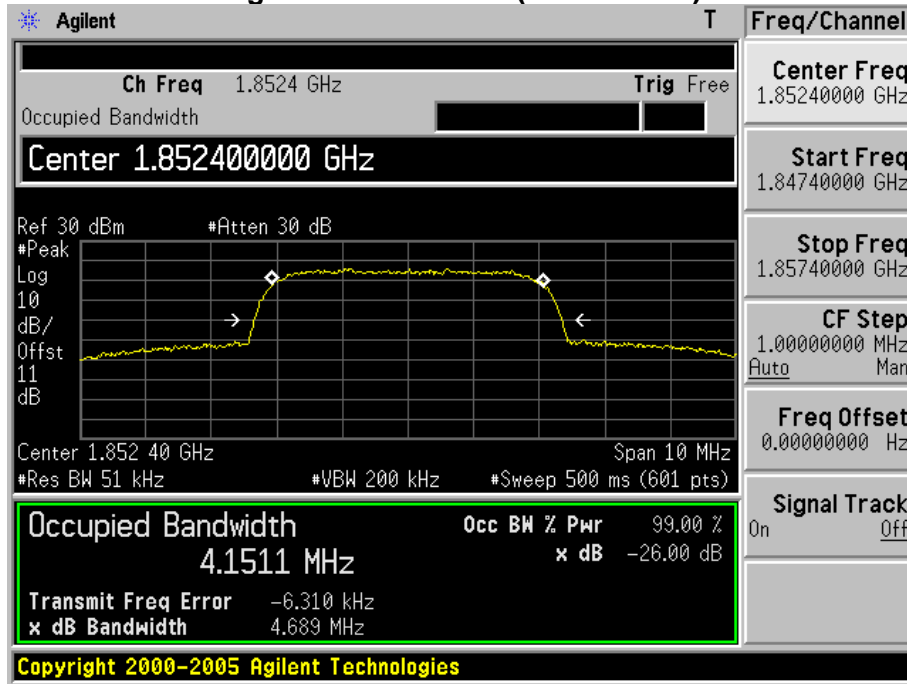

Figure Channel 9400 (1880.0MHz)

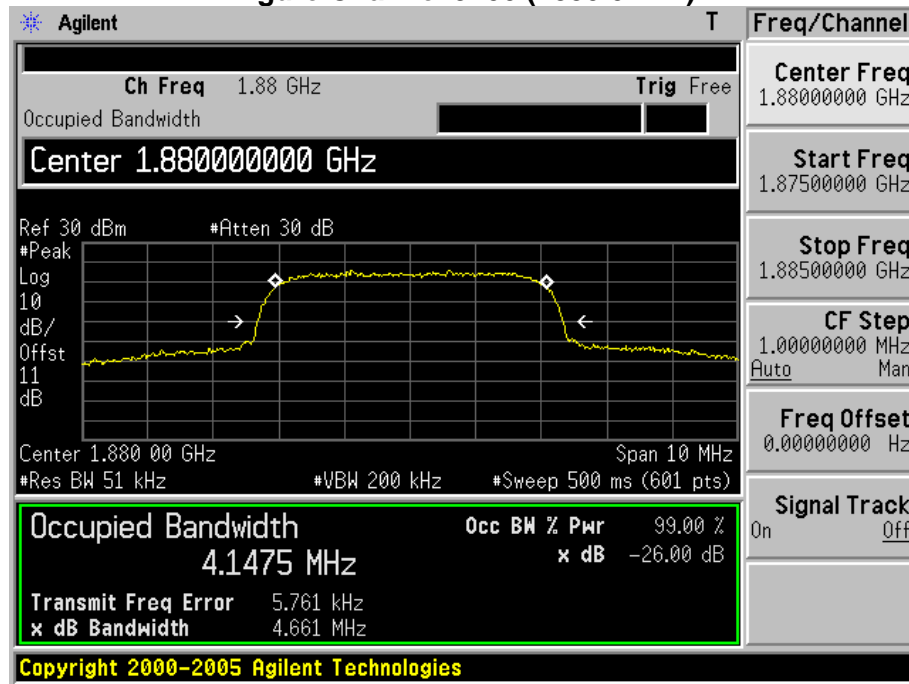
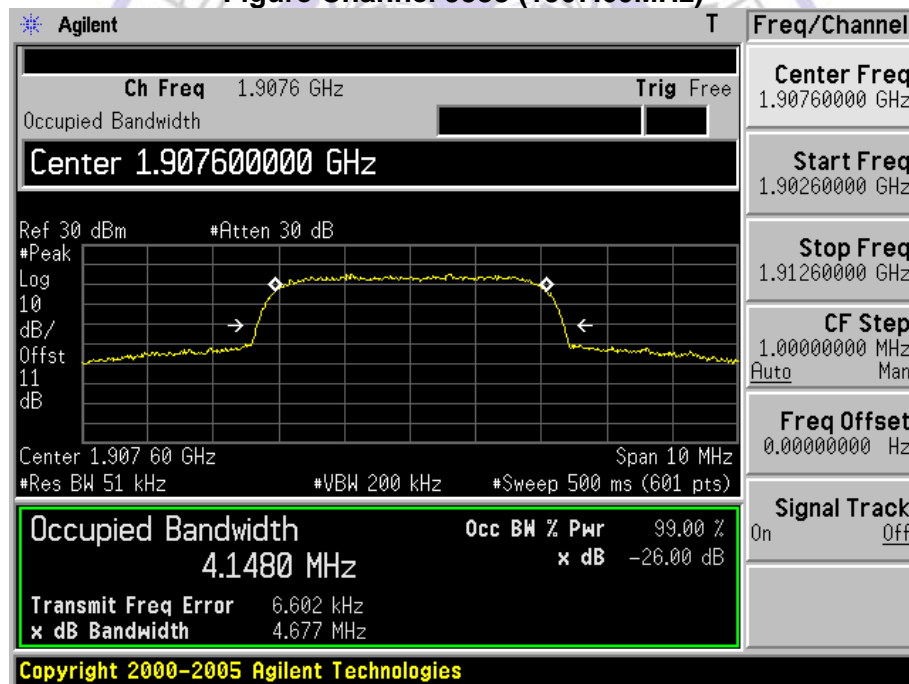

Figure Channel 9538 (1907.60MHz)



Test Item	Occupied Bandwidth		
Test Mode	Mode 6: WCDMA Band V Link		
Date of Test	2014/09/10	Test Site	AC6

Channel No.	Frequency (MHz)	-26dB Occupied Bandwidth (kHz)	99% Occupied Bandwidth (kHz)
4132	826.4	4670.0	4151.5
4182	836.4	4660.0	4142.8
4233	846.6	4657.0	4146.8

Figure Channel 4132 (826.40MHz)

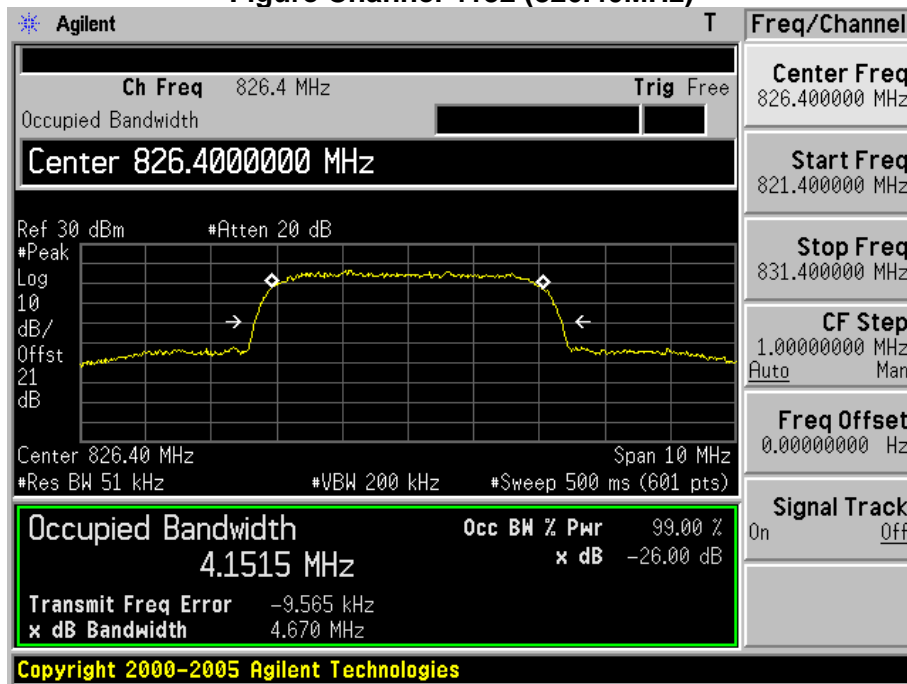

Figure Channel 4182 (836.40MHz)

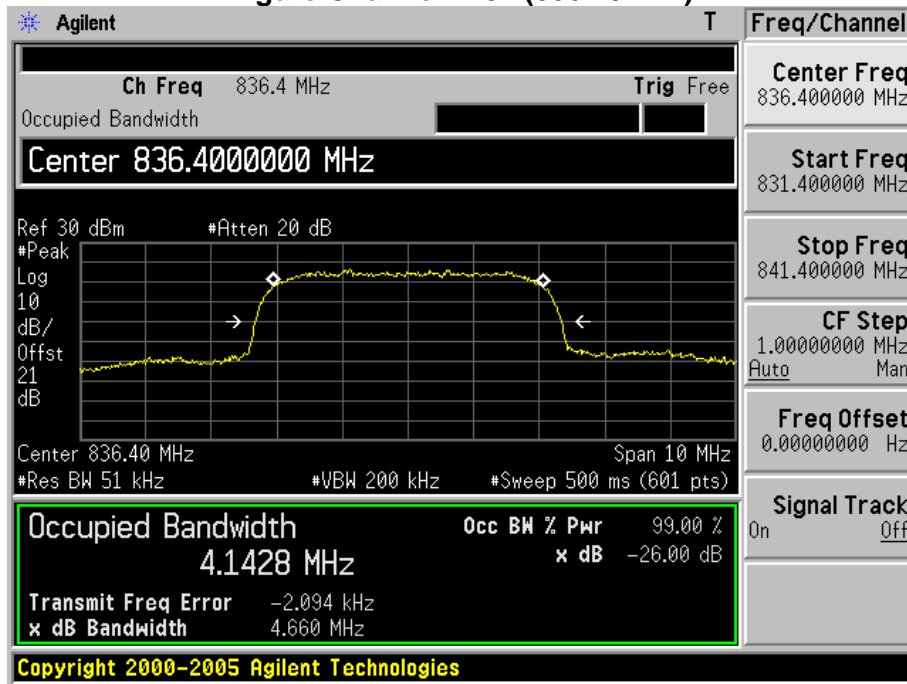
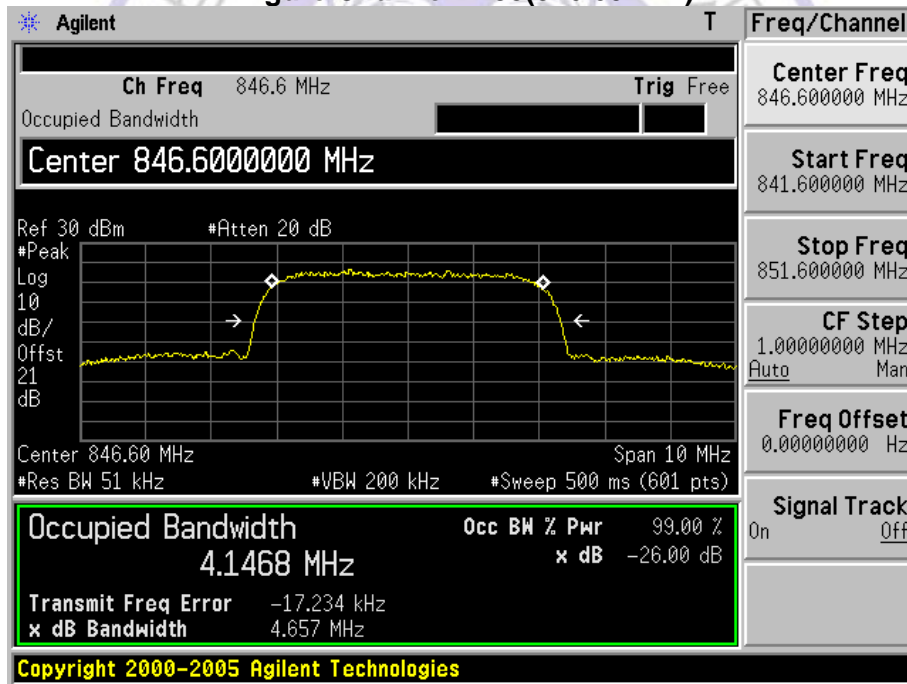
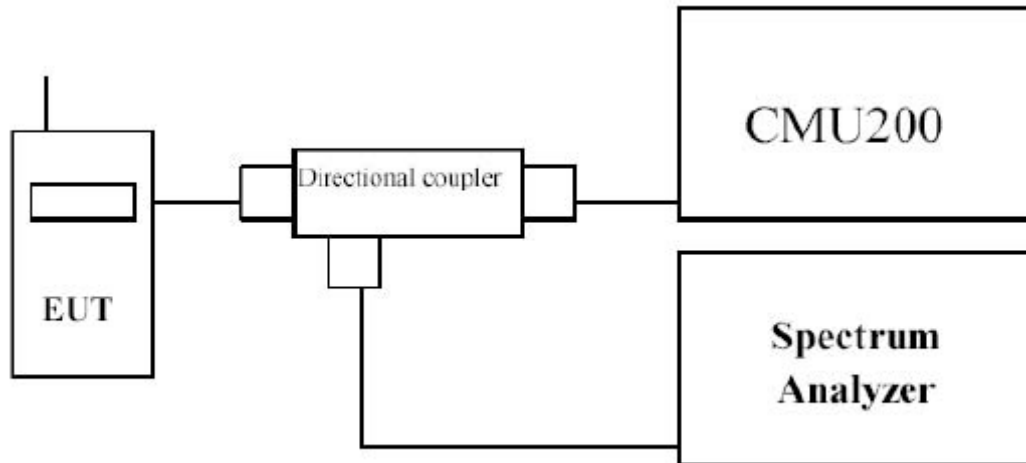

Figure Channel 4233(846.60MHz)



#### 4.4. Spurious Emission At Antenna Terminals (+/- 1MHz)

##### TEST CONFIGURATION



##### TEST PROCEDURE

In the 1MHz bands immediately outside and adjacent to the frequency block a resolution bandwidth of at least one percent of the emission bandwidth of the fundamental emission of the transmitter may be employed to measure the out of band Emissions.

##### LIMIT

The power of any emission outside of the authorized operating frequency ranges must be attenuated below the transmitting power (P) by a factor of at least  $43 + 10\log(P)$  dB.

##### TEST RESULTS

See next pages.

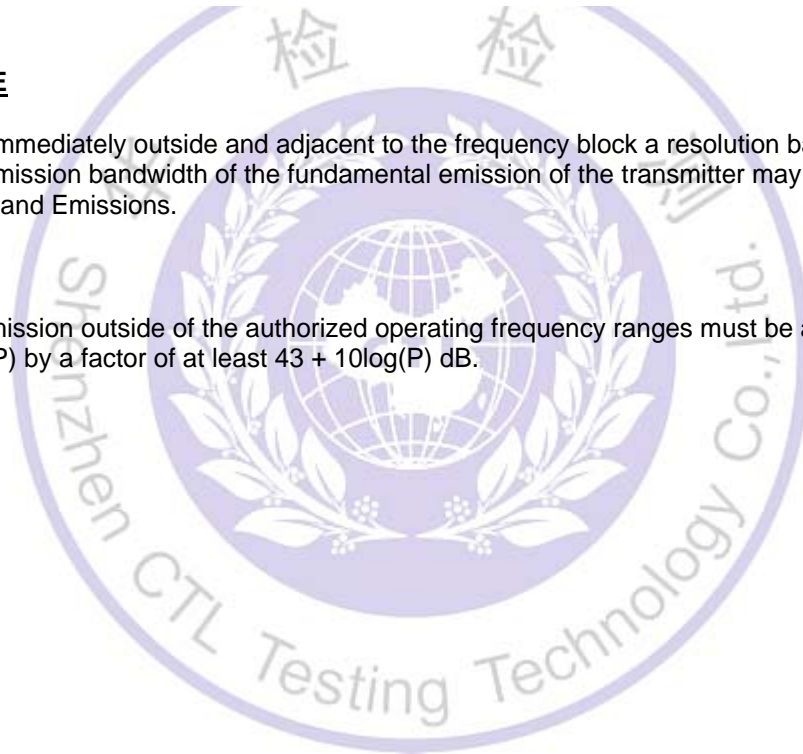



Test Item	Spurious Emission At Antenna Terminals (+/- 1MHz)		
Test Mode	Mode 1: GSM 850 Link		
Date of Test	2014/09/10	Test Site	AC6

Figure Channel 128 (824.20MHz)

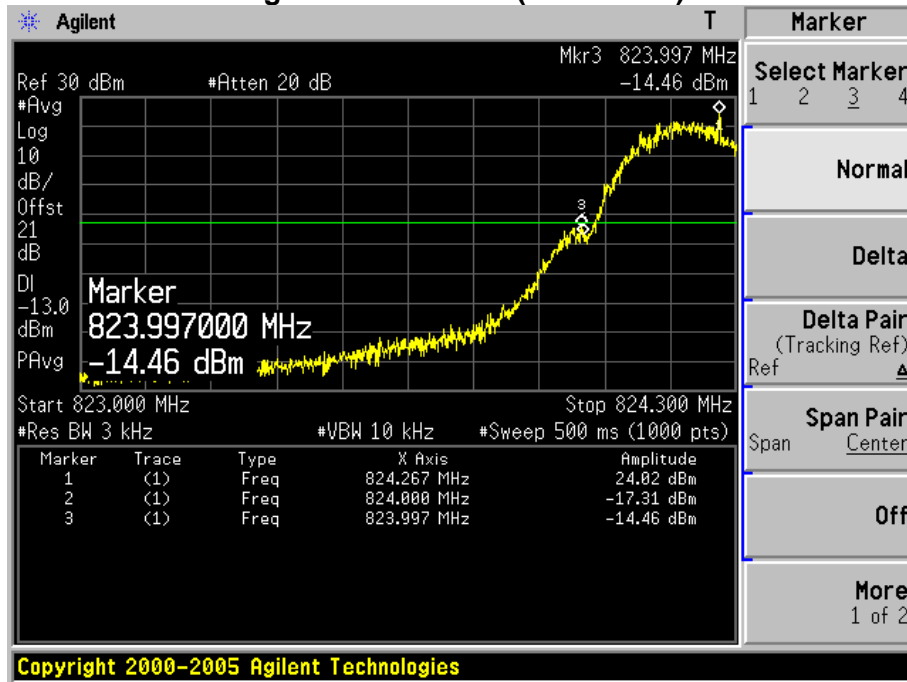
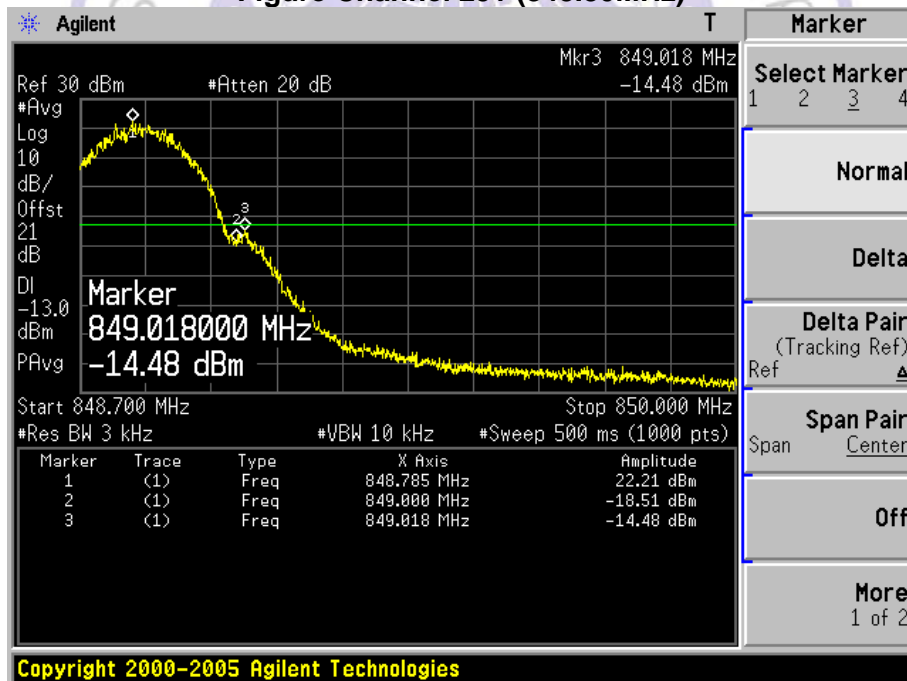

Figure Channel 251 (848.80MHz)



Test Item	Spurious Emission At Antenna Terminals (+/- 1MHz)		
Test Mode	Mode 2: GSM1900 Link		
Date of Test	2014/09/10	Test Site	AC6

Figure Channel 512 (1850.20MHz)

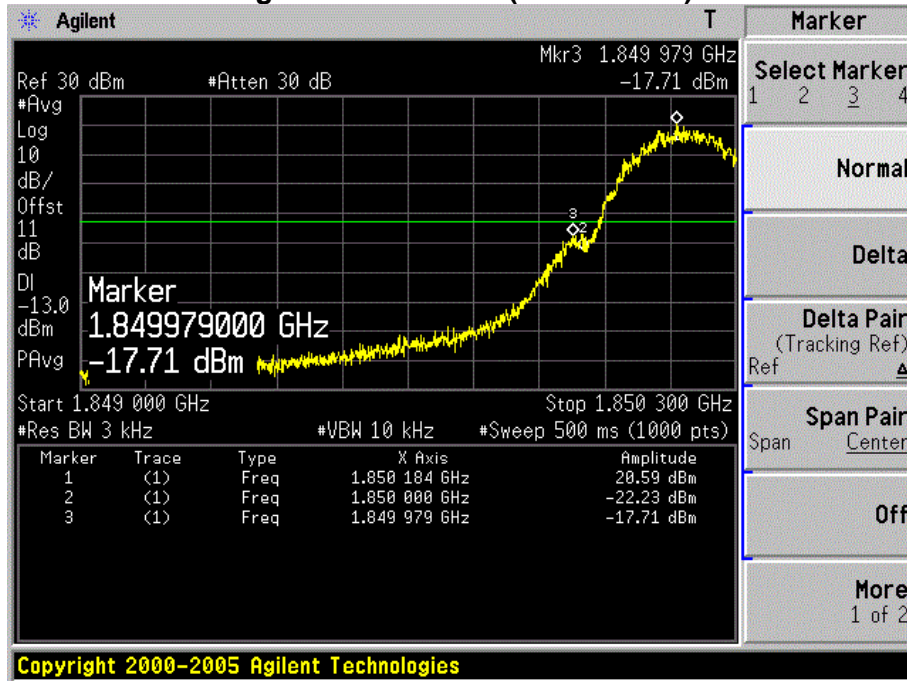
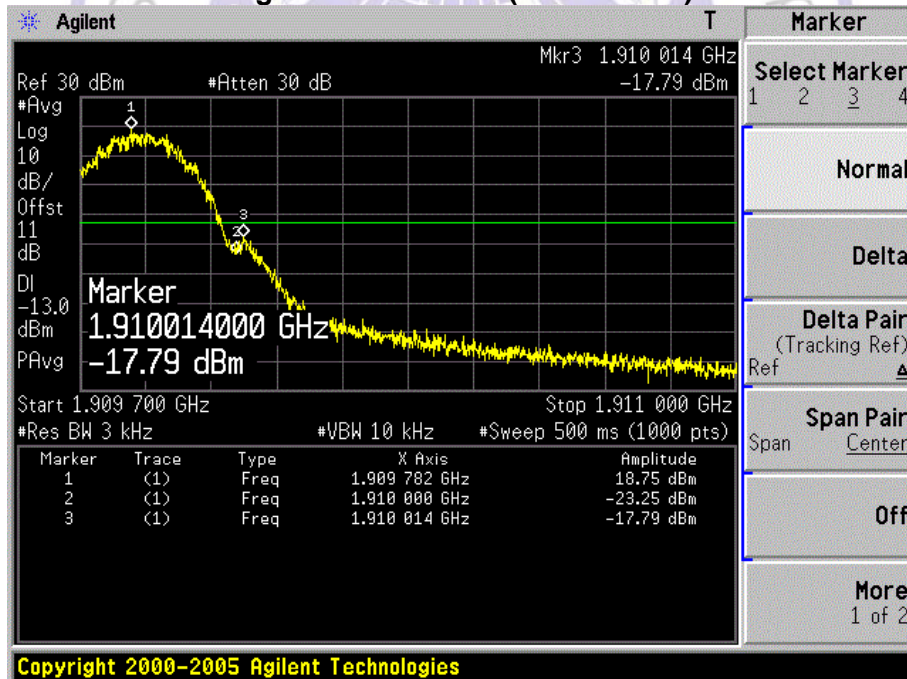

Figure Channel 810 (1909.80MHz)



Test Item	Spurious Emission At Antenna Terminals (+/- 1MHz)		
Test Mode	Mode 3: EDGE 850 Link		
Date of Test	2014/09/10	Test Site	AC6

Figure Channel 128 (824.20MHz)

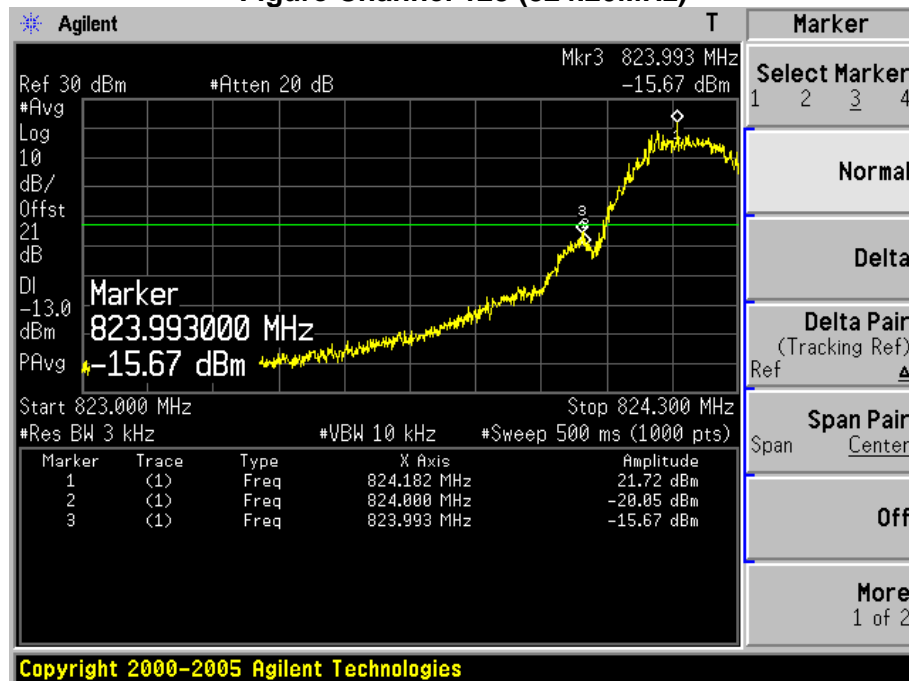
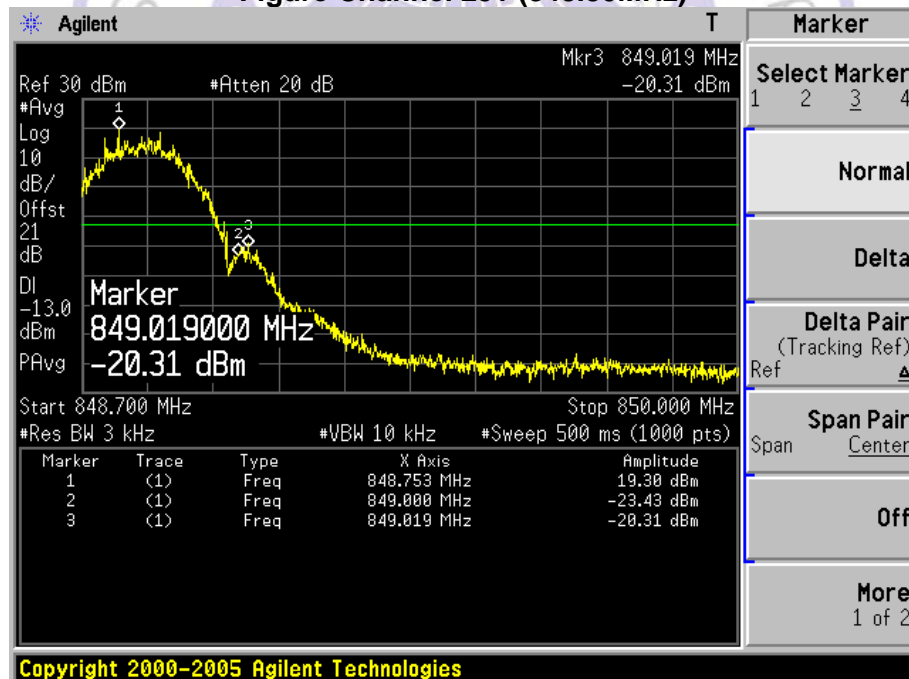

Figure Channel 251 (848.80MHz)



Test Item	Spurious Emission At Antenna Terminals (+/- 1MHz)		
Test Mode	Mode 4: EDGE1900 Link		
Date of Test	2014/09/10	Test Site	AC6

Figure Channel 512 (1850.20MHz)

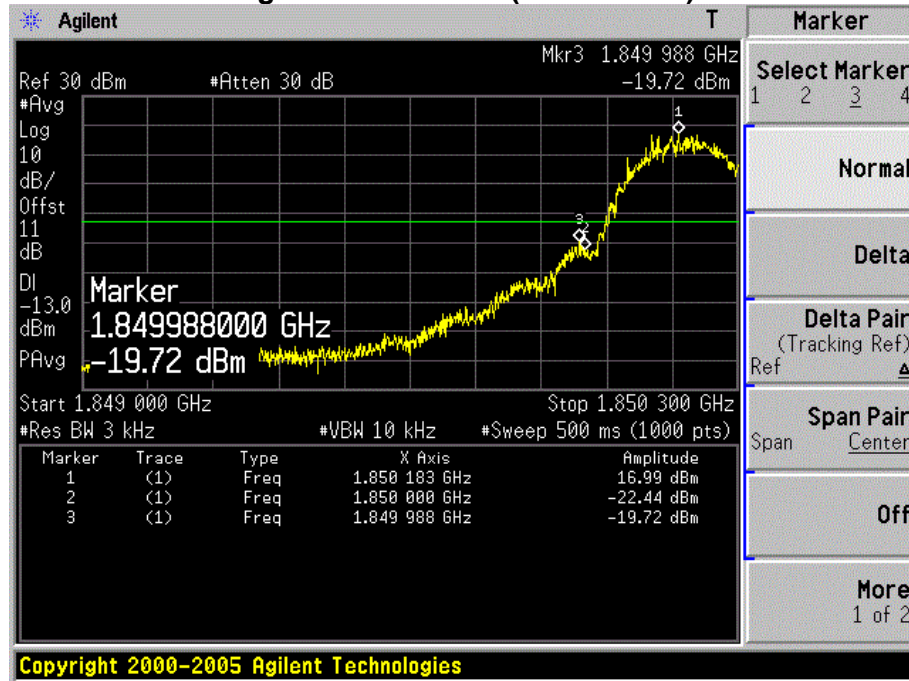
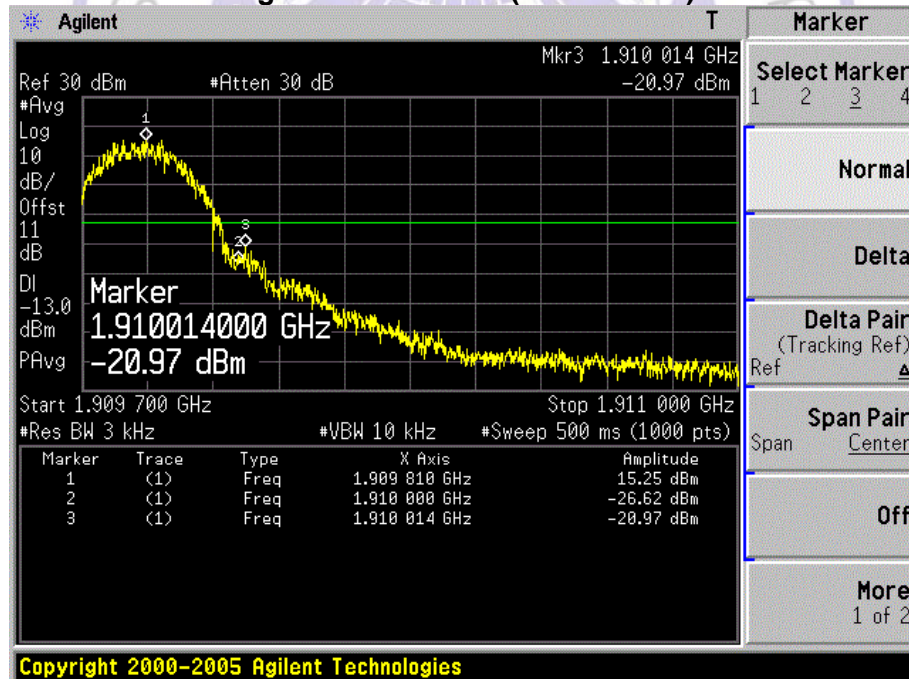

Figure Channel 810 (1909.80MHz)



Test Item	Spurious Emission At Antenna Terminals (+/- 1MHz)		
Test Mode	Mode 5: WCDMA Band II Link		
Date of Test	2014/09/10	Test Site	AC6

Figure Channel 9262 (1852.40MHz)

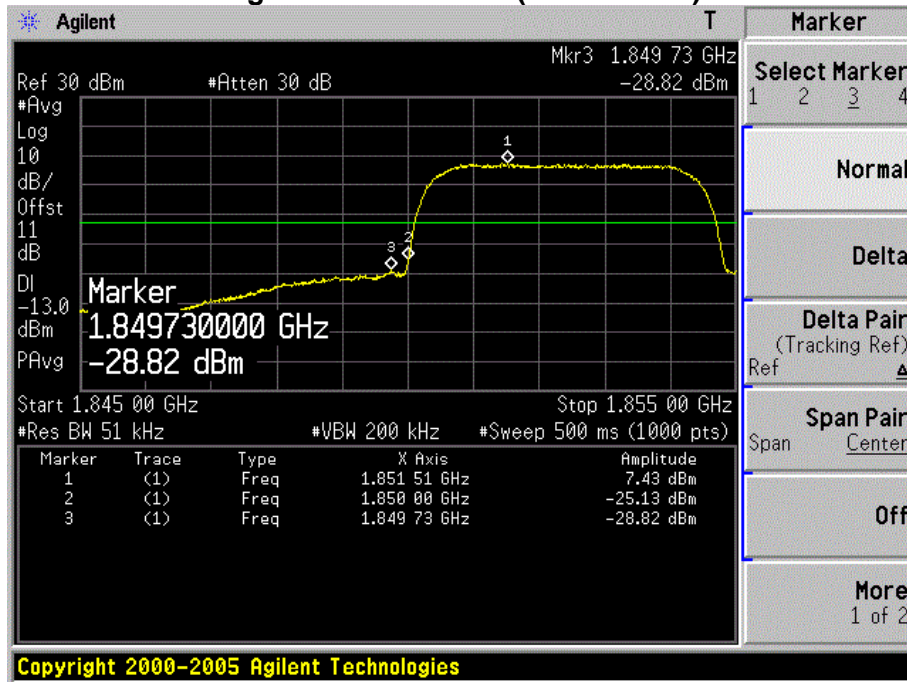
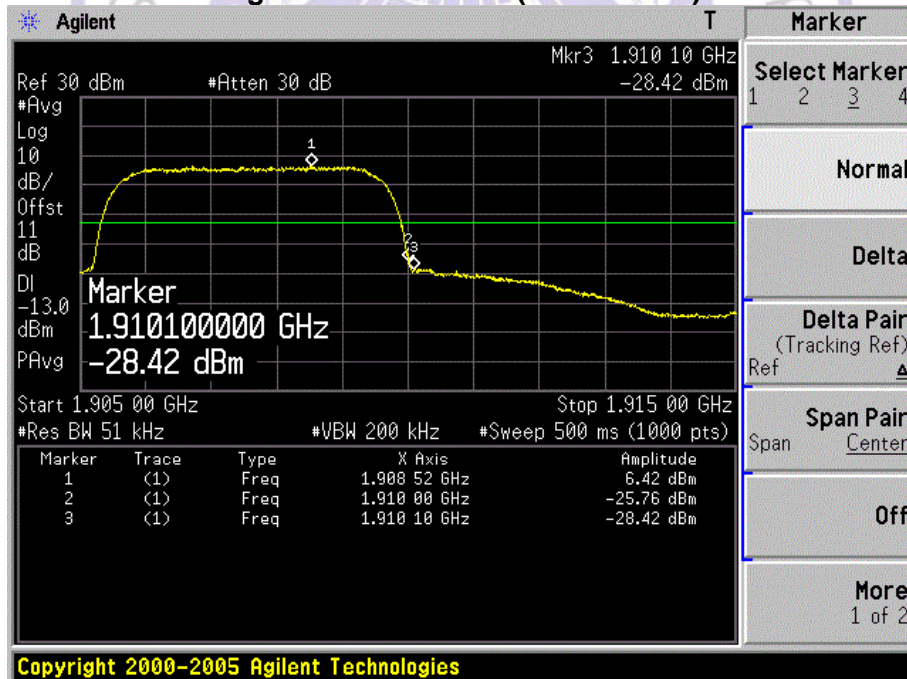

Figure Channel 9538 (1907.60MHz)



Test Item	Spurious Emission At Antenna Terminals (+/- 1MHz)		
Test Mode	Mode 6: WCDMA Band V Link		
Date of Test	2014/09/10	Test Site	AC6

Figure Channel 4132 (826.40MHz)

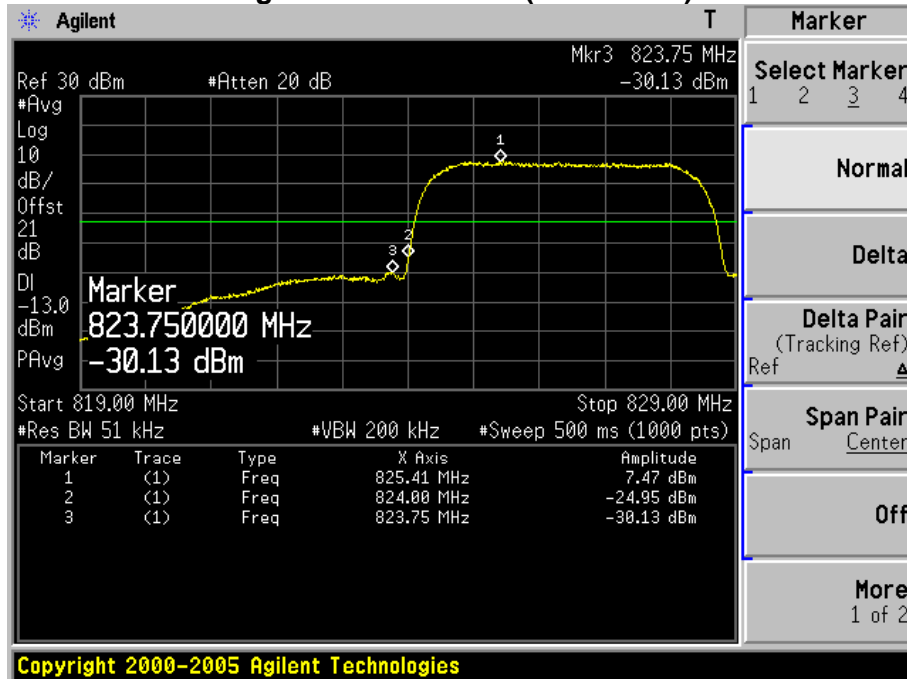
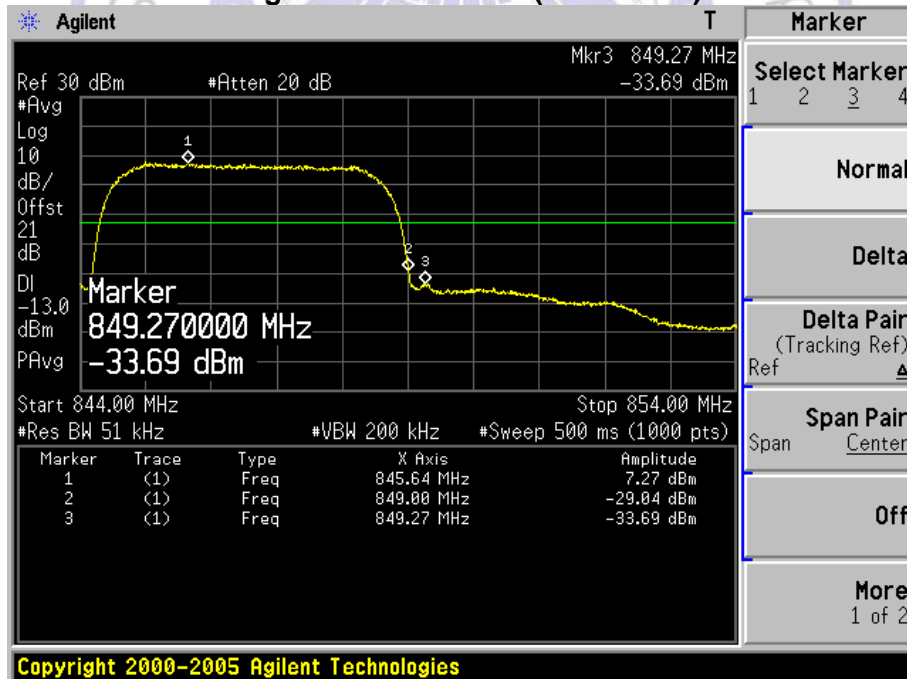

Figure Channel 4233 (846.60MHz)



## 4.5. Spurious Emission

### TEST CONFIGURATION

Conducted Spurious Measurement:

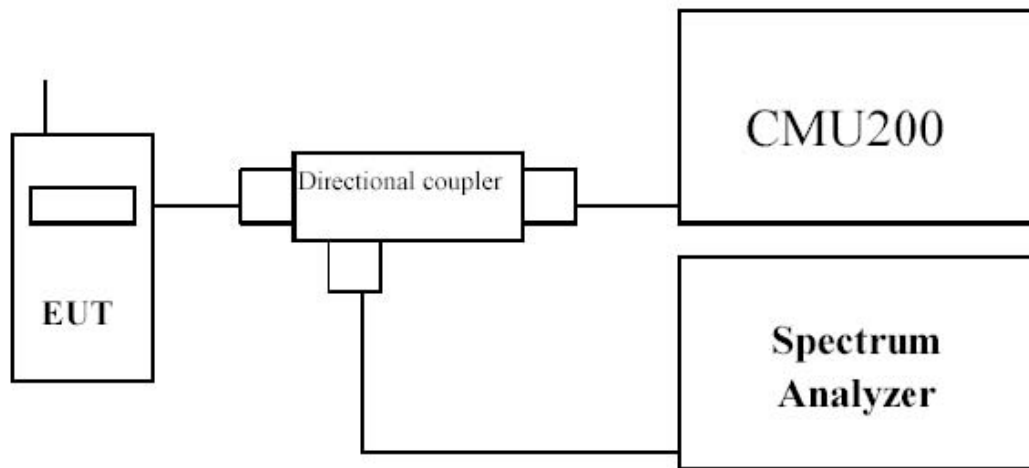

Radiated Spurious Measurement:

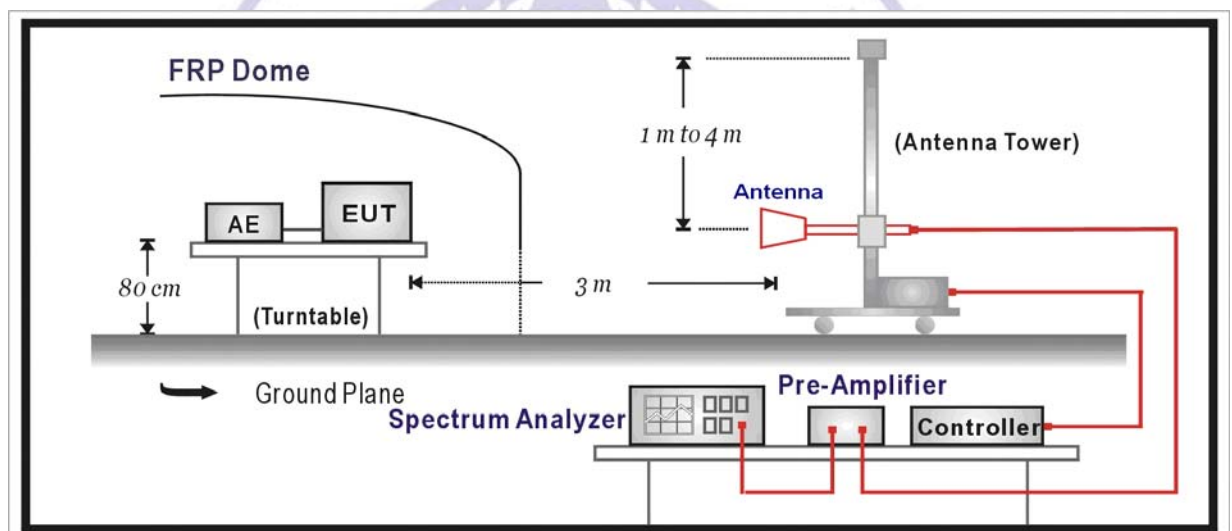

### TEST PROCEDURE

The EUT was setup according to EIA/TIA 603C

#### **Conducted Spurious Measurement:**

- Place the EUT on a bench and set it in transmitting mode.
- Connect a low loss RF cable from the antenna port to a spectrum analyzer and CMU200 by a Directional Couple.
- EUT Communicate with CMU200, then select a channel for testing.
- Add a correction factor to the display of spectrum, and then test.
- The resolution bandwidth of the spectrum analyzer was set at 100 kHz for Part 22 and 1MHz for Part 24 and 27, sufficient scans were taken to show the out of band Emission if any up to 10th harmonic.

**Radiated Spurious Measurement:**

- a) The EUT shall be placed at the specified height on a support, and in the position closest to normal use as declared by provider.
- b) The test antenna shall be oriented initially for vertical polarization and shall be chosen to correspond to the frequency of the transmitter
- c) The output of the test antenna shall be connected to the measuring receiver.
- d) The transmitter shall be switched on and the measuring receiver shall be tuned to the frequency of the transmitter under test.
- e) The test antenna shall be raised and lowered through the specified range of height until a maximum signal level is detected by the measuring receiver.
- f) The transmitter shall then be rotated through  $360^\circ$  in the horizontal plane, until the maximum signal level is detected by the measuring receiver.
- g) The test antenna shall be raised and lowered again through the specified range of height until a maximum signal level is detected by the measuring receiver.
- q) The maximum signal level detected by the measuring receiver shall be noted.
- h) The transmitter shall be replaced by a substitution antenna.
- i) The substitution antenna shall be orientated for vertical polarization and the length of the substitution antenna shall be adjusted to correspond to the frequency of the transmitter.
- j) The substitution antenna shall be connected to a calibrated signal generator.
- k) If necessary, the input attenuator setting of the measuring receiver shall be adjusted in order to increase the sensitivity of the measuring receiver.
- l) The test antenna shall be raised and lowered through the specified range of height to ensure that the maximum signal is received.
- m) The input signal to the substitution antenna shall be adjusted to the level that produces a level detected by the measuring receiver, that is equal to the level noted while the transmitter radiated power was measured, corrected for the change of input attenuator setting of the measuring receiver.
- n) The measurement shall be repeated with the test antenna and the substitution antenna orientated for horizontal polarization.
- o) The measure of the effective radiated power is the larger of the two levels recorded at the input to the substitution antenna, corrected for gain of the substitution antenna if necessary.
- p) The resolution bandwidth of the spectrum analyzer was set at 100 kHz for Part 22 and 1MHz for Part 24 and 27. The frequency range was checked up to 10th harmonic.
- q) Test site anechoic chamber refer to ANSI C63.4: 2009

**LIMIT**

The power of any emission outside of the authorized operating frequency ranges must be attenuated below the transmitting power (P) by a factor of at least  $43 + 10\log(P)$  dB.

**TEST RESULTS**

See next pages.



Test Item	Conducted Spurious Emission		
Test Mode	Mode 1: GPRS 850 Link		
Date of Test	2014/09/10	Test Site	TR8

Low Channel 128(824.20MHz)

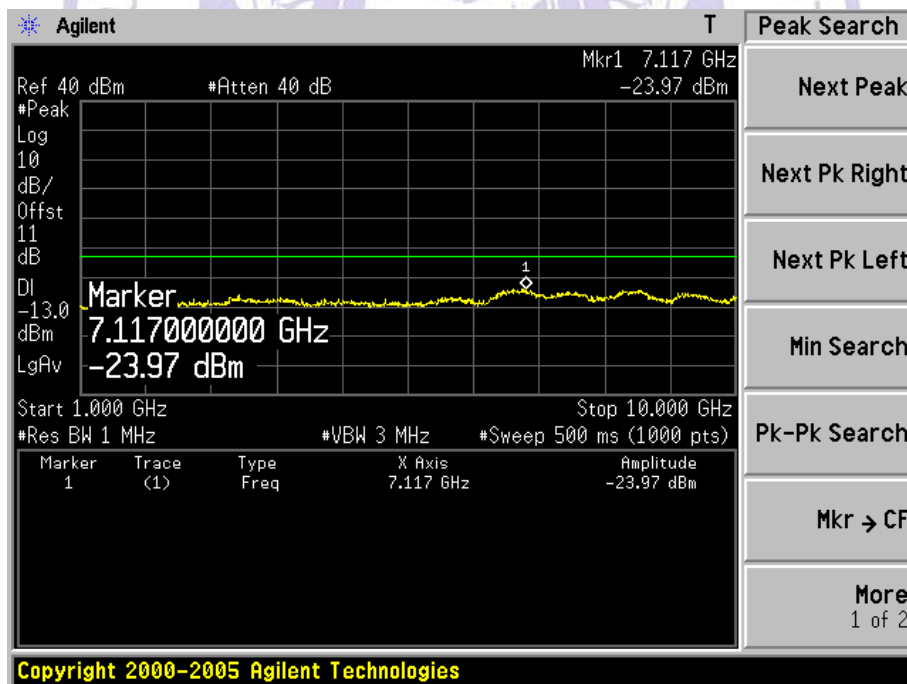
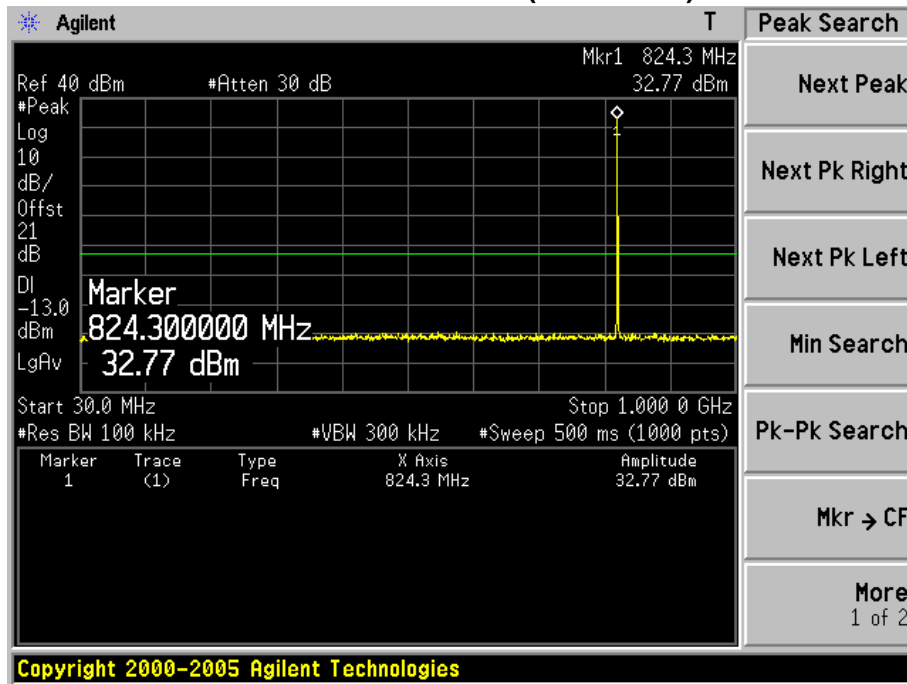

### Mid Channel 189(836.40MHz)

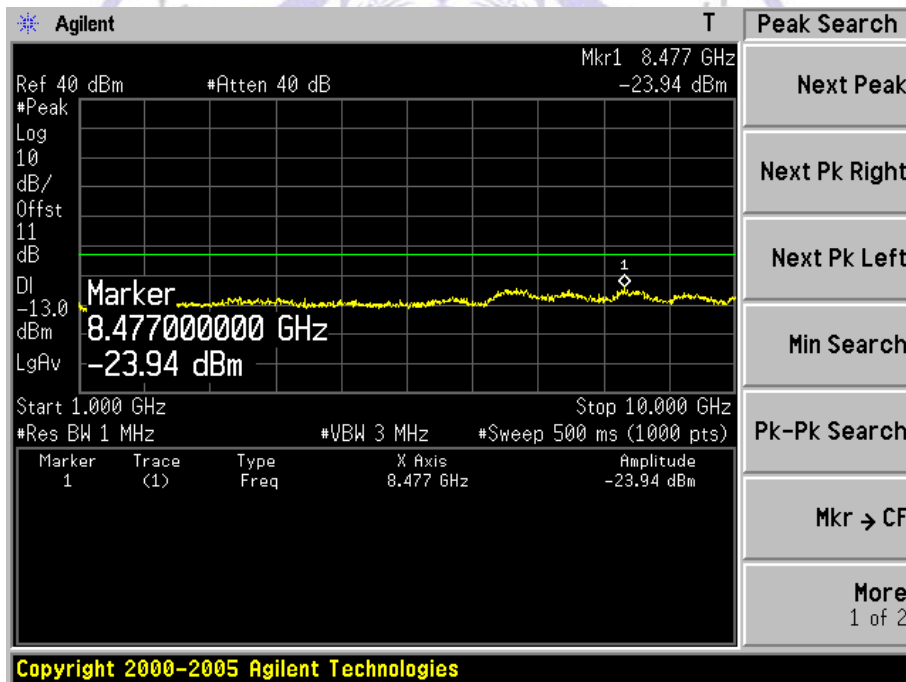
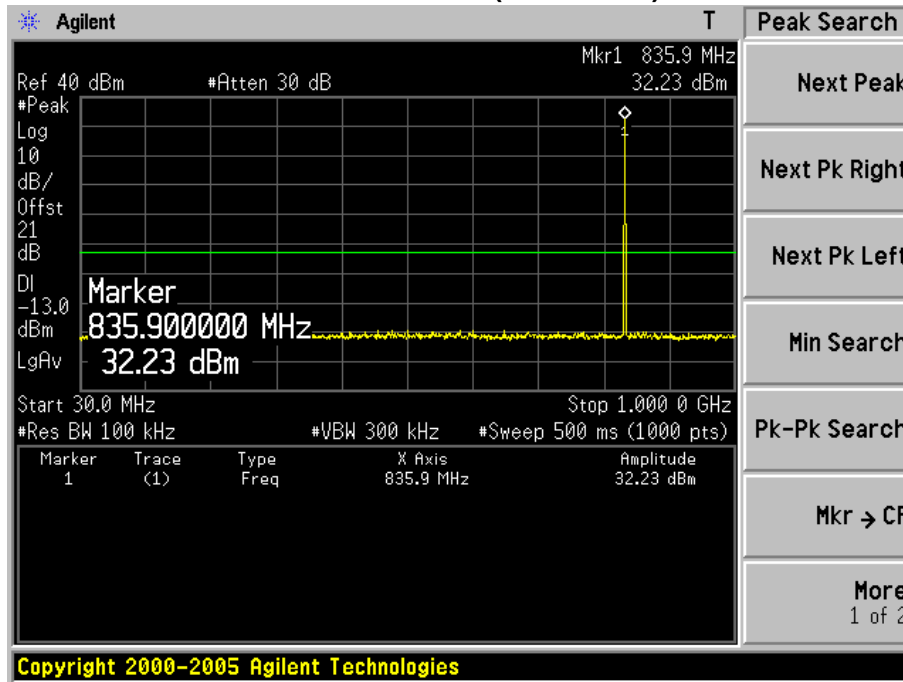

### High Channel 251(848.80MHz)

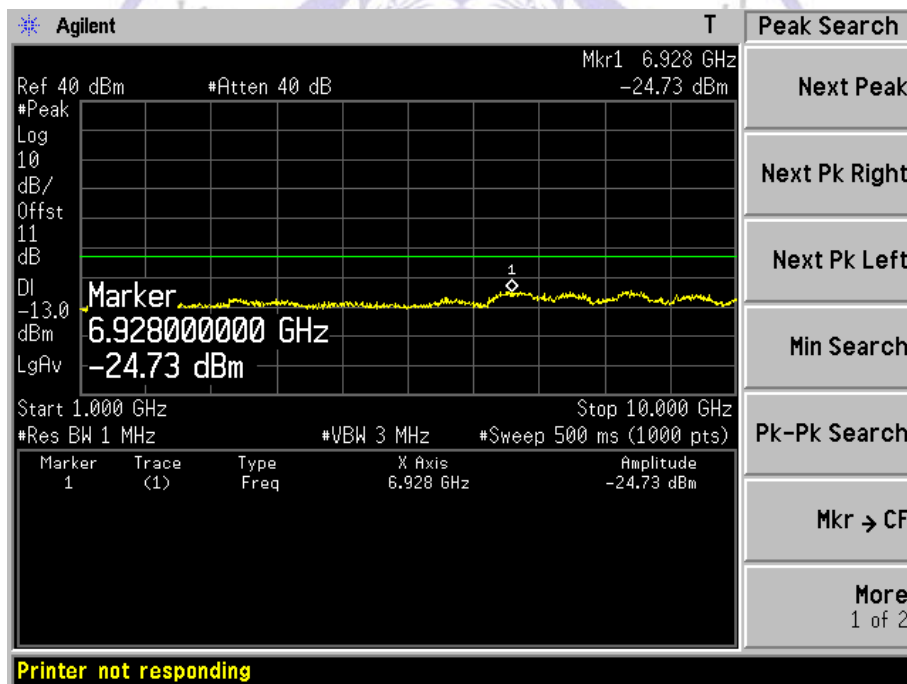
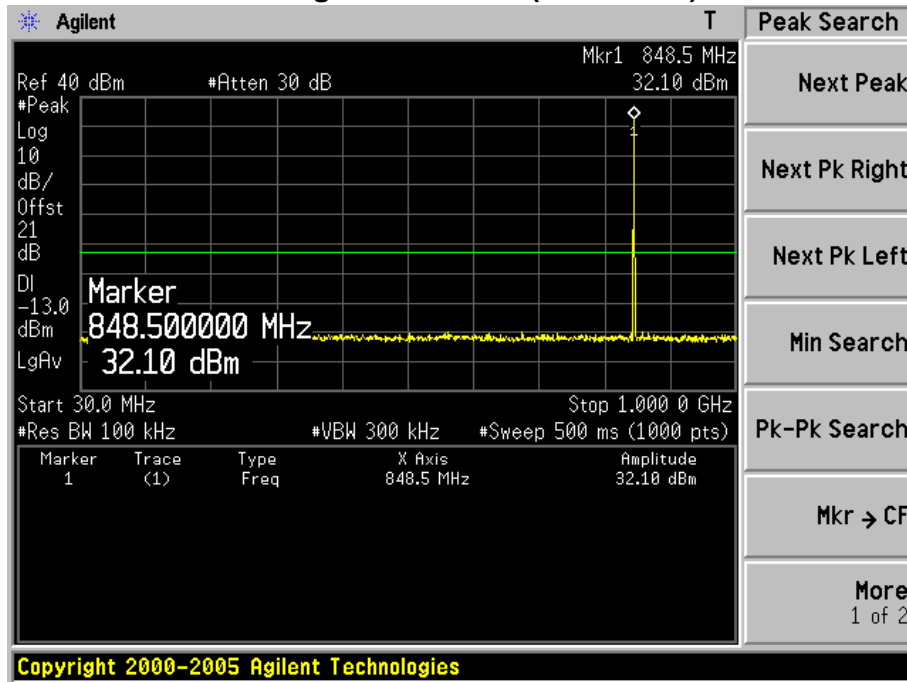

Test Item	Conducted Spurious Emission		
Test Mode	Mode 2: GSM1900 Link		
Date of Test	2014/09/10	Test Site	TR8

Low Channel 512(1850.20MHz)

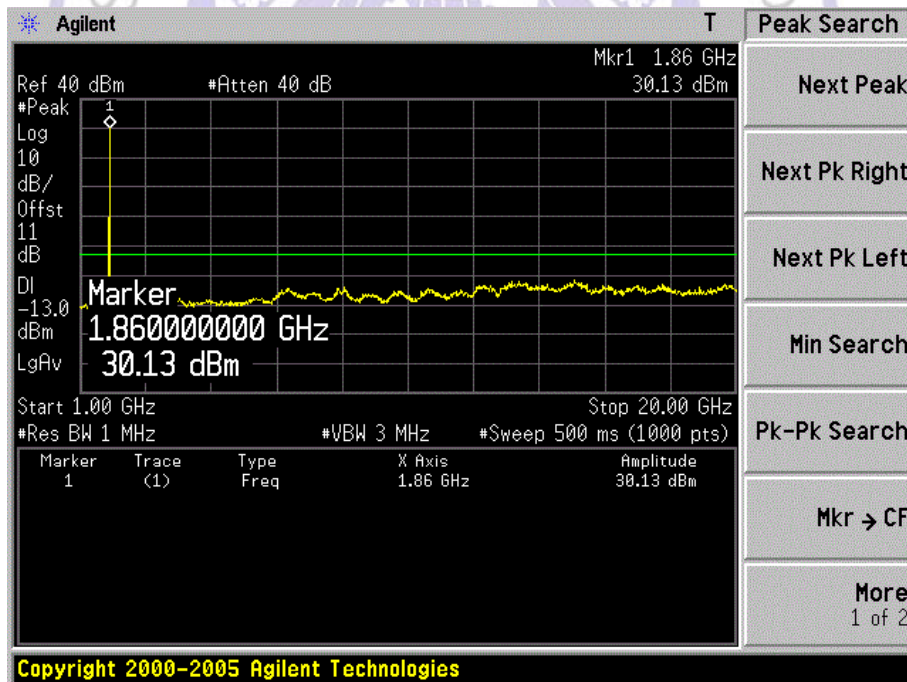
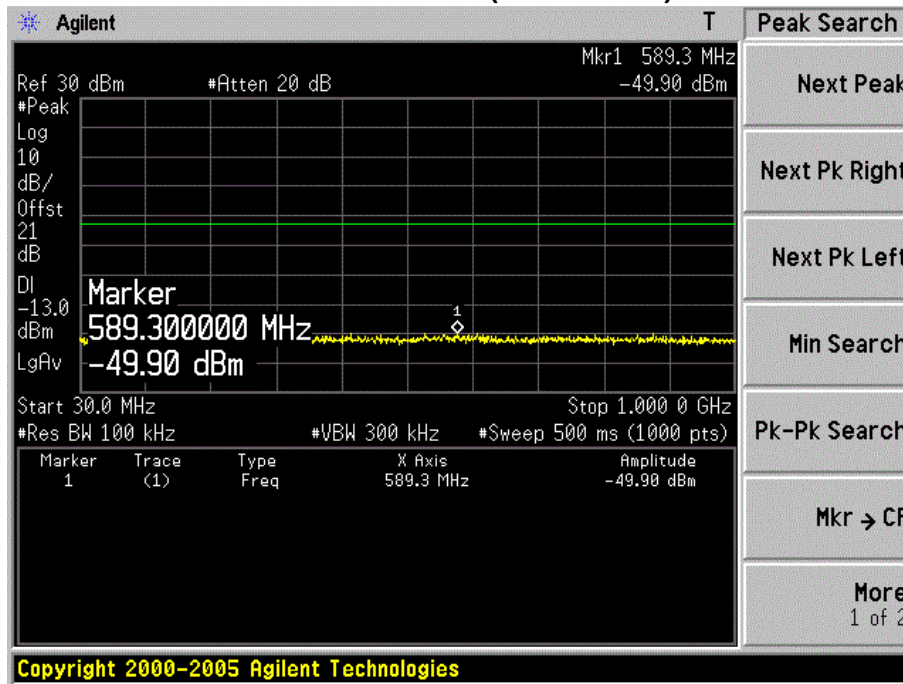

### Mid Channel 661(1880.00MHz)

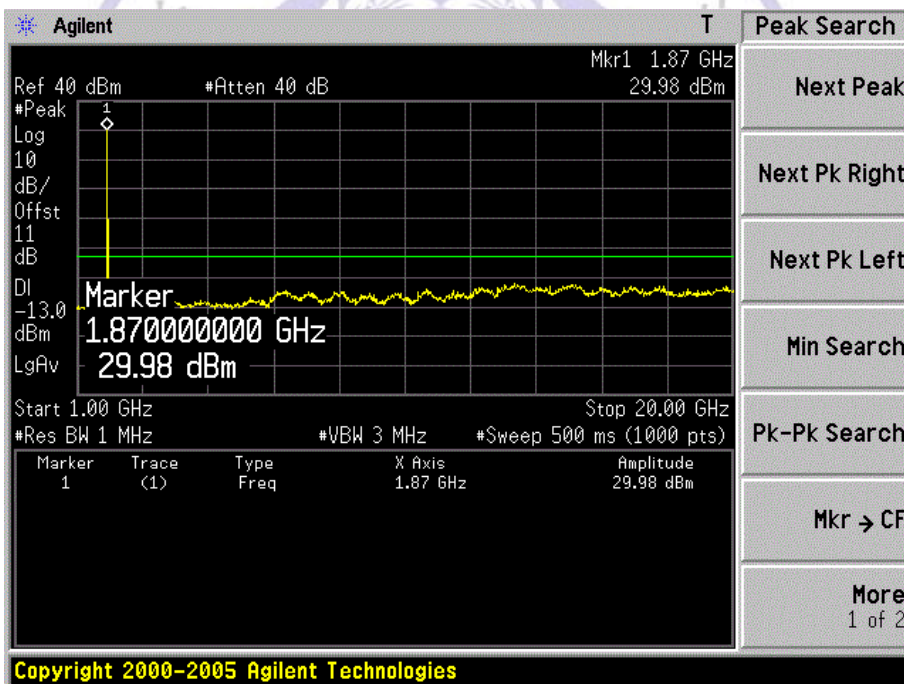
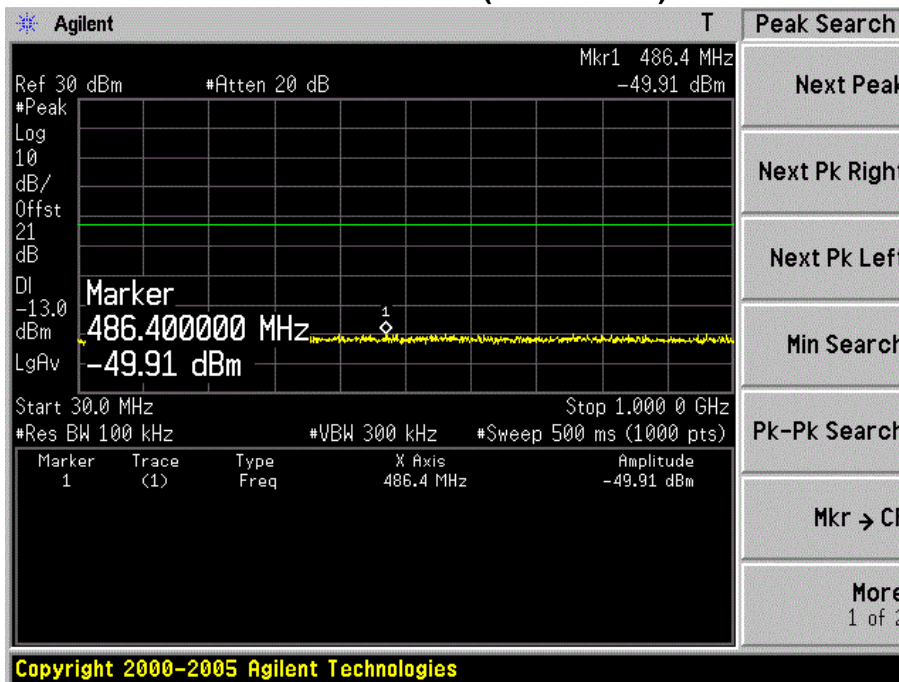

### High Channel 810(1909.80MHz)

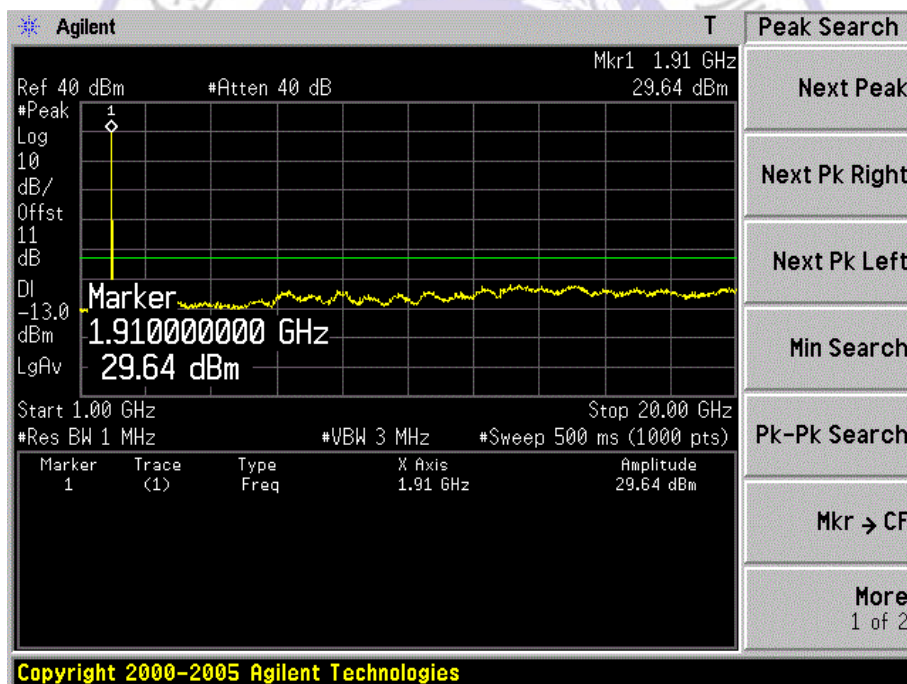
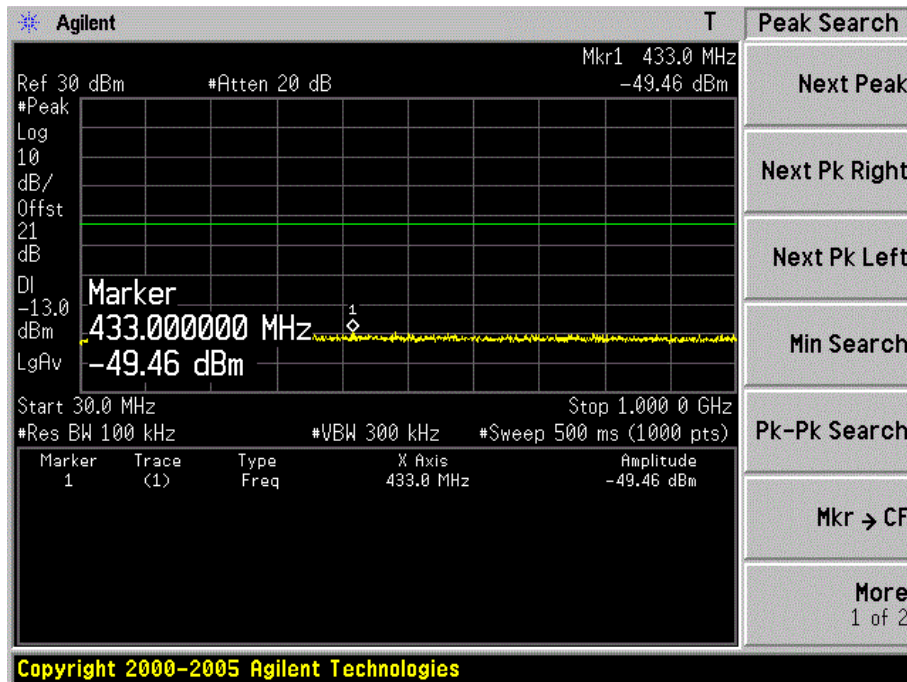

Test Item	Conducted Spurious Emission		
Test Mode	Mode 3: EDGE 850 Link		
Date of Test	2014/09/10	Test Site	TR8

Low Channel 128(824.20MHz)

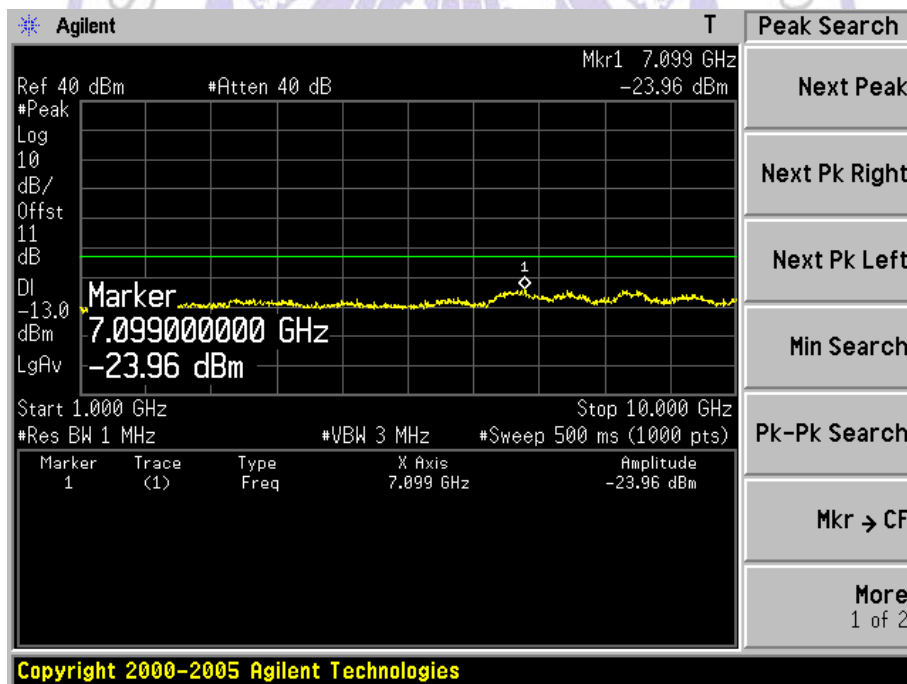
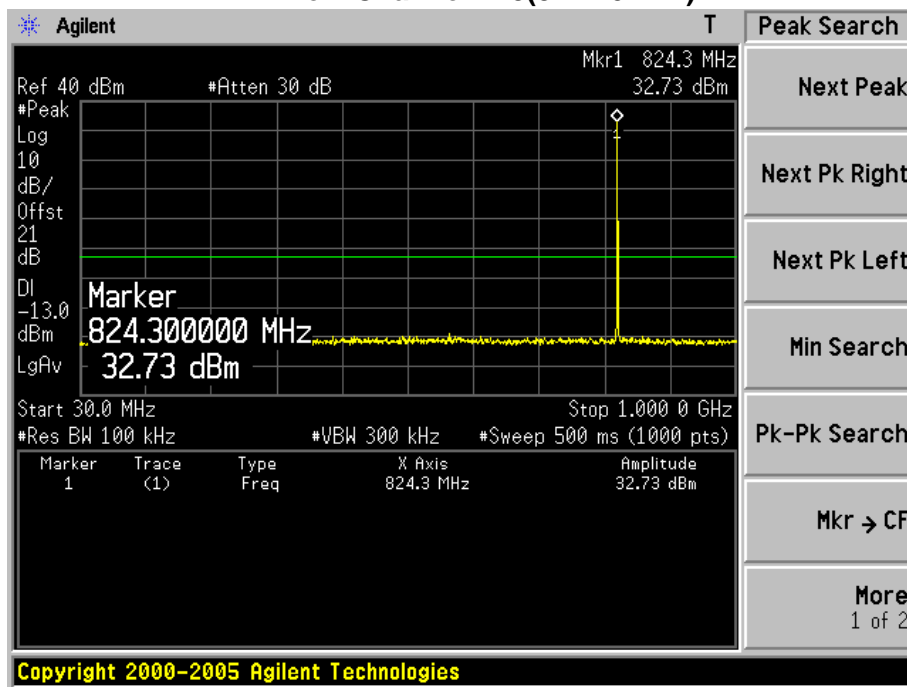

### Mid Channel 189(836.40MHz)

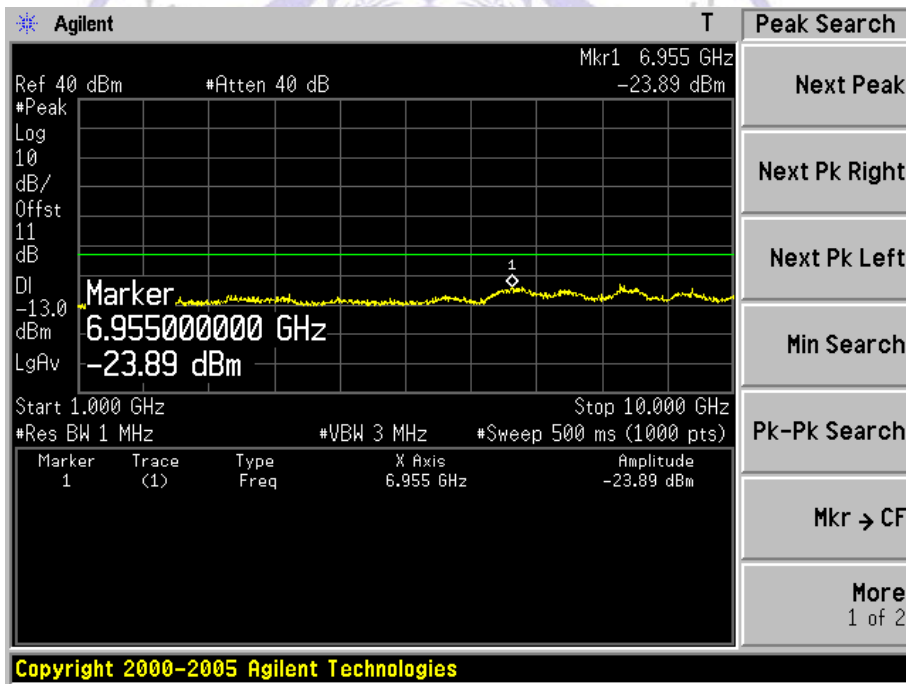
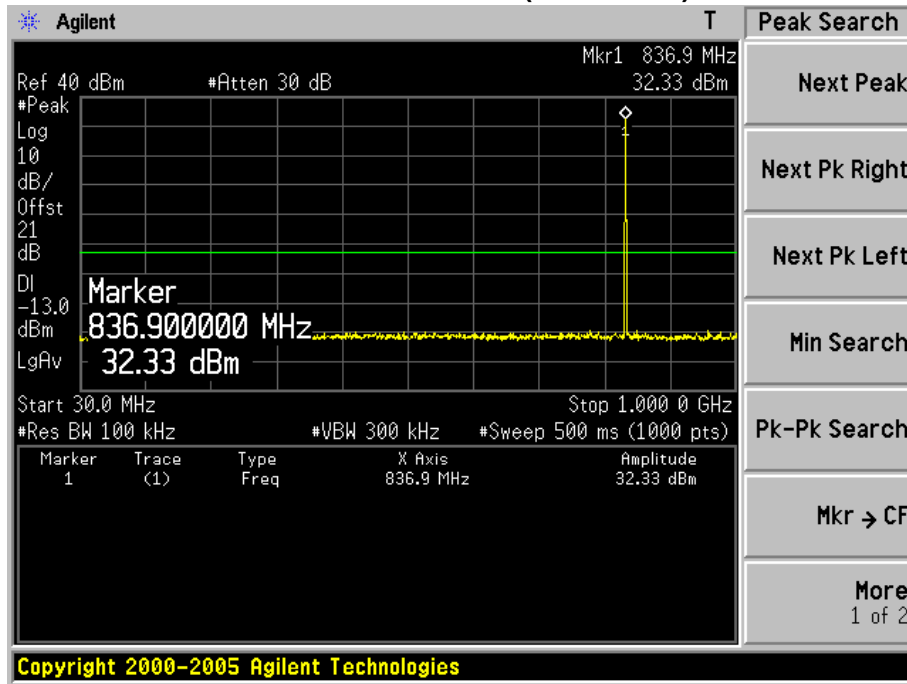



### High Channel 251(848.80MHz)

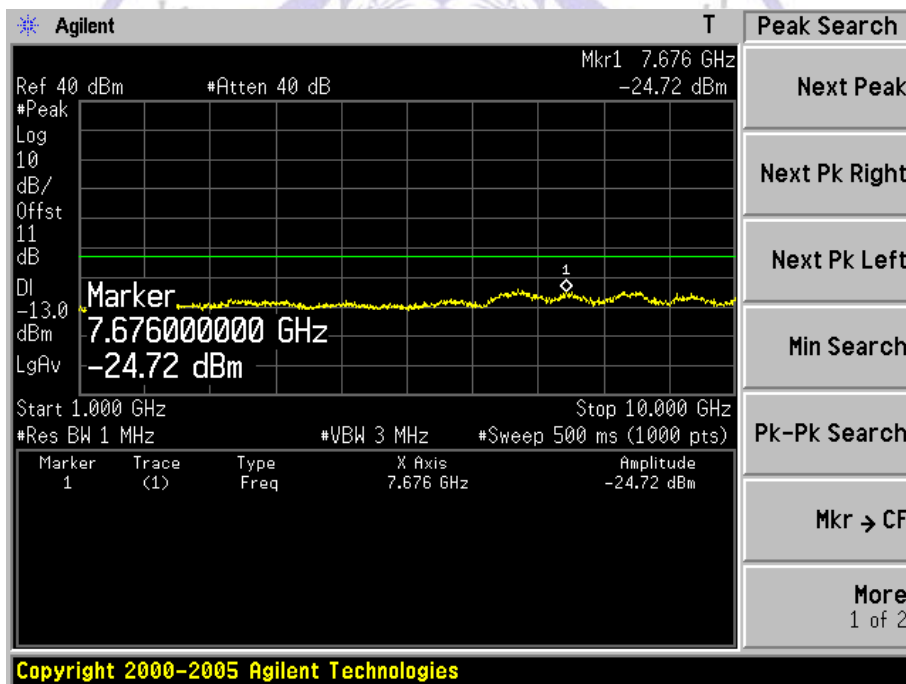
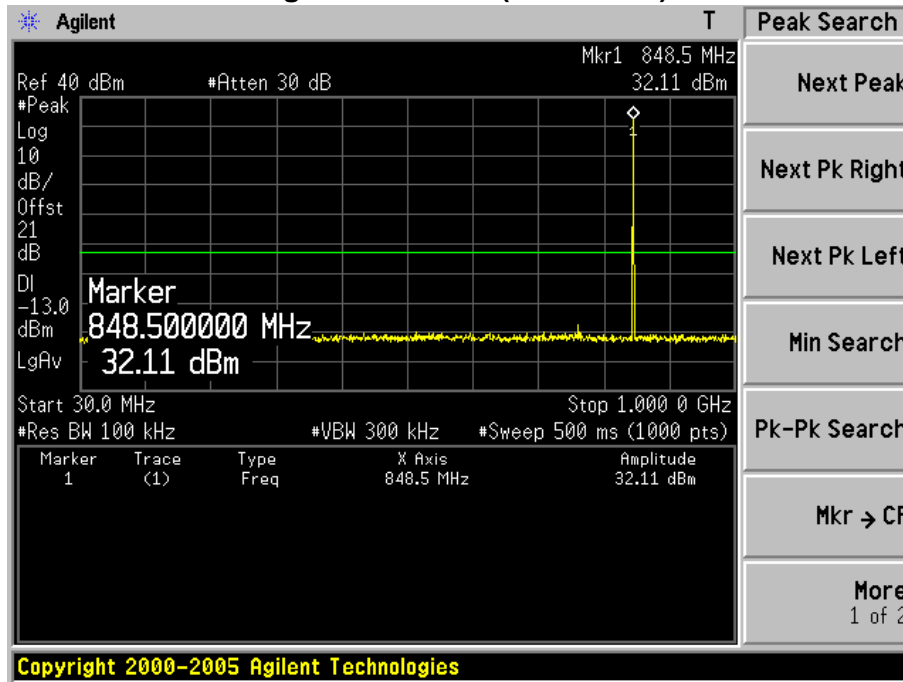

Test Item	Conducted Spurious Emission		
Test Mode	Mode 4: EDGE1900 Link		
Date of Test	2014/09/10	Test Site	TR8

Low Channel 512(1850.20MHz)

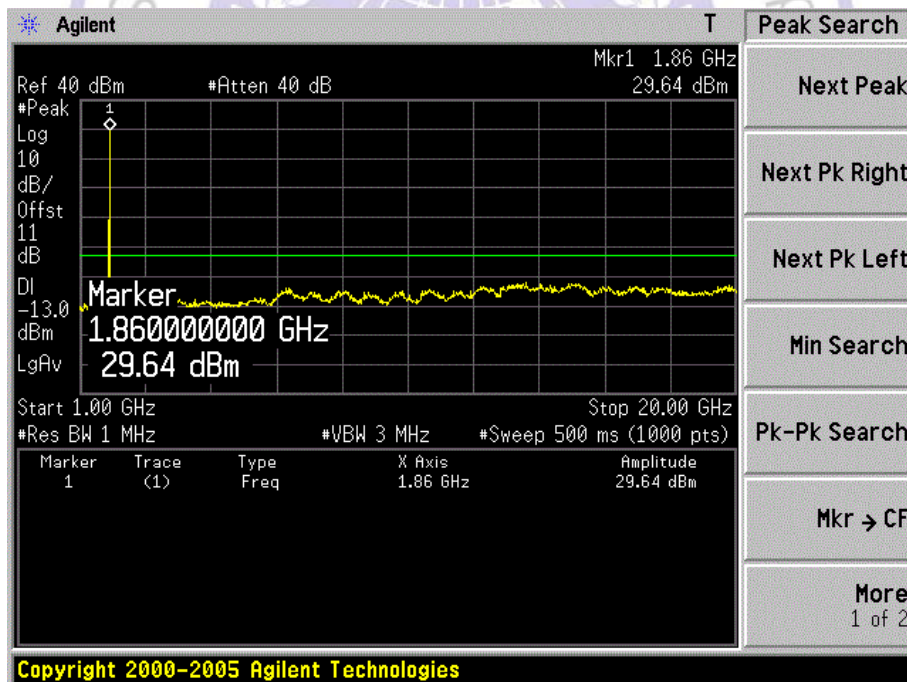
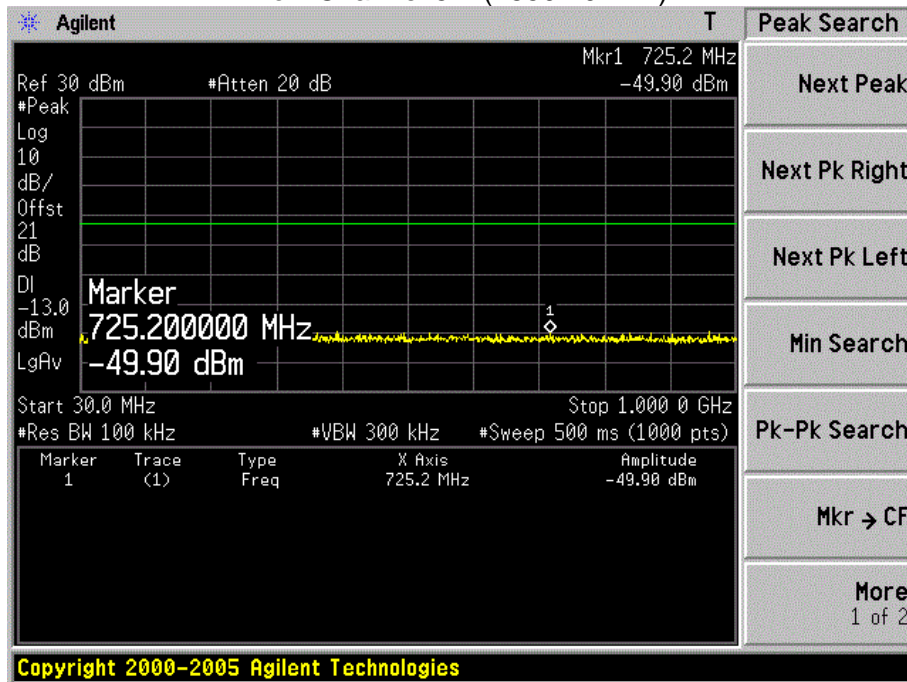

Mid Channel 661(1880.00MHz)

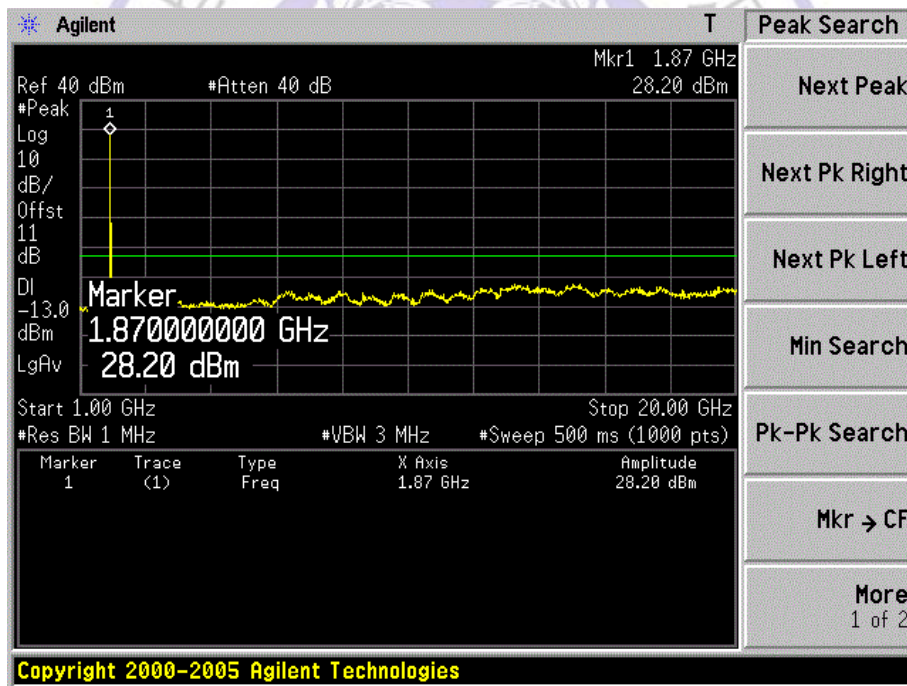
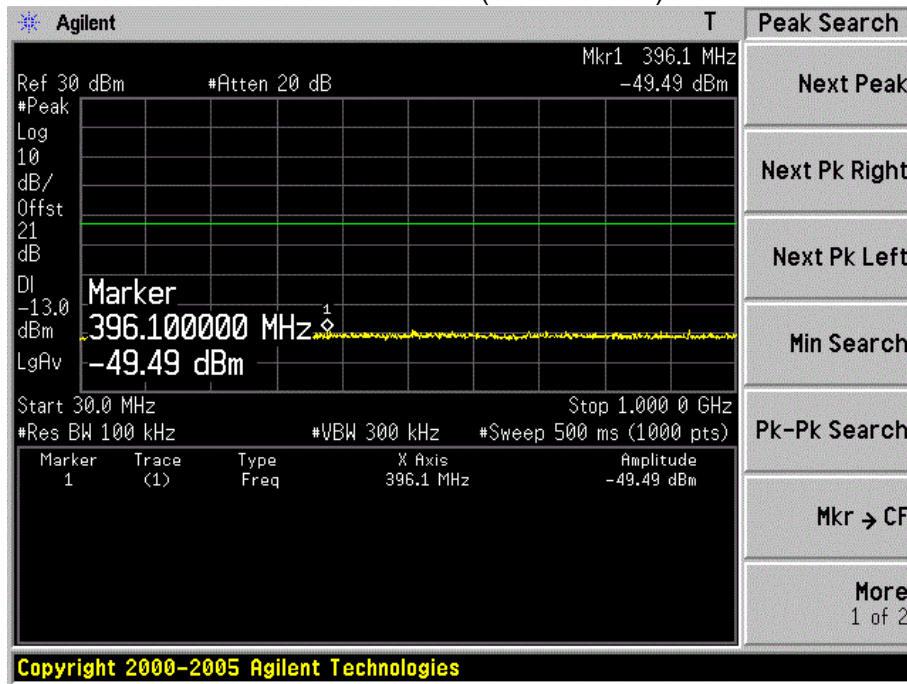

High Channel 810(1909.80MHz)

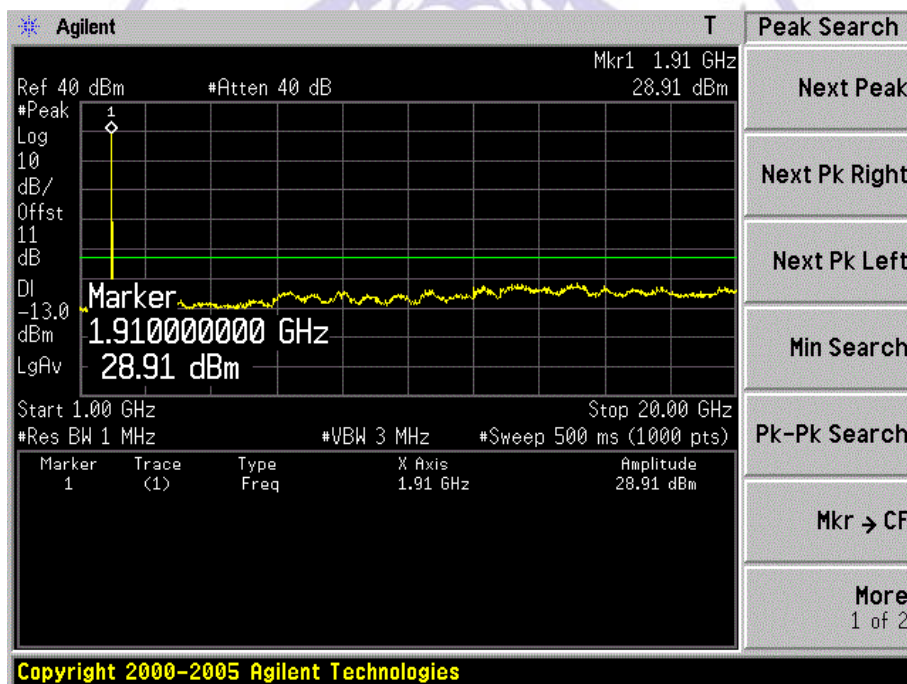
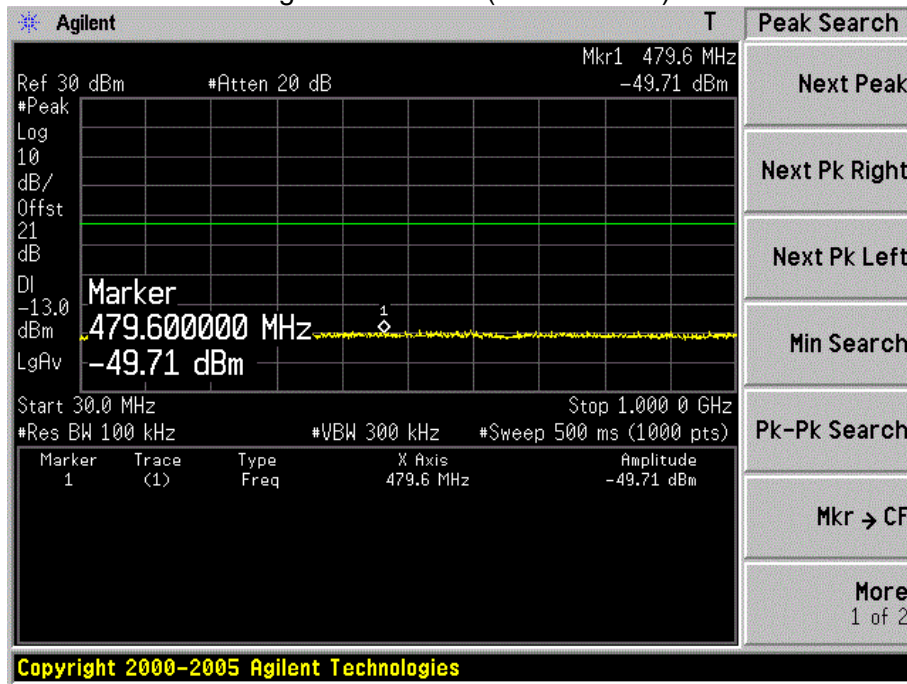

Test Item	Conducted Spurious Emission		
Test Mode	Mode 5: WCDMA Band II Link		
Date of Test	2014/09/10	Test Site	TR8

Low Channel 9262(1852.40MHz)

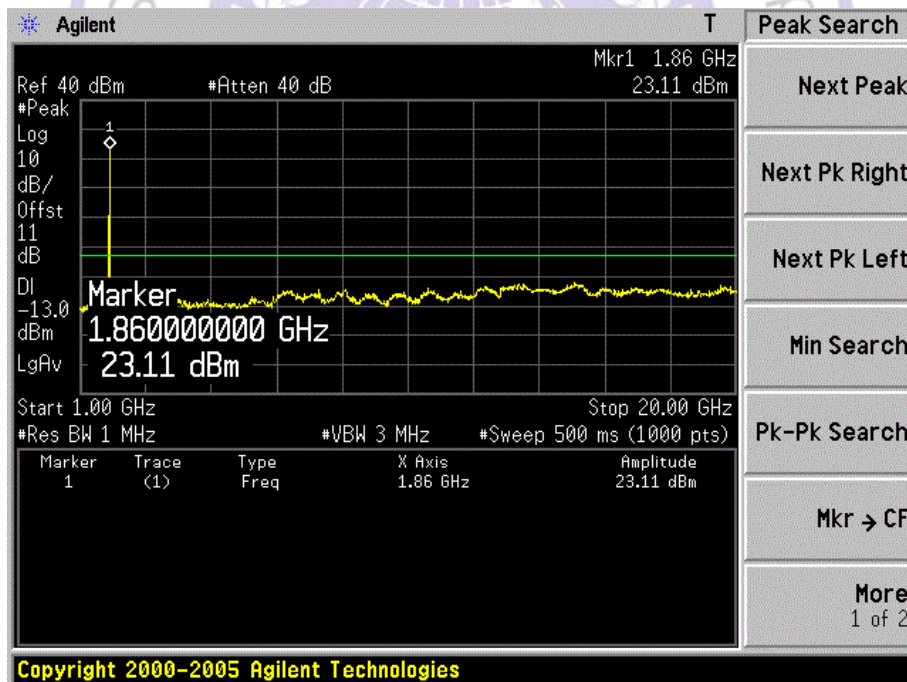
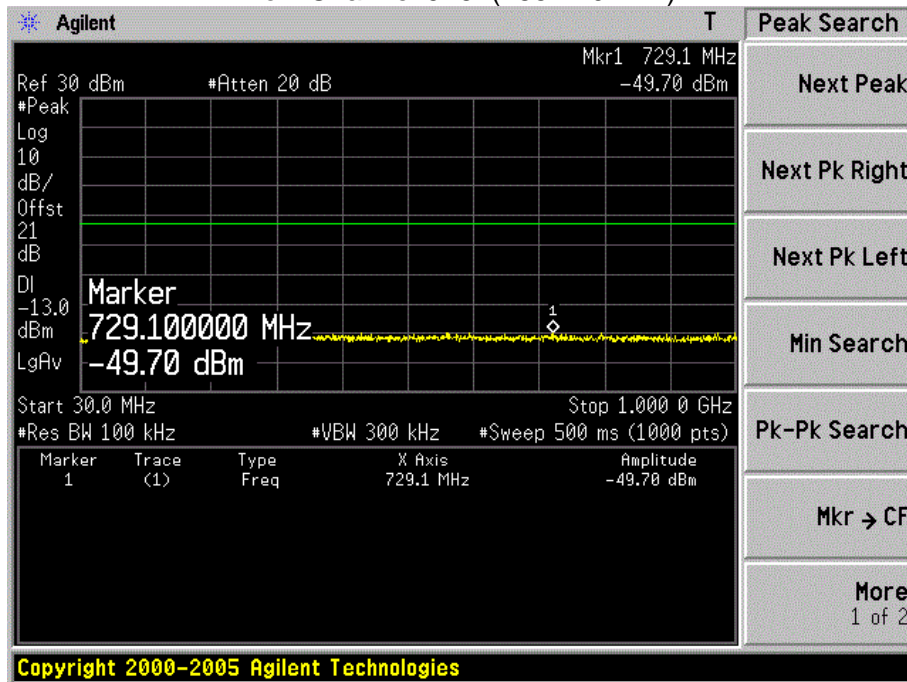

Mid Channel 9400(1880.00MHz)

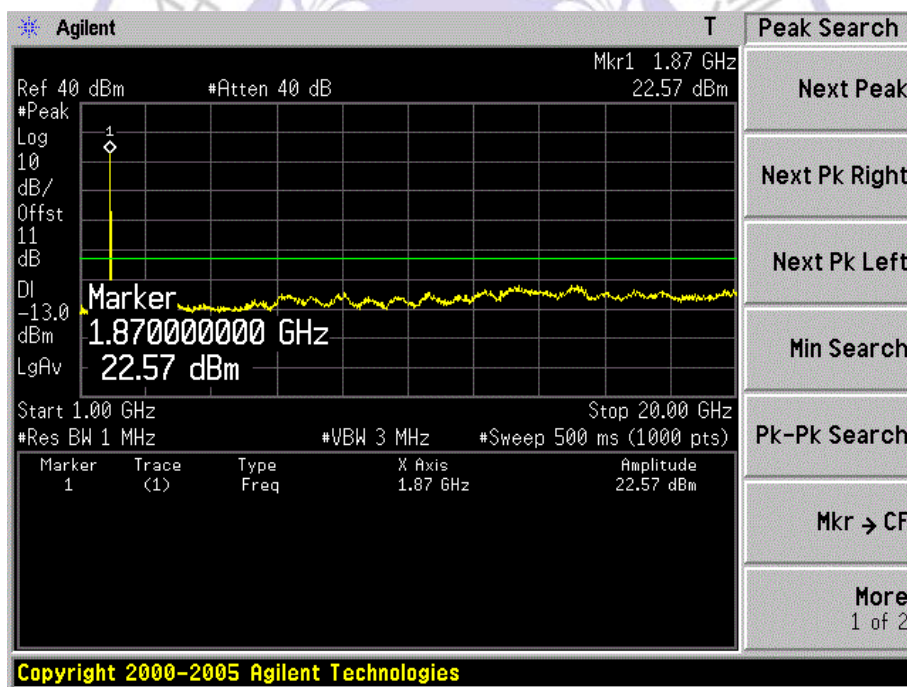
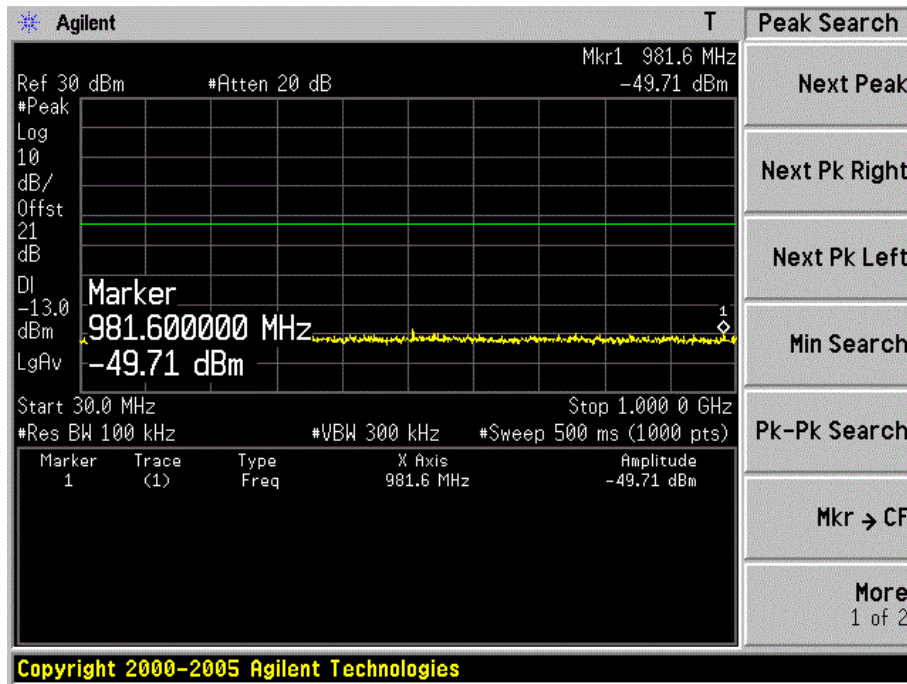

High Channel 9538(1907.60MHz)

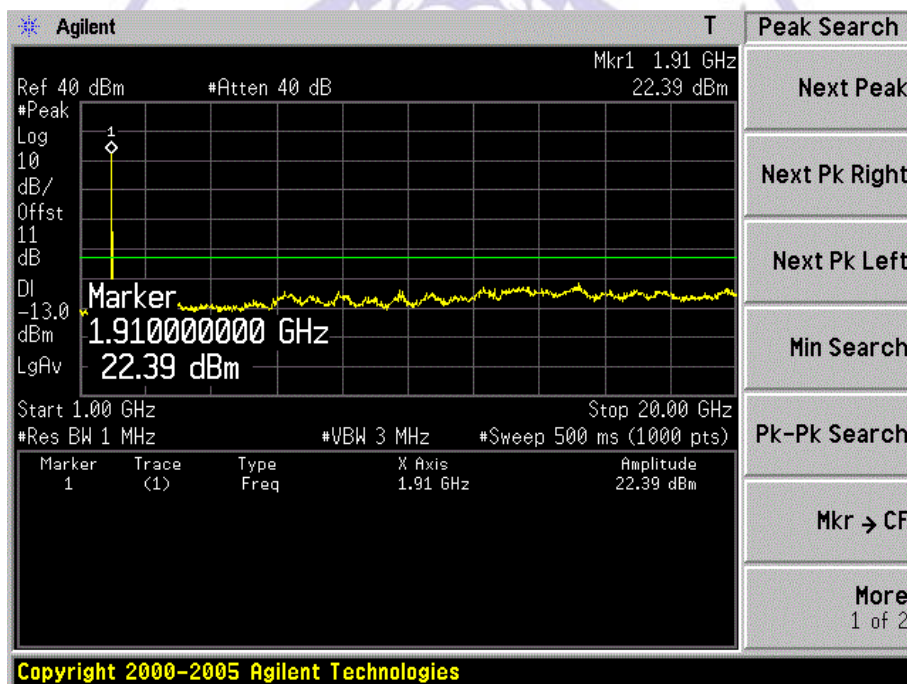
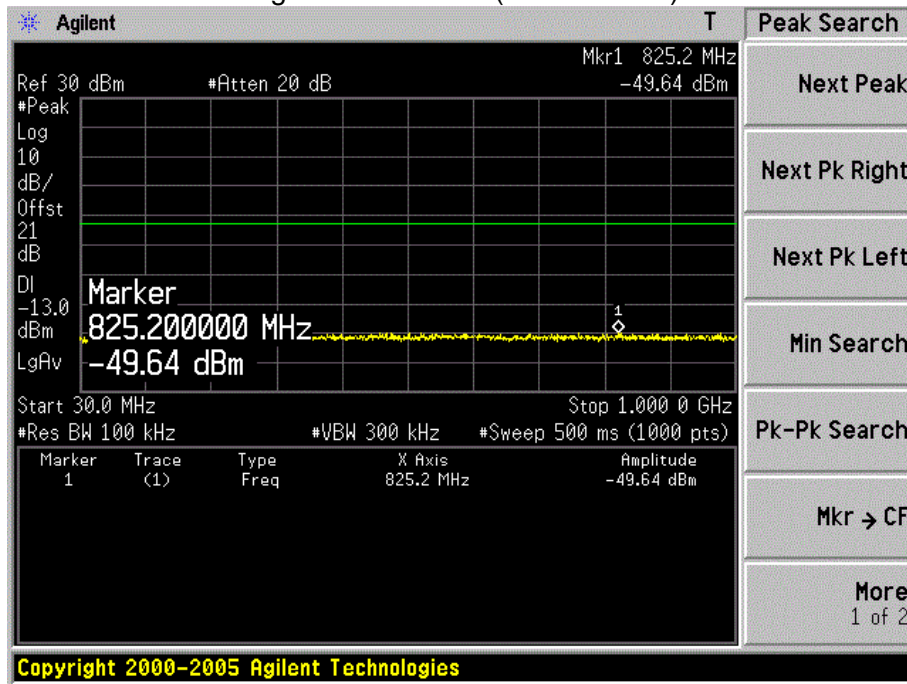

Test Item	Conducted Spurious Emission		
Test Mode	Mode 6: WCDMA Band V Link		
Date of Test	2014/09/10	Test Site	TR8

Low Channel 4132(826.40MHz)

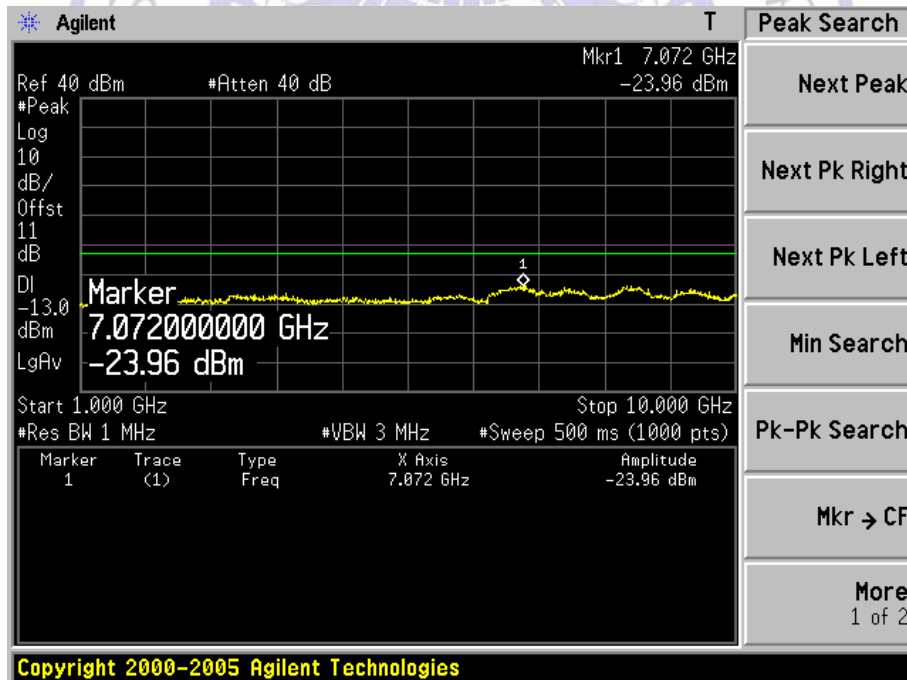
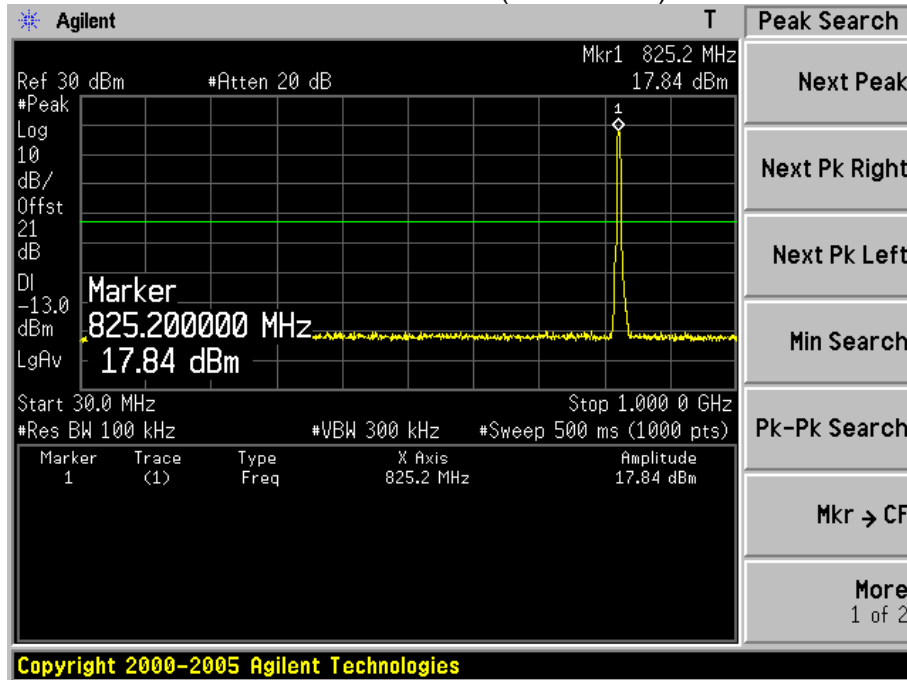



Mid Channel 4182(836.40MHz)

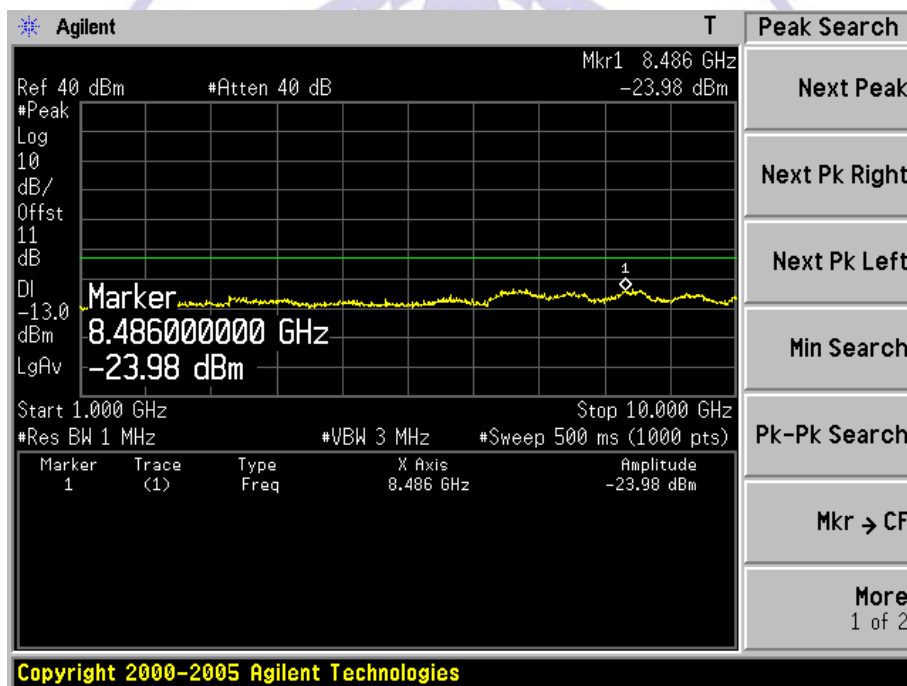
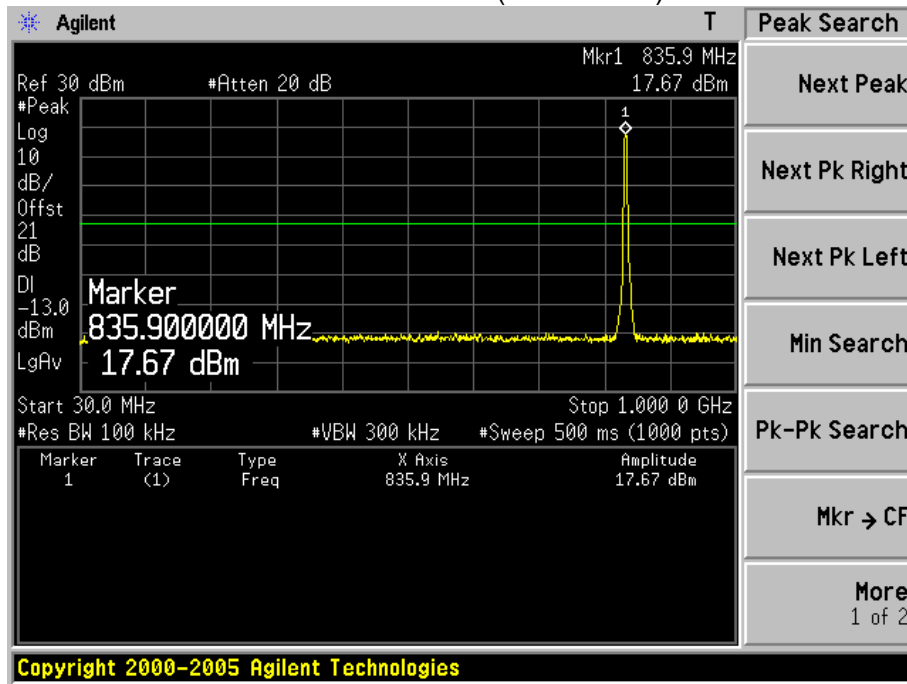

High Channel 4233(846.60MHz)

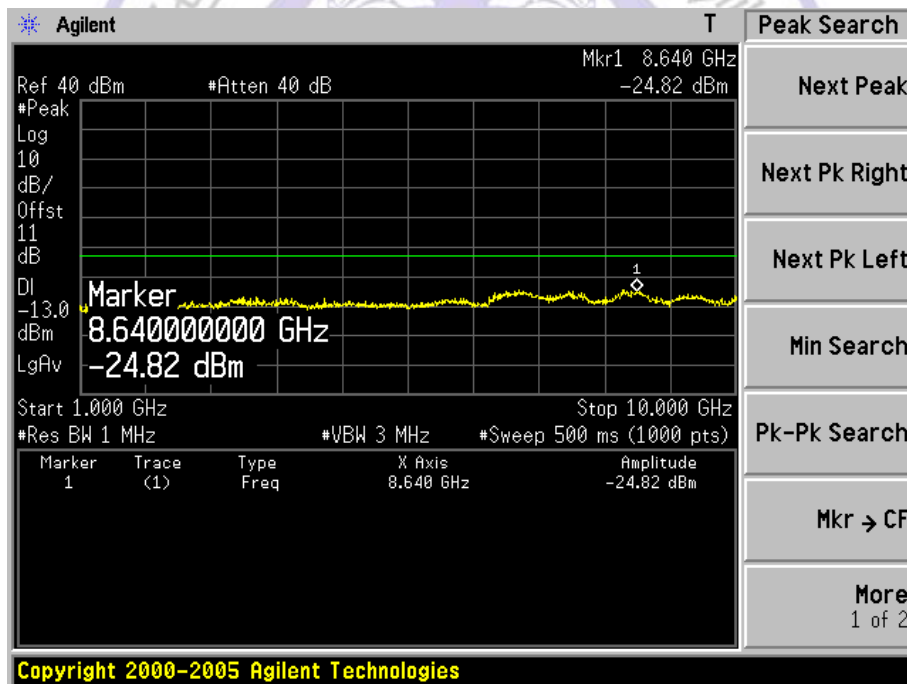
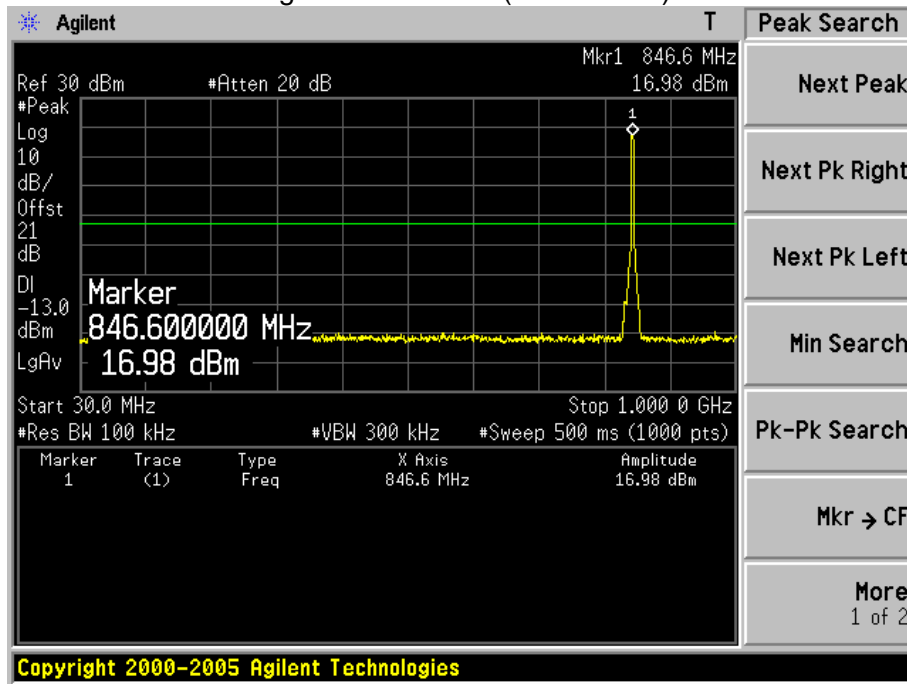

Test Item	Radiated Spurious Emission		
Test Mode	Mode 1: GSM 850 Link		
Date of Test	2014/09/10	Test Site	AC-5

Frequency (MHz)	SA Reading (dBm)	Ant.Pol. (H/V)	SG Reading (dBm)	Cable Loss (dB)	Gain (dBi)	EIRP (dBm)	Limit (dBm)	Margin (dB)
Low Channel 128 (824.20MHz)								
1646.00	-52.01	V	-54.58	2.50	9.75	-47.33	-13.00	-34.33
2470.50	-61.19	V	-60.26	3.12	10.48	-52.90	-13.00	-39.90
1646.00	-54.31	H	-56.97	2.50	9.75	-49.72	-13.00	-36.72
2470.50	-60.60	H	-59.51	3.12	10.48	-52.15	-13.00	-39.15
Middle Channel 189 (836.40MHz)								
1671.50	-53.69	V	-56.35	2.52	9.95	-48.92	-13.00	-35.92
2513.00	-63.16	V	-62.54	3.18	10.62	-55.10	-13.00	-42.10
1671.50	-51.91	H	-54.57	2.52	9.95	-47.14	-13.00	-34.14
2513.00	-62.34	H	-61.34	3.18	10.62	-53.90	-13.00	-40.90
High Channel 251 (848.80MHz)								
1697.00	-54.70	V	-57.43	2.54	10.06	-49.91	-13.00	-36.91
2547.00	-63.16	V	-61.61	3.14	10.68	-54.07	-13.00	-41.07
1697.00	-48.49	H	-56.01	2.54	10.06	-48.49	-13.00	-35.49
2547.00	-53.22	H	-60.76	3.14	10.68	-53.22	-13.00	-40.22

EIRP=SG Reading-Cable Loss+Gain, ERP=EIRP-2.15



Test Item	Radiated Spurious Emission		
Test Mode	Mode 2: GSM 1900 Link		
Date of Test	2014/09/10	Test Site	AC-5

Frequency (MHz)	SA Reading (dBm)	Ant.Pol. (H/V)	SG Reading (dBm)	Cable Loss (dB)	Gain (dBi)	EIRP (dBm)	Limit (dBm)	Margin (dB)
Low Channel 512 (1850.20MHz)								
3700.00	-65.44	V	-62.00	3.84	12.69	-53.15	-13.00	-40.15
5550.00	-66.24	V	-57.73	4.82	13.15	-49.40	-13.00	-36.40
3700.00	-64.56	H	-61.20	3.84	12.69	-52.35	-13.00	-39.35
5550.00	-66.82	H	-58.93	4.82	13.15	-50.60	-13.00	-37.60
Middle Channel 661 (1880.00MHz)								
3760.00	-64.90	V	-61.70	3.73	12.72	-52.71	-13.00	-39.71
5640.00	-66.56	V	-58.62	4.93	13.14	-50.41	-13.00	-37.41
3760.00	-64.49	H	-61.22	3.73	12.72	-52.23	-13.00	-39.23
5640.00	-65.77	H	-58.15	4.93	13.14	-49.94	-13.00	-36.94
High Channel 810 (1909.80MHz)								
3818.00	-65.06	V	-61.34	4.02	12.73	-52.63	-13.00	-39.63
5727.00	-65.67	V	-57.00	4.87	13.11	-48.76	-13.00	-35.76
3818.00	-64.60	H	-60.73	4.02	12.73	-52.02	-13.00	-39.02
5727.00	-66.65	H	-58.38	4.87	13.11	-50.14	-13.00	-37.14

EIRP=SG Reading-Cable Loss+Gain, ERP=EIRP-2.15



Test Item	Radiated Spurious Emission		
Test Mode	Mode 3: EDGE S850 Link		
Date of Test	2014/09/10	Test Site	AC5

Frequency (MHz)	SA Reading (dBm)	Ant.Pol. (H/V)	SG Reading (dBm)	Cable Loss (dB)	Gain (dBi)	EIRP (dBm)	Limit (dBm)	Margin (dB)
Low Channel 128 (824.20MHz)								
1646.00	-53.50	V	-56.07	2.50	9.75	-48.82	-13.00	-35.82
2470.50	-54.83	V	-70.48	3.12	10.48	-63.12	-13.00	-50.12
1646.00	-51.73	H	-54.39	2.50	9.75	-47.14	-13.00	-34.14
2470.50	-60.78	H	-59.69	3.12	10.48	-52.33	-13.00	-39.33
Middle Channel 189 (836.40MHz)								
1671.50	-58.52	V	-61.18	2.52	9.95	-53.75	-13.00	-40.75
2513.00	-62.88	V	-62.26	3.18	10.62	-54.82	-13.00	-41.82
1671.50	-57.47	H	-59.89	2.52	9.95	-52.46	-13.00	-39.46
2513.00	-63.05	H	-62.05	3.18	10.62	-54.61	-13.00	-41.61
High Channel 251 (848.80MHz)								
1697.00	-59.50	V	-62.23	2.54	10.06	-54.71	-13.00	-41.71
2547.00	-63.24	V	-61.69	3.14	10.68	-54.15	-13.00	-41.15
1697.00	-59.71	H	-61.71	2.54	10.06	-54.19	-13.00	-41.19
2547.00	-62.30	H	-60.50	3.14	10.68	-52.96	-13.00	-39.96

EIRP=SG Reading-Cable Loss+Gain, ERP=EIRP-2.15

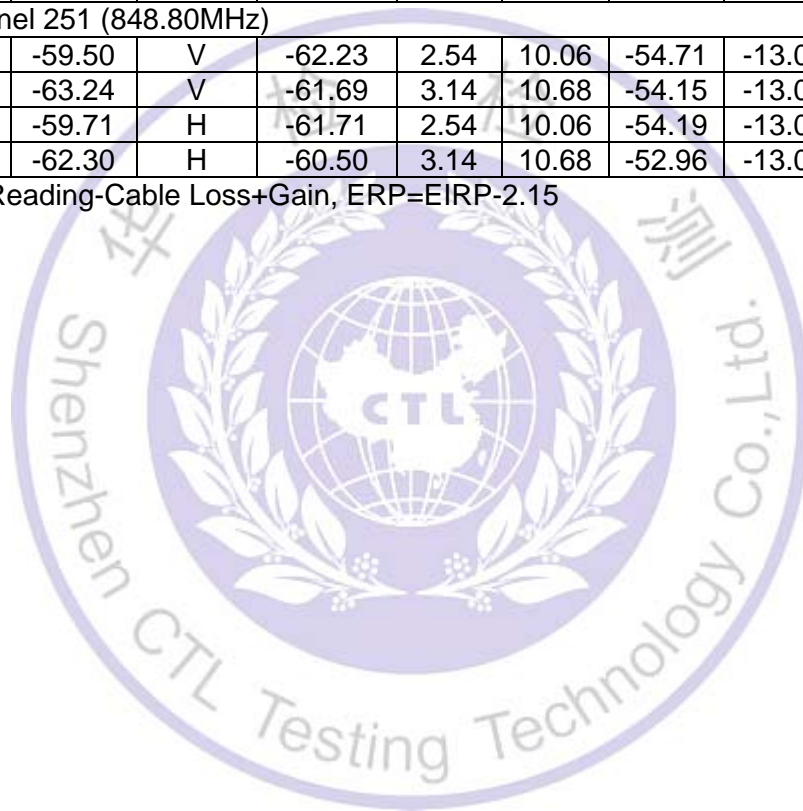

Test Item	Radiated Spurious Emission		
Test Mode	Mode 4: EDGE 1900 Link		
Date of Test	2014/09/10	Test Site	AC5

Frequency (MHz)	SA Reading (dBm)	Ant.Pol. (H/V)	SG Reading (dBm)	Cable Loss (dB)	Gain (dBi)	EIRP (dBm)	Limit (dBm)	Margin (dB)
Low Channel 512 (1850.20MHz)								
3700.00	-65.02	V	-61.59	3.84	12.69	-52.74	-13.00	-39.74
5550.00	-65.93	V	-57.43	4.82	13.15	-49.10	-13.00	-36.10
3700.00	-64.44	H	-61.08	3.84	12.69	-52.23	-13.00	-39.23
5550.00	-66.35	H	-58.47	4.82	13.15	-50.14	-13.00	-37.14
Middle Channel 661 (1880.00MHz)								
3760.00	-64.98	V	-61.78	3.73	12.72	-52.79	-13.00	-39.79
5640.00	-66.39	V	-58.45	4.93	13.14	-50.24	-13.00	-37.24
3760.00	-64.74	H	-61.47	3.73	12.72	-52.48	-13.00	-39.48
5640.00	-66.34	H	-58.72	4.93	13.14	-50.51	-13.00	-37.51
High Channel 810 (1909.80MHz)								
3818.00	-65.01	V	-61.29	4.02	12.73	-52.58	-13.00	-39.58
5727.00	-65.99	V	-57.32	4.87	13.11	-49.08	-13.00	-36.08
3818.00	-65.10	H	-61.23	4.02	12.73	-52.52	-13.00	-39.52
5727.00	-66.35	H	-58.08	4.87	13.11	-49.84	-13.00	-36.84

EIRP=SG Reading-Cable Loss+Gain, ERP=EIRP-2.15



Test Item	Radiated Spurious Emission		
Test Mode	Mode5: WCDMA Band II Link		
Date of Test	2014/09/10	Test Site	AC5

Frequency (MHz)	SA Reading (dBm)	Ant.Pol. (H/V)	SG Reading (dBm)	Cable Loss (dB)	Gain (dBi)	EIRP (dBm)	Limit (dBm)	Margin (dB)
Low Channel 9262 (1852.40MHz)								
3704.80	-62.52	V	-58.12	4.78	12.69	-50.21	-13.00	-37.21
5557.20	-63.49	V	-54.98	4.82	13.15	-46.65	-13.00	-33.65
3704.80	-63.11	H	-58.79	4.78	12.69	-50.88	-13.00	-37.88
5557.20	-64.12	H	-56.25	4.82	13.15	-47.92	-13.00	-34.92
Middle Channel 9400 (1880.00MHz)								
3760.00	-61.35	V	-56.83	5.03	12.72	-49.14	-13.00	-36.14
5640.00	-60.57	V	-51.58	5.93	13.14	-44.37	-13.00	-31.37
3760.00	-61.45	H	-56.85	5.03	12.72	-49.16	-13.00	-36.16
5640.00	-62.52	H	-53.79	5.93	13.14	-46.58	-13.00	-33.58
High Channel 9538 (1907.60MHz)								
3815.20	-59.76	V	-55.02	5.03	12.73	-47.32	-13.00	-34.32
5722.80	-60.35	V	-51.74	4.87	13.11	-43.50	-13.00	-30.50
3815.20	-59.65	H	-54.74	5.03	12.73	-47.04	-13.00	-34.04
5722.80	-62.14	H	-53.90	4.87	13.11	-45.66	-13.00	-32.66

EIRP=SG Reading-Cable Loss+Gain, ERP=EIRP-2.15



Test Item	Radiated Spurious Emission		
Test Mode	Mode 6: WCDMA Band V Traffic		
Date of Test	2014/09/10	Test Site	AC5

Frequency (MHz)	SA Reading (dBm)	Ant.Pol. (H/V)	SG Reading (dBm)	Cable Loss (dB)	Gain (dBi)	EIRP (dBm)	Limit (dBm)	Margin (dB)
Low Channel 4132 (826.40MHz)								
1654.50	-50.74	V	-52.50	3.28	9.75	-46.03	-13.00	-33.03
2479.20	-50.85	V	-49.07	4.10	10.48	-42.69	-13.00	-29.69
1654.50	-50.50	H	-52.25	3.28	9.75	-45.78	-13.00	-32.78
2479.00	-44.21	H	-42.20	4.10	10.48	-35.82	-13.00	-22.82
Middle Channel 4182 (836.40MHz)								
1671.50	-47.80	V	-49.67	3.32	9.95	-43.04	-13.00	-30.04
2513.00	-48.84	V	-47.17	4.31	10.62	-40.86	-13.00	-27.86
1671.50	-46.77	H	-48.39	3.32	9.95	-41.76	-13.00	-28.76
2513.00	-40.36	H	-38.30	4.31	10.62	-31.99	-13.00	-18.99
High Channel 4233 (846.60MHz)								
1697.00	-42.24	V	-44.16	3.35	10.06	-37.45	-13.00	-24.45
2539.80	-49.46	V	-46.77	3.91	10.33	-40.35	-13.00	-27.35
1697.00	-42.64	H	-43.61	4.19	10.68	-37.12	-13.00	-24.12
2538.50	-43.15	H	-40.25	4.33	10.79	-33.79	-13.00	-20.79

EIRP=SG Reading-Cable Loss+Gain, ERP=EIRP-2.15

**Remark: All of the modes tested and the worst case mode were recorded in the report, other test results below the limit over 20dB.**

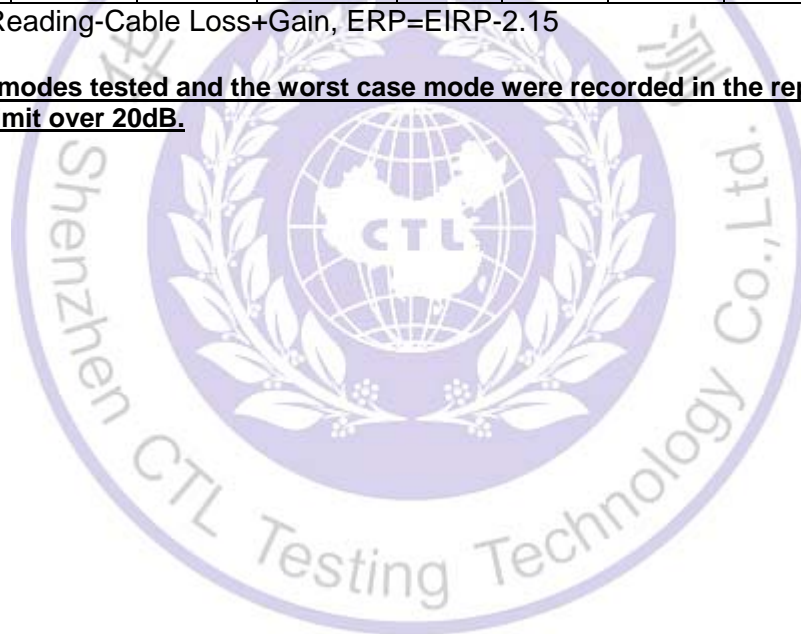



## 4.6. Frequency Stability under Temperature & Voltage Variations

### TEST CONFIGURATION

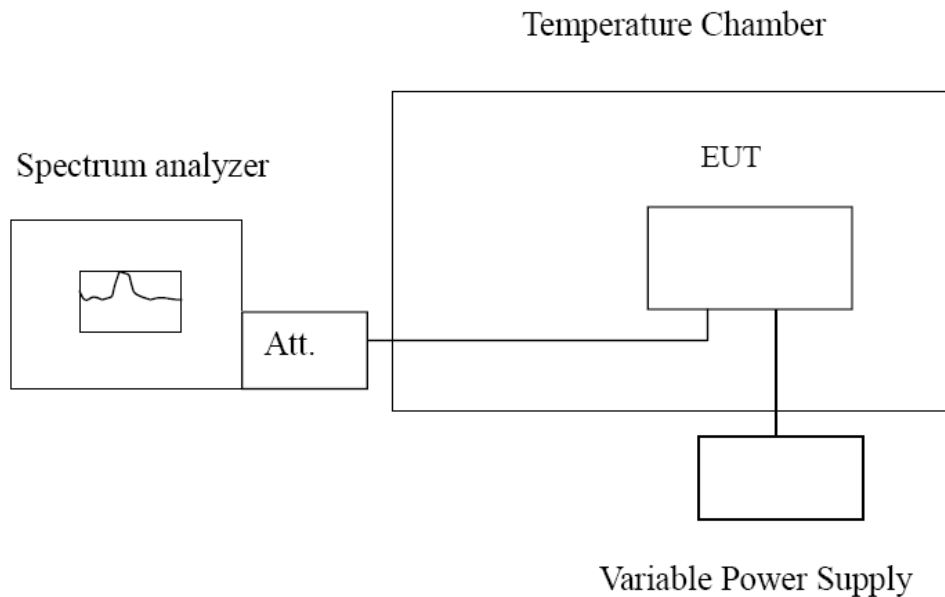

### TEST PROCEDURE

The EUT was setup according to EIA/TIA 603C

#### **Frequency Stability Under Temperature Variations:**

The equipment under test was connected to an external AC or DC power supply and input rated voltage. RF output was connected to a frequency counter or spectrum analyzer via feed through attenuators. The EUT was placed inside the temperature chamber. Set the spectrum analyzer RBW low enough to obtain the desired frequency resolution and measure EUT 20°C operating frequency as reference frequency. Turn EUT off and set the chamber temperature to -30°C. After the temperature stabilized for approximately 30 minutes recorded the frequency. Repeat step measure with 10°C increased per stage until the highest temperature of +50°C reached.

#### **Frequency Stability Under Voltage Variations:**

Set chamber temperature to 20°C. Use a variable AC power supply / DC power source to power the EUT and set the voltage to rated voltage. Set the spectrum analyzer RBW low enough to obtain the desired frequency resolution and recorded the frequency.

Reduce the input voltage to specify extreme voltage variation ( $\pm 15\%$ ) and endpoint, record the maximum frequency change.

### LIMIT

The frequency stability shall be sufficient to ensure that the fundamental emission stays within the authorized frequency block.

Limit <  $\pm 2.5$  ppm

### TEST RESULTS

See next pages.

Test Item	Frequency Stability Under Temperature & Voltage Variations		
Test Mode	Mode 1: GPRS 850 Link		
Date of Test	2013/07/20	Test Site	AC6

## Frequency Stability under Temperature

Temperature Interval (°C)	Test Frequency (MHz)	Deviation (Hz)	Limit (Hz)
-30	836.40	56	± 2091
-20	836.40	32	± 2091
-10	836.40	-14	± 2091
0	836.40	31	± 2091
10	836.40	-13	± 2091
20	836.40	14	± 2091
30	836.40	-54	± 2091
40	836.40	16	± 2091
50	836.40	26	± 2091

## Frequency Stability under Voltage

DC Voltage (V)	Test Frequency (MHz)	Deviation (Hz)	Limit (Hz)
5.2	836.40	-13	± 2091
6.0	836.40	24	± 2091
6.8	836.40	-19	± 2091

Test Item	Frequency Stability Under Temperature & Voltage Variations		
Test Mode	Mode 2: GPRS1900 Link		
Date of Test	2014/09/10	Test Site	AC6

## Frequency Stability under Temperature

Temperature Interval (°C)	Test Frequency (MHz)	Deviation (Hz)	Limit (Hz)
-30	1880.00	-33	± 4700
-20	1880.00	50	± 4700
-10	1880.00	44	± 4700
0	1880.00	36	± 4700
10	1880.00	27	± 4700
20	1880.00	-23	± 4700
30	1880.00	41	± 4700
40	1880.00	36	± 4700
50	1880.00	-11	± 4700

## Frequency Stability under Voltage

DC Voltage (V)	Test Frequency (MHz)	Deviation (Hz)	Limit (Hz)
5.2	1880.00	29	± 4700
6.0	1880.00	-33	± 4700
6.8	1880.00	-21	± 4700

Test Item	Frequency Stability Under Temperature & Voltage Variations		
Test Mode	Mode 3: EDGE 850 Link		
Date of Test	2014/09/10	Test Site	TR7

## Frequency Stability under Temperature

Temperature Interval (°C)	Test Frequency (MHz)	Deviation (Hz)	Limit (Hz)
-30	836.40	-41	± 2091
-20	836.40	12	± 2091
-10	836.40	43	± 2091
0	836.40	25	± 2091
10	836.40	-17	± 2091
20	836.40	25	± 2091
30	836.40	56	± 2091
40	836.40	19	± 2091
50	836.40	41	± 2091

## Frequency Stability under Voltage

DC Voltage (V)	Test Frequency (MHz)	Deviation (Hz)	Limit (Hz)
5.2	836.40	-23	± 2091
6.0	836.40	19	± 2091
6.8	836.40	16	± 2091

Test Item	Frequency Stability Under Temperature & Voltage Variations		
Test Mode	Mode 4: EDGE1900 Link		
Date of Test	2014/09/10	Test Site	TR7

## Frequency Stability under Temperature

Temperature Interval (°C)	Test Frequency (MHz)	Deviation (Hz)	Limit (Hz)
-30	1880.00	22	± 4700
-20	1880.00	-21	± 4700
-10	1880.00	17	± 4700
0	1880.00	15	± 4700
10	1880.00	26	± 4700
20	1880.00	-10	± 4700
30	1880.00	58	± 4700
40	1880.00	41	± 4700
50	1880.00	21	± 4700

## Frequency Stability under Voltage

DC Voltage (V)	Test Frequency (MHz)	Deviation (Hz)	Limit (Hz)
5.2	1880.00	51	± 4700
6.0	1880.00	22	± 4700
6.8	1880.00	-32	± 4700

Test Item	Frequency Stability Under Temperature & Voltage Variations		
Test Mode	Mode 5: WCDMA Band II Link		
Date of Test	2014/09/10	Test Site	TR7

## Frequency Stability under Temperature

Temperature Interval (°C)	Test Frequency (MHz)	Deviation (Hz)	Limit (Hz)
-30	1880.00	28	± 4700
-20	1880.00	35	± 4700
-10	1880.00	26	± 4700
0	1880.00	40	± 4700
10	1880.00	31	± 4700
20	1880.00	43	± 4700
30	1880.00	-19	± 4700
40	1880.00	-31	± 4700
50	1880.00	-24	± 4700

## Frequency Stability under Voltage

DC Voltage (V)	Test Frequency (MHz)	Deviation (Hz)	Limit (Hz)
5.2	1880.00	18	± 4700
6.0	1880.00	-31	± 4700
6.8	1880.00	-20	± 4700

Test Item	Frequency Stability Under Temperature & Voltage Variations		
Test Mode	Mode 6: WCDMA Band V Link		
Date of Test	2014/09/10	Test Site	TR7

## Frequency Stability under Temperature

Temperature Interval (°C)	Test Frequency (MHz)	Deviation (Hz)	Limit (Hz)
-30	836.40	16	± 2091
-20	836.40	-31	± 2091
-10	836.40	15	± 2091
0	836.40	-14	± 2091
10	836.40	22	± 2091
20	836.40	43	± 2091
30	836.40	61	± 2091
40	836.40	65	± 2091
50	836.40	-33	± 2091

## Frequency Stability under Voltage

DC Voltage (V)	Test Frequency (MHz)	Deviation (Hz)	Limit (Hz)
5.2	836.40	-13	± 2091
6.0	836.40	23	± 2091
6.8	836.40	-32	± 2091

**Note:**

1. Normal Voltage: 6.0 V
2. Battery End Point(BEP) = 5.2V

### 5. Test Setup Photos of the EUT

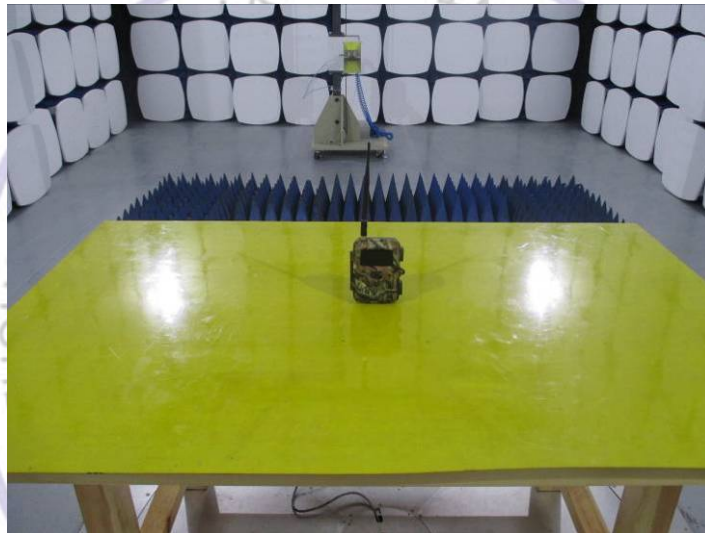
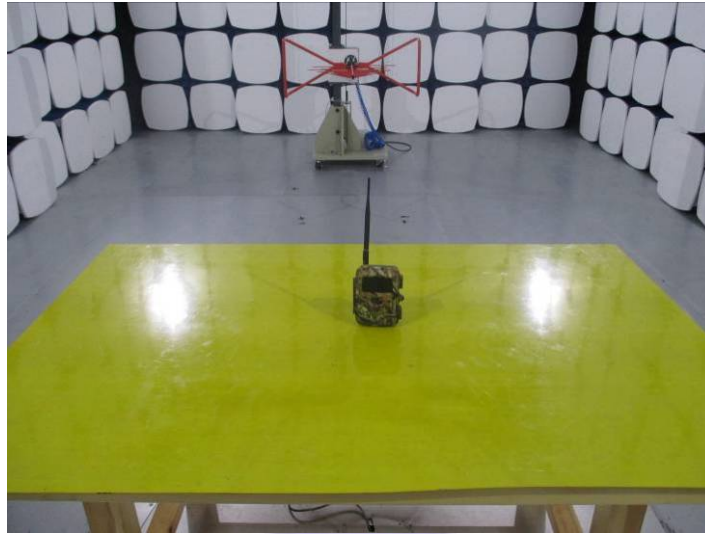



## 6. External and Internal Photos of the EUT

### External Photos of EUT

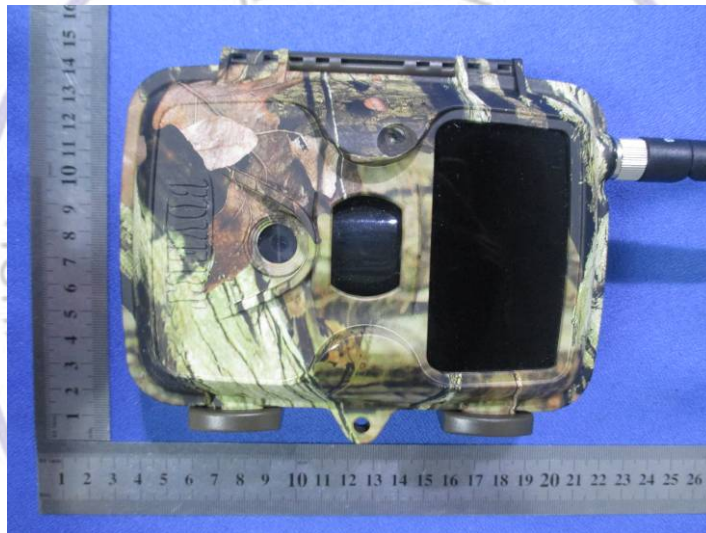
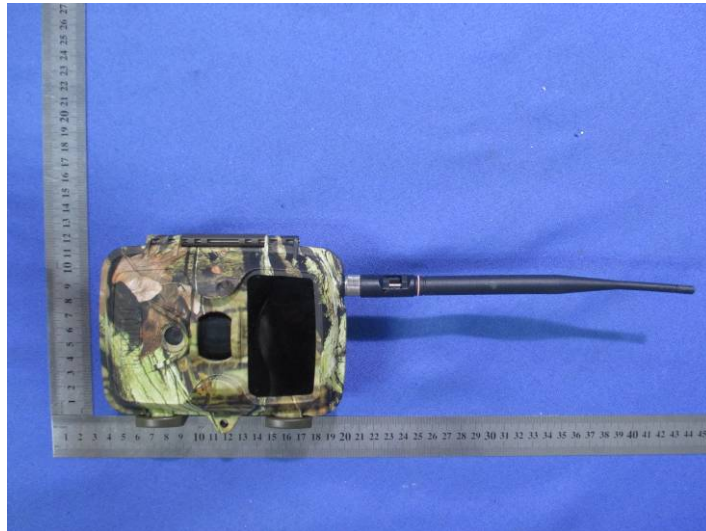





Internal Photos of EUT

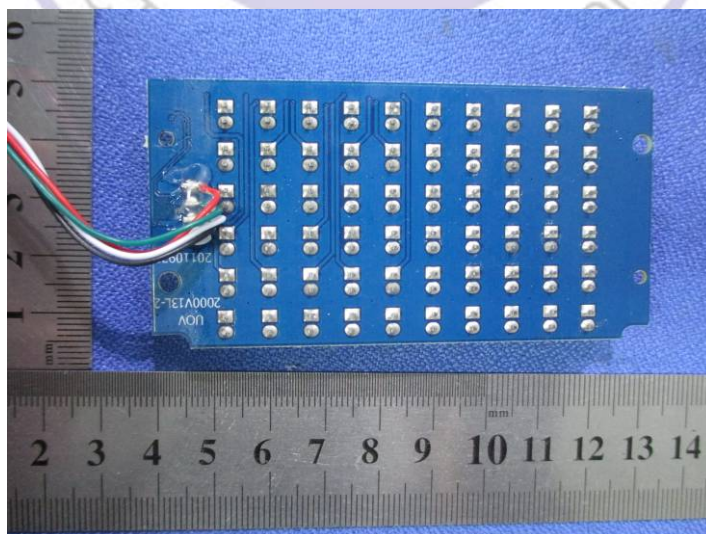
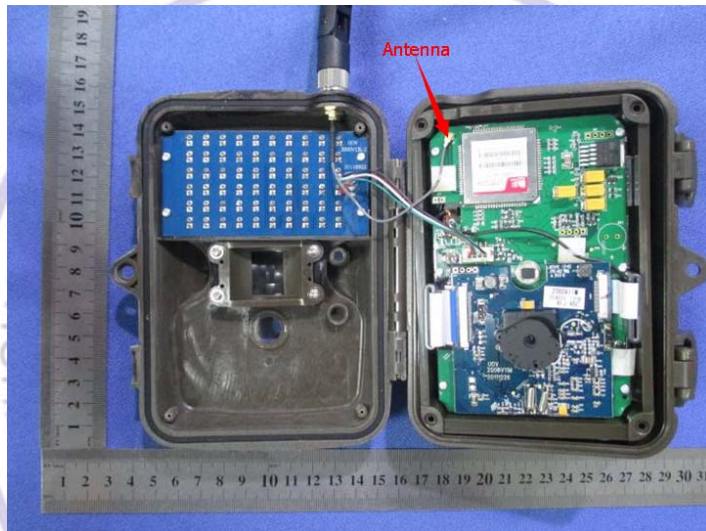

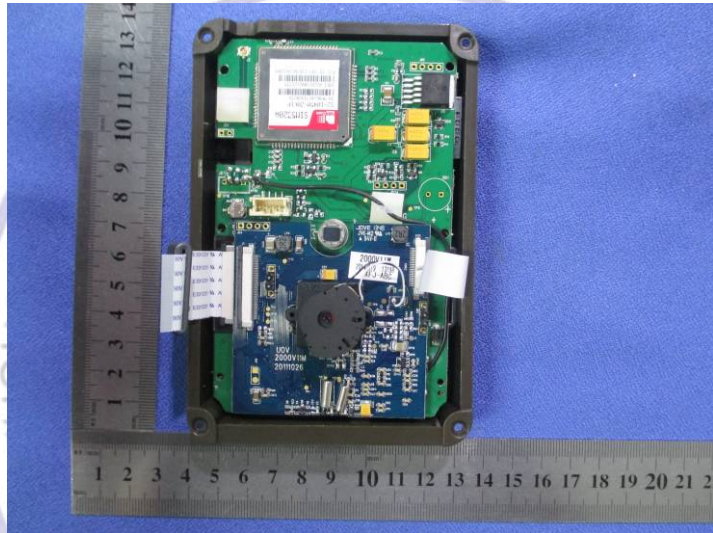
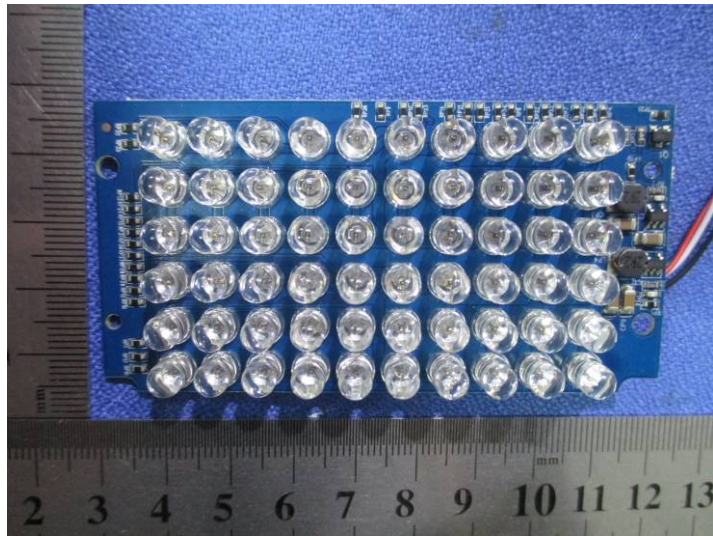

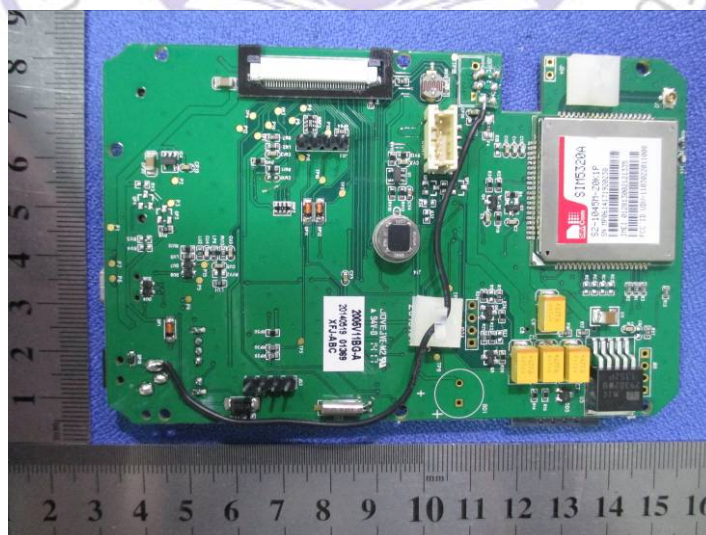
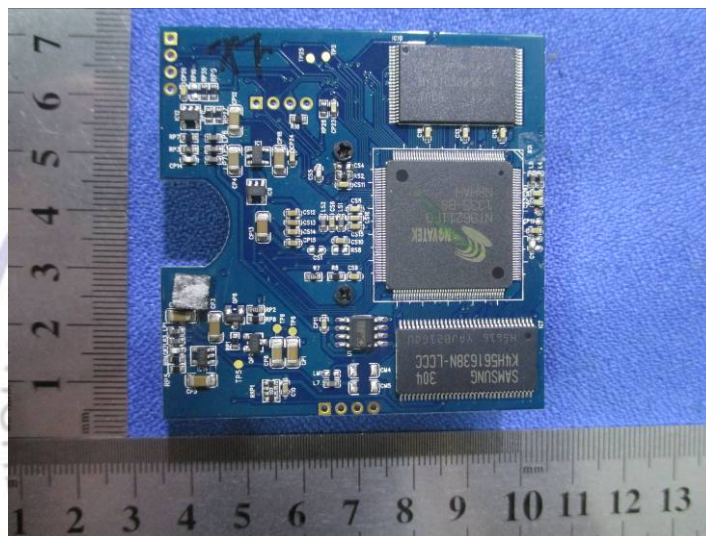
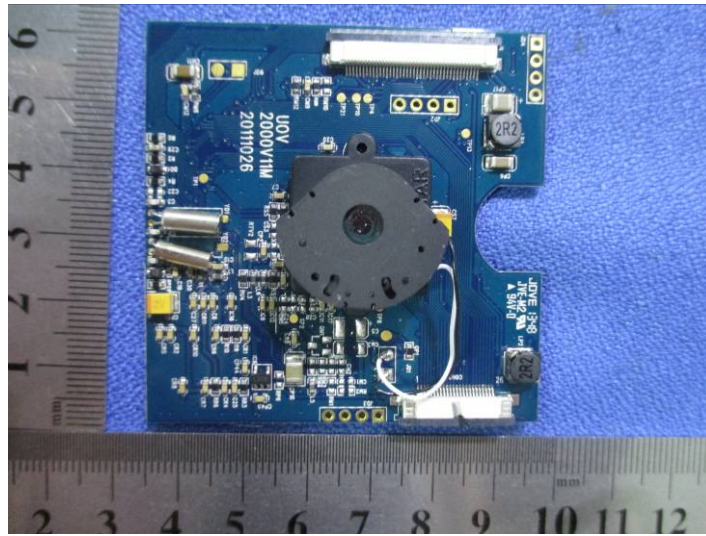

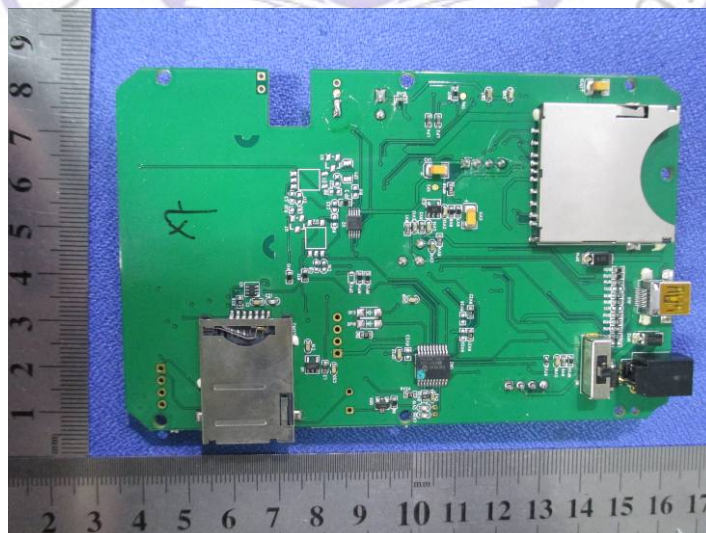
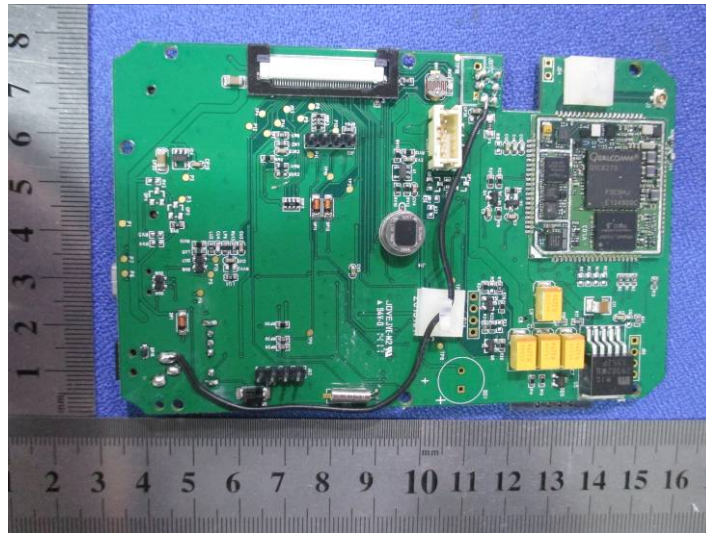

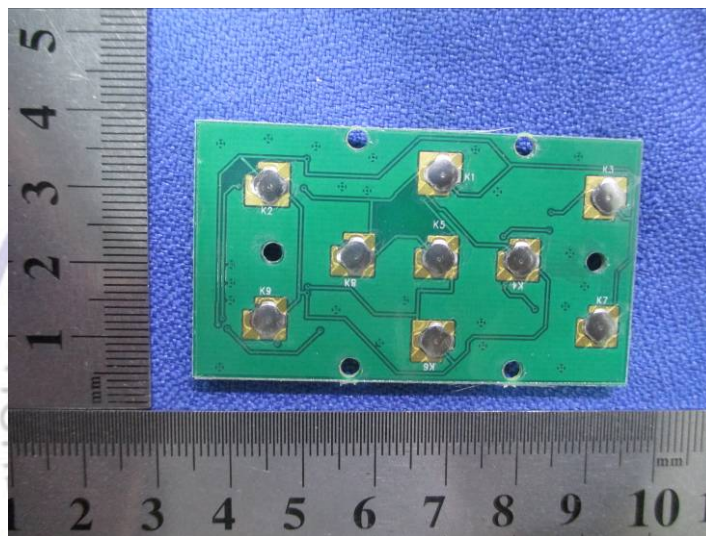
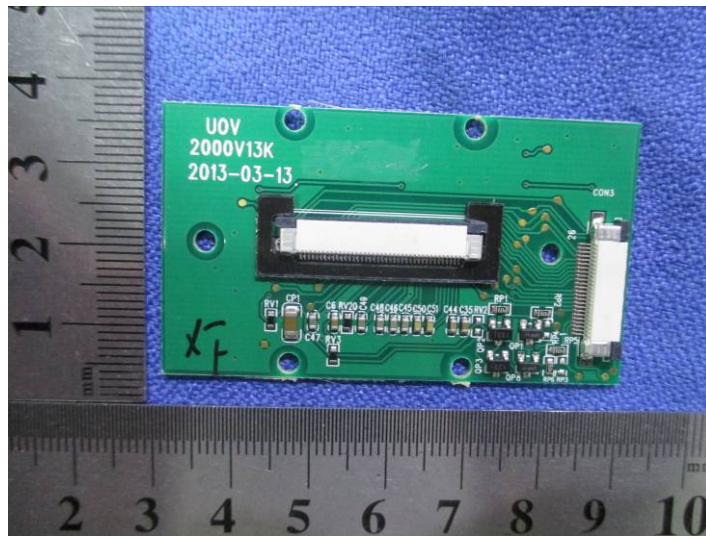

.....End of Report.....

