

goTenna



Pro-X2m Integration and Set-up Guide

2-11-25

Table of Contents

1. Introduction	3
2. Pro-X2m Specifications and Considerations	4
2.1 Safety and Handling Precautions	5
2.2 Ingress Protection and Environmental	5
2.3 Required Tools	5
2.4 Stop-gap and Power Continuity	5
3. Electro-Mechanical Interfaces	6
4. Step-by-Step Mechanical Integration	7
Step 1: Prepare the Chassis	7
Step 2: Insert the Pro-X2m and Secure	8
Step 3a: Connect Power Option-1	9
Step 3b: Connect Power Option 2	10
Step 4: External Antennas / Cables	11
5. Begin Operations	12
Step 1: Establish a goTenna Portal Account	12
Step 2: Download TAK or Pro App	13
Step 3A: Pair goTenna TAK plugin with Pro-X2m	14
Step 3B: Pair goTenna Pro App with Pro-X2m	18
6. Troubleshooting and Diagnostics	20
7. RF Transmission and Operational Compliance	20
FCC Compliance	20
Canada, Industry Canada (IC) Notices	21

1. Introduction

The Pro-X2m is the modular variant of the Pro-X2 mobile mesh radio, designed specifically for seamless, rapid integration into third-party platforms. The Pro-X2m is intended to ease integration of the goTenna mesh networking capabilities across a wide variety of systems, making it ideal for adaptable communications solutions in demanding environments. The Pro-X2m's modular mechanical design ensures easy installation and compatibility, enabling third-party platforms to integrate advanced connectivity with minimal modification. The Pro-X2m's power system has been redesigned, removing the internal batteries and accepting 9-32 VDC nominal input voltage. This alleviates the need for complicated DC-to-DC converters or adaptation to USB 5v power. On land, at sea, or in the air—even with autonomous systems—the Pro-X2m makes goTenna mesh networking integration simple and reliable.

Purpose: This document is meant to outline the Pro-X2m interfaces and methods of integration.

Audience: Intended for qualified integrators familiar with radio frequency (RF) compliance, thermal management, and electro-mechanical installation.

ICD Reference: Qualified integrators may contact support@goTenna.com for the full electro-mechanical ICD, if necessary for integration. It should be noted, however, that this not a board level product and disassembly will void any warranty and support for the product.

2. Pro-X2m Specifications and Considerations

X2m Facets	Facet Values
Dimensions - In (mm)	5.32 (135.10) L x 1.90 (48.34) W x 1.21 (30.73) H
Weight - Oz (g)	6.43 (182.5)
Front Plane Inputs / Outputs	Micro-USB
Back Plane Inputs	Power/Data
Mounting Features	Rail system / #6-32 Threaded Holes (5 faces)
Intrusion Characteristics (IP Rating)	IP30
Power In	9-32VDC; 3A Max
RF Operational Band(s)	445-480 MHz - FCC Part 90 Operations
RF Out	UHF
Data In/Out	USB / Bluetooth
Wireless Control Interface	Available Bluetooth RP-SMA interface
Max Internal Operating Temperature	140° F (60° C)
Min Internal Operating Temperature	-4° F (-20° C)

2.1 Safety and Handling Precautions

Electrostatic Discharge (ESD): Ensure anti-static measures are in place.

Handling and Orientation: Hold the Pro-X2m by its edges; follow orientation specifications to prevent connector damage.

Power Off: Confirm the chassis and any connected equipment are fully powered down during initial mating.

2.2 Ingress Protection and Environmental

IP Rating: While the PCBs of this device are conformally coated, this device is not protected against intrusion. Ingress protection is the requirement of the platform integrator and the operational employer. The Pro-X2m device itself has IP30 rating, providing protection against foreign objects 2.5 mm in diameter and no water protection. Any requirements for a higher IP rating are the responsibility of the platform integrator.

Thermal Management: This device contains NO active heating, cooling, or pressurization features. The environmental hardening of this device is the responsibility of the platform integrator and the operational Employer.

2.3 Required Tools

Tools: There is no required tooling for the use and integration of this device. This device is meant to be integrated by hand with limited resources by the platform integrator. Be mindful of over torquing, if using wrenches on the antenna ports. Any additional integration reinforcement is executed at the discretion and risk of the platform integrator and the operational employer.

2.4 Stop-gap and Power Continuity

This device does not contain an internal battery. Power continuity for stop-gap operations is the responsibility of the platform integrator and operational employer. If power from the integration platform fails, operations of this device will subsequently fail until power can be restored.

3. Electro-Mechanical Interfaces



Rail System

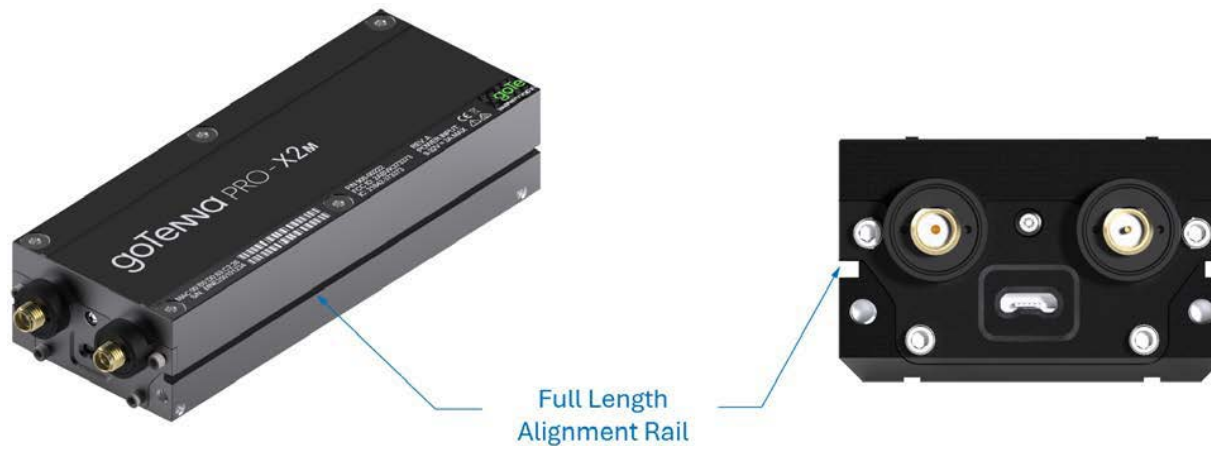

4. Step-by-Step Mechanical Integration

Step 1: Prepare the Chassis

*goTenna's Pro-X2m Reference Chassis is depicted here; integrator chasses will vary significantly

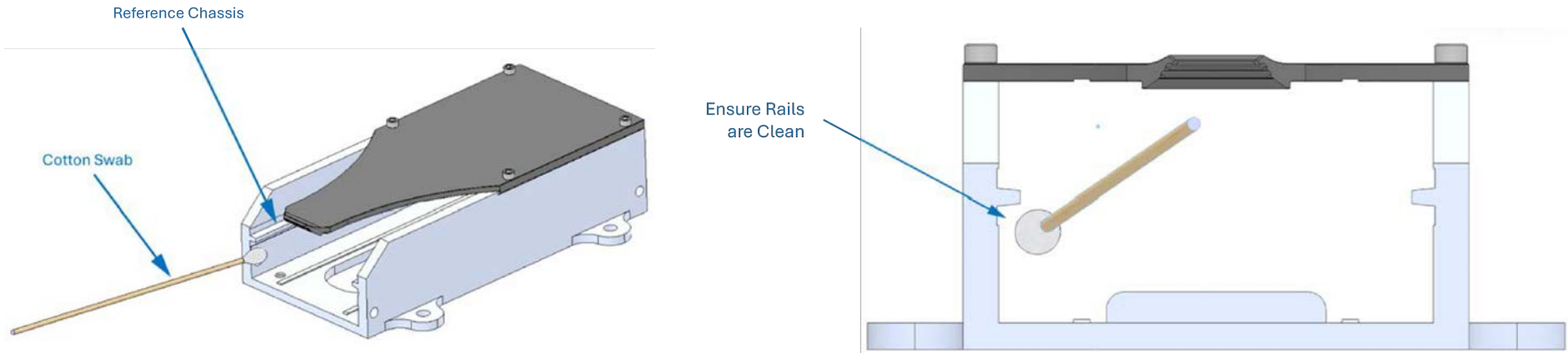

Cleaning: Clean mating interfaces from debris and obstacles

Slot Preparation: Verify the slot matches tolerances, and remove any protective covers or dust.

Dimensionality: Check to ensure that the Pro-X2m dimensions are compatible with the platform provider chassis. If the Pro-X2m and the Chassis are not compatible along all dimensions then an additional integration frame will be required. Additional integration requirements are the responsibility of the platform provider and operational deployer.

4. Step-by-Step Mechanical Integration (cont.)

Step 2: Insert the Pro-X2m and Secure

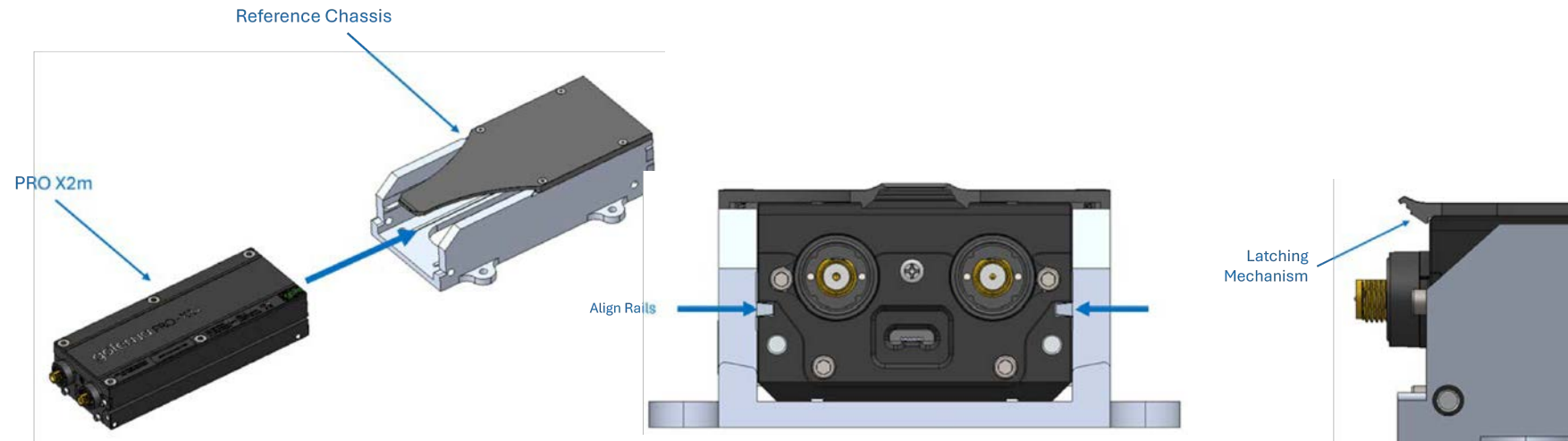

Ensure alignment: Ensure The frontplane with RF out is exposed to the user while the backplane with power is aligned with the chassis power interface. Utilize a locking or latching mechanism to ensure the Pro-X2m remains properly seated.

Guide Rails: Align with specified tolerances, $\pm 0.05\text{mm}$, ensuring a secure but low-resistance insertion.

Insertion Force: The Pro-X2m should slide into the chassis with minimal force. Excessive force may indicate misalignment.

4. Step-by-Step Mechanical Integration (cont.)

Step 3a: Connect Power Option-1

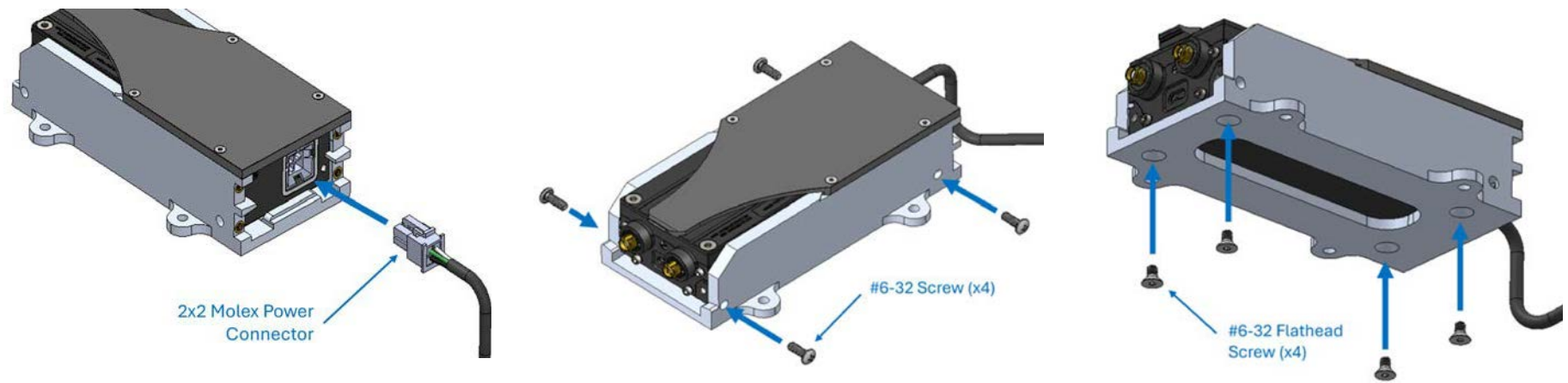

Connections: Insert power cable, 2x2 Molex (shown with guide marker toward the top of the device), per ICD specifications.

Power Path: A four position (2x2) Molex Connector (Molex P/N 0015246043s) on the back of the Pro-X2m will connect to a locking cable harness assembly provided by the integrator (suggested mating connector Molex P/N 39013048).

Route and Fix Cables: Ensure that all cables are routed and secured to avoid catching or accidental disturbance while in operation.

Fastening Points: If the Integrator designed chassis secures the Pro-X2m via any of the threaded holes found on the side and bottom faces. Use designated #6-32 screws and torque them to a torque of 4in-lbs to secure the sled without over-tightening. The bottom four threaded #6-32 holes have a thread depth of 0.125 inches. The four threaded #6-32 holes located on the sides of the Pro-X2m enclosure have a thread depth of 0.175 inches. Lengths of screws need to accommodate the thickness of the Integrator designed enclosure.

Verify: Check that all connections are secure.

4. Step-by-Step Mechanical Integration (Alternate.)

Step 3b: Connect Power Option 2



Connections: Insert power cable, 2x2 Molex Power Connector and Mounting Panel, onto the back plane of the reference chassis ensuring the alignment of the plate, connector and cover, and tighten the four (4) #2-56 3/8" screws to a torque of 3 in-lbs. The push-in connector is now installed.

Power Path: A four position (2x2) Molex Connector (Molex P/N 0015246043s) on the back of the Pro-X2m connects to a push-in 4 position receptacle connector provided by the integrator (suggested mating Molex P/N 015247043) as shown above. Integrators must ensure this location relative to the Pro-X2m for proper connectivity (See Reference Chassis).

Fastening Points: If the Integrator designed chassis secures the Pro-X2m via any of the threaded holes found on the side and bottom faces. Use designated #6-32 screws and torque them to a torque of 4in-lbs to secure the sled without over-tightening. The bottom four threaded #6-32 holes have a thread depth of 0.125 inches. The four threaded #6-32 holes located on the sides of the Pro-X2m enclosure have a thread depth of 0.175 inches. Lengths of screws need to accommodate the thickness of the Integrator designed enclosure.

Verify: Check that all connections are secure. Integrators should ensure that the keep out zone on the back plane is free from obstruction.

4. Step-by-Step Mechanical Integration (cont.)

Step 4: External Antennas / Cables

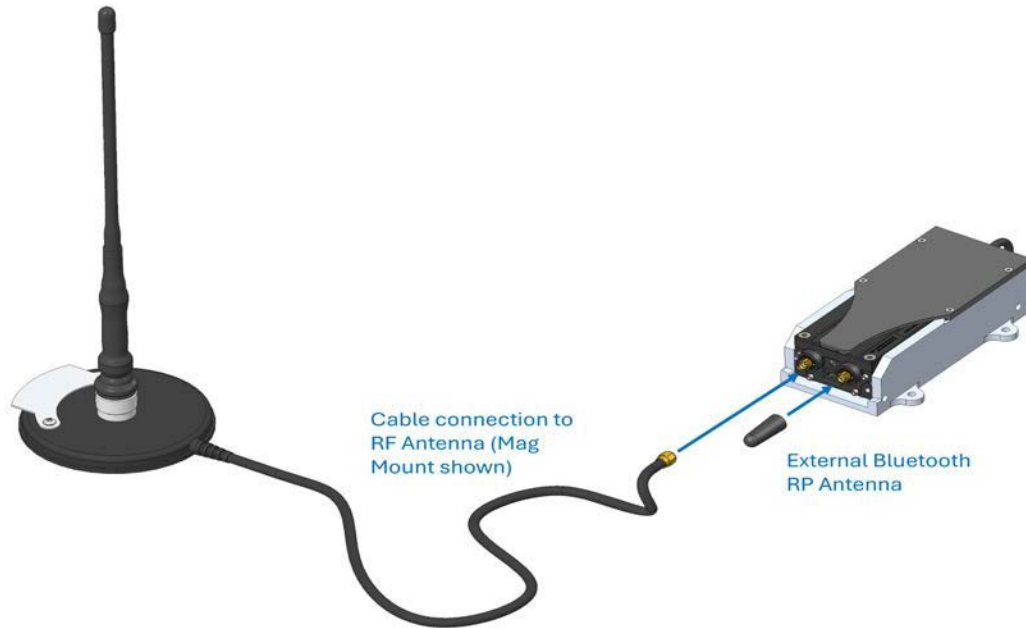

*The antenna depicted is merely an example. As the Pro-X2m is itself not environmentally hardened it is assumed that a wired antenna connection will be used for a band-appropriate antenna dislocated from the integrated chassis.

Antenna Considerations: Ensure that the antenna is placed with optimal line of sight (LoS), free of RF obstacles, and away from other transmitters. When using a monopole antenna ensure that a ground plane is at least $\frac{1}{4}$ wavelength in radius of the operational frequency. If Bluetooth connectivity is desired attach external Bluetooth antenna to reverse polarity SMA connector on the right side of the front face. Attach RF antenna, or RF extension cable to an external antenna, to the SMA connector on the left. Hand tighten.

*Antennas must maintain compliance with FCC Part 15.

5. Begin Operations

Step 1: Establish a goTenna Portal Account

Initial integration test and initial operational configuration requirement same setup steps.

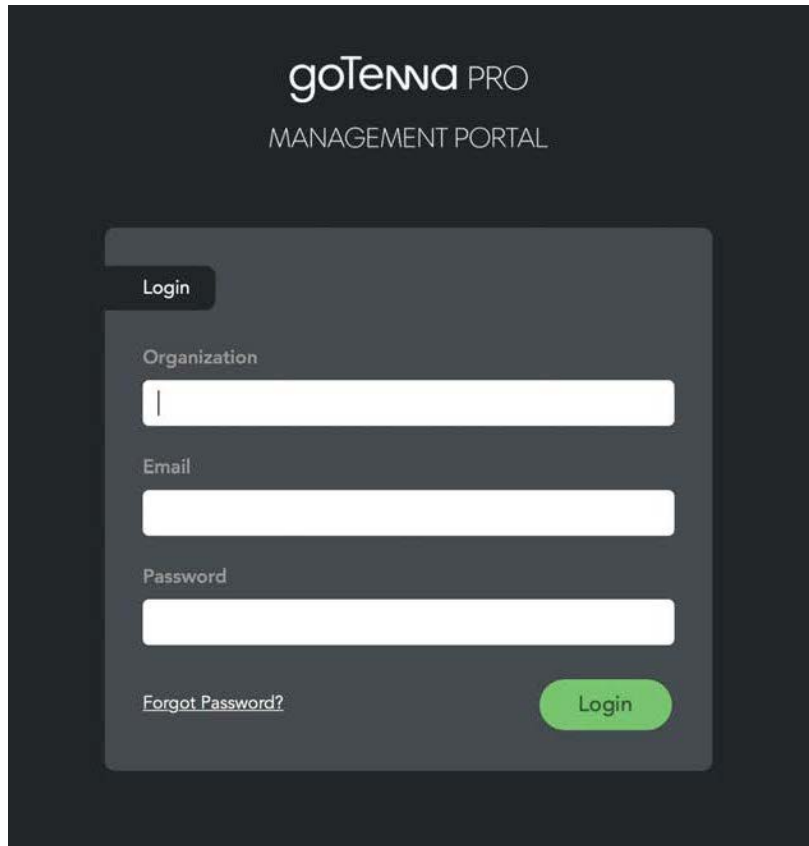

The screenshot shows the goTenna PRO Management Portal login interface. At the top, the logo 'goTenna PRO' and the text 'MANAGEMENT PORTAL' are displayed. Below this is a 'Login' button. The main form contains three input fields: 'Organization', 'Email', and 'Password'. A 'Forgot Password?' link is located below the password field. A green 'Login' button is positioned at the bottom right of the form.

If you already have a goKit or goTenna Pro X device Please contact goTenna at prosupport@gotenna.com for assistance.

The goTenna Portal can be accessed by visiting portal.gotenna.com on a computer.

You will need three things to log in to the portal. This information will be provided by your organization. If you have any issues logging in please contact prosupport@gotenna.com.

- **Organization** - The exact name of your organization as listed in goTenna. For example: "The SafeHouse" should be typed exactly as it is in the Portal into the devices signing in.
- **Email** - You must log in with the email credentials provided by your organization's administrator.
- **Password** - When your goTenna portal account is first created, you will receive an email confirming your account that also asks you to create a password. If you did not receive the onboarding email, please check your spam folder.

5. Begin Operations (cont.)

Step 2: Download TAK or Pro App

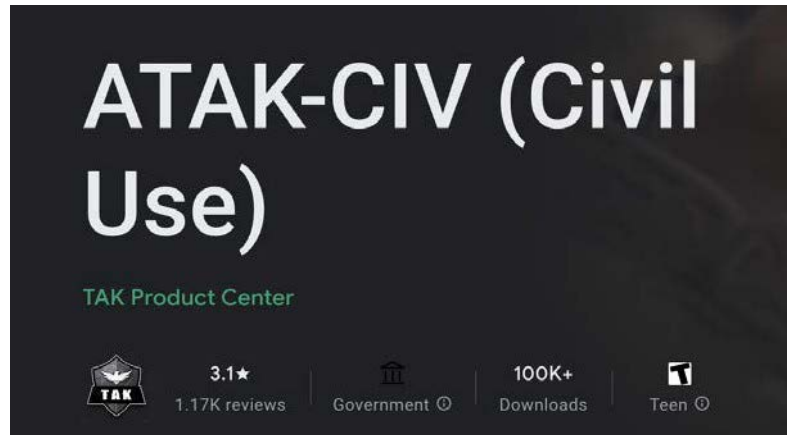

ATAK Plugin: goTenna

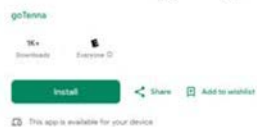

App support ▾

Download ATAK + goTenna TAK Plug-in

The Tactical Awareness Kit provides leading situational awareness and field operation management tools to eligible U.S. military organizations. The goTenna Pro X Series TAK plugin supports critical, short-burst data communications for mapping, messaging, and personnel tracking in comms-denied environments.



goTenna Pro ¹⁷⁺

Tactical situational awareness

goTenna Inc.

Designed for iPad

★★★★★ 4.5 • 14 Ratings

Free

[View in Mac App Store ↗](#)

goTenna Pro

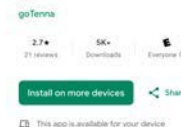

App support ▾

Download goTenna Pro App

From [Google Play](#) or [App Store](#)

goTenna Pro X Series devices pair with our native iOS/Android app for enhanced situational awareness in off-grid environments.

5. Begin Operations (cont.)

Step 3A: Pair goTenna TAK plugin with Pro-X2m

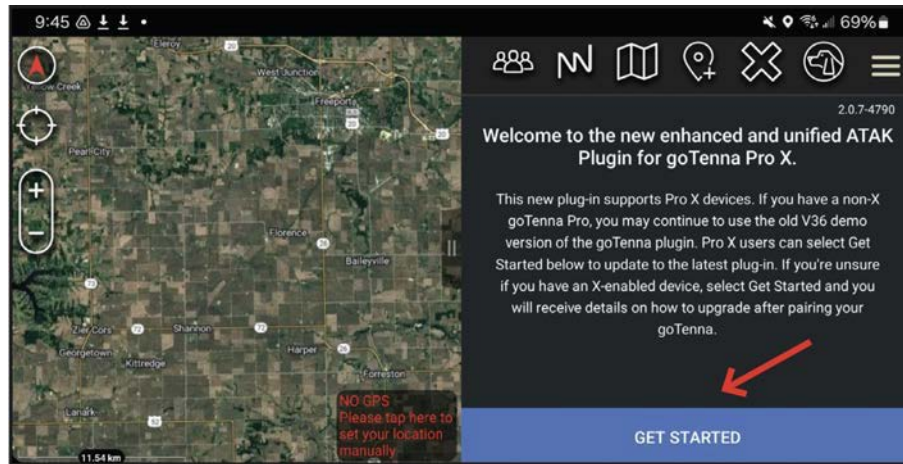

Get Started

When you first open the goTenna Plugin in ATAK, you'll be prompted to onboard your goTenna Pro X2 device and follow a quick tour of the available ATAK features.

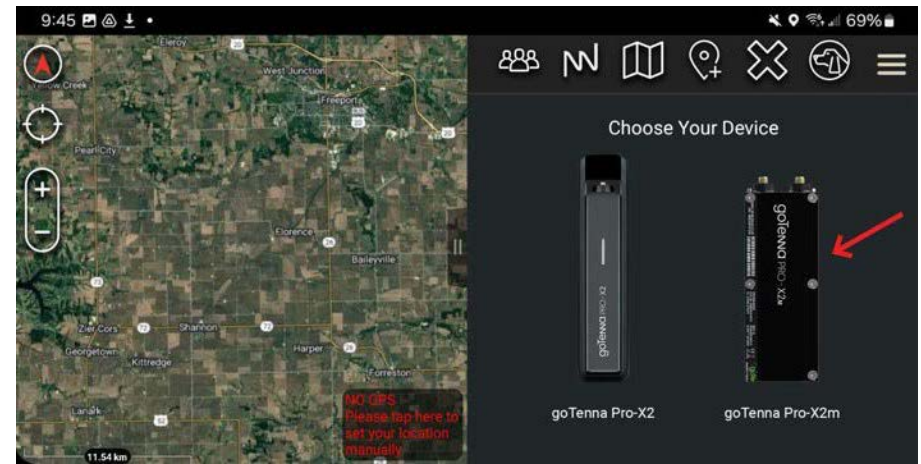

Select Device

Select the device you're using: **goTenna Pro-X2m**.

5. Begin Operations (cont.)

Step 3A: Pair goTenna TAK plugin with Pro-X2m (cont.)

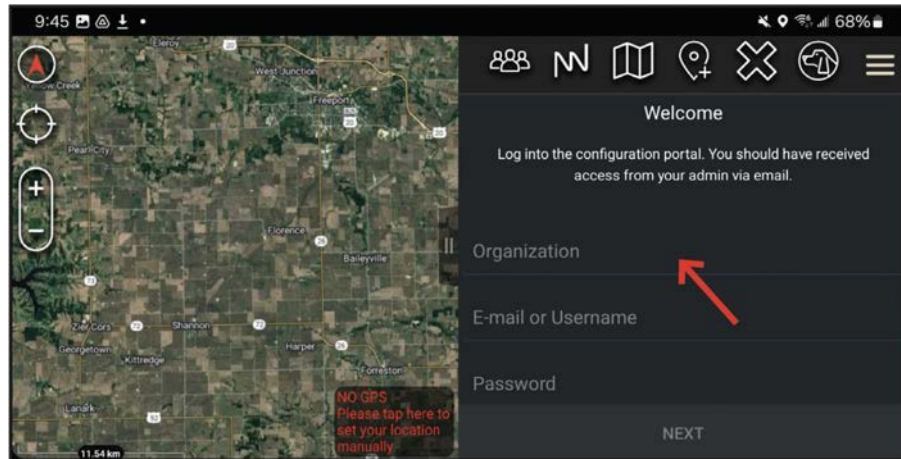

Login

Login to the goTenna Plugin using your Organization Name, Username, and Password. If you need login credentials, contact your organization administrator.

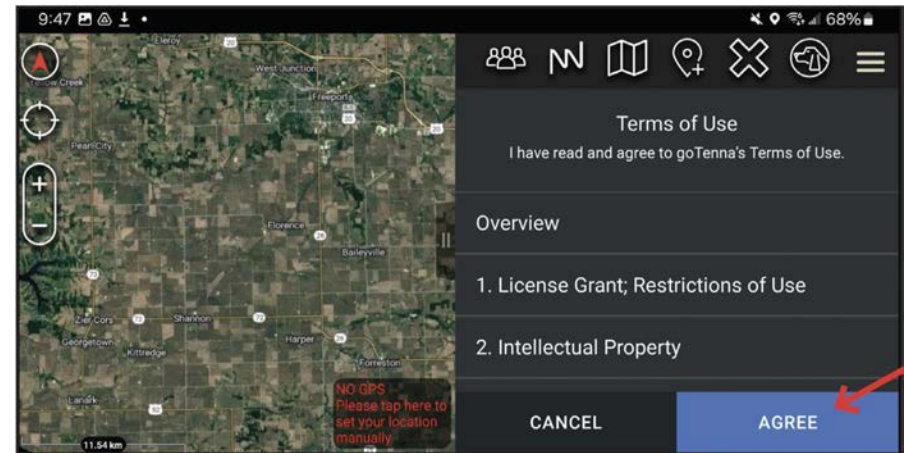

Terms of Use

Review and **AGREE** to the goTenna Pro-X & goTenna ATAK Plugin Terms of Use.

5. Begin Operations (cont.)

Step 3A: Pair goTenna TAK plugin with Pro-X2m (cont.)

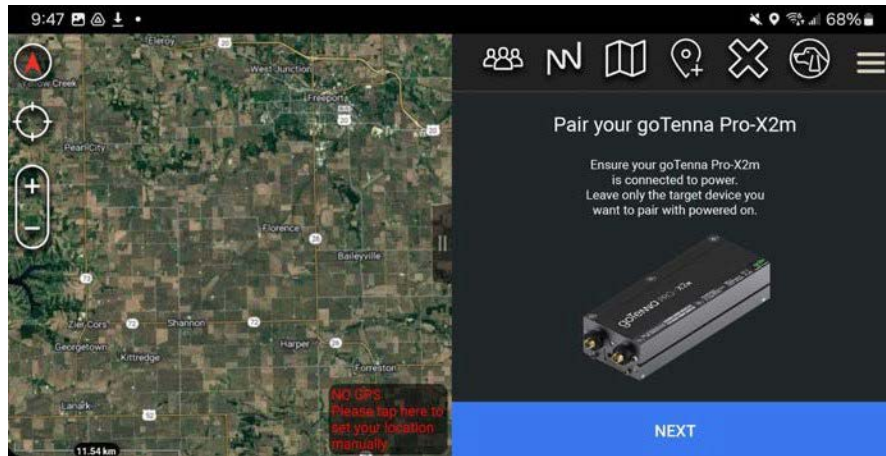

Pair Device

You'll now pair your goTenna Pro-X2m. Follow the on-screen instructions and tap **NEXT**. When your goTenna Pro-X2m is searching to pair, tap **PAIR**. Once you're paired, you'll move to the next step.

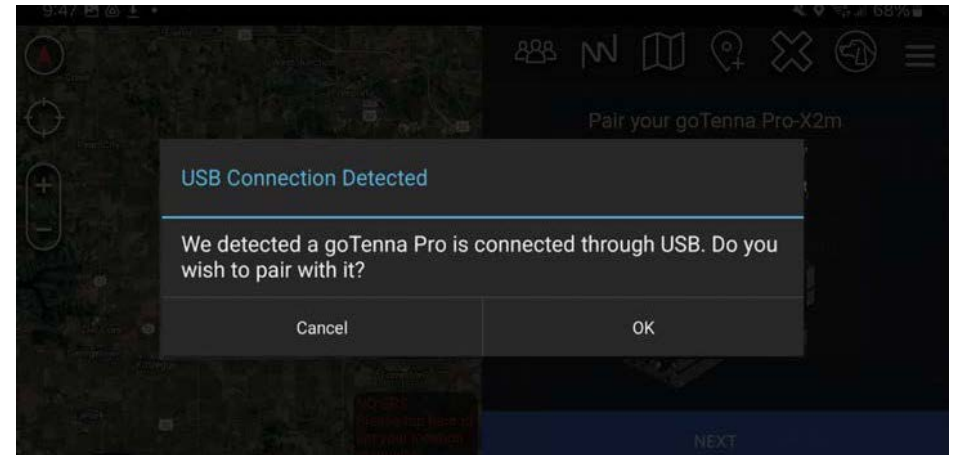

Pair Device (via USB)

If you have a wired USB connection you will see this dialog appear. Press OK.

5. Begin Operations (cont.)

Step 3A: Pair goTenna TAK plugin with Pro-X2m (cont.)

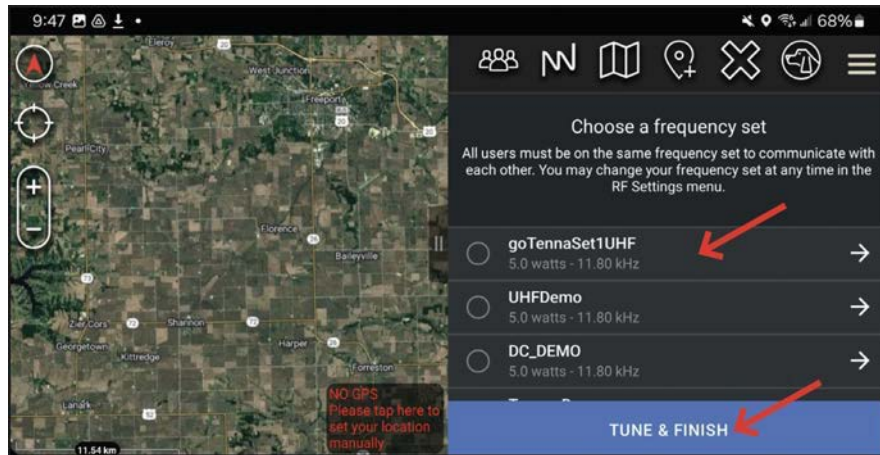

Select Frequency Set

Finally, you'll select the frequency set assigned. Your Admin will determine which frequency sets are available to you. If you're missing frequency sets, contact your goTenna Pro Admin user.

You're now able to explore the goTenna ATAK Plugin.

For goTenna TAK Plug-in troubleshooting or questions e-mail: prosupport@gotenna.com.

5. Begin Operations (cont.)

Step 3B: Pair goTenna Pro App with Pro-X2m

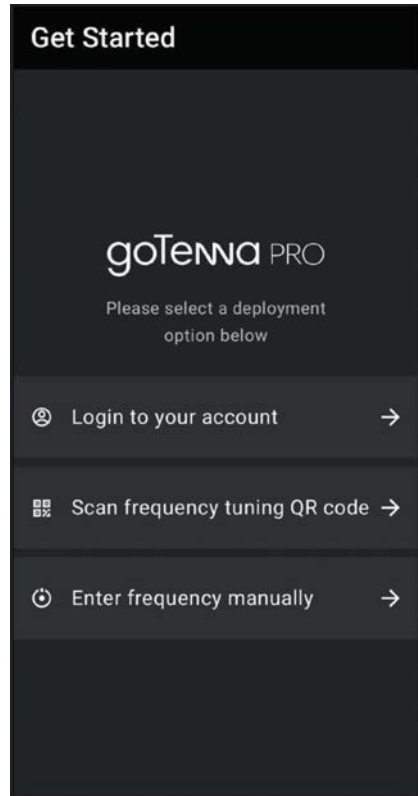

Get Started

To begin online setup, select **Login to your account**.

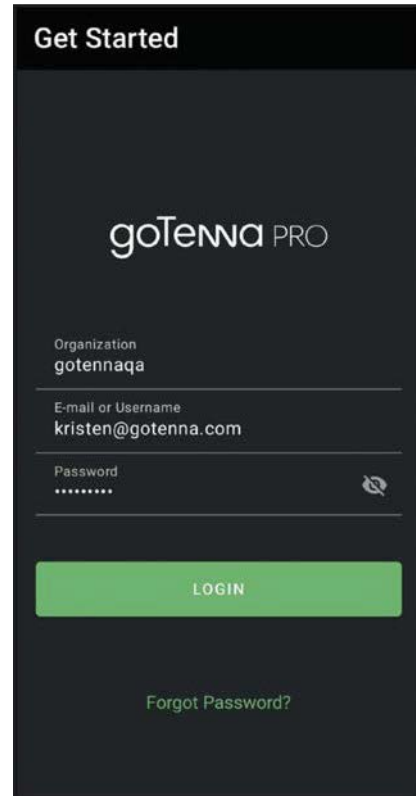

Login

To begin setup Login to the goTenna Pro App using your User Information.

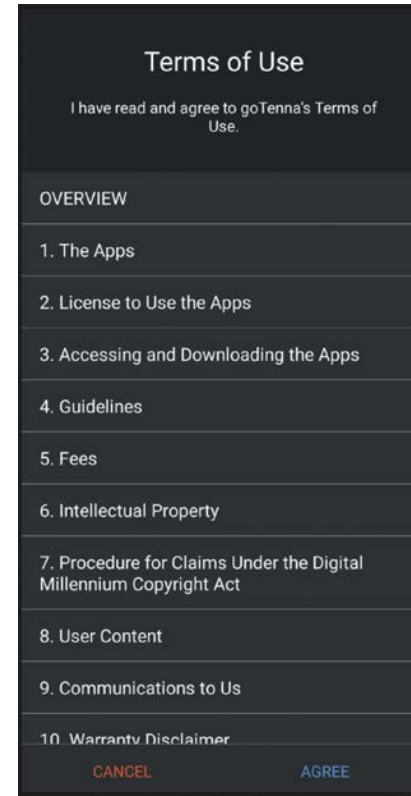

Terms of Use

Review and accept the Terms of Use by tapping **AGREE**.



Pair Device

Power on the goTenna Pro-X2m. Ensure only one Pro-X2m is on and all other devices are off. When the LED flashes, tap **PAIR**.

5. Begin Operations (cont.)

Step 3B: Pair goTenna Pro App with Pro-X2m (cont.)

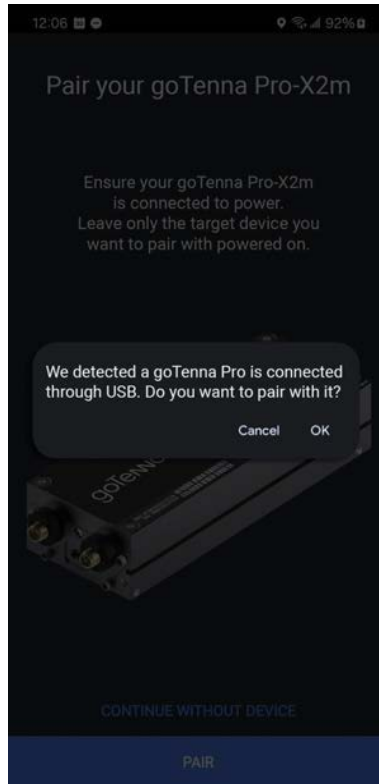

Pair Device (via USB)

If you have a wired USB connection you will see this dialog appear. Press **OK**.

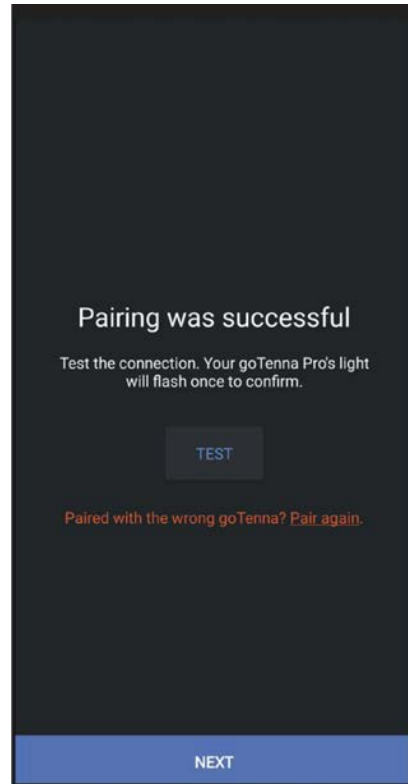

Pairing Successful

Once pairing is successful, tap **NEXT** to proceed.

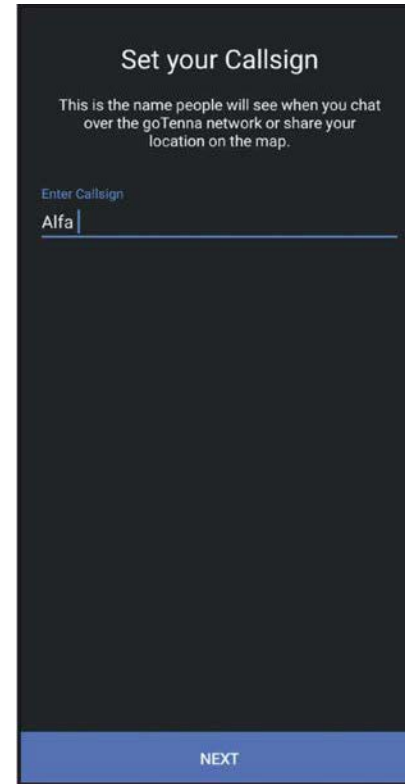

Set your Callsign

Your call sign will be the name associated with your user that will be used for display.

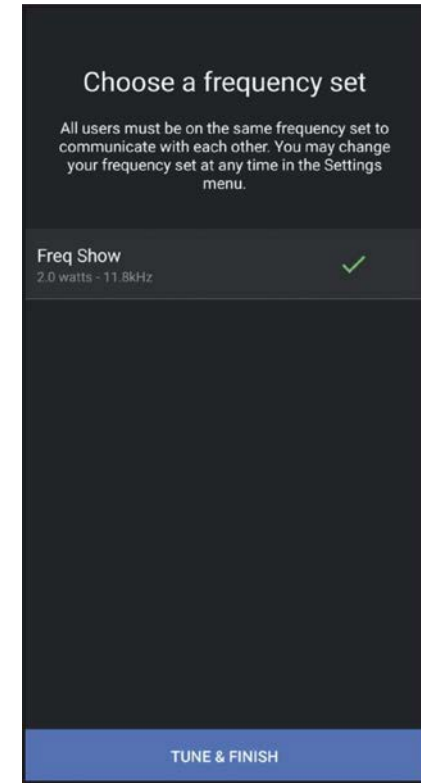

Choose Frequency Set

You'll be able to select a Frequency Set. Select your set then tap **TUNE & FINISH**.

6. Troubleshooting and Diagnostics

Intermittent Connectivity: Check seating and stability of data, control, and RF connections.

Thermal Overload: Monitor temperature indicators; ensure no excess heat build-up during testing.

7. RF Transmission and Operational Compliance

FCC Compliance

Note: Note: This radio is intended for use in occupational/controlled conditions where users have full knowledge of their exposure and can exercise control over their exposure to meet the occupational limits in FCC standards. This radio device is NOT authorized for general population consumer use.

PRO X2M is only FCC authorized for the specific rule parts listed on the FCC grant, the host product manufacturer is responsible for compliance to any other FCC rules that apply to the host not covered by the modular transmitter grant of certification. Any modifications could void the user's authority to operate the equipment.

Pro-X2m FCC ID - 2ABVK373373; IC ID 21842-373373. The grantee is not responsible for any changes or modifications not expressly approved by the party responsible for compliance.

PRO X2m can only be used in a host for the conditions that it was granted for. To be used in any other way than granted, requires additional evaluation, testing and Class 2 permissive change.

A host manufacturer is recommended to use FCC OEM D04 Module Integration Guide recommending as "best practice" RF design engineering testing and evaluation.

The Pro-X2m complies with part 15 of the FCC rules. Operation is subject to the following two conditions: (1) this device may not cause harmful interference, and (2) this device must accept any interference received, including interference that may cause undesired operation. The final host product still requires Part 15 Subpart B compliance testing with the modular transmitter installed.

- FCC RF Transmission Safety Standoff distance 20cm
- ISED RF Transmission Safety Standoff distance 22cm.

Compatible Bluetooth, VHF/UHF antennas: monopole, dipole, patch or yagi types, fifty-ohm impedance, RP-SMA connector.

Bluetooth antennas must not exceed 6dBi to comply with U.S. FCC part 15 rules or Canada Innovation Science and Economic Development, Radio Standards Specifications (RSS).

VHF/UHF antennas must not exceed 6dBi to comply with U.S. FCC part 90 radio exposure standards or Canada Innovation Science and Economic Development, Radio Standards Specifications (RSS).

For questions and support please contact prosupport@gotenna.com.

