



**FCC 47 CFR PART 15 SUBPART C AND ANSI C63.10:2009
TEST REPORT**

For

Panel PC

Model : VM-521

Trade Name : RuggON

Issued for

RuggON Corporation

**3F., No.10, Ln. 181, Sec. 2, Jiuzong Rd., Neihu Dist., Taipei City 114, Taiwan
(R.O.C.)**

Issued by

**Compliance Certification Services Inc.
Hsinchu Lab.**

**NO. 989-1 Wen Shan Rd., Shang Shan Village,
Qionglin Shiang Hsinchu County 30741, Taiwan, R.O.C**

TEL: +886-3-5921698

FAX: +886-3-5921108

<http://www.ccsrf.com>

E-Mail : service@ccsrf.com

Issued Date: December 05, 2014



Note: This report shall not be reproduced except in full, without the written approval of Compliance Certification Services Inc. This document may be altered or revised by Compliance Certification Services Inc. personnel only, and shall be noted in the revision section of the document. The client should not use it to claim product endorsement by TAF or any government agencies. The test results of this report relate only to the tested sample identified in this report.



Revision History

Rev.	Issue Date	Revisions	Effect Page	Revised By
00	12/05/2014	Initial Issue	All Page 91	Michelle Chiu



TABLE OF CONTENTS

TITLE	PAGE NO.
1. TEST REPORT CERTIFICATION	4
2. EUT DESCRIPTION	5
3. DESCRIPTION OF TEST MODES	6
4. TEST METHODOLOGY	8
5. FACILITIES AND ACCREDITATION	8
5.1 FACILITIES	8
5.2 ACCREDITATIONS.....	8
5.3 MEASUREMENT UNCERTAINTY	9
6. SETUP OF EQUIPMENT UNDER TEST.....	10
7. FCC PART 15.247 REQUIREMENTS	11
7.1 20dB BANDWIDTH FOR HOPPING	11
7.2 MAXIMUM PEAK OUTPUT POWER	17
7.3 AVERAGE POWER	19
7.4 HOPPING CHANNEL SEPARATION.....	21
7.5 NUMBER OF HOPPING FREQUENCY USED	27
7.6 DWELL TIME ON EACH CHANNEL.....	30
7.7 CONDUCTED SPURIOUS EMISSION	45
7.8 RADIATED EMISSION.....	53
7.9 CONDUCTED EMISSION.....	87
APPENDIX SETUP PHOTOS	90



1. TEST REPORT CERTIFICATION

Applicant : RuggON Corporation
Address : 3F., No.10, Ln. 181, Sec. 2, Jiuzong Rd., Neihu Dist., Taipei
City 114, Taiwan (R.O.C.)
Equipment Under Test : Panel PC
Model : VM-521
Trade Name : RuggON
Tested Date : September 01 ~ November 25, 2014

APPLICABLE STANDARD	
Standard	Test Result
FCC Part 15 Subpart C AND ANSI C63.10:2009	PASS

WE HEREBY CERTIFY THAT: The above equipment has been tested by Compliance Certification Services Inc., and found compliance with the requirements set forth in the technical standards mentioned above. The results of testing in this report apply only to the product/system, which was tested. Other similar equipment will not necessarily produce the same results due to production tolerance and measurement uncertainties.

Approved by:

Reviewed by:

Sb. Lu
Sr. Engineer

Gundam Lin
Sr. Engineer



2. EUT DESCRIPTION

Product Name	Panel PC
Model Number	VM-521
Identify Number	T140901D03
Received Date	September 01, 2014
Frequency Range	2402MHz to 2480MHz $f = 2402 + n\text{MHz}$, $n = 0, \dots, 78$
Transmit Power	6.71 dBm (0.0047W)
Channel Spacing	1MHz
Channel Number	79 Channels
Transmit Data Rate	GFSK (1Mbps), $\pi/4$ -DQPSK (2Mbps), 8-DPSK (3Mbps)
Type of Modulation	Frequency Hopping Spread Spectrum
Antenna Type	Dipole Antenna $\times 2$ (External), Antenna 1(Chain A), Antenna Gain : 5 dBi Antenna 2(Chain B), Antenna Gain : 5 dBi PIFA Antenna $\times 2$ (Internal), Antenna 1(Chain A), Antenna Gain : 3.17 dBi Antenna 2(Chain B), Antenna Gain : 3.21 dBi
Power Rating	24Vdc / 48Vdc 7.5Vdc from Battery
Test Voltage	120Vac, 60Hz
DC Power Cable Type	Shielded cable, 3.1 m \times 1 (Detachable)
I/O Port	Audio In Port $\times 1$, Audio Out Port $\times 1$, RJ-45 Port $\times 2$, USB(RS232) Port $\times 1$, Expansion Port $\times 1$, Canbus Port $\times 2$, COM Port $\times 2$, DIO Port $\times 1$, Power Port $\times 1$

Remark :

1. The sample selected for test was engineering sample that approximated to production product and was provided by manufacturer.
2. For more details, please refer to the User's manual of the EUT.
3. This submittal(s) (test report) is intended for FCC ID: 2ABTU-VM-521 filing to comply with Section 15.207, 15.209 and 15.247 of the FCC Part 15, Subpart C Rules.



3. DESCRIPTION OF TEST MODES

The EUT (Panel PC) had been tested under operating condition.

For Bluetooth : Chain B (Ant 2)transmit/receive.

No.	Antenna Position	Antenna Type	Antenna Gain (dBi)		Test item	
			1	2	Spurious emissions	Conducted
2	Internal	PIFA	3.17	3.21	V	

There are three channels have been tested as following :

Channel	Frequency (MHz)
Low	2402
Middle	2441
High	2480

Conducted Emission / Radiated Emission Test (Below 1 GHz)

1. The following test modes were scanned during the preliminary test:

No.	Pre-Test Mode
1	TX Mode / External Antenna
2	TX Mode / Internal Antenna

2. After the preliminary scan, the following test mode was found to produce the highest emission level.

Final Test Mode		
Emission	Radiated Emission	TX Mode / External Antenna TX Mode / Internal Antenna
	Conducted Emission	TX Mode / External Antenna

Remark : Then, the above highest emission mode of the configuration of the EUT and cable was chosen for all final test items.



Radiated Emission Test (Above 1 GHz):

Pre-Scan has been conducted to determine the worst-case mode from all possible combinations between available modulations, data rates and antenna ports (if EUT with antenna diversity architecture).

Following channel(s) was (were) selected for the final test as listed below.

Tested Channel	Modulation Technology	Modulation Type	Packet Type
Low, Mid, High	FHSS	GFSK	DH5
Low, Mid, High	FHSS	8-DPSK	3-DH5

Bandedge Measurement :

Pre-Scan has been conducted to determine the worst-case mode from all possible combinations between available modulations, data rates and antenna ports (if EUT with antenna diversity architecture).

Following channel(s) was (were) selected for the final test as listed below.

Tested Channel	Modulation Technology	Modulation Type	Packet Type
Low, High	FHSS	GFSK	DH5
Low, High	FHSS	8-DPSK	3-DH5

Antenna Port Conducted Measurement :

Pre-Scan has been conducted to determine the worst-case mode from all possible combinations between available modulations, data rates and antenna ports (if EUT with antenna diversity architecture).

Following channel(s) was (were) selected for the final test as listed below.

Tested Channel	Modulation Technology	Modulation Type	Packet Type
Low, Mid, High	FHSS	GFSK	DH5
Low, Mid, High	FHSS	8-DPSK	3-DH5



4. TEST METHODOLOGY

The tests documented in this report were performed in accordance with ANSI C63.10: 2009 and FCC CFR 47, 15.207, 15.209 and 15.247.

5. FACILITIES AND ACCREDITATION

5.1 FACILITIES

All measurement facilities used to collect the measurement data are located at

NO. 989-1 Wen Shan Rd., Shang Shan Village,
Qionglin Shiang Hsinchu County 30741, Taiwan, R.O.C

The sites are constructed in conformance with the requirements of ANSI C63.10:2009 and CISPR 22. All receiving equipment conforms to CISPR 16-1-1, CISPR 16-1-2, CISPR 16-1-3, CISPR 16-1-4, CISPR 16-1-5.

5.2 ACCREDITATIONS

Our laboratories are accredited and approved by the following approval agencies according to ISO/IEC 17025.

Taiwan	TAF
---------------	-----

The measuring facility of laboratories has been authorized or registered by the following approval agencies.

Canada	INDUSTRY CANADA
Japan	VCCI
Taiwan	BSMI
USA	FCC MRA

Copies of granted accreditation certificates are available for downloading from our web site, <http://www.ccsrf.com>

Remark: FCC Designation Number TW1027.



5.3 MEASUREMENT UNCERTAINTY

The following table is for the measurement uncertainty, which is calculated as per the document CISPR 16-4-2.

PARAMETER	UNCERTAINTY
Semi Anechoic Chamber (966 Chamber_B) / Radiated Emission, 30 to 1000 MHz	+/- 3.97
Semi Anechoic Chamber (966 Chamber_B) / Radiated Emission, 1 to 18GHz	+/- 3.58
Semi Anechoic Chamber (966 Chamber_B) / Radiated Emission, 18 to 26 GHz	+/- 3.59
Semi Anechoic Chamber (966 Chamber_B) / Radiated Emission, 26 to 40 GHz	+/- 3.81
Conducted Emission (Mains Terminals), 9kHz to 30MHz	+/- 2.48

This uncertainty represents an expanded uncertainty expressed at approximately the 95% confidence level using a coverage factor of $k=2$.

Consistent with industry standard (e.g. CISPR 22, clause 11, Measurement Uncertainty) determining compliance with the limits shall be base on the results of the compliance measurement. Consequently the measure emissions being less than the maximum allowed emission result in this be a compliant test or passing test.

The acceptable measurement uncertainty value without requiring revision of the compliance statement is base on conducted and radiated emissions being less than U_{CISPR} which is 3.6dB and 5.2dB respectively. CCS values (called U_{Lab} in CISPR 16-4-2) is less than U_{CISPR} as shown in the table above. Therefore, MU need not be considered for compliance.



6. SETUP OF EQUIPMENT UNDER TEST

SUPPORT EQUIPMENT

No.	Product	Manufacturer	Model No.	Serial No.
1	Notebook PC	HP	ProBook 4421s	CNF03242PJ

Power Adapter :

No.	Manufacturer	Model No.	Power Input	Power Output
1	DELTA	ADP-60DH REV.B	100-240Vac, 1.5A, 50-60Hz	19Vdc 3.16A

No.	Signal Cable Description
1	Non-shielded RJ-45 cable, 12m x 1
2	Non-shielded AC power cable, 1.8m x 1

SETUP DIAGRAM FOR TESTS

EUT & peripherals setup diagram is shown in appendix setup photos.

EUT OPERATING CONDITION

1. EUT & peripherals setup diagram is shown in appendix setup photos.
2. Run "DRTU" Software to test
3. TX mode(GFSK)
 - Continue TX
 - LO Freq: 2402, 2441, 2480
 - Power set: 9
 - DataRate: DH5
 - TX mode (8-DPSK)
 - Continue TX
 - LO Freq: 2402, 2441, 2480
 - Power set: 1
 - DataRate: 3DH5
6. All of the functions are under run
7. Start test.



7. FCC PART 15.247 REQUIREMENTS

7.1 20dB BANDWIDTH FOR HOPPING

LIMITS

Limit : N/A

TEST EQUIPMENT

Name of Equipment	Manufacturer	Model	Serial Number	Calibration Due
Spectrum Analyzer	Agilent	E4446A	MY43360132	06/10/2015

Remark: Each piece of equipment is scheduled for calibration once a year.

TEST SETUP

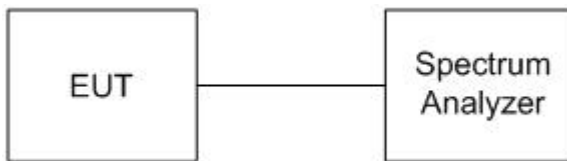

TEST PROCEDURE

1. The 20dB band width was measured with a spectrum analyzer connected to RF antenna connector(conducted measurement) while EUT was operating in transmit mode at the appropriate center frequency. The analyzer center frequency was set to the EUT carrier frequency, using the analyzer. Display Line and Marker Delta functions, the 20dB band width of the emission was determined.
2. Span = approximately 2 to 3 times the 20 dB bandwidth, centered on a hopping channel.
3. RBW \geq 1% of the 20 dB bandwidth.
4. VBW \geq RBW.
5. Sweep = auto.



TEST RESULTS

Modulation Type: GFSK, CFG PKT Packet Type: 15 Packet Size: 339 (DH5)

Channel	Channel Frequency (MHz)	20dB Bandwidth (MHz)	Result
Low	2402	0.9223	N/A
Middle	2441	0.9223	N/A
High	2480	0.9286	N/A

Modulation Type: 8-DPSK, CFG PKT Packet Type: 31 Packet Size: 1021 (3-DH5)

Channel	Channel Frequency (MHz)	20dB Bandwidth (MHz)	Result
Low	2402	1.4868	N/A
Middle	2441	1.4868	N/A
High	2480	1.4905	N/A



20dB BANDWIDTH

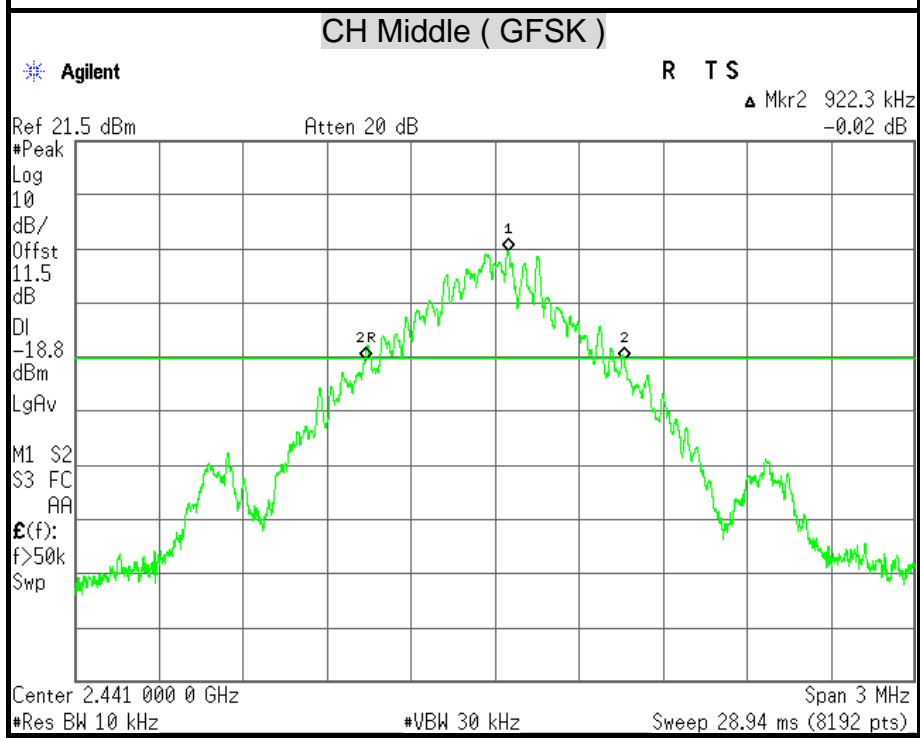
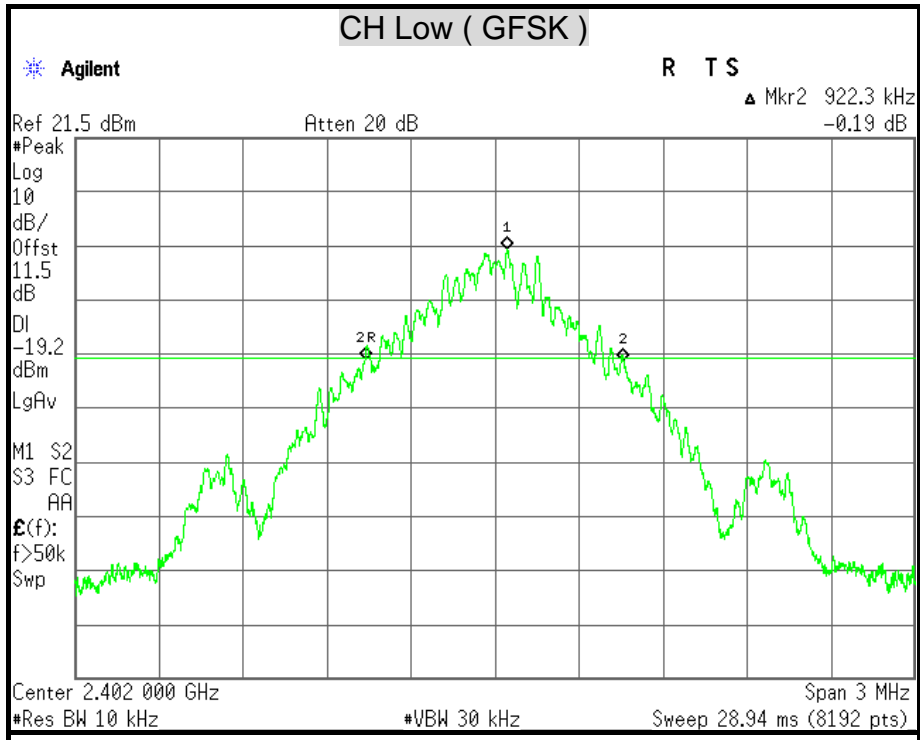

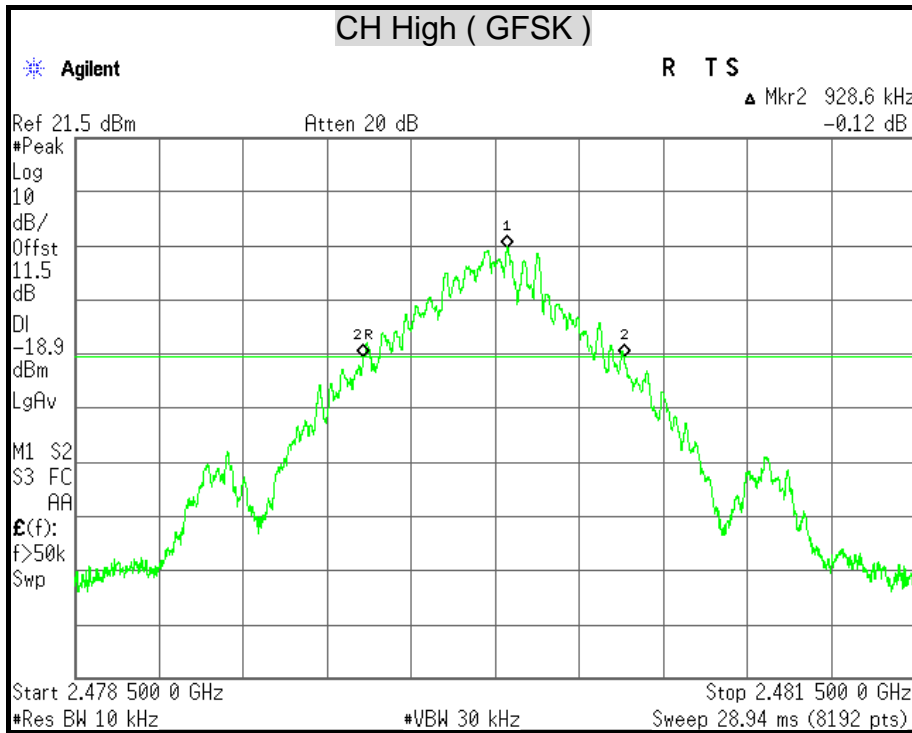

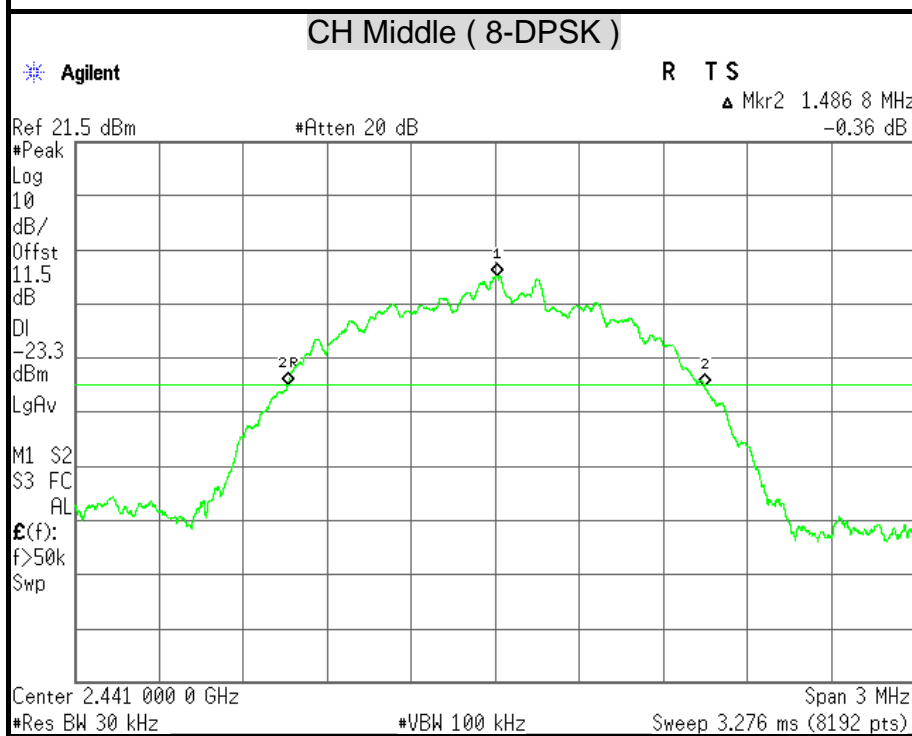
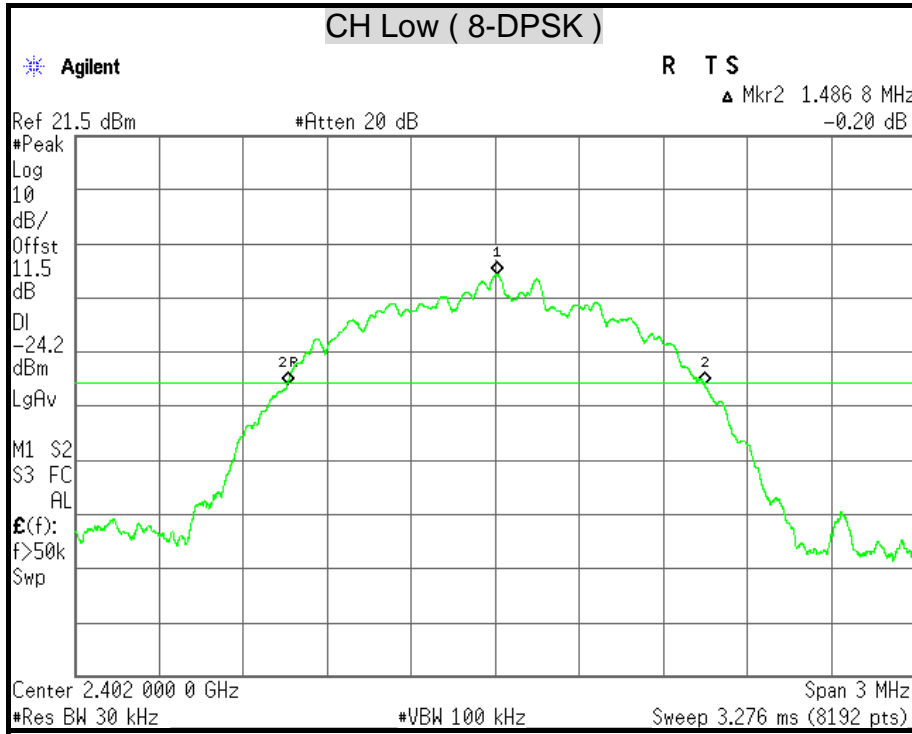

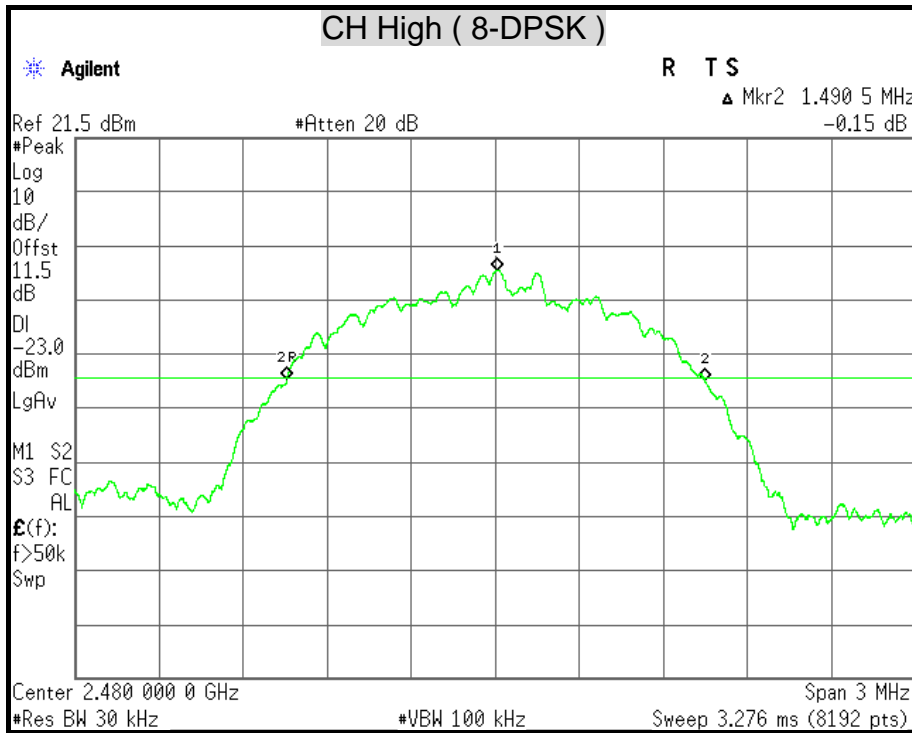



7.2 MAXIMUM PEAK OUTPUT POWER

LIMITS

§15.247(b)(1) For frequency hopping systems operating in the 2400-2483.5 MHz band employing at least 75 non-overlapping hopping channels, and all frequency hopping systems in the 5725-5850 MHz band: 1 watt. For all other frequency hopping systems in the 2400-2483.5 MHz band: 0.125 watts.

TEST EQUIPMENT

Name of Equipment	Manufacturer	Model	Serial Number	Calibration Due
Power Meter	Anritsu	ML2495A	1149001	12/06/2014
Power Sensor	Anritsu	MA2411B	1126148	12/06/2014

Remark: Each piece of equipment is scheduled for calibration once a year.

TEST SETUP



TEST PROCEDURE

The transmitter output is connected to the power meter. The power meter is set to the peak power detection.



TEST RESULTS

Modulation Type: GFSK ,CFG PKT Packet Type: 15 Packet Size: 339 (DH5)

Channel	Channel Frequency (MHz)	Peak Power		Peak Power Limit		Result
		(dBm)	(W)	(dBm)	(W)	
Low	2402	6.33	0.0043	20.97	0.125	PASS
Middle	2441	6.65	0.0046	20.97	0.125	PASS
High	2480	6.71	0.0047	20.97	0.125	PASS

Remark: The cable assembly insertion loss of 11.5 dB (including 10 dB pad and 1.5 dB cable) was Entered as an offset in the power meter to allow for direct reading of power.

Modulation Type: 8-DPSK ,CFG PKT Packet Type: 31 Packet Size: 1021 (3-DH5)

Channel	Channel Frequency (MHz)	Peak Power		Peak Power Limit		Result
		(dBm)	(W)	(dBm)	(W)	
Low	2402	0.63	0.0012	20.97	0.125	PASS
Middle	2441	1.51	0.0014	20.97	0.125	PASS
High	2480	1.72	0.0015	20.97	0.125	PASS

Remark: The cable assembly insertion loss of 11.5 dB (including 10 dB pad and 1.5 dB cable) was Entered as an offset in the power meter to allow for direct reading of power.



7.3 AVERAGE POWER

LIMITS

None; for reporting purposes only.

TEST EQUIPMENT

Name of Equipment	Manufacturer	Model	Serial Number	Calibration Due
Power Meter	ANRITSU	ML2495A	1149001	12/06/2014
Power Sensor	ANRITSU	MA2411B	1126148	12/06/2014

Remark: Each piece of equipment is scheduled for calibration once a year.

TEST SETUP



TEST PROCEDURE

The transmitter output is connected to the power meter. The power meter is set to the average power detection.



TEST RESULTS

Modulation Type: GFSK ,CFG PKT Packet Type: 15 Packet Size: 339 (DH5)

Channel	Channel Frequency (MHz)	Average Power (dBm)
Low	2402	6.24
Middle	2441	6.56
High	2480	6.62

Remark: The cable assembly insertion loss of 11.5 dB (including 10 dB pad and 1.5 dB cable) was Entered as an offset in the power meter to allow for direct reading of power.

Modulation Type: 8-DPSK ,CFG PKT Packet Type: 31 Packet Size: 1021 (3-DH5)

Channel	Channel Frequency (MHz)	Average Power (dBm)
Low	2402	-1.93
Middle	2441	-0.99
High	2480	-0.75

Remark: The cable assembly insertion loss of 11.5 dB (including 10 dB pad and 1.5 dB cable) was Entered as an offset in the power meter to allow for direct reading of power.



7.4 HOPPING CHANNEL SEPARATION

LIMITS

§15.247(a)(1) Frequency hopping systems shall have hopping channel carrier frequencies separated by a minimum of 25 kHz or the 20 dB bandwidth of the hopping channel, whichever is greater. Alternatively, frequency hopping systems operating in the 2400-2483.5 MHz band may have hopping channel carrier frequencies that are separated by 25 kHz or two-thirds of the 20 dB bandwidth of the hopping channel, whichever is greater, provided the systems operate with an output power no greater than 125 mW. The system shall hop to channel frequencies that are selected at the system hopping rate from a pseudorandomly ordered list of hopping frequencies. Each frequency must be used equally on the average by each transmitter. The system receivers shall have input bandwidths that match the hopping channel bandwidths of their corresponding transmitters and shall shift frequencies in synchronization with the transmitted signals.

TEST EQUIPMENT

Name of Equipment	Manufacturer	Model	Serial Number	Calibration Due
Spectrum Analyzer	Agilent	E4446A	MY43360132	06/10/2015

Remark: Each piece of equipment is scheduled for calibration once a year.

TEST SETUP

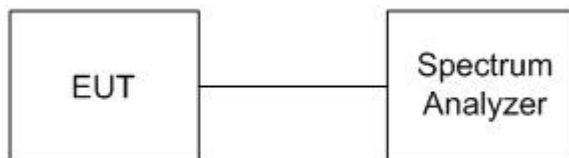

TEST PROCEDURE

1. Check the calibration of the measuring instrument using either an internal calibrator or a known signal from an external generator.
2. Position the EUT as shown in test setup without connection to measurement instrument. Turn on the EUT and connect it to measurement instrument. Then set it to any one convenient frequency within its operating range.
3. By using the MaxHold function record the separation of adjacent channels.
4. Measure the frequency difference of these two adjacent channels by spectrum analyzer MARK function. And then plot the result on spectrum analyzer screen.
5. Span = wide enough to capture the peaks of two adjacent channels.
6. Resolution (or IF) Bandwidth (RBW) \geq 1% of the span.
7. Video (or Average) Bandwidth (VBW) \geq RBW.
8. Sweep = auto.
9. Repeat above procedures until all frequencies measured were complete.



TEST RESULTS

Refer to section 7.1, 20dB bandwidth measurement, the measured channel separation should be greater than two-third of 20dB bandwidth or Minimum bandwidth.

Modulation Type: GFSK, CFG PKT Packet Type: 15 Packet Size: 339 (DH5)

Channel	Channel Frequency (MHz)	Adjacent Hopping Channel Separation (kHz)	Two –third of 20dB bandwidth (kHz)	Minimum Bandwidth	Result
Low	2402	1000	614.87	25 kHz	PASS
Middle	2441	1000	614.87	25 kHz	PASS
High	2480	1000	619.07	25 kHz	PASS

Modulation Type: 8-DPSK, CFG PKT Packet Type: 31 Packet Size: 1021 (3-DH5)

Channel	Channel Frequency (MHz)	Adjacent Hopping Channel Separation (kHz)	Two –third of 20dB bandwidth (kHz)	Minimum Bandwidth	Result
Low	2402	1000	991.20	25 kHz	PASS
Middle	2441	1000	991.20	25 kHz	PASS
High	2480	1000	993.67	25 kHz	PASS



HOPPING CHANNEL SEPARATION

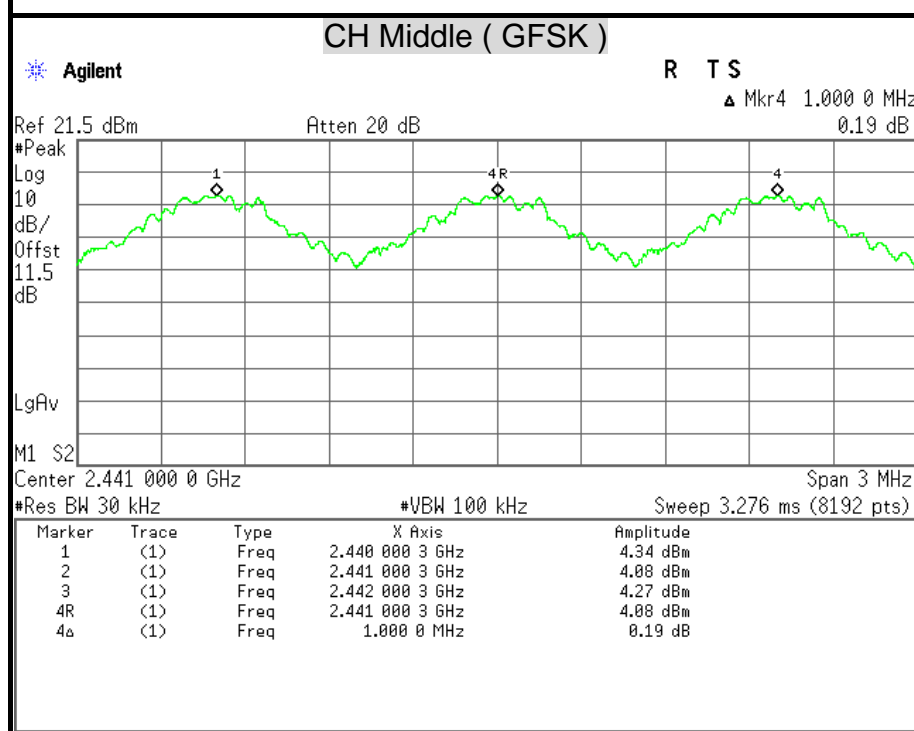
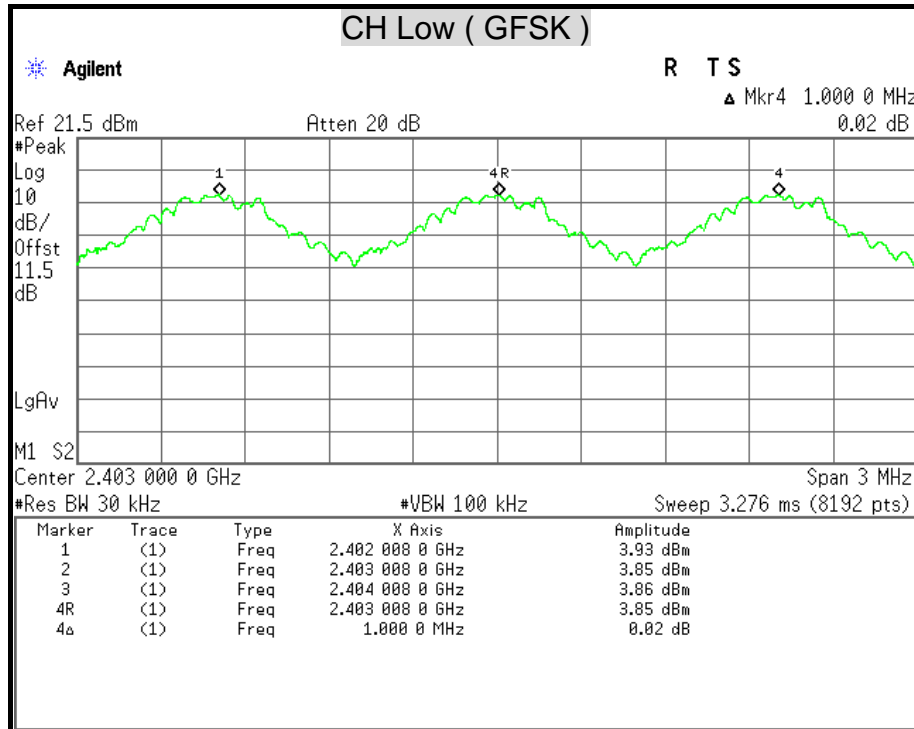

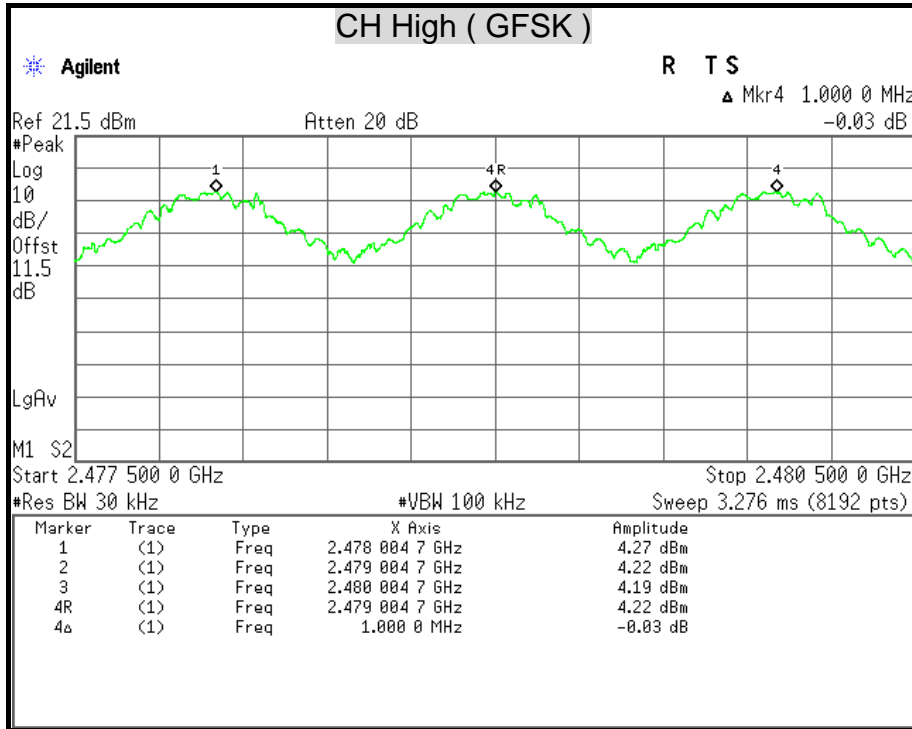

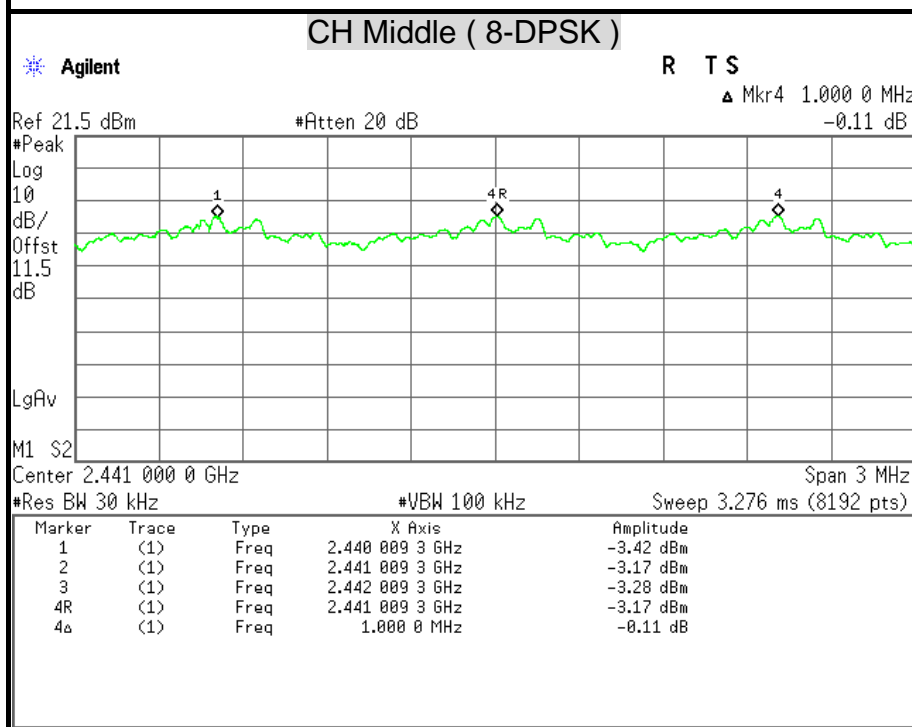
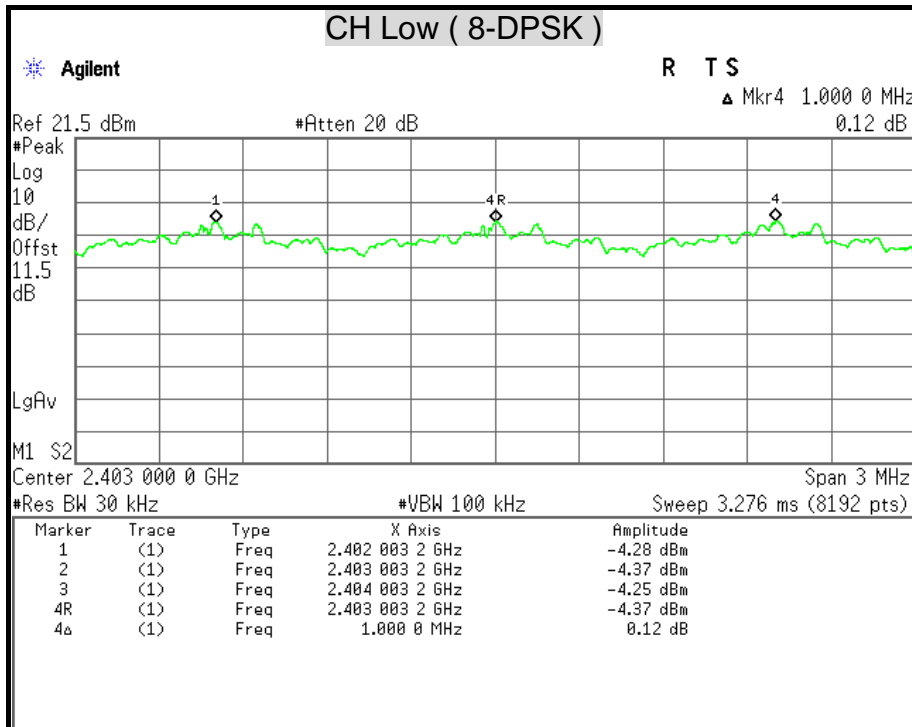

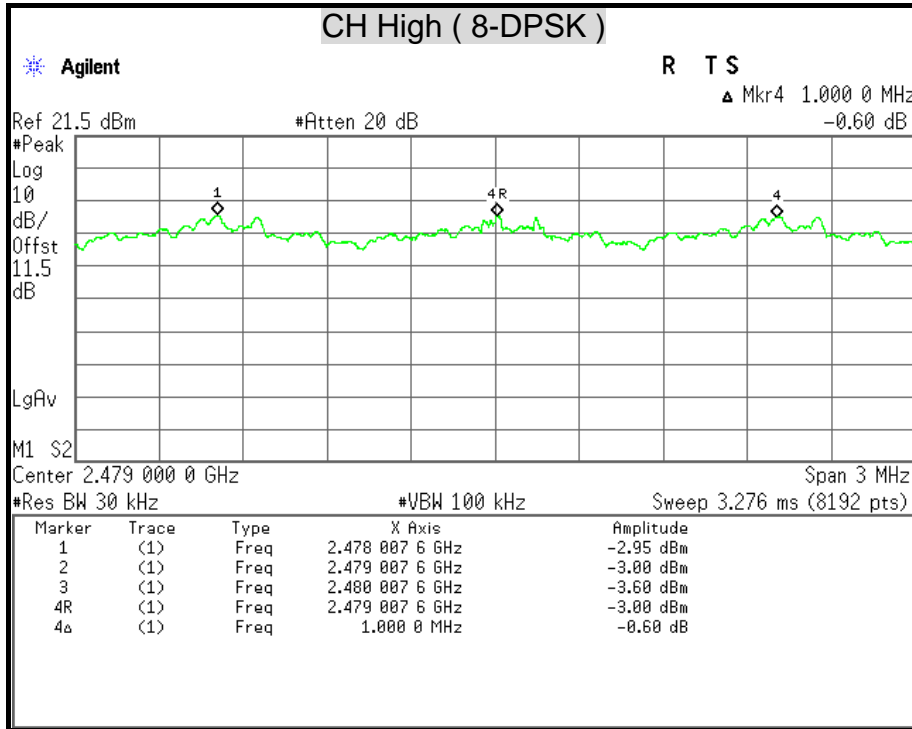



7.5 NUMBER OF HOPPING FREQUENCY USED

LIMITS

§15.247(a)(1)(iii) For frequency hopping systems in the 2400-2483.5 MHz band shall use at least 15 channels.

TEST EQUIPMENT

Name of Equipment	Manufacturer	Model	Serial Number	Calibration Due
Spectrum Analyzer	Agilent	E4446A	MY43360132	06/10/2015

Remark: Each piece of equipment is scheduled for calibration once a year.

TEST SETUP



TEST PROCEDURE

1. Check the calibration of the measuring instrument (spectrum analyzer) using either an internal calibrator or a known signal from an external generator.
2. Position the EUT as shown in test setup without connection to measurement instrument. Turn on the EUT and connect its antenna terminal to measurement instrument via a low loss cable. Then set it to any one measured frequency within its operating range and make sure the instrument is operated in its linear range.
3. Set the spectrum analyzer on MaxHold Mode, and then keep the EUT in hopping mode. Record all the signals from each channel until each one has been recorded.
4. Set the spectrum analyzer on View mode and then plot the result on spectrum analyzer screen.
5. Span = the frequency band of operation.
6. RBW \geq 1% of the span.
7. VBW \geq RBW.
8. Sweep = auto.
9. Repeat above procedures until all frequencies measured were complete.

TEST RESULTS

Refer to the attached plot.
There are 79 hopping frequencies in a hopping sequence.



NUMBER OF HOPPING FREQUENCY USED

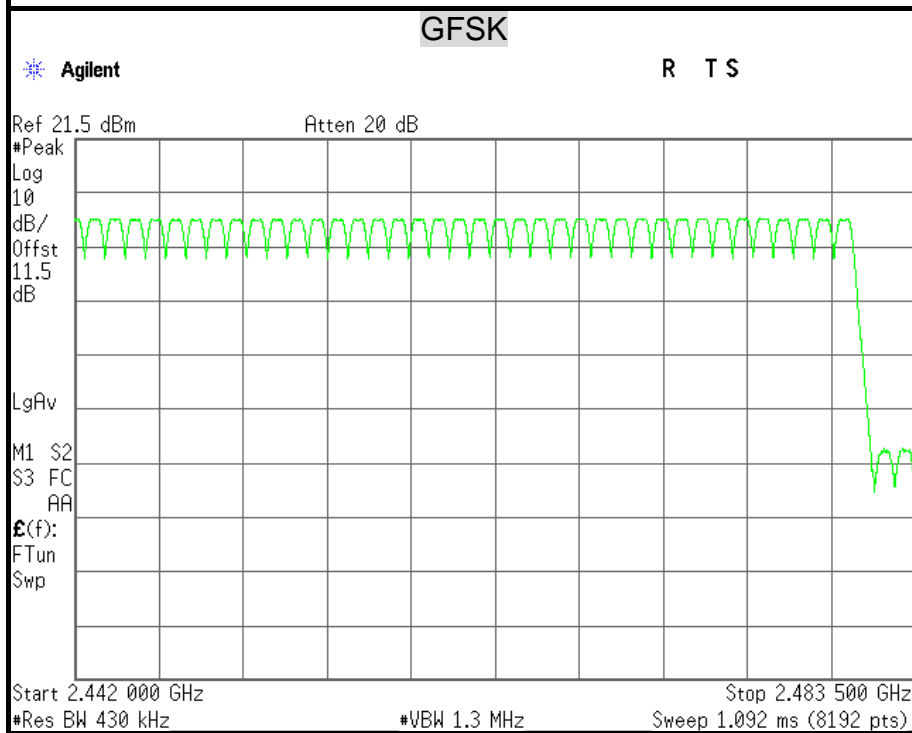
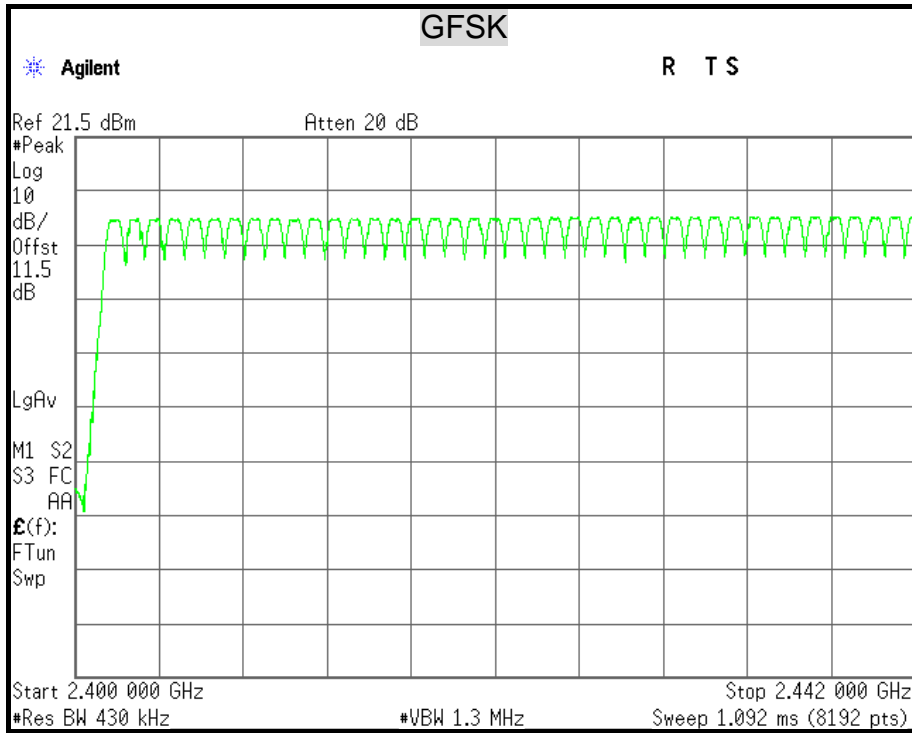

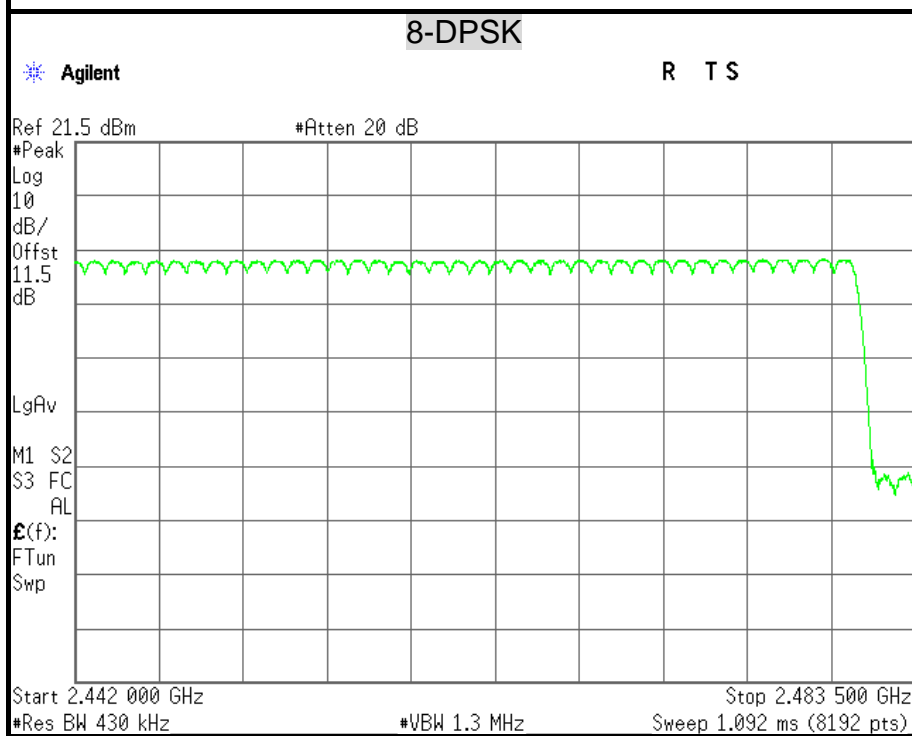
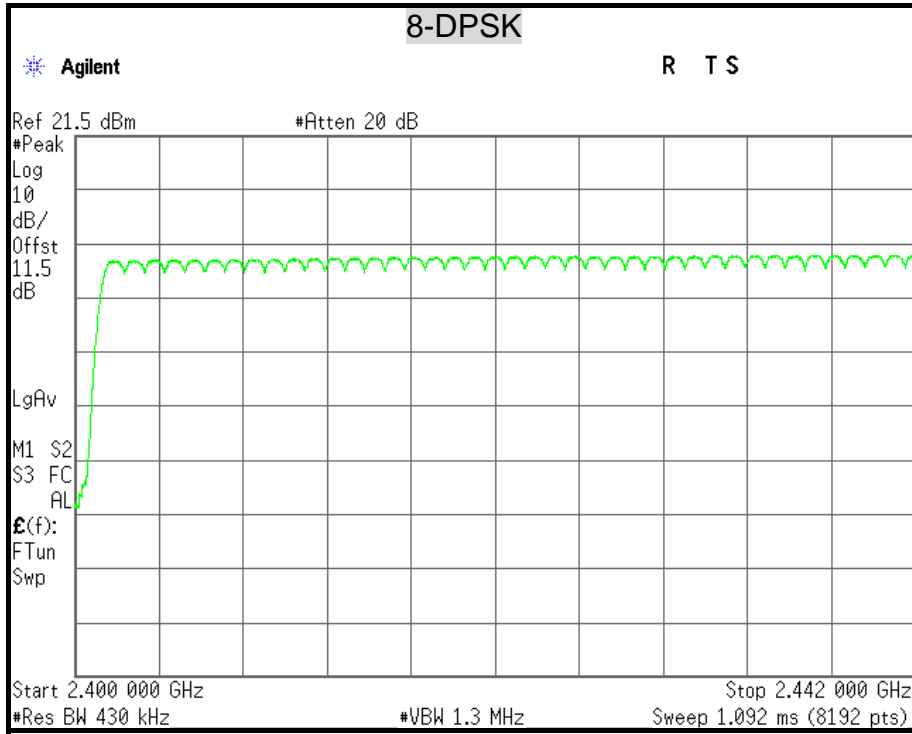



7.6 DWELL TIME ON EACH CHANNEL

LIMITS

§15.247(a)(1)(iii) For frequency hopping system operating in the 2400-2483.5MHz band, the average time of occupancy on any frequency shall not be greater than 0.4 second within a 31.6 second period.

TEST EQUIPMENT

Name of Equipment	Manufacturer	Model	Serial Number	Calibration Due
Spectrum Analyzer	Agilent	E4446A	MY43360132	06/10/2015

Remark: Each piece of equipment is scheduled for calibration once a year.

TEST SETUP

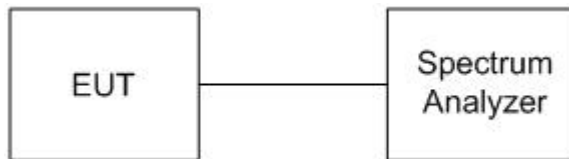

TEST PROCEDURE

1. Check the calibration of the measuring instrument using either an internal calibrator or a known signal from an external generator.
2. Position the EUT as shown in test setup without connection to measurement instrument. Turn on the EUT and connect its antenna terminal to measurement instrument via a low loss cable. Then set it to any one measured frequency within its operating range and make sure the instrument is operated in its linear range.
3. Adjust the center frequency of spectrum analyzer on any frequency be measured and set spectrum analyzer to zero span mode.
4. RBW = 1 MHz.
5. VBW ≥ RBW.
6. Sweep = as necessary to capture the entire dwell time per hopping channel.
7. Measure the time duration of one transmission on the measured frequency. And then plot the result with time difference of this time duration.
8. Repeat above procedures until all frequencies measured were complete.
9. The EUT has 3 type of payload, DH1, DH3, DH5. The hopping rate is 1600 per second. The longer the payload is, the slower the hopping rate is.



TEST RESULTS

Time of occupancy on the TX channel in 31.6sec = time domain slot length x hop rate ÷ number of hop per channel x 31.6

Refer to the attached graph.

The hopping rates of Bluetooth devices change with different types of payload. The longer the payload is, the slower the hopping rate. The hopping rate scenario is defined in Bluetooth core specification.

Modulation Type: GFSK

Channel	Channel Frequency (MHz)	Packet type	Dwell time (ms)	Time of occupancy on the TX channel in 31.6sec (ms)	Limit for Time of occupancy on the TX channel in 31.6sec (ms)	Results
Low	2402	DH1	0.378	120.96	400	PASS
	2402	DH3	1.630	260.80	400	PASS
	2402	DH5	2.880	307.20	400	PASS
Middle	2441	DH1	0.378	120.96	400	PASS
	2441	DH3	1.630	260.80	400	PASS
	2441	DH5	2.880	307.20	400	PASS
High	2480	DH1	0.378	120.96	400	PASS
	2480	DH3	1.630	260.80	400	PASS
	2480	DH5	2.880	307.20	400	PASS

Remark:

Ch Low

DH1 : 0.378 ms x (1600÷2) ÷ 79 x 31.6 = 120.96 (ms)

DH3 : 1.630 ms x (1600÷4) ÷ 79 x 31.6 = 260.80 (ms)

DH5 : 2.880 ms x (1600÷6) ÷ 79 x 31.6 = 307.20 (ms)

Ch Middle

DH1 : 0.378 ms x (1600÷2) ÷ 79 x 31.6 = 120.96 (ms)

DH3 : 1.630 ms x (1600÷4) ÷ 79 x 31.6 = 260.80 (ms)

DH5 : 2.880 ms x (1600÷6) ÷ 79 x 31.6 = 307.20 (ms)

Ch High

DH1 : 0.378 ms x (1600÷2) ÷ 79 x 31.6 = 120.96 (ms)

DH3 : 1.630 ms x (1600÷4) ÷ 79 x 31.6 = 260.80 (ms)

DH5 : 2.880 ms x (1600÷6) ÷ 79 x 31.6 = 307.20 (ms)



Modulation Type: 8-DPSK

Channel	Channel Frequency (MHz)	Packet type	Dwell time (ms)	Time of occupancy on the TX channel in 31.6sec (ms)	Limit for Time of occupancy on the TX channel in 31.6sec (ms)	Results
Low	2402	DH1	0.378	120.96	400	PASS
	2402	DH3	1.630	260.80	400	PASS
	2402	DH5	2.880	307.20	400	PASS
Middle	2441	DH1	0.378	120.96	400	PASS
	2441	DH3	1.630	260.80	400	PASS
	2441	DH5	2.880	307.20	400	PASS
High	2480	DH1	0.378	120.96	400	PASS
	2480	DH3	1.630	260.80	400	PASS
	2480	DH5	2.880	307.20	400	PASS

Remark:

Ch Low

DH1 : 0.378 ms x (1600÷2) ÷ 79 x 31.6 = 120.96 (ms)

DH3 : 1.630 ms x (1600÷4) ÷ 79 x 31.6 = 260.80 (ms)

DH5 : 2.880 ms x (1600÷6) ÷ 79 x 31.6 = 307.20 (ms)

Ch Middle

DH1 : 0.378 ms x (1600÷2) ÷ 79 x 31.6 = 120.96 (ms)

DH3 : 1.630 ms x (1600÷4) ÷ 79 x 31.6 = 260.80 (ms)

DH5 : 2.880 ms x (1600÷6) ÷ 79 x 31.6 = 307.20 (ms)

Ch High

DH1 : 0.378 ms x (1600÷2) ÷ 79 x 31.6 = 120.96 (ms)

DH3 : 1.630 ms x (1600÷4) ÷ 79 x 31.6 = 260.80 (ms)

DH5 : 2.880 ms x (1600÷6) ÷ 79 x 31.6 = 307.20 (ms)



DWELL TIME ON EACH PAYLOAD

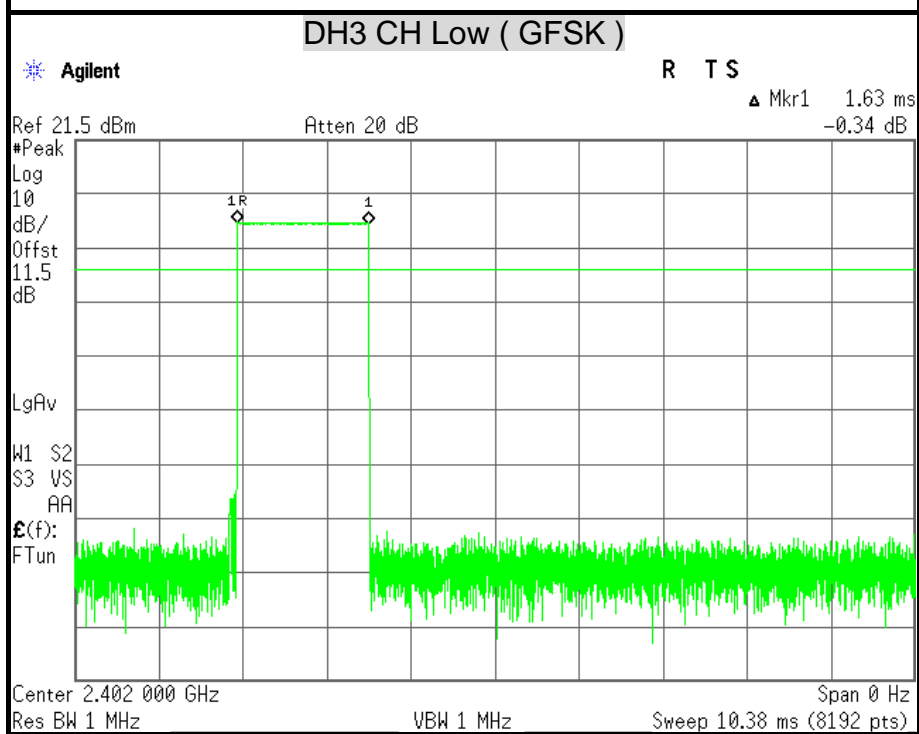
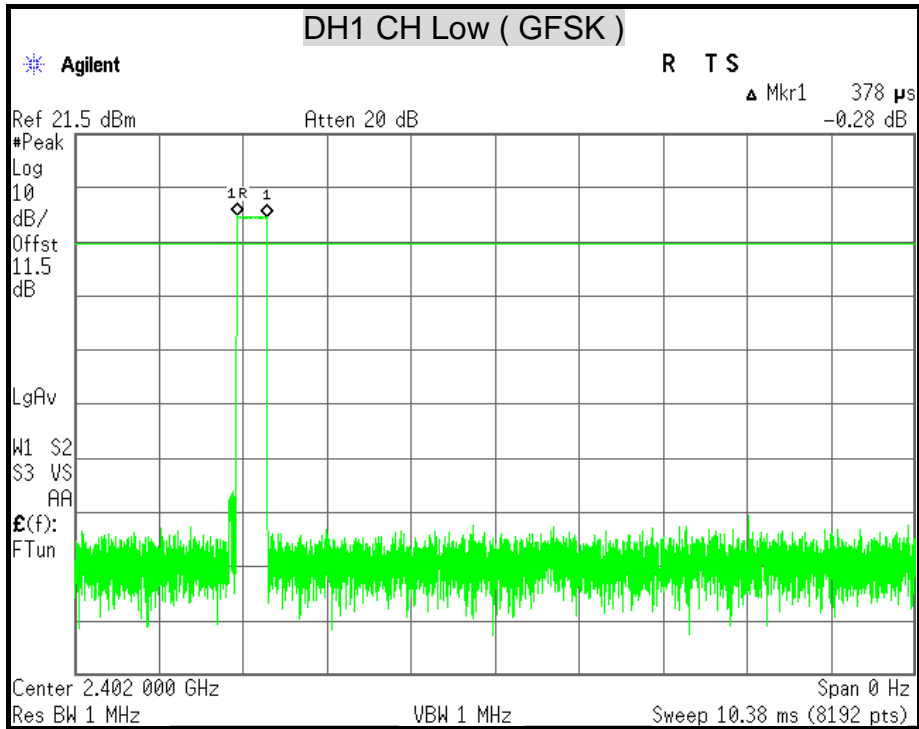

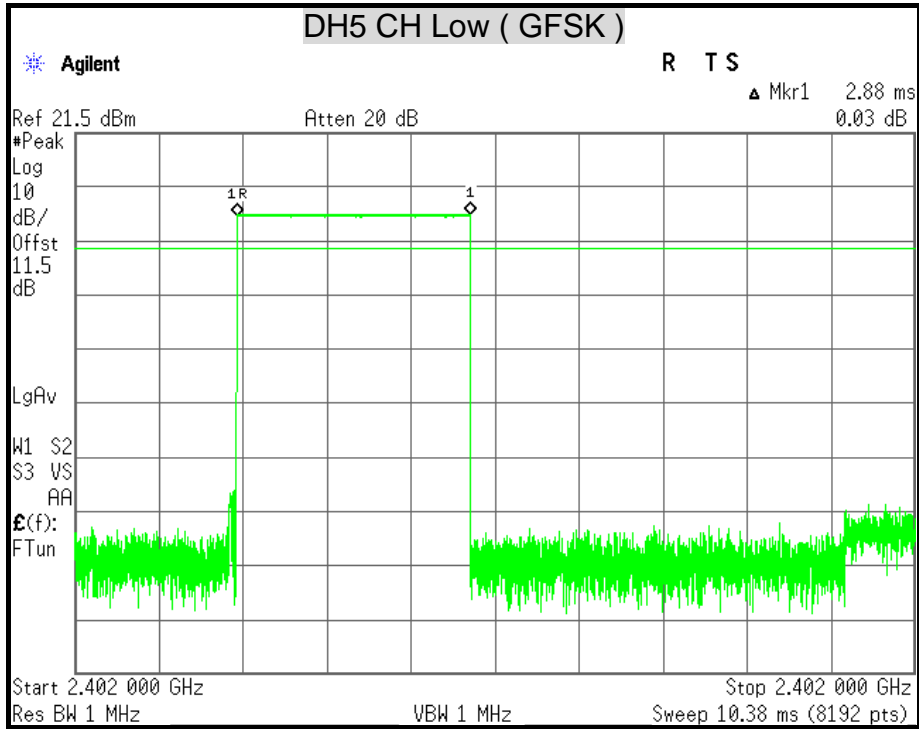

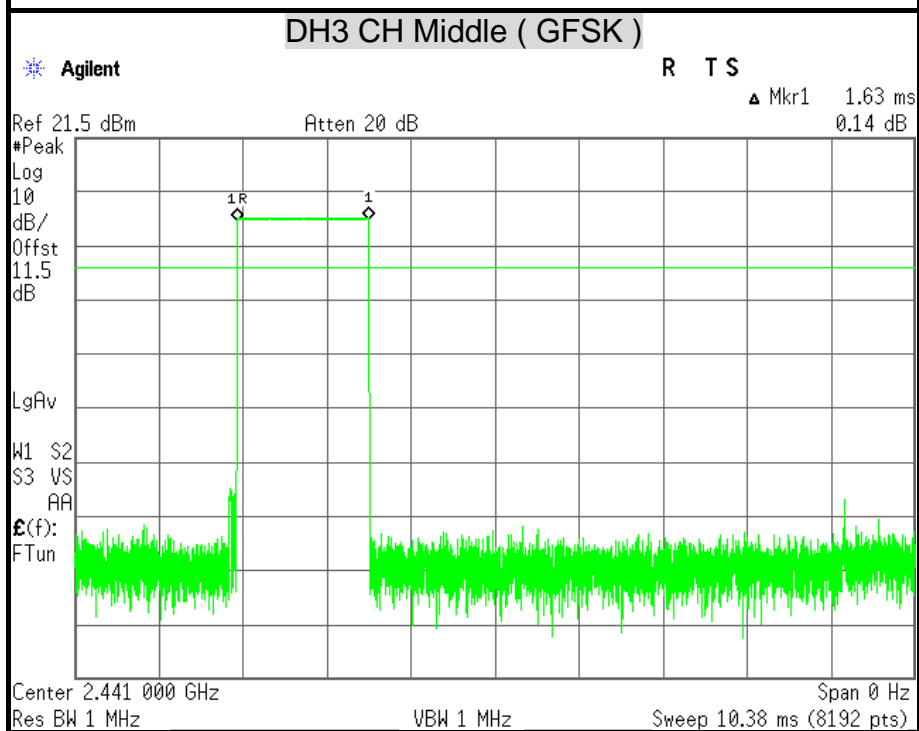
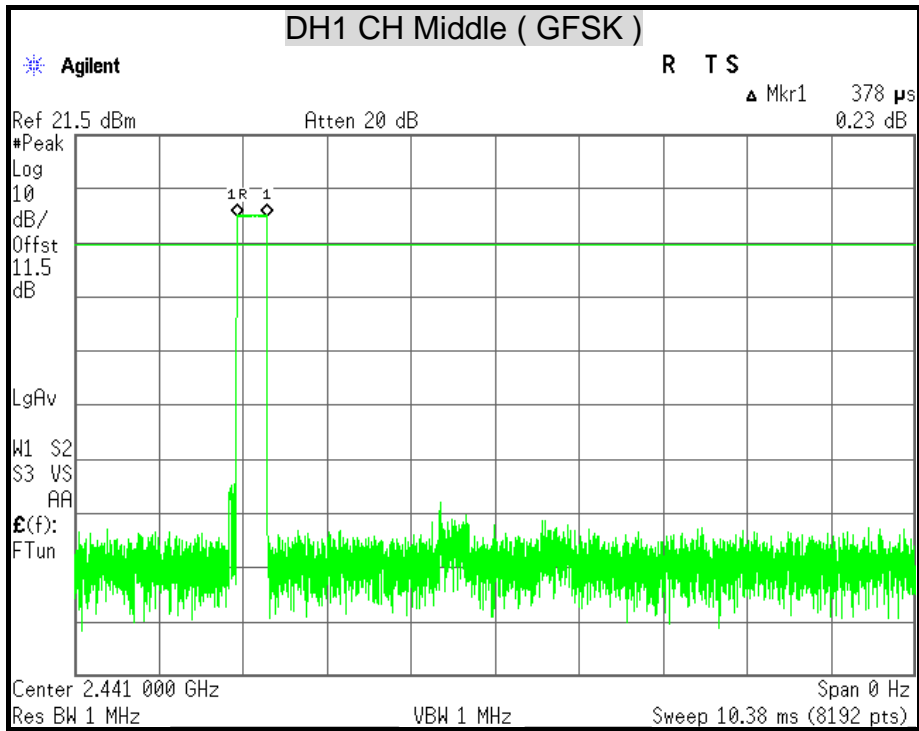

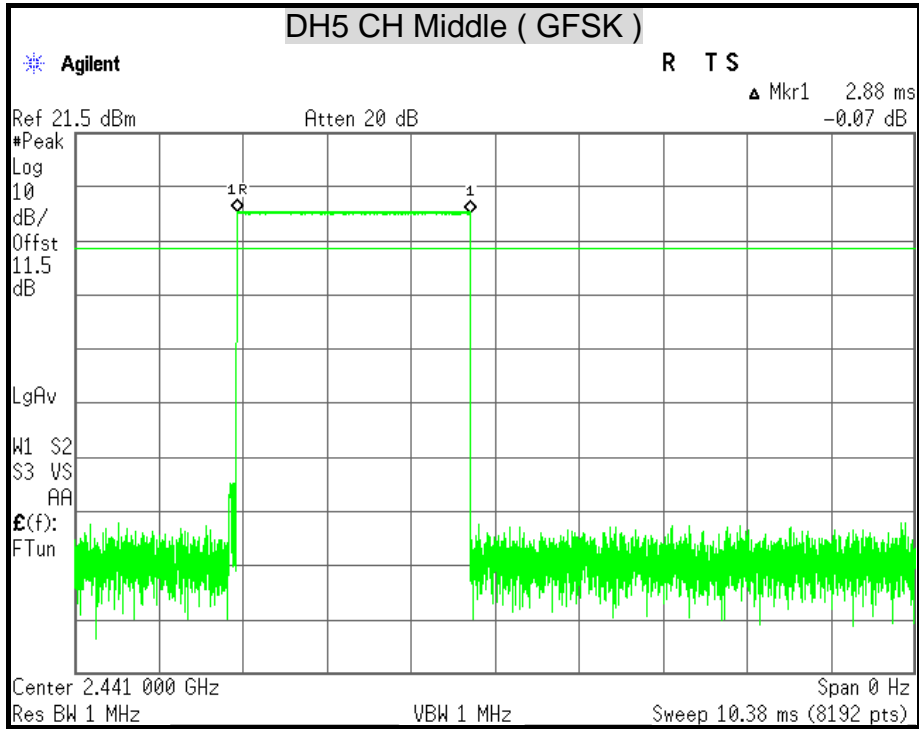

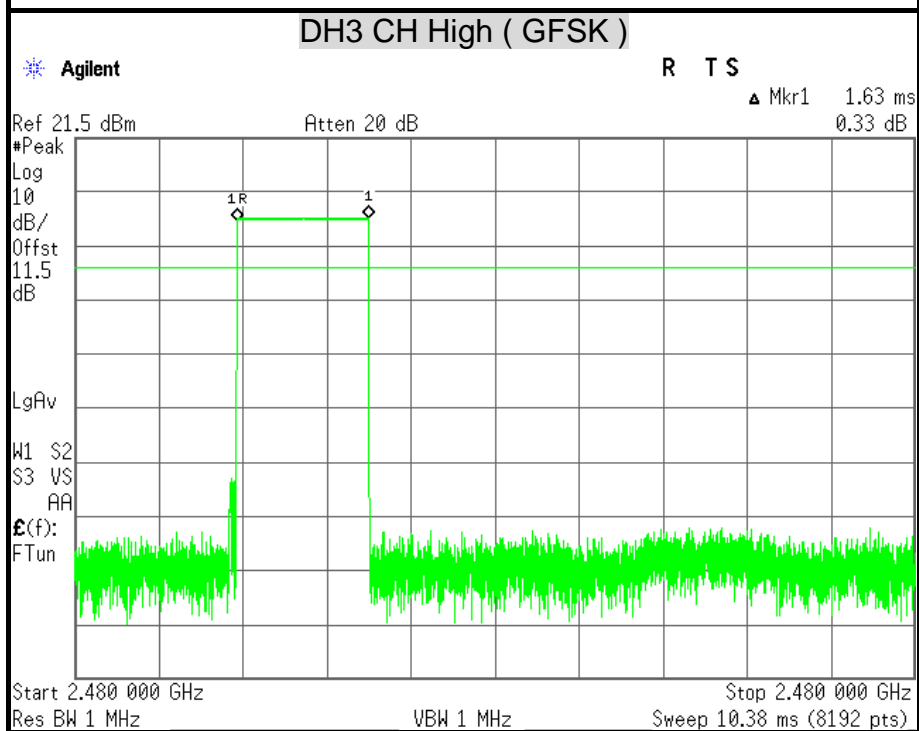
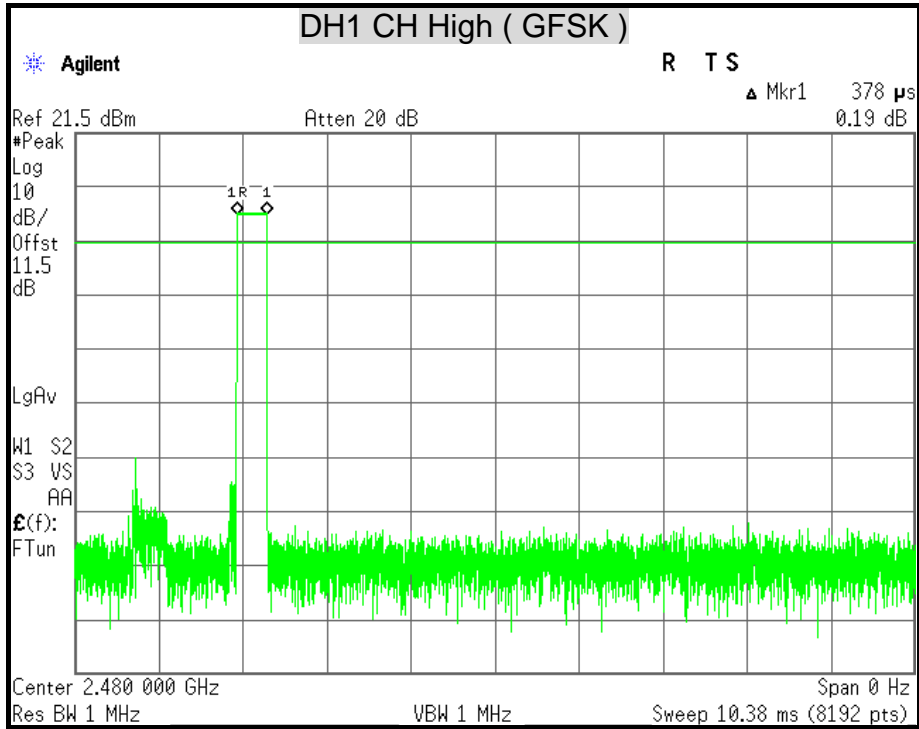

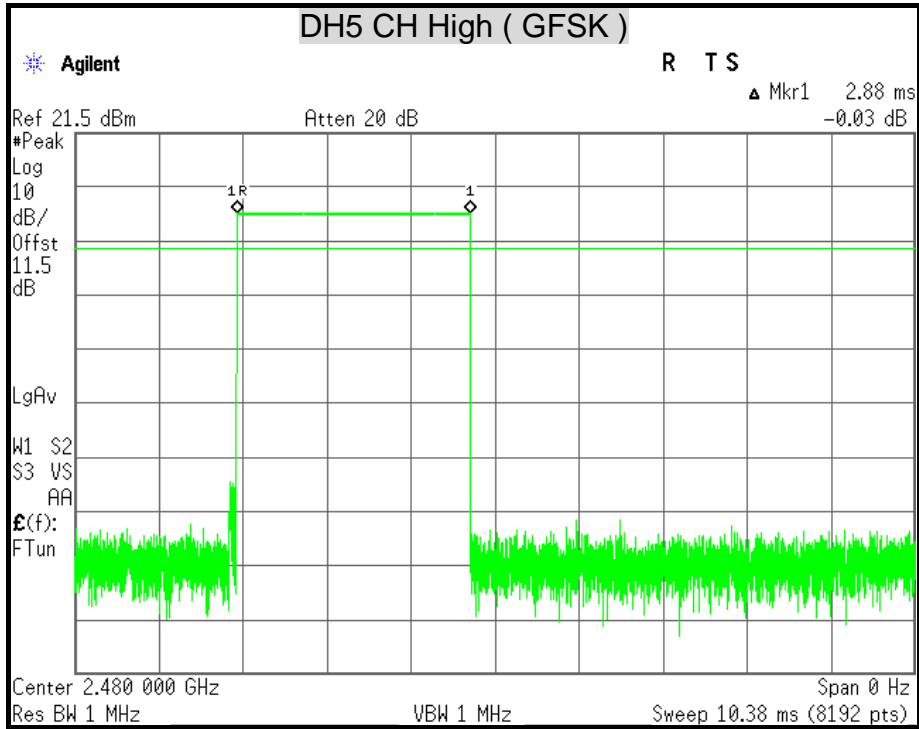

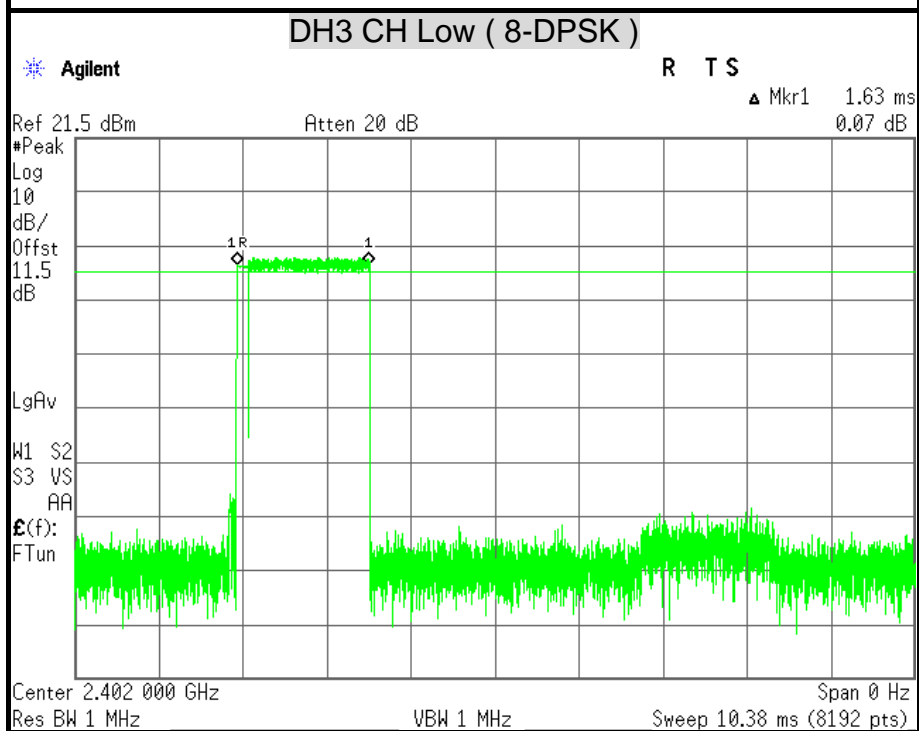
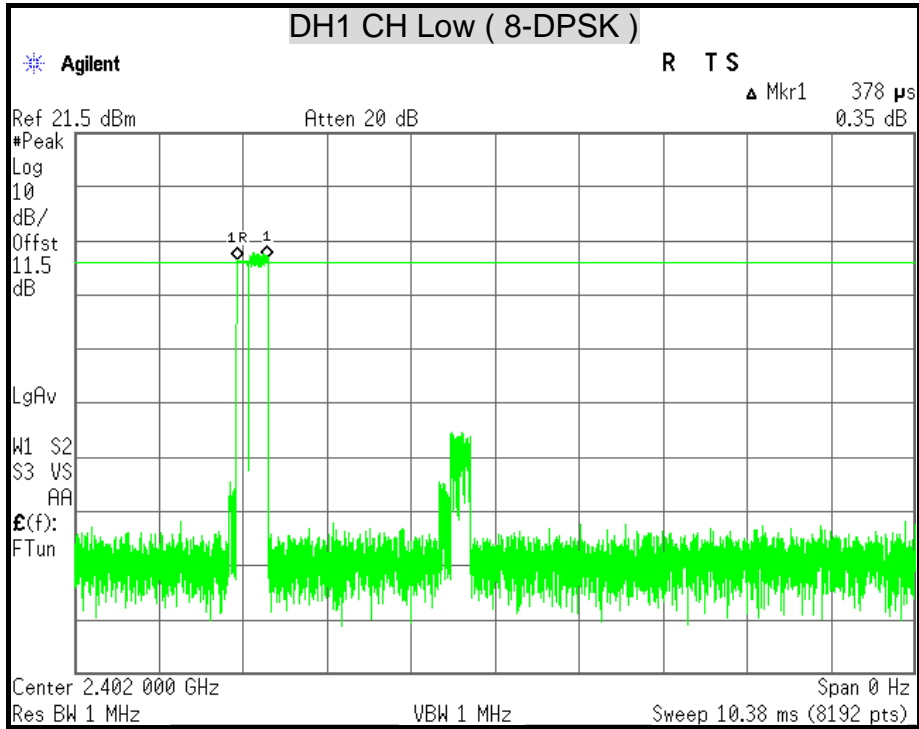

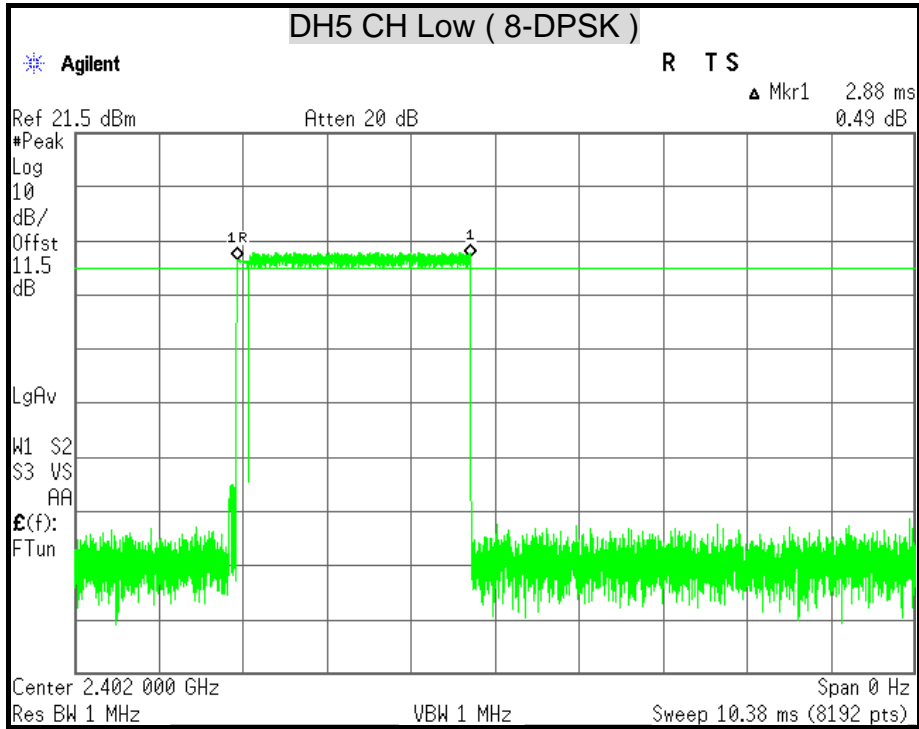

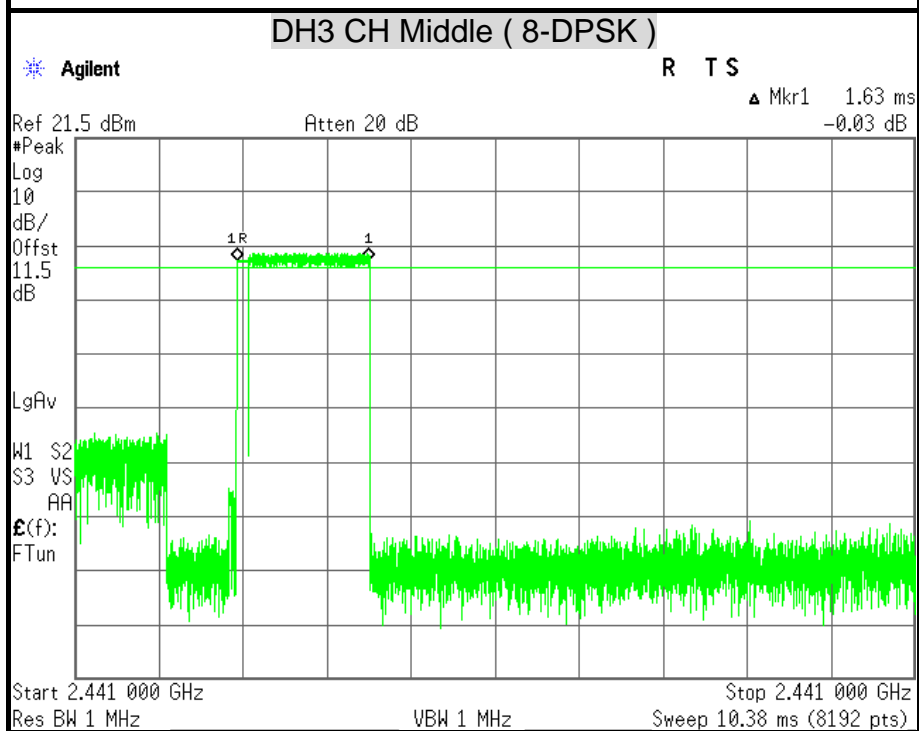
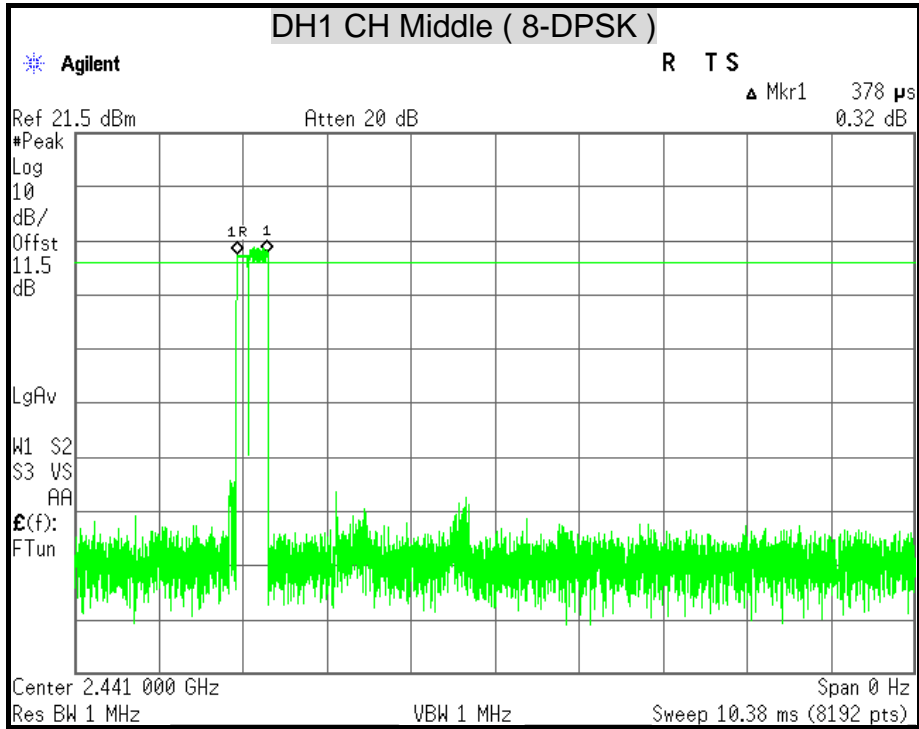

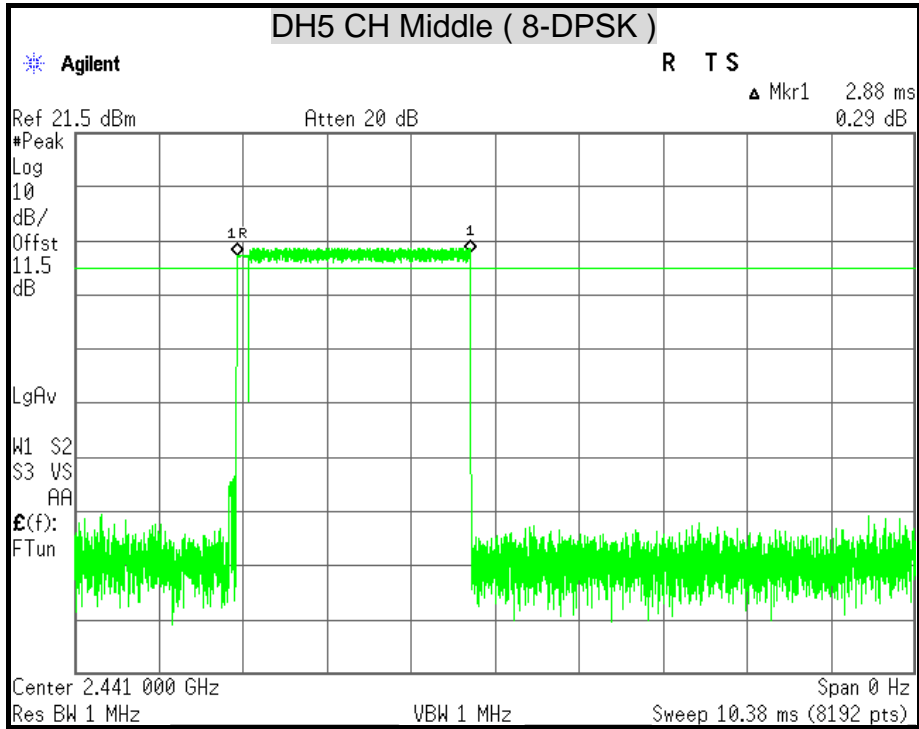

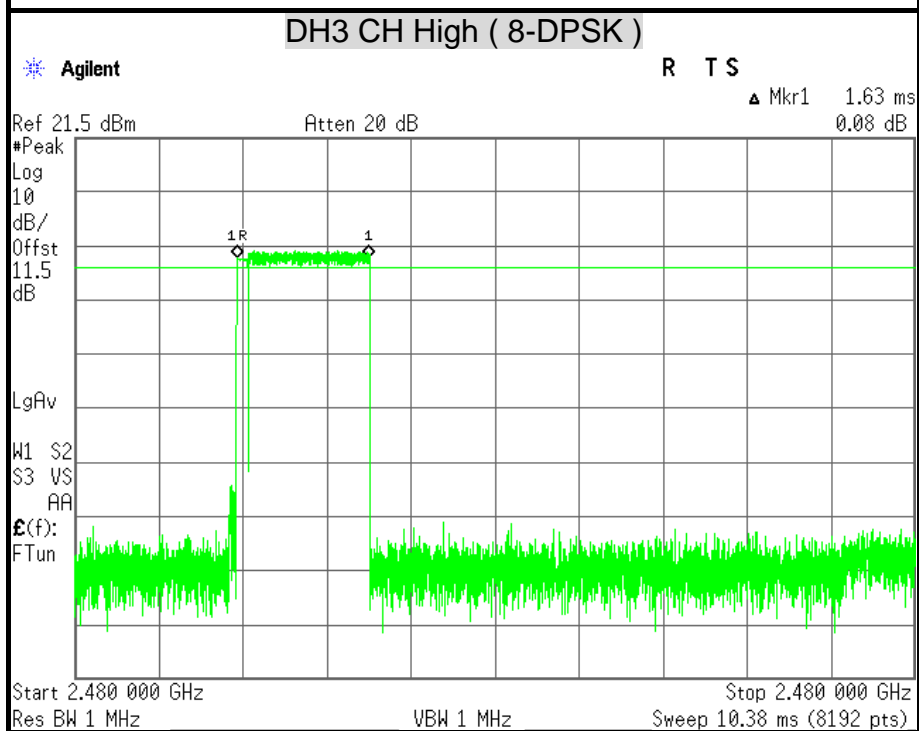
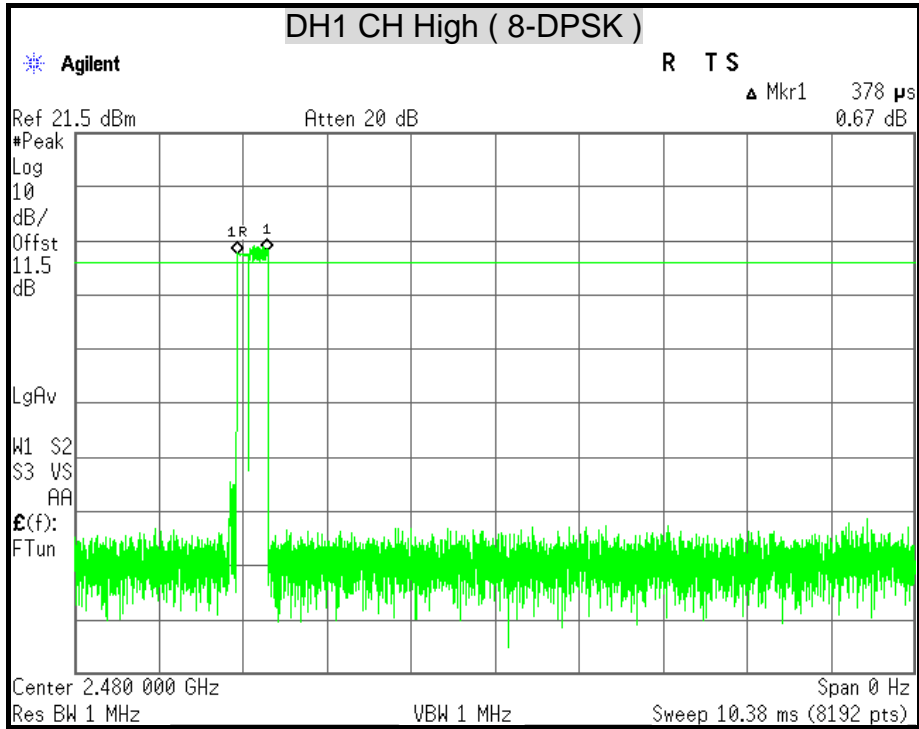

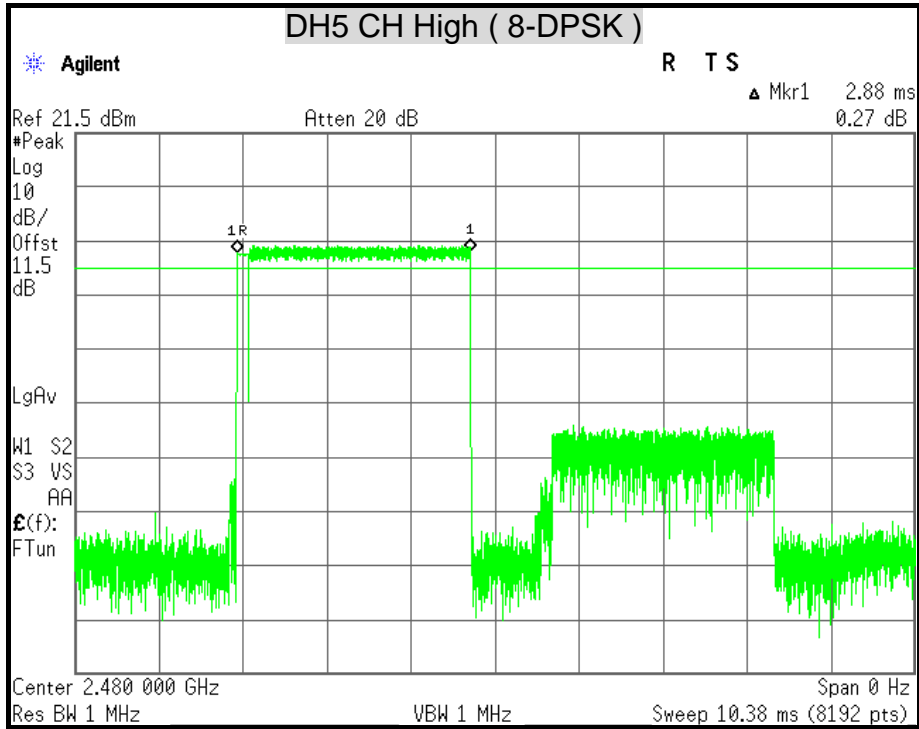



7.7 CONDUCTED SPURIOUS EMISSION

LIMITS

§ 15.247(d) In any 100 kHz bandwidth outside the frequency band in which the spread spectrum intentional radiator is operating, the radio frequency power that is produced by the intentional radiator shall be at least 20 dB below that in the 100 kHz bandwidth within the band that contains the highest level of the desired power, based on either an RF conducted or a radiated measurement. Attenuation below the general limits specified in § 15.209(a) is not required. In addition, radiated emissions which fall in the restricted bands, as defined in § 15.205(a), must also comply with the radiated emission limits specified in § 15.209(a) (see § 15.205(c)).

TEST EQUIPMENT

Name of Equipment	Manufacturer	Model	Serial Number	Calibration Due
Spectrum Analyzer	Agilent	E4446A	MY43360132	06/10/2015

Remark: Each piece of equipment is scheduled for calibration once a year.

TEST SETUP



TEST PROCEDURE

The transmitter output is connected to a spectrum analyzer. The resolution bandwidth is set to 100 kHz. The video bandwidth is set to 300 kHz.

The spectrum from 30 MHz to 26.5 GHz is investigated with the transmitter set to the lowest, middle, and highest channels in the 2.4 GHz band.



TEST RESULTS

OUT-OF-BAND SPURIOUS EMISSIONS-CONDUCTED MEASUREMENT

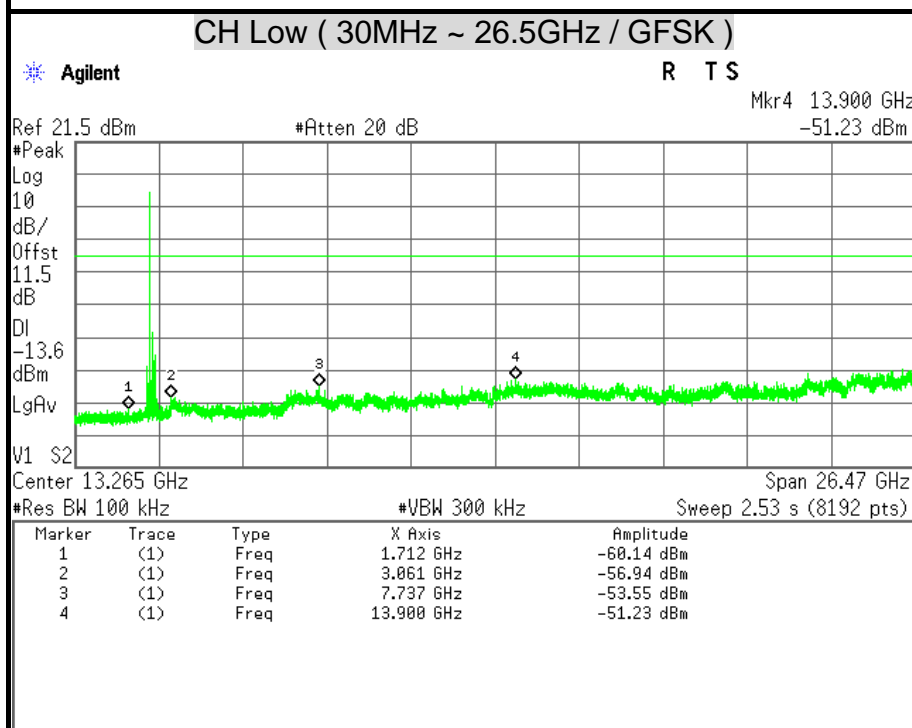
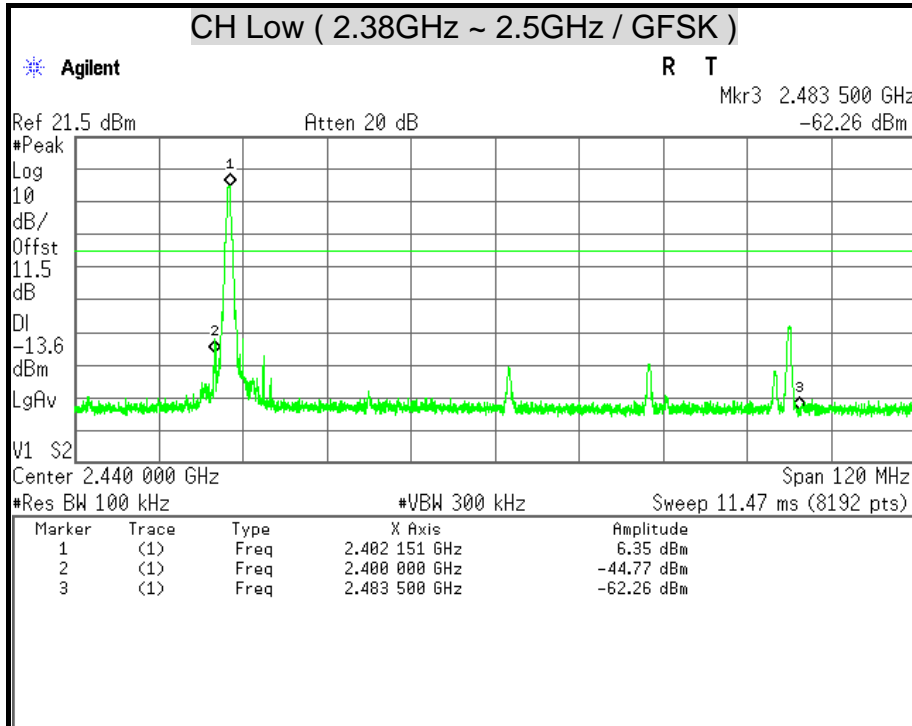

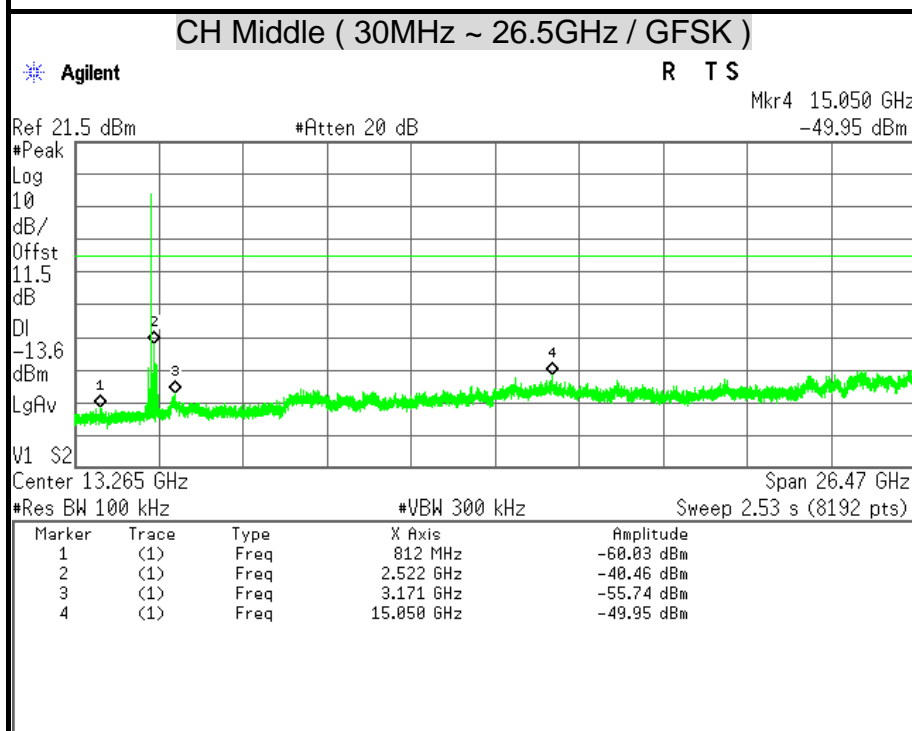
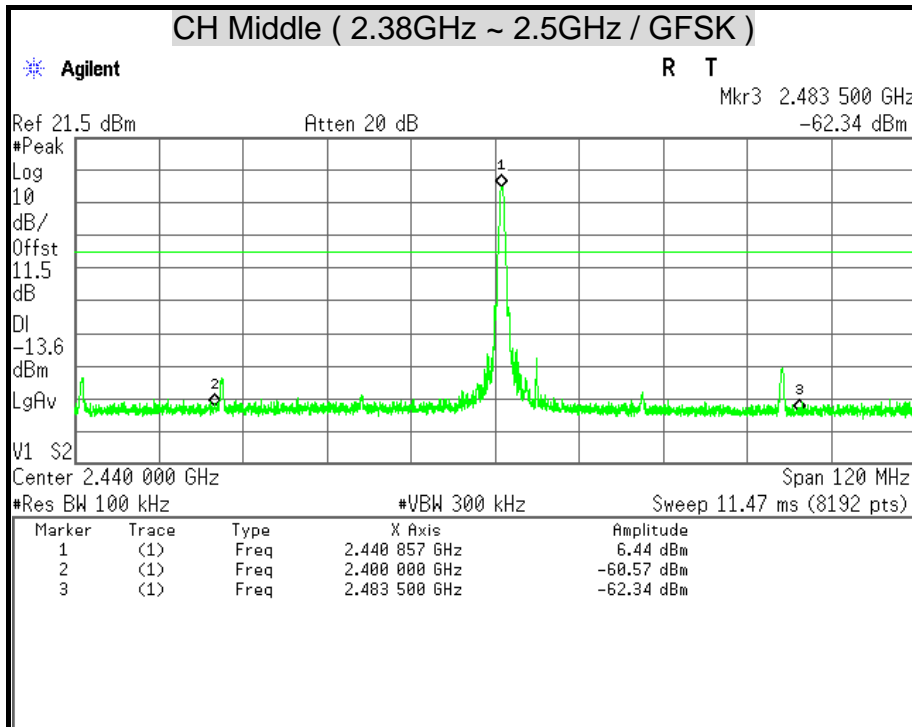

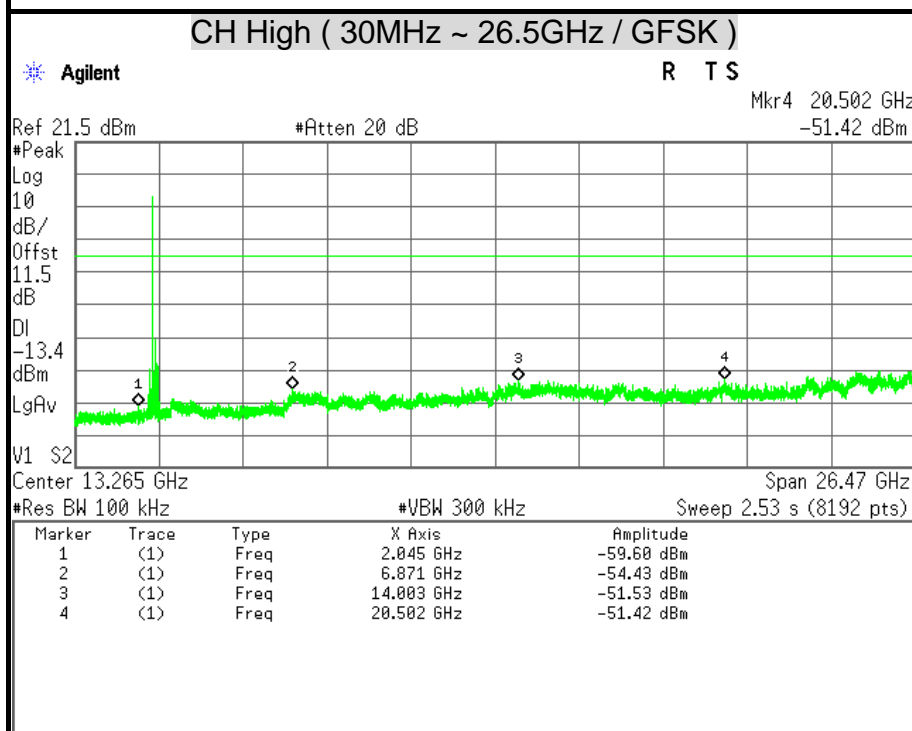
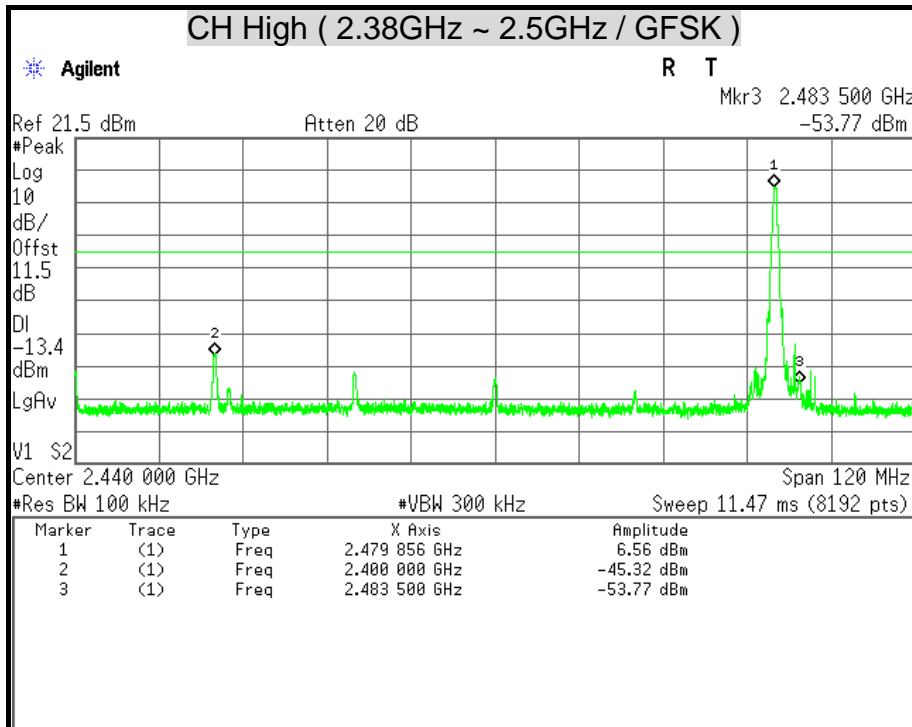

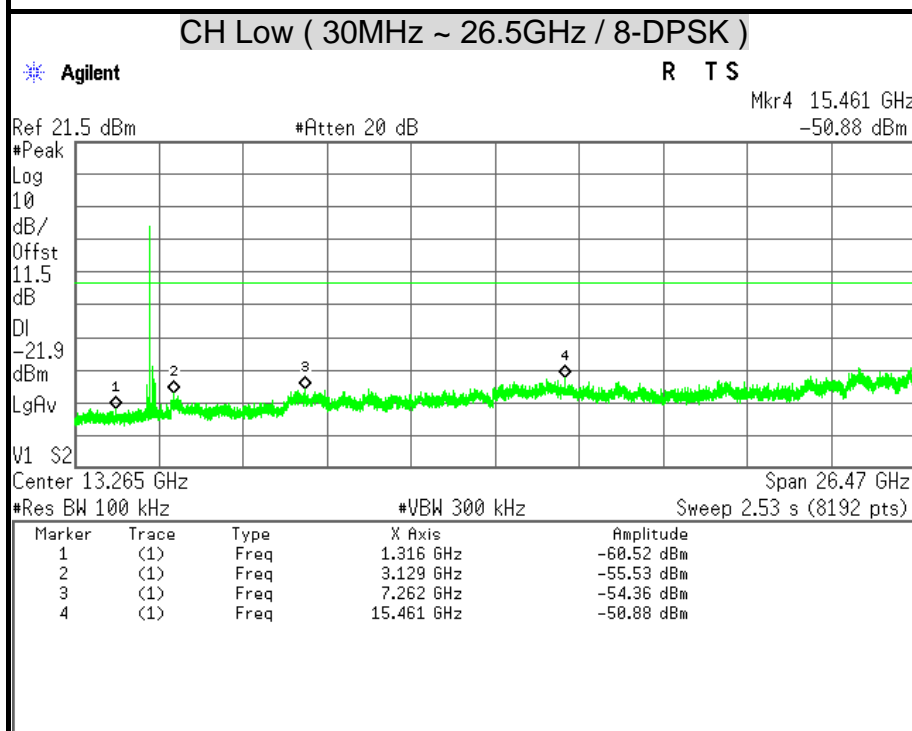
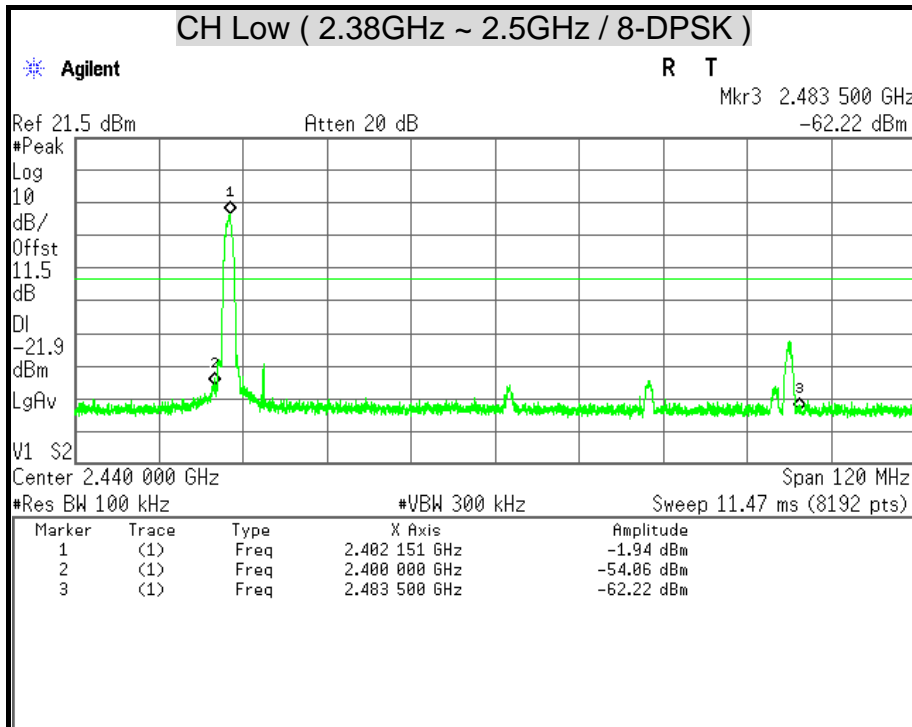

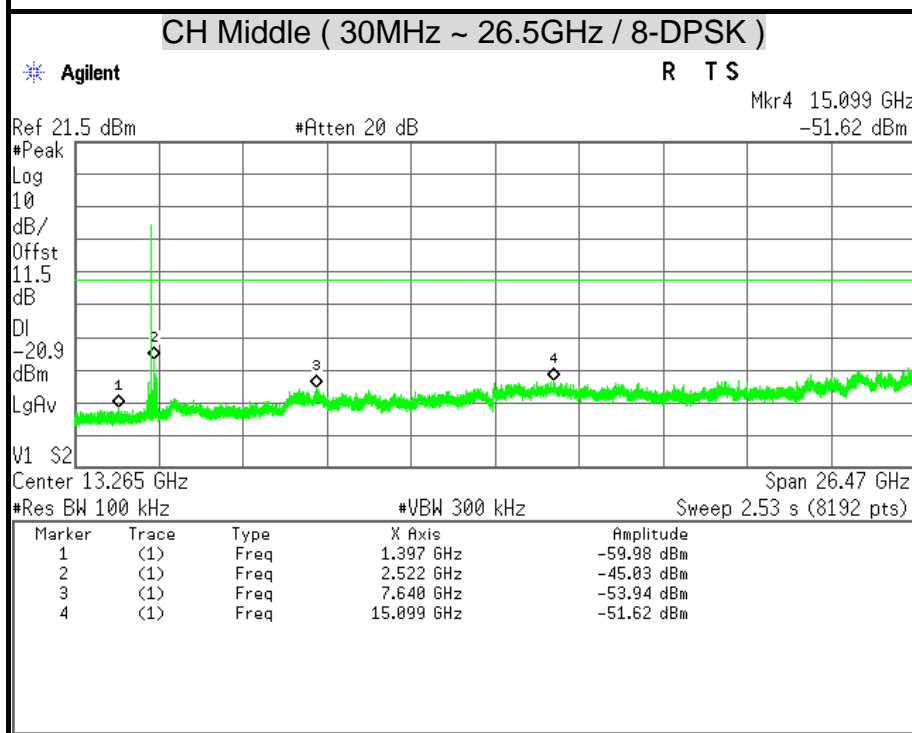
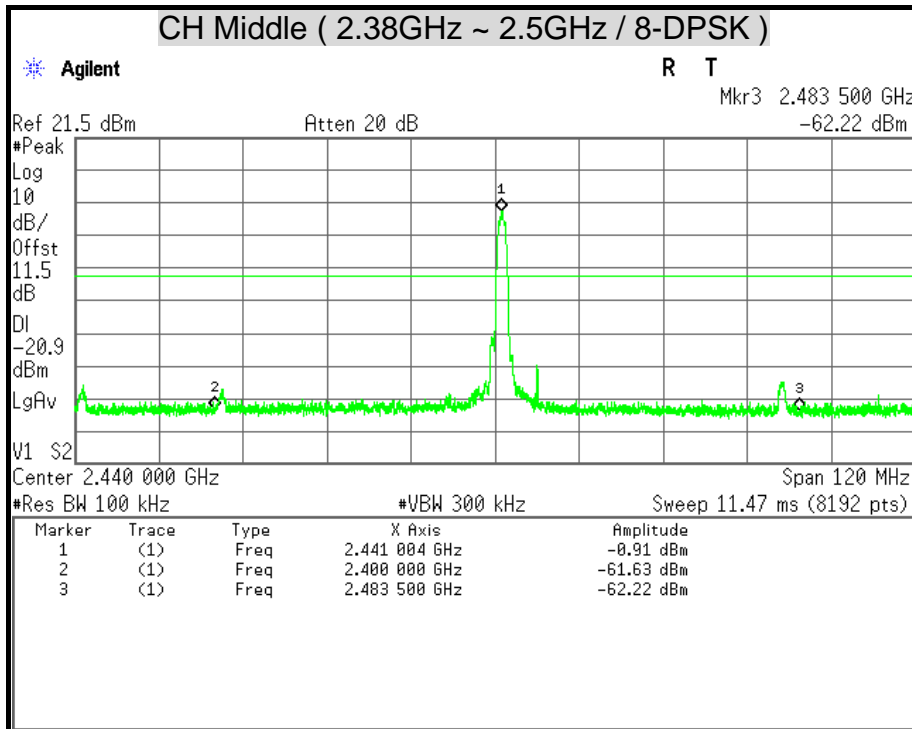

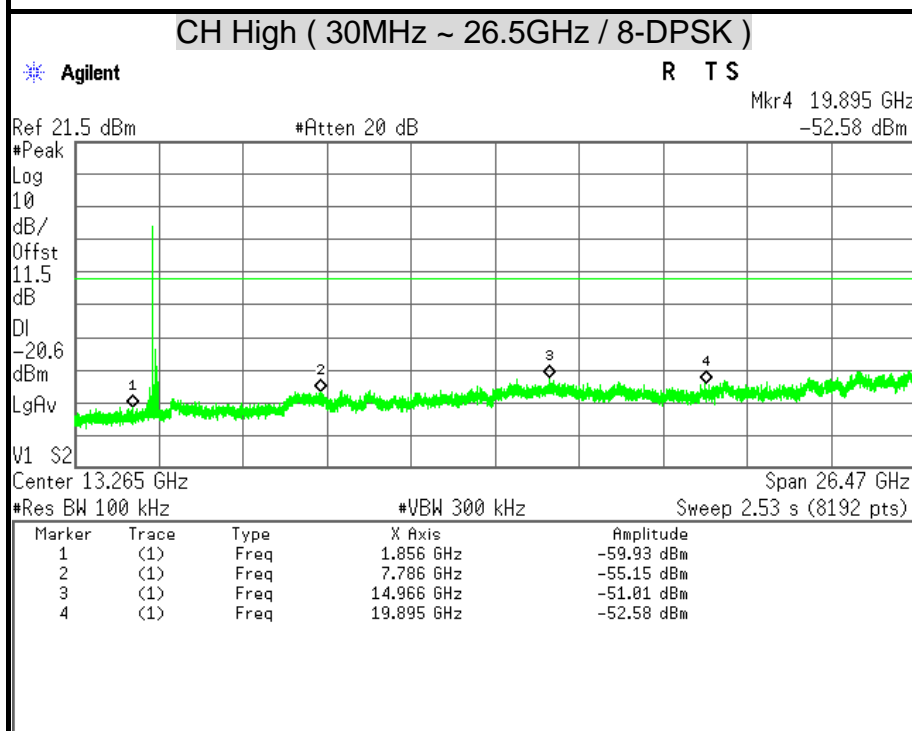
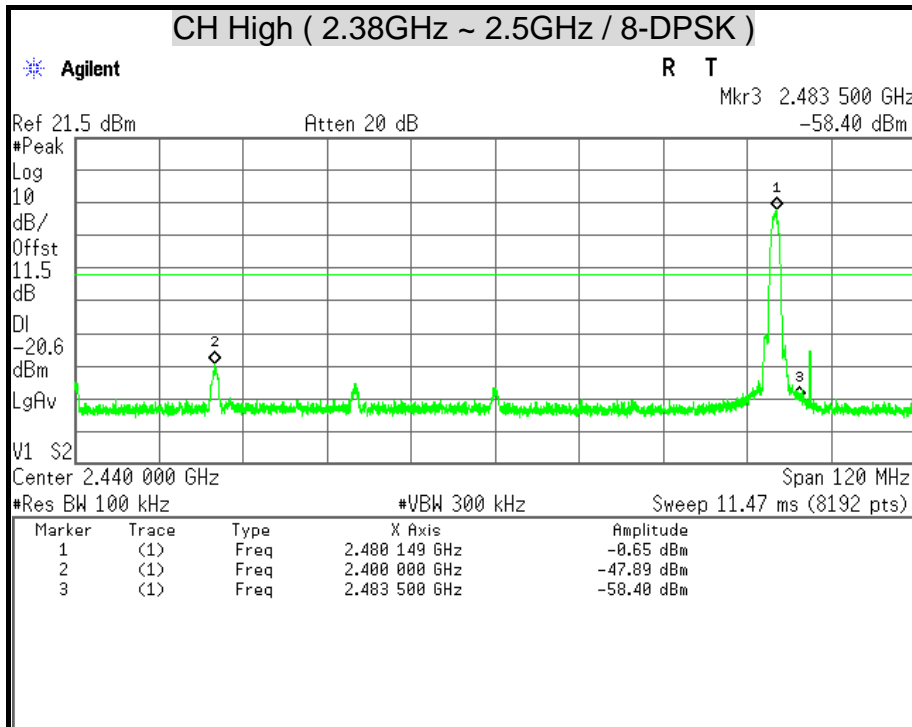



CONDUCTED MEASUREMENT HOPPING BAND EDGES

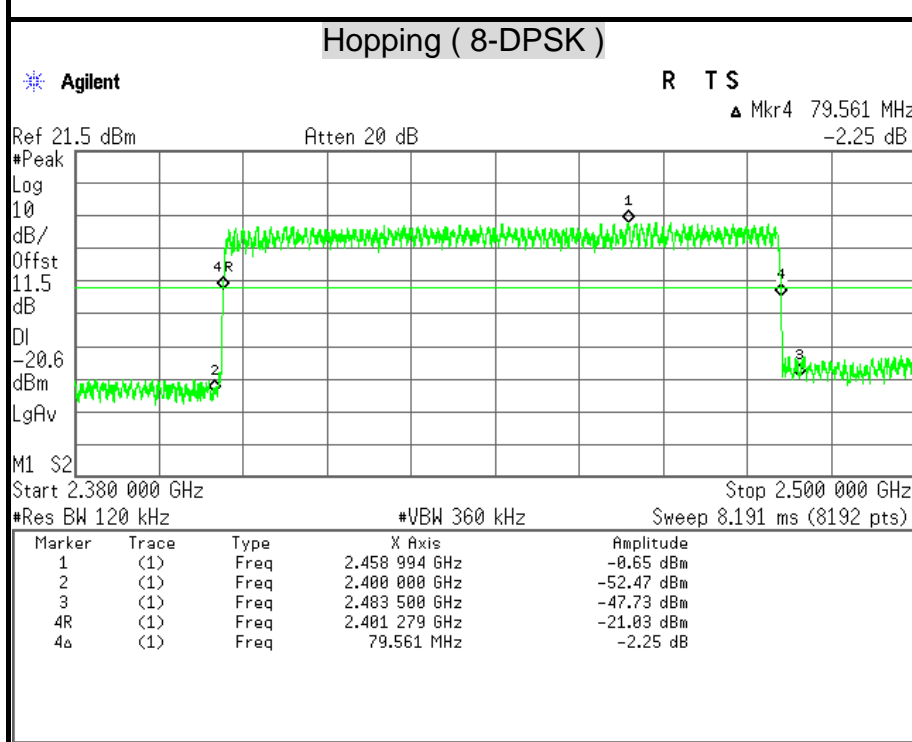
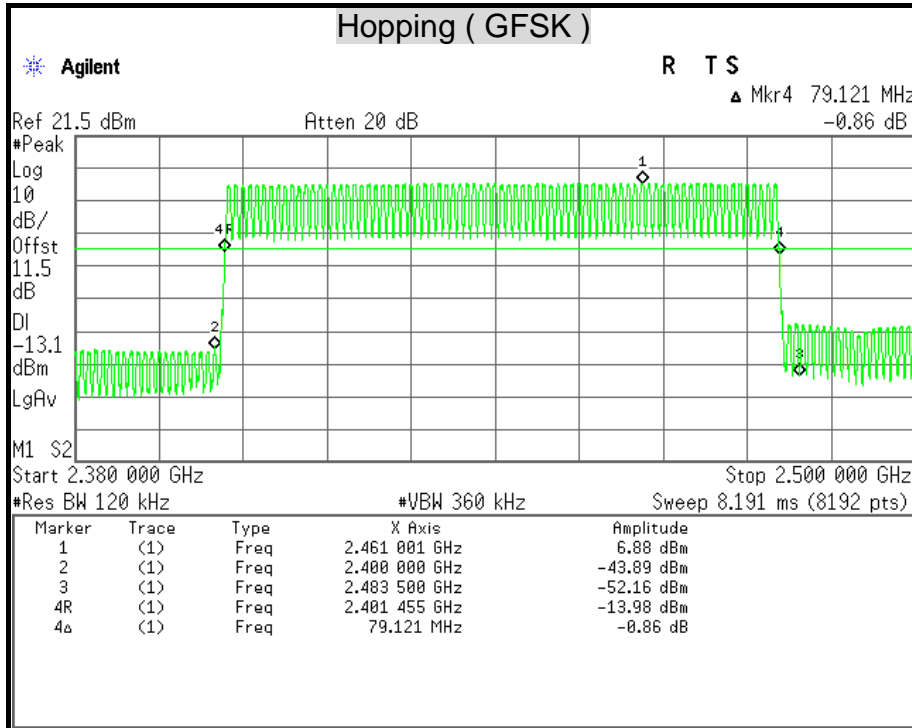



7.8 RADIATED EMISSION

LIMITS

(1) According to § 15.205 (a) Except as shown in paragraph (d) of this section, only spurious emissions are permitted in any of the frequency bands listed below:

MHz	MHz	MHz	GHz
0.090 - 0.110	16.42 - 16.423	399.9 - 410	4.5 - 5.15
¹ 0.495 - 0.505	16.69475 - 16.69525	608 - 614	5.35 - 5.46
2.1735 - 2.1905	16.80425 - 16.80475	960 - 1240	7.25 - 7.75
4.125 - 4.128	25.5 - 25.67	1300 - 1427	8.025 - 8.5
4.17725 - 4.17775	37.5 - 38.25	1435 - 1626.5	9.0 - 9.2
4.20725 - 4.20775	73 - 74.6	1645.5 - 1646.5	9.3 - 9.5
6.215 - 6.218	74.8 - 75.2	1660 - 1710	10.6 - 12.7
6.26775 - 6.26825	108 - 121.94	1718.8 - 1722.2	13.25 - 13.4
6.31175 - 6.31225	123 - 138	2200 - 2300	14.47 - 14.5
8.291 - 8.294	149.9 - 150.05	2310 - 2390	15.35 - 16.2
8.362 - 8.366	156.52475 - 156.52525	2483.5 - 2500	17.7 - 21.4
8.37625 - 8.38675	156.7 - 156.9	2655 - 2900	22.01 - 23.12
8.41425 - 8.41475	162.0125 - 167.17	3260 - 3267	23.6 - 24.0
12.29 - 12.293	167.72 - 173.2	3332 - 3339	31.2 - 31.8
12.51975 - 12.52025	240 - 285	3345.8 - 3338	36.43 - 36.5
12.57675 - 12.57725	322 - 335.4	3600 - 4400	(²)
13.36 - 13.41			

Remark:

- 1. ¹ Until February 1, 1999, this restricted band shall be 0.490-0.510 MHz.
- 2. ² Above 38.6

(2) According to § 15.205 (b) Except as provided in paragraphs (d) and (e), the field strength of emissions appearing within these frequency bands shall not exceed the limits shown in Section 15.209. At frequencies equal to or less than 1000 MHz, compliance with the limits in Section 15.209 shall be demonstrated using measurement instrumentation employing a CISPR quasi-peak detector. Above 1000 MHz, compliance with the emission limits in Section 15.209 shall be demonstrated based on the average value of the measured emissions. The provisions in Section 15.35 apply to these measurements.



(3) According to § 15.209 (a) Except as provided elsewhere in this Subpart, the emissions from an intentional radiator shall not exceed the field strength levels specified in the following table :

Frequency (MHz)	Field Strength (microvolts/meter)	Measurement Distance (meters)
0.009 – 0.490	2400/F(KHz)	300
0.490 – 1.705	24000/F(KHz)	30
1.705 – 30.0	30	30
30 - 88	100 **	3
88 - 216	150 **	3
216 - 960	200 **	3
Above 960	500	3

Remark: **Except as provided in paragraph (g), fundamental emissions from intentional radiators operating under this Section shall not be located in the frequency bands 54-72 MHz, 76-88 MHz, 174-216 MHz or 470-806 MHz. However, operation within these frequency bands is permitted under other sections of this Part, e.g., Sections 15.231 and 15.241.

(4) According to § 15.209 (b) In the emission table above, the tighter limit applies at the band edges.

TEST EQUIPMENT

Radiated Emission / 966Chamber_B

Name of Equipment	Manufacture	Model	Serial Number	Calibration Due
Spectrum Analyzer	Agilent	E4446A	MY46180323	04/15/2015
EMI Test Receiver	ROHDE & SCHWARZ	ESCS 30	835418/008	10/14/2015
Bi-log Antenna	SCHWARZBECK	VULB 9168	9168-250	08/21/2015
Broad-Band Horn Antenna	SCHWARZBECK	BBHA 9120 D	9120D-778	08/19/2015
Double-Ridged Waveguide Horn	ETS-LINDGREN	3117	00078733	12/05/2014
Horn Antenna	COM-POWER	AH-840	03077	12/18/2014
Pre-Amplifier	Agilent	8447D	2944A10052	07/15/2015
Pre-Amplifier	Agilent	8449B	3008A01916	07/15/2015
LOOP Antenna	EMCO	6502	8905-2356	09/23/2015
Notch Filters Band Reject	Micro-Tronics	BRM05702-01	026	N.C.R

Remark: 1. Each piece of equipment is scheduled for calibration once a year.
2. N.C.R = No Calibration Request.



TEST SETUP

The diagram below shows the test setup that is utilized to make the measurements for emission below 1GHz.

9kHz ~ 30MHz

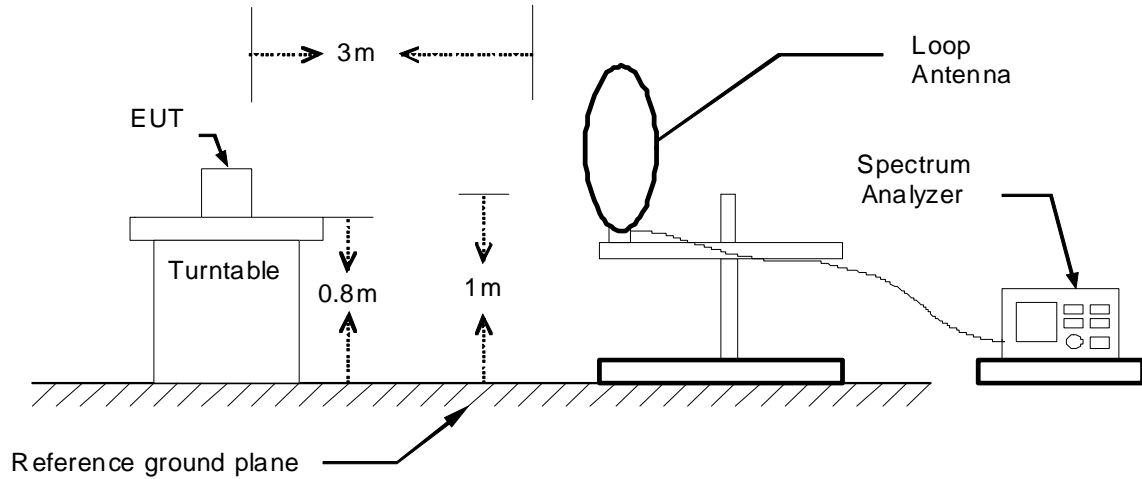

30MHz ~ 1GHz

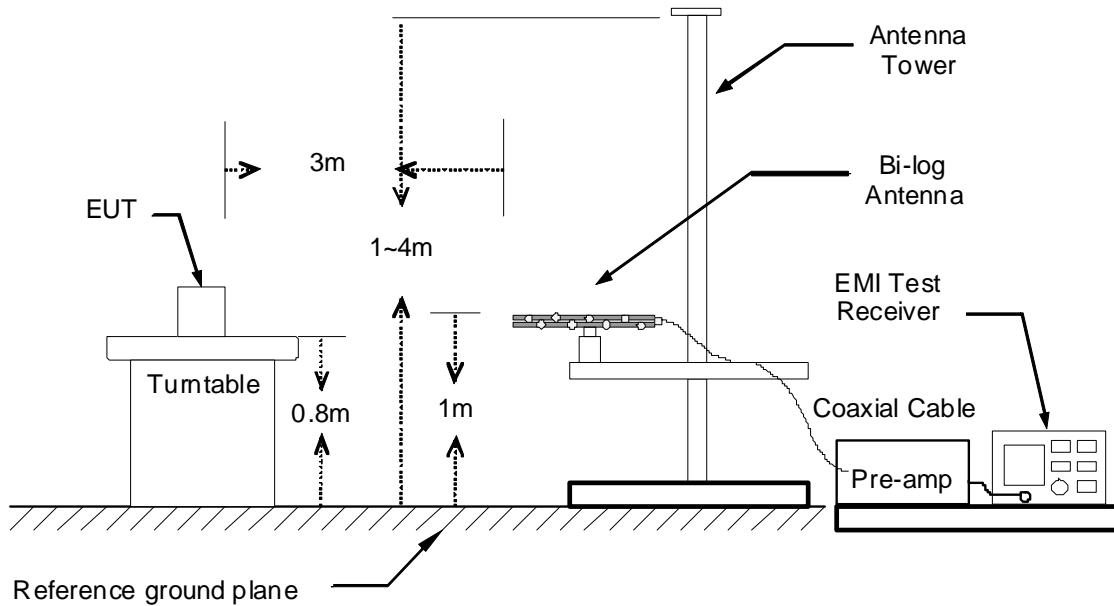



The diagram below shows the test setup that is utilized to make the measurements for emission above 1GHz.

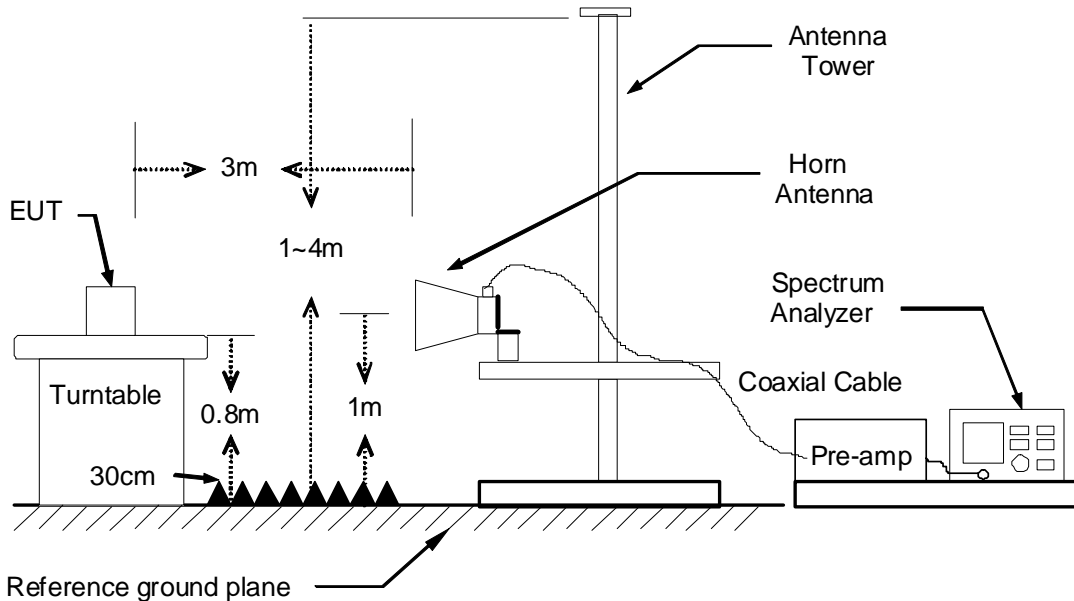

TEST PROCEDURE

1. The EUT was placed on the top of a rotating table 0.8 meters above the ground. The table was rotated 360 degrees to determine the position of the highest radiation.
2. While measuring the radiated emission below 1GHz, the EUT was set 3 meters away from the interference-receiving antenna, which was mounted on the top of a variable-height antenna tower. While measuring the radiated emission above 1GHz, the EUT was set 3 meters away from the interference-receiving antenna.
3. The antenna is a broadband antenna, and its height is varied from one meter to four meters above the ground to determine the maximum value of the field strength. Both horizontal and vertical polarization of the antenna are set to make the measurement.
4. For each suspected emission, the EUT was arranged to its worst case and then the antenna was tuned to heights from 1 meter to 4 meters and the table was turned from 0 degrees to 360 degrees to find the maximum reading.
5. The test-receiver system was set to Peak Detect Function and Specified Bandwidth with Maximum Hold Mode.
6. If the emission level of the EUT in peak mode was 10 dB lower than the limit specified, then testing could be stopped and the peak values of the EUT would be reported. Otherwise the emissions that did not have 10 dB margin would be re-tested one by one using peak, quasi-peak or average method as specified and then reported in a data sheet.

Remark :

1. The resolution bandwidth and video bandwidth of test receiver/spectrum analyzer is 120 KHz for Peak detection (PK) and Quasi-peak detection (QP) at frequency below 1GHz.
2. The resolution bandwidth and video bandwidth of test receiver/spectrum analyzer is 1 MHz for Peak detection and frequency above 1GHz.
3. The resolution bandwidth of test receiver/spectrum analyzer is 1 MHz and the video bandwidth is 10 Hz for Average detection (AV) at frequency above 1GHz.



TEST RESULTS

Below 1 GHz (9kHz ~ 30MHz)

No emission found between lowest internal used/generated frequency to 30MHz.

Below 1 GHz (30MHz ~ 1GHz)

Product Name	Panel PC	Test By	Davis Tseng
Test Model	VM-521	Test Date	2014/11/20
Test Mode	TX Mode / External Antenna	Temp. & Humidity	24.5°C, 33%

966 Chamber_B at 3Meter / Horizontal						
Frequency (MHz)	Reading (dBµV)	Correction Factor (dB/m)	Result (dBµV/m)	Limit (dBµV/m)	Margin (dB)	Remark
89.17	55.32	-19.55	35.77	43.50	-7.73	Peak
183.26	48.10	-14.60	33.50	43.50	-10.00	Peak
259.89	44.43	-12.88	31.56	46.00	-14.44	Peak
324.88	42.25	-10.98	31.27	46.00	-14.73	Peak
600.36	38.83	-5.82	33.01	46.00	-12.99	Peak
649.83	37.91	-5.36	32.55	46.00	-13.45	Peak

966 Chamber_B at 3Meter / Vertical						
Frequency (MHz)	Reading (dBµV)	Correction Factor (dB/m)	Result (dBµV/m)	Limit (dBµV/m)	Margin (dB)	Remark
32.91	49.30	-15.08	34.22	40.00	-5.78	Peak
89.17	54.05	-19.55	34.51	43.50	-8.99	Peak
183.26	53.41	-14.60	38.81	43.50	-4.69	Peak
423.82	39.25	-9.02	30.23	46.00	-15.77	Peak
600.36	44.01	-5.82	38.19	46.00	-7.81	Peak
943.74	31.50	-0.19	31.31	46.00	-14.69	Peak

Remark:

1. Quasi-peak test would be performed if the peak result were greater than the quasi-peak limit.
2. Data of measurement within this frequency range shown " --- " in the table above means the reading of emissions are attenuated more than 20dB below the permissible limits or the field strength is too small to be measured.
3. Correction Factor (dB/m) = Antenna Factor (dB/m) + Cable Loss (dB) – PreAmp.Gain (dB)
4. Result (dBµV/m) = Reading (dBµV) + Correction Factor (dB/m)
5. Margin (dB) = Remark result (dBµV/m) - Quasi-peak limit (dBµV/m).



Product Name	Panel PC	Test By	Rex Chiu
Test Model	VM-521	Test Date	2014/11/10
Test Mode	TX Mode / Internal Antenna	Temp. & Humidity	26°C, 52%

966 Chamber_B at 3Meter / Horizontal						
Frequency (MHz)	Reading (dBµV)	Correction Factor (dB/m)	Result (dBµV/m)	Limit (dBµV/m)	Margin (dB)	Remark
87.23	55.70	-19.28	36.42	40.00	-3.58	QP
173.56	52.41	-14.02	38.39	43.50	-5.11	Peak
324.88	44.43	-10.98	33.45	46.00	-12.55	Peak
365.62	43.31	-10.20	33.11	46.00	-12.89	Peak
482.99	39.09	-8.06	31.03	46.00	-14.97	Peak
600.36	39.29	-5.82	33.47	46.00	-12.53	Peak
966 Chamber_B at 3Meter / Vertical						
Frequency (MHz)	Reading (dBµV)	Correction Factor (dB/m)	Result (dBµV/m)	Limit (dBµV/m)	Margin (dB)	Remark
32.91	50.60	-15.08	35.52	40.00	-4.48	QP
74.62	51.83	-17.06	34.77	40.00	-5.23	Peak
86.26	55.28	-19.15	36.12	40.00	-3.88	Peak
172.59	52.57	-13.95	38.62	43.50	-4.88	Peak
600.36	47.10	-5.82	41.28	46.00	-4.72	Peak
974.78	30.82	0.24	31.06	54.00	-22.94	Peak

Remark:

1. Quasi-peak test would be performed if the peak result were greater than the quasi-peak limit.
2. Data of measurement within this frequency range shown " --- " in the table above means the reading of emissions are attenuated more than 20dB below the permissible limits or the field strength is too small to be measured.
3. Correction Factor (dB/m) = Antenna Factor (dB/m) + Cable Loss (dB) – PreAmp.Gain (dB)
4. Result (dBuV/m) = Reading (dBuV) + Correction Factor (dB/m)
5. Margin (dB) = Remark result (dBuV/m) - Quasi-peak limit (dBuV/m).



Above 1 GHz

Product Name	Panel PC	Test By	Rex Chiu
Test Model	VM-521	Test Date	2014/11/12
Test Mode	GFSK TX / CH Low / External Antenna	Temp. & Humidity	23°C, 54%

966 Chamber_B at 3Meter / Horizontal									
Frequency (MHz)	Reading-PK (dBuV)	Reading-AV (dBuV)	Correction Factor (dB/m)	Result-PK (dBuV/m)	Result-AV (dBuV/m)	Limit-PK (dBuV/m)	Limit-AV (dBuV/m)	Margin (dB)	Remark
1714.00	50.36	---	-0.02	50.34	---	74.00	54.00	-3.66	Peak
2522.00	48.07	---	3.66	51.73	---	74.00	54.00	-2.27	Peak
2562.00	49.87	43.97	3.76	53.62	47.73	74.00	54.00	-6.27	AVG
4605.00	39.57	---	8.80	48.37	---	74.00	54.00	-5.63	Peak
5820.00	39.06	---	11.99	51.05	---	74.00	54.00	-2.95	Peak
7005.00	37.91	---	14.06	51.97	---	74.00	54.00	-2.03	Peak

966 Chamber_B at 3Meter / Vertical									
Frequency (MHz)	Reading-PK (dBuV)	Reading-AV (dBuV)	Correction Factor (dB/m)	Result-PK (dBuV/m)	Result-AV (dBuV/m)	Limit-PK (dBuV/m)	Limit-AV (dBuV/m)	Margin (dB)	Remark
2502.00	52.91	47.05	3.61	56.52	50.66	74.00	54.00	-3.34	AVG
2522.00	54.06	48.17	3.66	57.72	51.83	74.00	54.00	-2.17	AVG
2562.00	54.31	48.49	3.76	58.07	52.25	74.00	54.00	-1.75	AVG
4800.00	39.54	---	8.71	48.24	---	74.00	54.00	-5.76	Peak
5985.00	38.35	---	12.70	51.06	---	74.00	54.00	-2.94	Peak
6930.00	38.69	---	13.86	52.54	---	74.00	54.00	-1.46	Peak

Remark:

1. Measuring frequencies from 1 GHz to the 10th harmonic of highest fundamental frequency.
2. Average test would be performed if the peak result were greater than the average limit.
3. Data of measurement within this frequency range shown " --- " in the table above means the reading of emissions are attenuated more than 20dB below the permissible limits or the field strength is too small to be measured.
4. Measurements above show only up to 6 maximum emissions noted, or would be lesser, with " N/A " remark, if no specific emissions from the EUT are recorded (ie: margin>20dB from the applicable limit) and considered that's already beyond the background noise floor.
5. Result = Reading + Correction Factor
Margin = Result - Limit
Remark Peak = Result(PK) - Limit(AV)
Remark AVG = Result(AV) - Limit(AV)



Product Name	Panel PC	Test By	Rex Chiu
Test Model	VM-521	Test Date	2014/11/12
Test Mode	GFSK TX / CH Middle / External Antenna	Temp. & Humidity	23°C, 54%

966 Chamber_B at 3Meter / Horizontal									
Frequency (MHz)	Reading-PK (dBuV)	Reading-AV (dBuV)	Correction Factor (dB/m)	Result-PK (dBuV/m)	Result-AV (dBuV/m)	Limit-PK (dBuV/m)	Limit-AV (dBuV/m)	Margin (dB)	Remark
1714.00	50.72	---	-0.02	50.70	---	74.00	54.00	-3.30	Peak
2520.00	52.51	46.63	3.66	56.16	50.29	74.00	54.00	-3.71	AVG
2542.00	48.26	---	3.71	51.97	---	74.00	54.00	-2.03	Peak
4455.00	39.40	---	8.62	48.03	---	74.00	54.00	-5.97	Peak
6240.00	38.92	---	12.66	51.59	---	74.00	54.00	-2.41	Peak
6885.00	38.68	---	13.72	52.41	---	74.00	54.00	-1.59	Peak

966 Chamber_B at 3Meter / Vertical									
Frequency (MHz)	Reading-PK (dBuV)	Reading-AV (dBuV)	Correction Factor (dB/m)	Result-PK (dBuV/m)	Result-AV (dBuV/m)	Limit-PK (dBuV/m)	Limit-AV (dBuV/m)	Margin (dB)	Remark
2362.00	52.04	46.28	3.34	55.38	49.62	74.00	54.00	-4.38	AVG
2520.00	58.71	49.75	3.66	62.37	53.41	74.00	54.00	-0.59	AVG
2540.00	51.97	46.14	3.70	55.68	49.84	74.00	54.00	-4.16	AVG
4725.00	39.59	---	8.74	48.33	---	74.00	54.00	-5.67	Peak
5790.00	38.99	---	11.86	50.85	---	74.00	54.00	-3.15	Peak
7050.00	38.70	---	13.94	52.64	---	74.00	54.00	-1.36	Peak

Remark:

1. Measuring frequencies from 1 GHz to the 10th harmonic of highest fundamental frequency.
2. Average test would be performed if the peak result were greater than the average limit.
3. Data of measurement within this frequency range shown " --- " in the table above means the reading of emissions are attenuated more than 20dB below the permissible limits or the field strength is too small to be measured.
4. Measurements above show only up to 6 maximum emissions noted, or would be lesser, with " N/A " remark, if no specific emissions from the EUT are recorded (ie: margin>20dB from the applicable limit) and considered that's already beyond the background noise floor.
5. Result = Reading + Correction Factor
Margin = Result - Limit
Remark Peak = Result(PK) - Limit(AV)
Remark AVG = Result(AV) - Limit(AV)



Product Name	Panel PC	Test By	Rex Chiu
Test Model	VM-521	Test Date	2014/11/12
Test Mode	GFSK TX / CH High / External Antenna	Temp. & Humidity	23°C, 54%

966 Chamber_B at 3Meter / Horizontal									
Frequency (MHz)	Reading-PK (dBuV)	Reading-AV (dBuV)	Correction Factor (dB/m)	Result-PK (dBuV/m)	Result-AV (dBuV/m)	Limit-PK (dBuV/m)	Limit-AV (dBuV/m)	Margin (dB)	Remark
1666.00	49.17	---	-0.47	48.70	---	74.00	54.00	-5.30	Peak
2560.00	52.29	46.45	3.75	56.05	50.20	74.00	54.00	-3.80	AVG
2580.00	46.83	---	3.80	50.63	---	74.00	54.00	-3.37	Peak
4425.00	40.43	---	8.48	48.90	---	74.00	54.00	-5.10	Peak
4755.00	39.72	---	8.73	48.45	---	74.00	54.00	-5.55	Peak
6285.00	37.89	---	12.64	50.53	---	74.00	54.00	-3.47	Peak

966 Chamber_B at 3Meter / Vertical									
Frequency (MHz)	Reading-PK (dBuV)	Reading-AV (dBuV)	Correction Factor (dB/m)	Result-PK (dBuV/m)	Result-AV (dBuV/m)	Limit-PK (dBuV/m)	Limit-AV (dBuV/m)	Margin (dB)	Remark
2380.00	47.73	---	3.37	51.11	---	74.00	54.00	-2.89	Peak
2560.00	57.16	49.76	3.75	60.91	53.51	74.00	54.00	-0.49	AVG
2580.00	51.91	46.09	3.80	55.71	49.89	74.00	54.00	-4.11	AVG
4845.00	39.84	---	8.68	48.52	---	74.00	54.00	-5.48	Peak
5970.00	37.78	---	12.64	50.42	---	74.00	54.00	-3.58	Peak
7095.00	38.49	---	13.82	52.30	---	74.00	54.00	-1.70	Peak

Remark:

1. Measuring frequencies from 1 GHz to the 10th harmonic of highest fundamental frequency.
2. Average test would be performed if the peak result were greater than the average limit.
3. Data of measurement within this frequency range shown " --- " in the table above means the reading of emissions are attenuated more than 20dB below the permissible limits or the field strength is too small to be measured.
4. Measurements above show only up to 6 maximum emissions noted, or would be lesser, with " N/A " remark, if no specific emissions from the EUT are recorded (ie: margin>20dB from the applicable limit) and considered that's already beyond the background noise floor.
5. Result = Reading + Correction Factor
Margin = Result - Limit
Remark Peak = Result(PK) - Limit(AV)
Remark AVG = Result(AV) - Limit(AV)



Product Name	Panel PC	Test By	Rex Chiu
Test Model	VM-521	Test Date	2014/11/12
Test Mode	8-DPSK TX / CH Low / External Antenna	Temp. & Humidity	23°C, 54%

966 Chamber_B at 3Meter / Horizontal									
Frequency (MHz)	Reading-PK (dBuV)	Reading-AV (dBuV)	Correction Factor (dB/m)	Result-PK (dBuV/m)	Result-AV (dBuV/m)	Limit-PK (dBuV/m)	Limit-AV (dBuV/m)	Margin (dB)	Remark
1666.00	47.53	---	-0.47	47.06	---	74.00	54.00	-6.94	Peak
1750.00	47.95	---	0.31	48.26	---	74.00	54.00	-5.74	Peak
2562.00	46.02	---	3.76	49.78	---	74.00	54.00	-4.22	Peak
4800.00	40.12	---	8.71	48.82	---	74.00	54.00	-5.18	Peak
5970.00	38.39	---	12.64	51.03	---	74.00	54.00	-2.97	Peak
7110.00	38.48	---	13.78	52.26	---	74.00	54.00	-1.74	Peak

966 Chamber_B at 3Meter / Vertical									
Frequency (MHz)	Reading-PK (dBuV)	Reading-AV (dBuV)	Correction Factor (dB/m)	Result-PK (dBuV/m)	Result-AV (dBuV/m)	Limit-PK (dBuV/m)	Limit-AV (dBuV/m)	Margin (dB)	Remark
1690.00	46.07	---	-0.25	45.82	---	74.00	54.00	-8.18	Peak
2522.00	49.33	43.46	3.66	52.99	47.12	74.00	54.00	-6.88	AVG
2562.00	50.25	44.38	3.76	54.01	48.14	74.00	54.00	-5.86	AVG
4560.00	39.62	---	8.82	48.45	---	74.00	54.00	-5.55	Peak
5985.00	38.08	---	12.70	50.78	---	74.00	54.00	-3.22	Peak
6885.00	37.91	---	13.72	51.63	---	74.00	54.00	-2.37	Peak

Remark:

1. Measuring frequencies from 1 GHz to the 10th harmonic of highest fundamental frequency.
2. Average test would be performed if the peak result were greater than the average limit.
3. Data of measurement within this frequency range shown " --- " in the table above means the reading of emissions are attenuated more than 20dB below the permissible limits or the field strength is too small to be measured.
4. Measurements above show only up to 6 maximum emissions noted, or would be lesser, with " N/A " remark, if no specific emissions from the EUT are recorded (ie: margin>20dB from the applicable limit) and considered that's already beyond the background noise floor.
5. Result = Reading + Correction Factor
Margin = Result - Limit
Remark Peak = Result(PK) - Limit(AV)
Remark AVG = Result(AV) - Limit(AV)



Product Name	Panel PC	Test By	Rex Chiu
Test Model	VM-521	Test Date	2014/11/12
Test Mode	8-DPSK TX / CH Middle / External Antenna	Temp. & Humidity	23°C, 54%

966 Chamber_B at 3Meter / Horizontal

Frequency (MHz)	Reading-PK (dBuV)	Reading-AV (dBuV)	Correction Factor (dB/m)	Result-PK (dBuV/m)	Result-AV (dBuV/m)	Limit-PK (dBuV/m)	Limit-AV (dBuV/m)	Margin (dB)	Remark
1750.00	46.77	---	0.31	47.08	---	74.00	54.00	-6.92	Peak
2522.00	49.25	43.41	3.66	52.91	47.07	74.00	54.00	-6.93	AVG
2602.00	46.48	---	3.85	50.33	---	74.00	54.00	-3.67	Peak
4380.00	39.92	---	8.25	48.17	---	74.00	54.00	-5.83	Peak
6105.00	37.76	---	12.72	50.48	---	74.00	54.00	-3.52	Peak
6975.00	38.64	---	13.99	52.63	---	74.00	54.00	-1.37	Peak

966 Chamber_B at 3Meter / Vertical

Frequency (MHz)	Reading-PK (dBuV)	Reading-AV (dBuV)	Correction Factor (dB/m)	Result-PK (dBuV/m)	Result-AV (dBuV/m)	Limit-PK (dBuV/m)	Limit-AV (dBuV/m)	Margin (dB)	Remark
2360.00	49.49	43.62	3.34	52.82	46.96	74.00	54.00	-7.04	AVG
2520.00	55.19	49.26	3.66	58.85	52.92	74.00	54.00	-1.08	AVG
2562.00	49.13	43.21	3.76	52.88	46.97	74.00	54.00	-7.03	Peak
4515.00	40.17	---	8.84	49.01	---	74.00	54.00	-4.99	Peak
6450.00	38.75	---	12.57	51.32	---	74.00	54.00	-2.68	Peak
7020.00	38.42	---	14.02	52.44	---	74.00	54.00	-1.56	Peak

Remark:

1. Measuring frequencies from 1 GHz to the 10th harmonic of highest fundamental frequency.
2. Average test would be performed if the peak result were greater than the average limit.
3. Data of measurement within this frequency range shown " --- " in the table above means the reading of emissions are attenuated more than 20dB below the permissible limits or the field strength is too small to be measured.
4. Measurements above show only up to 6 maximum emissions noted, or would be lesser, with " N/A " remark, if no specific emissions from the EUT are recorded (ie: margin>20dB from the applicable limit) and considered that's already beyond the background noise floor.
5. Result = Reading + Correction Factor
Margin = Result - Limit
Remark Peak = Result(PK) - Limit(AV)
Remark AVG = Result(AV) - Limit(AV)



Product Name	Panel PC	Test By	Rex Chiu
Test Model	VM-521	Test Date	2014/11/12
Test Mode	8-DPSK TX / CH High / External Antenna	Temp. & Humidity	23°C, 54%

966 Chamber_B at 3Meter / Horizontal

Frequency (MHz)	Reading-PK (dBuV)	Reading-AV (dBuV)	Correction Factor (dB/m)	Result-PK (dBuV/m)	Result-AV (dBuV/m)	Limit-PK (dBuV/m)	Limit-AV (dBuV/m)	Margin (dB)	Remark
1702.00	47.27	---	-0.14	47.13	---	74.00	54.00	-6.87	Peak
1798.00	46.66	---	0.76	47.42	---	74.00	54.00	-6.58	Peak
2560.00	49.61	43.82	3.75	53.36	47.57	74.00	54.00	-6.43	AVG
4440.00	39.65	---	8.55	48.20	---	74.00	54.00	-5.80	Peak
6270.00	38.50	---	12.65	51.15	---	74.00	54.00	-2.85	Peak
7005.00	38.02	---	14.06	52.07	---	74.00	54.00	-1.93	Peak

966 Chamber_B at 3Meter / Vertical

Frequency (MHz)	Reading-PK (dBuV)	Reading-AV (dBuV)	Correction Factor (dB/m)	Result-PK (dBuV/m)	Result-AV (dBuV/m)	Limit-PK (dBuV/m)	Limit-AV (dBuV/m)	Margin (dB)	Remark
2380.00	46.33	---	3.37	49.71	---	74.00	54.00	-4.29	Peak
2560.00	53.92	48.32	3.75	57.68	52.07	74.00	54.00	-1.93	AVG
2580.00	49.70	43.78	3.80	53.50	47.58	74.00	54.00	-6.42	AVG
4515.00	39.71	---	8.84	48.55	---	74.00	54.00	-5.45	Peak
6195.00	38.91	---	12.68	51.59	---	74.00	54.00	-2.41	Peak
6900.00	38.61	---	13.77	52.37	---	74.00	54.00	-1.63	Peak

Remark:

1. Measuring frequencies from 1 GHz to the 10th harmonic of highest fundamental frequency.
2. Average test would be performed if the peak result were greater than the average limit.
3. Data of measurement within this frequency range shown " --- " in the table above means the reading of emissions are attenuated more than 20dB below the permissible limits or the field strength is too small to be measured.
4. Measurements above show only up to 6 maximum emissions noted, or would be lesser, with " N/A " remark, if no specific emissions from the EUT are recorded (ie: margin>20dB from the applicable limit) and considered that's already beyond the background noise floor.
5. Result = Reading + Correction Factor
Margin = Result - Limit
Remark Peak = Result(PK) - Limit(AV)
Remark AVG = Result(AV) - Limit(AV)



Product Name	Panel PC	Test By	Rex Chiu
Test Model	VM-521	Test Date	2014/11/11
Test Mode	GFSK TX / CH Low / Internal Antenna	Temp. & Humidity	24°C, 52%

966 Chamber_B at 3Meter / Horizontal									
Frequency (MHz)	Reading-PK (dBuV)	Reading-AV (dBuV)	Correction Factor (dB/m)	Result-PK (dBuV/m)	Result-AV (dBuV/m)	Limit-PK (dBuV/m)	Limit-AV (dBuV/m)	Margin (dB)	Remark
1666.00	50.54	---	-0.47	50.07	---	74.00	54.00	-3.93	Peak
1796.00	45.98	---	0.74	46.72	---	74.00	54.00	-7.28	Peak
2562.00	51.92	46.17	3.76	55.68	49.93	74.00	54.00	-4.07	AVG
4695.00	39.61	---	8.76	48.37	---	74.00	54.00	-5.63	Peak
6285.00	38.82	---	12.64	51.46	---	74.00	54.00	-2.54	Peak
7140.00	38.32	---	13.70	52.03	---	74.00	54.00	-1.97	Peak

966 Chamber_B at 3Meter / Vertical									
Frequency (MHz)	Reading-PK (dBuV)	Reading-AV (dBuV)	Correction Factor (dB/m)	Result-PK (dBuV/m)	Result-AV (dBuV/m)	Limit-PK (dBuV/m)	Limit-AV (dBuV/m)	Margin (dB)	Remark
1996.00	43.99	---	2.59	46.58	---	74.00	54.00	-7.42	Peak
2522.00	49.85	43.59	3.66	53.51	47.25	74.00	54.00	-6.75	AVG
2562.00	51.11	44.59	3.76	54.87	48.35	74.00	54.00	-5.65	AVG
4650.00	39.27	---	8.78	48.05	---	74.00	54.00	-5.95	Peak
5970.00	38.24	---	12.64	50.88	---	74.00	54.00	-3.12	Peak
6960.00	38.53	---	13.95	52.48	---	74.00	54.00	-1.52	Peak

Remark:

1. Measuring frequencies from 1 GHz to the 10th harmonic of highest fundamental frequency.
2. Average test would be performed if the peak result were greater than the average limit.
3. Data of measurement within this frequency range shown " --- " in the table above means the reading of emissions are attenuated more than 20dB below the permissible limits or the field strength is too small to be measured.
4. Measurements above show only up to 6 maximum emissions noted, or would be lesser, with " N/A " remark, if no specific emissions from the EUT are recorded (ie: margin>20dB from the applicable limit) and considered that's already beyond the background noise floor.
5. Result = Reading + Correction Factor
Margin = Result - Limit
Remark Peak = Result(PK) - Limit(AV)
Remark AVG = Result(AV) - Limit(AV)



Product Name	Panel PC	Test By	Rex Chiu
Test Model	VM-521	Test Date	2014/11/11
Test Mode	GFSK TX / CH Middle / Internal Antenna	Temp. & Humidity	24°C, 52%

966 Chamber_B at 3Meter / Horizontal									
Frequency (MHz)	Reading-PK (dBuV)	Reading-AV (dBuV)	Correction Factor (dB/m)	Result-PK (dBuV/m)	Result-AV (dBuV/m)	Limit-PK (dBuV/m)	Limit-AV (dBuV/m)	Margin (dB)	Remark
1796.00	46.79	---	0.74	47.53	---	74.00	54.00	-6.47	Peak
2500.00	46.63	---	3.61	50.24	---	74.00	54.00	-3.76	Peak
2520.00	54.54	48.36	3.66	58.20	52.02	74.00	54.00	-1.98	AVG
4875.00	39.97	---	8.67	48.64	---	74.00	54.00	-5.36	Peak
6135.00	39.51	---	12.71	52.22	---	74.00	54.00	-1.78	Peak
7140.00	38.68	---	13.70	52.38	---	74.00	54.00	-1.62	Peak

966 Chamber_B at 3Meter / Vertical									
Frequency (MHz)	Reading-PK (dBuV)	Reading-AV (dBuV)	Correction Factor (dB/m)	Result-PK (dBuV/m)	Result-AV (dBuV/m)	Limit-PK (dBuV/m)	Limit-AV (dBuV/m)	Margin (dB)	Remark
2362.00	44.75	---	3.34	48.09	---	74.00	54.00	-5.91	Peak
2502.00	47.04	---	3.61	50.66	---	74.00	54.00	-3.34	Peak
2520.00	54.45	48.52	3.66	58.11	52.18	74.00	54.00	-1.82	AVG
4515.00	40.57	---	8.84	49.42	---	74.00	54.00	-4.58	Peak
6090.00	38.46	---	12.73	51.19	---	74.00	54.00	-2.81	Peak
7080.00	38.53	---	13.86	52.39	---	74.00	54.00	-1.61	Peak

Remark:

1. Measuring frequencies from 1 GHz to the 10th harmonic of highest fundamental frequency.
2. Average test would be performed if the peak result were greater than the average limit.
3. Data of measurement within this frequency range shown " --- " in the table above means the reading of emissions are attenuated more than 20dB below the permissible limits or the field strength is too small to be measured.
4. Measurements above show only up to 6 maximum emissions noted, or would be lesser, with " N/A " remark, if no specific emissions from the EUT are recorded (ie: margin>20dB from the applicable limit) and considered that's already beyond the background noise floor.
5. Result = Reading + Correction Factor
Margin = Result - Limit
Remark Peak = Result(PK) - Limit(AV)
Remark AVG = Result(AV) - Limit(AV)



Product Name	Panel PC	Test By	Rex Chiu
Test Model	VM-521	Test Date	2014/11/11
Test Mode	GFSK TX / CH High / Internal Antenna	Temp. & Humidity	24°C, 52%

966 Chamber_B at 3Meter / Horizontal									
Frequency (MHz)	Reading-PK (dBuV)	Reading-AV (dBuV)	Correction Factor (dB/m)	Result-PK (dBuV/m)	Result-AV (dBuV/m)	Limit-PK (dBuV/m)	Limit-AV (dBuV/m)	Margin (dB)	Remark
1714.00	49.06	---	-0.02	49.03	---	74.00	54.00	-4.97	Peak
2540.00	48.12	---	3.70	51.83	---	74.00	54.00	-2.17	Peak
2560.00	53.54	47.62	3.75	57.29	51.37	74.00	54.00	-2.63	AVG
4470.00	39.67	---	8.70	48.37	---	74.00	54.00	-5.63	Peak
6075.00	38.53	---	12.74	51.26	---	74.00	54.00	-2.74	Peak
7095.00	38.66	---	13.82	52.48	---	74.00	54.00	-1.52	Peak

966 Chamber_B at 3Meter / Vertical									
Frequency (MHz)	Reading-PK (dBuV)	Reading-AV (dBuV)	Correction Factor (dB/m)	Result-PK (dBuV/m)	Result-AV (dBuV/m)	Limit-PK (dBuV/m)	Limit-AV (dBuV/m)	Margin (dB)	Remark
1958.00	43.73	---	2.24	45.97	---	74.00	54.00	-8.03	Peak
2540.00	47.23	---	3.70	50.93	---	74.00	54.00	-3.07	Peak
2560.00	52.36	46.45	3.75	56.11	50.20	74.00	54.00	-3.80	AVG
4500.00	40.26	---	8.85	49.11	---	74.00	54.00	-4.89	Peak
6075.00	39.17	---	12.74	51.91	---	74.00	54.00	-2.09	Peak
7095.00	38.64	---	13.82	52.46	---	74.00	54.00	-1.54	Peak

Remark:

1. Measuring frequencies from 1 GHz to the 10th harmonic of highest fundamental frequency.
2. Average test would be performed if the peak result were greater than the average limit.
3. Data of measurement within this frequency range shown " --- " in the table above means the reading of emissions are attenuated more than 20dB below the permissible limits or the field strength is too small to be measured.
4. Measurements above show only up to 6 maximum emissions noted, or would be lesser, with " N/A " remark, if no specific emissions from the EUT are recorded (ie: margin>20dB from the applicable limit) and considered that's already beyond the background noise floor.
5. Result = Reading + Correction Factor
Margin = Result - Limit
Remark Peak = Result(PK) - Limit(AV)
Remark AVG = Result(AV) - Limit(AV)



Product Name	Panel PC	Test By	Rex Chiu
Test Model	VM-521	Test Date	2014/11/11
Test Mode	8-DPSK TX / CH Low / Internal Antenna	Temp. & Humidity	24°C, 52%

966 Chamber_B at 3Meter / Horizontal

Frequency (MHz)	Reading-PK (dBuV)	Reading-AV (dBuV)	Correction Factor (dB/m)	Result-PK (dBuV/m)	Result-AV (dBuV/m)	Limit-PK (dBuV/m)	Limit-AV (dBuV/m)	Margin (dB)	Remark
1836.00	48.54	---	1.11	49.65	---	74.00	54.00	-4.35	Peak
2522.00	48.04	---	3.66	51.70	---	74.00	54.00	-2.30	Peak
2562.00	48.40	---	3.76	52.16	---	74.00	54.00	-1.84	Peak
4620.00	40.32	---	8.79	49.12	---	74.00	54.00	-4.88	Peak
5520.00	40.27	---	10.69	50.96	---	74.00	54.00	-3.04	Peak
6990.00	38.36	---	14.04	52.40	---	74.00	54.00	-1.60	Peak

966 Chamber_B at 3Meter / Vertical

Frequency (MHz)	Reading-PK (dBuV)	Reading-AV (dBuV)	Correction Factor (dB/m)	Result-PK (dBuV/m)	Result-AV (dBuV/m)	Limit-PK (dBuV/m)	Limit-AV (dBuV/m)	Margin (dB)	Remark
2088.00	43.00	---	2.80	45.80	---	74.00	54.00	-8.20	Peak
2562.00	47.68	---	3.76	51.44	---	74.00	54.00	-2.56	Peak
2740.00	42.99	---	4.18	47.17	---	74.00	54.00	-6.83	Peak
4605.00	39.72	---	8.80	48.52	---	74.00	54.00	-5.48	Peak
5865.00	38.57	---	12.18	50.76	---	74.00	54.00	-3.24	Peak
7170.00	38.61	---	13.62	52.23	---	74.00	54.00	-1.77	Peak

Remark:

1. Measuring frequencies from 1 GHz to the 10th harmonic of highest fundamental frequency.
2. Average test would be performed if the peak result were greater than the average limit.
3. Data of measurement within this frequency range shown " --- " in the table above means the reading of emissions are attenuated more than 20dB below the permissible limits or the field strength is too small to be measured.
4. Measurements above show only up to 6 maximum emissions noted, or would be lesser, with " N/A " remark, if no specific emissions from the EUT are recorded (ie: margin>20dB from the applicable limit) and considered that's already beyond the background noise floor.
5. Result = Reading + Correction Factor
Margin = Result - Limit
Remark Peak = Result(PK) - Limit(AV)
Remark AVG = Result(AV) - Limit(AV)



Product Name	Panel PC	Test By	Rex Chiu
Test Model	VM-521	Test Date	2014/11/11
Test Mode	8-DPSK TX / CH Middle / Internal Antenna	Temp. & Humidity	24°C, 52%

966 Chamber_B at 3Meter / Horizontal									
Frequency (MHz)	Reading-PK (dBuV)	Reading-AV (dBuV)	Correction Factor (dB/m)	Result-PK (dBuV/m)	Result-AV (dBuV/m)	Limit-PK (dBuV/m)	Limit-AV (dBuV/m)	Margin (dB)	Remark
1702.00	47.77	---	-0.14	47.64	---	74.00	54.00	-6.36	Peak
1788.00	46.91	---	0.66	47.57	---	74.00	54.00	-6.43	Peak
2520.00	50.89	44.96	3.66	54.55	48.62	74.00	54.00	-5.38	AVG
4410.00	40.19	---	8.40	48.59	---	74.00	54.00	-5.41	Peak
6090.00	38.05	---	12.73	50.78	---	74.00	54.00	-3.22	Peak
7140.00	38.81	---	13.70	52.51	---	74.00	54.00	-1.49	Peak

966 Chamber_B at 3Meter / Vertical									
Frequency (MHz)	Reading-PK (dBuV)	Reading-AV (dBuV)	Correction Factor (dB/m)	Result-PK (dBuV/m)	Result-AV (dBuV/m)	Limit-PK (dBuV/m)	Limit-AV (dBuV/m)	Margin (dB)	Remark
2038.00	43.64	---	2.70	46.35	---	74.00	54.00	-7.65	Peak
2520.00	50.77	44.85	3.66	54.43	48.51	74.00	54.00	-5.49	AVG
2540.00	46.44	---	3.70	50.15	---	74.00	54.00	-3.85	Peak
4545.00	39.74	---	8.83	48.57	---	74.00	54.00	-5.43	Peak
5580.00	39.34	---	10.95	50.28	---	74.00	54.00	-3.72	Peak
7155.00	38.50	---	13.66	52.16	---	74.00	54.00	-1.84	Peak

Remark:

1. Measuring frequencies from 1 GHz to the 10th harmonic of highest fundamental frequency.
2. Average test would be performed if the peak result were greater than the average limit.
3. Data of measurement within this frequency range shown " --- " in the table above means the reading of emissions are attenuated more than 20dB below the permissible limits or the field strength is too small to be measured.
4. Measurements above show only up to 6 maximum emissions noted, or would be lesser, with " N/A " remark, if no specific emissions from the EUT are recorded (ie: margin>20dB from the applicable limit) and considered that's already beyond the background noise floor.
5. Result = Reading + Correction Factor
Margin = Result - Limit
Remark Peak = Result(PK) - Limit(AV)
Remark AVG = Result(AV) - Limit(AV)



Product Name	Panel PC	Test By	Rex Chiu
Test Model	VM-521	Test Date	2014/11/11
Test Mode	8-DPSK TX / CH High / Internal Antenna	Temp. & Humidity	24°C, 52%

966 Chamber_B at 3Meter / Horizontal									
Frequency (MHz)	Reading-PK (dBuV)	Reading-AV (dBuV)	Correction Factor (dB/m)	Result-PK (dBuV/m)	Result-AV (dBuV/m)	Limit-PK (dBuV/m)	Limit-AV (dBuV/m)	Margin (dB)	Remark
1666.00	48.53	---	-0.47	48.06	---	74.00	54.00	-5.94	Peak
1786.00	47.17	---	0.64	47.81	---	74.00	54.00	-6.19	Peak
2560.00	51.49	45.56	3.75	55.24	49.31	74.00	54.00	-4.69	AVG
4455.00	40.06	---	8.62	48.69	---	74.00	54.00	-5.31	Peak
6030.00	38.64	---	12.76	51.40	---	74.00	54.00	-2.60	Peak
7035.00	38.00	---	13.98	51.97	---	74.00	54.00	-2.03	Peak

966 Chamber_B at 3Meter / Vertical									
Frequency (MHz)	Reading-PK (dBuV)	Reading-AV (dBuV)	Correction Factor (dB/m)	Result-PK (dBuV/m)	Result-AV (dBuV/m)	Limit-PK (dBuV/m)	Limit-AV (dBuV/m)	Margin (dB)	Remark
2188.00	43.30	---	3.00	46.30	---	74.00	54.00	-7.70	Peak
2540.00	46.30	---	3.70	50.01	---	74.00	54.00	-3.99	Peak
2560.00	51.05	45.17	3.75	54.80	48.92	74.00	54.00	-5.08	AVG
4680.00	40.39	---	8.76	49.16	---	74.00	54.00	-4.84	Peak
5970.00	38.17	---	12.64	50.81	---	74.00	54.00	-3.19	Peak
6960.00	38.55	---	13.95	52.50	---	74.00	54.00	-1.50	Peak

Remark:

1. Measuring frequencies from 1 GHz to the 10th harmonic of highest fundamental frequency.
2. Average test would be performed if the peak result were greater than the average limit.
3. Data of measurement within this frequency range shown " --- " in the table above means the reading of emissions are attenuated more than 20dB below the permissible limits or the field strength is too small to be measured.
4. Measurements above show only up to 6 maximum emissions noted, or would be lesser, with " N/A " remark, if no specific emissions from the EUT are recorded (ie: margin>20dB from the applicable limit) and considered that's already beyond the background noise floor.
5. Result = Reading + Correction Factor
Margin = Result - Limit
Remark Peak = Result(PK) - Limit(AV)
Remark AVG = Result(AV) - Limit(AV)



Restricted Band Edges

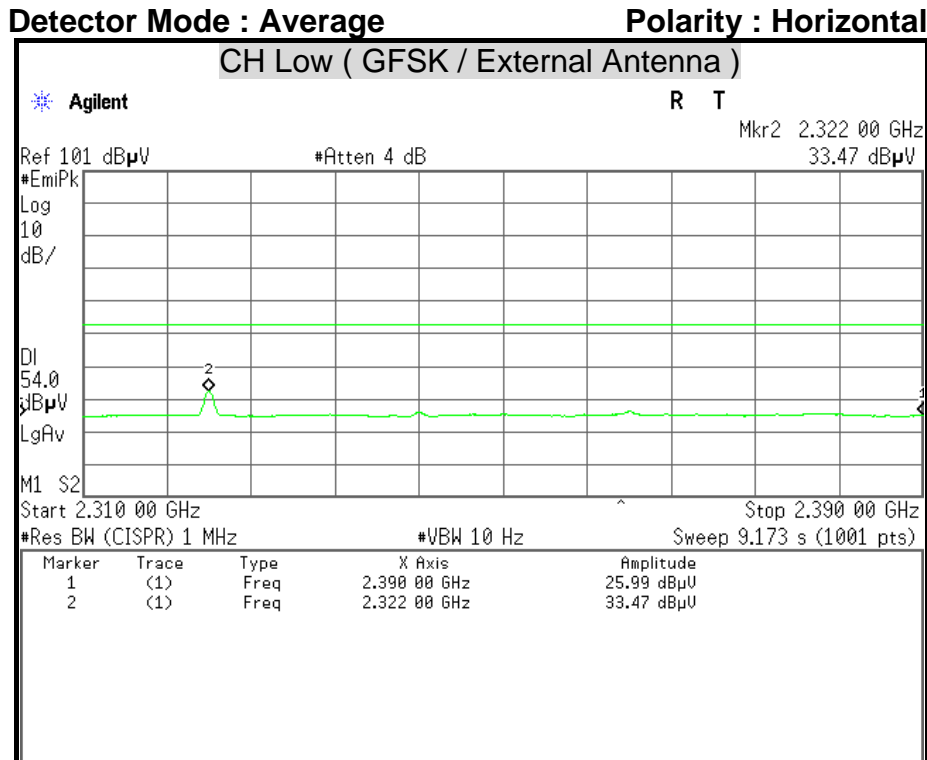
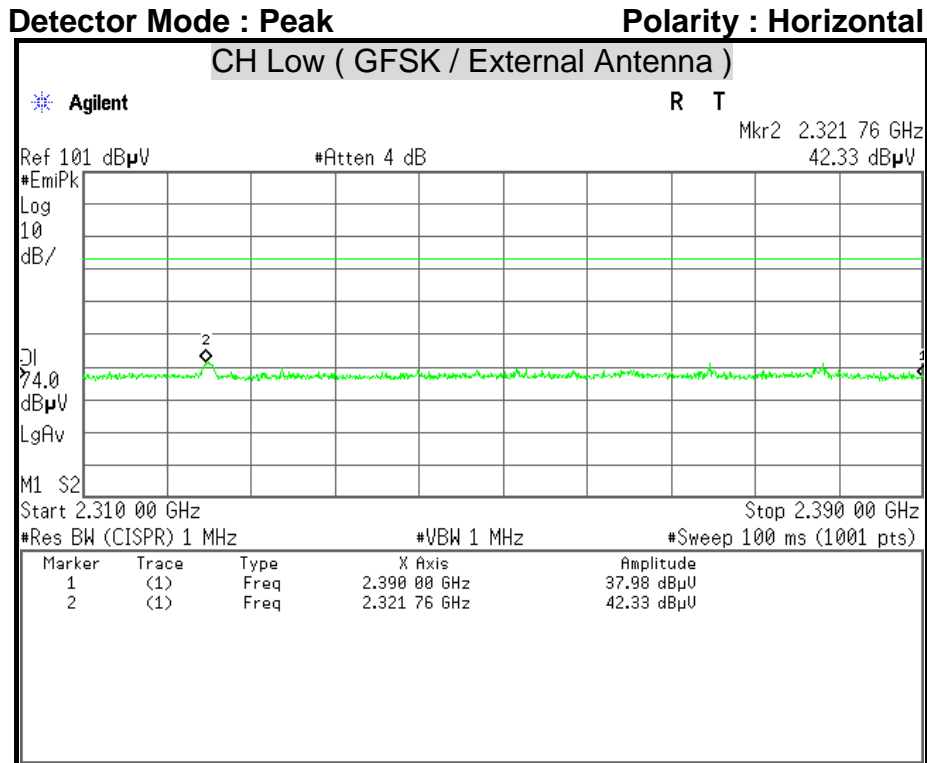



Detector Mode : Peak

Polarity : Vertical

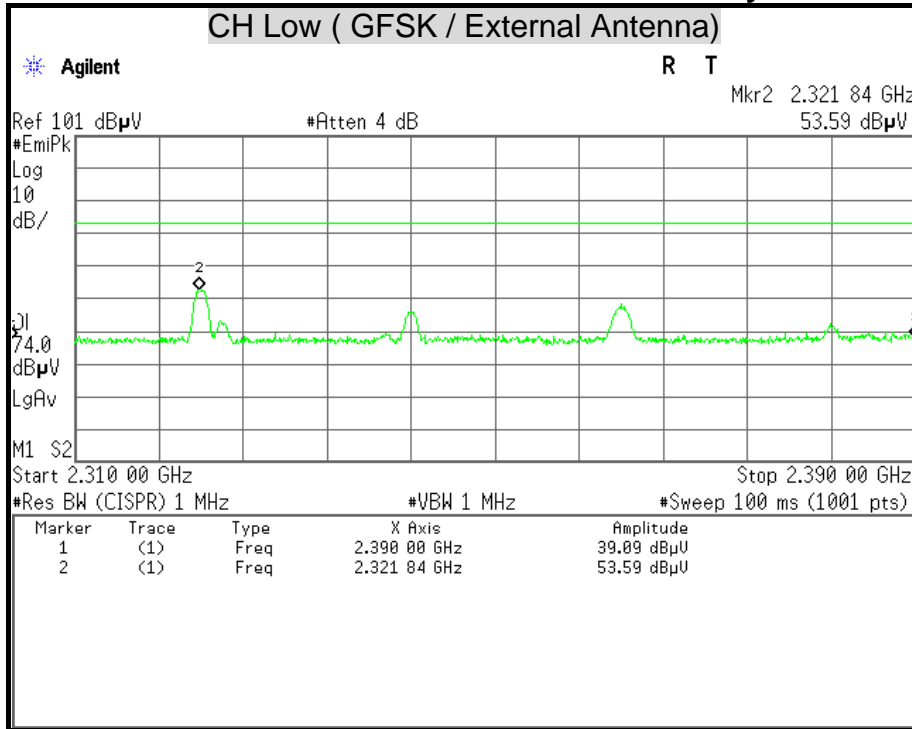

Detector Mode : Average

Polarity : Vertical

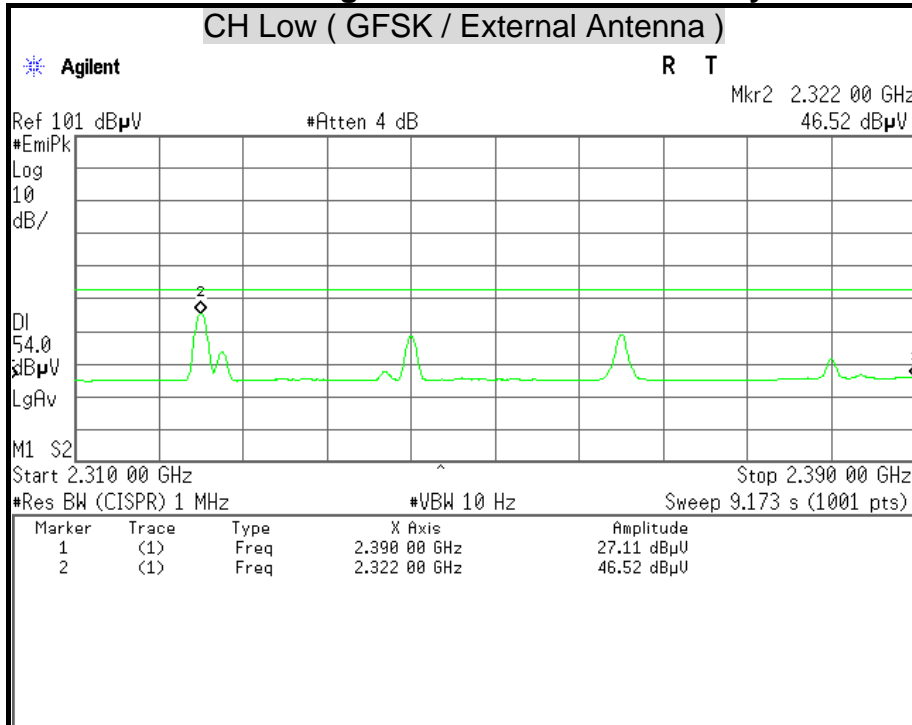



Detector Mode : Peak

Polarity : Horizontal

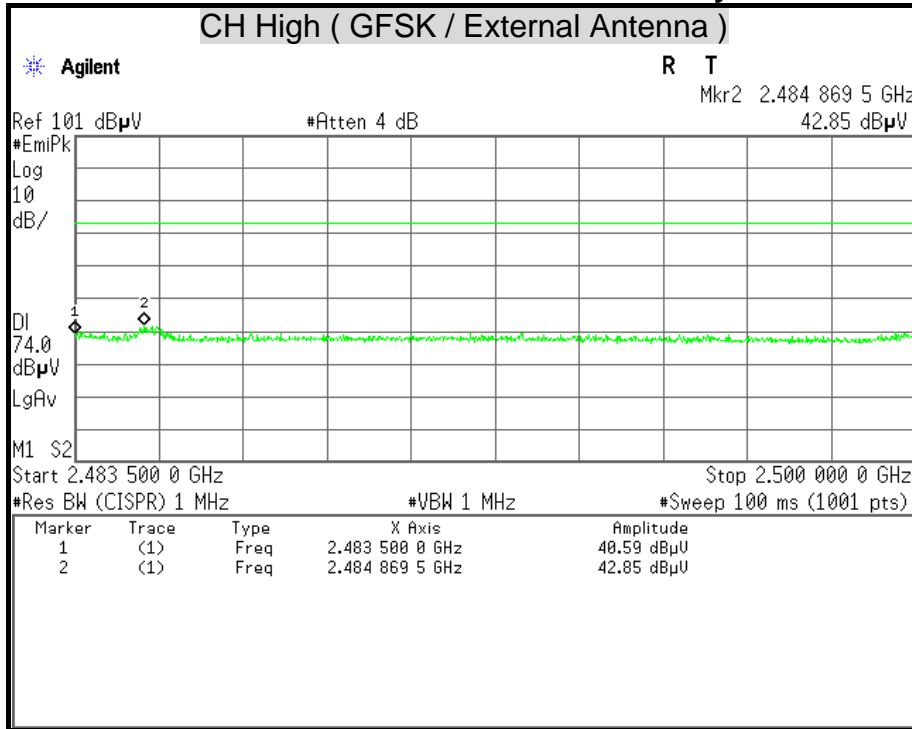

Detector Mode : Average

Polarity : Horizontal

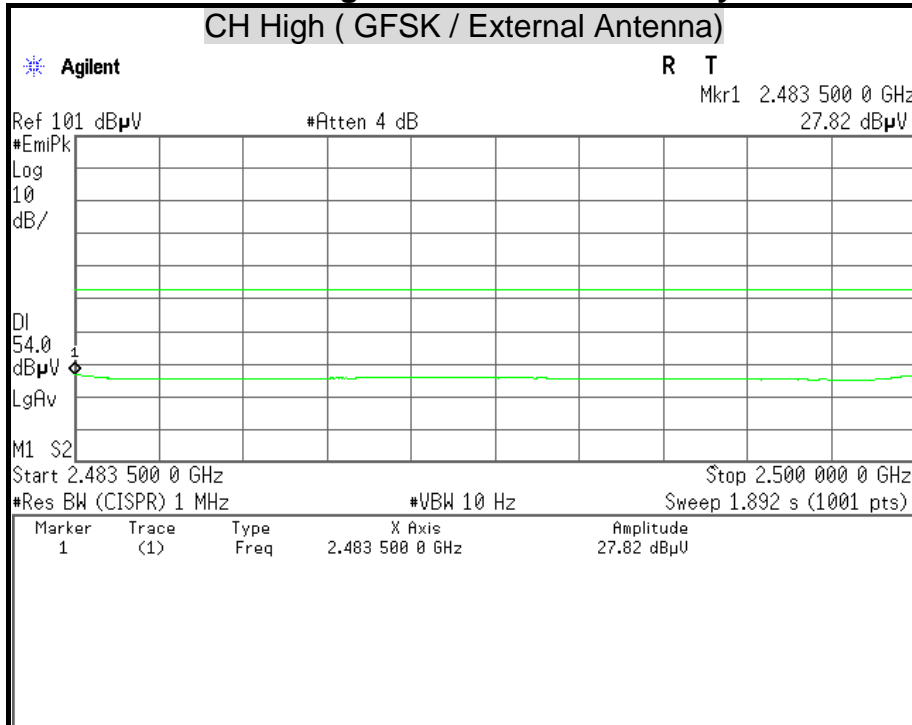



Detector Mode : Peak

Polarity : Vertical

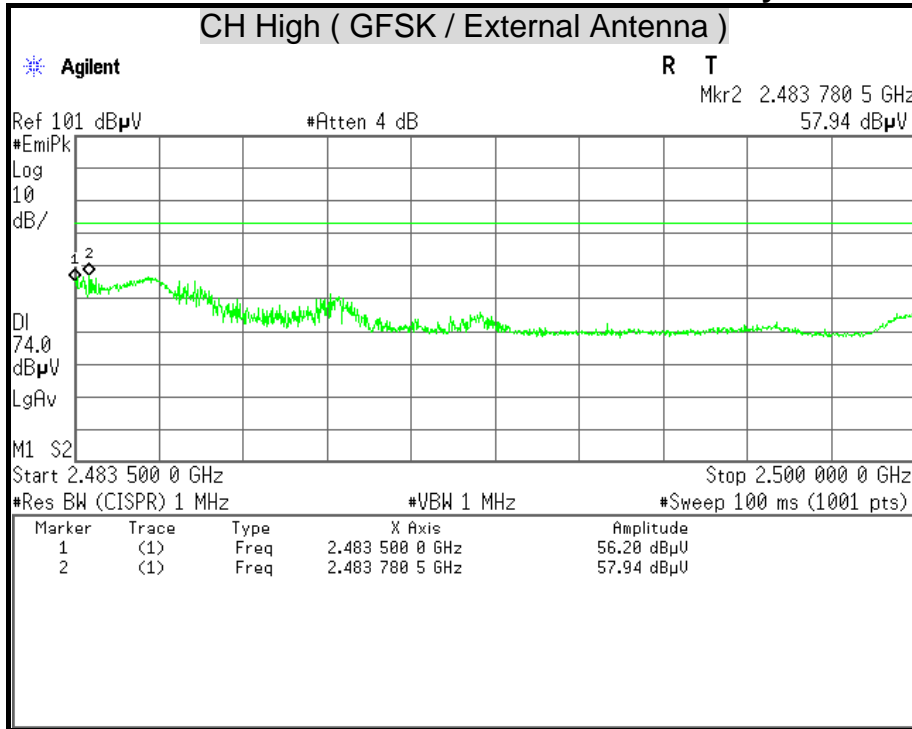

Detector Mode : Average

Polarity : Vertical

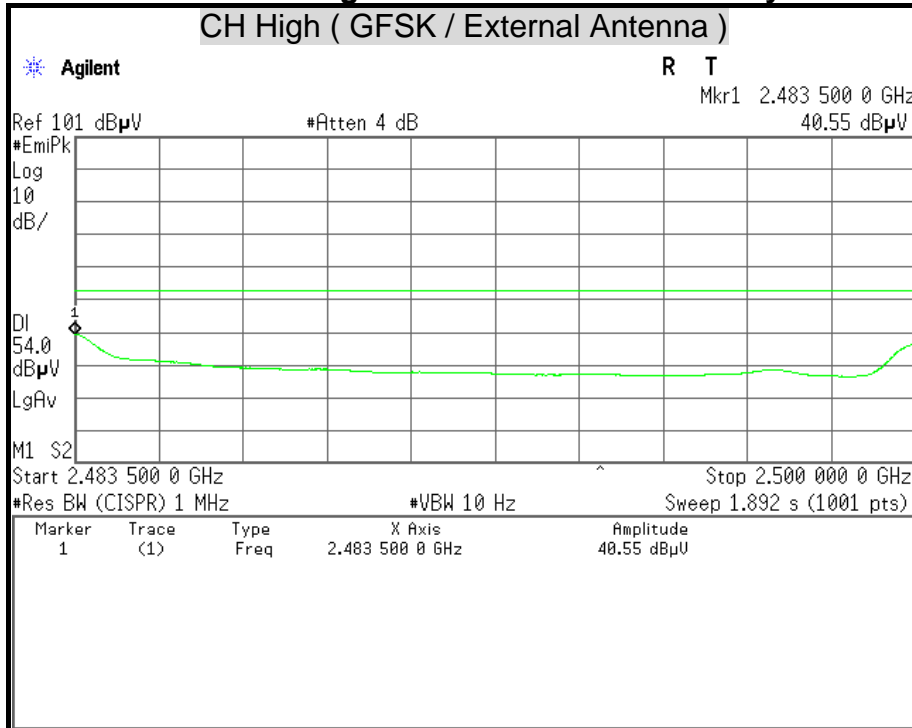



Detector Mode : Peak

Polarity : Horizontal

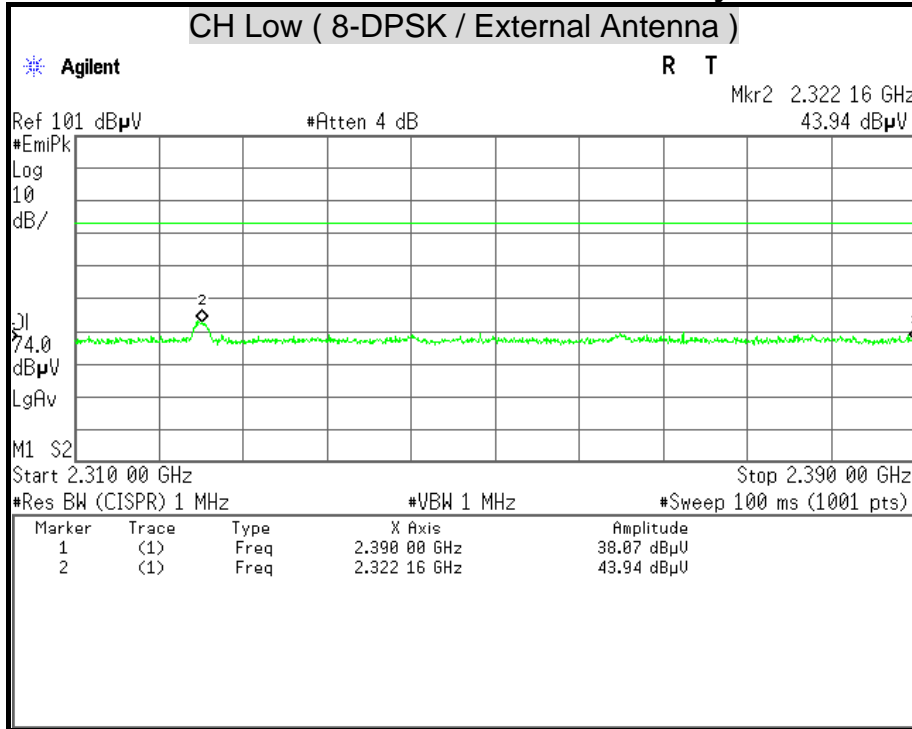

Detector Mode : Average

Polarity : Horizontal

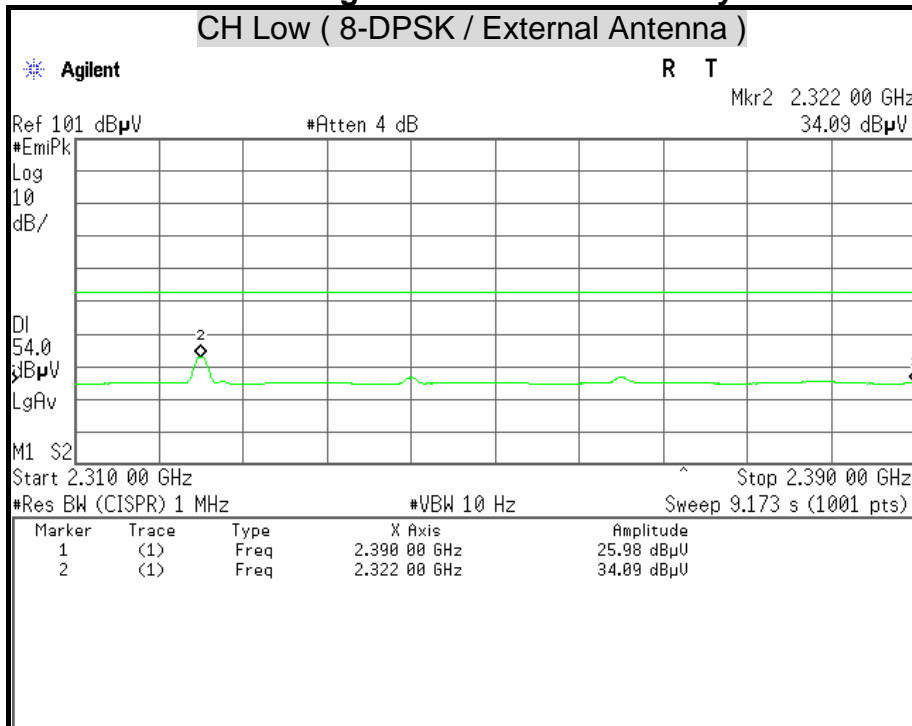



Detector Mode : Peak

Polarity : Vertical

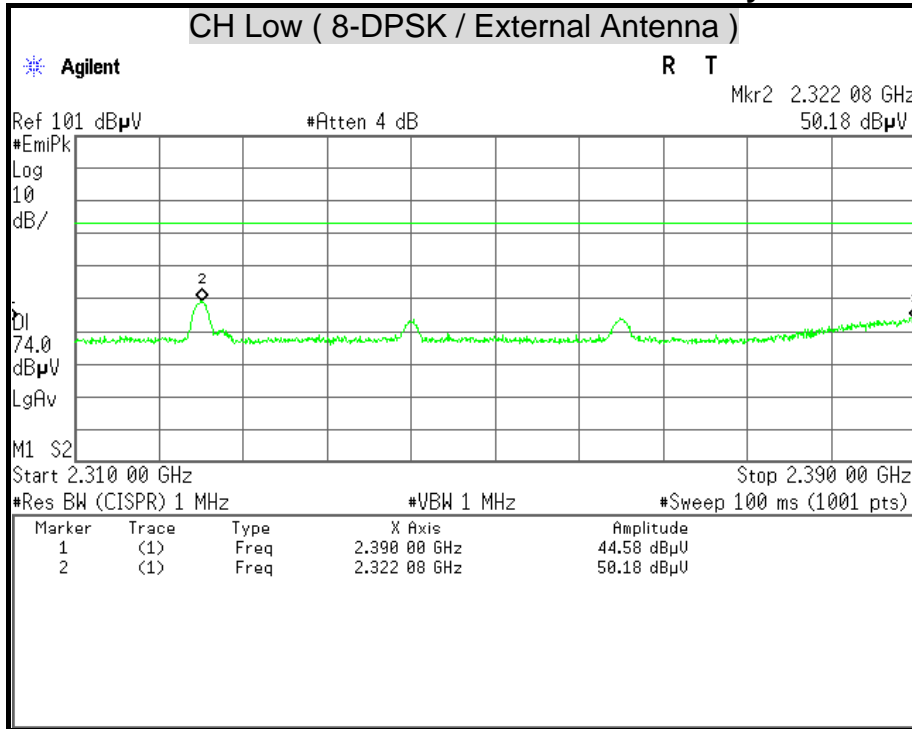

Detector Mode : Average

Polarity : Vertical

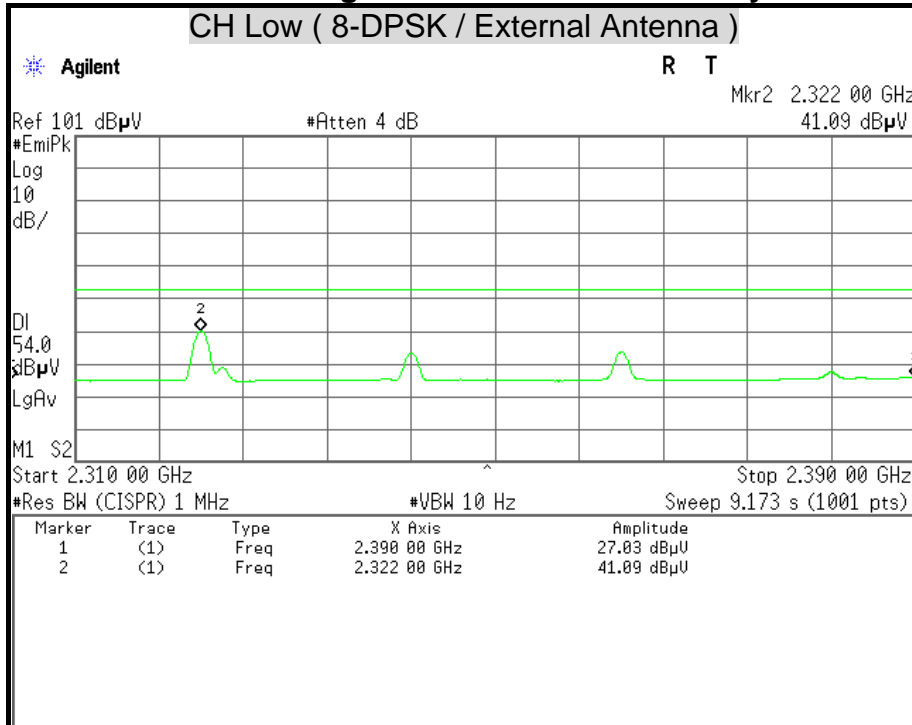



Detector Mode : Peak

Polarity : Horizontal

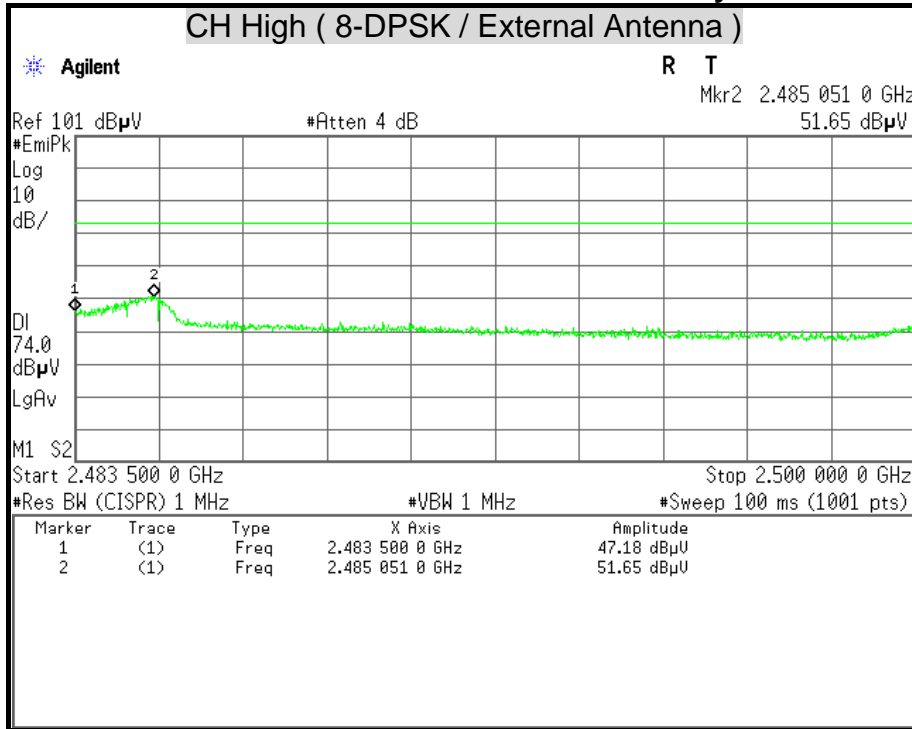

Detector Mode : Average

Polarity : Horizontal

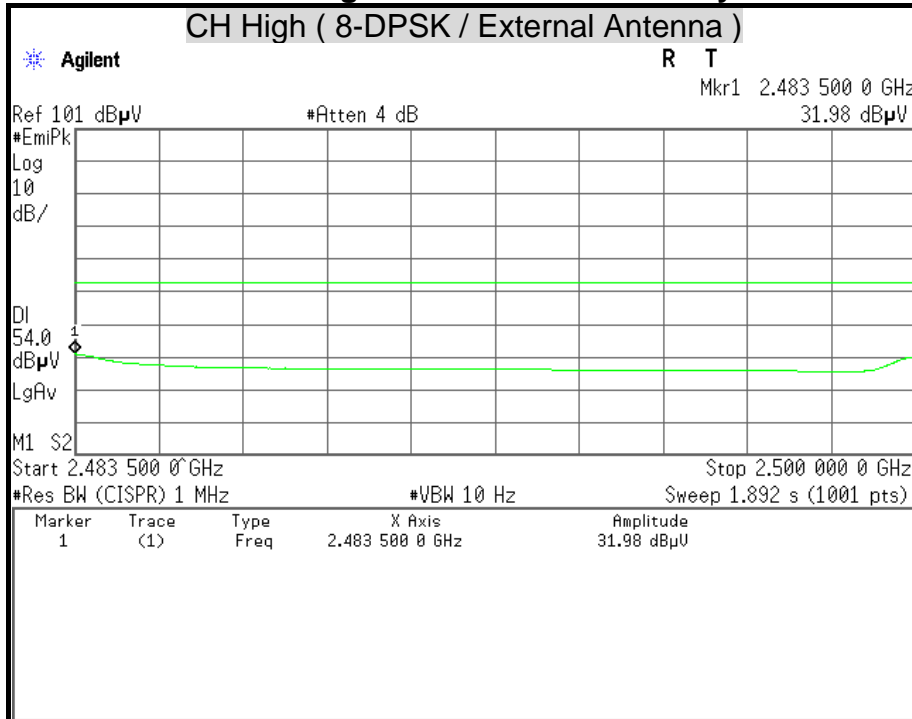



Detector Mode : Peak

Polarity : Vertical

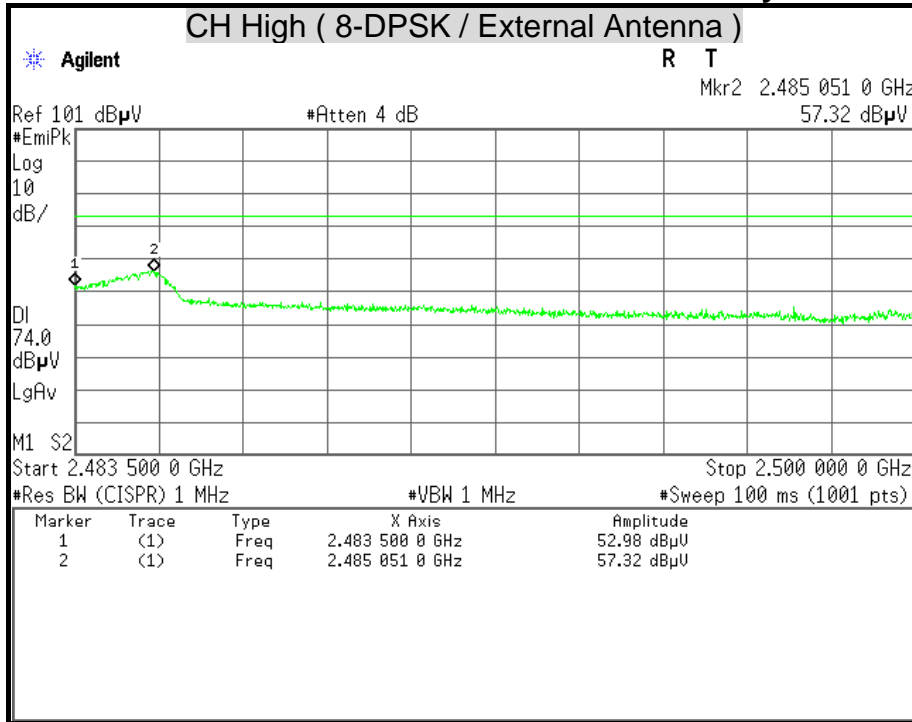

Detector Mode : Average

Polarity : Vertical

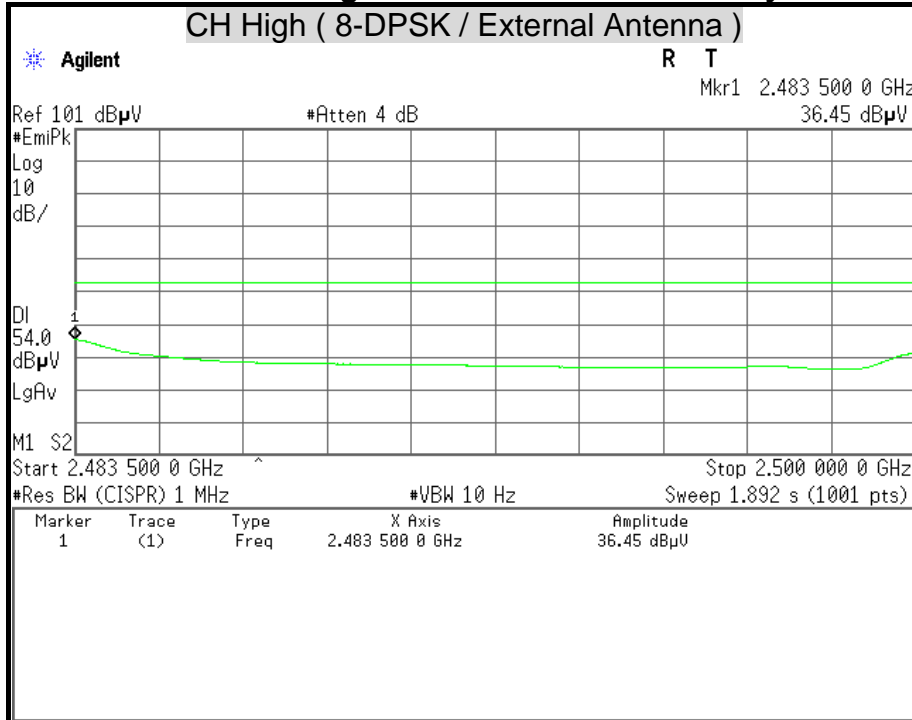



Detector Mode : Peak Polarity : Horizontal

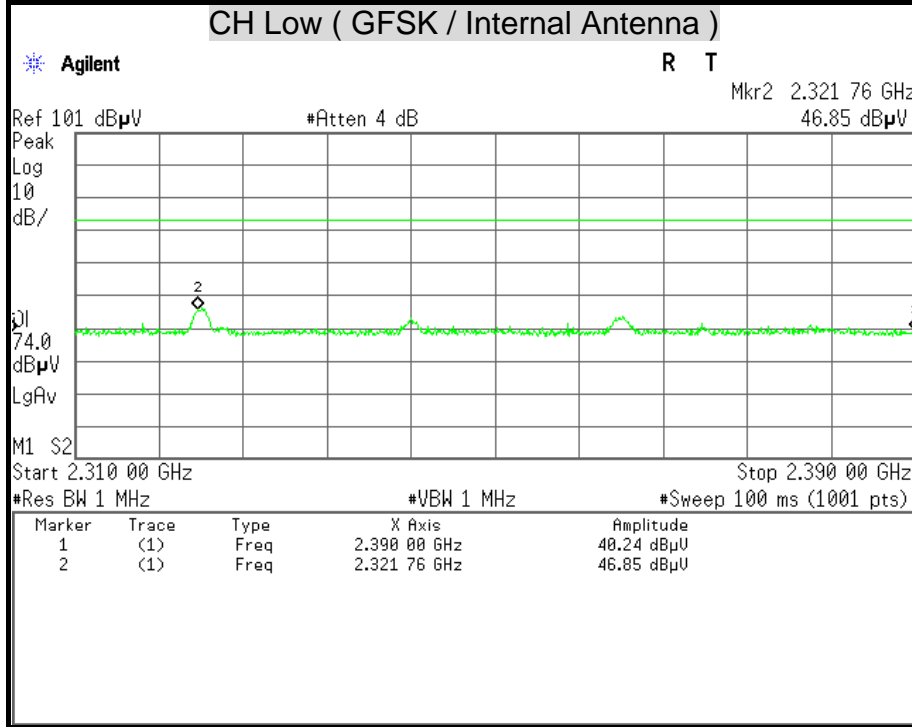

Detector Mode : Average Polarity : Horizontal

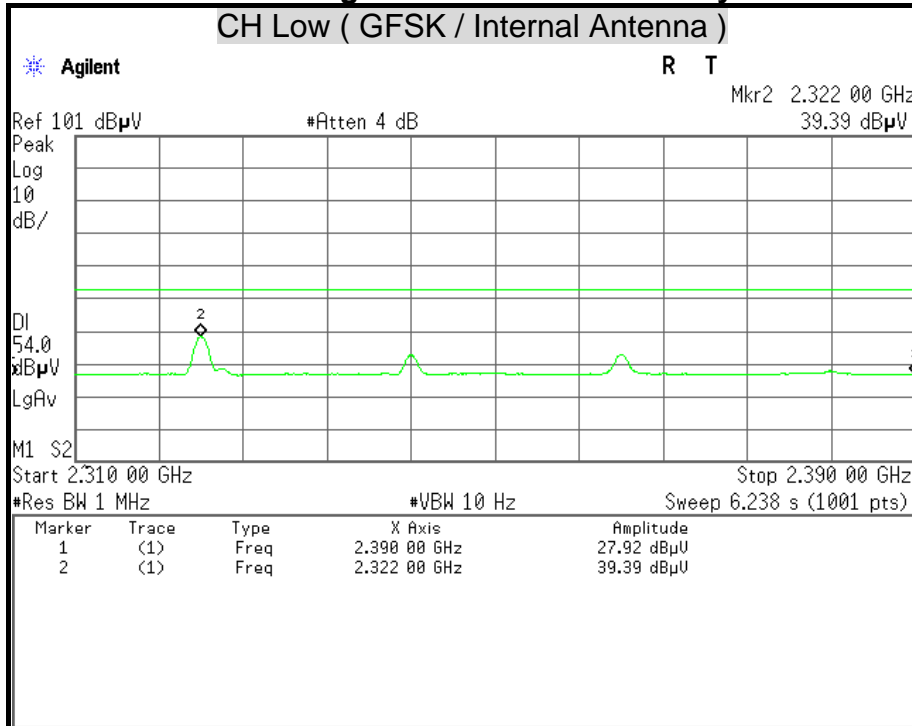



Detector Mode : Peak

Polarity : Vertical

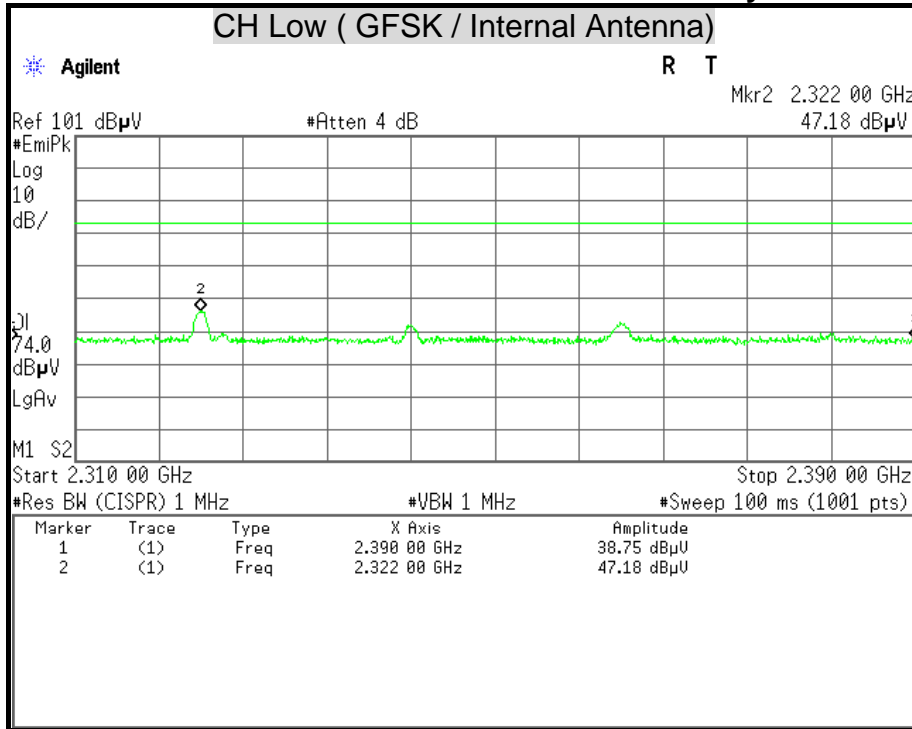

Detector Mode : Average

Polarity : Vertical

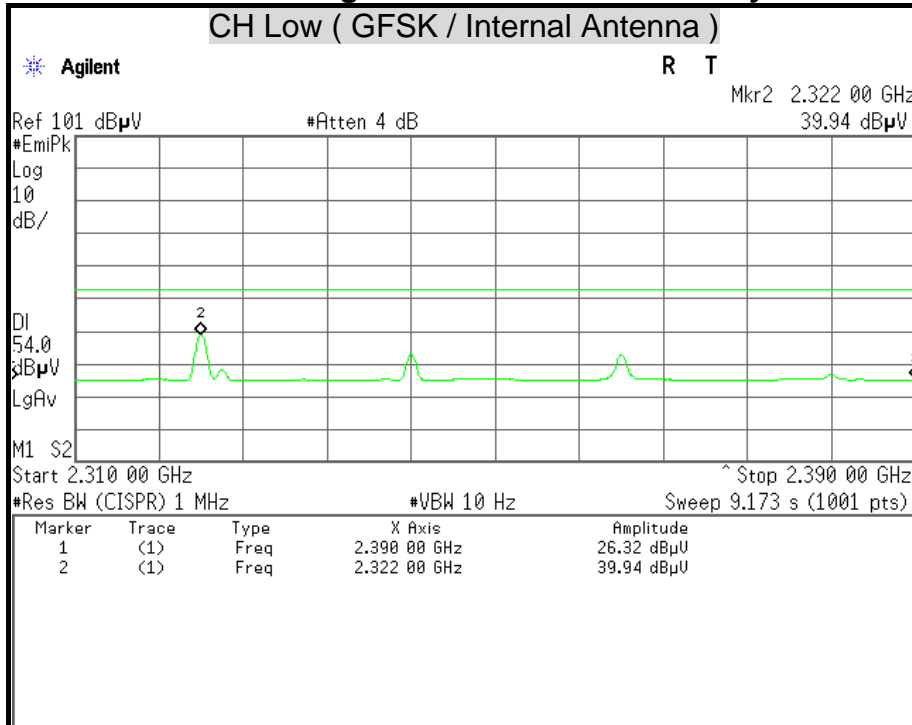



Detector Mode : Peak

Polarity : Horizontal

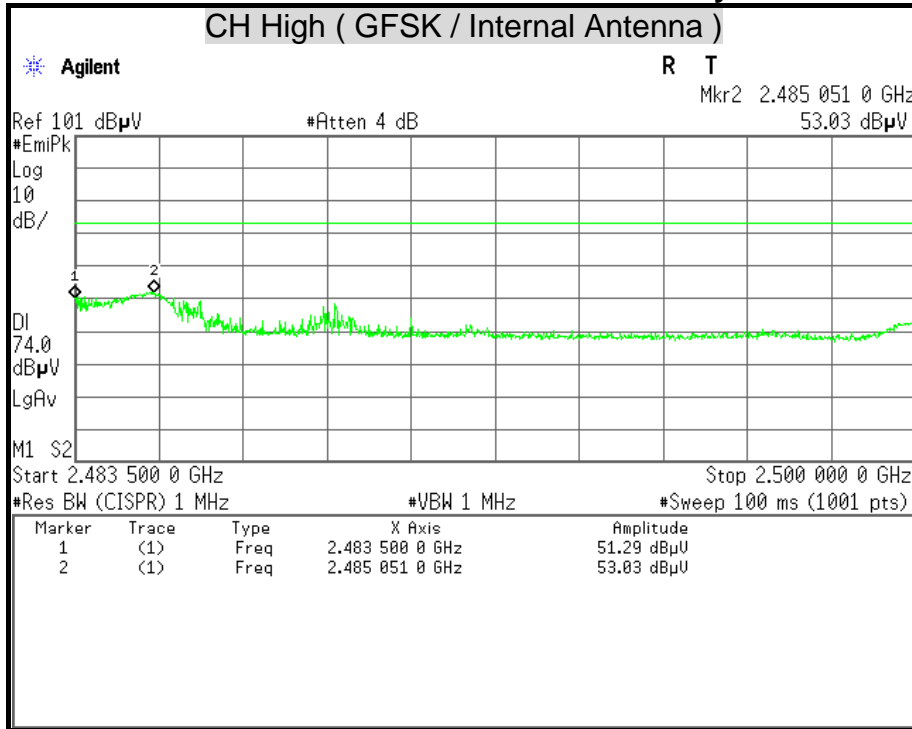

Detector Mode : Average

Polarity : Horizontal

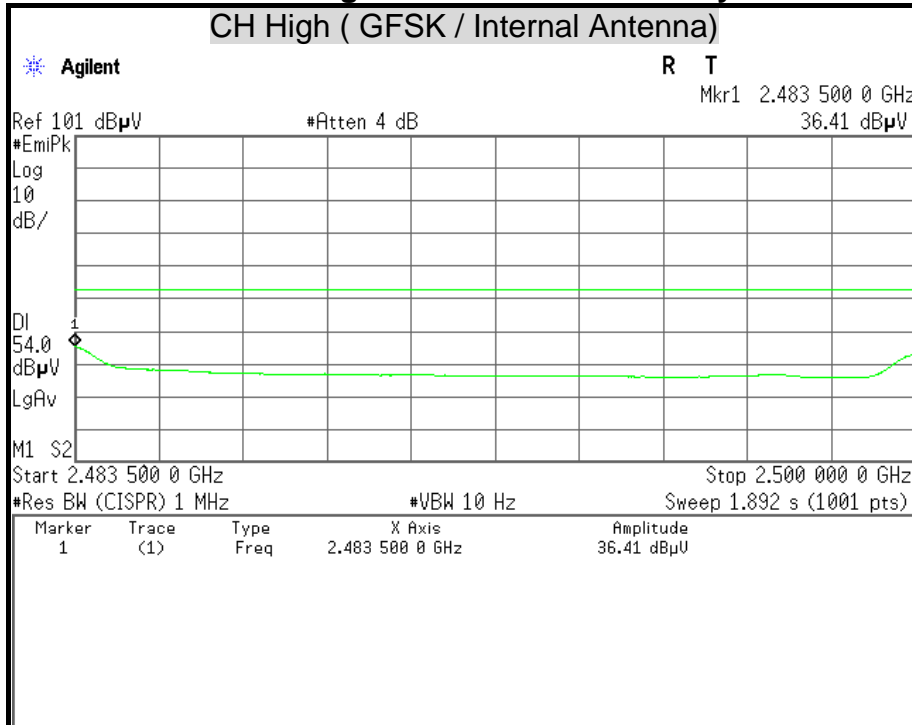



Detector Mode : Peak

Polarity : Vertical

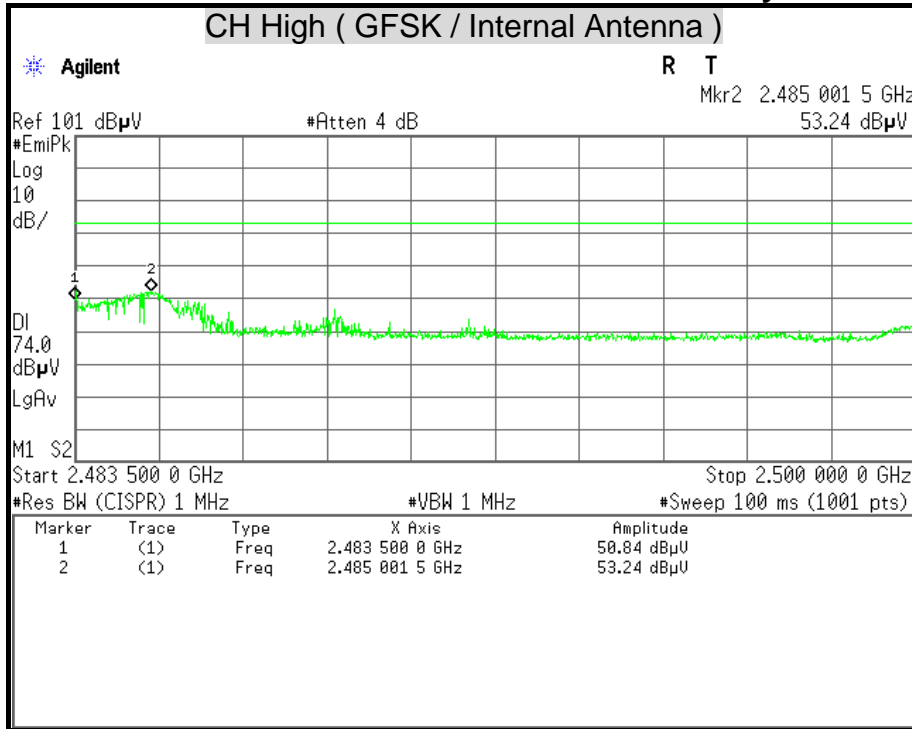

Detector Mode : Average

Polarity : Vertical

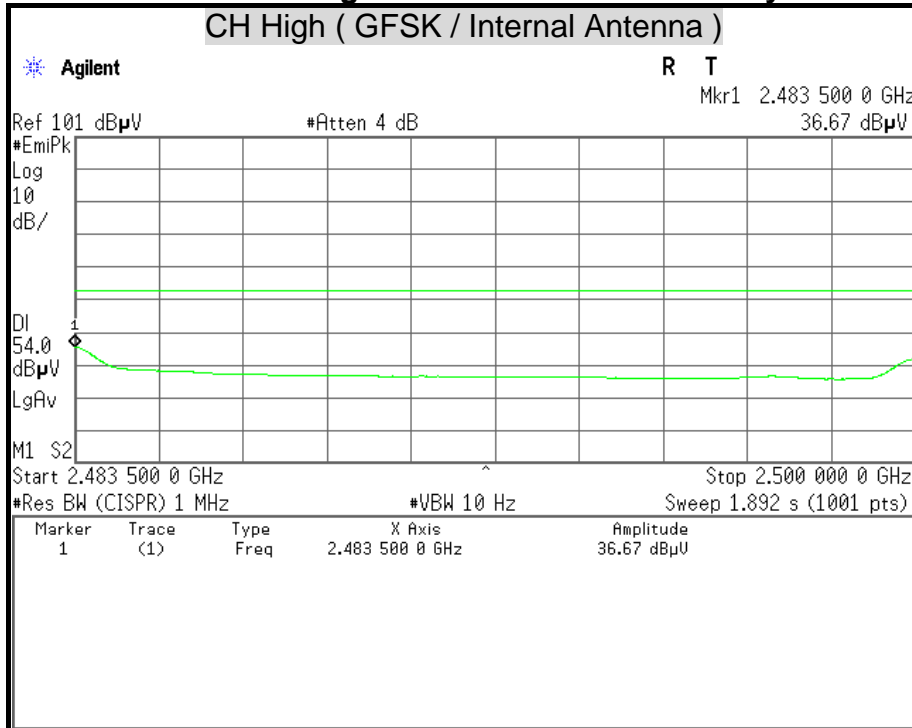



Detector Mode : Peak

Polarity : Horizontal

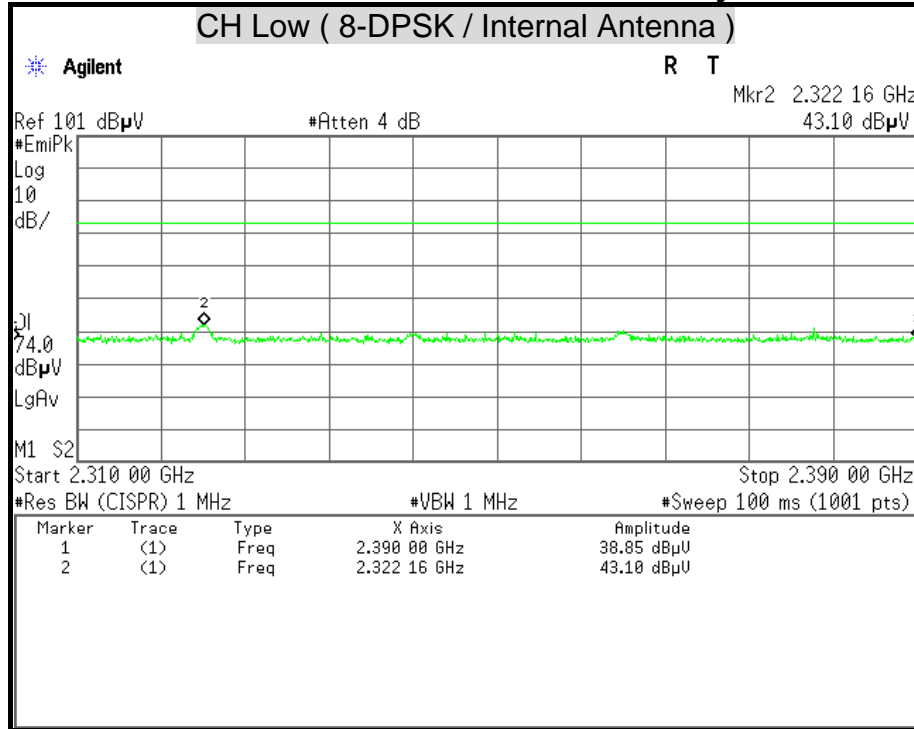

Detector Mode : Average

Polarity : Horizontal

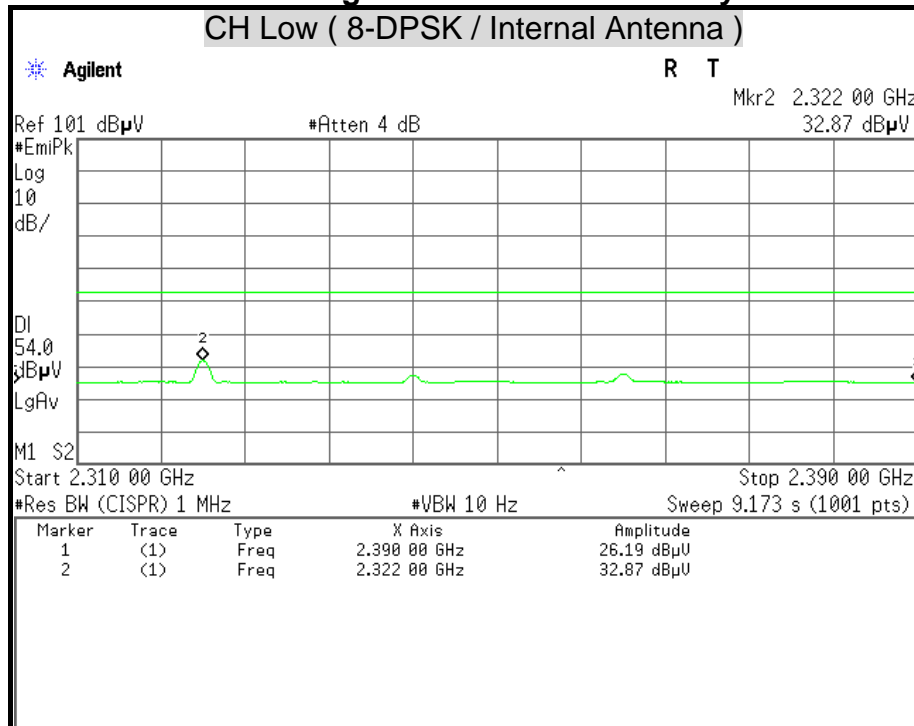



Detector Mode : Peak

Polarity : Vertical

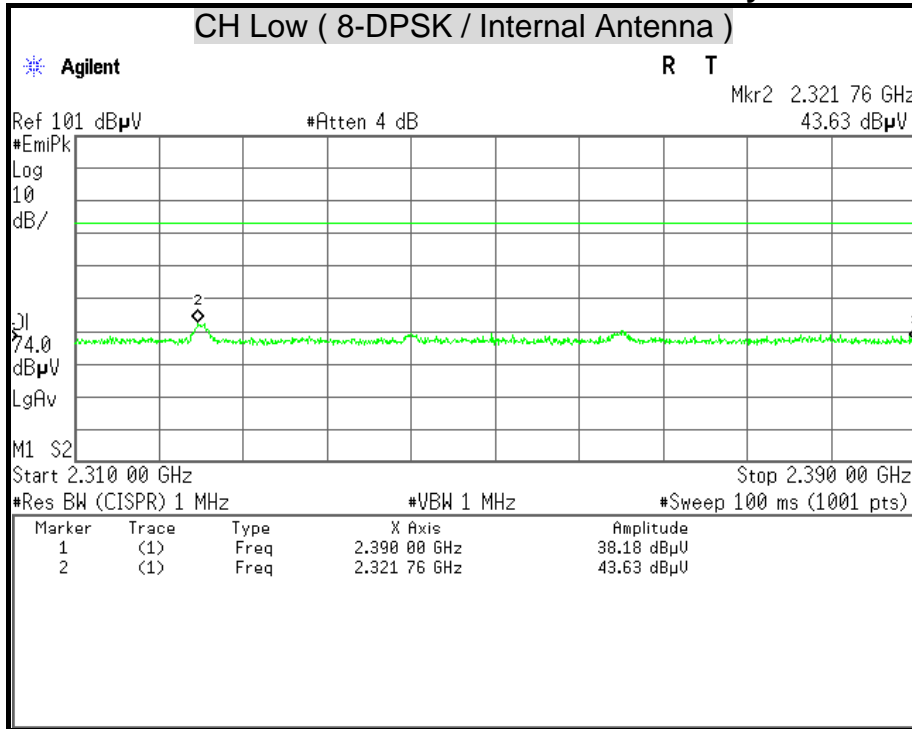

Detector Mode : Average

Polarity : Vertical

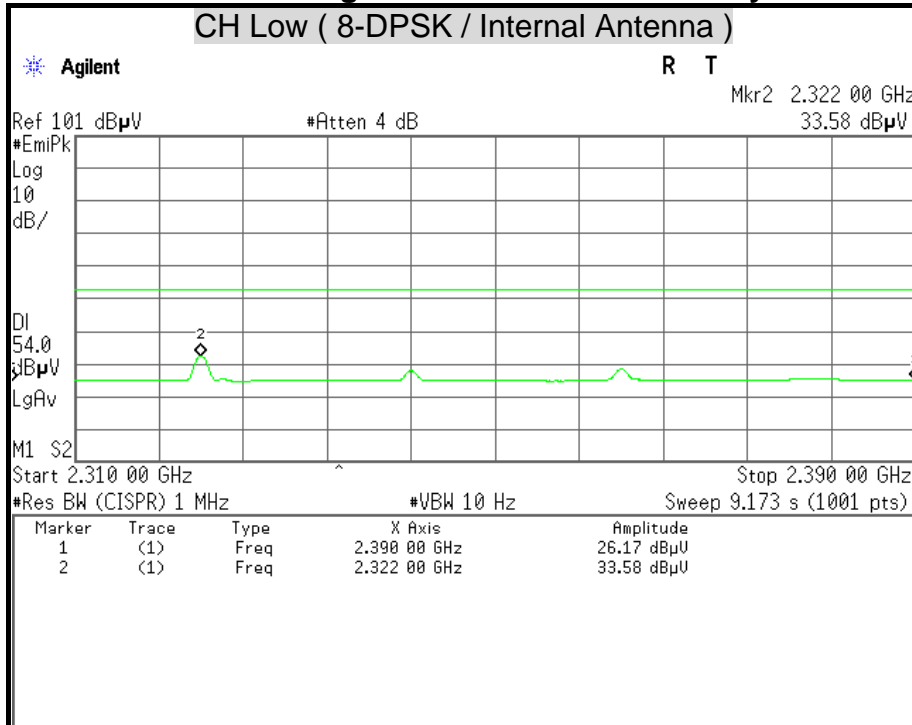



Detector Mode : Peak

Polarity : Horizontal

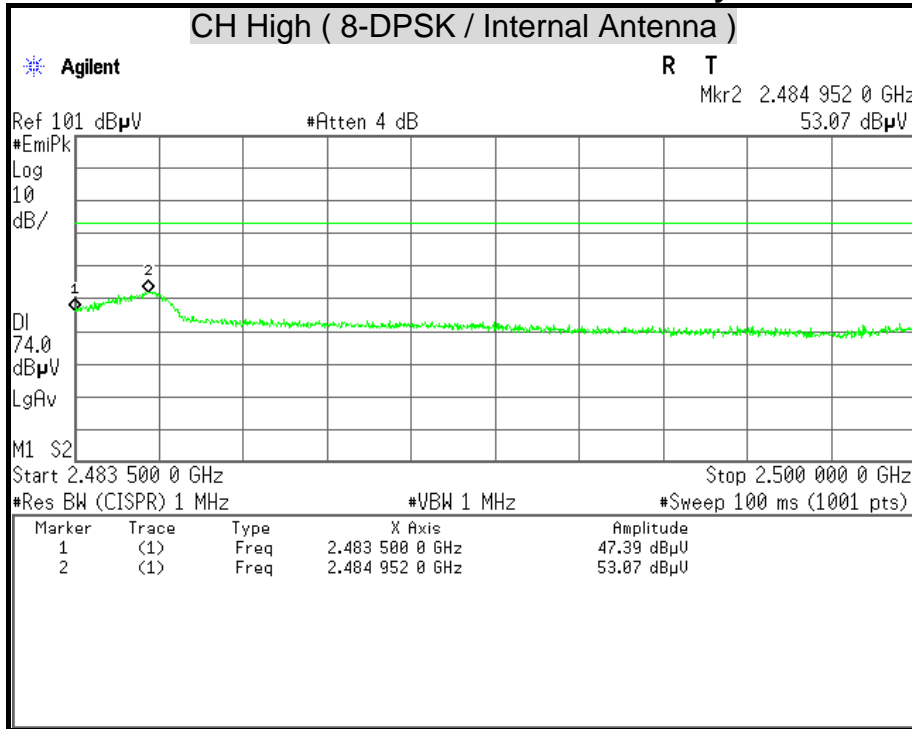

Detector Mode : Average

Polarity : Horizontal

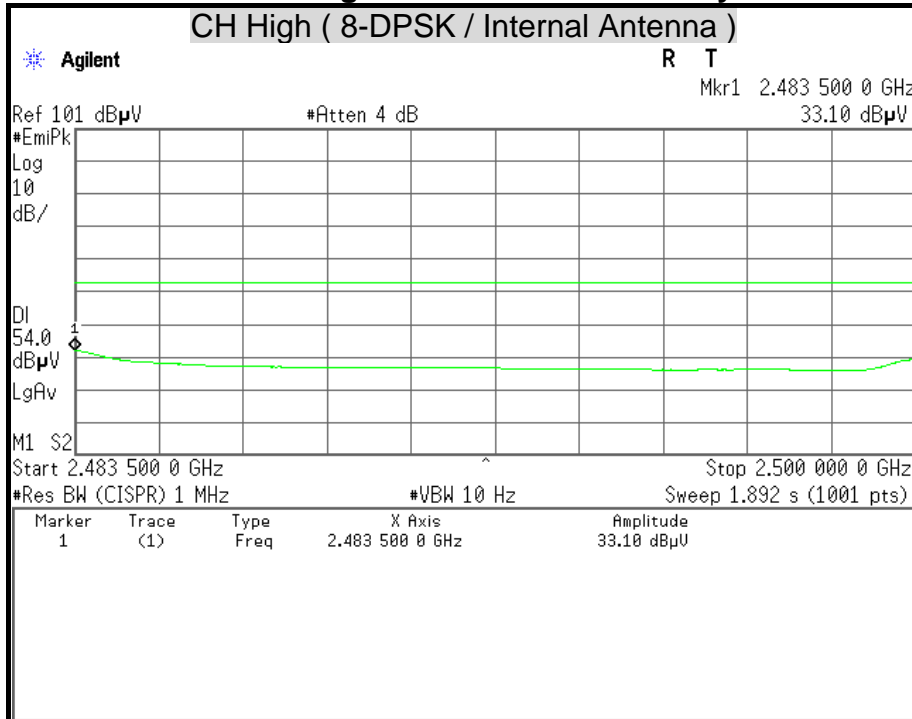



Detector Mode : Peak

Polarity : Vertical

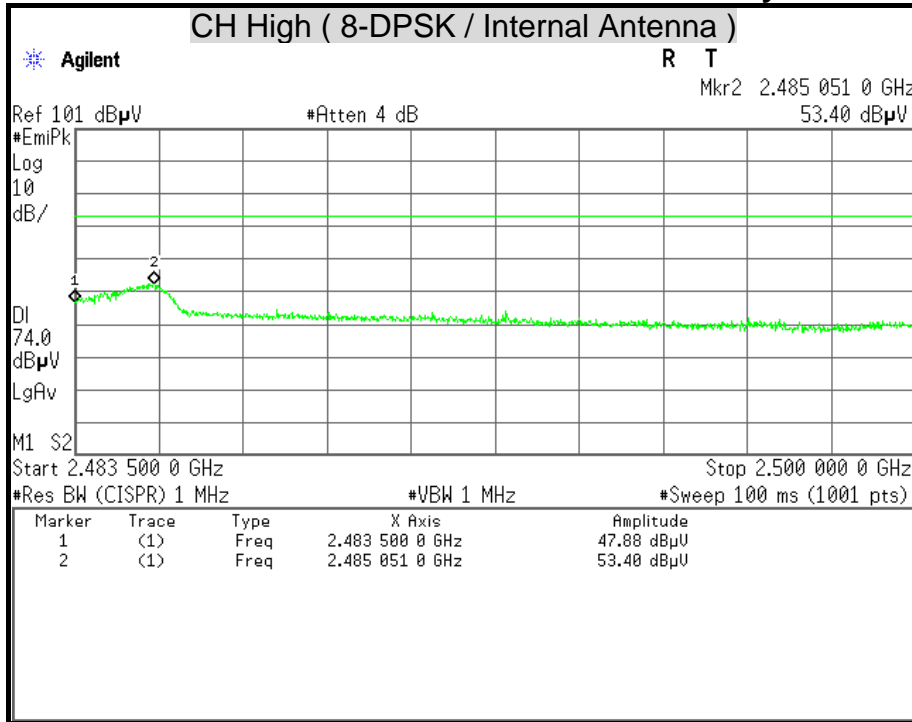

Detector Mode : Average

Polarity : Vertical

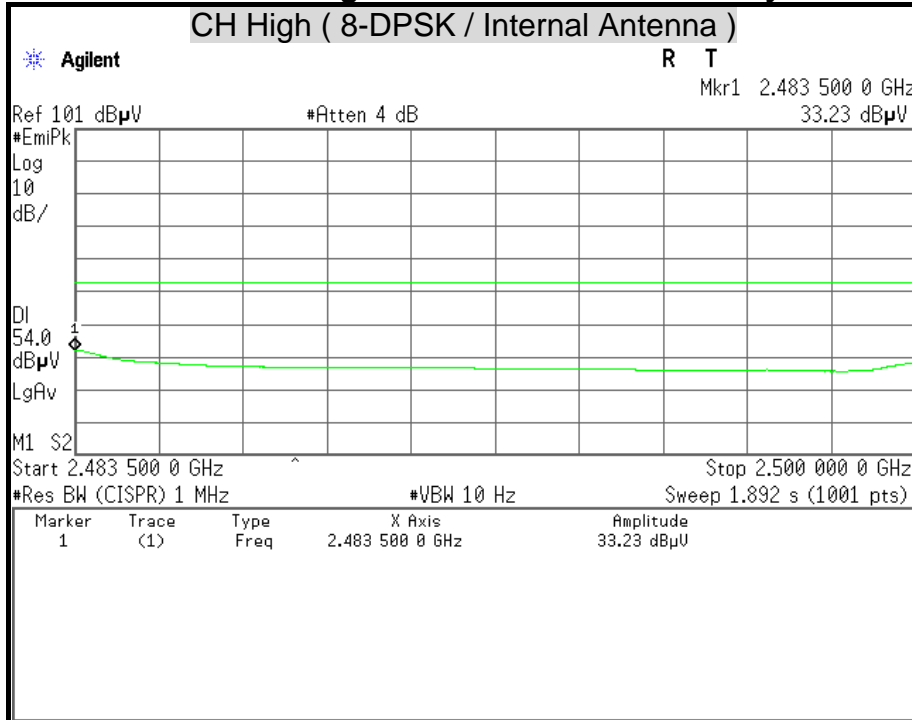



7.9 CONDUCTED EMISSION

LIMITS

§ 15.207 (a) Except as shown in paragraph (b) and (c) this section, for an intentional radiator that is designed to be connected to the public utility (AC) power line, the radio frequency voltage that is conducted back onto the AC power line on any frequency or frequencies within the band 150 kHz to 30 MHz shall not exceed the limits in the following table, as measured using a 50 μ H/50 ohms line impedance stabilization network (LISN). Compliance with the provisions of this paragraph shall be based on the measurement of the radio frequency voltage between each power line and ground at the power terminal. The lower limit applies at the boundary between the frequency ranges.

Frequency Range (MHz)	Conducted Limit (dB μ v)	
	Quasi-peak	Average
0.15 - 0.50	66 to 56	56 to 46
0.50 - 5.00	56	46
5.00 - 30.0	60	50

TEST EQUIPMENT

Name of Equipment	Manufacturer	Model	Serial Number	Calibration Due
L.I.S.N	SCHWARZBECK	NSLK 8127	8127-465	08/06/2015
L.I.S.N	SCHWARZBECK	NSLK 8127	8127-473	03/10/2015
EMI Test Receiver	ROHDE & SCHWARZ	ESHS 30	838550/003	11/02/2015
Pulse Limiter	ROHDE & SCHWARZ	ESH3-Z2	100111	06/30/2015

Remark: Each piece of equipment is scheduled for calibration once a year.



TEST SETUP

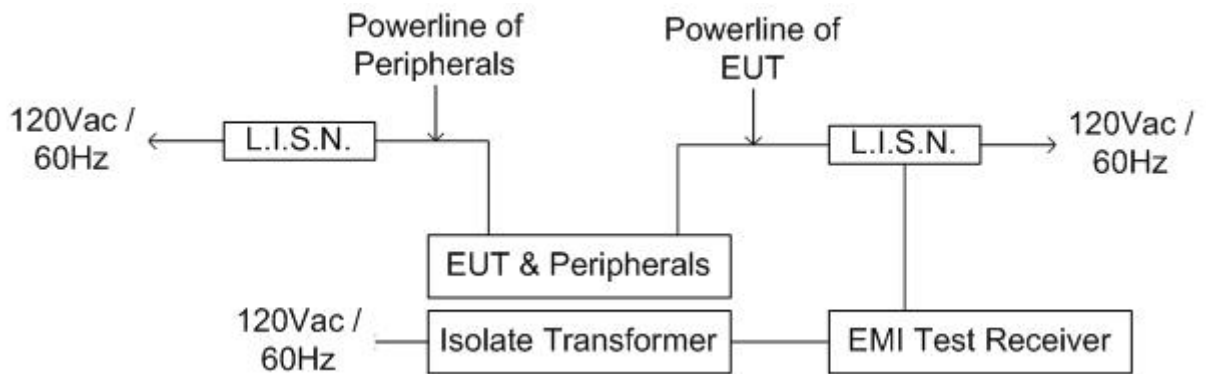
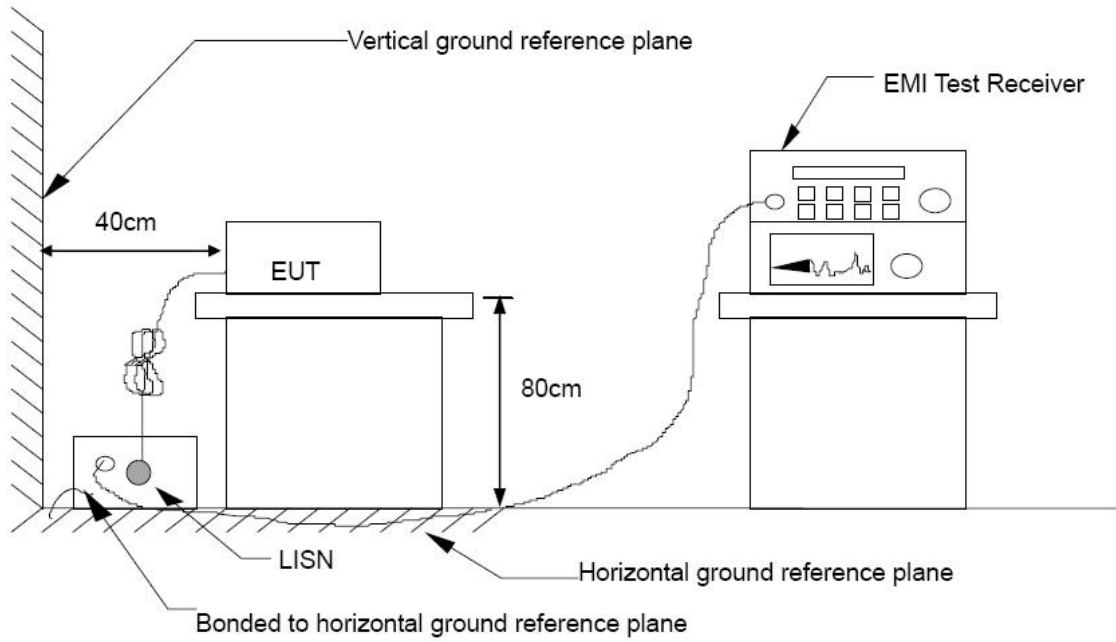



TEST PROCEDURE

The basic test procedure was in accordance with ANSI C63.10:2009.

The test procedure is performed in a 4m × 3m × 2.4m (L×W×H) shielded room.

The EUT along with its peripherals were placed on a 1.0m (W) × 1.5m (L) and 0.8m in height wooden table and the EUT was adjusted to maintain a 0.4 meter space from a vertical reference plane.

The EUT was connected to power mains through a line impedance stabilization network (LISN) which provides 50 ohm coupling impedance for measuring instrument and the chassis ground was bounded to the horizontal ground plane of shielded room. All peripherals were connected to the second LISN and the chassis ground also bounded to the horizontal ground plane of shielded room.

The EUT was located so that the distance between the boundary of the EUT and the closest surface of the LISN is 0.8 m. Where a mains flexible cord was provided by the manufacturer shall be 1 m long, or if in excess of 1 m, the excess cable was folded back and forth as far as possible so as to form a bundle not exceeding 0.4 m in length.

TEST RESULTS

Since the EUT is powered by DC Source, this test item is not applicable.