



Neutron Engineering Inc.

FCC & IC Radio Test Report

FCC ID: 2ABOW-BOOM-BOOM

IC: 11711A-BOOMBOOM

This report concerns (check one) : Original Grant Class II Change

Issued Date : Feb. 13, 2014
Project No. : 1312171
Equipment : BOOM BOOM !
Model Name : BOOM BOOM !

Applicant : Binauric SE
Address : Am Soeldnermoos 17, Hallbergmoos
85399, Germany

Tested by: Neutron Engineering Inc. EMC Laboratory
Date of Receipt: Dec. 24, 2013
Date of Test: Dec. 24, 2013 ~ Jan. 08, 2014

Testing Engineer: Josh Lin
(Josh Lin)

Technical Manager: Jeff Yang
(Jeff Yang)

Authorized Signatory: Andy Chiu
(Andy Chiu)

Neutron Engineering Inc.
B1, No. 37, Lane 365, YangGuang St.,
NeiHu District 114, Taipei, Taiwan.
TEL: +886-2-2657-3299
FAX: +886-2-2657-3331



**Neutron Engineering Inc.****Declaration**

Neutron represents to the client that testing is done in accordance with standard procedures as applicable and that test instruments used has been calibrated with the standards traceable to National Measurement Laboratory (**NML**) of **R.O.C.**, or National Institute of Standards and Technology (**NIST**) of **U.S.A.**

Neutron's reports apply only to the specific samples tested under conditions. It is manufacture's responsibility to ensure that additional production units of this model are manufactured with the identical electrical and mechanical components. **Neutron** shall have no liability for any declarations, inferences or generalizations drawn by the client or others from **Neutron** issued reports.

Neutron's reports must not be used by the client to claim product endorsement by the authorities or any agency of the Government.

This report is the confidential property of the client. As a mutual protection to the clients, the public and **Neutron-self**, extracts from the test report shall not be reproduced except in full with **Neutron's** authorized written approval.

Neutron's laboratory quality assurance procedures are in compliance with the **ISO Guide 17025** requirements, and accredited by the conformity assessment authorities listed in this test report.

Limitation

For the use of the authority's logo is limited unless the Test Standard(s)/Scope(s)/Item(s) mentioned in this test report is (are) included in the conformity assessment authorities acceptance respective.



Table of Contents

REPORT ISSUED HISTORY	6
1 CERTIFICATION	7
2 SUMMARY OF TEST RESULTS	8
2.1 TEST FACILITY	9
2.2 MEASUREMENT UNCERTAINTY	9
3 GENERAL INFORMATION	10
3.1 GENERAL DESCRIPTION OF EUT	10
3.2 DESCRIPTION OF TEST MODES	12
3.3 TABLE OF PARAMETERS OF TEXT SOFTWARE SETTING	13
3.4 BLOCK DIAGRAM SHOWING THE CONFIGURATION OF SYSTEM TESTED	14
3.5 DESCRIPTION OF SUPPORT UNITS	15
4 CONDUCTED EMISSION	16
4.1 LIMIT	16
4.2 MEASUREMENT INSTRUMENTS LIST	16
4.3 TEST PROCEDURES	17
4.4 TEST SETUP LAYOUT	17
4.5 DEVIATION FROM TEST STANDARD	17
4.6 EUT OPERATING CONDITIONS	18
4.7 TEST RESULTS	19
5 ANTENNA CONDUCTED SPURIOUS EMISSION	21
5.1 LIMIT	21
5.2 MEASUREMENT INSTRUMENTS LIST	21
5.3 TEST PROCEDURES	21
5.4 TEST SETUP LAYOUT	21
5.5 DEVIATION FROM TEST STANDARD	21
5.6 EUT OPERATING CONDITIONS	21
5.7 TEST RESULTS	22
6 HOPPING CHANNEL SEPARATION	30
6.1 LIMIT	30
6.2 MEASUREMENT INSTRUMENTS LIST	30
6.3 MEASURING INSTRUMENTS SETTING	30
6.4 TEST PROCEDURES	30
6.5 TEST SETUP LAYOUT	30
6.6 DEVIATION FROM TEST STANDARD	30
6.7 EUT OPERATING CONDITIONS	30
6.8 TEST RESULTS	31
7 MAXIMUM PEAK CONDUCTED OUTPUT POWER	39
7.1 LIMIT	39

**Table of Contents**

7.2	MEASUREMENT INSTRUMENTS LIST	39
7.3	TEST PROCEDURES	39
7.4	TEST SETUP LAYOUT	39
7.5	DEVIATION FROM TEST STANDARD	39
7.6	EUT OPERATING CONDITIONS	39
7.7	TEST RESULTS	40
8	RADIATED SPURIOUS EMISSION (9 KHZ TO 1 GHZ)	44
8.1	LIMIT	44
8.2	MEASUREMENT INSTRUMENTS LIST	45
8.3	MEASURING INSTRUMENTS SETTING	45
8.4	TEST PROCEDURES	46
8.5	DEVIATION FROM TEST STANDARD	46
8.6	TEST SETUP LAYOUT	46
8.7	EUT OPERATING CONDITIONS	47
8.8	TEST RESULTS	48
9	RADIATED SPURIOUS EMISSION (ABOVE 1 GHZ)	50
9.1	LIMIT	50
9.2	MEASUREMENT INSTRUMENTS LIST	51
9.3	MEASURING INSTRUMENTS SETTING	51
9.4	TEST PROCEDURES	52
9.5	DEVIATION FROM TEST STANDARD	52
9.6	TEST SETUP LAYOUT	52
9.7	EUT OPERATING CONDITIONS	53
9.8	TEST RESULTS	54
9.9	TEST RESULTS (RESTRICTED BANDS)	78
10	NUMBER OF HOPPING FREQUENCY	86
10.1	LIMIT	86
10.2	MEASUREMENT INSTRUMENTS LIST	86
10.3	MEASURING INSTRUMENTS SETTING	86
10.4	TEST PROCEDURES	86
10.5	TEST SETUP LAYOUT	86
10.6	DEVIATION FROM TEST STANDARD	86
10.7	EUT OPERATING CONDITIONS	86
10.8	TEST RESULTS	87
11	AVERAGE TIME OF OCCUPANCY	89
11.1	LIMIT	89
11.2	MEASUREMENT INSTRUMENTS LIST	89
11.3	TEST PROCEDURES	89



Table of Contents

11.4	TEST SETUP LAYOUT	89
11.5	DEVIATION FROM TEST STANDARD	89
11.6	EUT OPERATING CONDITIONS	90
11.7	TEST RESULTS	91
12	EUT TEST PHOTO	103



REPORT ISSUED HISTORY

Revised Version No.	Description	Issued Date
-	Initial Issue.	Feb. 13, 2014



Neutron Engineering Inc.

1 CERTIFICATION

Equipment : BOOM BOOM !
Brand Name : Binauric
Model Name : BOOM BOOM !
Applicant : Binauric SE
Date of Test : Dec. 24, 2013 ~ Jan. 08, 2014
Standards : RSS-210, Issue 8: 2010
FCC Part 15, Subpart C: 2012
ANSI C63.4: 2009

The above equipment has been tested and found compliance with the requirement of the relative standards by Neutron Engineering Inc. EMC Laboratory.

The test data, data evaluation, and equipment configuration contained in our test report (Ref No. NEI-FCCP-1-1312171) were obtained utilizing the test procedures, test instruments, test sites that has been accredited by the Authority of TAF according to the ISO-17025 quality assessment standard and technical standard(s).



2. SUMMARY OF TEST RESULTS

RSS-210, Issue 8: 2010; FCC Part 15, Subpart C: 2012			
Standard Clause		Test Item	Result
RSS-210	FCC Part 15, Subpart C		
NOTE (2)	15.207	Conducted Emission	PASS
A8.5	15.247 (c)	Antenna conducted Spurious Emission	PASS
A8.1 (b)	15.247 (a)(1)	Hopping Channel Separation	PASS
A8.4 (2)	15.247 (b)	Maximum Peak Conducted Output Power	PASS
NOTE (3)	15.247 (c)	Radiated Spurious Emission	PASS
A8.1 (d)	15.247 (b)(1)	Number of Hopping Frequency	PASS
A8.1 (d)	15.247 (a)(1)	Average time of occupancy	PASS
NOTE (4)	15.205	Restricted Bands	PASS
NOTE (5)	15.203	Antenna Requirement	PASS

NOTE:

- (1) **N/A**: denotes test is not applicable in this Test Report
- (2) Reference standerads is RSS-GEN 7.2.4
- (3) Reference standerads is RSS-GEN 7.2.5
- (4) Reference standerads is RSS-GEN 7.2.2
- (5) Reference standerads is RSS-GEN 7.1.2



Neutron Engineering Inc.

2.1 TEST FACILITY

The test facilities used to collect the test data in this report:

Conducted emission Test:

C02: 1F., No. 61, Ln. 77, Sing-ai Rd., Neihu Dist., Taipei City 114, Taiwan (R.O.C.)

Radiated emission Test (Below 1 GHz):

CB08: 1F., No. 61, Ln. 77, Sing-ai Rd., Neihu Dist., Taipei City 114, Taiwan (R.O.C.)

Radiated emission Test (Above 1 GHz):

CB08: 1F., No. 61, Ln. 77, Sing-ai Rd., Neihu Dist., Taipei City 114, Taiwan (R.O.C.)

2.2 MEASUREMENT UNCERTAINTY

The measurement uncertainty is not specified by FCC/Industry Canada rules and for reference only.

The reported uncertainty of measurement $y \pm U$, where expanded uncertainty U is based on a standard uncertainty multiplied by a coverage factor of $k=2$, providing a level of confidence of approximately **95%**.

The measurement instrumentation uncertainty considerations contained in CISPR 16-4-2.

A. Conducted emission test:

Test Site	Measurement Frequency Range	U, (dB)	NOTE
C02	150 kHz ~ 30 MHz	2.59	

B. Radiated emission test:

Test Site	Item	Measurement Frequency Range	Uncertainty	NOTE	
CB08	Radiated emission at 3m	Horizontal Polarization	30 - 200MHz	3.35 dB	
			200 - 1000MHz	3.11 dB	
		Vertical Polarization	1 - 18GHz	3.97 dB	
			18 - 40GHz	4.01 dB	
	Radiated emission at 3m	Horizontal Polarization	30 - 200MHz	3.22 dB	
			200 - 1000MHz	3.24 dB	
		Vertical Polarization	1 - 18GHz	4.05 dB	
			18 - 40GHz	4.04 dB	

Our calculated Measurement Instrumentation Uncertainty is shown in the tables above. These are our U_{lab} values in CISPR 16-4-2 terminology.

Since Table 1 of CISPR 16-4-2 has values of measurement instrumentation uncertainty, called U_{CISPR} , as follows:

Conducted Disturbance (mains port) – 150 kHz – 30 MHz : 3.6 dB

Radiated Disturbance (electric field strength on an open area test site or alternative test site) – 30 MHz – 1000 MHz : 5.2 dB

It can be seen that our U_{lab} values are smaller than U_{CISPR} .



Neutron Engineering Inc.

3 GENERAL INFORMATION

3.1 GENERAL DESCRIPTION OF EUT

Equipment	BOOM BOOM !	
Brand Name	Binauric	
Model Name	BOOM BOOM !	
OEM Brand/Model Name	N/A	
Model Difference	The EUT has three colors (White, Bordeaux and Khaki) which do not affect the EMI performance.	
Product Description	The EUT is a BOOM BOOM !.	
	Operation Frequency	2402 MHz ~ 2480 MHz
	Modulation Type	FHSS(GFSK, pi/4 DQPSK, 8DPSK)
	Bit Rate of Transmitter	1/2/3 Mbps
	Number Of Channel	Please refer to the Note 2.
	Antenna Designation	Please refer to the Note 3.
	Antenna Gain(Peak)	Please refer to the Note 3.
	Maximum Conducted Output Power	1 Mbps: 8.04 dBm (0.0064W) 3 Mbps: 8.20 dBm (0.0066W)
	More details of EUT technical specification, please refer to the User's Manual.	
Power Source	1. Battery supplied. 2. DC Voltage supplied from External Power Supply.	
Power Rating	1. Li-ion BATTERY PACK: 3.7V 2. External Power Supply: I/P: AC 100-240V 50-60Hz 0.3A / O/P: DC 5V 1.5A 7.5W Max	
Connecting I/O Port(s)	Please refer to the User's Manual	
Products Covered	1 * Li-ion BATTERY PACK: YOKU, 3.7V 1800mAh 1 * External Power Supply: Powertron Electronics Corp., PA1008-1SI 1 * USB Cable 1 * Audio Cable	
EUT Modification(s)	N/A	



Neutron Engineering Inc.

NOTE:

1. For a more detailed features description, please refer to the manufacturer's specifications or the User's Manual.
2. Channel List:

Channel	Frequency (MHz)	Channel	Frequency (MHz)	Channel	Frequency (MHz)
00	2402	27	2429	54	2456
01	2403	28	2430	55	2457
02	2404	29	2431	56	2458
03	2405	30	2432	57	2459
04	2406	31	2433	58	2460
05	2407	32	2434	59	2461
06	2408	33	2435	60	2462
07	2409	34	2436	61	2463
08	2410	35	2437	62	2464
09	2411	36	2438	63	2465
10	2412	37	2439	64	2466
11	2413	38	2440	65	2467
12	2414	39	2441	66	2468
13	2415	40	2442	67	2469
14	2416	41	2443	68	2470
15	2417	42	2444	69	2471
16	2418	43	2445	70	2472
17	2419	44	2446	71	2473
18	2420	45	2447	72	2474
19	2421	46	2448	73	2475
20	2422	47	2449	74	2476
21	2423	48	2450	75	2477
22	2424	49	2451	76	2478
23	2425	50	2452	77	2479
24	2426	51	2453	78	2480
25	2427	52	2454		
26	2428	53	2455		

3. Table for Filed Antenna

Ant.	Brand	Model Name	Antenna Type	Connector	Gain (dBi)
1	ACX	AT3216-T2R4PAA	Chip	Soldered	1.50



Neutron Engineering Inc.

3.2 DESCRIPTION OF TEST MODES

To investigate the maximum EMI emission characteristics generates from EUT, the test system was pre-scanning tested base on the consideration of following EUT operation mode or test configuration mode which possible have effect on EMI emission level. Each of these EUT operation mode(s) or test configuration mode(s) mentioned above was evaluated respectively.

Test Items	Mode	Data Rate	Tested Channel/Mode
Conducted Emission	GFSK	1 Mbps	2441 MHz
Antenna conducted Spurious Emission	GFSK	1 Mbps	2402 MHz, 2441 MHz, 2480 MHz
	8DPSK	3 Mbps	
Hopping Channel Separation	GFSK	1 Mbps	2402 MHz, 2441 MHz, 2480 MHz
	8DPSK	3 Mbps	
Maximum Peak Conducted Output Power	GFSK	1 Mbps	2402 MHz, 2441 MHz, 2480 MHz
	8DPSK	3 Mbps	
Radiated Spurious Emission (30 MHz to 1 GHz)	GFSK	1 Mbps	2441 MHz
Radiated Spurious Emission (above 1 GHz)	GFSK	1 Mbps	2402 MHz, 2441 MHz, 2480 MHz
	8DPSK	3 Mbps	
Number of Hopping Frequency	GFSK	1 Mbps	2402 MHz, 2441 MHz, 2480 MHz
	8DPSK	3 Mbps	
Average time of occupancy	GFSK	1 Mbps	2402 MHz, 2441 MHz, 2480 MHz
	8DPSK	3 Mbps	
Restricted Bands	GFSK	1 Mbps	2402 MHz, 2441 MHz, 2480 MHz
	8DPSK	3 Mbps	
Antenna Requirement	GFSK	---	---
RF Exposure Compliance	GFSK	---	---

NOTE: The measurements are performed at the highest, middle, lowest available channels.



3.3 TABLE OF PARAMETERS OF TEXT SOFTWARE SETTING

During testing channel & power controlling software provided by the customer was used to control the operating channel as well as the output power level. The RF output power selection is for the setting of RF output power expected by the customer and is going to be fixed on the firmware of the final end product.

Data Rate	1 Mbps		
Test software Version	Bluetest3		
Frequency	2402 MHz	2441 MHz	2480 MHz
Parameter	50	50	50

Data Rate	3 Mbps		
Test software Version	Bluetest3		
Frequency	2402 MHz	2441 MHz	2480 MHz
Parameter	120	120	120



3.4 BLOCK DIAGRAM SHOWING THE CONFIGURATION OF SYSTEM TESTED

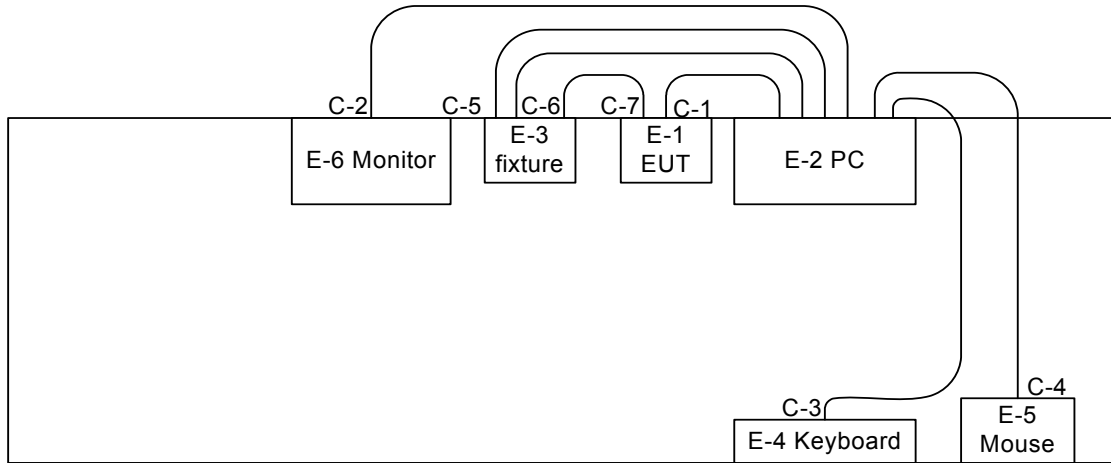

- C-1 USB Cable
- C-2 VGA Cable
- C-3 USB Cable
- C-4 USB Cable
- C-5 DATA Cable
- C-6 USB Cable
- C-7 DATA Cable



Neutron Engineering Inc.

3.5 DESCRIPTION OF SUPPORT UNITS

The EUT has been tested as an independent unit together with other necessary accessories or support units. The following support units or accessories were used to form a representative test configuration during the tests.

Item	Equipment	Mfr/Brand	Model/Type No.	FCC ID/IC	Series No.	Note
E-1	BOOM BOOM !	Binauric	BOOM BOOM !	FCC ID: 2ABOW-BOOM-BOOM IC: 11711A-BOOMBOOM	N/A	EUT
E-2	PC	N/A	N/A	N/A	N/A	
E-3	Fixture	N/A	N/A	N/A	N/A	
E-4	USB K/B	DELL	L50U	DOC	N/A	
E-5	USB Mouse	DELL	MS111-L	DOC	CN-09RRC7-447 51-17J-OH1F	
E-6	24" LCD Monitor	DELL	U2410f	DOC	CN-OJ257M-728 72-09J-067L	

Item	Shielded Type	Ferrite Core	Length	Note
C-1	YES	NO	1.2M	
C-2	YES	YES	1.8M	
C-3	YES	NO	1.8M	
C-4	YES	NO	1.8M	
C-5	YES	NO	1.5M	
C-6	YES	NO	1M	
C-7	NO	NO	0.3M	

NOTE: The support equipment was authorized by Declaration of Conformity (DOC).



Neutron Engineering Inc.

4 CONDUCTED EMISSION

4.1 LIMIT

FREQUENCY (MHz)	Class A (dBuV)		Class B (dBuV)	
	Quasi-peak	Average	Quasi-peak	Average
0.15 - 0.5	79.00	66.00	66 - 56 *	56 - 46 *
0.50 - 5.0	73.00	60.00	56.00	46.00
5.0 - 30.0	73.00	60.00	60.00	50.00

NOTE:

1. The tighter limit applies at the band edges.
2. The limit of " * " marked band means the limitation decreases linearly with the logarithm of the frequency in the range.
3. The test result calculated as following:
 Measurement Value = Reading Level + Correct Factor
 Correct Factor = Insertion Loss + Cable Loss + Attenuator Factor(if use)
 Margin Level = Measurement Value – Limit Value

4.2 MEASUREMENT INSTRUMENTS LIST

Item	Kind of Equipment	Manufacturer	Type No.	Serial No.	Calibrated until
1	LISN	Schwarzbeck	NSLK 8127	8127685	Feb. 24, 2014
2	Test Cable	TIMES	CFD300-NL	C01	Jun. 16, 2014
3	EMI Test Receiver	Agilent	N9038A	MY51210215	Mar. 21, 2014
4	Measurement Software	EZ	EZ_EMG (Version NB-02A)	N/A	N/A

NOTE: **N/A**: denotes No Model Name, No Serial No. or No Calibration specified.

4.3 TEST PROCEDURES

- a. The EUT was placed 0.8 meters from the horizontal ground plane with EUT being connected to the power mains through a line impedance stabilization network (LISN). All other support equipments powered from additional LISN(s). The LISN provide 50 Ohm/ 50uH of coupling impedance for the measuring instrument.
- b. Interconnecting cables that hang closer than 40 cm to the ground plane shall be folded back and forth in the center forming a bundle 30 to 40 cm long.
- c. I/O cables that are not connected to a peripheral shall be bundled in the center. The end of the cable may be terminated, if required, using the correct terminating impedance. The overall length shall not exceed 1 m.
- d. LISN at least 80 cm from nearest part of EUT chassis.
- e. For the actual test configuration, please refer to the related Item –EUT Test Photos.

NOTE:

- a. Reading in which marked as Peak, QP or AVG means measurements by using are Quasi-Peak or Average Mode with Detector BW=9 kHz (6 dB Bandwidth).
- b. All readings are Peak Mode value unless otherwise stated QP or AVG in column of Note. If the Peak or QP Mode Measured value compliance with the QP Limits and lower than AVG Limits, the EUT shall be deemed to meet both QP & AVG Limits and then only Peak or QP Mode was measured, but AVG Mode didn't perform.

4.4 TEST SETUP LAYOUT

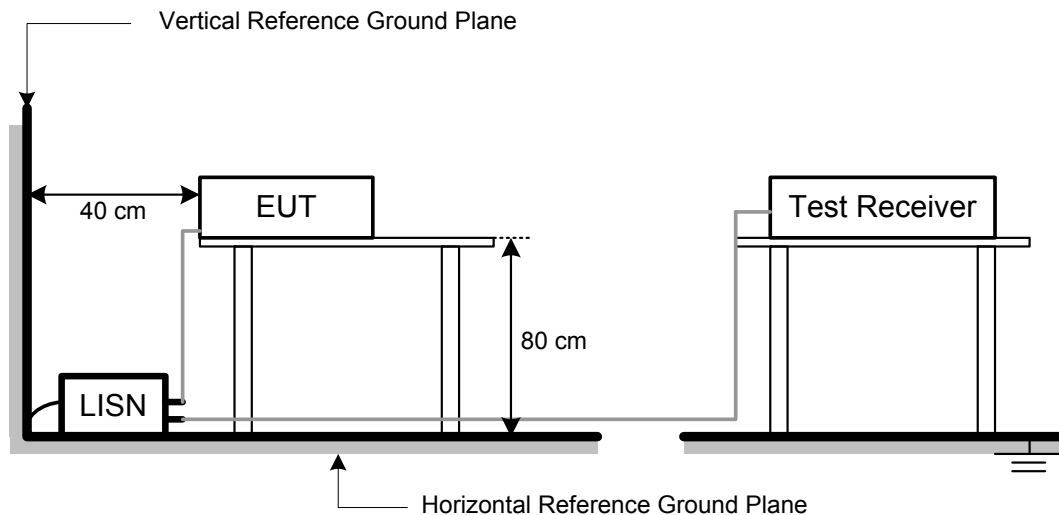

4.5 DEVIATION FROM TEST STANDARD

No deviation



Neutron Engineering Inc.

4.6 EUT OPERATING CONDITIONS

The EUT used during radiated and/or conducted emission measurement was designed to exercise in a manner similar to a typical use.



Neutron Engineering Inc.

4.7 TEST RESULTS

EUT	BOOM BOOM !	Model Name	BOOM BOOM !
Temperature	24°C	Relative Humidity	46%
Test Voltage	AC 120V/60Hz		
Test Mode	Bluetooth/1 Mbps/2441 MHz		

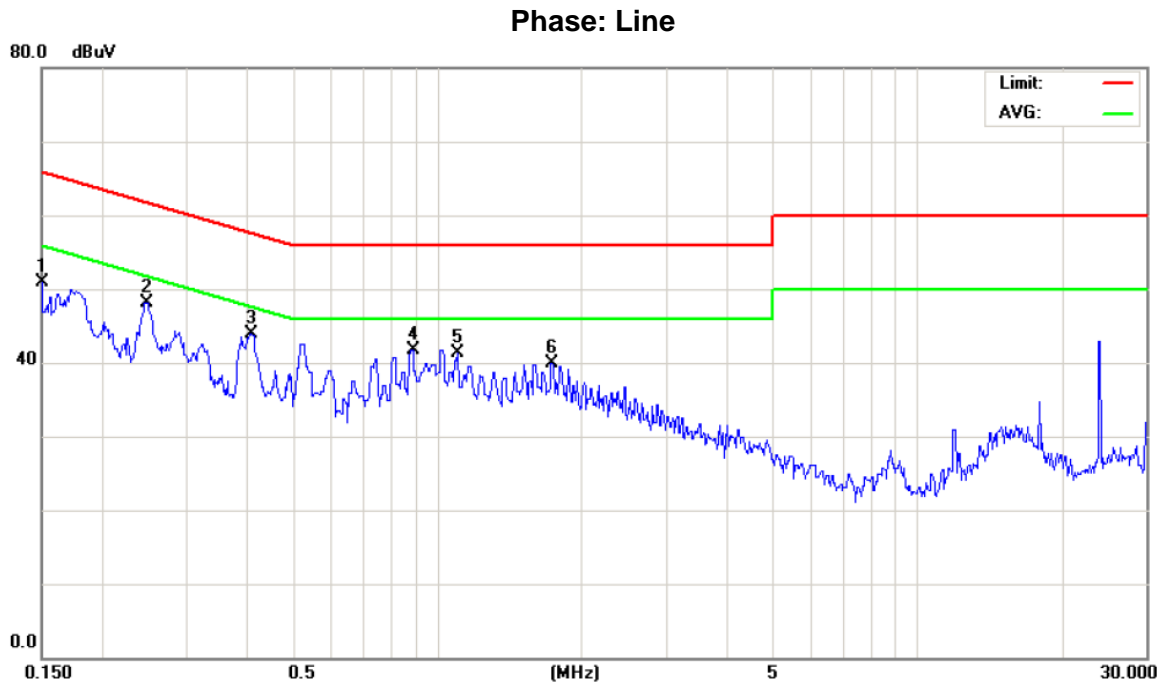

No.	Mk.	Freq. MHz	Reading Level dBuV	Correct Factor dB	Measure- ment dBuV	Limit dBuV	Over dB	Detector	Comment
1		0.1500	42.23	8.68	50.91	66.00	-15.09	peak	
2	*	0.2479	39.48	8.70	48.18	61.83	-13.65	peak	
3		0.4089	36.10	7.84	43.94	57.67	-13.73	peak	
4		0.8870	32.24	9.43	41.67	56.00	-14.33	peak	
5		1.1029	31.64	9.66	41.30	56.00	-14.70	peak	
6		1.7329	30.53	9.43	39.96	56.00	-16.04	peak	



Neutron Engineering Inc.

EUT	BOOM BOOM !	Model Name	BOOM BOOM !
Temperature	24°C	Relative Humidity	46%
Test Voltage	AC 120V/60Hz		
Test Mode	Bluetooth/1 Mbps/2441 MHz		

Phase: Neutral

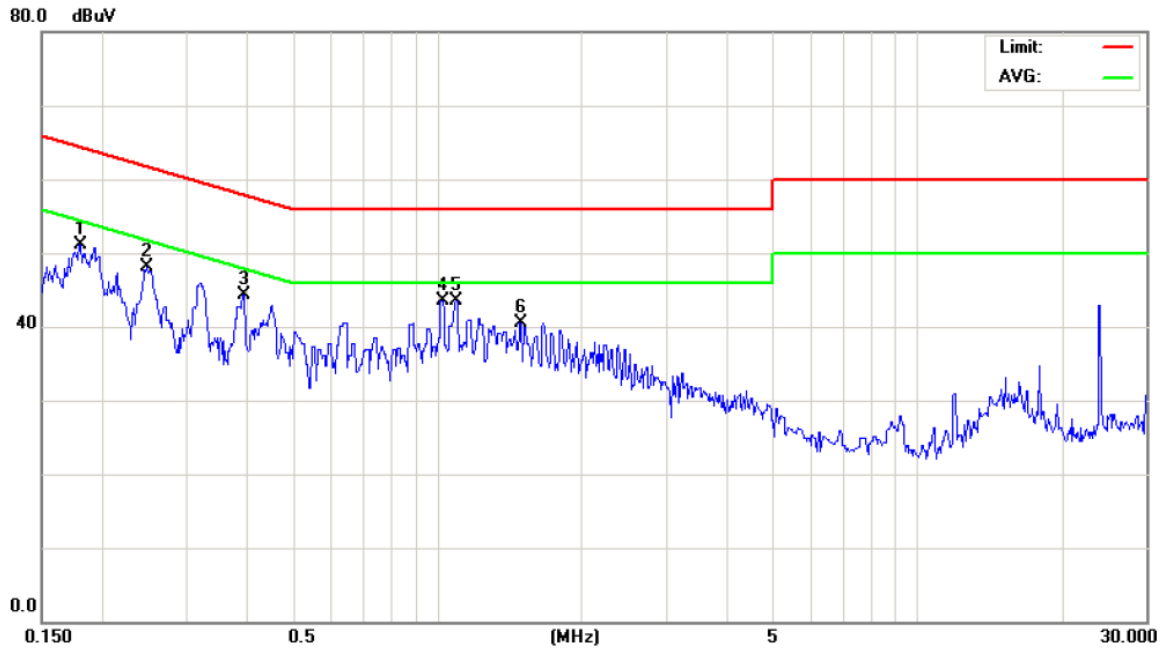

No.	Mk.	Freq. MHz	Reading Level dBuV	Correct Factor dB	Measure- ment dBuV	Limit dBuV	Over dB	Detector	Comment
1		0.1800	41.32	9.77	51.09	64.49	-13.40	peak	
2		0.2479	38.90	9.22	48.12	61.83	-13.71	peak	
3		0.3935	36.61	7.77	44.38	57.99	-13.61	peak	
4		1.0220	33.78	9.68	43.46	56.00	-12.54	peak	
5	*	1.0939	33.87	9.66	43.53	56.00	-12.47	peak	
6		1.4899	30.94	9.51	40.45	56.00	-15.55	peak	



Neutron Engineering Inc.

5 ANTENNA CONDUCTED SPURIOUS EMISSION

5.1 LIMIT

Test Item	Frequency Range (MHz)	Limit
Antenna conducted Spurious Emission	30-25000	20 dB less than the peak value of fundamental frequency

5.2 MEASUREMENT INSTRUMENTS LIST

Item	Kind of Equipment	Manufacturer	Type No.	Serial No.	Calibrated until
1	Spectrum Analyzer	R&S	FSP-30	100854	Sep. 08, 2014

NOTE: **N/A**: denotes No Model Name, No Serial No. or No Calibration specified.

5.3 TEST PROCEDURES

- a. The EUT was directly connected to the spectrum analyzer and antenna output port as show in the block diagram below,
- b. Spectrum Setting : RBW= 100KHz, VBW=100KHz, Sweep time = Auto.

5.4 TEST SETUP LAYOUT



5.5 DEVIATION FROM TEST STANDARD

No deviation

5.6 EUT OPERATING CONDITIONS

The EUT was configured for testing in a typical fashion (as a customer would normally use it). The EUT has been programmed to continuously transmit during test. This operating condition was tested and used to collect the included data.



Neutron Engineering Inc.

5.7 TEST RESULTS

EUT	BOOM BOOM !	Model Name	BOOM BOOM !
Temperature	26°C	Relative Humidity	46%
Test Voltage	AC 120V/60Hz		
Test Mode	Bluetooth/1 Mbps		

Channel of Worst Data			
The max. radio frequency power in any 100kHz bandwidth outside the frequency band		The max. radio frequency power in any 100 kHz bandwidth within the frequency band.	
FREQUENCY(MHz)	POWER(dBm)	FREQUENCY(MHz)	POWER(dBm)
2400.00	-30.21	2483.50	-54.43
Result			
In any 100kHz bandwidth outside the frequency band, the radio frequency power is at least 20dB below that in the 100kHz bandwidth within the band that contains the highest level of the desired power.			



Neutron Engineering Inc.

Bluetooth/1 Mbps/The max. radio frequency power in any 100kHz bandwidth outside the frequency band

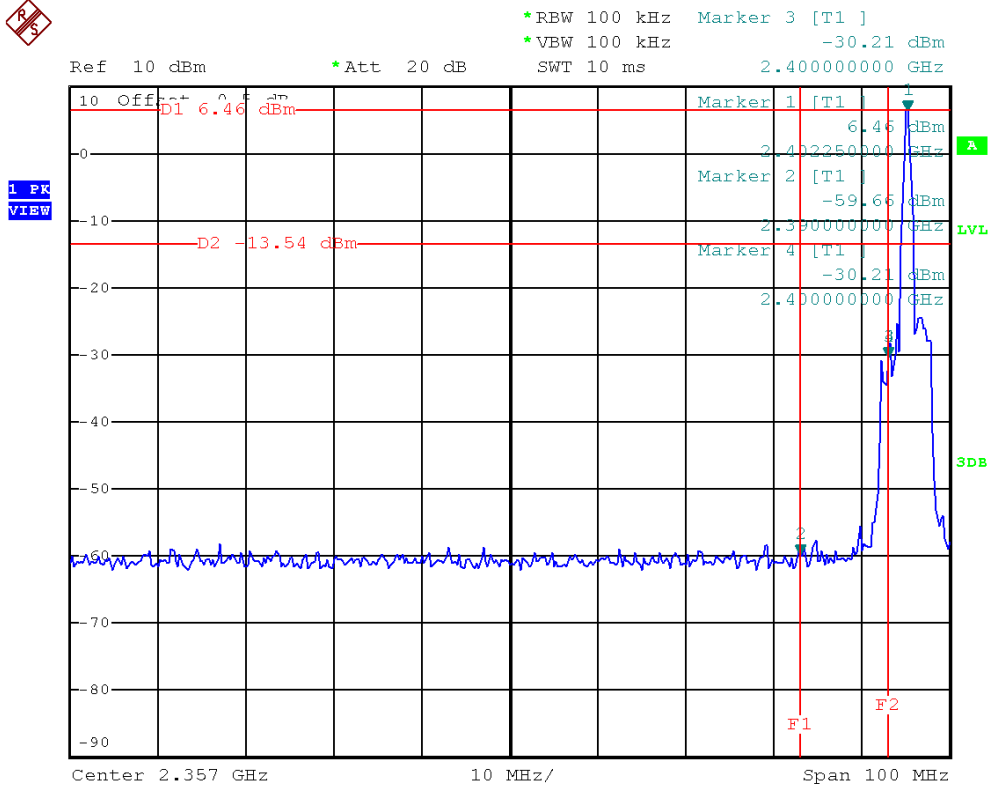

Bluetooth/1 Mbps/The max. radio frequency power in any 100 kHz bandwidth within the frequency band

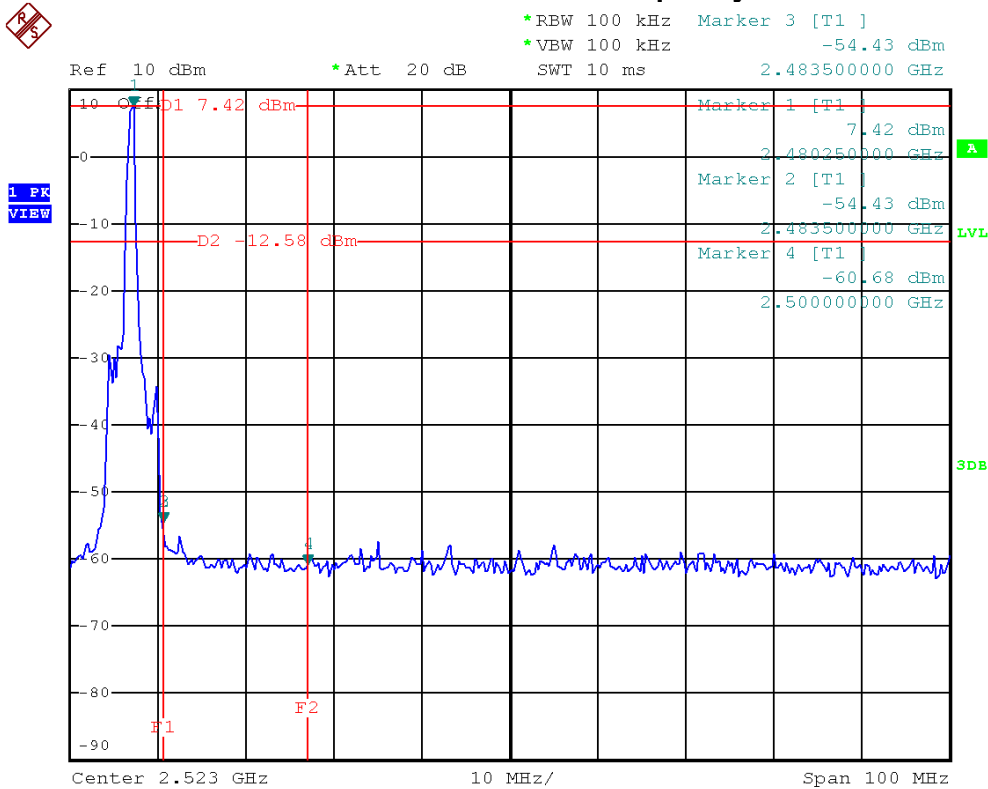



Neutron Engineering Inc.

Bluetooth/1 Mbps/2402 MHz/10 Harmonic of the frequency



*RBW 100 kHz Marker 2 [T1]
*VBW 100 kHz -51.60 dBm
SWT 2.5 s 24.188475000 GHz

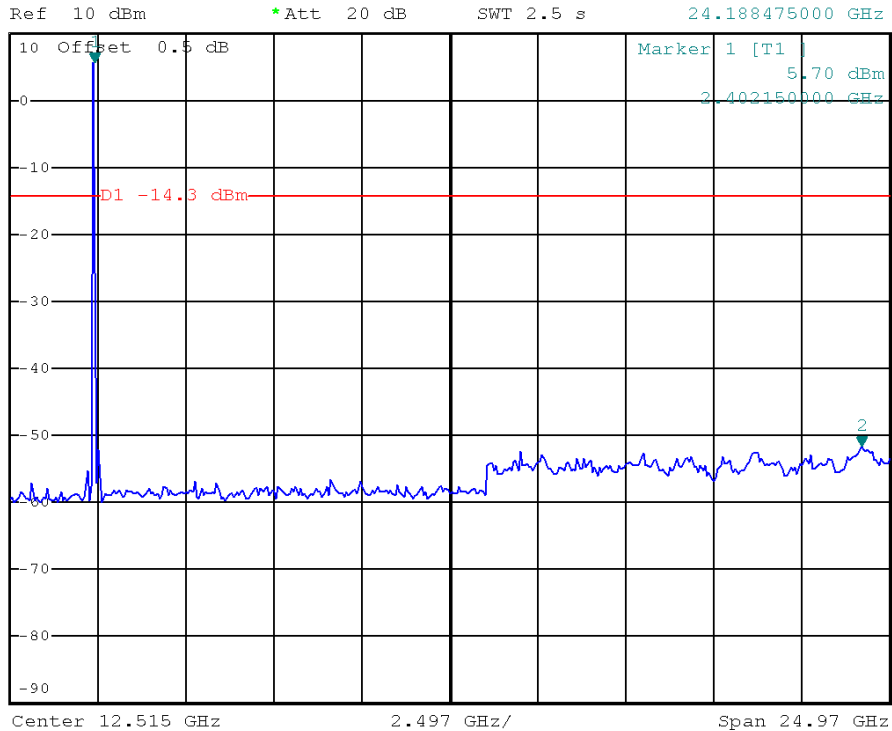

Bluetooth/1 Mbps/2441 MHz/10 Harmonic of the frequency



*RBW 100 kHz Marker 2 [T1]
*VBW 100 kHz -51.73 dBm
SWT 2.5 s 24.188475000 GHz

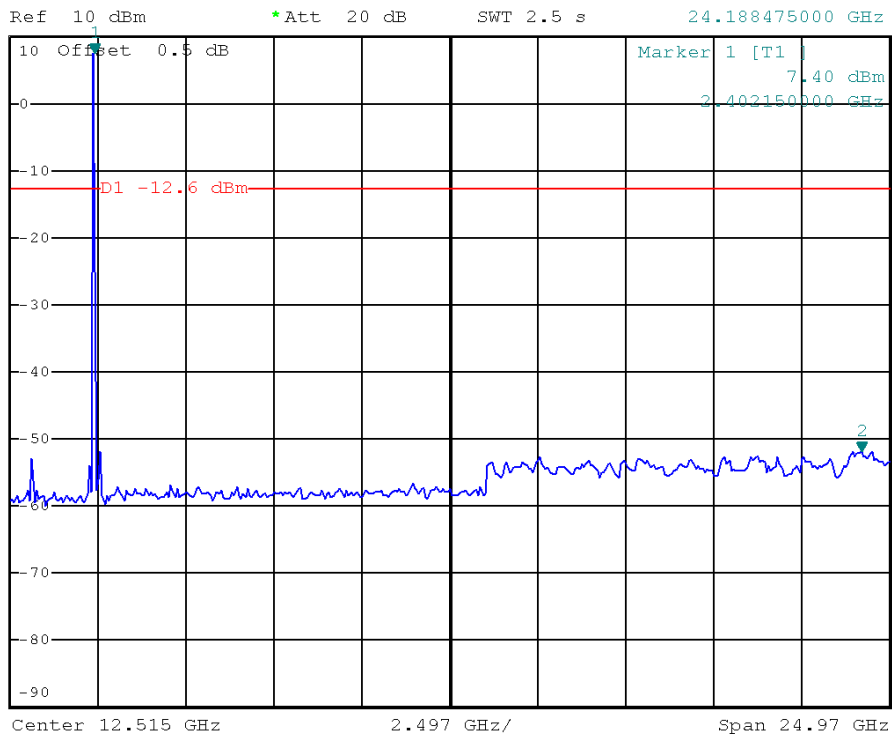



Neutron Engineering Inc.

Bluetooth/1 Mbps/2480 MHz/10 Harmonic of the frequency

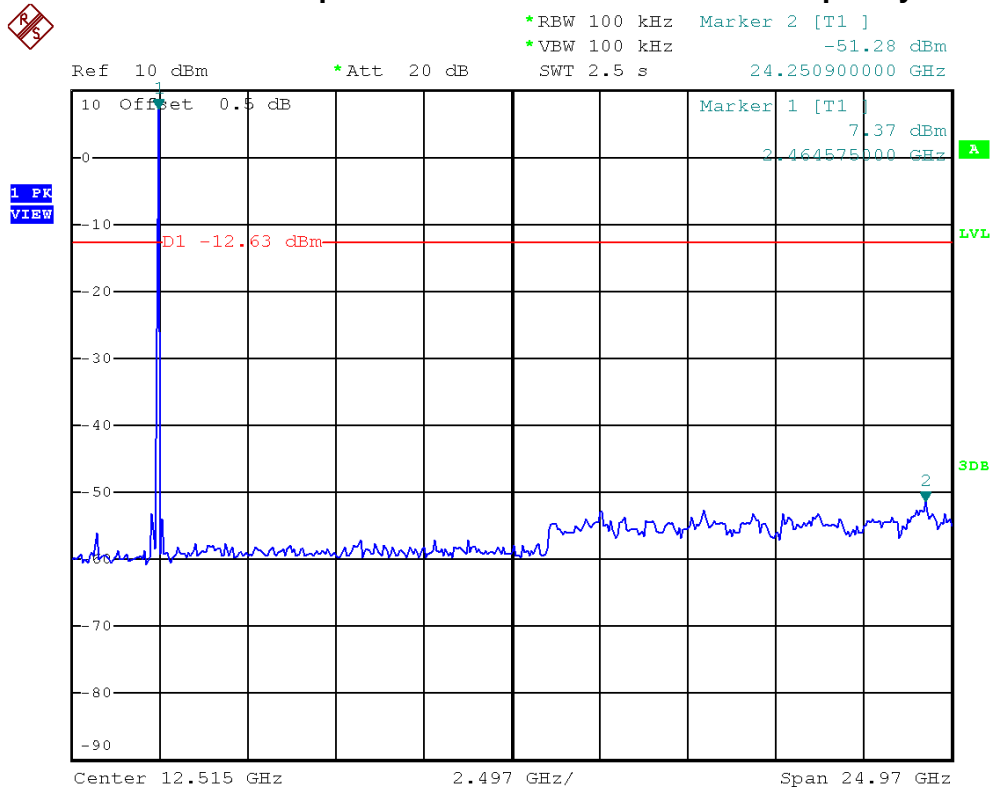



Neutron Engineering Inc.

EUT	BOOM BOOM !	Model Name	BOOM BOOM !
Temperature	26°C	Relative Humidity	46%
Test Voltage	AC 120V/60Hz		
Test Mode	Bluetooth/3 Mbps		

Channel of Worst Data			
The max. radio frequency power in any 100kHz bandwidth outside the frequency band		The max. radio frequency power in any 100 kHz bandwidth within the frequency band.	
FREQUENCY(MHz)	POWER(dBm)	FREQUENCY(MHz)	POWER(dBm)
2400.00	-30.89	2483.50	-47.83
Result			
In any 100kHz bandwidth outside the frequency band, the radio frequency power is at least 20dB below that in the 100kHz bandwidth within the band that contains the highest level of the desired power.			



Neutron Engineering Inc.

Bluetooth/3 Mbps/The max. radio frequency power in any 100kHz bandwidth outside the frequency band

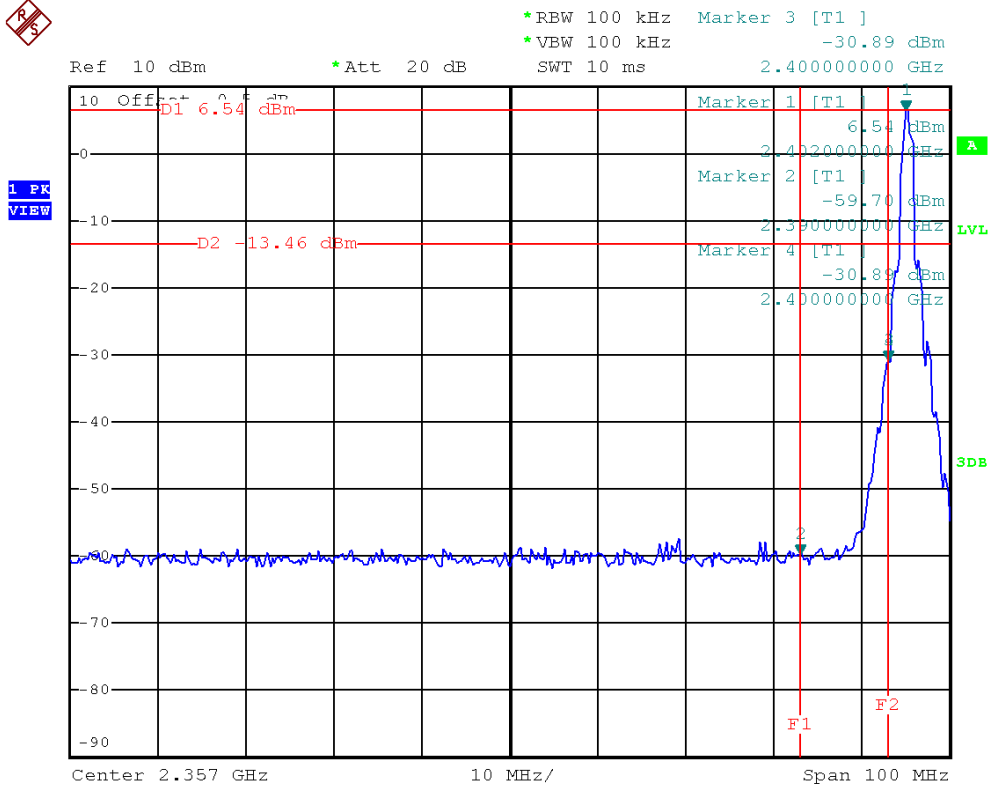

Bluetooth/3 Mbps/The max. radio frequency power in any 100 kHz bandwidth within the frequency band

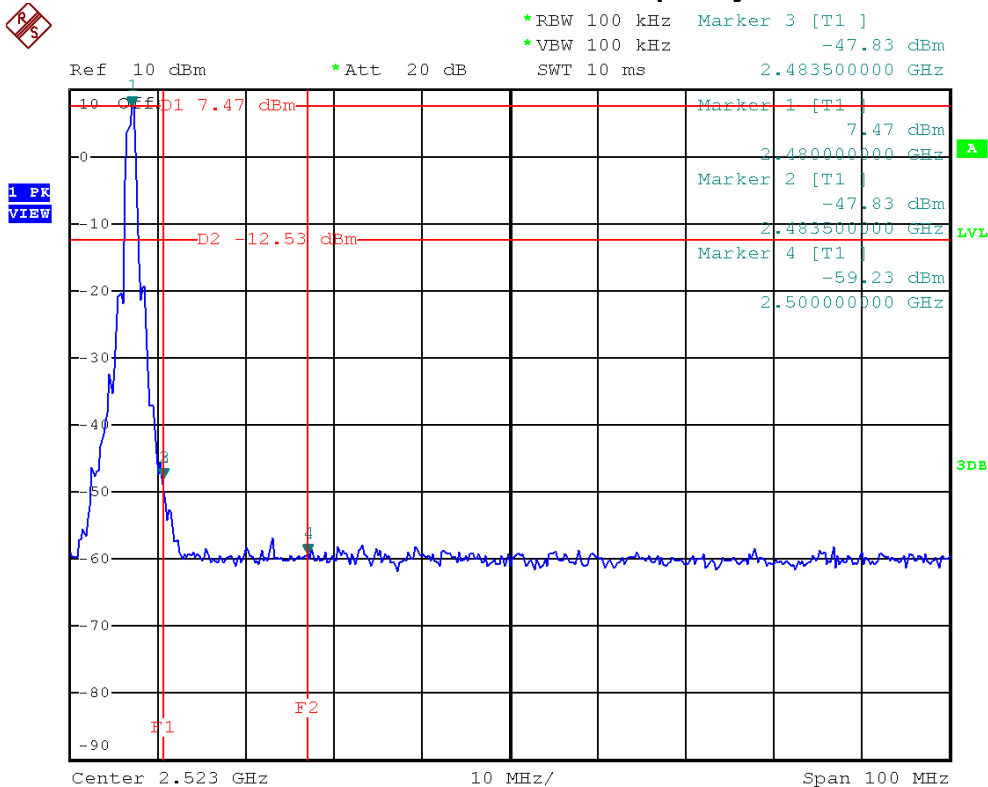



Neutron Engineering Inc.

Bluetooth/3 Mbps/2402 MHz/10 Harmonic of the frequency



*RBW 100 kHz Marker 2 [T1]
 *VBW 100 kHz -52.30 dBm
 Ref 10 dBm *Att 20 dB SWT 2.5 s 24.438175000 GHz

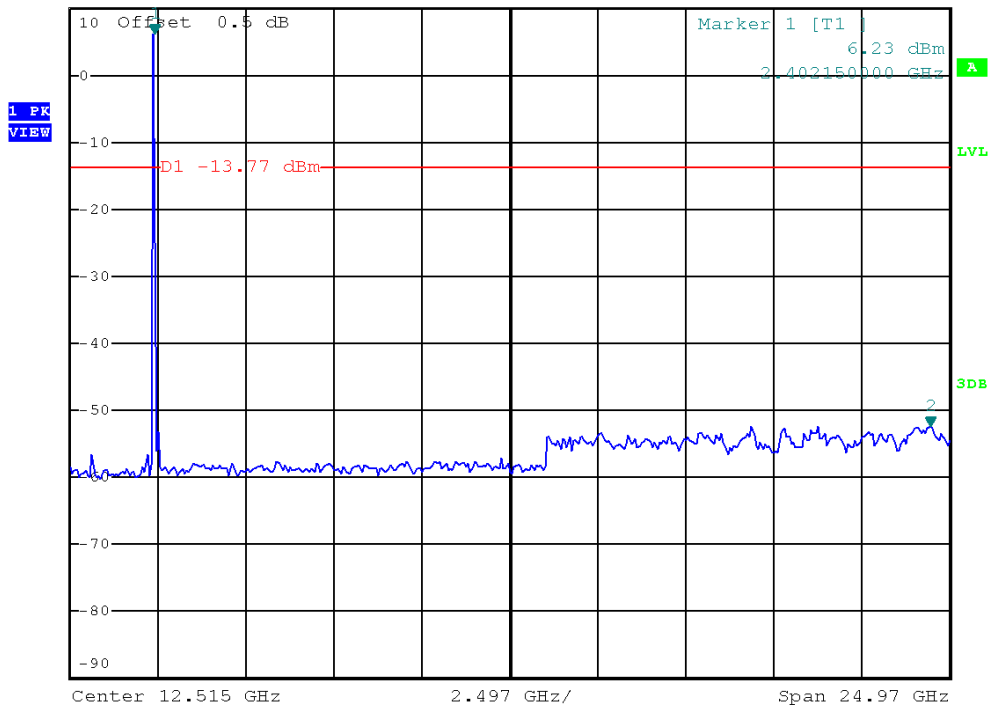

Bluetooth/3 Mbps/2441 MHz/10 Harmonic of the frequency



*RBW 100 kHz Marker 2 [T1]
 *VBW 100 kHz -52.65 dBm
 Ref 10 dBm *Att 20 dB SWT 2.5 s 24.126050000 GHz

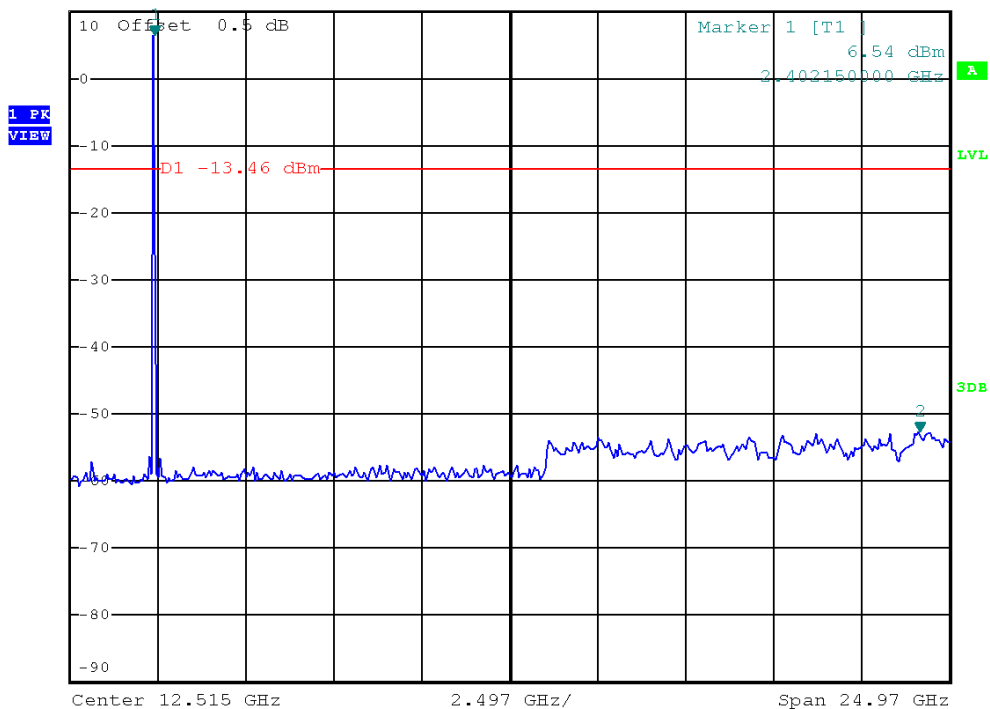



Neutron Engineering Inc.

Bluetooth/3 Mbps/2480 MHz/10 Harmonic of the frequency



*RBW 100 kHz Marker 2 [T1]
*VBW 100 kHz -52.24 dBm
SWT 2.5 s 20.380550000 GHz

Ref 10 dBm

*Att 20 dB

1 PK
VIEW

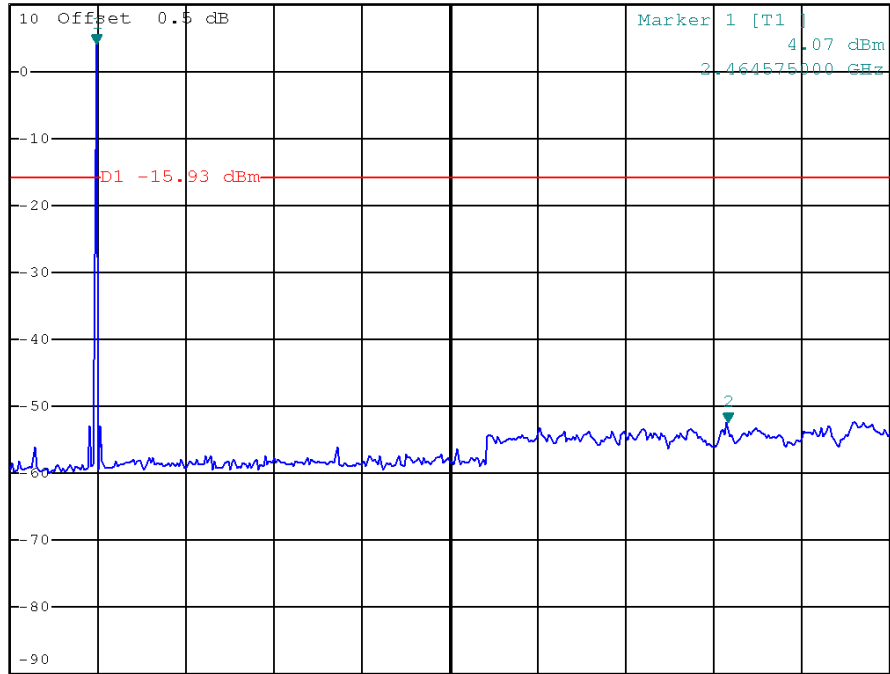

Center 12.515 GHz

2.497 GHz/

Span 24.97 GHz



Neutron Engineering Inc.

6 HOPPING CHANNEL SEPARATION

6.1 LIMIT

Frequency hopping systems operating in the 2400-2483.5 MHz band may have hopping channel carrier frequencies that are separated by 25 kHz or two-thirds of the 20 dB bandwidth of the hopping channel, whichever is greater.

6.2 MEASUREMENT INSTRUMENTS LIST

Item	Kind of Equipment	Manufacturer	Type No.	Serial No.	Calibrated until
1	Spectrum Analyzer	R&S	FSP-30	100854	Sep. 08, 2014

NOTE: **N/A**: denotes No Model Name, No Serial No. or No Calibration specified.

6.3 MEASURING INSTRUMENTS SETTING

EMI Test Receiver	Parameter Setting
Attenuation	Auto
Span Frequency	> Measurement Bandwidth or Channel Separation
RB	30 kHz (20dB Bandwidth) / 100 kHz (Channel Separation)
VB	100 kHz (20dB Bandwidth) / 300 kHz (Channel Separation)
Detector	Peak
Trace	Max Hold
Sweep Time	Auto

6.4 TEST PROCEDURES

- The transmitter output (antenna port) was connected to the spectrum analyser in peak hold mode.
- The resolution bandwidth of 30 kHz and the video bandwidth of 100 kHz were utilised for 20 dB bandwidth measurement.
- The resolution bandwidth of 100 kHz and the video bandwidth of 300 kHz were utilised for channel separation measurement.

6.5 TEST SETUP LAYOUT



6.6 DEVIATION FROM TEST STANDARD

No deviation

6.7 EUT OPERATING CONDITIONS

The EUT tested system was configured as the statements of 5.6 Unless otherwise a special operating condition is specified in the follows during the testing.



Neutron Engineering Inc.

6.8 TEST RESULTS

EUT	BOOM BOOM !	Model Name	BOOM BOOM !
Temperature	26°C	Relative Humidity	46%
Test Voltage	AC 120V/60Hz		
Test Mode	Bluetooth/1 Mbps/2402 MHz, 2441 MHz, 2480 MHz		

Frequency	Channel Separation (MHz)	20 dB Bandwidth (MHz)	99% Occupied Bandwidth (MHz)	Two-thirds of the 20 dB Bandwidth	Result
2402 MHz	1.01	0.943	0.865	0.63	PASS
2441 MHz	1.01	0.943	0.860	0.63	PASS
2480 MHz	1.00	0.943	0.850	0.63	PASS

NOTE: Ch. Separation Limits: >25 KHz or >2/3 of 20dB bandwidth



Neutron Engineering Inc.

Bluetooth/1 Mbps/2402 MHz/Channel Separation

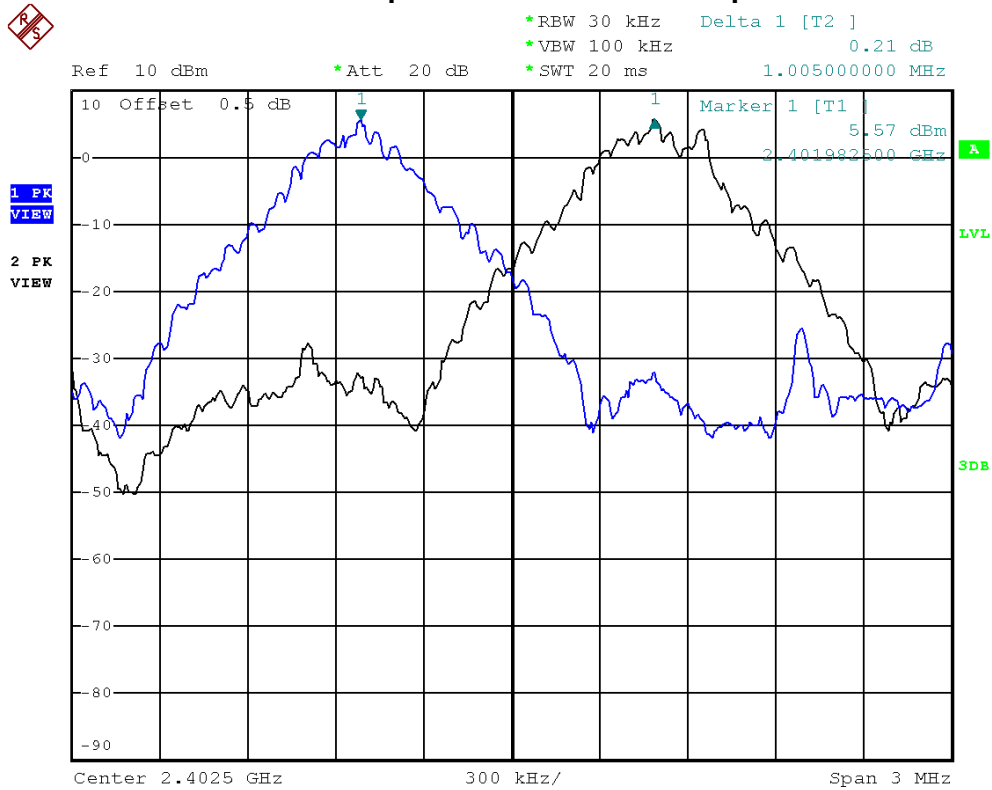

Bluetooth/1 Mbps/2402 MHz/20dB Bandwidth

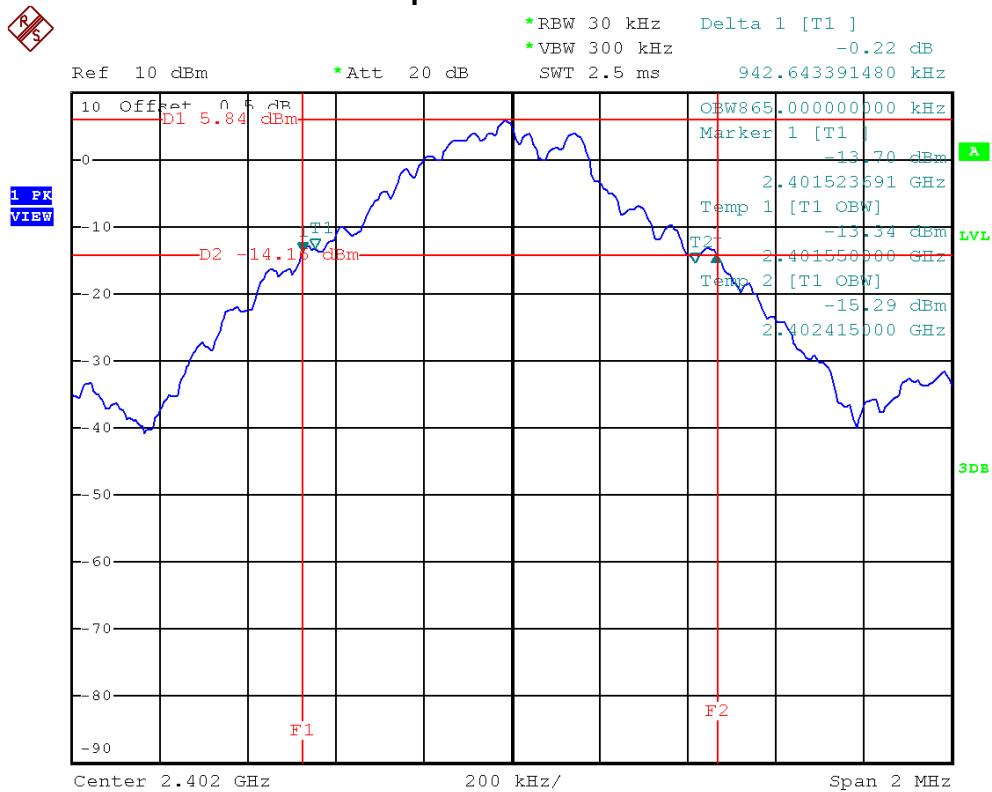



Neutron Engineering Inc.

Bluetooth/1 Mbps/2441 MHz/Channel Separation



*RBW 30 kHz Delta 1 [T2]
 *VBW 100 kHz 0.01 dB
 *SWT 20 ms 1.005000000 MHz

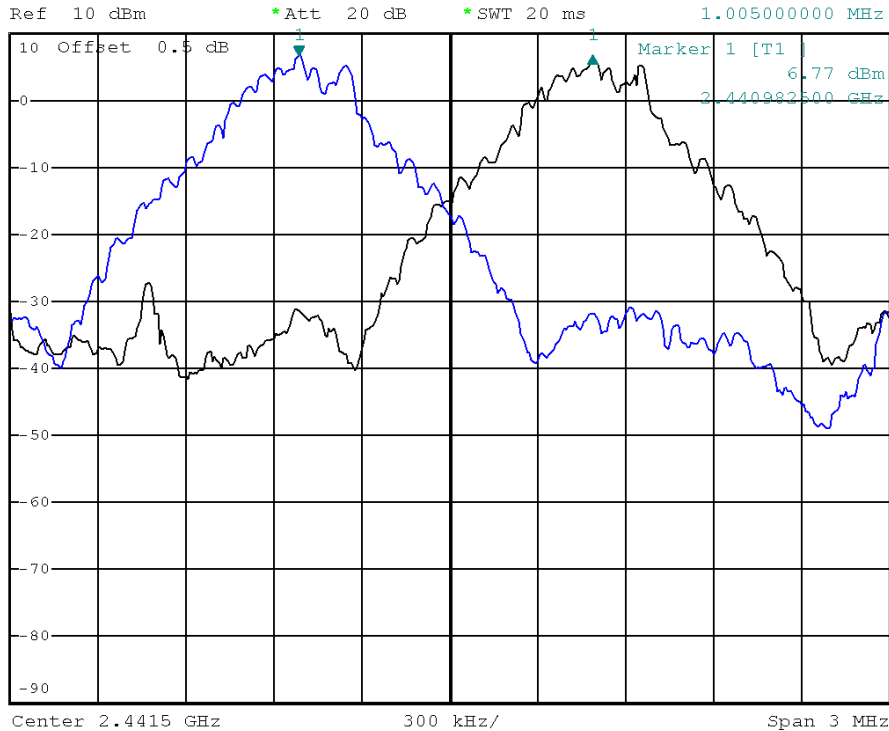

Bluetooth/1 Mbps/2441 MHz/20dB Bandwidth



*RBW 30 kHz Delta 1 [T1]
 *VBW 300 kHz -0.06 dB
 SWT 2.5 ms 942.643391470 kHz

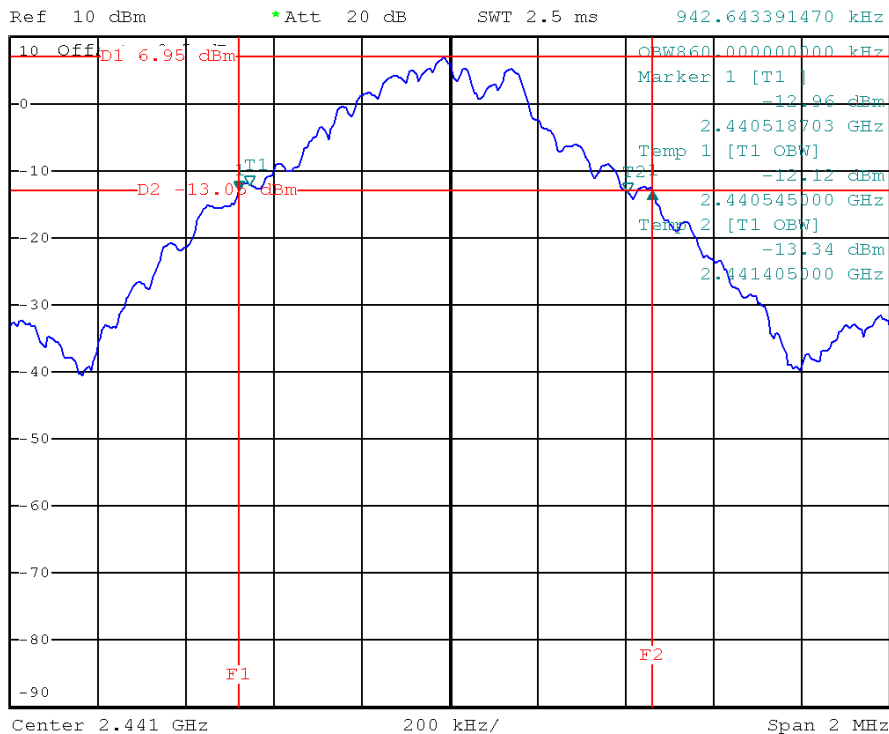



Neutron Engineering Inc.

Bluetooth/1 Mbps/2480 MHz/Channel Separation

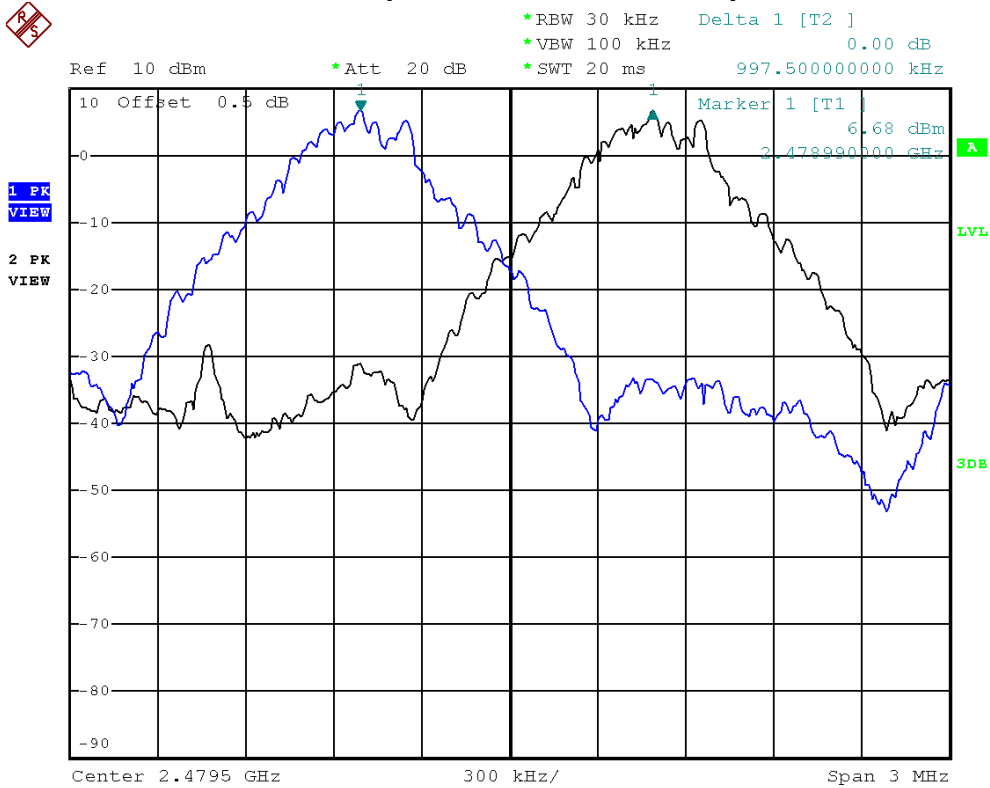

Bluetooth/1 Mbps/2480 MHz/20dB Bandwidth

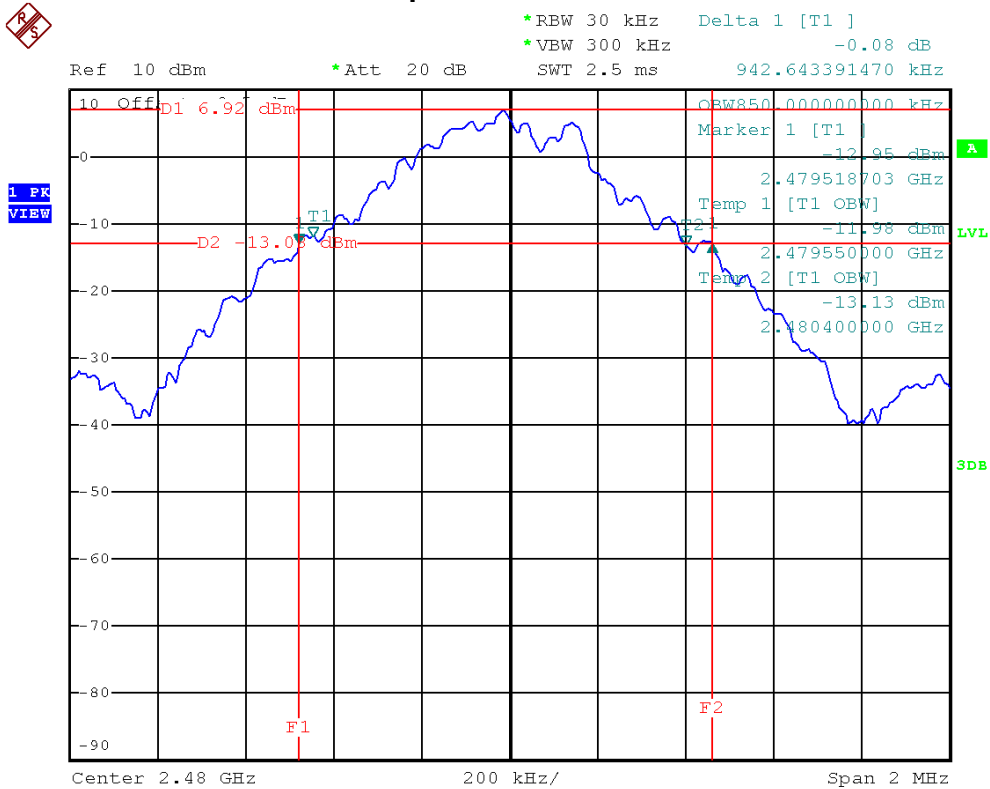



Neutron Engineering Inc.

EUT	BOOM BOOM !	Model Name	BOOM BOOM !
Temperature	26°C	Relative Humidity	46%
Test Voltage	AC 120V/60Hz		
Test Mode	Bluetooth/3 Mbps/2402 MHz, 2441 MHz, 2480 MHz		

Frequency	Channel Separation (MHz)	20 dB Bandwidth (MHz)	99% Occupied Bandwidth (MHz)	Two-thirds of the 20 dB Bandwidth	Result
2402 MHz	1.01	1.307	1.240	0.87	PASS
2441 MHz	1.01	1.307	1.220	0.87	PASS
2480 MHz	1.00	1.267	1.210	0.84	PASS

NOTE: Ch. Separation Limits: >25 KHz or >2/3 of 20dB bandwidth



Neutron Engineering Inc.

Bluetooth/3 Mbps/2402 MHz/Channel Separation

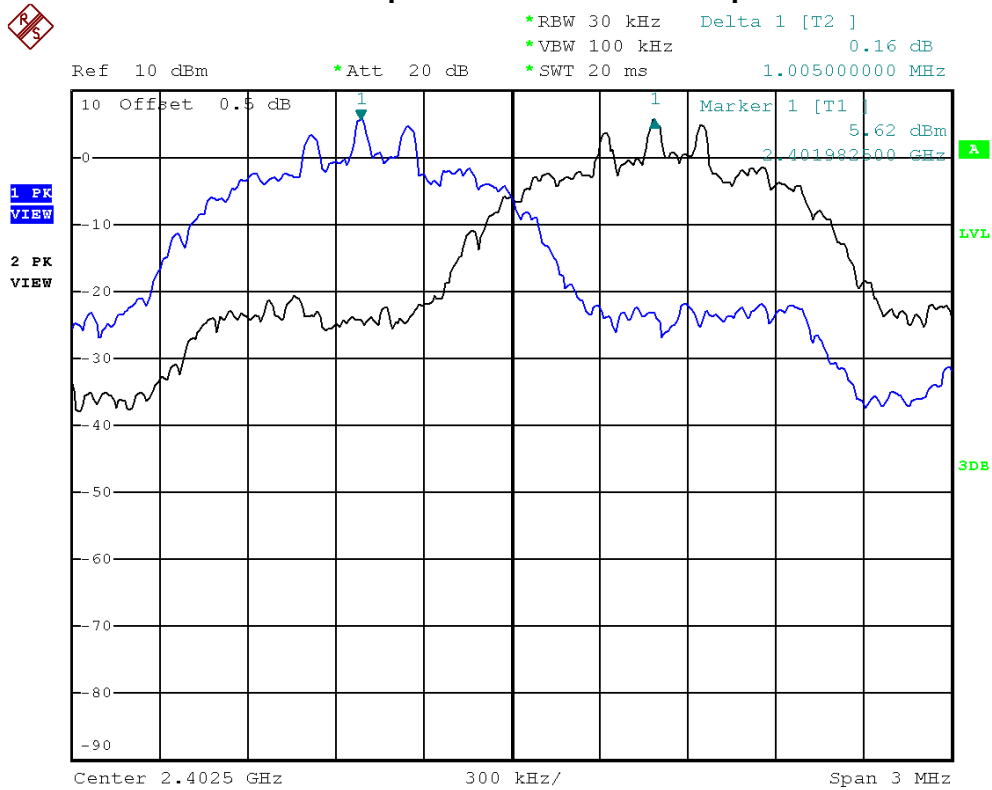

Bluetooth/3 Mbps/2402 MHz/20dB Bandwidth

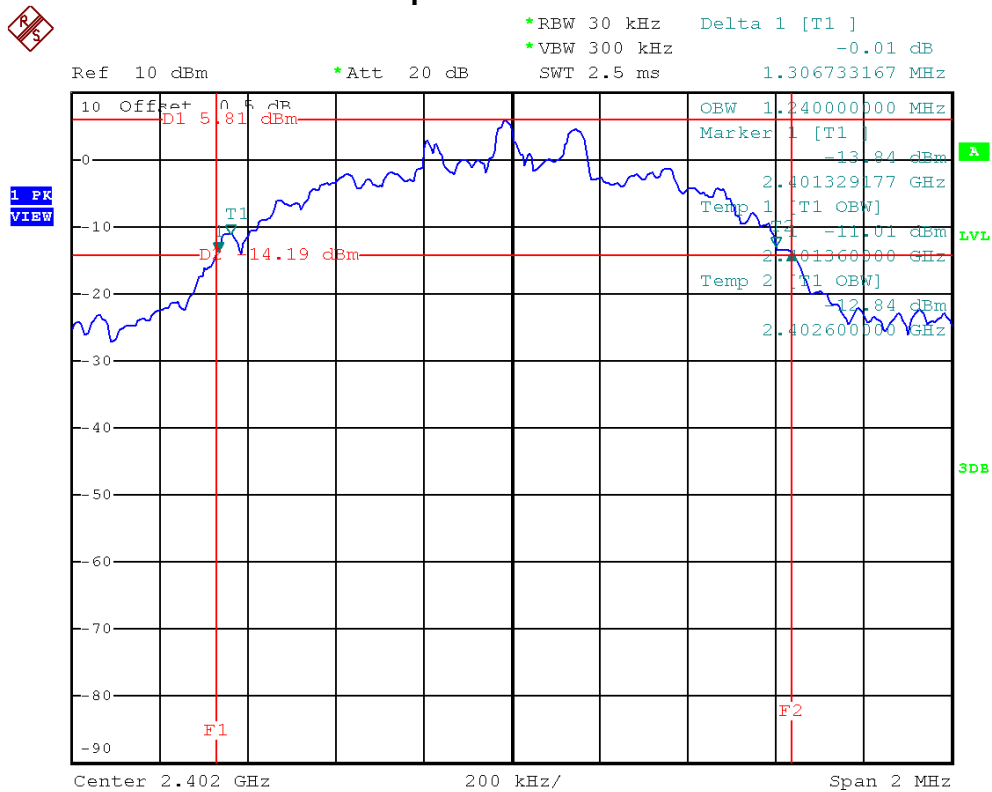



Neutron Engineering Inc.

Bluetooth/3 Mbps/2441 MHz/Channel Separation

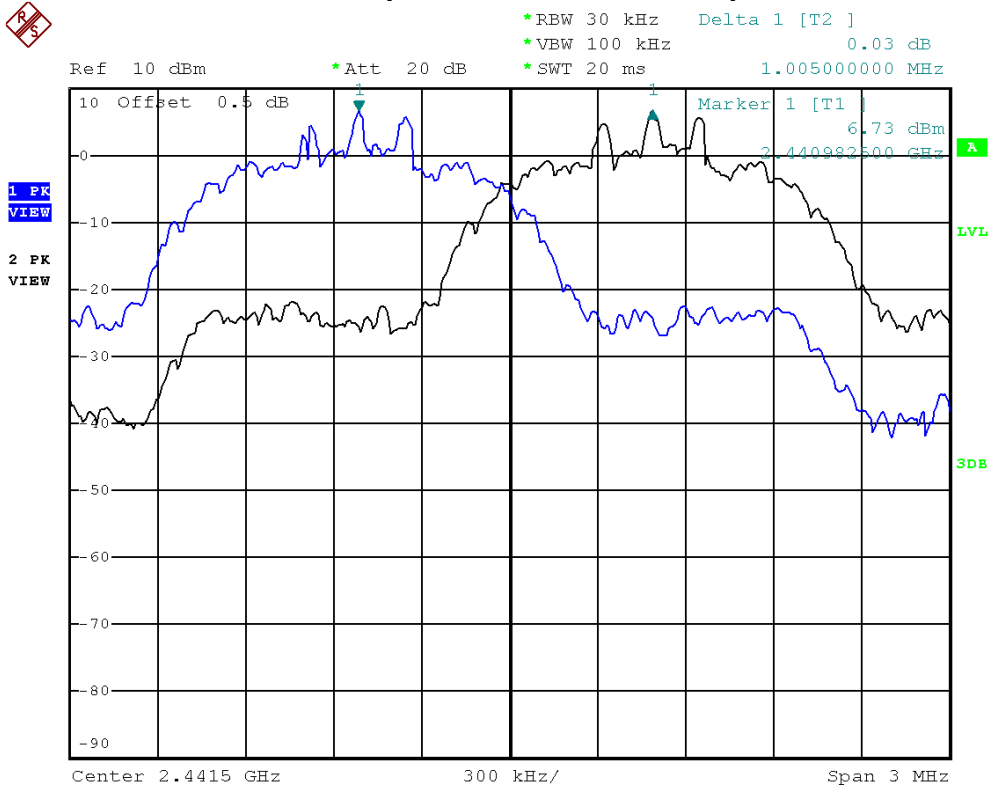

Bluetooth/3 Mbps/2441 MHz/20dB Bandwidth

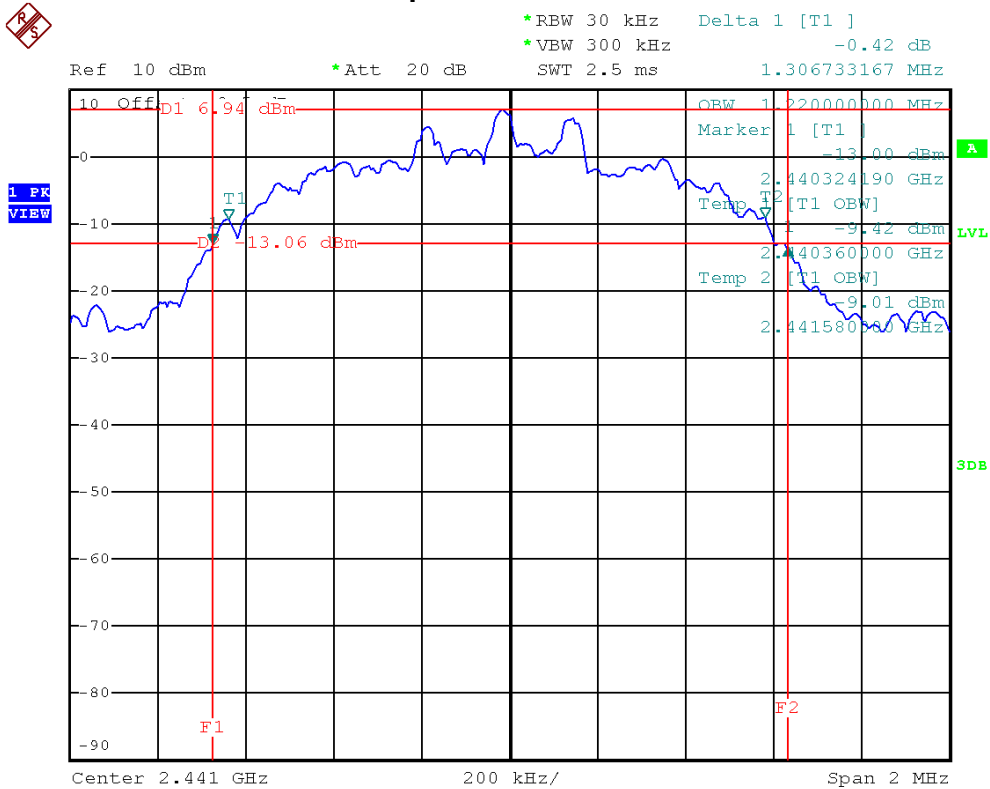



Neutron Engineering Inc.

Bluetooth/3 Mbps/2480 MHz/Channel Separation

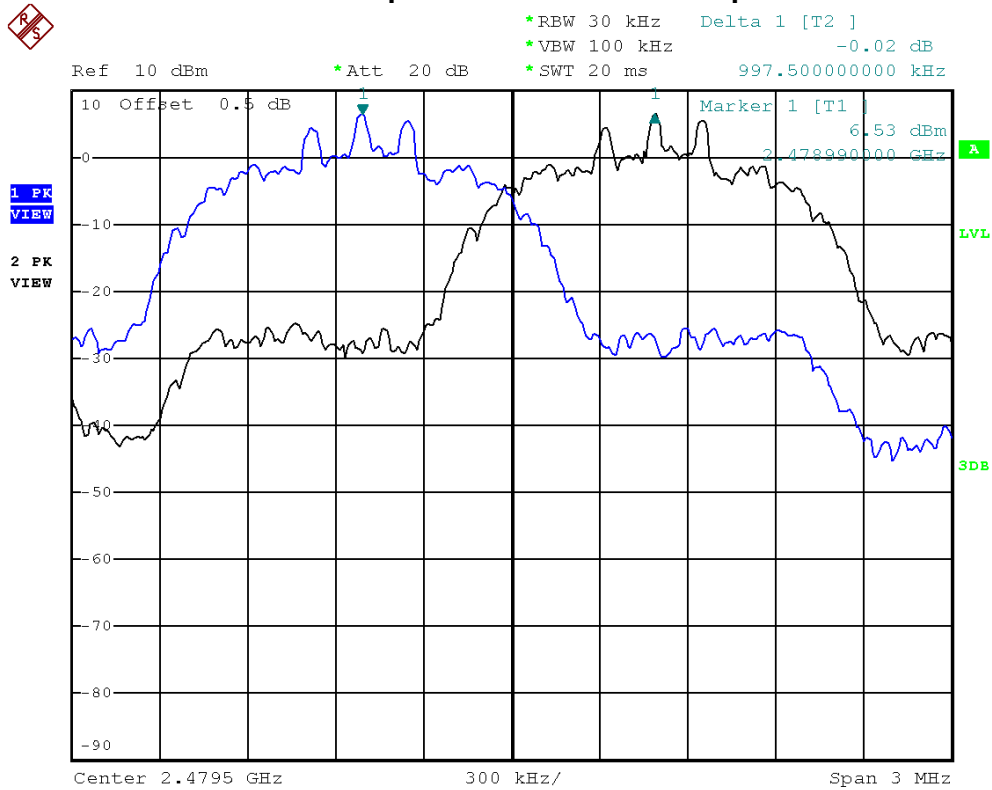

Bluetooth/3 Mbps/2480 MHz/20dB Bandwidth

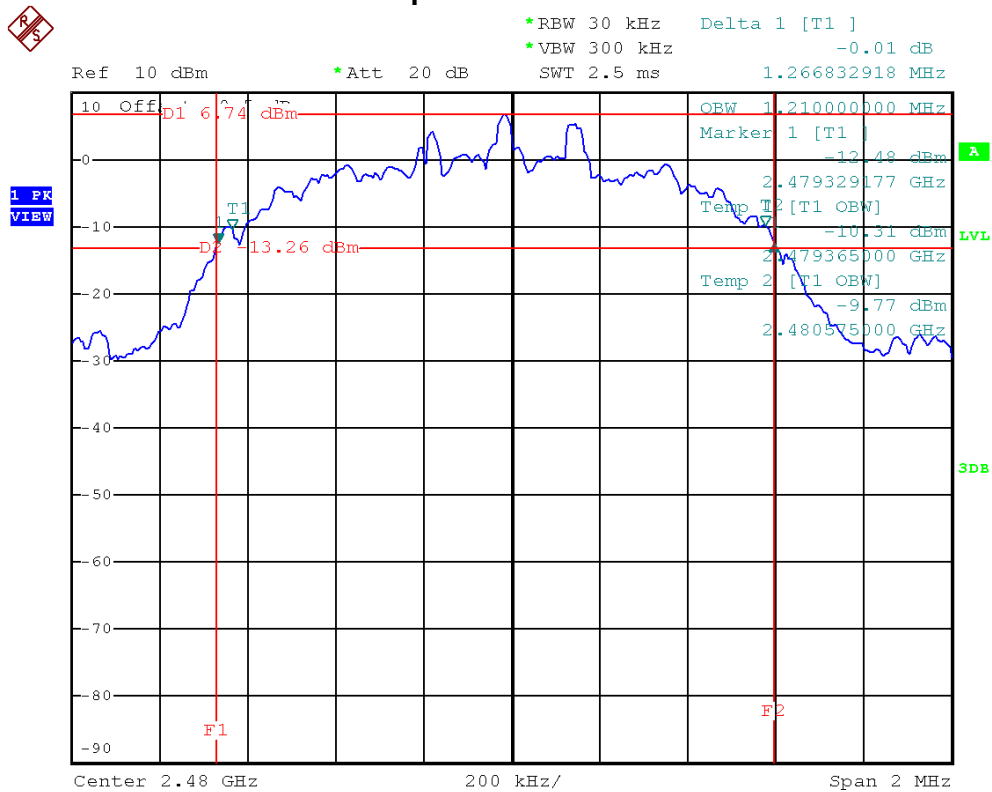



Neutron Engineering Inc.

7 MAXIMUM PEAK CONDUCTED OUTPUT POWER

7.1 LIMIT

Test Item	Frequency Range (MHz)	Limit
Maximum Peak Conducted Output Power	2400-2483.5	1 watt or 30 dBm

7.2 MEASUREMENT INSTRUMENTS LIST

Item	Kind of Equipment	Manufacturer	Type No.	Serial No.	Calibrated until
1	Spectrum Analyzer	R&S	FSP-30	100854	Sep. 08, 2014

NOTE: **N/A**: denotes No Model Name, No Serial No. or No Calibration specified.

7.3 TEST PROCEDURES

- a. The EUT was directly connected to the spectrum analyzer and antenna output port as show in the block diagram below,
- b. Spectrum Setting: RBW= 3 MHz, VBW= 3 MHz, Sweep time = Auto.

7.4 TEST SETUP LAYOUT

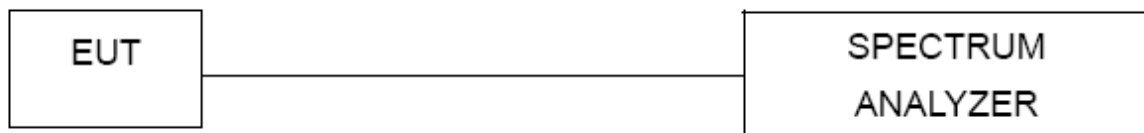

7.5 DEVIATION FROM TEST STANDARD

No deviation

7.6 EUT OPERATING CONDITIONS

The EUT tested system was configured as the statements of 5.6 Unless otherwise a special operating condition is specified in the follows during the testing.



Neutron Engineering Inc.

7.7 TEST RESULTS

EUT	BOOM BOOM !	Model Name	BOOM BOOM !
Temperature	26°C	Relative Humidity	46%
Test Voltage	AC 120V/60Hz		
Test Mode	Bluetooth/1 Mbps/2402 MHz, 2441 MHz, 2480 MHz		

Frequency	Peak Output Power		Limit		Result
	(dBm)	(W)	(dBm)	(W)	
2402 MHz	6.74	0.0047	30	1	PASS
2441 MHz	8.00	0.0063	30	1	PASS
2480 MHz	8.04	0.0064	30	1	PASS

Bluetooth/1 Mbps/2402 MHz/Peak Output Power

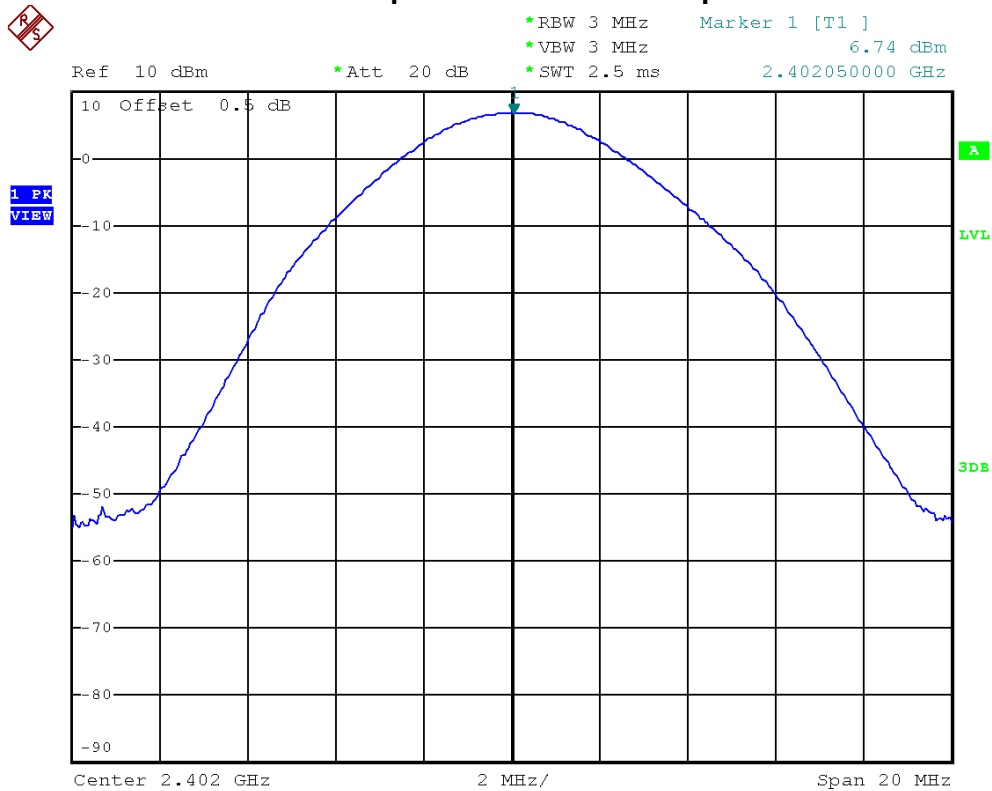



Neutron Engineering Inc.

Bluetooth/1 Mbps/2441 MHz/Peak Output Power

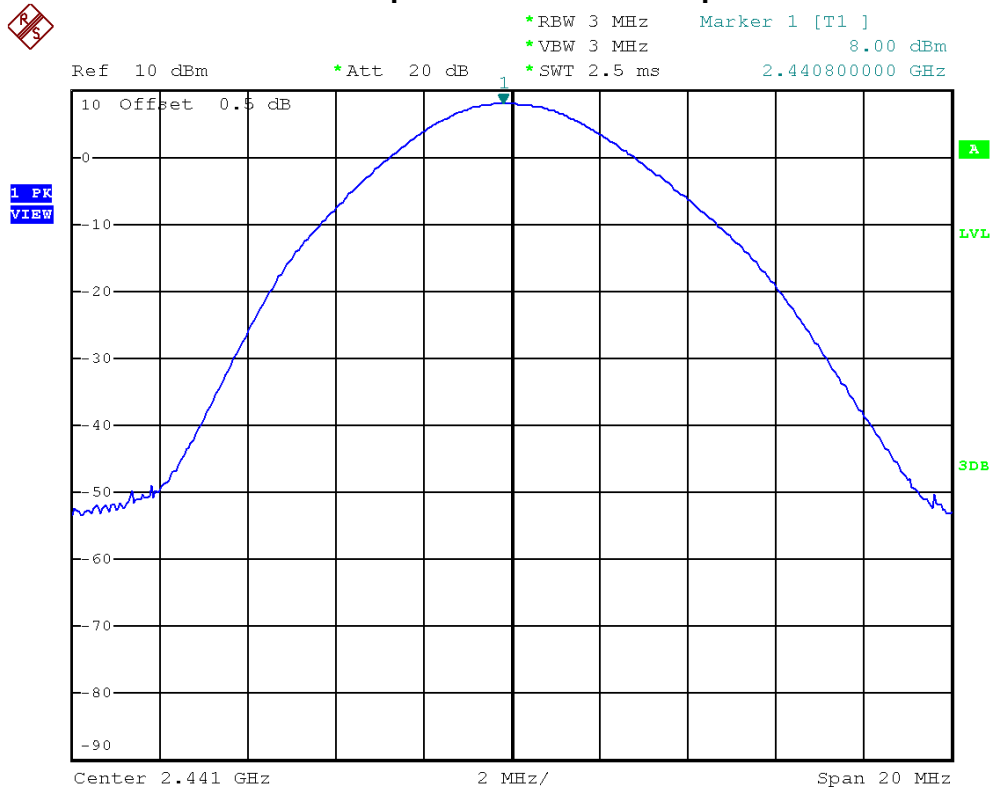

Bluetooth/1 Mbps/2480 MHz/Peak Output Power

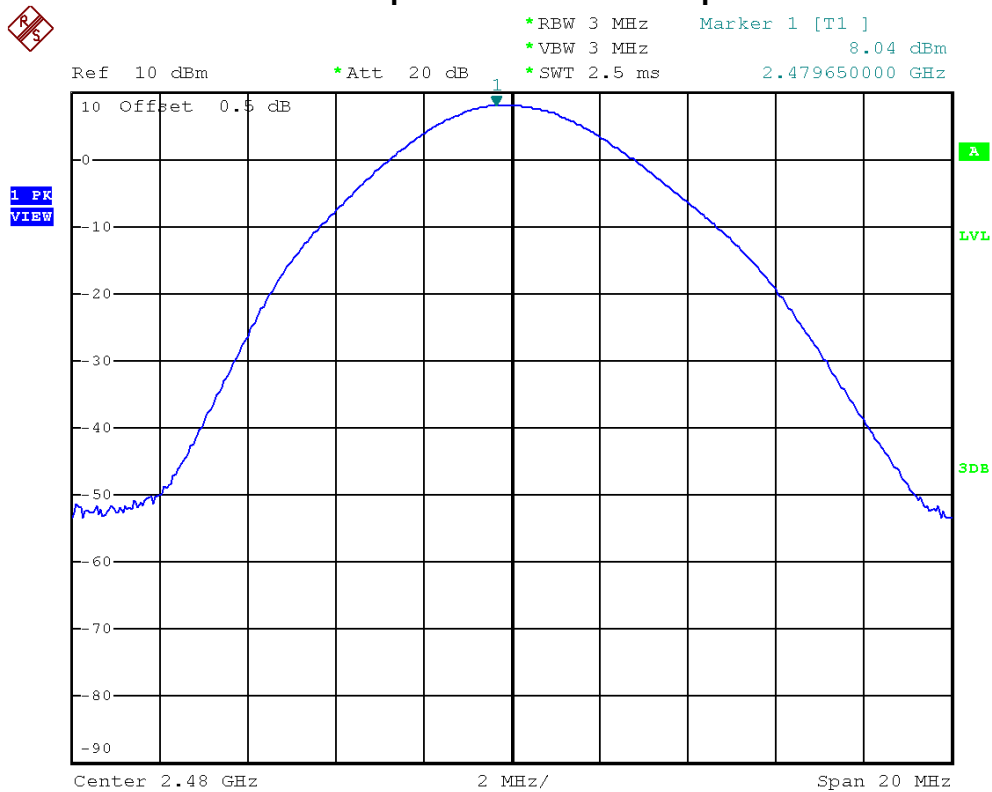



Neutron Engineering Inc.

EUT	BOOM BOOM !	Model Name	BOOM BOOM !
Temperature	26°C	Relative Humidity	46%
Test Voltage	AC 120V/60Hz		
Test Mode	Bluetooth/3 Mbps/2402 MHz, 2441 MHz, 2480 MHz		

Frequency	Peak Output Power		Limit		Result
	(dBm)	(W)	(dBm)	(W)	
2402 MHz	6.83	0.0048	30	1	PASS
2441 MHz	8.10	0.0065	30	1	PASS
2480 MHz	8.20	0.0066	30	1	PASS

Bluetooth/3 Mbps/2402 MHz/Peak Output Power

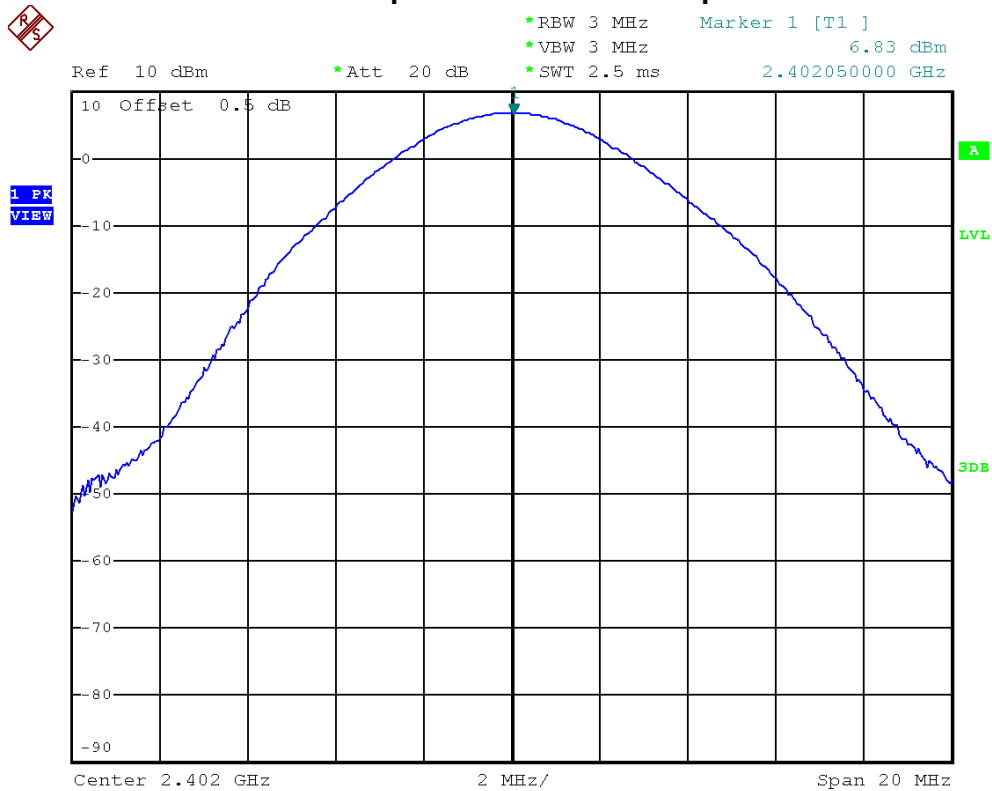



Neutron Engineering Inc.

Bluetooth/3 Mbps/2441 MHz/Peak Output Power

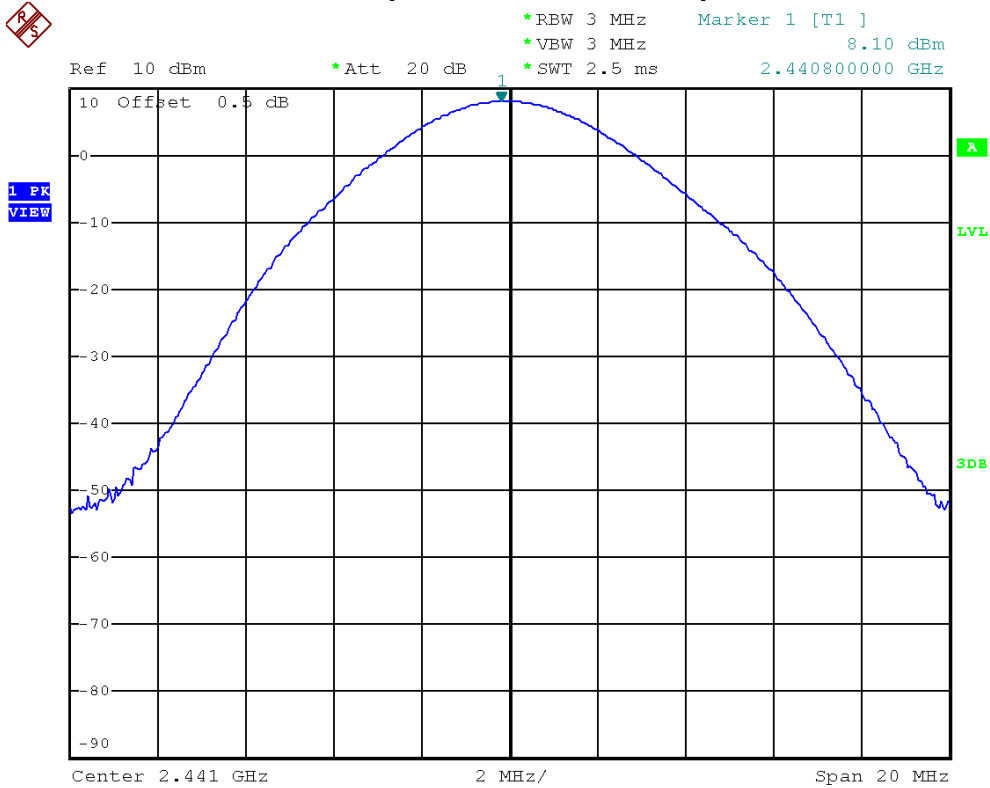

Bluetooth/3 Mbps/2480 MHz/Peak Output Power

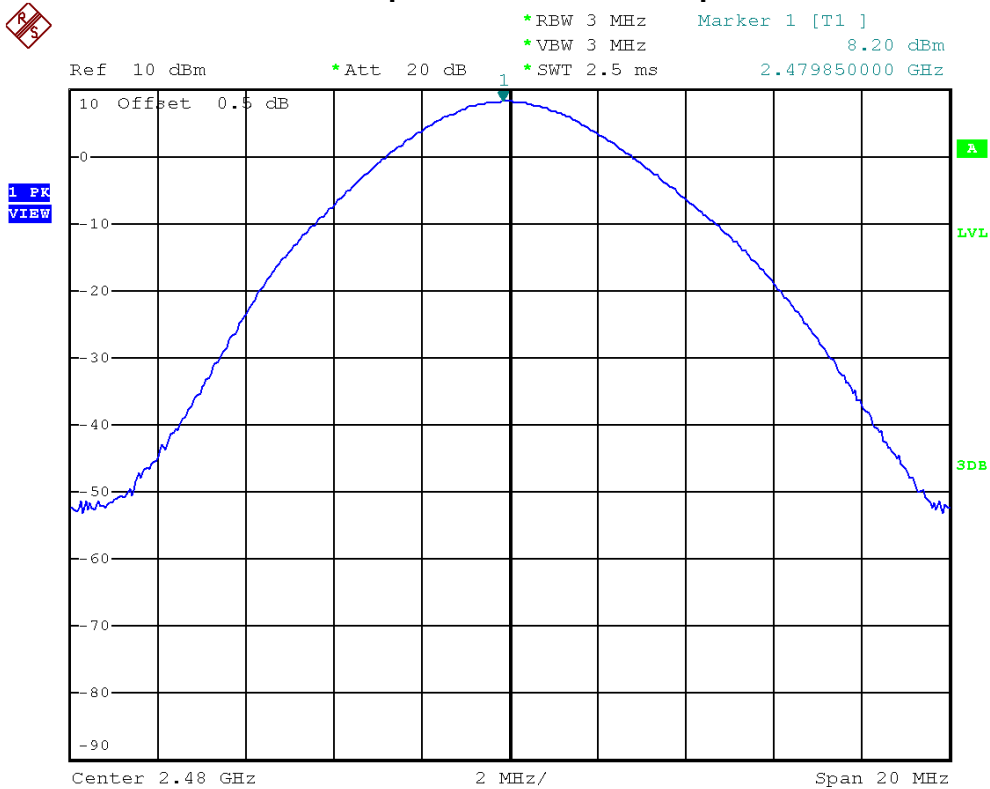



Neutron Engineering Inc.

8 RADIATED SPURIOUS EMISSION (9 KHZ TO 1 GHZ)

8.1 LIMIT

20 dB in any 100 kHz bandwidth outside the operating frequency band. In case the emission fall within the restricted band specified on 15.205(a), then the 15.209(a) limit in the table below has to be followed.

Frequency Range: 9 kHz to 1 GHz		
FREQUENCY (MHz)	Field Strength (microvolts/meter)	Measurement Distance (meters)
0.009~0.490	2400/F(kHz)	300
0.490~1.705	24000/F(kHz)	30
1.705~30.0	30	30
30~88	100	3
88~216	150	3
216~960	200	3
Above 960	500	3

Frequency Range: above 1 GHz				
FREQUENCY (MHz)	Class A (dBuV/m) (at 3m)		Class B (dBuV/m) (at 3m)	
	PEAK	AVERAGE	PEAK	AVERAGE
above 1 GHz	80	60	74	54

NOTE:

- (1) The limit for radiated test was performed according to FCC PART 15B.
- (2) The tighter limit applies at the band edges.
- (3) Emission level (dBuV/m)=20log Emission level (uV/m).
- (4) The test result calculated as following:
 Measurement Value = Reading Level + Correct Factor
 Correct Factor = Antenna Factor + Cable Loss – Amplifier Gain(if use)
 Margin Level = Measurement Value – Limit Value



Neutron Engineering Inc.

8.2 MEASUREMENT INSTRUMENTS LIST

Item	Kind of Equipment	Manufacturer	Type No.	Serial No.	Calibrated until
1	Spectrum Analyzer	R&S	FSP-30	100854	Sep. 08, 2014
2	Horn Antenna	Schwarzbeck	BBHA 9120	D-325	Apr. 15, 2014
3	Microwave Pre_amplifier	Agilent	8449B	3008A01714	Apr. 16, 2014
4	Microflex Cable	Harbour industries	27478LL142	1m	May. 13, 2014
5	Microflex Cable	EMC	S104-SMA	8m	May. 13, 2014
6	Microflex Cable	Harbour industries	27478LL142	3m	May. 13, 2014
7	Test Cable	LMR	LMR-400	12m	May. 14, 2014
8	Test Cable	LMR	LMR-400	3m	May. 14, 2014
9	Pre-Amplifier	Anritsu	MH648A	M92649	Jun. 18, 2014
10	Log-Bicon Antenna	Schwarzbeck	VULB9168-352	9168-352	Jun. 11, 2014
11	Preamplifier With Adaptor	EMC	EMC2654045	980030	Feb. 18, 2014
12	Horn Antenna	Schwarzbeck	BBHA 9170	340	Nov. 14, 2014

Remark: "N/A" denotes No Model Name, No Serial No. or No Calibration specified.

8.3 MEASURING INSTRUMENTS SETTING

EMI Test Receiver	Parameter Setting
Attenuation	Auto
Start ~ Stop Frequency	9kHz~150kHz / RB 200Hz for QP
Start ~ Stop Frequency	150kHz~30MHz / RB 9kHz for QP
Start ~ Stop Frequency	30MHz~1000MHz / RB 120kHz for QP

8.4 TEST PROCEDURES

- a. The measuring distance of at 3 m shall be used for measurements at frequency up to 1 GHz. For frequencies above 1 GHz, any suitable measuring distance may be used.
- b. The EUT was placed on the top of a rotating table 0.8 meters above the ground at a 3m Semi-anechoic chamber. The table was rotated 360 degrees to determine the position of the highest radiation.
- c. The height of the equipment or of the substitution antenna shall be 0.8 m; the height of the test antenna shall vary between 1 m to 4 m. Both horizontal and vertical polarizations of the antenna are set to make the measurement.
- d. The initial step in collecting conducted emission data is a spectrum analyzer peak detector mode pre-scanning the measurement frequency range. Significant peaks are then marked and then Quasi Peak detector mode re-measured.
- e. If the Peak Mode measured value compliance with and lower than Quasi Peak Mode Limit, the EUT shall be deemed to meet QP Limits and then no additional QP Mode measurement performed.
- f. For the actual test configuration, please refer to the related Item –EUT Test Photos.
- g. The testing follows the guidelines in ANSI C63.4 and FCC Public Notice DA 00-705 Measurement Guidelines. In case the emission is fail due to the used RBW/VBW is too wide, marker-delta method of FCC Public Notice DA 00-705 will be followed.

NOTE:

- a. Reading in which marked as QP or Peak means measurements by using are Quasi-Peak Mode with Detector BW=120 kHz; SPA setting in RBW=100 kHz, VBW =100 kHz, Swp. Time = 0.3 sec./ MHz.
- b. All readings are Peak unless otherwise stated QP in column of Note. Peak denotes that the Peak reading compliance with the QP Limits and then QP Mode measurement didn't perform.

8.5 DEVIATION FROM TEST STANDARD

No deviation

8.6 TEST SETUP LAYOUT

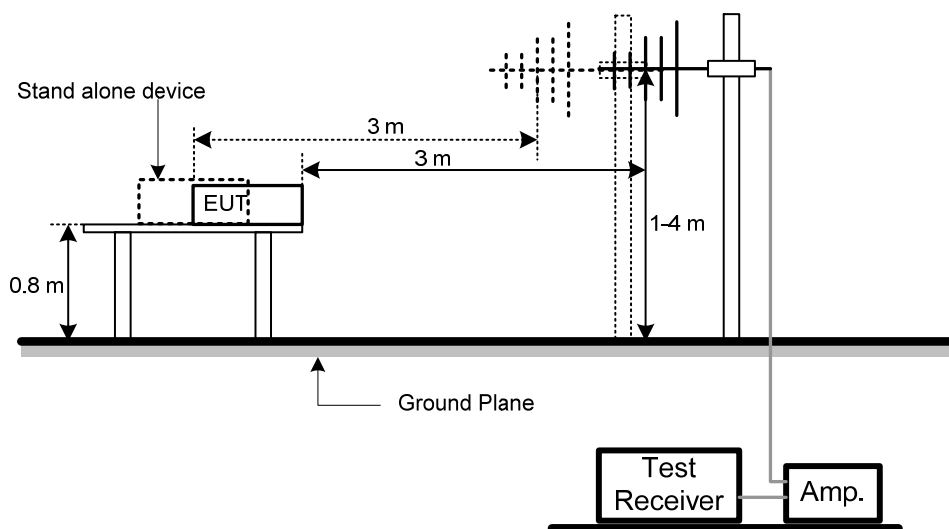



Neutron Engineering Inc.

8.7 EUT OPERATING CONDITIONS

The EUT tested system was configured as the statements of 5.6 Unless otherwise a special operating condition is specified in the follows during the testing.



Neutron Engineering Inc.

8.8 TEST RESULTS

EUT	BOOM BOOM !	Model Name	BOOM BOOM !
Temperature	25°C	Relative Humidity	62%
Test Voltage	AC 120V/60Hz		
Test Mode	Bluetooth/1 Mbps/2441 MHz		

Polarization: Vertical

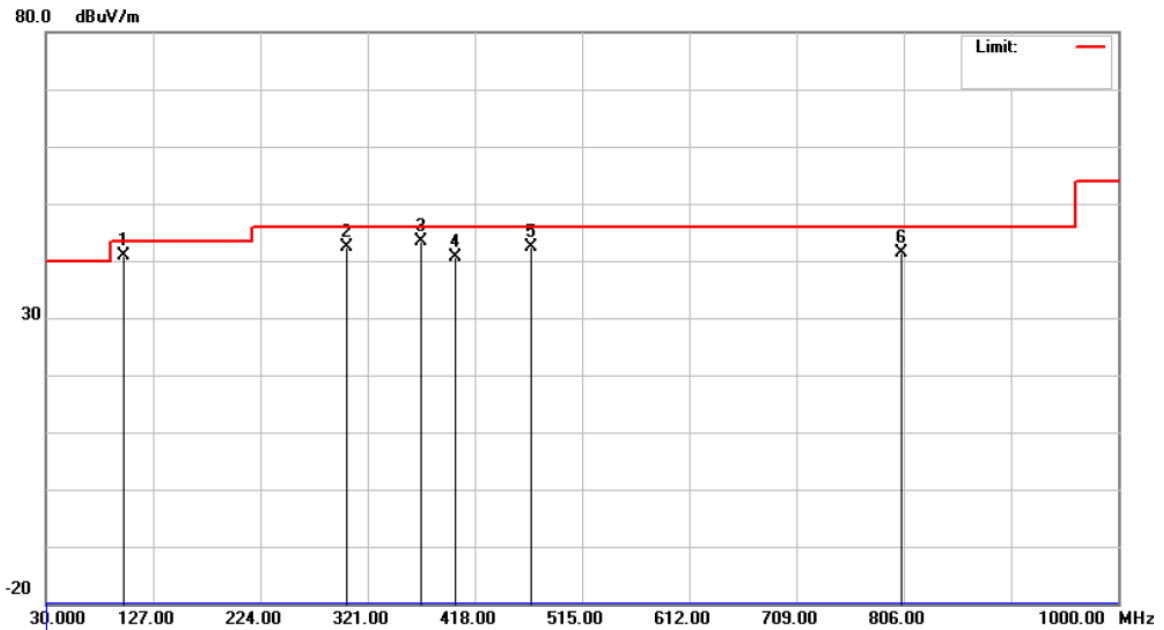

No. Mk.	Freq. MHz	Reading Level dBuV	Correct Factor dB	Measurement dBuV/m	Limit dBuV/m	Over dB	Detector	Comment
1	100.3248	59.99	-19.19	40.80	43.50	-2.70	peak	
2	301.6000	56.21	-13.88	42.33	46.00	-3.67	peak	
3 *	369.5000	55.48	-12.14	43.34	46.00	-2.66	peak	
4	401.0249	51.72	-11.16	40.56	46.00	-5.44	peak	
5	468.9248	51.98	-9.66	42.32	46.00	-3.68	peak	
6	803.5750	46.18	-4.78	41.40	46.00	-4.60	peak	



Neutron Engineering Inc.

EUT	BOOM BOOM !	Model Name	BOOM BOOM !
Temperature	25°C	Relative Humidity	62%
Test Voltage	AC 120V/60Hz		
Test Mode	Bluetooth/1 Mbps/2441 MHz		

Polarization: Horizontal

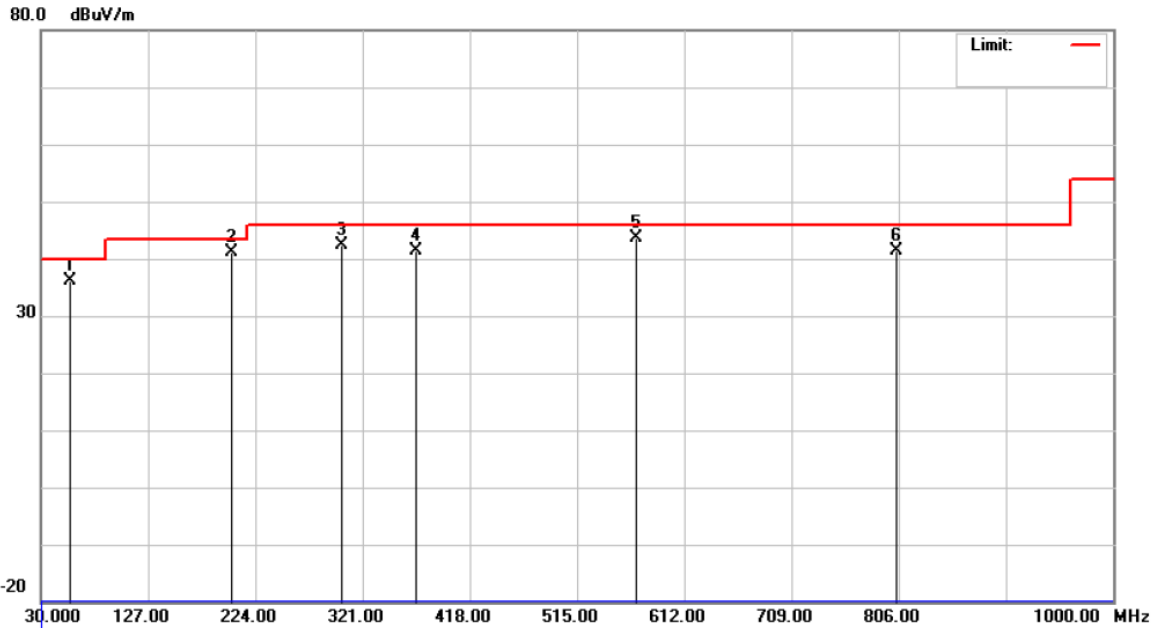

No. Mk.	Freq. MHz	Reading Level dBuV	Correct Factor dB	Measurement dBuV/m	Limit dBuV/m	Over dB	Detector	Comment
1	56.6749	50.02	-13.94	36.08	40.00	-3.92	peak	
2	202.1750	58.15	-16.92	41.23	43.50	-2.27	peak	
3	301.6000	56.38	-13.88	42.50	46.00	-3.50	peak	
4	369.5000	53.54	-12.14	41.40	46.00	-4.60	peak	
5 *	568.3499	51.43	-7.68	43.75	46.00	-2.25	peak	
6	803.5750	46.23	-4.78	41.45	46.00	-4.55	peak	



Neutron Engineering Inc.

9 RADIATED SPURIOUS EMISSION (ABOVE 1 GHz)

9.1 LIMIT

20dBc in any 100 kHz bandwidth outside the operating frequency band. In case the emission fall within the restricted band specified on 15.205(a), then the 15.209(a) limit in the table below has to be followed.

Frequency Range: 9 kHz to 1 GHz		
FREQUENCY (MHz)	Field Strength (micovolts/meter)	Measurement Distance (meters)
0.009~0.490	2400/F(kHz)	300
0.490~1.705	24000/F(kHz)	30
1.705~30.0	30	30
30~88	100	3
88~216	150	3
216~960	200	3
Above 960	500	3

Frequency Range: above 1 GHz				
FREQUENCY (MHz)	Class A (dBuV/m) (at 3m)		Class B (dBuV/m) (at 3m)	
	PEAK	AVERAGE	PEAK	AVERAGE
above 1 GHz	80	60	74	54

NOTE:

- (1) The limit for radiated test was performed according to FCC PART 15B.
- (2) The tighter limit applies at the band edges.
- (3) Emission level (dBuV/m)=20log Emission level (uV/m).
- (4) The test result calculated as following:
 Measurement Value = Reading Level + Correct Factor
 Correct Factor = Antenna Factor + Cable Loss – Amplifier Gain(if use)
 Margin Level = Measurement Value – Limit Value



Neutron Engineering Inc.

9.2 MEASUREMENT INSTRUMENTS LIST

Item	Kind of Equipment	Manufacturer	Type No.	Serial No.	Calibrated until
1	Spectrum Analyzer	R&S	FSP-30	100854	Sep. 08, 2014
2	Horn Antenna	Schwarzbeck	BBHA 9120	D-325	Apr. 15, 2014
3	Microwave Pre_amplifier	Agilent	8449B	3008A01714	Apr. 16, 2014
4	Microflex Cable	Harbour industries	27478LL142	1m	May. 13, 2014
5	Microflex Cable	EMC	S104-SMA	8m	May. 13, 2014
6	Microflex Cable	Harbour industries	27478LL142	3m	May. 13, 2014
7	Test Cable	LMR	LMR-400	12m	May. 14, 2014
8	Test Cable	LMR	LMR-400	3m	May. 14, 2014
9	Pre-Amplifier	Anritsu	MH648A	M92649	Jun. 18, 2014
10	Log-Bicon Antenna	Schwarzbeck	VULB9168-352	9168-352	Jun. 11, 2014
11	Preamplifier With Adaptor	EMC	EMC2654045	980030	Feb. 18, 2014
12	Horn Antenna	Schwarzbeck	BBHA 9170	340	Nov. 14, 2014

Remark: "N/A" denotes No Model Name, No Serial No. or No Calibration specified.

9.3 MEASURING INSTRUMENTS SETTING

Spectrum Analyzer	Parameter Setting
Attenuation	Auto
Start Frequency	1000 MHz
Stop Frequency	10th carrier harmonic
RB / VB (emission in restricted band)	1MHz / 1MHz for Peak, 1 MHz / 10Hz for Average
RB / VB (other emission)	1MHz / 1MHz for Peak, 1 MHz / 10Hz for Average

9.4 TEST PROCEDURES

- a. The measuring distance of at 3 m shall be used for measurements at frequency up to 1 GHz. For frequencies above 1 GHz, any suitable measuring distance may be used.
- b. The EUT was placed on the top of a rotating table 0.8 meters above the ground at a 3m Semi-anechoic chamber. The table was rotated 360 degrees to determine the position of the highest radiation.
- c. The height of the equipment or of the substitution antenna shall be 0.8 m; the height of the test antenna shall vary between 1 m to 4 m. Both horizontal and vertical polarizations of the antenna are set to make the measurement.
- d. The initial step in collecting conducted emission data is a spectrum analyzer peak detector mode pre-scanning the measurement frequency range. Significant peaks are then marked and then Quasi Peak detector mode re-measured.
- e. If the Peak Mode measured value compliance with and lower than Quasi Peak Mode Limit, the EUT shall be deemed to meet QP Limits and then no additional QP Mode measurement performed.
- f. For the actual test configuration, please refer to the related Item –EUT Test Photos.
- g. The testing follows the guidelines in ANSI C63.4 and FCC Public Notice DA 00-705 Measurement Guidelines. In case the emission is fail due to the used RBW/VBW is too wide, marker-delta method of FCC Public Notice DA 00-705 will be followed.

NOTE:

- a. Reading in which marked as Peak means measurements by using are Peak Mode with instrument setting in RBW= 1 MHz, VBW= 1 MHz, Swp. Time = Auto.
Reading in which marked as AV means measurements by using are Average Mode with instrument setting in RBW= 1 MHz, VBW= 10 Hz, Swp. Time = Auto.
- b. All readings are Peak Mode value unless otherwise stated AVG in column of Note. If the Peak Mode Measured value compliance with the Peak Limits and lower than AVG Limits, the EUT shall be deemed to meet both Peak & AVG Limits and then only Peak Mode was measured, but AVG Mode didn't perform.

9.5 DEVIATION FROM TEST STANDARD

No deviation

9.6 TEST SETUP LAYOUT

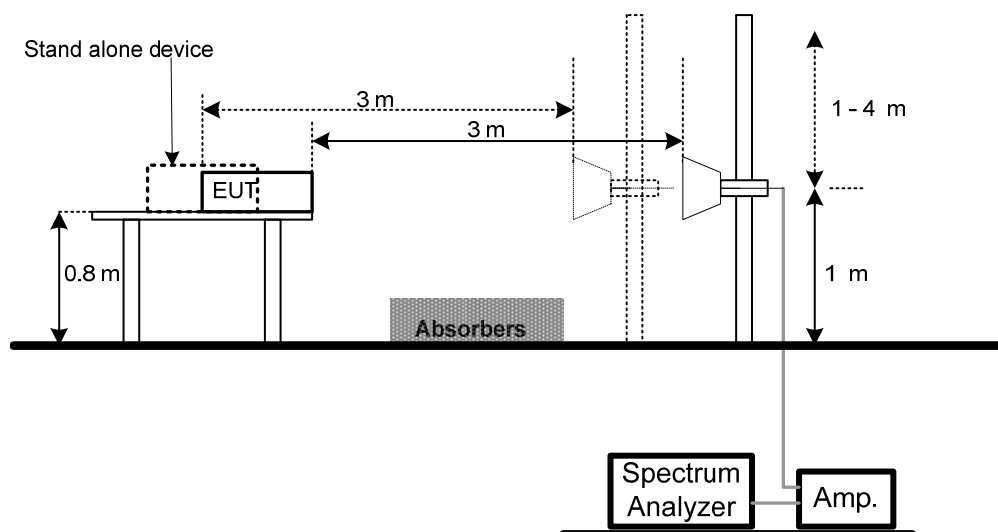



9.7 EUT OPERATING CONDITIONS

The EUT tested system was configured as the statements of 5.6 Unless otherwise a special operating condition is specified in the follows during the testing.



Neutron Engineering Inc.

9.8 TEST RESULTS

EUT	BOOM BOOM !	Model Name	BOOM BOOM !
Temperature	25°C	Relative Humidity	62%
Test Voltage	AC 120V/60Hz		
Test Mode	Bluetooth/1 Mbps/2402 MHz		

Polarization: Vertical

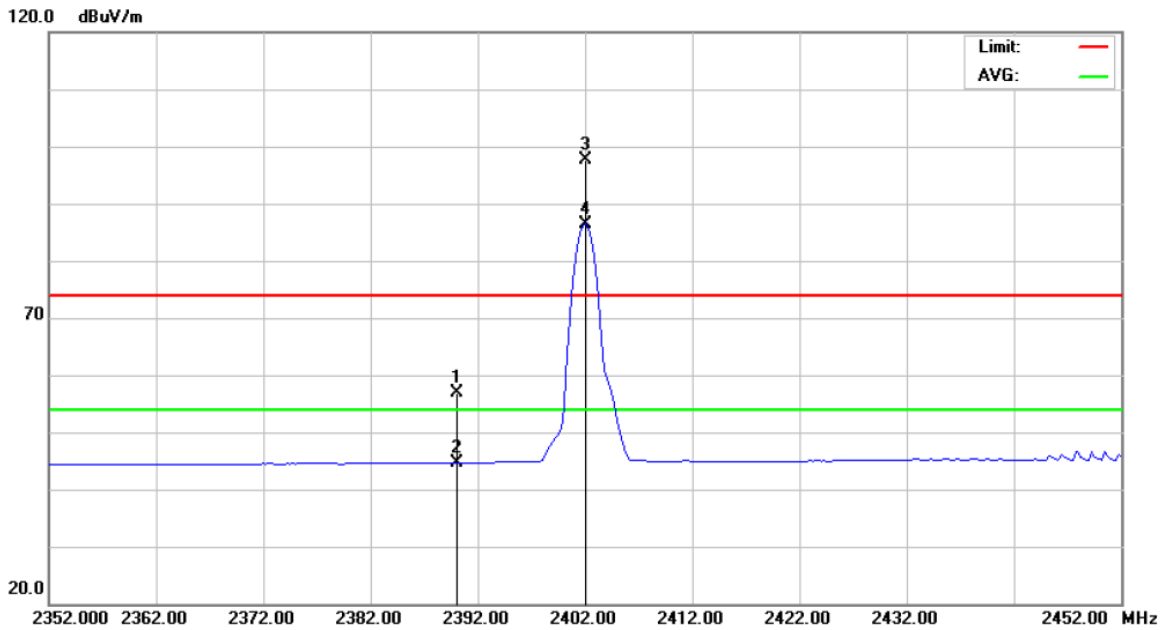

No.	Mk.	Freq. MHz	Reading Level dBuV	Correct Factor dB	Measure- ment dBuV/m	Limit dBuV/m	Over dB	Detector	Comment
1		2390.000	25.27	31.67	56.94	74.00	-17.06	peak	
2		2390.000	12.96	31.67	44.63	54.00	-9.37	AVG	
3	X	2402.000	65.88	31.72	97.60	74.00	23.60	peak	
4	*	2402.000	54.78	31.72	86.50	54.00	32.50	AVG	



Neutron Engineering Inc.

EUT	BOOM BOOM !	Model Name	BOOM BOOM !
Temperature	25°C	Relative Humidity	62%
Test Voltage	AC 120V/60Hz		
Test Mode	Bluetooth/1 Mbps/2402 MHz		

Polarization: Vertical

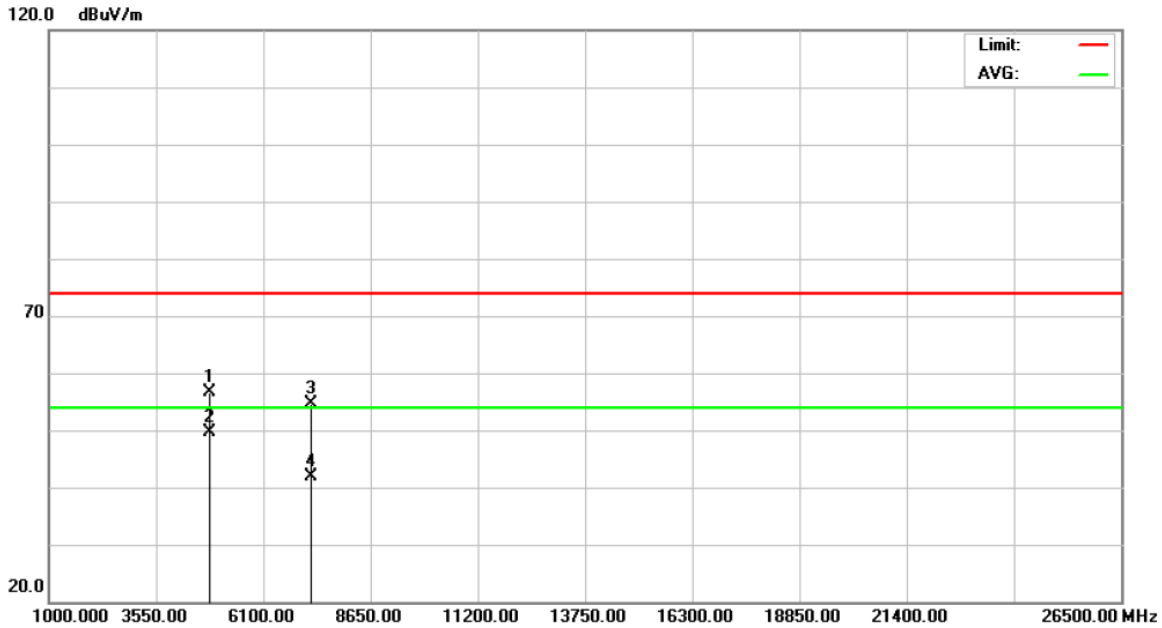

No. Mk.	Freq. MHz	Reading Level dBuV	Correct Factor dB	Measurement dBuV/m	Limit dBuV/m	Over dB	Detector	Comment
1	4803.960	50.96	5.69	56.65	74.00	-17.35	peak	
2 *	4803.960	44.02	5.69	49.71	54.00	-4.29	AVG	
3	7206.420	42.47	12.18	54.65	74.00	-19.35	peak	
4	7206.420	29.82	12.18	42.00	54.00	-12.00	AVG	



Neutron Engineering Inc.

EUT	BOOM BOOM !	Model Name	BOOM BOOM !
Temperature	25°C	Relative Humidity	62%
Test Voltage	AC 120V/60Hz		
Test Mode	Bluetooth/1 Mbps/2402 MHz		

Polarization: Horizontal

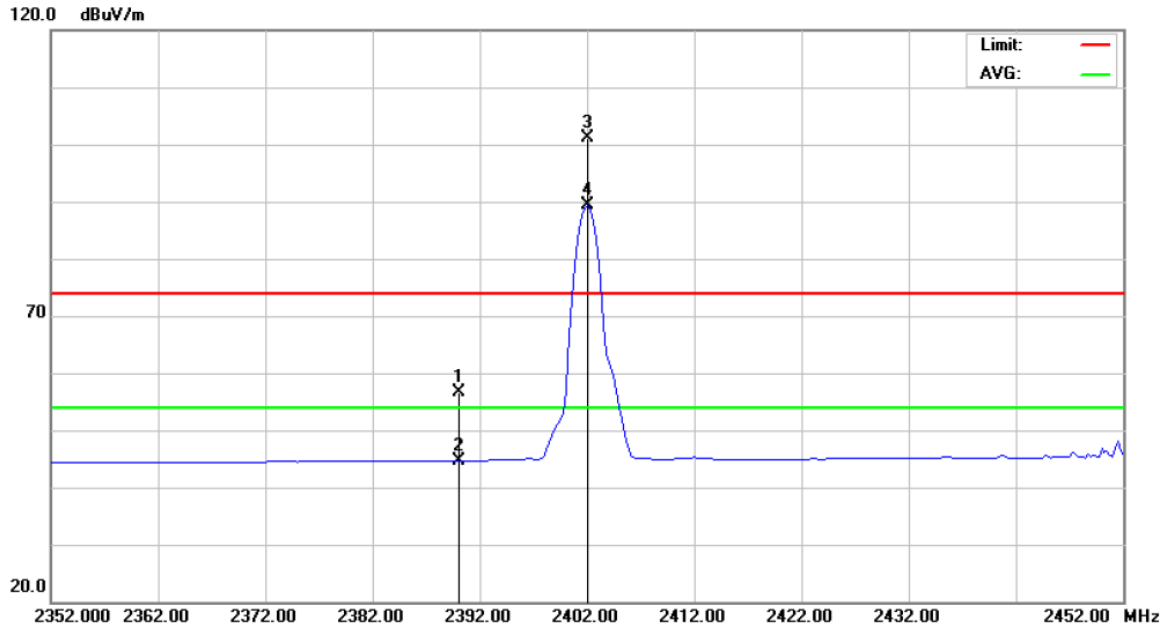

No.	Mk.	Freq. MHz	Reading Level dBuV	Correct Factor dB	Measure- ment dBuV/m	Limit dBuV/m	Over dB	Detector	Comment
1		2390.000	24.99	31.67	56.66	74.00	-17.34	peak	
2		2390.000	13.00	31.67	44.67	54.00	-9.33	AVG	
3	X	2402.000	69.35	31.72	101.07	74.00	27.07	peak	
4	*	2402.000	57.54	31.72	89.26	54.00	35.26	AVG	



Neutron Engineering Inc.

EUT	BOOM BOOM !	Model Name	BOOM BOOM !
Temperature	25°C	Relative Humidity	62%
Test Voltage	AC 120V/60Hz		
Test Mode	Bluetooth/1 Mbps/2402 MHz		

Polarization: Horizontal

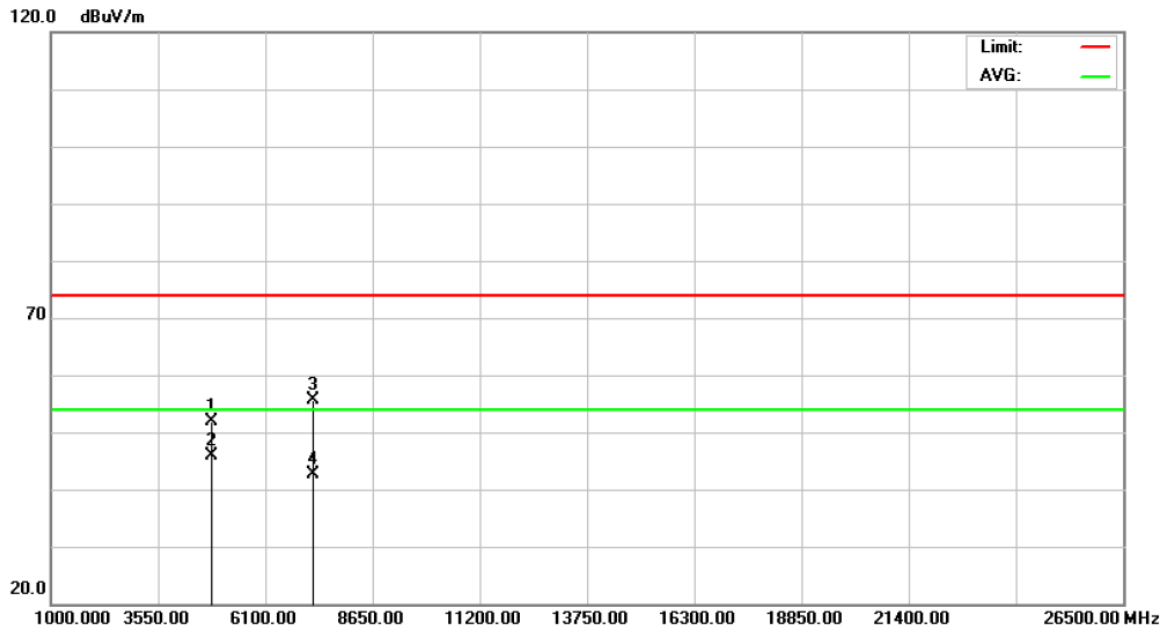

No. Mk.	Freq. MHz	Reading Level dBuV	Correct Factor dB	Measurement dBuV/m	Limit dBuV/m	Over dB	Detector	Comment
1	4803.980	46.25	5.69	51.94	74.00	-22.06	peak	
2 *	4803.980	40.13	5.69	45.82	54.00	-8.18	AVG	
3	7206.475	43.44	12.18	55.62	74.00	-18.38	peak	
4	7206.475	30.36	12.18	42.54	54.00	-11.46	AVG	



Neutron Engineering Inc.

EUT	BOOM BOOM !	Model Name	BOOM BOOM !
Temperature	25°C	Relative Humidity	62%
Test Voltage	AC 120V/60Hz		
Test Mode	Bluetooth/1 Mbps/2441 MHz		

Polarization: Vertical

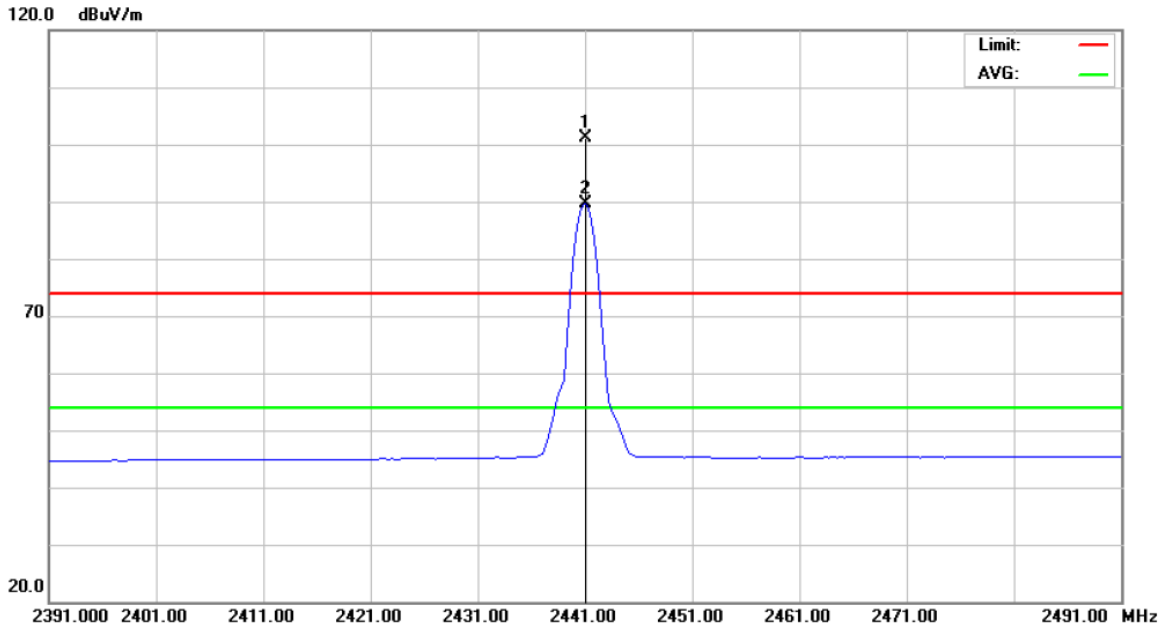

No.	Mk.	Freq. MHz	Reading Level dBuV	Correct Factor dB	Measure- ment dBuV/m	Limit dBuV/m	Over dB	Detector	Comment
1	X	2441.000	69.32	31.90	101.22	74.00	27.22	peak	
2	*	2441.000	57.66	31.90	89.56	54.00	35.56	AVG	



Neutron Engineering Inc.

EUT	BOOM BOOM !	Model Name	BOOM BOOM !
Temperature	25°C	Relative Humidity	62%
Test Voltage	AC 120V/60Hz		
Test Mode	Bluetooth/1 Mbps/2441 MHz		

Polarization: Vertical

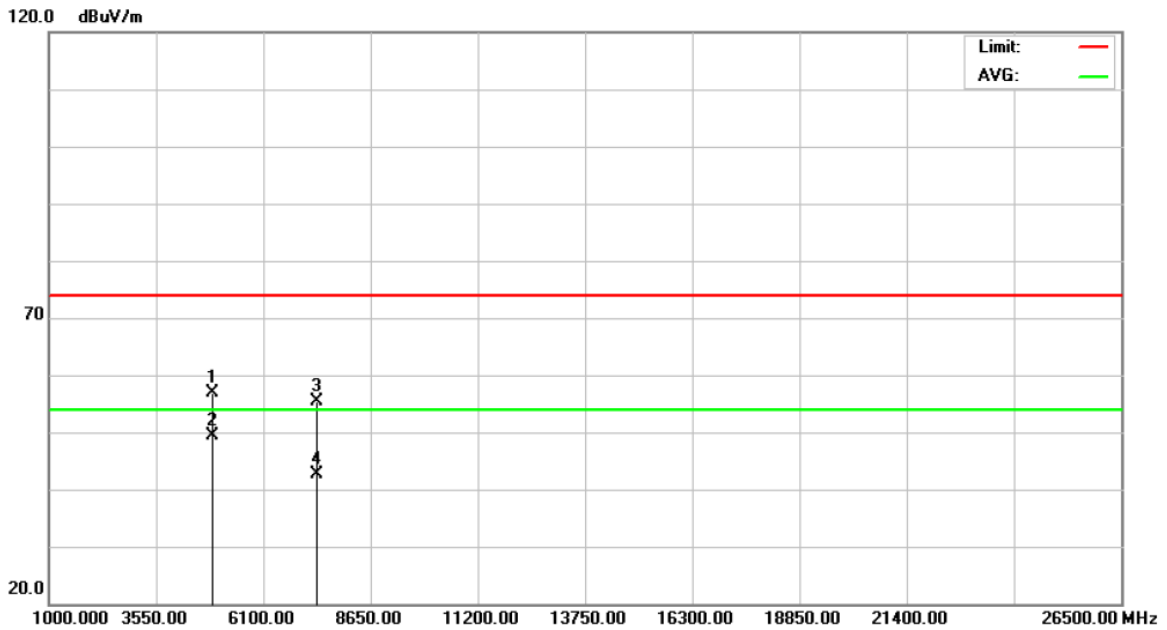

No. Mk.	Freq. MHz	Reading Level dBuV	Correct Factor dB	Measurement dBuV/m	Limit dBuV/m	Over dB	Detector	Comment
1	4881.965	50.97	5.79	56.76	74.00	-17.24	peak	
2 *	4881.965	43.63	5.79	49.42	54.00	-4.58	AVG	
3	7322.745	42.71	12.61	55.32	74.00	-18.68	peak	
4	7322.745	30.07	12.61	42.68	54.00	-11.32	AVG	



Neutron Engineering Inc.

EUT	BOOM BOOM !	Model Name	BOOM BOOM !
Temperature	25°C	Relative Humidity	62%
Test Voltage	AC 120V/60Hz		
Test Mode	Bluetooth/1 Mbps/2441 MHz		

Polarization: Horizontal

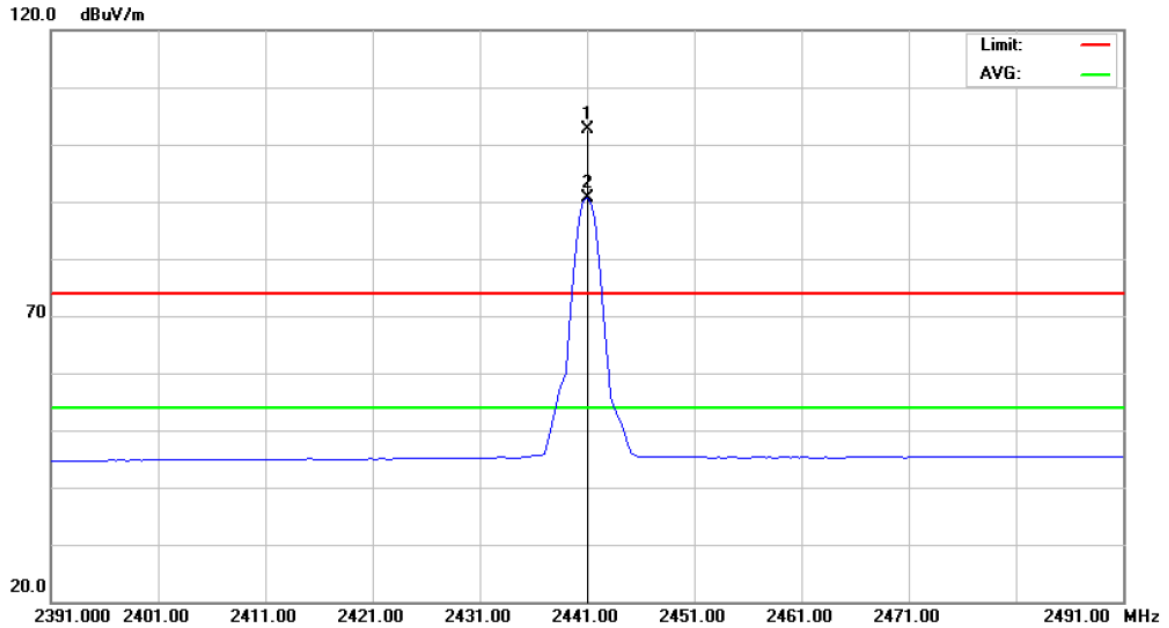

No.	Mk.	Freq.	Reading Level	Correct Factor	Measurement	Limit	Over	Detector	Comment
		MHz	dBuV	dB	dBuV/m	dBuV/m	dB		
1	X	2441.000	70.73	31.90	102.63	74.00	28.63	peak	
2	*	2441.000	58.77	31.90	90.67	54.00	36.67	AVG	



Neutron Engineering Inc.

EUT	BOOM BOOM !	Model Name	BOOM BOOM !
Temperature	25°C	Relative Humidity	62%
Test Voltage	AC 120V/60Hz		
Test Mode	Bluetooth/1 Mbps/2441 MHz		

Polarization: Horizontal

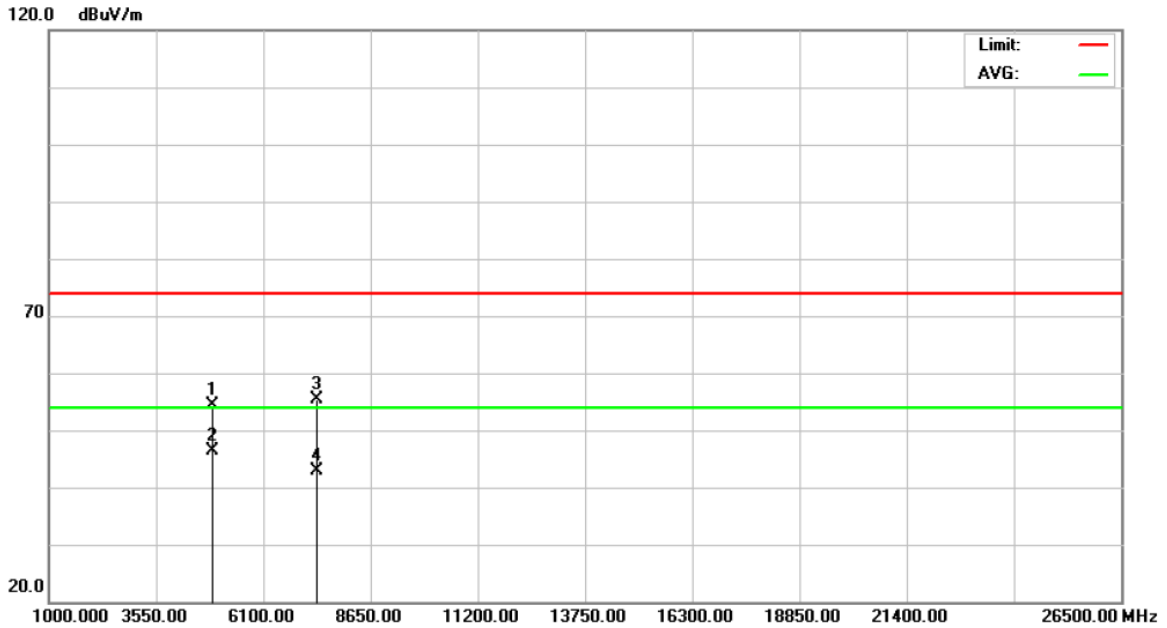

No. Mk.	Freq. MHz	Reading Level dBuV	Correct Factor dB	Measurement dBuV/m	Limit dBuV/m	Over dB	Detector	Comment
1	4882.020	48.65	5.79	54.44	74.00	-19.56	peak	
2 *	4882.020	40.59	5.79	46.38	54.00	-7.62	AVG	
3	7322.910	42.68	12.61	55.29	74.00	-18.71	peak	
4	7322.910	30.18	12.61	42.79	54.00	-11.21	AVG	



Neutron Engineering Inc.

EUT	BOOM BOOM !	Model Name	BOOM BOOM !
Temperature	25°C	Relative Humidity	62%
Test Voltage	AC 120V/60Hz		
Test Mode	Bluetooth/1 Mbps/2480 MHz		

Polarization: Vertical

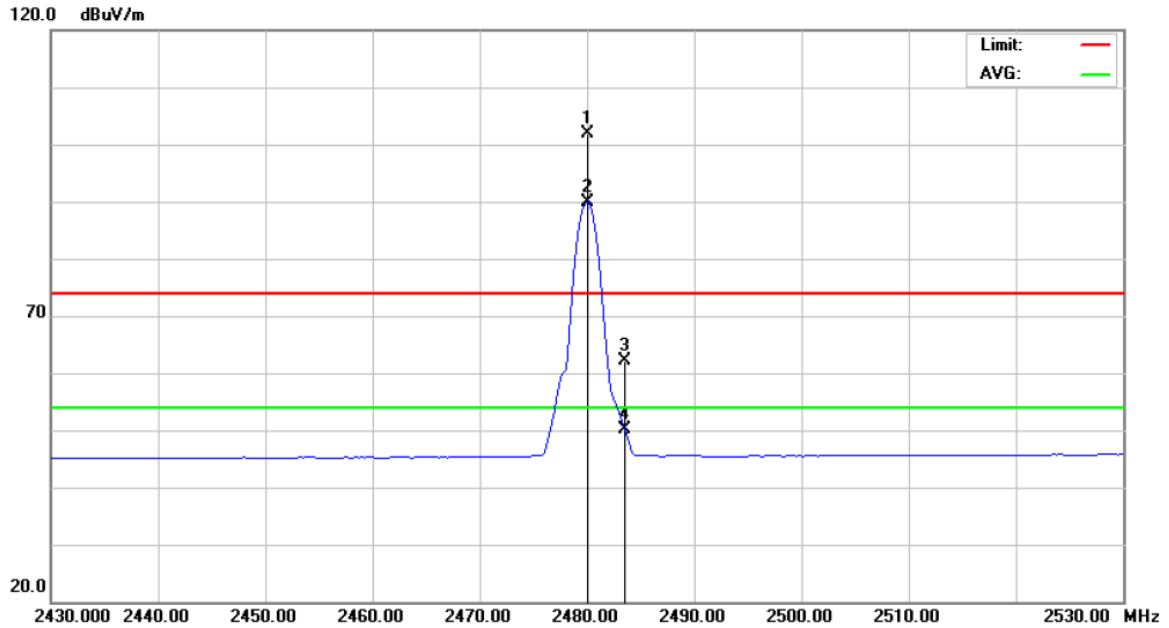

No.	Mk.	Freq. MHz	Reading Level dBuV	Correct Factor dB	Measure- ment dBuV/m	Limit dBuV/m	Over dB	Detector	Comment
1	X	2480.000	69.77	32.07	101.84	74.00	27.84	peak	
2	*	2480.000	57.90	32.07	89.97	54.00	35.97	AVG	
3		2483.500	30.02	32.09	62.11	74.00	-11.89	peak	
4		2483.500	18.13	32.09	50.22	54.00	-3.78	AVG	



Neutron Engineering Inc.

EUT	BOOM BOOM !	Model Name	BOOM BOOM !
Temperature	25°C	Relative Humidity	62%
Test Voltage	AC 120V/60Hz		
Test Mode	Bluetooth/1 Mbps/2480 MHz		

Polarization: Vertical

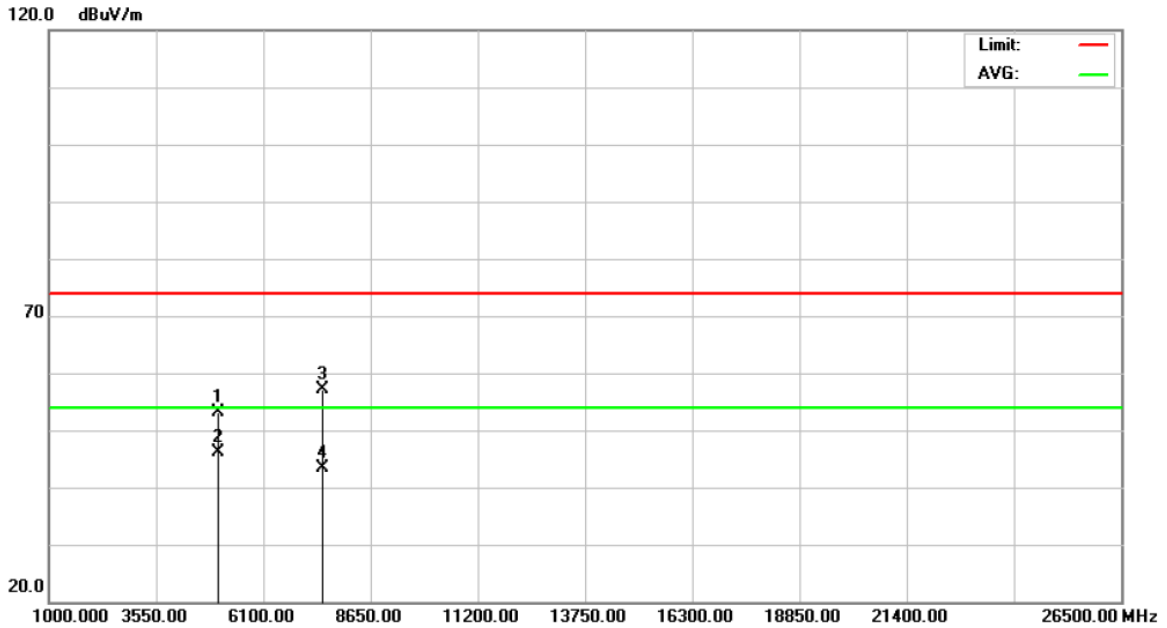

No. Mk.	Freq. MHz	Reading Level dBuV	Correct Factor dB	Measurement dBuV/m	Limit dBuV/m	Over dB	Detector	Comment
1	4959.965	47.12	5.89	53.01	74.00	-20.99	peak	
2 *	4959.965	40.14	5.89	46.03	54.00	-7.97	AVG	
3	7440.030	44.01	13.05	57.06	74.00	-16.94	peak	
4	7440.030	30.28	13.05	43.33	54.00	-10.67	AVG	



Neutron Engineering Inc.

EUT	BOOM BOOM !	Model Name	BOOM BOOM !
Temperature	25°C	Relative Humidity	62%
Test Voltage	AC 120V/60Hz		
Test Mode	Bluetooth/1 Mbps/2480 MHz		

Polarization: Horizontal

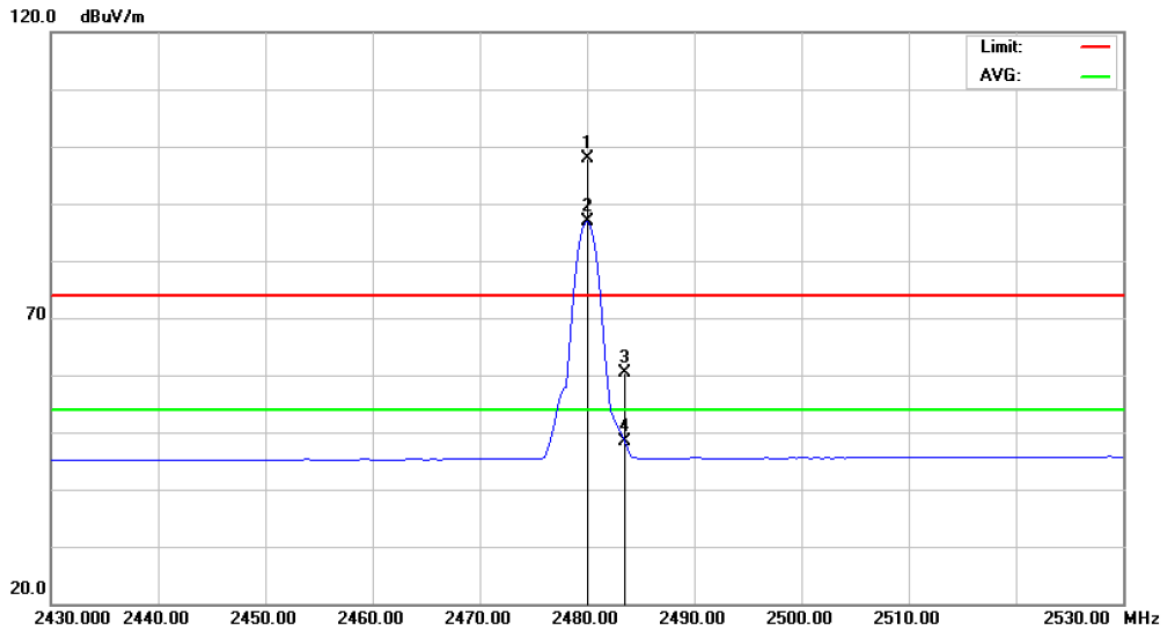

No.	Mk.	Freq. MHz	Reading Level dBuV	Correct Factor dB	Measure- ment dBuV/m	Limit dBuV/m	Over dB	Detector	Comment
1	X	2480.000	65.82	32.07	97.89	74.00	23.89	peak	
2	*	2480.000	54.82	32.07	86.89	54.00	32.89	AVG	
3		2483.500	28.28	32.09	60.37	74.00	-13.63	peak	
4		2483.500	16.21	32.09	48.30	54.00	-5.70	AVG	



Neutron Engineering Inc.

EUT	BOOM BOOM !	Model Name	BOOM BOOM !
Temperature	25°C	Relative Humidity	62%
Test Voltage	AC 120V/60Hz		
Test Mode	Bluetooth/1 Mbps/2480 MHz		

Polarization: Horizontal

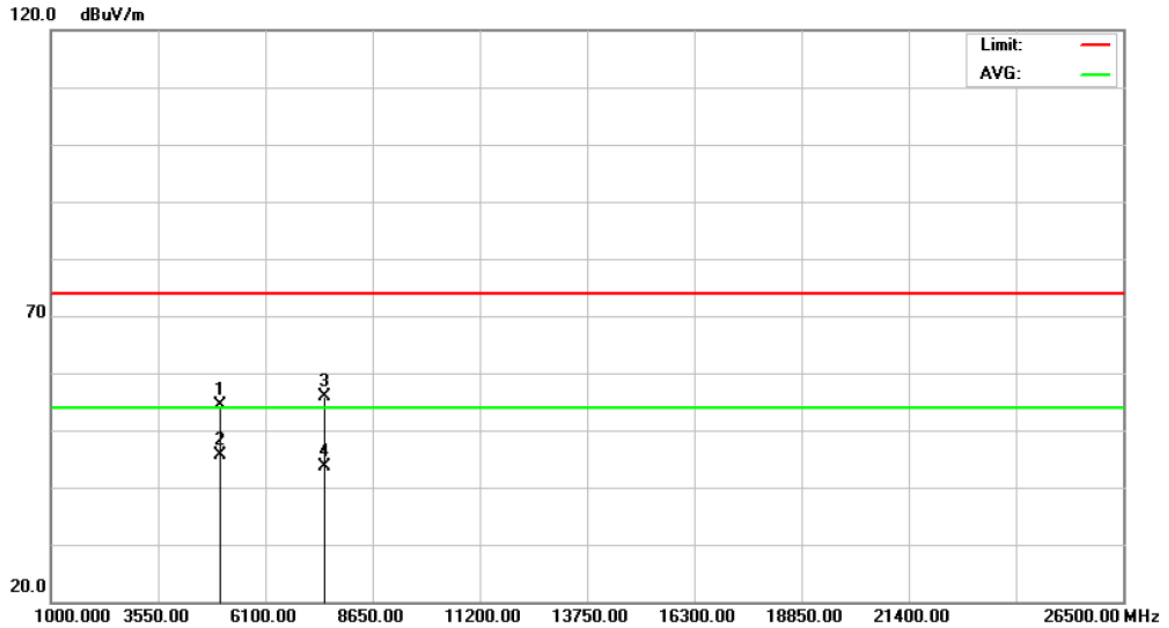

No. Mk.	Freq. MHz	Reading Level dBuV	Correct Factor dB	Measurement dBuV/m	Limit dBuV/m	Over dB	Detector	Comment
1	4959.945	48.60	5.89	54.49	74.00	-19.51	peak	
2 *	4959.945	39.71	5.89	45.60	54.00	-8.40	AVG	
3	7439.895	42.81	13.05	55.86	74.00	-18.14	peak	
4	7439.895	30.70	13.05	43.75	54.00	-10.25	AVG	



Neutron Engineering Inc.

EUT	BOOM BOOM !	Model Name	BOOM BOOM !
Temperature	25°C	Relative Humidity	62%
Test Voltage	AC 120V/60Hz		
Test Mode	Bluetooth/3 Mbps/2402 MHz		

Polarization: Vertical

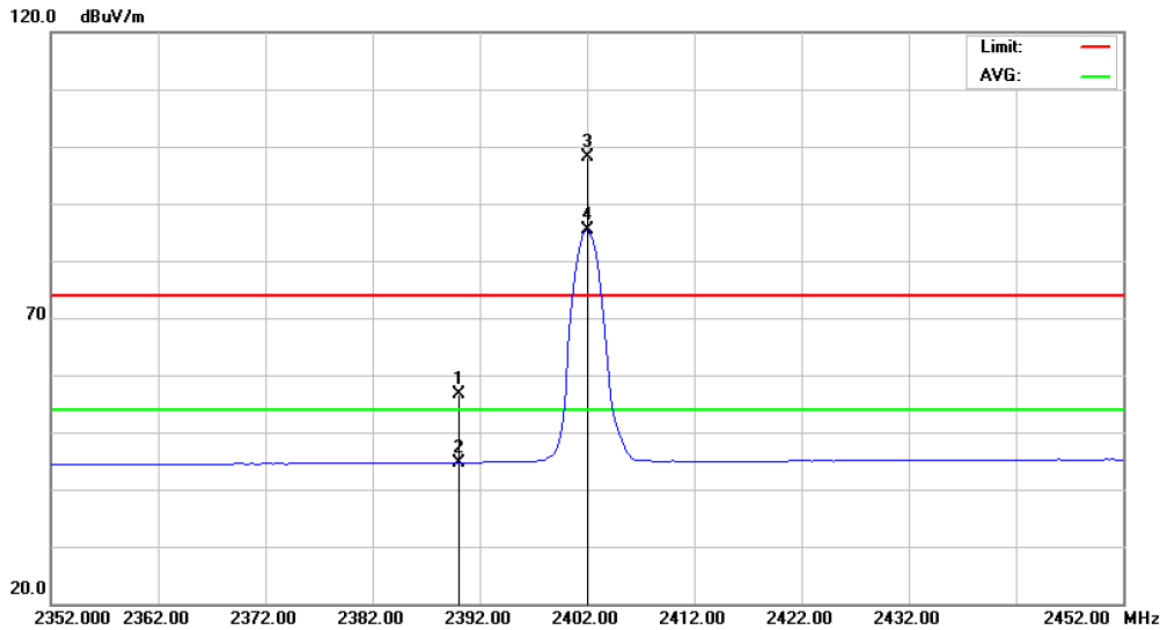

No.	Mk.	Freq. MHz	Reading Level dBuV	Correct Factor dB	Measure- ment dBuV/m	Limit dBuV/m	Over dB	Detector	Comment
1		2390.000	24.84	31.67	56.51	74.00	-17.49	peak	
2		2390.000	13.01	31.67	44.68	54.00	-9.32	AVG	
3	X	2402.000	66.42	31.72	98.14	74.00	24.14	peak	
4	*	2402.000	53.55	31.72	85.27	54.00	31.27	AVG	



Neutron Engineering Inc.

EUT	BOOM BOOM !	Model Name	BOOM BOOM !
Temperature	25°C	Relative Humidity	62%
Test Voltage	AC 120V/60Hz		
Test Mode	Bluetooth/3 Mbps/2402 MHz		

Polarization: Vertical

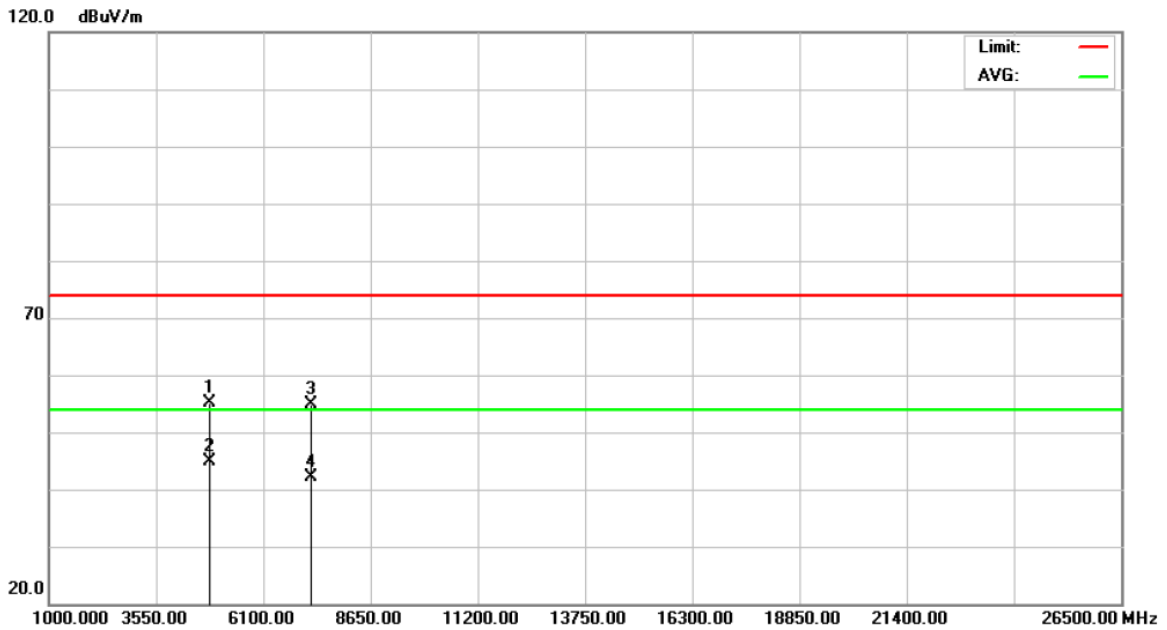

No. Mk.	Freq. MHz	Reading Level dBuV	Correct Factor dB	Measurement dBuV/m	Limit dBuV/m	Over dB	Detector	Comment
1	4804.040	49.38	5.69	55.07	74.00	-18.93	peak	
2 *	4804.040	39.31	5.69	45.00	54.00	-9.00	AVG	
3	7206.335	42.76	12.18	54.94	74.00	-19.06	peak	
4	7206.335	29.84	12.18	42.02	54.00	-11.98	AVG	



Neutron Engineering Inc.

EUT	BOOM BOOM !	Model Name	BOOM BOOM !
Temperature	25°C	Relative Humidity	62%
Test Voltage	AC 120V/60Hz		
Test Mode	Bluetooth/3 Mbps/2402 MHz		

Polarization: Horizontal

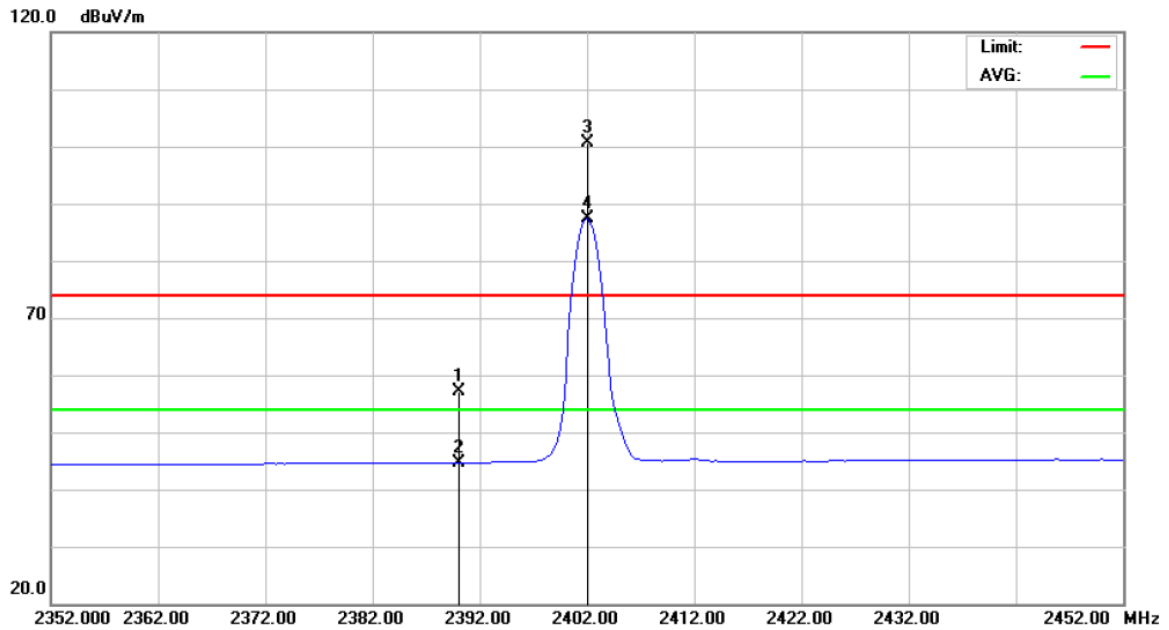

No.	Mk.	Freq. MHz	Reading Level dBuV	Correct Factor dB	Measure- ment dBuV/m	Limit dBuV/m	Over dB	Detector	Comment
1		2390.000	25.48	31.67	57.15	74.00	-16.85	peak	
2		2390.000	13.02	31.67	44.69	54.00	-9.31	AVG	
3	X	2402.000	68.99	31.72	100.71	74.00	26.71	peak	
4	*	2402.000	55.58	31.72	87.30	54.00	33.30	AVG	



Neutron Engineering Inc.

EUT	BOOM BOOM !	Model Name	BOOM BOOM !
Temperature	25°C	Relative Humidity	62%
Test Voltage	AC 120V/60Hz		
Test Mode	Bluetooth/3 Mbps/2402 MHz		

Polarization: Horizontal

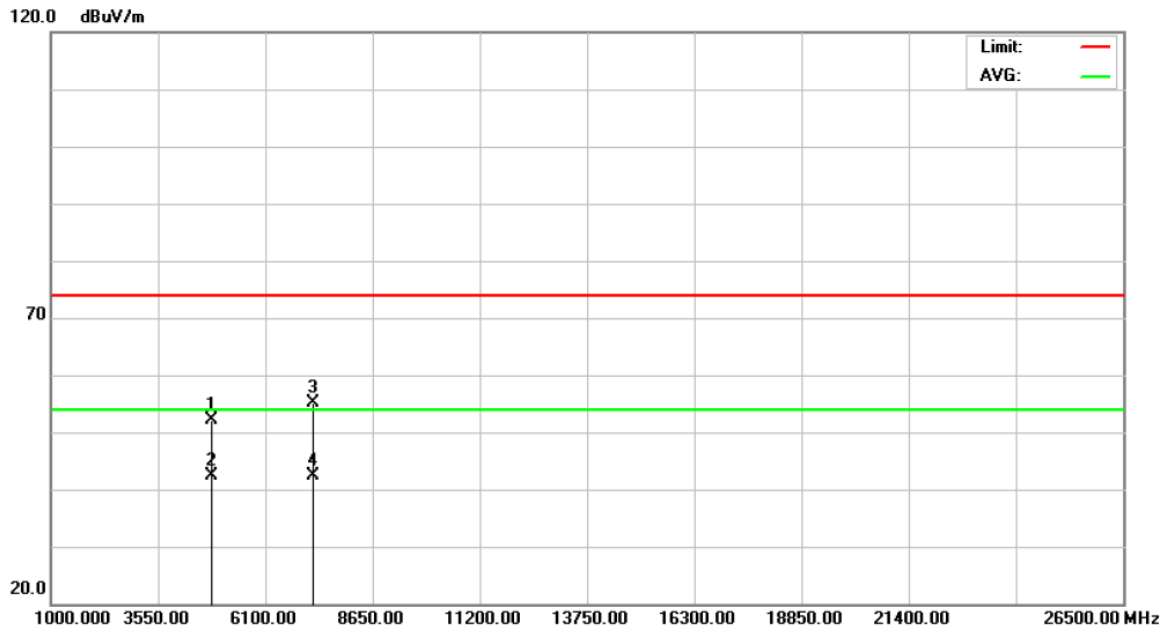

No. Mk.	Freq. MHz	Reading Level dBuV	Correct Factor dB	Measurement dBuV/m	Limit dBuV/m	Over dB	Detector	Comment
1	4803.975	46.34	5.69	52.03	74.00	-21.97	peak	
2 *	4803.975	36.61	5.69	42.30	54.00	-11.70	AVG	
3	7206.090	42.84	12.18	55.02	74.00	-18.98	peak	
4	7206.090	30.10	12.18	42.28	54.00	-11.72	AVG	



Neutron Engineering Inc.

EUT	BOOM BOOM !	Model Name	BOOM BOOM !
Temperature	25°C	Relative Humidity	62%
Test Voltage	AC 120V/60Hz		
Test Mode	Bluetooth/3 Mbps/2441 MHz		

Polarization: Vertical

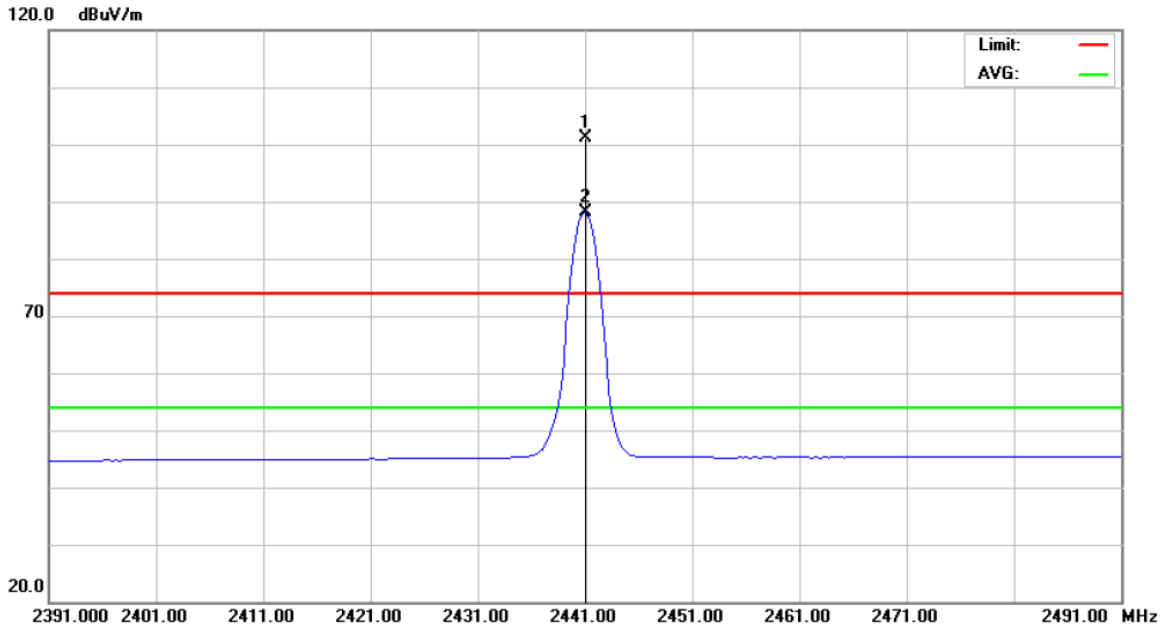

No.	Mk.	Freq.	Reading Level	Correct Factor	Measurement	Limit	Over	Detector	Comment
		MHz	dBuV	dB	dBuV/m	dBuV/m	dB		
1	X	2441.000	69.11	31.90	101.01	74.00	27.01	peak	
2	*	2441.000	56.12	31.90	88.02	54.00	34.02	AVG	



Neutron Engineering Inc.

EUT	BOOM BOOM !	Model Name	BOOM BOOM !
Temperature	25°C	Relative Humidity	62%
Test Voltage	AC 120V/60Hz		
Test Mode	Bluetooth/3 Mbps/2441 MHz		

Polarization: Vertical

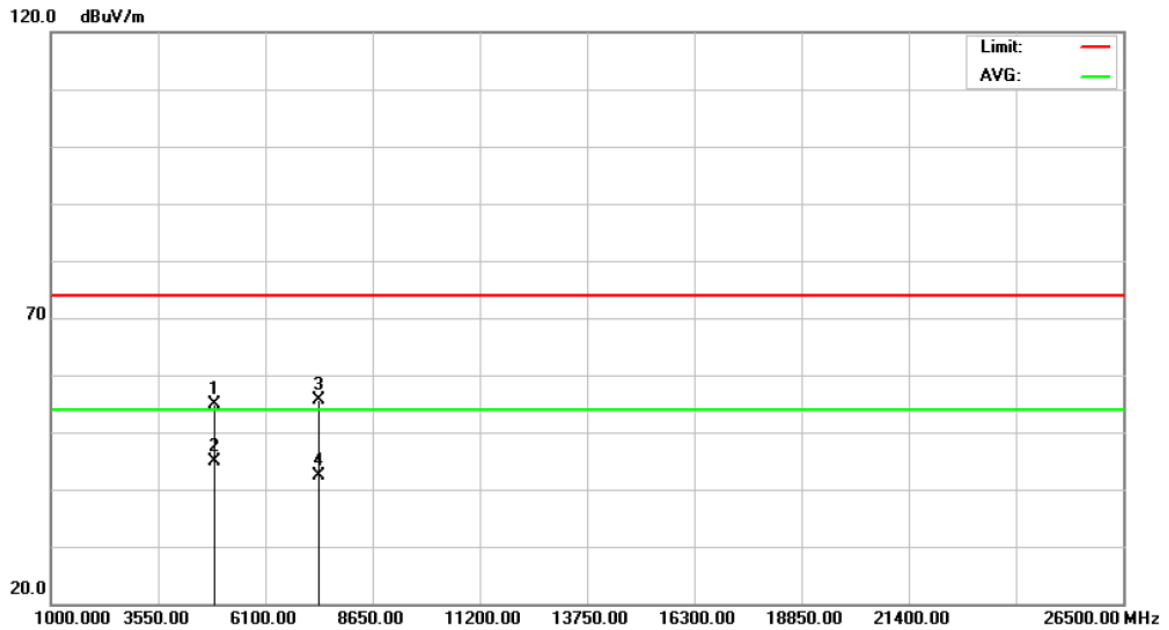

No. Mk.	Freq. MHz	Reading Level dBuV	Correct Factor dB	Measurement dBuV/m	Limit dBuV/m	Over dB	Detector	Comment
1	4881.965	49.04	5.79	54.83	74.00	-19.17	peak	
2 *	4881.965	39.02	5.79	44.81	54.00	-9.19	AVG	
3	7323.225	43.02	12.61	55.63	74.00	-18.37	peak	
4	7323.225	29.78	12.61	42.39	54.00	-11.61	AVG	



Neutron Engineering Inc.

EUT	BOOM BOOM !	Model Name	BOOM BOOM !
Temperature	25°C	Relative Humidity	62%
Test Voltage	AC 120V/60Hz		
Test Mode	Bluetooth/3 Mbps/2441 MHz		

Polarization: Horizontal

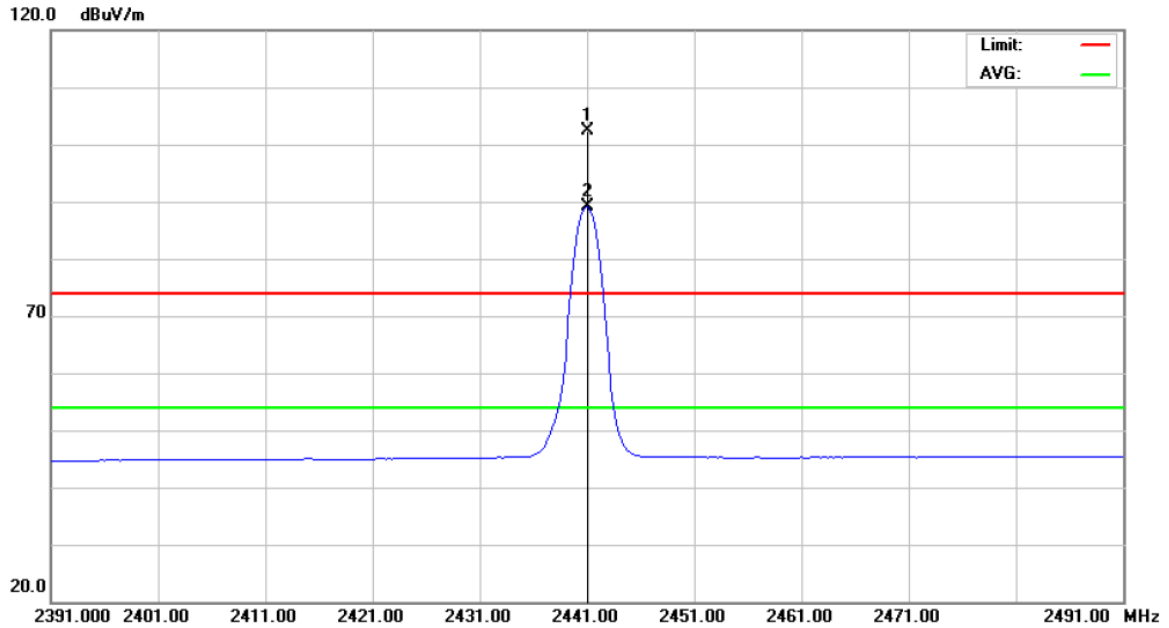

No.	Mk.	Freq. MHz	Reading Level dBuV	Correct Factor dB	Measure- ment dBuV/m	Limit dBuV/m	Over dB	Detector	Comment
1	X	2441.000	70.49	31.90	102.39	74.00	28.39	peak	
2	*	2441.000	57.19	31.90	89.09	54.00	35.09	AVG	



Neutron Engineering Inc.

EUT	BOOM BOOM !	Model Name	BOOM BOOM !
Temperature	25°C	Relative Humidity	62%
Test Voltage	AC 120V/60Hz		
Test Mode	Bluetooth/3 Mbps/2441 MHz		

Polarization: Horizontal

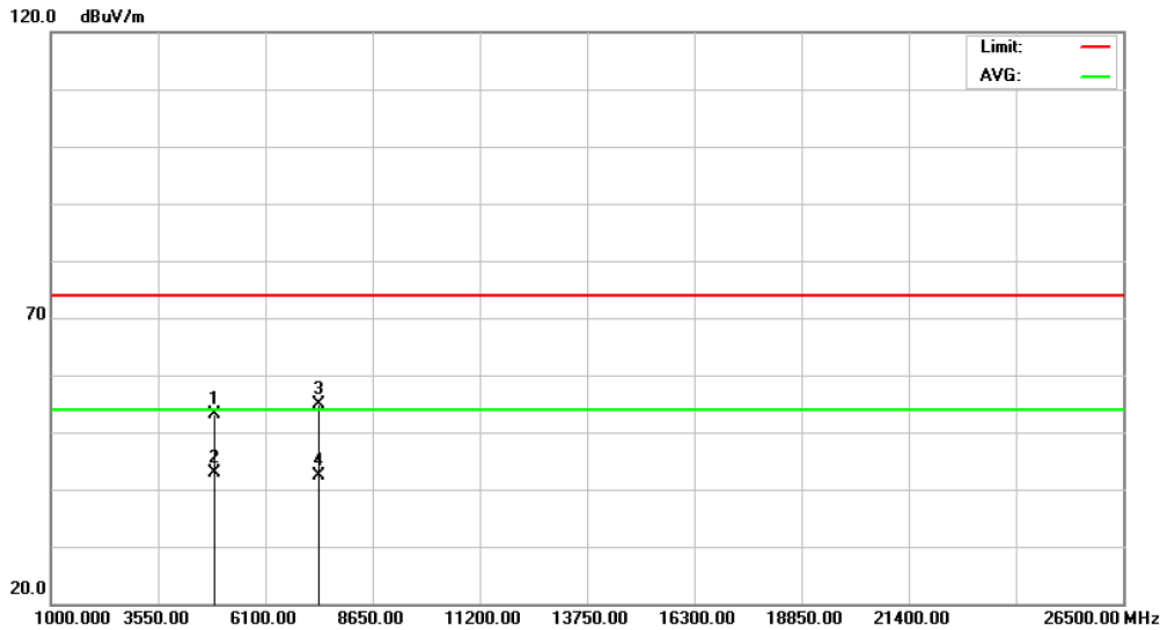

No. Mk.	Freq. MHz	Reading Level dBuV	Correct Factor dB	Measurement dBuV/m	Limit dBuV/m	Over dB	Detector	Comment
1	4881.870	47.32	5.79	53.11	74.00	-20.89	peak	
2 *	4881.870	36.97	5.79	42.76	54.00	-11.24	AVG	
3	7323.130	42.35	12.61	54.96	74.00	-19.04	peak	
4	7323.130	29.82	12.61	42.43	54.00	-11.57	AVG	



Neutron Engineering Inc.

EUT	BOOM BOOM !	Model Name	BOOM BOOM !
Temperature	25°C	Relative Humidity	62%
Test Voltage	AC 120V/60Hz		
Test Mode	Bluetooth/3 Mbps/2480 MHz		

Polarization: Vertical

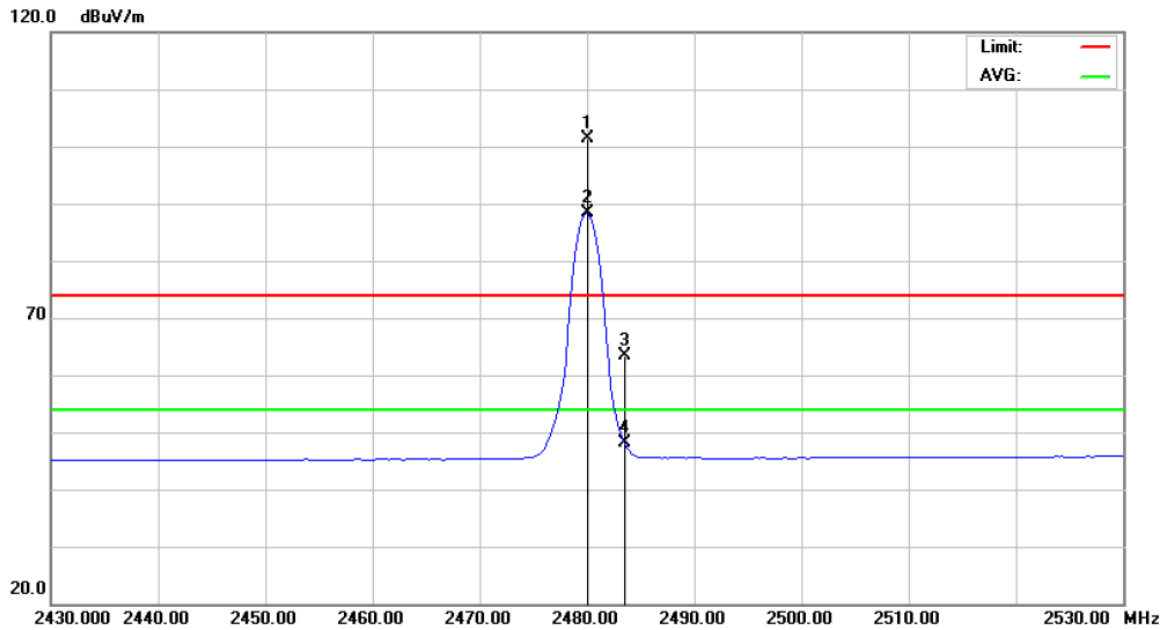

No.	Mk.	Freq. MHz	Reading Level dBuV	Correct Factor dB	Measure- ment dBuV/m	Limit dBuV/m	Over dB	Detector	Comment
1	X	2480.000	69.41	32.07	101.48	74.00	27.48	peak	
2	*	2480.000	56.31	32.07	88.38	54.00	34.38	AVG	
3		2483.500	31.39	32.09	63.48	74.00	-10.52	peak	
4		2483.500	15.96	32.09	48.05	54.00	-5.95	AVG	



Neutron Engineering Inc.

EUT	BOOM BOOM !	Model Name	BOOM BOOM !
Temperature	25°C	Relative Humidity	62%
Test Voltage	AC 120V/60Hz		
Test Mode	Bluetooth/3 Mbps/2480 MHz		

Polarization: Vertical

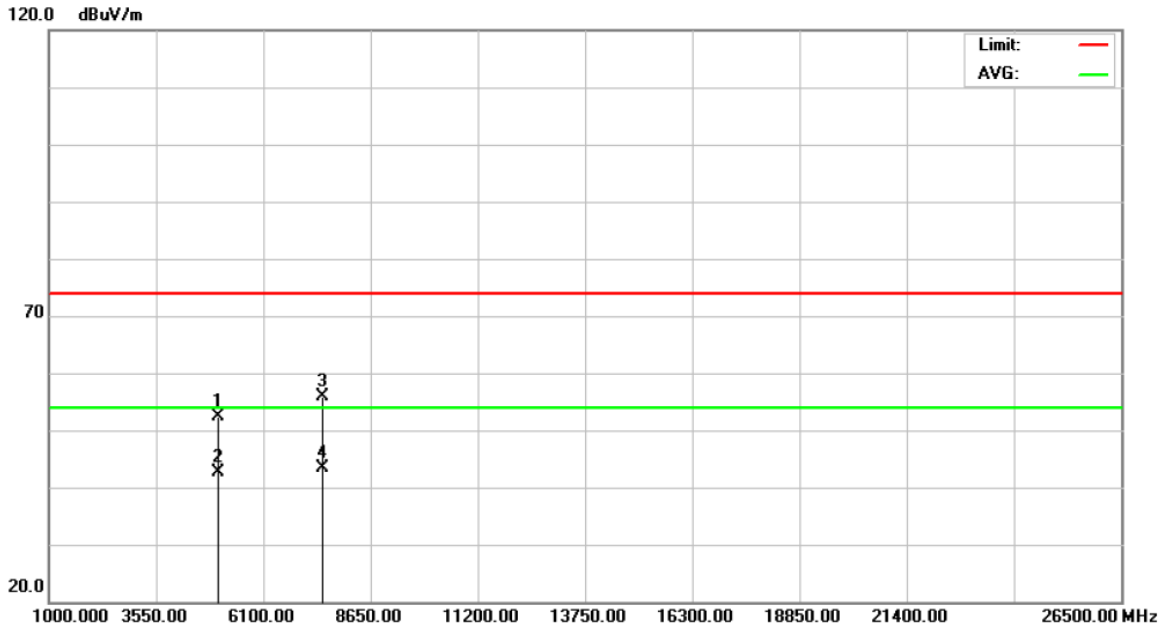

No. Mk.	Freq. MHz	Reading Level dBuV	Correct Factor dB	Measurement dBuV/m	Limit dBuV/m	Over dB	Detector	Comment
1	4959.930	46.38	5.89	52.27	74.00	-21.73	peak	
2	4959.930	36.75	5.89	42.64	54.00	-11.36	AVG	
3	7440.040	42.77	13.05	55.82	74.00	-18.18	peak	
4 *	7440.040	30.24	13.05	43.29	54.00	-10.71	AVG	



Neutron Engineering Inc.

EUT	BOOM BOOM !	Model Name	BOOM BOOM !
Temperature	25°C	Relative Humidity	62%
Test Voltage	AC 120V/60Hz		
Test Mode	Bluetooth/3 Mbps/2480 MHz		

Polarization: Horizontal

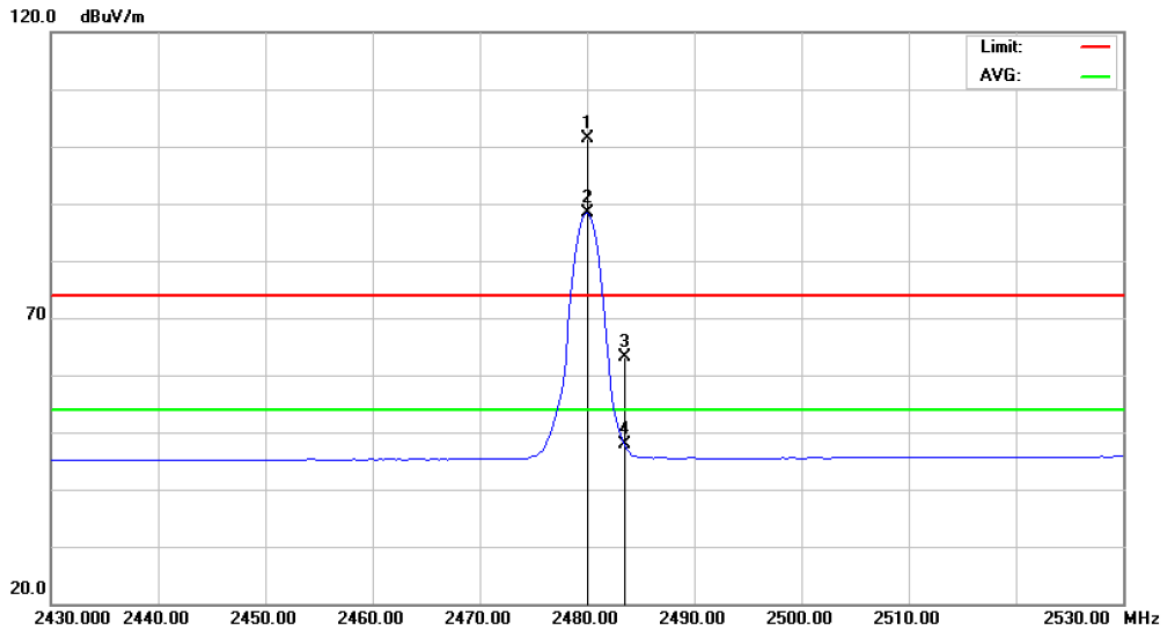

No.	Mk.	Freq. MHz	Reading Level dBuV	Correct Factor dB	Measure- ment dBuV/m	Limit dBuV/m	Over dB	Detector	Comment
1	X	2480.000	69.22	32.07	101.29	74.00	27.29	peak	
2	*	2480.000	56.26	32.07	88.33	54.00	34.33	AVG	
3		2483.500	30.97	32.09	63.06	74.00	-10.94	peak	
4		2483.500	15.75	32.09	47.84	54.00	-6.16	AVG	



Neutron Engineering Inc.

EUT	BOOM BOOM !	Model Name	BOOM BOOM !
Temperature	25°C	Relative Humidity	62%
Test Voltage	AC 120V/60Hz		
Test Mode	Bluetooth/3 Mbps/2480 MHz		

Polarization: Horizontal

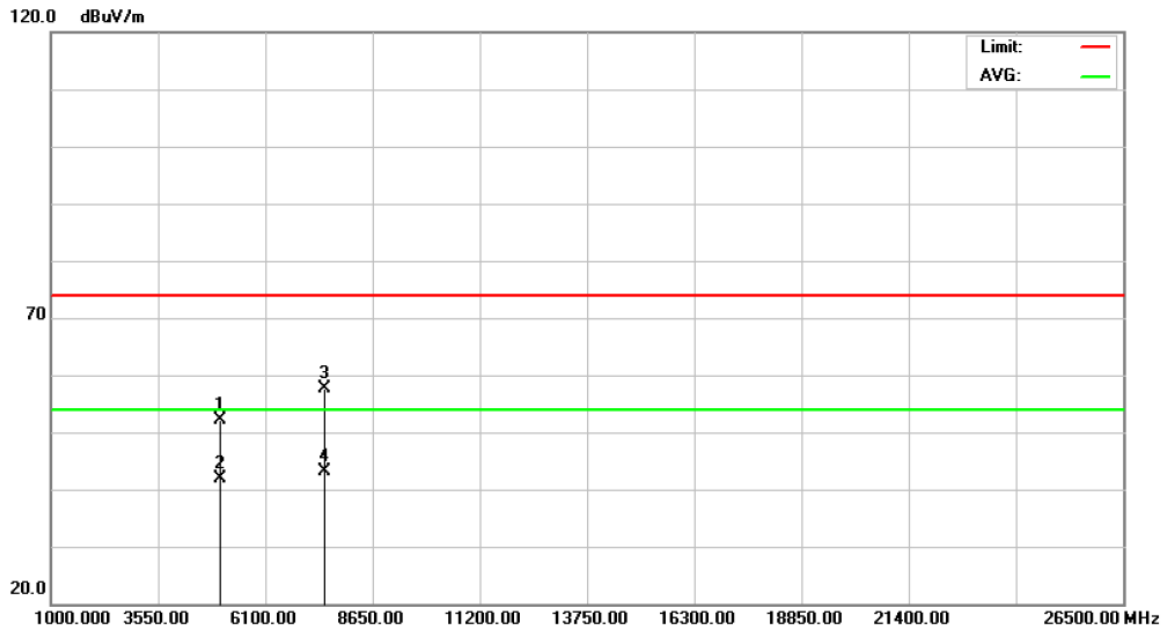

No. Mk.	Freq. MHz	Reading Level dBuV	Correct Factor dB	Measurement dBuV/m	Limit dBuV/m	Over dB	Detector	Comment
1	4959.945	46.27	5.89	52.16	74.00	-21.84	peak	
2	4959.945	35.97	5.89	41.86	54.00	-12.14	AVG	
3	7439.895	44.49	13.05	57.54	74.00	-16.46	peak	
4 *	7439.895	30.08	13.05	43.13	54.00	-10.87	AVG	



Neutron Engineering Inc.

9.9 TEST RESULTS (RESTRICTED BANDS)

EUT	BOOM BOOM !	Model Name	BOOM BOOM !
Temperature	24°C	Relative Humidity	46%
Test Voltage	AC 120V/60Hz		
Test Mode	Bluetooth/1 Mbps/2402 MHz		
NOTE	The transmitter was setup to transmit at the lowest channel and the field strength was measured at 2310-2390 MHz.		

Polarization: Vertical

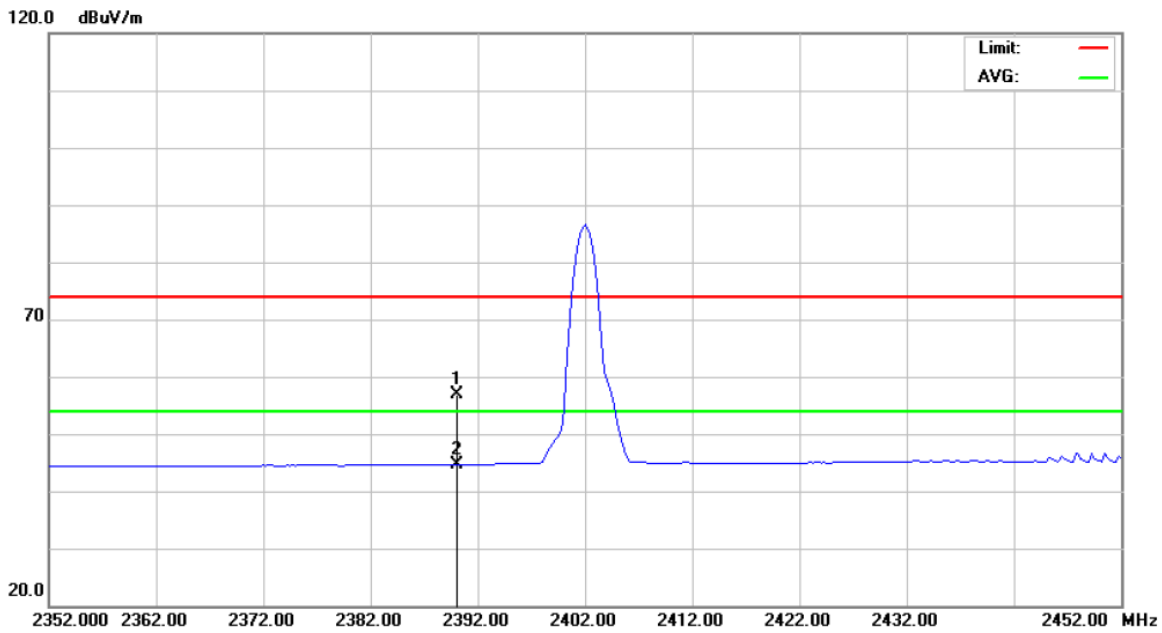

No. Mk.	Freq. MHz	Reading Level dBuV	Correct Factor dB	Measurement dBuV/m	Limit dBuV/m	Over dB	Detector	Comment
1	2390.000	25.27	31.67	56.94	74.00	-17.06	peak	
2 *	2390.000	12.96	31.67	44.63	54.00	-9.37	AVG	



Neutron Engineering Inc.

EUT	BOOM BOOM !	Model Name	BOOM BOOM !
Temperature	24°C	Relative Humidity	46%
Test Voltage	AC 120V/60Hz		
Test Mode	Bluetooth/1 Mbps/2480 MHz		
NOTE	The transmitter was setup to transmit at the highest channel and the field strength was measured at 2483.5-2500 MHz.		

Polarization: Vertical

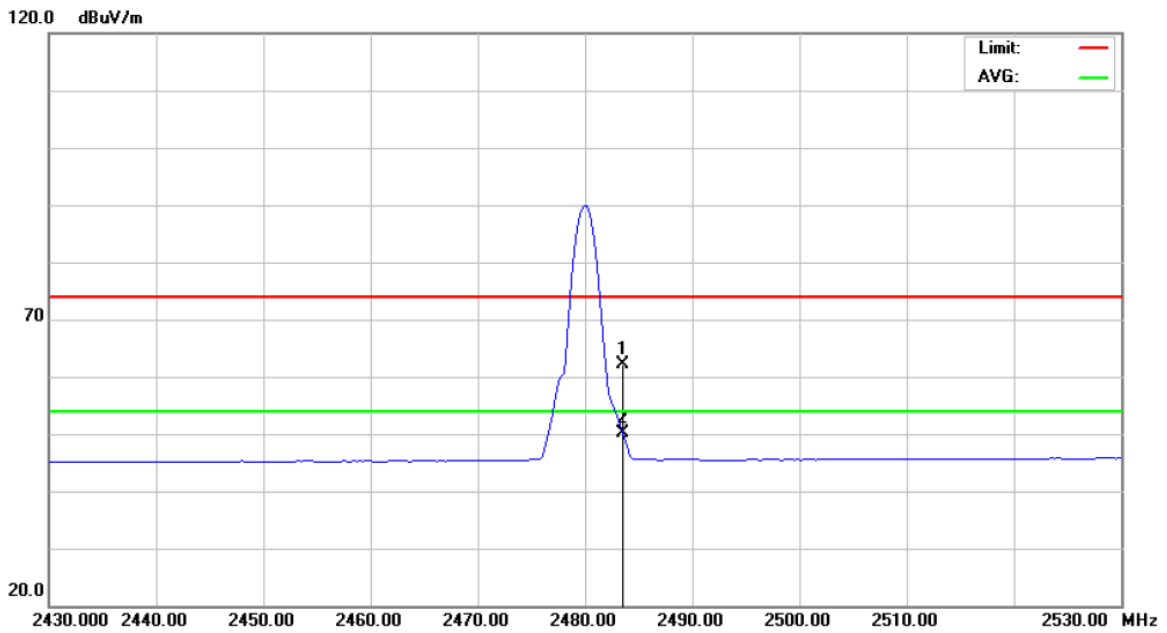

No. Mk.	Freq. MHz	Reading Level dBuV	Correct Factor dB	Measurement dBuV/m	Limit dBuV/m	Over dB	Detector	Comment
1	2483.500	30.02	32.09	62.11	74.00	-11.89	peak	
2 *	2483.500	18.13	32.09	50.22	54.00	-3.78	AVG	



Neutron Engineering Inc.

EUT	BOOM BOOM !	Model Name	BOOM BOOM !
Temperature	24°C	Relative Humidity	46%
Test Voltage	AC 120V/60Hz		
Test Mode	Bluetooth/1 Mbps/2402 MHz		
NOTE	The transmitter was setup to transmit at the lowest channel and the field strength was measured at 2310-2390 MHz.		

Polarization: Horizontal

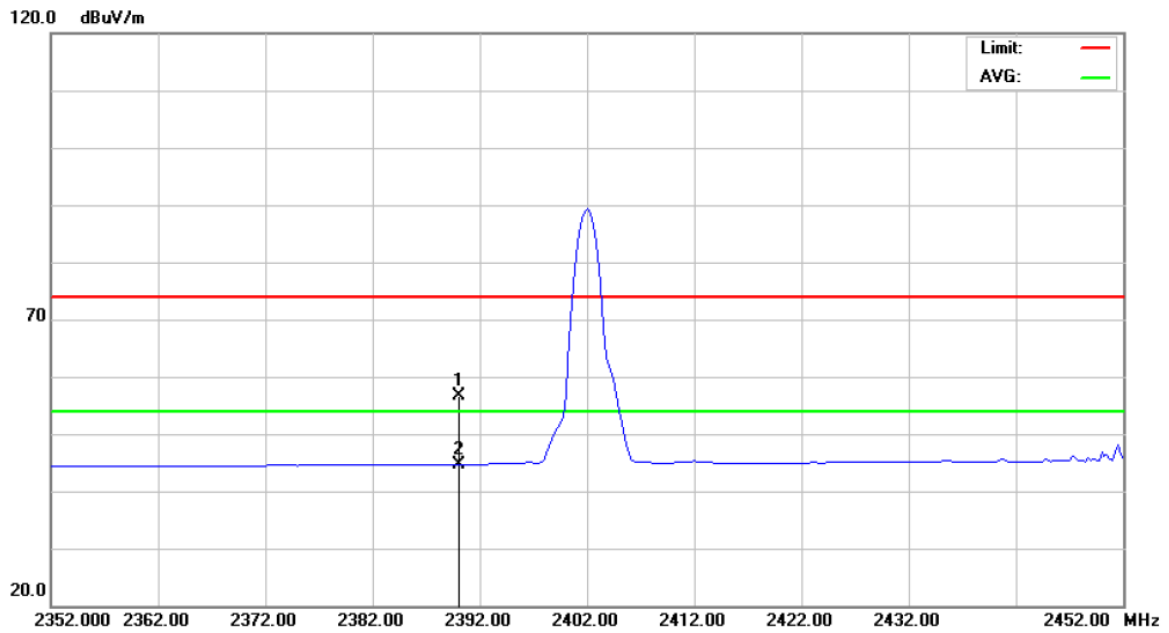

No. Mk.	Freq. MHz	Reading Level dBuV	Correct Factor dB	Measurement dBuV/m	Limit dBuV/m	Over dB	Detector	Comment
1	2390.000	24.99	31.67	56.66	74.00	-17.34	peak	
2 *	2390.000	13.00	31.67	44.67	54.00	-9.33	AVG	



Neutron Engineering Inc.

EUT	BOOM BOOM !	Model Name	BOOM BOOM !
Temperature	24°C	Relative Humidity	46%
Test Voltage	AC 120V/60Hz		
Test Mode	Bluetooth/1 Mbps/2480 MHz		
NOTE	The transmitter was setup to transmit at the highest channel and the field strength was measured at 2483.5-2500 MHz.		

Polarization: Horizontal

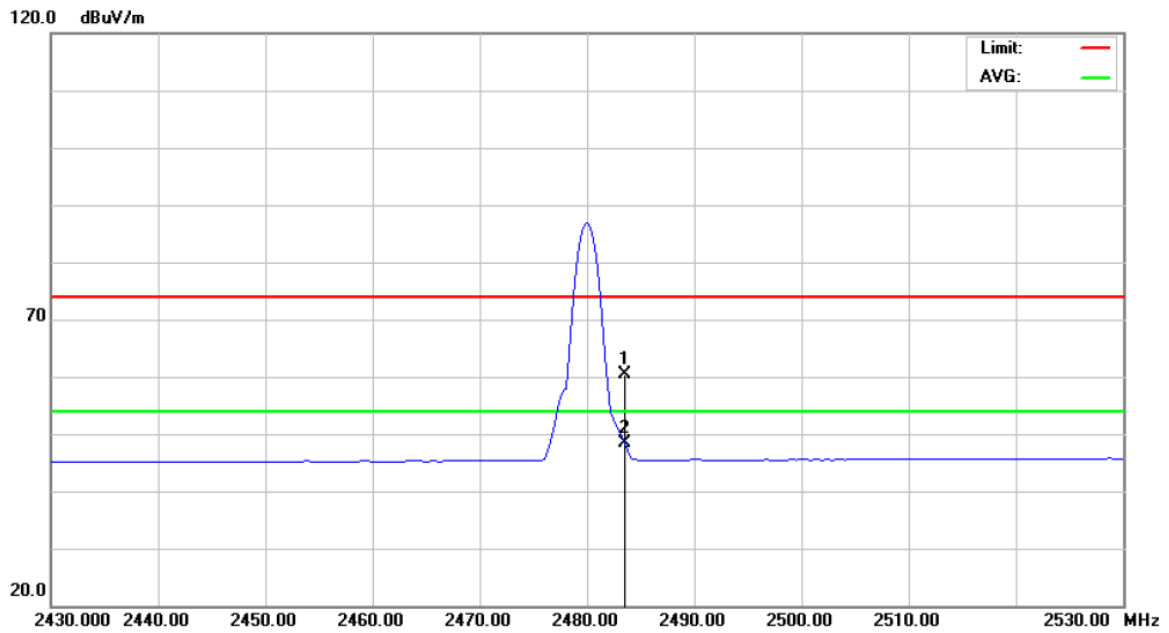

No. Mk.	Freq. MHz	Reading Level dBuV	Correct Factor dB	Measurement dBuV/m	Limit dBuV/m	Over dB	Detector	Comment
1	2483.500	28.28	32.09	60.37	74.00	-13.63	peak	
2 *	2483.500	16.21	32.09	48.30	54.00	-5.70	AVG	



Neutron Engineering Inc.

EUT	BOOM BOOM !	Model Name	BOOM BOOM !
Temperature	24°C	Relative Humidity	46%
Test Voltage	AC 120V/60Hz		
Test Mode	Bluetooth/3 Mbps/2402 MHz		
NOTE	The transmitter was setup to transmit at the lowest channel and the field strength was measured at 2310-2390 MHz.		

Polarization: Vertical

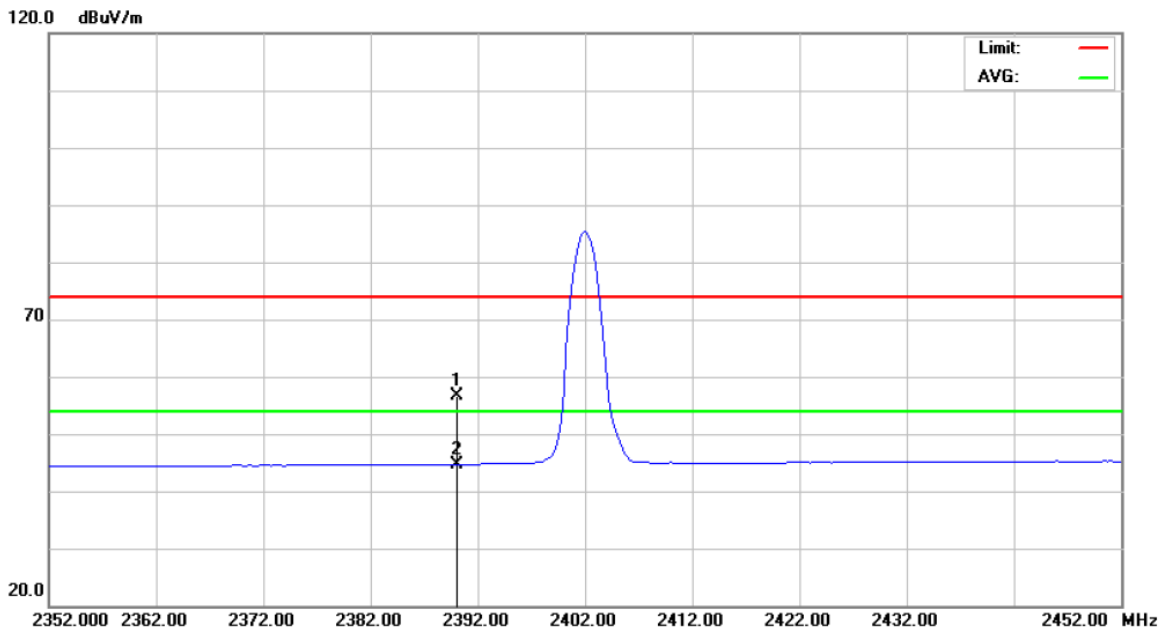

No. Mk.	Freq. MHz	Reading Level dBuV	Correct Factor dB	Measurement dBuV/m	Limit dBuV/m	Over dB	Detector	Comment
1	2390.000	24.84	31.67	56.51	74.00	-17.49	peak	
2 *	2390.000	13.01	31.67	44.68	54.00	-9.32	AVG	



Neutron Engineering Inc.

EUT	BOOM BOOM !	Model Name	BOOM BOOM !
Temperature	24°C	Relative Humidity	46%
Test Voltage	AC 120V/60Hz		
Test Mode	Bluetooth/3 Mbps/2480 MHz		
NOTE	The transmitter was setup to transmit at the highest channel and the field strength was measured at 2483.5-2500 MHz.		

Polarization: Vertical

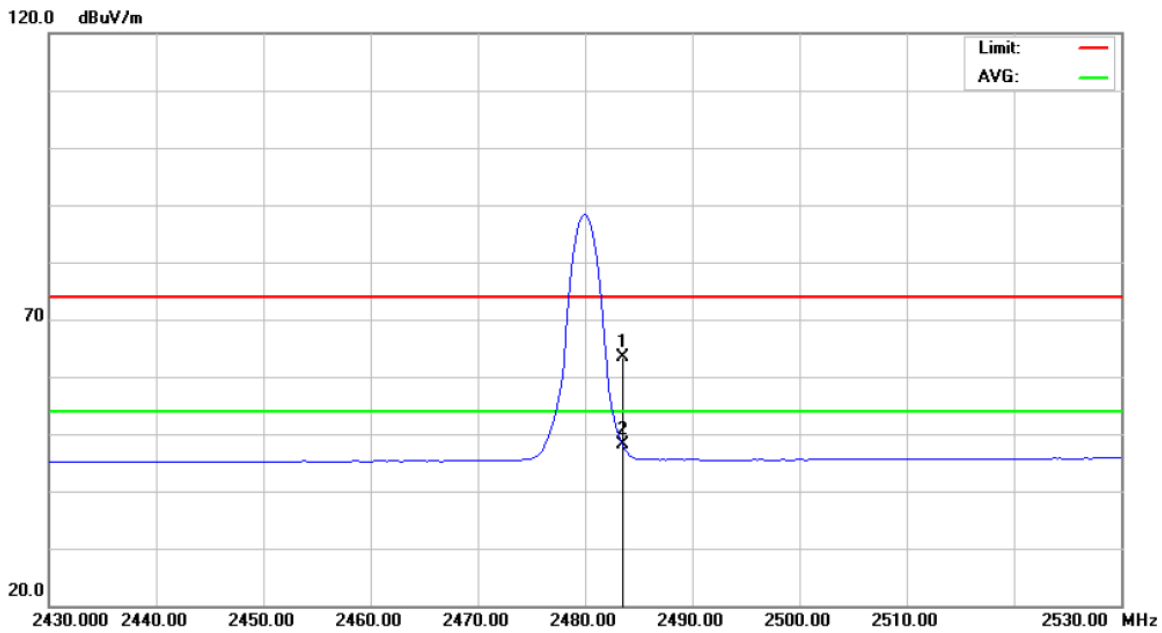

No. Mk.	Freq. MHz	Reading Level dBuV	Correct Factor dB	Measurement dBuV/m	Limit dBuV/m	Over dB	Detector	Comment
1	2483.500	31.39	32.09	63.48	74.00	-10.52	peak	
2 *	2483.500	15.96	32.09	48.05	54.00	-5.95	AVG	



Neutron Engineering Inc.

EUT	BOOM BOOM !	Model Name	BOOM BOOM !
Temperature	24°C	Relative Humidity	46%
Test Voltage	AC 120V/60Hz		
Test Mode	Bluetooth/3 Mbps/2402 MHz		
NOTE	The transmitter was setup to transmit at the lowest channel and the field strength was measured at 2310-2390 MHz.		

Polarization: Horizontal

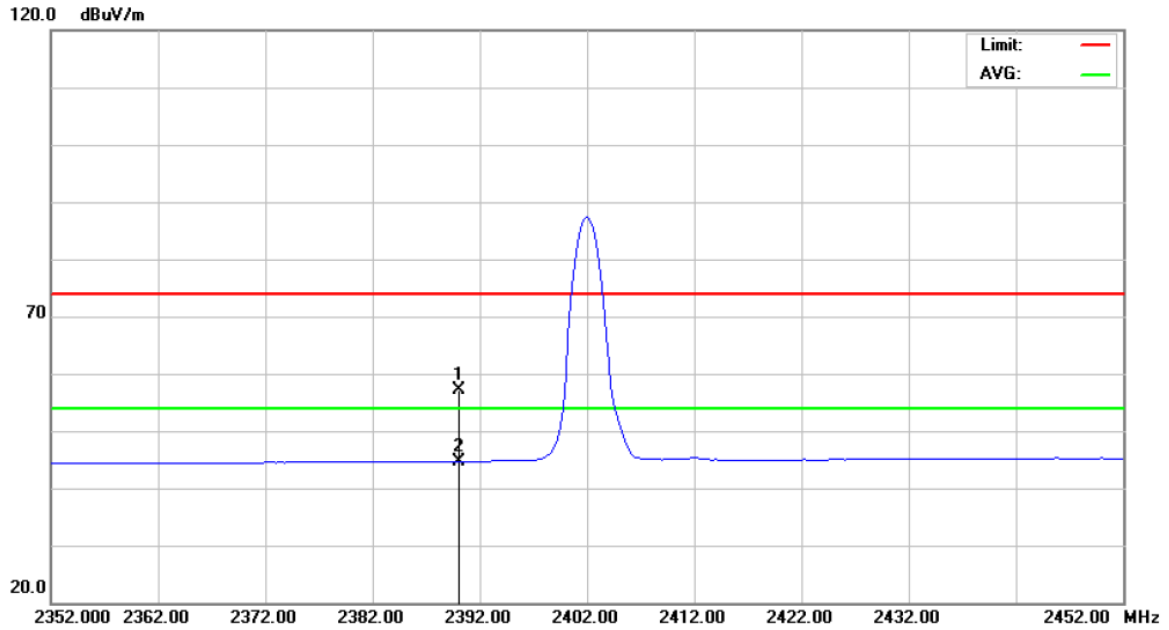

No. Mk.	Freq. MHz	Reading Level dBuV	Correct Factor dB	Measurement dBuV/m	Limit dBuV/m	Over dB	Detector	Comment
1	2390.000	25.48	31.67	57.15	74.00	-16.85	peak	
2 *	2390.000	13.02	31.67	44.69	54.00	-9.31	AVG	



Neutron Engineering Inc.

EUT	BOOM BOOM !	Model Name	BOOM BOOM !
Temperature	24°C	Relative Humidity	46%
Test Voltage	AC 120V/60Hz		
Test Mode	Bluetooth/3 Mbps/2480 MHz		
NOTE	The transmitter was setup to transmit at the highest channel and the field strength was measured at 2483.5-2500 MHz.		

Polarization: Horizontal

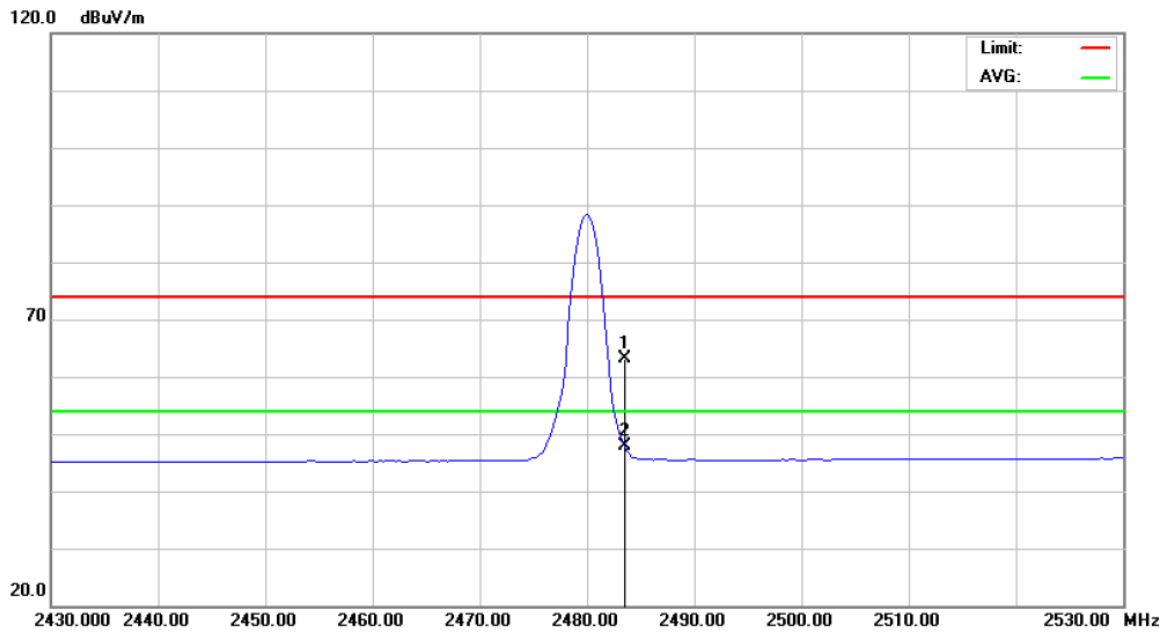

No. Mk.	Freq. MHz	Reading Level dBuV	Correct Factor dB	Measurement dBuV/m	Limit dBuV/m	Over dB	Detector	Comment
1	2483.500	30.97	32.09	63.06	74.00	-10.94	peak	
2 *	2483.500	15.75	32.09	47.84	54.00	-6.16	AVG	



Neutron Engineering Inc.

10 NUMBER OF HOPPING FREQUENCY

10.1 LIMIT

Test Item	Frequency Range (MHz)	Limit
Number of Hopping Channel	2400-2483.5	shall use at least 15 channels

10.2 MEASUREMENT INSTRUMENTS LIST

Item	Kind of Equipment	Manufacturer	Type No.	Serial No.	Calibrated until
1	Spectrum Analyzer	R&S	FSP-30	100854	Sep. 08, 2014

NOTE: **N/A**: denotes No Model Name, No Serial No. or No Calibration specified.

10.3 MEASURING INSTRUMENTS SETTING

Spectrum Analyzer	Parameter Setting
Attenuation	Auto
Span Frequency	> Operating Frequency Range
RB	100 kHz
VB	100 kHz
Detector	Peak
Trace	Max Hold
Sweep Time	Auto

10.4 TEST PROCEDURES

- a. The EUT was directly connected to the spectrum analyzer and antenna output port as show in the block diagram below.
- b. Spectrum Setting: RBW= 100 kHz, VBW=100 kHz, Sweep time = Auto.

10.5 TEST SETUP LAYOUT

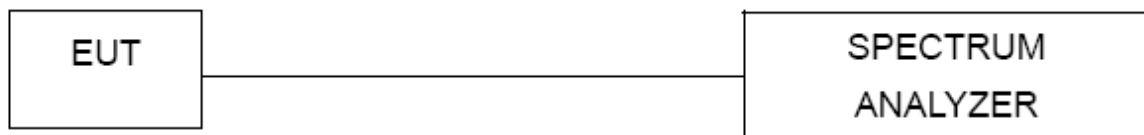

10.6 DEVIATION FROM TEST STANDARD

No deviation

10.7 EUT OPERATING CONDITIONS

The EUT tested system was configured as the statements of 5.6 Unless otherwise a special operating condition is specified in the follows during the testing.



Neutron Engineering Inc.

10.8 TEST RESULTS

EUT	BOOM BOOM !	Model Name	BOOM BOOM !
Temperature	25°C	Relative Humidity	62%
Test Voltage	AC 120V/60Hz		
Test Mode	Bluetooth/1 Mbps		

Number of Hopping Channel	Limit	Result
79	15	Pass

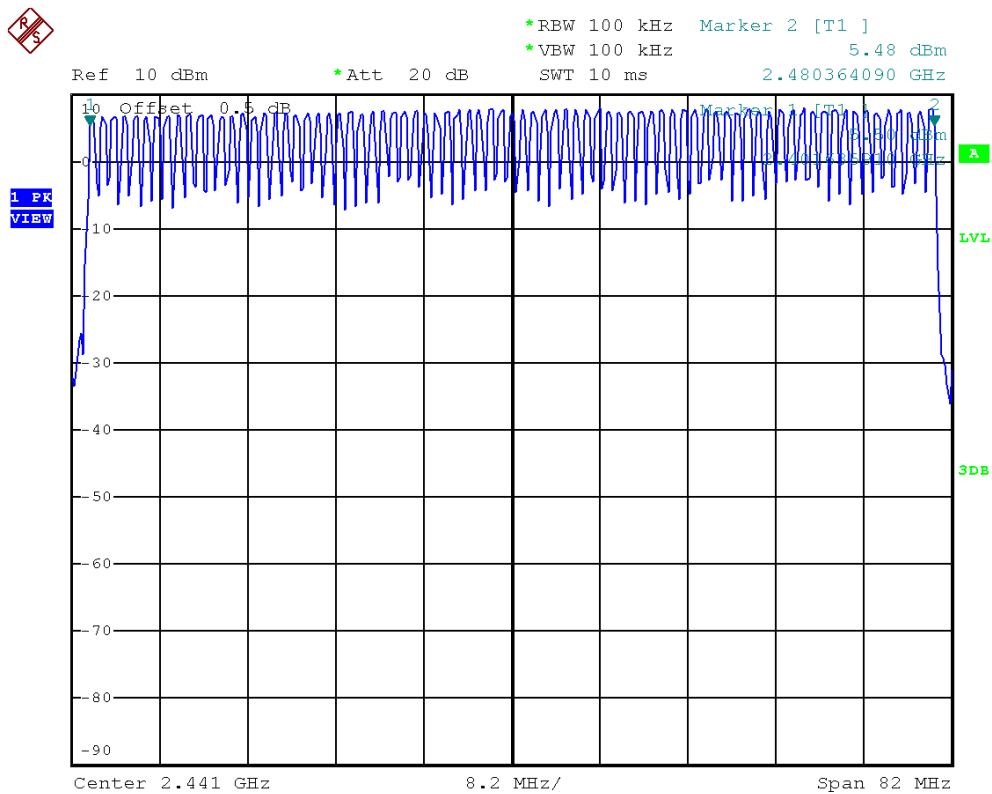



Neutron Engineering Inc.

EUT	BOOM BOOM !	Model Name	BOOM BOOM !
Temperature	25°C	Relative Humidity	62%
Test Voltage	AC 120V/60Hz		
Test Mode	Bluetooth/3 Mbps		

Number of Hopping Channel	Limit	Result
79	15	Pass

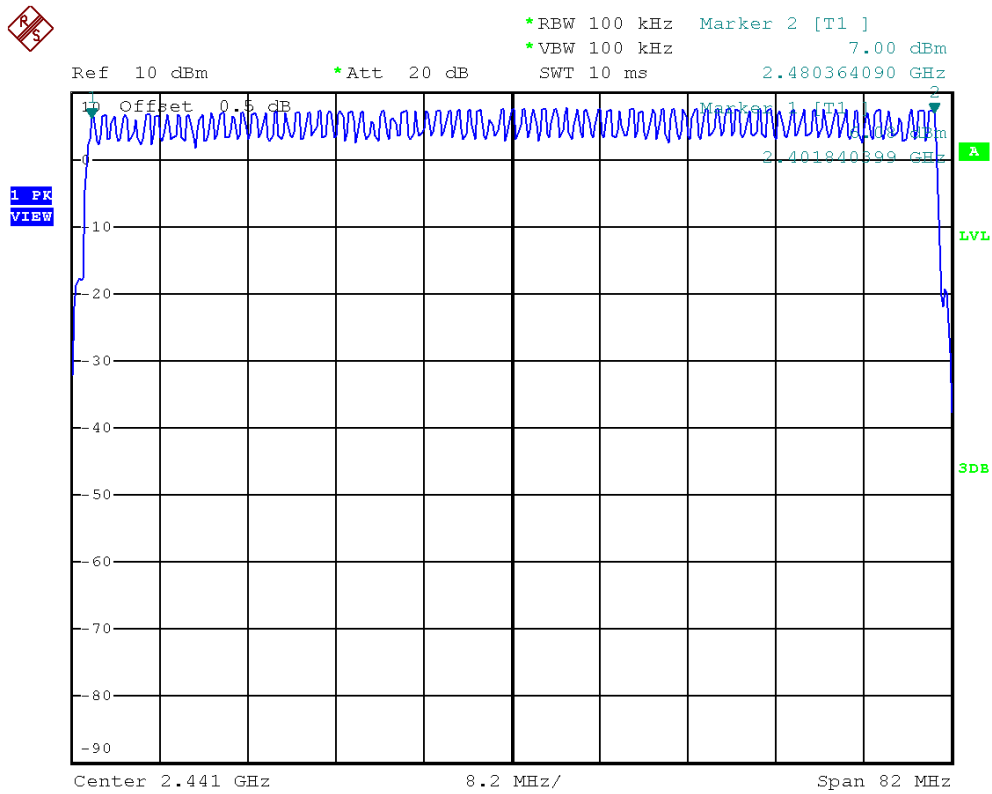



Neutron Engineering Inc.

11 AVERAGE TIME OF OCCUPANCY

11.1 LIMIT

Test Item	Frequency Range (MHz)	Limit
Average time of occupancy	2400-2483.5	shall not be greater than 0.4 seconds within a period of 0.4 seconds multiplied by the number of hopping channels employed.

11.2 MEASUREMENT INSTRUMENTS LIST

Item	Kind of Equipment	Manufacturer	Type No.	Serial No.	Calibrated until
1	Spectrum Analyzer	R&S	FSP-30	100854	Sep. 08, 2014

NOTE: **N/A**: denotes No Model Name, No Serial No. or No Calibration specified.

11.3 TEST PROCEDURES

- a. The transmitter output (antenna port) was connected to the spectrum analyzer
- b. Set RBW of spectrum analyzer to 100 kHz and VBW to 100 kHz.
- c. Use a video trigger with the trigger level set to enable triggering only on full pulses.
- d. Sweep Time is more than once pulse time.
- e. Set the center frequency on any frequency would be measure and set the frequency span to zero span.
- f. Measure the maximum time duration of one single pulse.
- g. Set the EUT for DH5, DH3 and DH1 packet transmitting.
- h. Measure the maximum time duration of one single pulse.
- i. DH5 Packet permit maximum $1600 / 79 / 6 = 3.37$ hops per second in each channel (5 time slots RX, 1 time slot TX). So, the dwell time is the time duration of the pulse times $3.37 \times 31.6 = 106.6$ within 31.6 seconds.
- j. DH3 Packet permit maximum $1600 / 79 / 4 = 5.06$ hops per second in each channel (3 time slots RX, 1 time slot TX). So, the dwell time is the time duration of the pulse times $5.06 \times 31.6 = 160$ within 31.6 seconds.
- k. DH1 Packet permit maximum $1600 / 79 / 2 = 10.12$ hops per second in each channel (1 time slot RX, 1 time slot TX). So, the dwell time is the time duration of the pulse times $10.12 \times 31.6 = 320$ within 31.6 seconds.

11.4 TEST SETUP LAYOUT



11.5 DEVIATION FROM TEST STANDARD

No deviation



Neutron Engineering Inc.

11.6 EUT OPERATING CONDITIONS

The EUT tested system was configured as the statements of 5.6 Unless otherwise a special operating condition is specified in the follows during the testing.



Neutron Engineering Inc.

11.7 TEST RESULTS

EUT	BOOM BOOM !	Model Name	BOOM BOOM !
Temperature	25°C	Relative Humidity	46%
Test Voltage	AC 120V/60Hz		
Test Mode	Bluetooth/1 Mbps/2402 MHz		

Data Packet	Frequency	Pulse Duration (ms)	Dwell Time (s)	Limit (s)	Result
DH5	2402 MHz	3.0869	0.3293	0.4	PASS
DH3	2402 MHz	1.7939	0.2870	0.4	PASS
DH1	2402 MHz	0.5224	0.1672	0.4	PASS

Bluetooth/1 Mbps/2402 MHz/DH5

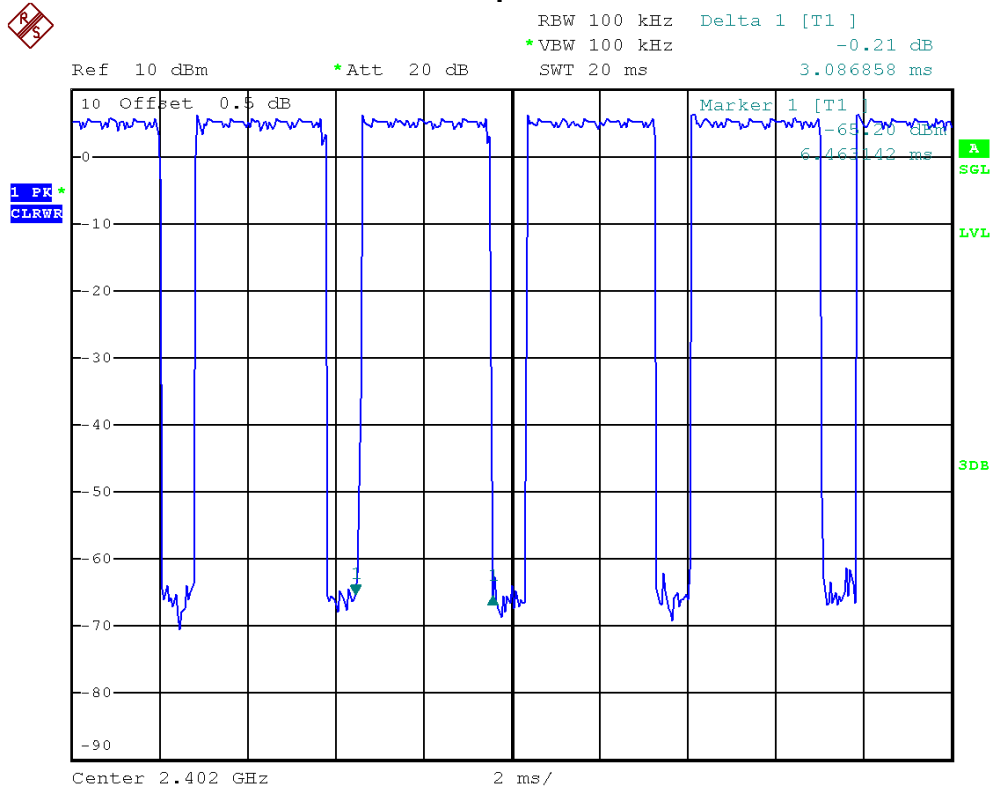



Neutron Engineering Inc.

Bluetooth/1 Mbps/2402 MHz/DH3

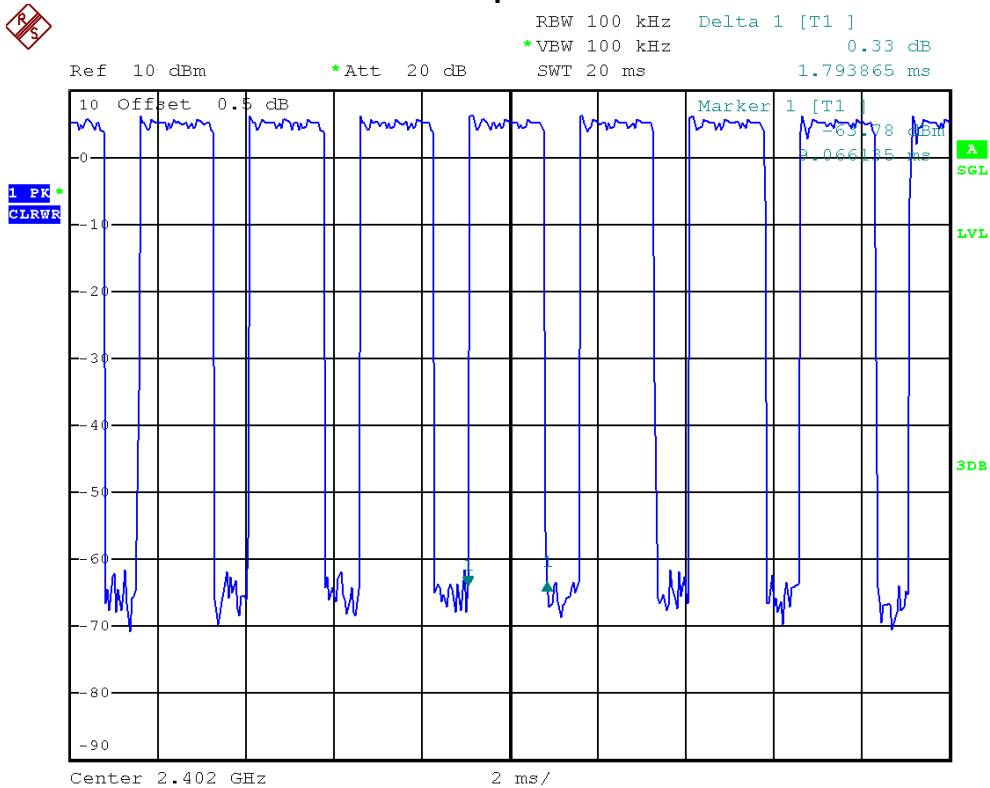

Bluetooth/1 Mbps/2402 MHz/DH1

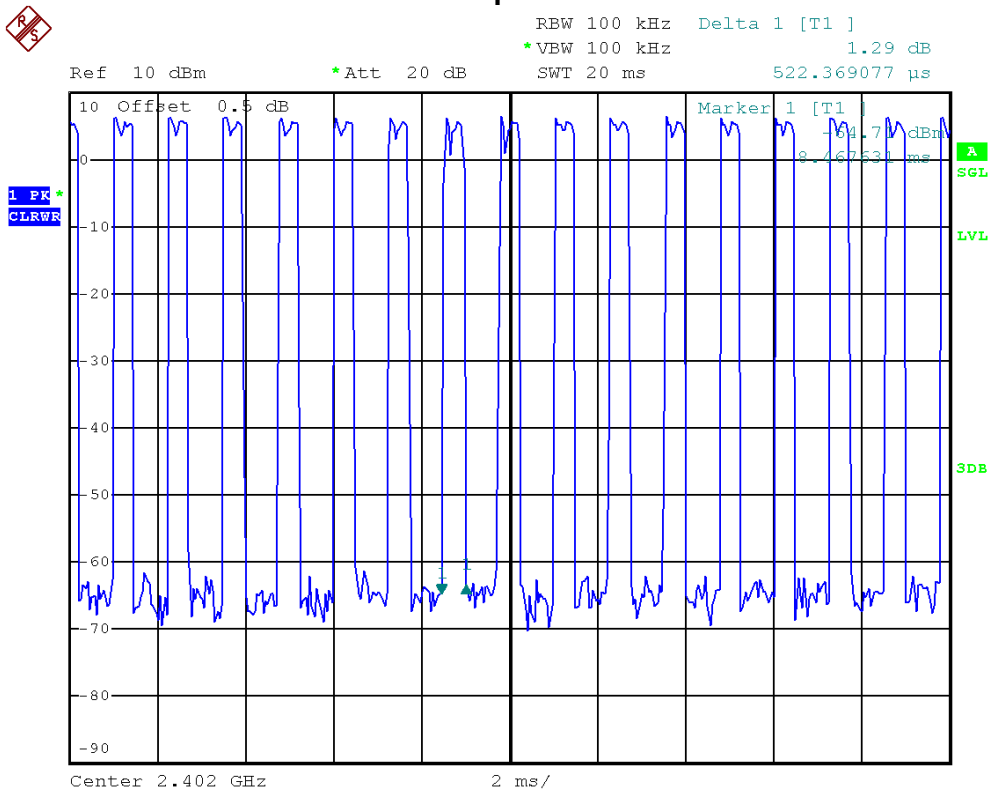



Neutron Engineering Inc.

EUT	BOOM BOOM !	Model Name	BOOM BOOM !
Temperature	25°C	Relative Humidity	46%
Test Voltage	AC 120V/60Hz		
Test Mode	Bluetooth/1 Mbps/2441 MHz		

Data Packet	Frequency	Pulse Duration (ms)	Dwell Time (s)	Limit (s)	Result
DH5	2441 MHz	2.9957	0.3195	0.4	PASS
DH3	2441 MHz	1.7942	0.2871	0.4	PASS
DH1	2441 MHz	0.5330	0.1706	0.4	PASS

Bluetooth/1 Mbps/2441 MHz/DH5

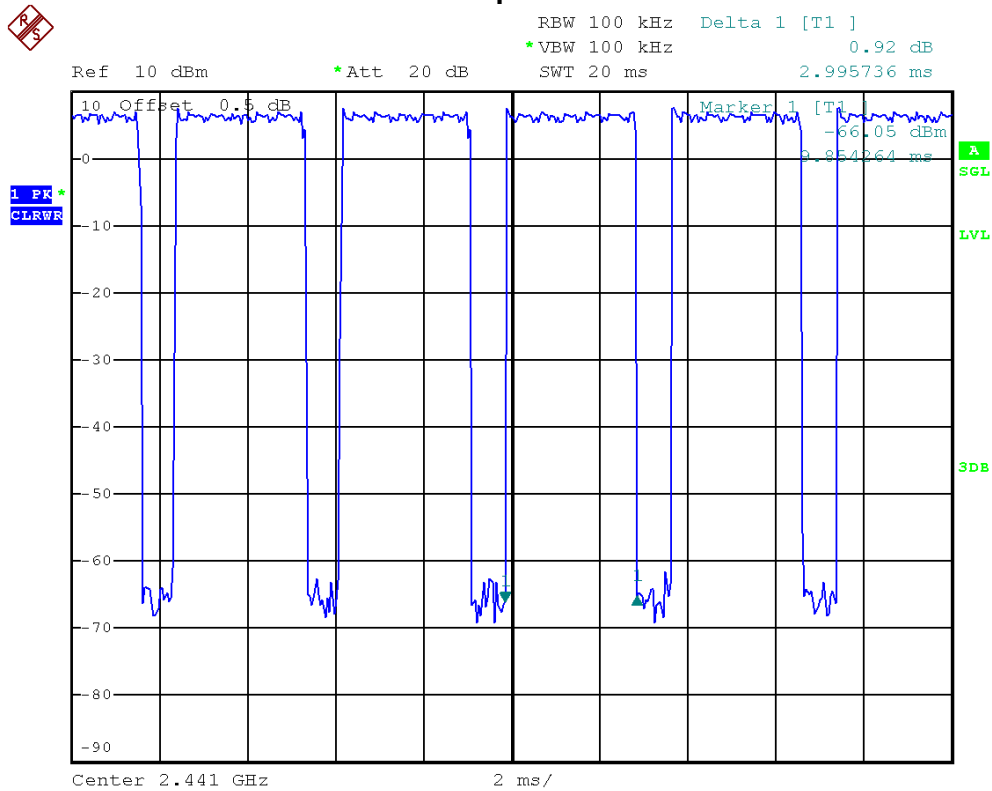



Neutron Engineering Inc.

Bluetooth/1 Mbps/2441 MHz/DH3

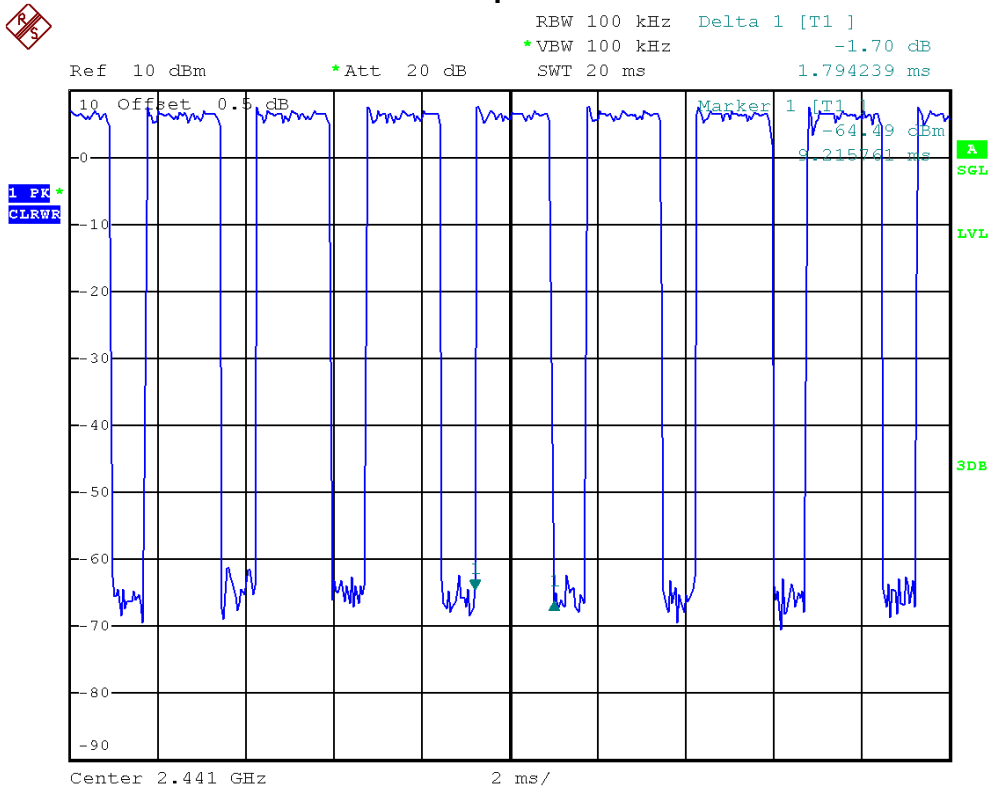

Bluetooth/1 Mbps/2441 MHz/DH1

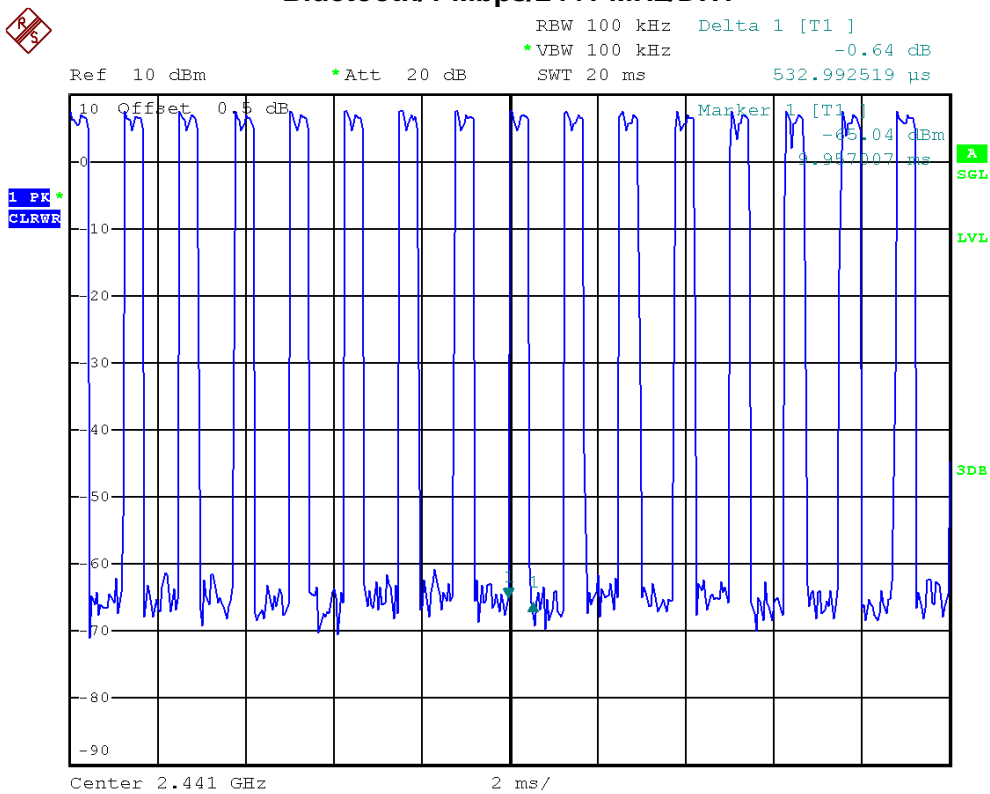



Neutron Engineering Inc.

EUT	BOOM BOOM !	Model Name	BOOM BOOM !
Temperature	25°C	Relative Humidity	46%
Test Voltage	AC 120V/60Hz		
Test Mode	Bluetooth/1 Mbps/2480 MHz		

Data Packet	Frequency	Pulse Duration (ms)	Dwell Time (s)	Limit (s)	Result
DH5	2480 MHz	3.0455	0.3249	0.4	PASS
DH3	2480 MHz	1.7614	0.2818	0.4	PASS
DH1	2480 MHz	0.5320	0.1702	0.4	PASS

Bluetooth/1 Mbps/2480 MHz/DH5

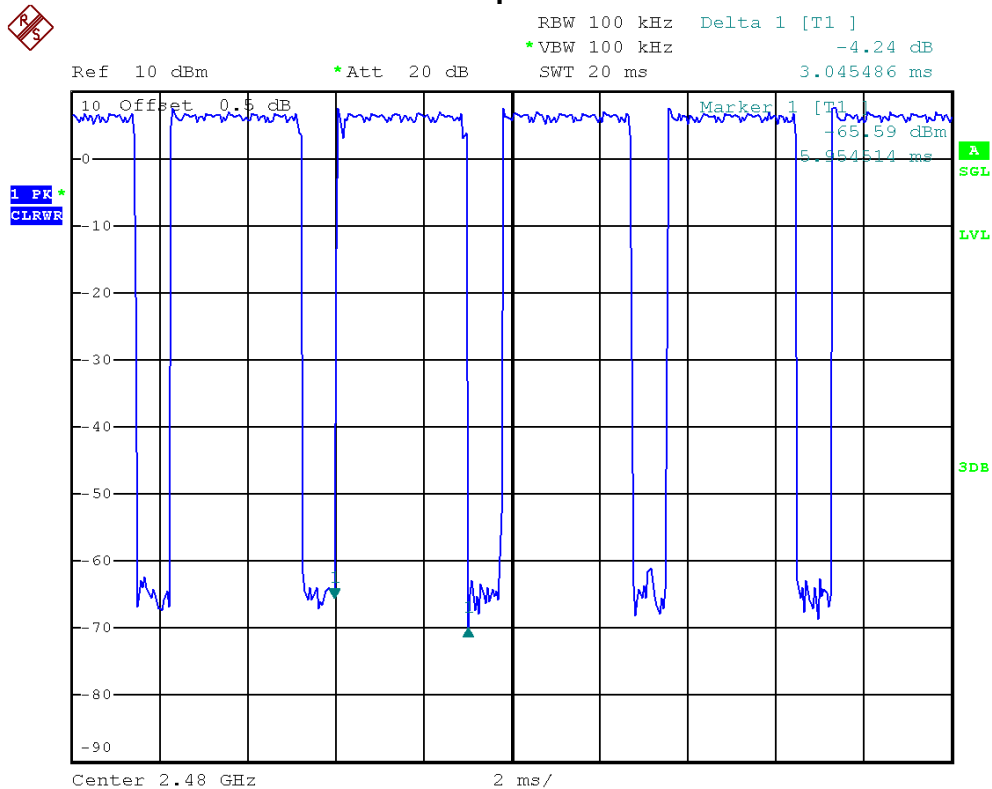



Neutron Engineering Inc.

Bluetooth/1 Mbps/2480 MHz/DH3

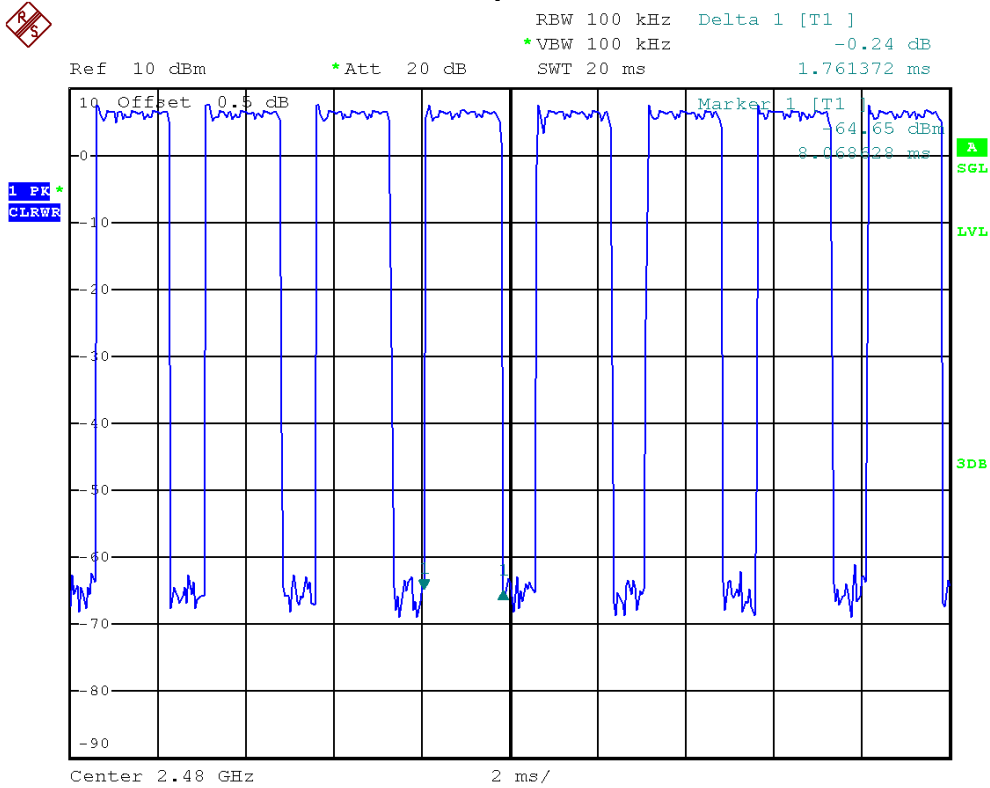

Bluetooth/1 Mbps/2480 MHz/DH1

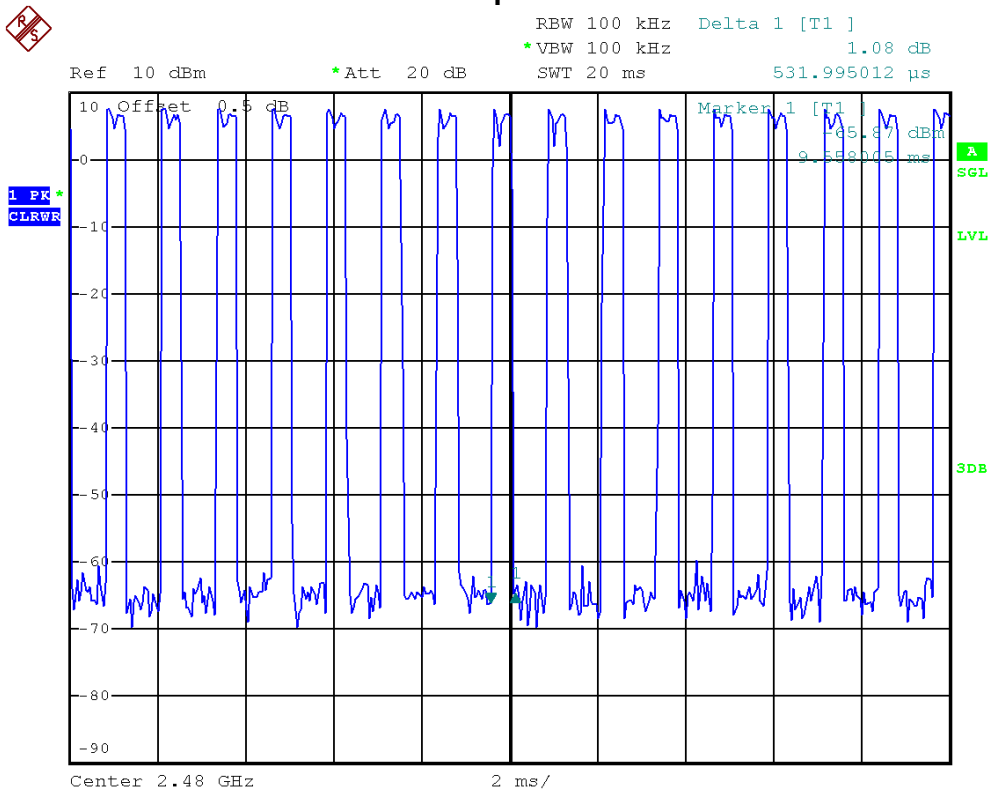



Neutron Engineering Inc.

EUT	BOOM BOOM !	Model Name	BOOM BOOM !
Temperature	25°C	Relative Humidity	46%
Test Voltage	AC 120V/60Hz		
Test Mode	Bluetooth/3 Mbps/2402 MHz		

Data Packet	Frequency	Pulse Duration (ms)	Dwell Time (s)	Limit (s)	Result
DH5	2402 MHz	3.0362	0.3239	0.4	PASS
DH3	2402 MHz	1.7610	0.2818	0.4	PASS
DH1	2402 MHz	0.5301	0.1696	0.4	PASS

Bluetooth/3 Mbps/2402 MHz/DH5

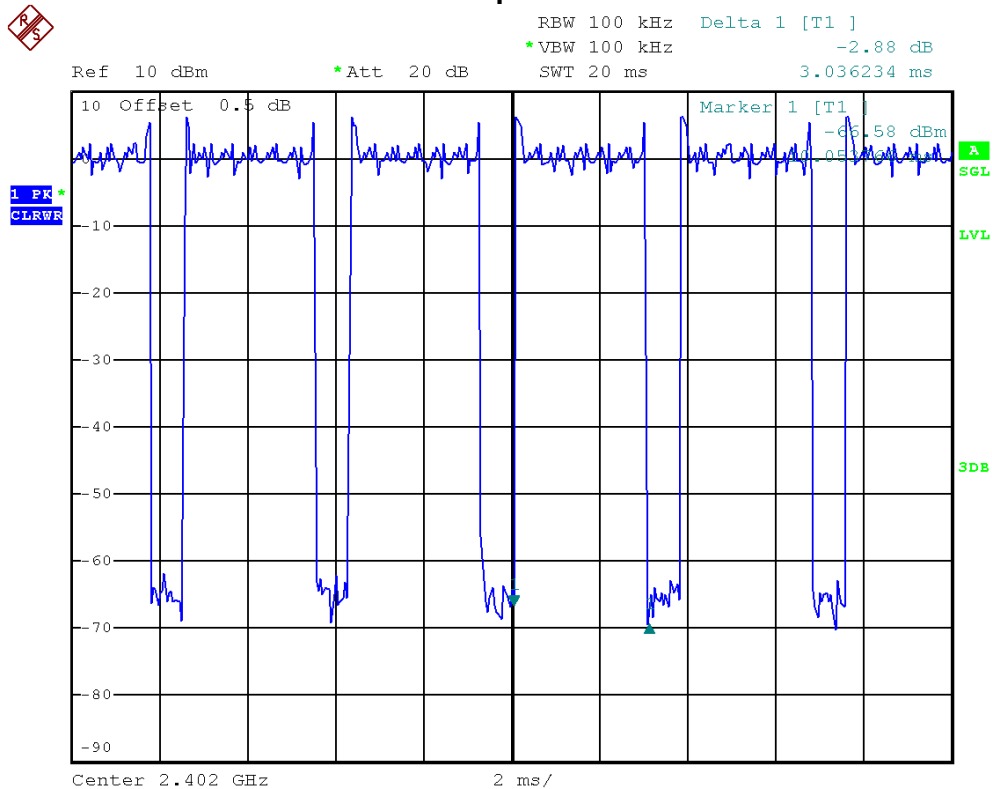



Neutron Engineering Inc.

Bluetooth/3 Mbps/2402 MHz/DH3



RBW 100 kHz Delta 1 [T1]
 *Att 20 dB 3.49 dB
 *VBW 100 kHz
 Ref 10 dBm SWT 20 ms 1.760998 ms

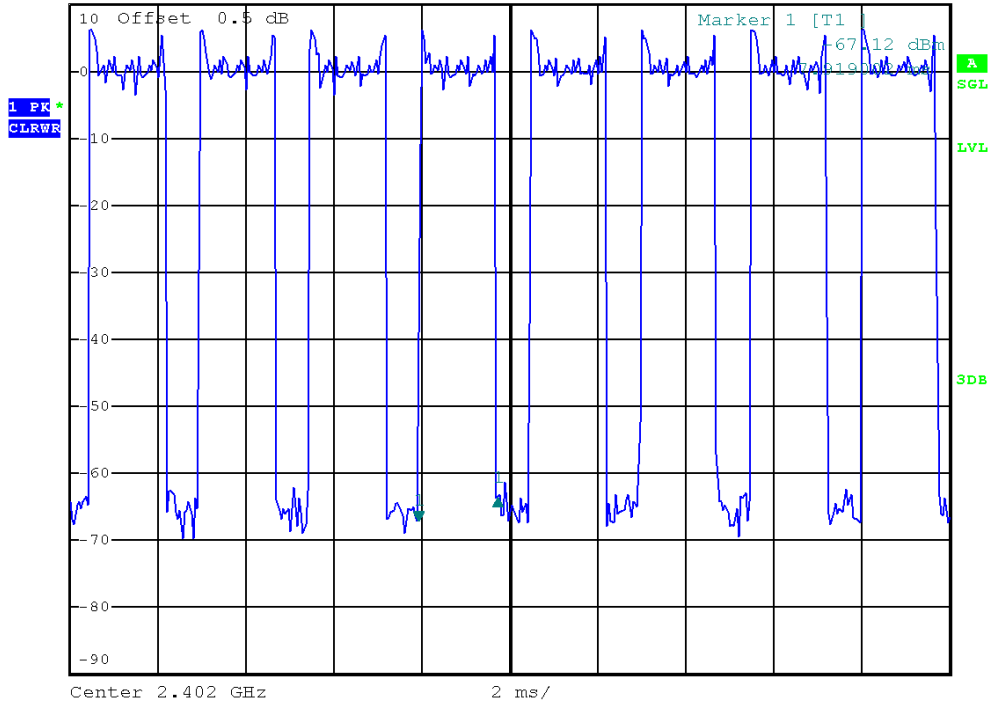

Bluetooth/3 Mbps/2402 MHz/DH1



RBW 100 kHz Delta 1 [T1]
 *Att 20 dB 0.48 dB
 *VBW 100 kHz
 Ref 10 dBm SWT 20 ms 530.124688 μ s

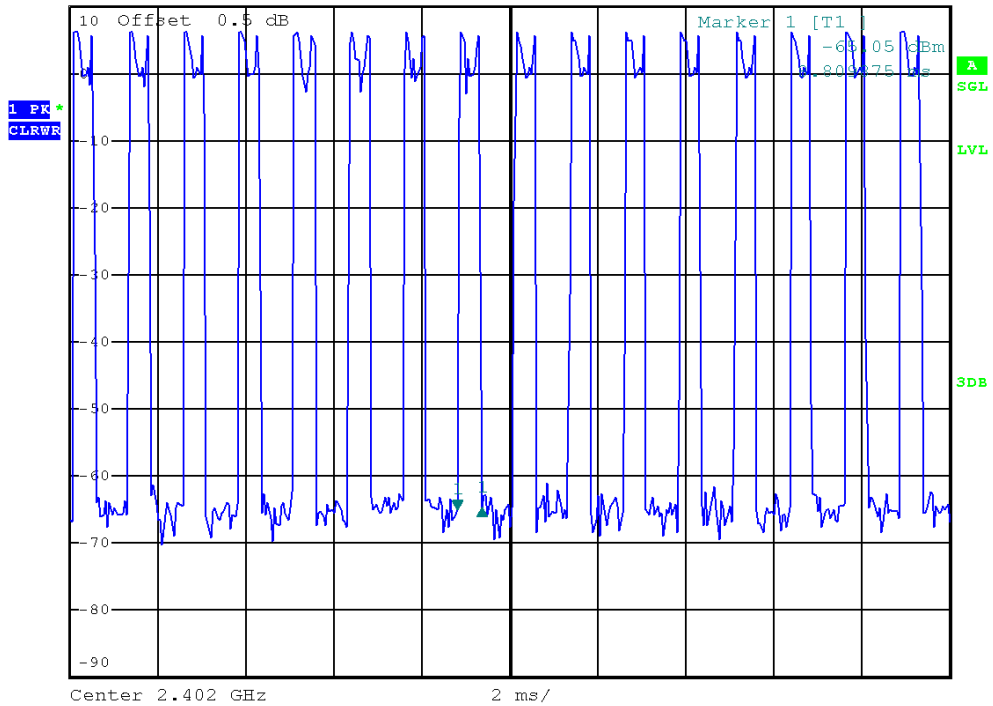



Neutron Engineering Inc.

EUT	BOOM BOOM !	Model Name	BOOM BOOM !
Temperature	25°C	Relative Humidity	46%
Test Voltage	AC 120V/60Hz		
Test Mode	Bluetooth/3 Mbps/2441 MHz		

Data Packet	Frequency	Pulse Duration (ms)	Dwell Time (s)	Limit (s)	Result
DH5	2441 MHz	3.0424	0.3245	0.4	PASS
DH3	2441 MHz	1.7602	0.2816	0.4	PASS
DH1	2441 MHz	0.5409	0.1731	0.4	PASS

Bluetooth/3 Mbps/2441 MHz/DH5

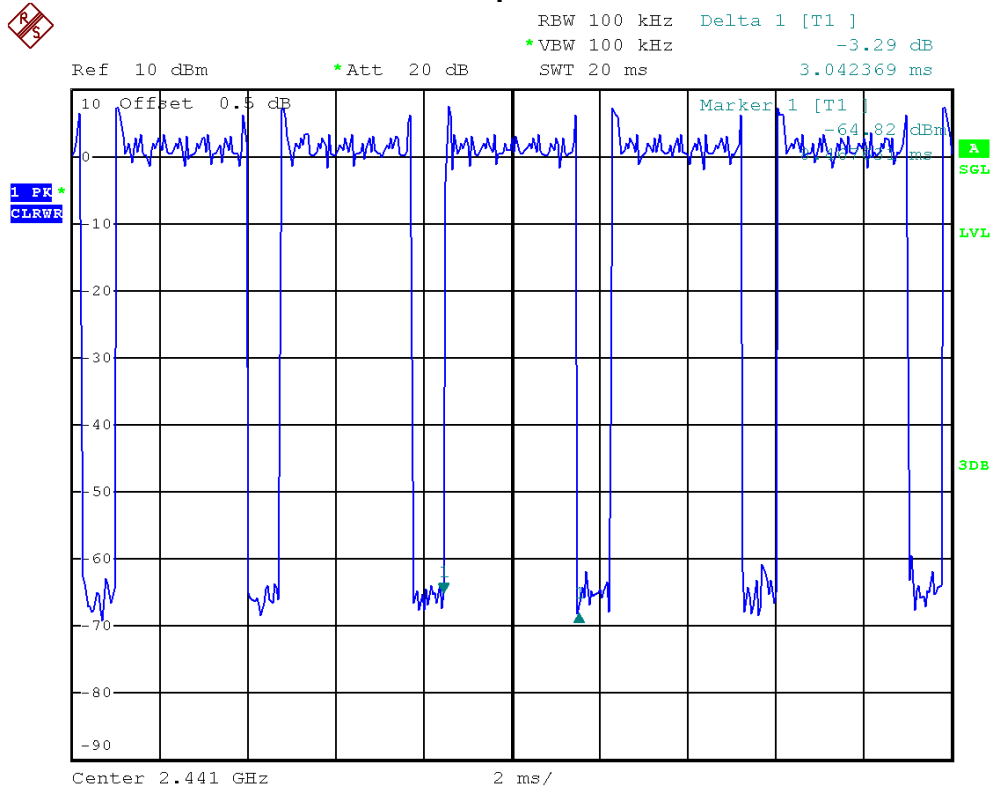



Neutron Engineering Inc.

Bluetooth/3 Mbps/2441 MHz/DH3

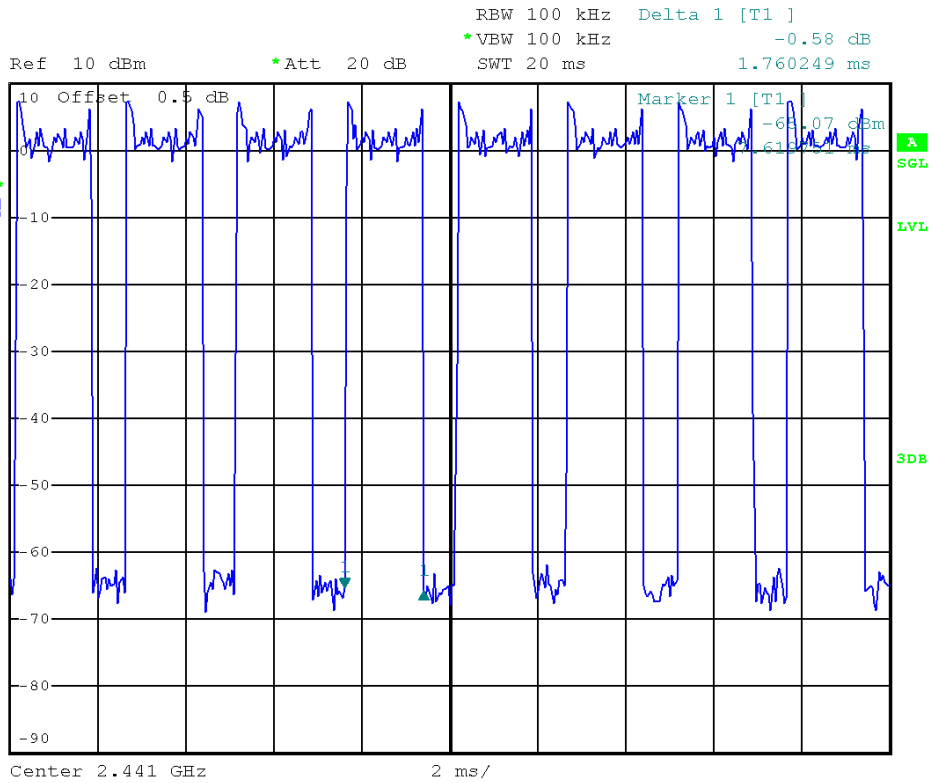

Bluetooth/3 Mbps/2441 MHz/DH1

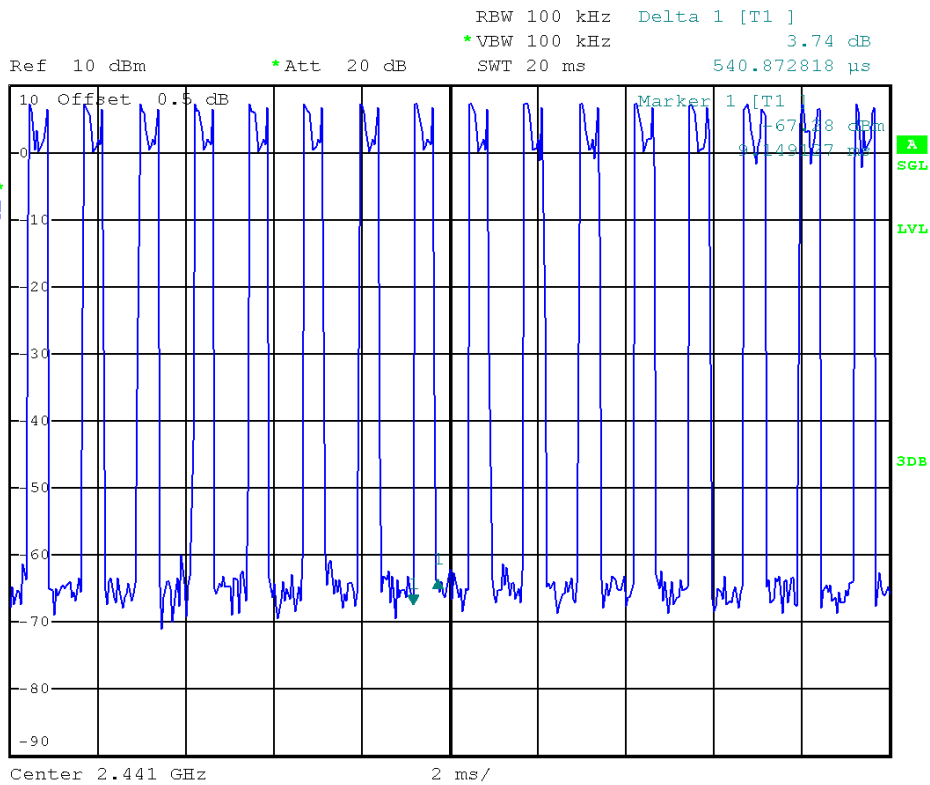



Neutron Engineering Inc.

EUT	BOOM BOOM !	Model Name	BOOM BOOM !
Temperature	25°C	Relative Humidity	46%
Test Voltage	AC 120V/60Hz		
Test Mode	Bluetooth/3 Mbps/2480 MHz		

Data Packet	Frequency	Pulse Duration (ms)	Dwell Time (s)	Limit (s)	Result
DH5	2480 MHz	3.0381	0.3241	0.4	PASS
DH3	2480 MHz	1.7861	0.2858	0.4	PASS
DH1	2480 MHz	0.5317	0.1702	0.4	PASS

Bluetooth/3 Mbps/2480 MHz/DH5

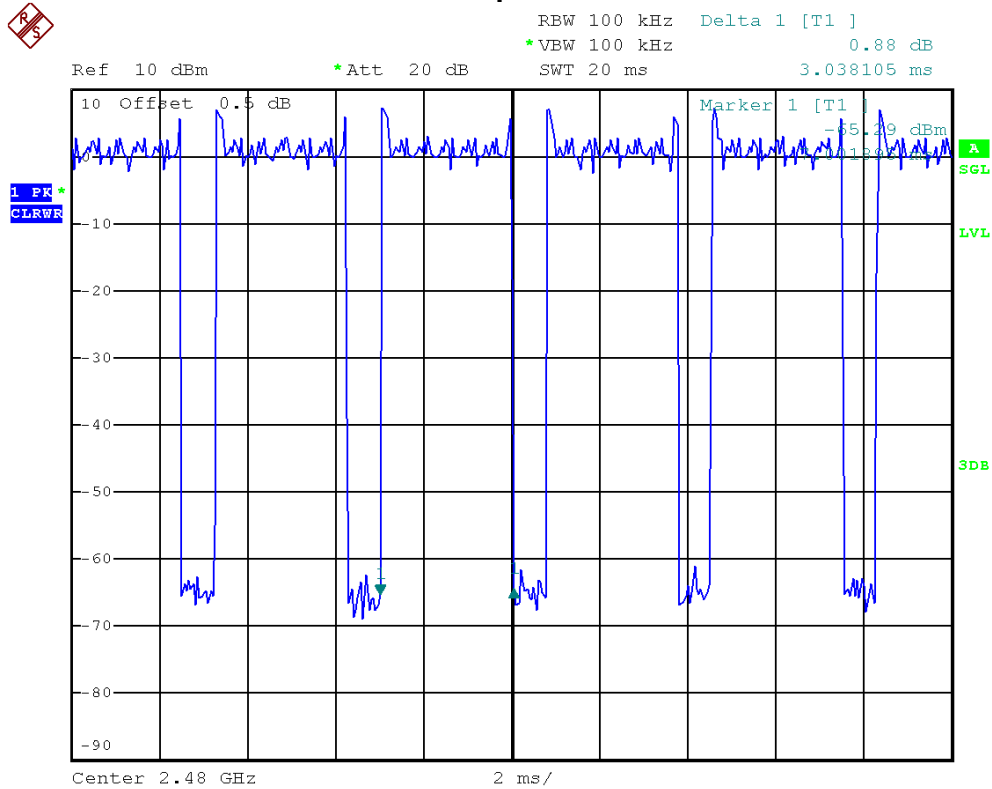



Neutron Engineering Inc.

Bluetooth/3 Mbps/2480 MHz/DH3



RBW 100 kHz Delta 1 [T1]
*VBW 100 kHz -0.43 dB
SWT 20 ms 1.786110 ms

Ref 10 dBm

*Att 20 dB

1 PK*
CLRWR

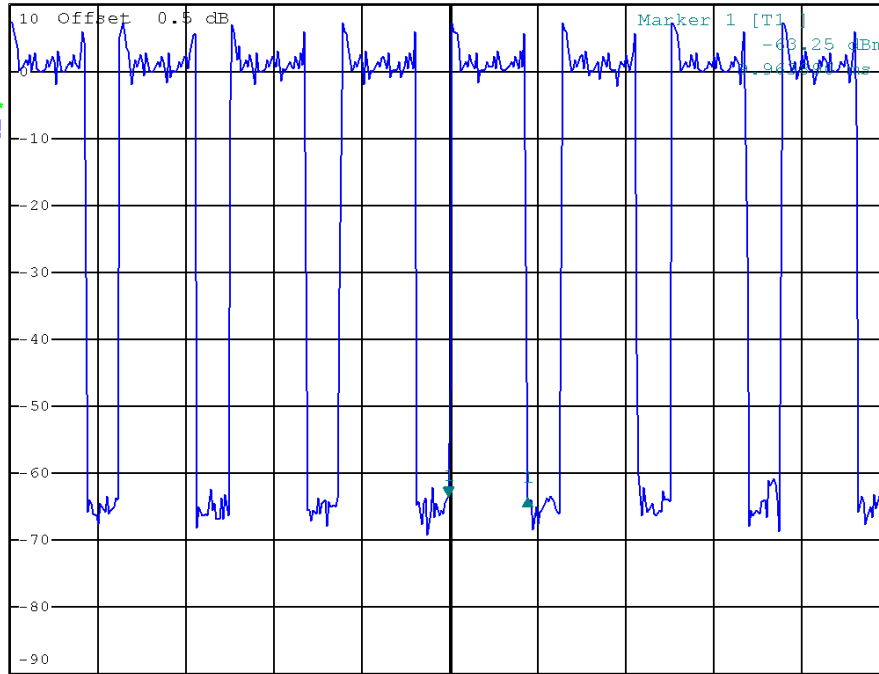

Bluetooth/3 Mbps/2480 MHz/DH1



RBW 100 kHz Delta 1 [T1]
*VBW 100 kHz -0.73 dB
SWT 20 ms 531.745636 μ s

Ref 10 dBm

*Att 20 dB

1 PK*
CLRWR

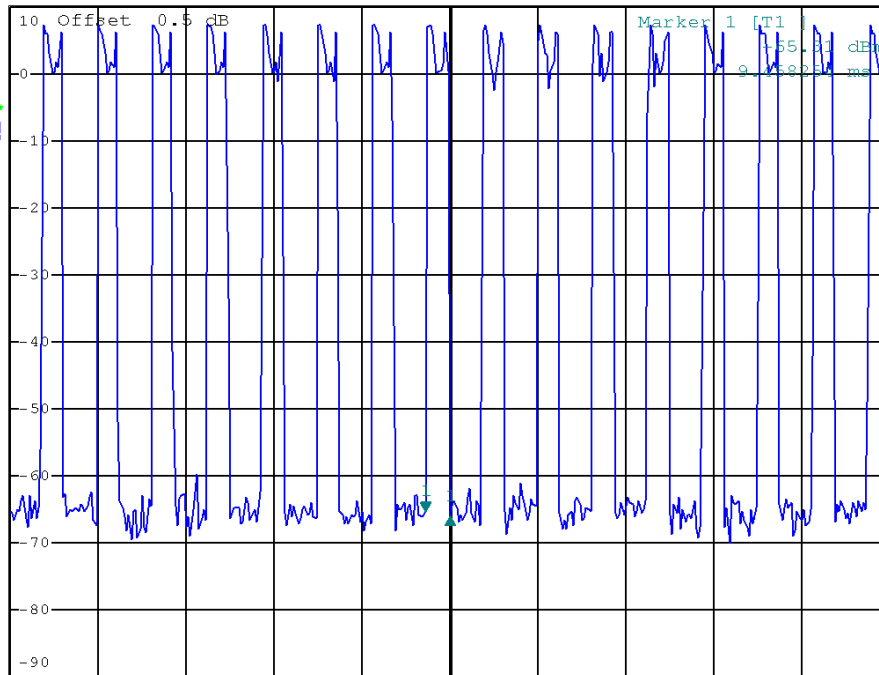

12 EUT TEST PHOTO

Conducted emission test photos



Radiated spurious emission test photos

