



# TEST REPORT

**Report Reference No.**..... : **TRE14090022** R/C.....: 55671  
**FCC ID**..... : **2ABOU5008**  
**Applicant's name**..... : **Shenzhen Hipad Telecommunication Technology Co.,LTD**  
 Address..... : Room 502-503,Unit 3,Building C,Kexing Science Park, Keyuan Road, Hi-tech industrial Park,NanShan District,Shenzhen,Guangdong,China  
 Manufacturer..... : Shenzhen Hipad Telecommunication Technology Co.,LTD.  
 Address..... : Room 502-503,Unit 3,Building C,Kexing Science Park, Keyuan Road, Hi-tech industrial Park,NanShan District,Shenzhen,Guangdong,China  
**Test item description** ..... : Mobile phone  
 Trade Mark ..... : /  
 Model/Type reference..... : MM5008-MX  
 Listed Model(s) ..... : MM5008-MX-O, MM5008-CA  
**Standard** ..... : **ANSI C95.1-1999**  
**47CFR § 2.1093**  
 Date of receipt of test sample..... : Sep 04, 2014  
 Date of testing..... : Sep 15, 2014 ~ Sep 19, 2014  
 Date of issue..... : Sep 20, 2014  
**Result**..... : **PASS**

Compiled by  
 ( position+printed name+signature)...: File administrators May Hu

*May Hu*

Supervised by  
 ( position+printed name+signature)...: Test Engineer Jerome Luo

*Jerome Luo*

Approved by  
 ( position+printed name+signature)...: Manager Hans Hu

*Hans Hu*

**Testing Laboratory Name** ..... : **Shenzhen Huatongwei International Inspection Co., Ltd**  
 Address..... : Keji Nan No.12 Road, Hi-tech Park, Shenzhen, China

**Shenzhen Huatongwei International Inspection Co., Ltd. All rights reserved.**

This publication may be reproduced in whole or in part for non-commercial purposes as long as the Shenzhen Huatongwei International Inspection Co., Ltd is acknowledged as copyright owner and source of the material. Shenzhen Huatongwei International Inspection Co., Ltd takes no responsibility for and will not assume liability for damages resulting from the reader's interpretation of the reproduced material due to its placement and context.

## Contents

<b>1.</b>	<b><u>TEST STANDARDS</u></b>	<b>3</b>
<b>2.</b>	<b><u>SUMMARY</u></b>	<b>4</b>
2.1.	Client Information	4
2.2.	Product Description	4
2.3.	Statement of Compliance	5
2.4.	Equipment under Test	6
2.5.	Short description of the Equipment under Test (EUT)	6
2.6.	EUT configuration	6
<b>3.</b>	<b><u>TEST ENVIRONMENT</u></b>	<b>7</b>
3.1.	Address of the test laboratory	7
3.2.	Test Facility	7
3.3.	Environmental conditions	8
3.4.	SAR Limits	8
3.5.	Equipments Used during the Test	8
<b>4.</b>	<b><u>SAR MEASUREMENTS SYSTEM CONFIGURATION</u></b>	<b>9</b>
4.1.	SAR Measurement Set-up	9
4.2.	DASY5 E-field Probe System	10
4.3.	Phantoms	11
4.4.	Device Holder	11
4.5.	Scanning Procedure	12
4.6.	Data Storage and Evaluation	12
4.7.	Tissue Dielectric Parameters for Head and Body Phantoms	14
4.8.	Tissue equivalent liquid properties	14
4.9.	System Check	15
4.10.	SAR measurement procedure	16
<b>5.</b>	<b><u>TEST CONDITIONS AND RESULTS</u></b>	<b>22</b>
5.1.	Conducted Power Results	22
5.2.	Simultaneous TX SAR Considerations	26
5.3.	SAR Measurement Results	29
5.4.	SAR Measurement Variability	31
5.5.	Measurement Uncertainty (300MHz-3GHz)	32
5.6.	System Check Results	34
5.7.	SAR Test Graph Results	40
<b>6.</b>	<b><u>CALIBRATION CERTIFICATE</u></b>	<b>58</b>
6.1.	Probe Calibration Certificate	58
6.2.	D835V2 Dipole Calibration Certificate	69
6.3.	D1900V2 Dipole Calibration Certificate	77
6.4.	D2450V2 Dipole Calibration Certificate	85
6.5.	DAE4 Calibration Certificate	93
<b>7.</b>	<b><u>TEST SETUP PHOTOS</u></b>	<b>96</b>
<b>8.</b>	<b><u>EXTERNAL PHOTOS OF THE EUT</u></b>	<b>102</b>

## 1. TEST STANDARDS

The tests were performed according to following standards:

[IEEE Std C95.1, 1999](#): IEEE Standard for Safety Levels with Respect to Human Exposure to Radio Frequency Electromagnetic Fields, 3 KHz to 300 GHz. It specifies the maximum exposure limit of 1.6 W/kg as averaged over any 1 gram of tissue for portable devices being used within 20 cm of the user in the uncontrolled environment.

[IEEE Std 1528™-2003](#): IEEE Recommended Practice for Determining the Peak Spatial-Average Specific Absorption Rate (SAR) in the Human Head from Wireless Communications Devices: Measurement Techniques.

[KDB 447498 D01 Mobile Portable RF Exposure v05r01](#): Mobile and Portable Device RF Exposure Procedures and Equipment Authorization Policies

[KDB 616217 D04 SAR for laptop and tablets v01](#): SAR Evaluation Considerations for Laptop, Notebook, Netbook and Tablet Computers

[KDB865664 D01 SAR measurement 100 MHz to 6 GHz v01r02](#): SAR Measurement Requirements for 100 MHz to 6 GHz

[KDB865664 D02 SAR Reporting v01](#): RF Exposure Compliance Reporting and Documentation Considerations

[KDB248227](#): SAR measurement procedures for 802.112abg transmitters

[FCC Part 2.1093 Radiofrequency Radiation Exposure Evaluation](#): Portable Devices

[KDB 616217 D04 SAR for laptop and Internet Tablets v01](#): SAR Evaluation Considerations for Laptop, Notebook, Netbook and Internet Tablet Computers

## 2. SUMMARY

### 2.1. Client Information

Applicant:	Shenzhen Hipad Telecommunication Technology Co.,LTD
Address:	Room 502-503,Unit 3,Building C,Kexing Science Park, Keyuan Road, Hi-tech industrial Park,NanShan District,Shenzhen,Guangdong,China
Manufacturer:	Shenzhen Hipad Telecommunication Technology Co.,LTD
Address:	Room 502-503,Unit 3,Building C,Kexing Science Park, Keyuan Road, Hi-tech industrial Park,NanShan District,Shenzhen,Guangdong,China

### 2.2. Product Description

Name of EUT	Mobile phone
Trade Mark:	/
Model No.:	MM5008-MX
Listed Model(s):	MM5008-MX-O, MM5008-CA
Power supply:	DC 3.7V From internal battery
Adapter information:	Model:JLY-050 Input:AC 100-240V 50/60Hz 0.2A Output:DC 5V 500mA

#### 2G:

Support Network:	GSM, GPRS, EGPRS
Support Band:	GSM850, DCS1900
Modulation:	GSM/GPRS: GMSK EGPRS: GMSK
Transmit Frequency:	GSM850: 824.20MHz-848.80MHz PCS1900: 1850.20MHz-1909.80MHz
Receive Frequency:	GSM850: 869.20MHz-893.80MHz PCS1900: 1930.20MHz-1989.80MHz
GPRS Class:	12
EGPRS Class:	12
Antenna type:	Intergal Antenna
Antenna gain:	GSM850:-0.2dBi PCS1900:-0.55dBi
Hardware version:	WS4040-V1.3
Software version:	UTLA80v1017_07-08-2014

#### 3G:

Operation Band:	FDD Band II and FDD Band V
Power Class:	Power Class 3
Modulation Type:	QPSK for WCDMA/HSUPA/HSDPA
WCDMA Release Version:	Release 6
HSDPA Release Version:	Category 8
HSUPA Release Version:	Category 5
DC-HSUPA Release Version:	Not Supported
Antenna type:	Intergal Antenna
Antenna gain:	Band II:-0.55dBi, Band V: -0.2dBi

#### Bluetooth

Version:	Supported BT2.1
Modulation:	GFSK, $\pi/4$ DQPSK, 8DPSK
Operation frequency:	2402MHz~2480MHz
Channel number:	79
Channel separation:	1MHz
Antenna type:	Internal Antenna
Antenna gain:	-2.24dBi
<b>WIFI</b>	
Supported type:	802.11b/802.11g/802.11n(H20)
Modulation:	802.11b: DSSS 802.11g/802.11n(H20):OFDM
Operation frequency:	802.11b/802.11g/802.11n(H20): 2412MHz~2462MHz
Channel number:	802.11b/802.11g/802.11n(H20): 11
Channel separation:	5MHz
Antenna type:	Internal Antenna
Antenna gain:	-2.24Bi

### 2.3. Statement of Compliance

The maximum of results of SAR found during testing for MM5008-MX are follows:

Exposure Configuration	Technolohy Band	Highest Reported SAR 1g(W/Kg)	Equipment Class
Head (Separation Distance 0mm)	GSM850	<b>0.382</b>	PCE
	PCS1900	0.308	
	WCDMA Band V	0.226	
	WCDMA Band II	0.246	
	WLAN2450	0.309	
Body-worn (Separation Distance 10mm)	GSM850	0.569	PCE
	PCS1900	<b>0.587</b>	
	WCDMA Band V	0.552	
	WCDMA Band II	0.360	
	WLAN2450	0.418	

The SAR values found for theTable PC are below the maximum recommended levels of 1.6W/Kg as averaged over any 1g tissue accordintg to the ANSI C95.1-1999.

For body worn operation, this devices has been tested and meets FCC RF exposure guidelines when used with any accessory that conrtains no metal and which provides a minimum separation distance of 0mm between this devices and the body of the user. User of other accessories may not ensure compliance with FCC RF exposure guidelines.

The EUT battery must be fully charged and checked periodically during the test to ascertain iniform power output.

#### GSM/WCDMA & WLAN Mode

Test Position	GSM850 Reported SAR1g (W/Kg)	PCS1900 Reported SAR1g (W/Kg)	WCDMA Band V Reported SAR1g (W/Kg)	WCDMA Band II Reported SAR1g (W/Kg)	WLAN Reported SAR1g (W/Kg)	Summation Reported SAR(1g) (W/kg)	Simultaneous Measurement Required?
Left Head Touch	0.364	<b>0.308</b>	<b>0.266</b>	0.212	0.227	0.591	No
Left Head Title	<b>0.382</b>	0.286	0.252	0.204	0.247	0.629	No
Right Head Touch	0.341	0.255	0.233	0.220	0.287	0.628	No
Right Head Title	0.323	0.270	0.245	<b>0.246</b>	<b>0.309</b>	<b>0.632</b>	No
Body-Back Side	<b>0.569</b>	<b>0.587</b>	<b>0.552</b>	<b>0.360</b>	<b>0.418</b>	<b>1.005</b>	No
Body-Left Side	0.388	0.370	0.392	0.247	0.370	0.762	No
Body-Right Side	0.347	0.326	0.375	0.210	--	--	No
Body-Bottom Side	0.416	0.482	0.440	0.267	--	--	No

**GSM/WCDMA & BT Mode**

Test Position	GSM850 Reported SAR <sub>1g</sub> (W/Kg)	PCS1900 Reported SAR <sub>1g</sub> (W/Kg)	WCDMA Band V Reported SAR <sub>1g</sub> (W/Kg)	WCDMA Band II Reported SAR <sub>1g</sub> (W/Kg)	Bluetooth Estimated SAR (W/Kg)	Summation Reported SAR(1g) (W/kg)	Simultaneous Measurement Required?
Left Head Touch	0.364	<b>0.308</b>	<b>0.266</b>	0.212	0.296	0.660	No
Left Head Title	<b>0.382</b>	0.286	0.252	0.204	0.296	<b>0.678</b>	No
Right Head Touch	0.341	0.255	0.233	0.220	0.296	0.637	No
Right Head Title	0.323	0.270	0.245	<b>0.246</b>	0.296	0.619	No
Body-Back Side	<b>0.569</b>	<b>0.587</b>	<b>0.552</b>	<b>0.360</b>	0.148	<b>0.735</b>	No
Body-Left Side	0.388	0.370	0.392	0.247	0.148	0.540	No
Body-Right Side	0.347	0.326	0.375	0.210	0.148	0.523	No
Body-Bottom Side	0.416	0.482	0.440	0.267	0.148	0.630	No

Note:1. The value with green color is the maximum values of standalone

2. The value with blue color is the maximum values of  $\Sigma$ SAR<sub>1g</sub>

3. Body-Rear side values was the maximum values of GPRS,EDGE and Speech with Headset.

According to the above tables,the highest sum of reported SAR values is **0.678W/Kg(1g)** for Head and **1.005W/Kg(1g)** for Body.

**2.4. Equipment under Test****Power supply system utilised**

Power supply voltage	:	<input type="radio"/> 120V / 60 Hz	<input type="radio"/> 115V / 60Hz
		<input type="radio"/> 12 V DC	<input type="radio"/> 24 V DC
		<input checked="" type="radio"/> Other (specified in blank below)	

DC 3.70V/DC 5.0V Adapter from AC 120V/60Hz

**2.5. Short description of the Equipment under Test (EUT)**

Mobile phone (Model: MM5008-MX).

The EUT battery must be fully charged and checked periodically during the test to ascertain maximum power output.

**2.6. EUT configuration**

The following peripheral devices and interface cables were connected during the measurement:

● - supplied by the manufacturer

○ - supplied by the lab

<input type="radio"/>	Power Cable	Length (m) :	/
		Shield :	/
		Detachable :	/
<input type="radio"/>	Multimeter	Manufacturer :	/
		Model No. :	/

### **3. TEST ENVIRONMENT**

#### **3.1. Address of the test laboratory**

Shenzhen Huatongwei International Inspection Co., Ltd.  
Keji Nan No.12 Road, Hi-tech Park, Shenzhen, China  
Phone: 86-755-26748019 Fax: 86-755-26748089

#### **3.2. Test Facility**

The test facility is recognized, certified, or accredited by the following organizations:

##### **CNAS-Lab Code: L1225**

Shenzhen Huatongwei International Inspection Co., Ltd. has been assessed and proved to be in compliance with CNAS-CL01 Accreditation Criteria for Testing and Calibration Laboratories (identical to ISO/IEC 17025: 2005 General Requirements) for the Competence of Testing and Calibration Laboratories, Date of Registration: Mar. 01, 2012. Valid time is until February 28, 2015.

##### **A2LA-Lab Cert. No. 2243.01**

Shenzhen Huatongwei International Inspection Co., Ltd. EMC Laboratory has been accredited by A2LA for technical competence in the field of electrical testing, and proved to be in compliance with ISO/IEC 17025: 2005 General Requirements for the Competence of Testing and Calibration Laboratories and any additional program requirements in the identified field of testing. Valid time is until Sept 30, 2015.

##### **FCC-Registration No.: 662850**

Shenzhen Huatongwei International Inspection Co., Ltd. EMC Laboratory has been registered and fully described in a report filed with the FCC (Federal Communications Commission). The acceptance letter from the FCC is maintained in our files. Registration 662850, Renewal date Jul. 01, 2012, valid time is until Jun. 01, 2015.

##### **IC-Registration No.: 5377A**

The 3m Alternate Test Site of Shenzhen Huatongwei International Inspection Co., Ltd. has been registered by Certification and Engineering Bureau of Industry Canada for the performance of radiated measurements with Registration No. 5377A on Dec. 31, 2013, valid time is until Dec. 31, 2016.

##### **ACA**

Shenzhen Huatongwei International Inspection Co., Ltd. EMC Laboratory can also perform testing for the Australian C-Tick mark as a result of our A2LA accreditation.

##### **VCCI**

The 3m Semi-anechoic chamber (12.2m×7.95m×6.7m) of Shenzhen Huatongwei International Inspection Co., Ltd. has been registered in accordance with the Regulations for Voluntary Control Measures with Registration No.:R-2484. Date of Registration: Dec. 20, 2012. Valid time is until Dec. 29, 2015.

Radiated disturbance above 1GHz measurement of Shenzhen Huatongwei International Inspection Co., Ltd. has been registered in accordance with the Regulations for Voluntary Control Measures with Registration No.: G-292. Date of Registration: Dec. 24, 2013. Valid time is until Dec. 23, 2016.

Main Ports Conducted Interference Measurement of Shenzhen Huatongwei International Inspection Co., Ltd. has been registered in accordance with the Regulations for Voluntary Control Measures with Registration No.: C-2726. Date of Registration: Dec. 20, 2012. Valid time is until Dec. 19, 2015.

Telecommunication Ports Conducted Interference Measurement of Shenzhen Huatongwei International Inspection Co., Ltd. has been registered in accordance with the Regulations for Voluntary Control Measures with Registration No.: T-1837. Date of Registration: May 07, 2013. Valid time is until May 06, 2016.

##### **DNV**

Shenzhen Huatongwei International Inspection Co., Ltd. has been found to comply with the requirements of DNV towards subcontractor of EMC and safety testing services in conjunction with the EMC and Low voltage Directives and in the voluntary field. The acceptance is based on a formal quality Audit and follow-ups according to relevant parts of ISO/IEC Guide 17025 (2005), in accordance with the requirements of the DNV Laboratory Quality Manual towards subcontractors. Valid time is until Aug. 24, 2016.

### 3.3. Environmental conditions

During the measurement the environmental conditions were within the listed ranges:

Temperature:	18-25 ° C
Humidity:	40-65 %
Atmospheric pressure:	950-1050mbar

### 3.4. SAR Limits

FCC Limit (1g Tissue)

EXPOSURE LIMITS	SAR (W/kg)	
	(General Population / Uncontrolled Exposure Environment)	(Occupational / Controlled Exposure Environment)
Spatial Average (averaged over the whole body)	0.08	0.4
Spatial Peak (averaged over any 1 g of tissue)	1.60	8.0
Spatial Peak (hands/wrists/feet/ankles averaged over 10 g)	4.0	20.0

Population/Uncontrolled Environments are defined as locations where there is the exposure of individual who have no knowledge or control of their exposure.

Occupational/Controlled Environments are defined as locations where there is exposure that may be incurred by people who are aware of the potential for exposure (i.e. as a result of employment or occupation).

### 3.5. Equipments Used during the Test

Test Equipment	Manufacturer	Type/Model	Serial Number	Calibration	
				Last Calibration	Calibration Interval
Data Acquisition Electronics DAEx	SPEAG	DAE4	1315	2013/11/25	1
E-field Probe	SPEAG	EX3DV4	3842	2014/06/06	1
System Validation Dipole 835V2	SPEAG	D835V2	4d134	2013/12/13	1
System Validation Dipole 1900V2	SPEAG	D1900V2	5d150	2013/12/12	1
System Validation Dipole 2450V2	SPEAG	D2450V2	884	2013/12/11	1
Dielectric Probe Kit	Agilent	85070E	US44020288	/	/
Power meter	Agilent	E4417A	GB41292254	2013/12/26	1
Power sensor	Agilent	8481H	MY41095360	2013/12/26	1
Network analyzer	Agilent	8753E	US37390562	2013/12/25	1
Universal Radio Communication Tester	ROHDE & SCHWARZ	CMU200	112012	2013/10/23	1



## 4. SAR Measurements System configuration

### 4.1. SAR Measurement Set-up

The DASY5 system for performing compliance tests consists of the following items:

A standard high precision 6-axis robot (Stäubli RX family) with controller and software. An arm extension for accommodating the data acquisition electronics (DAE).

A dosimetric probe, i.e. an isotropic E-field probe optimized and calibrated for usage in tissue simulating liquid. The probe is equipped with an optical surface detector system.

A data acquisition electronic (DAE) which performs the signal amplification, signal multiplexing, AD-conversion, offset measurements, mechanical surface detection, collision detection, etc. The unit is battery powered with standard or rechargeable batteries. The signal is optically transmitted to the EOC.

A unit to operate the optical surface detector which is connected to the EOC.

The Electro-Optical Coupler (EOC) performs the conversion from the optical into a digital electric signal of the DAE. The EOC is connected to the DASY5 measurement server.

The DASY5 measurement server, which performs all real-time data evaluation for field measurements and surface detection, controls robot movements and handles safety operation. A computer operating Windows 2003.

DASY5 software and SEMCAD data evaluation software.

Remote control with teach panel and additional circuitry for robot safety such as warning lamps, etc.

The generic twin phantom enabling the testing of left-hand and right-hand usage.

The device holder for handheld mobile phones.

Tissue simulating liquid mixed according to the given recipes.

System validation dipoles allowing to validate the proper functioning of the system.

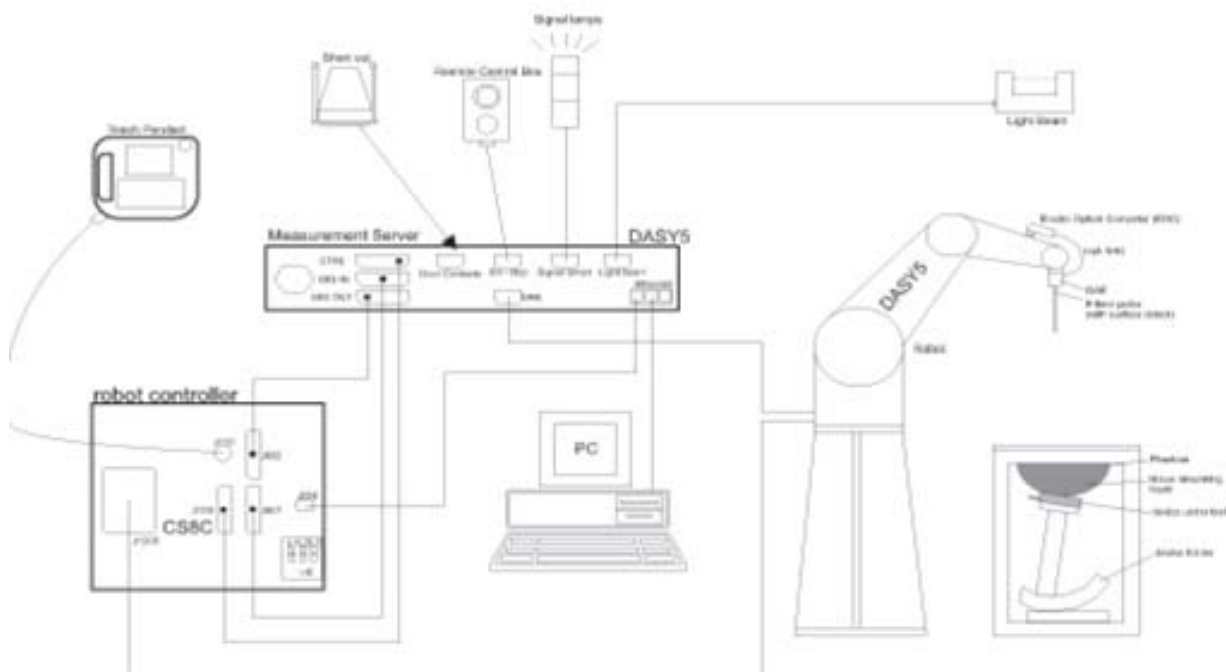

## 4.2. DASY5 E-field Probe System

The SAR measurements were conducted with the dosimetric probe ES3DV3 (manufactured by SPEAG), designed in the classical triangular configuration and optimized for dosimetric evaluation.

### Probe Specification

Construction	Symmetrical design with triangular core Interleaved sensors Built-in shielding against static charges PEEK enclosure material (resistant to organic solvents, e.g., DGBE)
Calibration	ISO/IEC 17025 calibration service available.
Frequency	10 MHz to 4 GHz; Linearity: $\pm 0.2$ dB (30 MHz to 4 GHz)
Directivity	$\pm 0.2$ dB in HSL (rotation around probe axis) $\pm 0.3$ dB in tissue material (rotation normal to probe axis)
Dynamic Range	5 $\mu$ W/g to > 100 mW/g; Linearity: $\pm 0.2$ dB
Dimensions	Overall length: 337 mm (Tip: 20 mm) Tip diameter: 3.9 mm (Body: 12 mm) Distance from probe tip to dipole centers: 2.0 mm
Application	General dosimetry up to 4 GHz Dosimetry in strong gradient fields Compliance tests of mobile phones
Compatibility	DASY3, DASY4, DASY52 SAR and higher, EASY4/MRI



### Isotropic E-Field Probe

The isotropic E-Field probe has been fully calibrated and assessed for isotropicity, and boundary effect within a controlled environment. Depending on the frequency for which the probe is calibrated the method utilized for calibration will change.

The E-Field probe utilizes a triangular sensor arrangement as detailed in the diagram below:

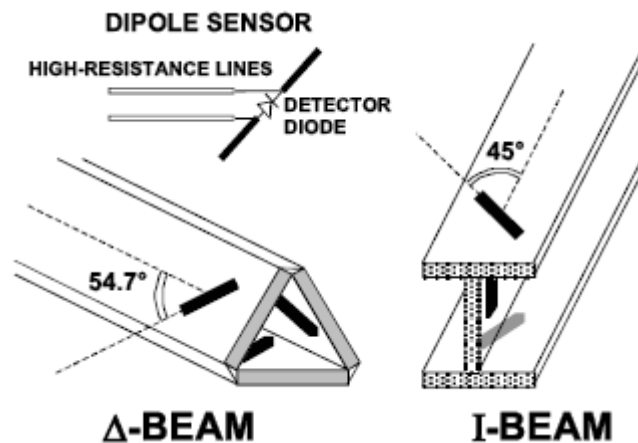

### 4.3. Phantoms

The phantom used for all tests i.e. for both system checks and device testing, was the twin-headed "SAM Phantom", manufactured by SPEAG. The SAM twin phantom is a fiberglass shell phantom with 2mm shell thickness (except the ear region, where shell thickness increases to 6mm).

System checking was performed using the flat section, whilst Head SAR tests used the left and right head profile sections. Body SAR testing also used the flat section between the head profiles.



SAM Twin Phantom

### 4.4. Device Holder

The device was placed in the device holder (illustrated below) that is supplied by SPEAG as an integral part of the DASY system.

The DASY device holder is designed to cope with the different positions given in the standard. It has two scales for device rotation (with respect to the body axis) and device inclination (with respect to the line between the ear reference points). The rotation centers for both scales is the ear reference point (ERP). Thus the device needs no repositioning when changing the angles.



Device holder supplied by SPEAG

## 4.5. Scanning Procedure

The DASY5 installation includes predefined files with recommended procedures for measurements and validation. They are read-only document files and destined as fully defined but unmeasured masks. All test positions (head or body-worn) are tested with the same configuration of test steps differing only in the grid definition for the different test positions.

The “reference” and “drift” measurements are located at the beginning and end of the batch process. They measure the field drift at one single point in the liquid over the complete procedure. The indicated drift is mainly the variation of the DUT’s output power and should vary max.  $\pm 5\%$ .

The “surface check” measurement tests the optical surface detection system of the DASY5 system by repeatedly detecting the surface with the optical and mechanical surface detector and comparing the results. The output gives the detecting heights of both systems, the difference between the two systems and the standard deviation of the detection repeatability. Air bubbles or refraction in the liquid due to separation of the sugar-water mixture gives poor repeatability (above  $\pm 0.1\text{mm}$ ). To prevent wrong results tests are only executed when the liquid is free of air bubbles. The difference between the optical surface detection and the actual surface depends on the probe and is specified with each probe (It does not depend on the surface reflectivity or the probe angle to the surface within  $\pm 30^\circ$ .)

### Area Scan

The Area Scan is used as a fast scan in two dimensions to find the area of high field values before running a detailed measurement around the hot spot. Before starting the area scan a grid spacing of 15 mm x 15 mm is set. During the scan the distance of the probe to the phantom remains unchanged. After finishing area scan, the field maxima within a range of 2 dB will be ascertained.

### Zoom Scan

Zoom Scans are used to estimate the peak spatial SAR values within a cubic averaging volume containing 1 g and 10 g of simulated tissue. The default Zoom Scan is done by 7x7x7 points within a cube whose base is centered around the maxima found in the preceding area scan.

### Spatial Peak Detection

The procedure for spatial peak SAR evaluation has been implemented and can determine values of masses of 1g and 10g, as well as for user-specific masses. The DASY5 system allows evaluations that combine measured data and robot positions, such as: • maximum search • extrapolation • boundary correction • peak search for averaged SAR. During a maximum search, global and local maxima searches are automatically performed in 2-D after each Area Scan measurement with at least 6 measurement points. It is based on the evaluation of the local SAR gradient calculated by the Quadratic Shepard’s method. The algorithm will find the global maximum and all local maxima within -2 dB of the global maxima for all SAR distributions.

Extrapolation routines are used to obtain SAR values between the lowest measurement points and the inner phantom surface. The extrapolation distance is determined by the surface detection distance and the probe sensor offset. Several measurements at different distances are necessary for the extrapolation. Extrapolation routines require at least 10 measurement points in 3-D space. They are used in the Zoom Scan to obtain SAR values between the lowest measurement points and the inner phantom surface. The routine uses the modified Quadratic Shepard’s method for extrapolation. For a grid using 7x7x7 measurement points with 5mm resolution amounting to 343 measurement points, the uncertainty of the extrapolation routines is less than 1% for 1g and 10g cubes.

A Z-axis scan measures the total SAR value at the x-and y-position of the maximum SAR value found during the cube 7x7x7 scan. The probe is moved away in z-direction from the bottom of the SAM phantom in 5mm steps.

## 4.6. Data Storage and Evaluation

### Data Storage

The DASY5 software stores the acquired data from the data acquisition electronics as raw data (in microvolt readings from the probe sensors), together with all necessary software parameters for the data evaluation (probe calibration data, liquid parameters and device frequency and modulation data) in measurement files with the extension “.DA4”. The software evaluates the desired unit and format for output each time the data is visualized or exported. This allows verification of the complete software setup even after the measurement and allows correction of incorrect parameter settings. For example, if a measurement has been performed with a wrong crest factor parameter in the device setup, the parameter can be corrected afterwards and the data can be re-evaluated.

The measured data can be visualized or exported in different units or formats, depending on the selected probe type ([V/m], [A/m], [°C], [mW/g], [mW/cm<sup>2</sup>], [dBrel], etc.). Some of these units are not available in certain situations or show meaningless results, e.g., a SAR output in a lossless media will always be zero. Raw data can also be exported to perform the evaluation with other software packages.

#### Data Evaluation

The SEMCAD software automatically executes the following procedures to calculate the field units from the microvolt readings at the probe connector. The parameters used in the evaluation are stored in the configuration modules of the software:

Probe parameters:	- Sensitivity	Normi, ai0, ai1, ai2
	- Conversion factor	ConvFi
	- Diode compression point	Dcpi
Device parameters:	- Frequency	f
	- Crest factor	cf
Media parameters:	- Conductivity	σ
	- Density	ρ

These parameters must be set correctly in the software. They can be found in the component documents or they can be imported into the software from the configuration files issued for the DASY5 components. In the direct measuring mode of the multimeter option, the parameters of the actual system setup are used. In the scan visualization and export modes, the parameters stored in the corresponding document files are used.

The first step of the evaluation is a linearization of the filtered input signal to account for the compression characteristics of the detector diode. The compensation depends on the input signal, the diode type and the DC-transmission factor from the diode to the evaluation electronics. If the exciting field is pulsed, the crest factor of the signal must be known to correctly compensate for peak power. The formula for each channel can be given as:

$$V_i = U_i + U_i^2 \cdot \frac{cf}{dcp_i}$$

With	$V_i$	= compensated signal of channel i	(i = x, y, z)
	$U_i$	= input signal of channel i	(i = x, y, z)
	cf	= crest factor of exciting field	(DASY parameter)
	dcp <sub>i</sub>	= diode compression point	(DASY parameter)

From the compensated input signals the primary field data for each channel can be evaluated:

$$\text{E - fieldprobes : } E_i = \sqrt{\frac{V_i}{Norm_i \cdot ConvF}}$$

$$\text{H - fieldprobes : } H_i = \sqrt{V_i} \cdot \frac{a_{i0} + a_{i1}f + a_{i2}f^2}{f}$$

With	$V_i$	= compensated signal of channel i	(i = x, y, z)
	Norm <sub>i</sub>	= sensor sensitivity of channel i	(i = x, y, z)
		[mV/(V/m) <sup>2</sup> ] for E-field Probes	
	ConvF	= sensitivity enhancement in solution	
	a <sub>ij</sub>	= sensor sensitivity factors for H-field probes	
	f	= carrier frequency [GHz]	
	$E_i$	= electric field strength of channel i in V/m	
	$H_i$	= magnetic field strength of channel i in A/m	

The RSS value of the field components gives the total field strength (Hermitian magnitude):

$$E_{tot} = \sqrt{E_x^2 + E_y^2 + E_z^2}$$

The primary field data are used to calculate the derived field units.

$$SAR = E_{tot}^2 \cdot \frac{\sigma}{\rho \cdot 1'000}$$

with	SAR	= local specific absorption rate in mW/g
	$E_{tot}$	= total field strength in V/m
	σ	= conductivity in [mho/m] or [Siemens/m]
	ρ	= equivalent tissue density in g/cm <sup>3</sup>

Note that the density is normally set to 1 (or 1.06), to account for actual brain density rather than the density of the simulation liquid.

### 4.7. Tissue Dielectric Parameters for Head and Body Phantoms

The liquid is consisted of water,salt,Glycol,Sugar,Preventol and Cellulose.The liquid has previously been proven to be suited for worst-case.The table 3 and table 4 show the detail solition.It's satisfying the latest tissue dielectric parameters requirements proposed by the KDB865664.

Table 3:Composition of the Head Tissue Equivalent Matter

MIXTURE%	FREQUENCY(Brain) 835MHz
Water	41.45
Sugar	56
Salt	1.45
Preventol	0.12
Cellulose	1.0
Dielectric Paramters Target Value	f=835MHz $\epsilon$ =41.50 $\sigma$ =0.9

MIXTURE%	FREQUENCY(Brain) 1900MHz
Water	55.242
Glycol monobutyl	44.452
Salt	0.306
Dielectric Paramters Target Value	f=1900MHz $\epsilon$ =40.00 $\sigma$ =1.40

MIXTURE%	FREQUENCY(Brain) 2450MHz
Water	62.70
Glycol	36.80
Salt	0.50
Dielectric Paramters Target Value	f=2450MHz $\epsilon$ =39.20 $\sigma$ =1.80

Table 4:Composition of the Body Tissue Equivalent Matter

MIXTURE%	FREQUENCY(Brain) 835MHz
Water	52.50
Sugar	45
Salt	1.40
Preventol	0.10
Cellulose	1.00
Dielectric Paramters Target Value	f=835MHz $\epsilon$ =55.20 $\sigma$ =0.97

MIXTURE%	FREQUENCY(Brain) 1900MHz
Water	69.91
Glycol monobutyl	29.96
Salt	0.13
Dielectric Paramters Target Value	f=1900MHz $\epsilon$ =53.30 $\sigma$ =1.52

MIXTURE%	FREQUENCY(Brain) 2450MHz
Water	73.20
Glycol	26.70
Salt	0.10
Dielectric Paramters Target Value	f=2450MHz $\epsilon$ =52.70 $\sigma$ =1.95

### 4.8. Tissue equivalent liquid properties

Dielectric performance of Body tissue simulating liquid

Frequency	Description	Dielectric paramenters	
		$\epsilon_r$	$\sigma$
835MHz(Head)	Target Value $\pm$ 5%	41.5 (39.4~43.6)	0.90 (0.86~0.95)
	Measurement Value 2014-09-15	41.53	0.92
835MHz(Body)	Target Value $\pm$ 5%	56.1 (53.30~58.91)	0.97 (0.90~1.00)
	Measurement Value 2014-09-15	55.95	0.96

1900MHz(Head)	Target Value $\pm 5\%$	40.0 (38.0~42.0)	1.40 (1.33~1.47)
	Measurement Value 2014-09-17	39.83	1.45
1900MHz(Body)	Target Value $\pm 5\%$	54.00 (51.30~56.70)	1.45 (1.38~1.52)
	Measurement Value 2014-09-17	55.64	1.49
2450MHz(Head)	Target Value $\pm 5\%$	39.20 (37.24~41.16)	1.80 (1.71~1.89)
	Measurement Value 2014-09-19	40.58	1.74
2450MHz(Body)	Target Value $\pm 5\%$	52.70 (50.01~55.34)	1.95 (1.85~2.05)
	Measurement Value 2014-09-19	53.47	1.98

### 4.9. System Check

The purpose of the system check is to verify that the system operates within its specifications at the device test frequency. The system check is simple check of repeatability to make sure that the system works correctly at the time of the compliance test;

System check results have to be equal or near the values determined during dipole calibration with the relevant liquids and test system ( $\pm 10\%$ ).

System check is performed regularly on all frequency bands where tests are performed with the DASY5 system.

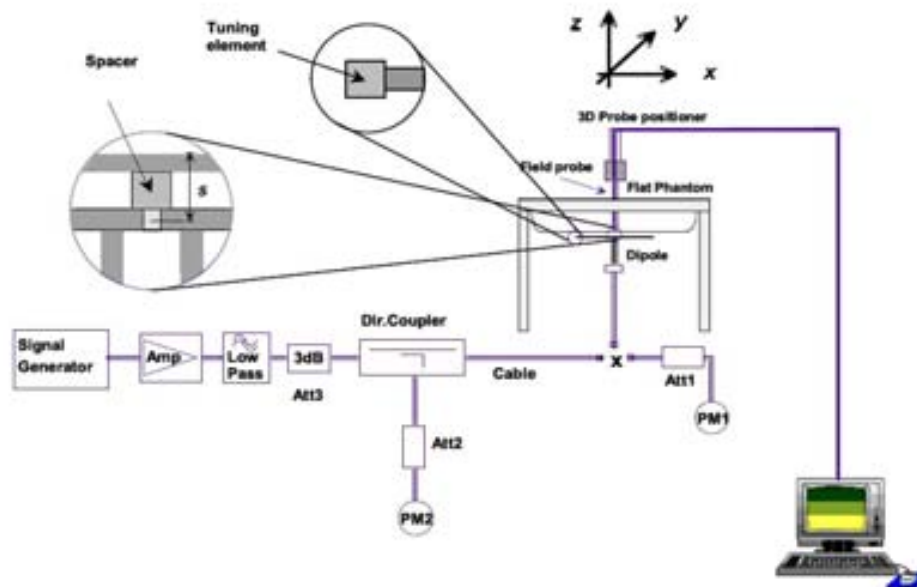

The output power on dipole port must be calibrated to 24 dBm (250Mw) before dipole is connected.

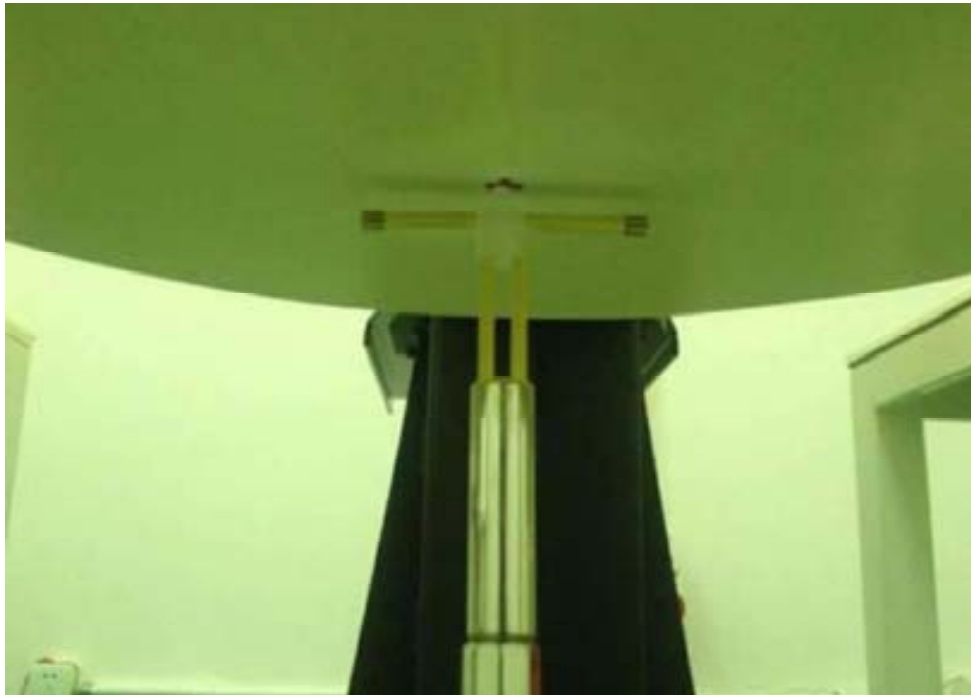

Photo of Dipole Setup

System Validation of Head

Measurement is made at temperature 22.0 °C and relative humidity 55%.							
Tissue temperature 22.0 °C							
Measurement Date: 835MHz Sep 15 <sup>th</sup> , 2014; 1900MHz Sep 17 <sup>th</sup> , 2014; 2540MHz Sep 19 <sup>th</sup> , 2014;							
Verification results	Frequency (MHz)	Target value (W/kg)		Measured value (W/kg)		Deviation	
		1 g Average	10 g Average	1 g Average	10 g Average	1 g Average	10 g Average
	835	2.38	1.55	2.32	1.48	-2.52%	-4.52%
	1900	9.71	5.08	9.53	4.96	-1.85%	-2.36%
	2450	13.00	6.05	12.47	5.83	-4.08%	-3.64%

System Validation of Body

Measurement is made at temperature 22.0 °C and relative humidity 55%.							
Tissue temperature 22.0 °C							
Measurement Date: 835MHz Sep 15 <sup>th</sup> , 2014; 1900MHz Sep 17 <sup>th</sup> , 2014; 2540MHz Sep 19 <sup>th</sup> , 2014;							
Verification results	Frequency (MHz)	Target value (W/kg)		Measured value (W/kg)		Deviation	
		1 g Average	10 g Average	1 g Average	10 g Average	1 g Average	10 g Average
	835	2.32	1.54	2.25	1.48	-3.02%	-3.90%
	1900	9.98	5.26	9.71	5.13	-2.71%	-2.47%
	2450	12.9	5.98	12.53	5.69	-2.87%	-4.85%

4.10. SAR measurement procedure

4.10.1 Tests to be performed

In order to determine the highest value of the peak spatial-average SAR of a handset, all device positions, configurations and operational modes shall be tested for each frequency band according to steps 1 to 3 below. A flowchart of the test process is shown in Picture 11.1.

Step 1: The tests described in 11.2 shall be performed at the channel that is closest to the centre of the transmit frequency band ( $f_c$ ) for:

- a). all device positions (cheek and tilt, for both left and right sides of the SAM phantom;
- b). all configurations for each device position in a), e.g., antenna extended and retracted, and
- c). all operational modes, e.g., analogue and digital, for each device position in a) and configuration in b) in each frequency band.

If more than three frequencies need to be tested according to 11.1 (i.e.,  $N_c > 3$ ), then all frequencies, configurations and modes shall be tested for all of the above test conditions.



Step 2: For the condition providing highest peak spatial-average SAR determined in Step 1, perform all tests described in 11.2 at all other test frequencies, i.e., lowest and highest frequencies. In addition, for all other conditions (device position, configuration and operational mode) where the peak spatial-average SAR value determined in Step 1 is within 3 dB of the applicable SAR limit, it is recommended that all other test frequencies shall be tested as well.

Step 3: Examine all data to determine the highest value of the peak spatial-average SAR found in Steps 1 to 2.

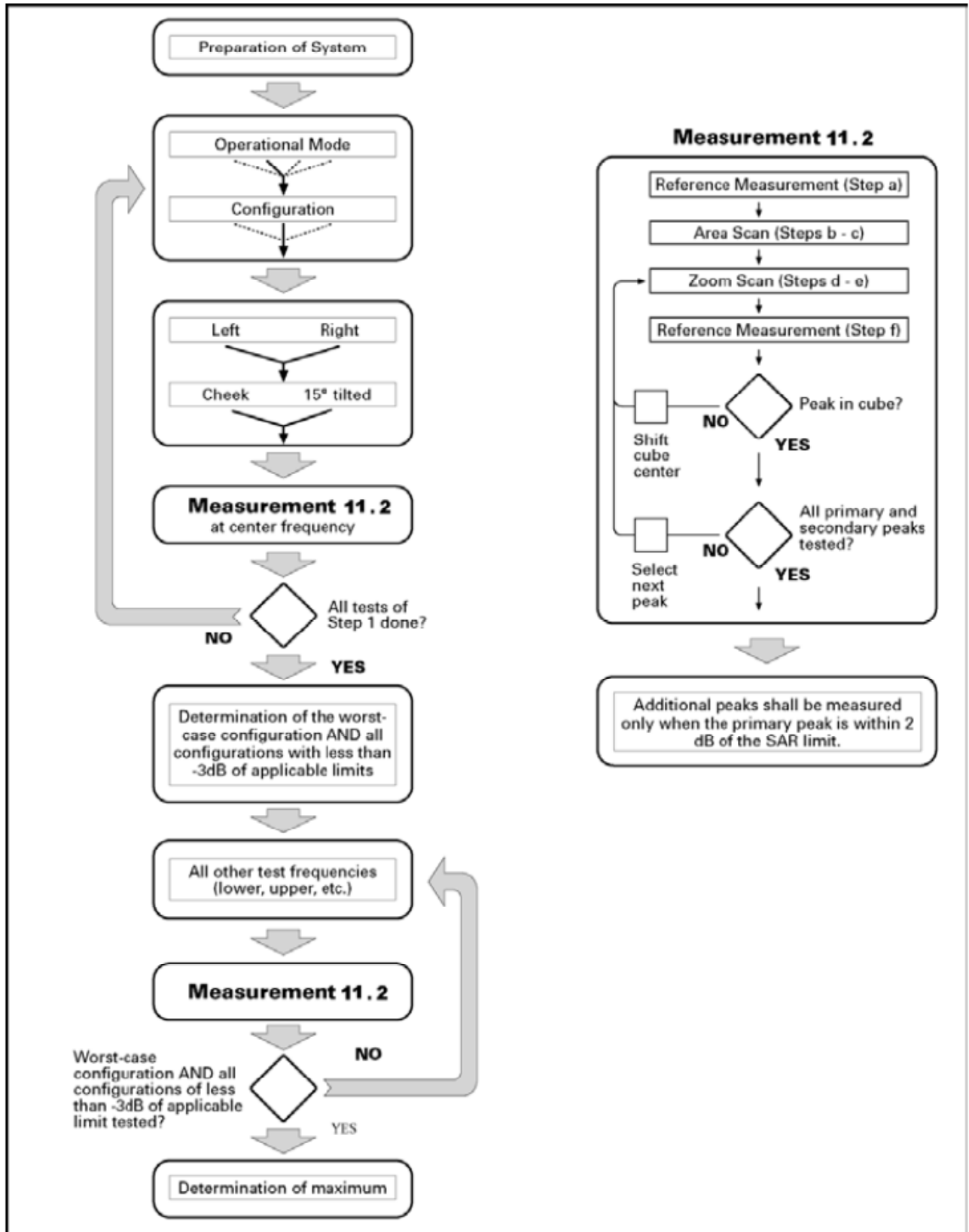

Picture 10.1 Block diagram of the tests to be performed

**4.10.2 General Measurement Procedure**

The area and zoom scan resolutions specified in the table below must be applied to the SAR measurements and fully documented in SAR reports to qualify for TCB approval. Probe boundary effect error compensation is required for measurements with the probe tip closer than half a probe tip diameter to the phantom surface. Both the probe tip diameter and sensor offset distance must satisfy measurement protocols; to ensure probe boundary effect errors are minimized and the higher fields closest to the phantom surface can be correctly measured and extrapolated to the phantom surface for computing 1-g SAR. Tolerances of the post-processing algorithms must be verified by the test laboratory for the scan resolutions used in the SAR measurements, according to the reference distribution functions specified in IEEE Std 1528-2003. The results should be documented as part of the system validation records and may be requested to support test results when all the measurement parameters in the following table are not satisfied.

		$\leq 3$ GHz	$> 3$ GHz
Maximum distance from closest measurement point (geometric center of probe sensors) to phantom surface		$5 \pm 1$ mm	$\frac{1}{2} \delta \ln(2) \pm 0.5$ mm
Maximum probe angle from probe axis to phantom surface normal at the measurement location		$30^\circ \pm 1^\circ$	$20^\circ \pm 1^\circ$
Maximum area scan spatial resolution: $\Delta x_{Area}$ , $\Delta y_{Area}$		$\leq 2$ GHz: $\leq 15$ mm 2 – 3 GHz: $\leq 12$ mm	3 – 4 GHz: $\leq 12$ mm 4 – 6 GHz: $\leq 10$ mm
		When the x or y dimension of the test device, in the measurement plane orientation, is smaller than the above, the measurement resolution must be $\leq$ the corresponding x or y dimension of the test device with at least one measurement point on the test device.	
Maximum zoom scan spatial resolution: $\Delta x_{Zoom}$ , $\Delta y_{Zoom}$		$\leq 2$ GHz: $\leq 8$ mm 2 – 3 GHz: $\leq 5$ mm*	3 – 4 GHz: $\leq 5$ mm* 4 – 6 GHz: $\leq 4$ mm*
Maximum zoom scan spatial resolution, normal to phantom surface	uniform grid: $\Delta z_{Zoom}(n)$	$\leq 5$ mm	3 – 4 GHz: $\leq 4$ mm 4 – 5 GHz: $\leq 3$ mm 5 – 6 GHz: $\leq 2$ mm
	graded grid	$\Delta z_{Zoom}(1)$ : between 1 <sup>st</sup> two points closest to phantom surface	$\leq 4$ mm
		$\Delta z_{Zoom}(n>1)$ : between subsequent points	$\leq 1.5 \Delta z_{Zoom}(n-1)$
Minimum zoom scan volume	x, y, z	$\geq 30$ mm	3 – 4 GHz: $\geq 28$ mm 4 – 5 GHz: $\geq 25$ mm 5 – 6 GHz: $\geq 22$ mm
Note: $\delta$ is the penetration depth of a plane-wave at normal incidence to the tissue medium; see draft standard IEEE P1528-2011 for details. * When zoom scan is required and the <u>reported</u> SAR from the area scan based 1-g SAR estimation procedures of KDB 447498 is $\leq 1.4$ W/kg, $\leq 8$ mm, $\leq 7$ mm and $\leq 5$ mm zoom scan resolution may be applied, respectively, for 2 GHz to 3 GHz, 3 GHz to 4 GHz and 4 GHz to 6 GHz.			

**4.10.3 GSM Test Configuration**

SAR tests for GSM 850 and GSM 1900, a communication link is set up with a System Simulator (SS) by air link. Using E5515C the power level is set to “5” for GSM 850, set to “0” for GSM 1900. Since the GPRS class is 12 for this EUT, it has at most 4 timeslots in uplink and at most 4 timeslots in downlink, the maximum total timeslots is 5. The EGPRS class is 12 for this EUT, it has at most 4 timeslots in uplink and at most 4 timeslots in downlink, the maximum total timeslots is 5.

When SAR tests for EGPRS mode is necessary, GMSK modulation should be used to minimize SAR measurement error due to higher peak-to-average power (PAR) ratios inherent in 8-PSK.

According to specification 3GPP TS 51.010, the maximum power of the GSM can do the power reduction for the multi-slot. The allowed power reduction in the multi-slot configuration is as following: Output power of reductions:

The allowed power reduction in the multi-slot configuration

Number of timeslots in uplink assignment	Permissible nominal reduction of maximum output power (dB)
1	0
2	0 to 3.0
3	1.8 to 4.8
4	3.0 to 6.0

**4.10.4 UMTS Test Configuration**

**4.10.4.1 Output power Verification**

Maximum output power is verified on the High, Middle and Low channel according to the procedures described in section 5.2 of 3GPP TS 34. 121, using the appropriate RMC or AMR with TPC(transmit power control) set to all up bits for WCDMA/HSDPA or applying the required inner loop power control procedures to the maximum output power while HSUPA is active. Results for all applicable physical channel configuration (DPCCH, DPDCH<sub>n</sub> and spreading codes, HSDPA, HSPA) should be tabulated in the SAR report. All configuration that are not supported by the DUT or can not be measured due to technical or equipment limitations should be clearly identified

**4.10.4.2 Head SAR Measurements**

SAR for head exposure configurations in voice mode is measured using a 12.2kbps RMC with TPC bits configured to all up bits. SAR in AMR configurations is not required when the maximum average output of each RF channel for 12.2kbps AMR is less than 1/4 dB higher than that measured in 12.2 kbps RMC. Otherwise, SAR is measured on the maximum output channel in 12.2kbps AMR with a 3.4 kbps SRB( Signaling radio bearer) using the exposure configuration that results in the highest SAR in 12.2kbps RMC for that RF channel.

**4.10.4.3 Body SAR Measurements**

SAR for body exposure configurations in voice and data modes is measured using 12.2kbps RMC with TPC bits configured to all up bits. SAR for other spreading codes and multiple DPDCH<sub>n</sub>, when supported by the DUT, are not required when the maximum average output of each RF channel, for each spreading code and DPDCH<sub>n</sub> configuration, are less than 1/4 dB higher than those measured in 12.2kbps RMC. Otherwise, SAR is measured on the maximum output channel with an applicable RMC configuration for the corresponding spreading code or DPDCH<sub>n</sub> using the exposure configuration that results in the highest SAR with 12.2 kbps RMC. When more than 2 DPDCH<sub>n</sub> are supported by the DUT, it may be necessary to configure additional DPDCH<sub>n</sub> for a DUT using FTM (Factory Test Mode) or other chipset based test approaches with parameters similar to those used in 384 kbps and 768 kbps RMC.

**4.10.4.4 HSDPA Test Configuration**

SAR for body exposure configurations is measured according to the 'Body SAR Measurements' procedures of that section. In addition, body SAR is also measured for HSDPA when the maximum average output of each RF channel with HSDPA active is at least ¼ dB higher than that measured without HSDPA using 12.2 kbps RMC or the maximum SAR for 12.2 kbps RMC is above 75% of the SAR limit. Body SAR for HSDPA is measured using an FRC with H-Set 1 in Sub-test 1 and a 12.2 kbps RMC configured in Test Loop Mode 1, using the highest body SAR configuration in 12.2 kbps RMC without HSDPA. HSDPA should be configured according to the UE category of a test device. The number of HSDSCH/ HS-PDSCHs, HARQ processes, minimum inter-TTI interval, transport block sizes and RV coding sequence are defined by the H-set. To maintain a consistent test configuration and stable transmission conditions, QPSK is used in the H-set for SAR testing. HS-DPCCH should be configured with a CQI feedback cycle of 4 ms with a CQI repetition factor of 2 to maintain a constant rate of active CQI slots. DPCCH and DPDCH gain factors( $\beta_c$ ,  $\beta_d$ ), and HS-DPCCH power offset parameters ( $\Delta ACK$ ,  $\Delta NACK$ ,  $\Delta CQI$ ) should be set according to values indicated in the Table below. The CQI value is determined by the UE category, transport block size, number of HS-PDSCHs and modulation used in the H-set.

Subtests for UMTS Release 5 HSDPA

Sub-set	$\beta_c$	$\beta_d$	$\beta_d$ (SF)	$\beta_c/\beta_d$	$\beta_{hs}$ (note 1, note 2)	CM(dB) (note 3)	MPR(dB)
1	2/15	15/15	64	2/15	4/15	0.0	0.0
2	12/15 (note 4)	15/15 (note 4)	64	2/15 (note 4)	24/15	1.0	0.0
3	15/15	8/15	64	2/15	30/15	1.5	0.5
4	15/15	4/15	64	2/15	30/15	1.5	0.5

Note1:  $\Delta ACK, \Delta NACK$  and  $\Delta CQI = 8, A_{hs} = \beta_{hs}/\beta_c = 30/15, \beta_{hs} = 30/15 * \beta_c$   
 Note2: For the HS-DPCCH power mask requirement test in clause 5.2C, 5.7A, and the Error Vector Magnitude (EVM) with HS-DPCCH test in clause 5.13.1.A, and HSDPA EVM with phase discontinuity in clause 5.13.1AA,  $\Delta ACK$  and  $\Delta NACK = 8 (A_{hs} = 30/15)$  with  $\beta_{hs} = 30/15 * \beta_c$ , and  $\Delta CQI = 7 (A_{hs} = 24/15)$  with  $\beta_{hs} = 24/15 * \beta_c$ .  
 Note3:  $CM = 1$  for  $\beta_c/\beta_d = 12/15, \beta_{hs}/\beta_c = 24/15$ . For all other combinations of DPDCH, DPCCH and HS-DPCCH the MPR is based on the relative CM difference. This is applicable for only UEs that support HSDPA in release 6 and later releases.  
 Note 4: For subtest 2 the  $\beta_c/\beta_d$  ratio of 12/15 for the TFC during the measurement period (TF1, TF0) is achieved by setting the signaled gain factors for the reference TFC (TFC1, TF1) to  $\beta_c = 11/15$  and  $\beta_d = 15/15$ .

Settings of required H-Set 1 QPSK in HSDPA mode

Parameter	Unit	Value
Nominal Avg. Inf. Bit Rate	kbps	534
Inter-TTI Distance	TTI's	3
Number of HARQ Processes	Processes	2
Information Bit Payload ( $N_{INF}$ )	Bits	3202
Number Code Blocks	Blocks	1
Binary Channel Bits Per TTI	Bits	4800
Total Available SML's in UE	SML's	19200
Number of SML's per HARQ Proc.	SML's	9600
Coding Rate	/	0.67
Number of Physical Channel Codes	Codes	5
Modulation	/	QPSK

**4.10.4.5 HSUPA Test Configuration**

Body SAR is also measured for HSPA when the maximum average output of each RF channel with HSPA active is at least ¼ dB higher than that measured without HSPA using 12.2 kbps RMC or the maximum SAR for 12.2 kbps RMC is above 75% of the SAR limit. Body SAR for HSPA is measured with E-DCH Sub-test 5, using H-Set 1 and QPSK for FRC and a 12.2 kbps RMC configured in Test Loop Mode 1 with power control algorithm 2, according to the highest body SAR configuration in 12.2 kbps RMC without HSPA. Due to inner loop power control requirements in HSPA, a commercial communication test set should be used for the output power and SAR tests. The 12.2 kbps RMC, FRC H-set 1 and E- DCH configurations for HSPA should be configured according to the  $\beta$  values indicated below as well as other applicable procedures described in the 'WCDMA Handset' and 'Release 5 HSDPA Data Devices' sections of 3 G device.

HSUPA UE category

UE E-DCH Category	Maximum E-DCH Codes Transmitted	Number of HARQ Processes	E- DCH TTI (ms)	Minimum Spreading Factor	Maximum E-DCH Transport Block Bits	Max Rate (Mbps)
1	1	4	10	4	7110	0.7296
2	2	8	2	4	2798	1.4592
	2	4	10	4	14484	
3	2	4	10	4	14484	1.4592
4	2	8	10	2	5772	2.9185
	2	4	10	2	20000	2.00
5	2	4	10	2	20000	2.00
6 (No DPDCH)	4	8	2	2 SF2 & 2	11484	5.76
	4	4	10	SF4	20000	2.00
7 (No DPDCH)	4	8	2	2 SF2 & 2	22996	?
	4	4	10	SF4	20000	?

NOTE: When 4 codes are transmitted in parallel, two codes shall be transmitted with SF2 and two with SF4. UE Categories 1 to 6 supports QPSK only. UE Category 7 supports QPSK and 16QAM. (TS25.306-7.3.0)

**4.10.5 Wi-Fi Test Configuration**

For WLAN SAR testing, WLAN engineering testing software installed on the DUT can provide continuous transmitting RF signal. The Tx power is set to 23 for 802.11 b mode, set to 19 for 802.11 g mode, set to 19 for 802.11 n mode by software, This RF signal utilized in SAR measurement has almost 100% duty cycle and its crest factor is 1.

For the 802.11b/g/n SAR tests, a communication link is set up with the test mode software for WIFI mode test. During the test, at the each test frequency channel, the EUT is operated at the RF continuous emission mode. Each channel should be tested at the highest power rate.

802.11b/g/n operating modes are tested independently according to the service requirements in each frequency band. 802.11b/g/n modes are tested on the maximum average output channel;

SAR is not required for 802.11g/n channels when the maximum average output power is less than 0.25dB higher than that measured on the corresponding 802.11b channels.

#### **4.10.6 BT Test Configuration**

For BT SAR testing, BT engineering testing software installed on the EUT can provide continuous transmitting RF signal with maximum output power. This RF signal utilized in SAR measurement has Almost 100% duty cycle and its crest factor is 1.

#### **4.10.7 Power Drift**

To control the output power stability during the SAR test, DASY5 system calculates the power drift by measuring the E-field at the same location at the beginning and at the end of the measurement for each test position. These drift values can be found in Table 14.1 to Table 14.11 labeled as: (Power Drift [dB]). This ensures that the power drift during one measurement is within 5%.

#### **4.10.8 Area Scan Based 1-g SAR**

##### **4.10.8.1 Requirement of KDB**

According to the KDB447498 D01 v05, when the implementation is based the specific polynomial fit algorithm as presented at the 29th Bioelectromagnetics Society meeting (2007) and the estimated 1-g SAR is  $\leq 1.2$  W/kg, a zoom scan measurement is not required provided it is also not needed for any other purpose; for example, if the peak SAR location required for simultaneous transmission SAR test exclusion can be determined accurately by the SAR system or manually to discriminate between distinctive peaks and scattered noisy SAR distributions from area scans.

There must not be any warning or alert messages due to various measurement concerns identified by the SAR system; for example, noise in measurements, peaks too close to scan boundary, peaks are too sharp, spatial resolution and uncertainty issues etc. The SAR system verification must also demonstrate that the area scan estimated 1-g SAR is within 3% of the zoom scan 1-g SAR (See Annex B). When all the SAR results for each exposure condition in a frequency band and wireless mode are based on estimated 1-g SAR, the 1-g SAR for the highest SAR configuration must be determined by a zoom scan.

##### **4.10.8.2 Fast SAR Algorithms**

The approach is based on the area scan measurement applying a frequency dependent attenuation parameter. This attenuation parameter was empirically determined by analyzing a large number of phones. The MOTOROLA FAST SAR was developed and validated by the MOTOROLA Research Group in Ft. Lauderdale.

In the initial study, an approximation algorithm based on Linear fit was developed. The accuracy of the algorithm has been demonstrated across a broad frequency range (136-2450 MHz) and for both 1- and 10-g averaged SAR using a sample of 264 SAR measurements from 55 wireless handsets. For the sample size studied, the root-mean-squared errors of the algorithm are 1.2% and 5.8% for 1- and 10-g averaged SAR, respectively

In the second step, the same research group optimized the fitting algorithm to an Polynomial fit whereby the frequency validity was extended to cover the range 30-6000MHz. Details of this study can be found in the BEMS 2007 Proceedings.

Both algorithms are implemented in DASY software.

## 5. TEST CONDITIONS AND RESULTS

### 5.1. Conducted Power Results

Max Conducted power measurement results and power drift from tune-up tolerance provide by manufacturer:

The conducted power measurement results for GSM850/PCS1900

Test Mode	Conducted Power (dBm)		
	Channel 251(848.8MHz)	Channel 190(836.6MHz)	Channel 128(824.2MHz)
GSM850	33.48	33.42	33.41
PCS1900	Channel 810(1909.8MHz)	Channel 661 (1880.0MHz)	Channel 512(1850.2MHz)
	31.48	30.84	30.52

The conducted power measurement results for GPRS/ EGPRS

Test Mode	Measured Power (dBm)			Calculation (dB)	Averaged Power (dBm)			
	Test Channel				Test Channel			
GSM 850 GPRS (GMSK)		128	190	251		128	190	251
	1 Txslot	33.25	33.34	33.64	-9.03	24.22	24.31	24.61
	2 Txslot	31.65	31.91	31.54	-6.02	25.63	25.89	25.52
	3 Txslot	29.27	29.23	29.27	-4.26	25.01	24.97	25.01
	4 Txslot	27.08	27.04	27.03	-3.01	24.07	24.03	24.02
Test Mode	Measured Power (dBm)			Calculation (dB)	Averaged Power (dBm)			
	Test Channel				Test Channel			
GSM 850 EGPRS (GMSK)		128	190	251		128	190	251
	1 Txslot	33.42	33.48	33.38	-9.03	24.39	24.45	24.35
	2 Txslot	31.74	31.63	31.81	-6.02	25.72	25.61	25.79
	3 Txslot	29.27	29.18	29.16	-4.26	25.01	24.92	24.90
	4 Txslot	26.82	26.75	26.87	-3.01	23.81	23.74	23.86
Test Mode	Measured Power (dBm)			Calculation (dB)	Averaged Power (dBm)			
	Test Channel				Test Channel			
DCS1900 GPRS (GMSK)		512	661	810		512	661	810
	1 Txslot	30.21	30.42	30.24	-9.03	21.18	21.39	21.21
	2 Txslot	28.24	28.57	28.22	-6.02	22.22	22.55	22.20
	3 Txslot	26.57	26.72	26.46	-4.26	22.31	22.46	22.20
	4 Txslot	24.12	24.14	24.14	-3.01	21.11	21.13	21.13
Test Mode	Measured Power (dBm)			Calculation (dB)	Averaged Power (dBm)			
	Test Channel				Test Channel			
DCS1900 EGPRS (GMSK)		512	661	810		512	661	810
	1 Txslot	30.24	30.37	31.32	-9.03	21.21	21.34	22.29
	2 Txslot	28.44	28.56	28.33	-6.02	22.42	22.54	22.31
	3 Txslot	26.56	26.45	26.36	-4.26	22.30	22.19	22.10
	4 Txslot	24.08	24.02	24.04	-3.01	21.07	21.01	21.03

#### NOTES:

##### 1) Division Factors

To average the power, the division factor is as follows:

1TX-slot = 1 transmit time slot out of 8 time slots=> conducted power divided by (8/1) => -9.03dB

2TX-slots = 2 transmit time slots out of 8 time slots=> conducted power divided by (8/2) => -6.02dB

3TX-slots = 3 transmit time slots out of 8 time slots=> conducted power divided by (8/3) => -4.26dB

4TX-slots = 4 transmit time slots out of 8 time slots=> conducted power divided by (8/4) => -3.01dB

According to the conducted power as above, the body measurements are performed with 4Txslots for GSM850 and GSM1900.

Note: According to the KDB941225 D03, "when SAR tests for EDGE or EGPRS mode is necessary, GMSK modulation should be used".

**The conducted power measurement results for WCDMA**

Item	band	FDD Band V result (dBm)			FDD Band II result (dBm)		
		Test Channel			Test Channel		
	ARFCN	4132	4183	4233	9262	9400	9538
5.2(WCDMA)	\	22.37	22.46	22.64	22.48	22.64	22.52
5.2AA (HSDPA)	1	22.24	22.26	22.43	22.25	22.43	22.44
	2	22.33	22.18	22.26	22.14	22.35	22.23
	3	22.15	22.33	22.14	22.17	22.36	22.42
	4	22.37	22.19	22.36	22.29	22.13	22.24
5.2B (HSUPA)	1	22.43	22.33	22.28	22.12	22.13	22.28
	2	22.19	22.49	22.49	22.29	22.15	22.16
	3	22.03	22.19	22.22	22.25	22.03	22.08
	4	22.18	22.26	22.48	22.14	22.14	22.16
	5	22.23	22.14	22.13	22.17	22.18	22.19

Note: HSUPA body SAR are not required, because maximum average output power of each RF channel with HSDPA active is not 1/4 dB higher than that measured without HSUPA and the maximum SAR for WCDMA850 and WCDMA1900 are not above 75% of the SAR limit.

**The conducted power measurement results for WLAN**

Mode	Channel	Frequency (MHz)	Conducted Output Power		Test Rate Data
			(dBm)	(mW)	
802.11b	1	2412	17.98	62.81	1 Mbps
	7	2442	18.77	75.34	1 Mbps
	13	2472	18.96	78.70	1 Mbps
802.11g	1	2412	11.14	13.00	6 Mbps
	7	2442	13.80	23.99	6 Mbps
	13	2472	13.48	22.28	6 Mbps
802.11n(20MHz)	1	2412	10.25	10.59	6.5 Mbps
	7	2442	10.65	11.61	6.5 Mbps
	13	2472	12.24	16.75	6.5 Mbps

**Note:** 1.The output power was test all data rate and recorded worst case at recorded data rate.

**Bluetooth v2.1+EDR**

Mode	Channel	Frequency (MHz)	Conducted Peak Output Power (dBm)
GFSK	00	2402	7.95
	39	2441	8.39
	78	2480	8.51
π/4DQPSK	00	2402	7.30
	39	2441	7.73
	78	2480	7.84
8DPSK	00	2402	7.29
	39	2441	7.71
	78	2480	7.85

**Manufacturing tolerance**

**GSM Speech**

GSM 850			
Channel	Channel 251	Channel 190	Channel 190
Target (dBm)	33.0	33.0	33.0
Tolerance ±(dB)	1	1	1
GSM 1900			
Channel	Channel 810	Channel 661	Channel 512
Target (dBm)	31.0	31.0	31.0
Tolerance ±(dB)	1	1	1

**GPRS/EGPRS (GMSK Modulation)**

<b>GSM 850 GPRS</b>				
Channel		251	190	128
1 Txslot	Target (dBm)	33.0	33.0	33.0
	Tolerance ±(dB)	1	1	1
2 Txslot	Target (dBm)	31.5	31.5	31.5
	Tolerance ±(dB)	1	1	1
3 Txslot	Target (dBm)	29.5	29.5	29.5
	Tolerance ±(dB)	1	1	1
4 Txslot	Target (dBm)	27.0	27.0	27.0
	Tolerance ±(dB)	1	1	1
<b>GSM 850 EGPRS</b>				
Channel		251	190	128
1 Txslot	Target (dBm)	33.0	33.0	33.0
	Tolerance ±(dB)	1	1	1
2 Txslot	Target (dBm)	31.5	31.5	31.5
	Tolerance ±(dB)	1	1	1
3 Txslot	Target (dBm)	29.5	29.5	29.5
	Tolerance ±(dB)	1	1	1
4 Txslot	Target (dBm)	27.0	27.0	27.0
	Tolerance ±(dB)	1	1	1
<b>GSM 1900 GPRS</b>				
Channel		810	661	512
1 Txslot	Target (dBm)	30.0	30.0	30.0
	Tolerance ±(dB)	1	1	1
2 Txslot	Target (dBm)	28.5	28.5	28.5
	Tolerance ±(dB)	1	1	1
3 Txslot	Target (dBm)	27.0	27.0	27.0
	Tolerance ±(dB)	1	1	1
4 Txslot	Target (dBm)	24.5	24.5	24.5
	Tolerance ±(dB)	1	1	1
<b>GSM 1900 EGPRS</b>				
Channel		810	661	512
1 Txslot	Target (dBm)	30.0	30.0	30.0
	Tolerance ±(dB)	1	1	1
2 Txslot	Target (dBm)	28.5	28.5	28.5
	Tolerance ±(dB)	1	1	1
3 Txslot	Target (dBm)	27.0	27.0	27.0
	Tolerance ±(dB)	1	1	1
4 Txslot	Target (dBm)	24.5	24.5	24.5
	Tolerance ±(dB)	1	1	1

**WCDMA**

<b>WCDMA Band V</b>				
Channel	Channel 4132	Channel 4183	Channel 4233	
Target (dBm)	23.0	23.0	23.0	
Tolerance ±(dB)	1	1	1	
<b>WCDMA Band V HSDPA(sub-test 1)</b>				
Channel	Channel 4132	Channel 4183	Channel 4233	
Target (dBm)	23.0	23.0	23.0	
Tolerance ±(dB)	1	1	1	
<b>WCDMA Band V HSDPA(sub-test 2)</b>				
Channel	Channel 4132	Channel 4183	Channel 4233	
Target (dBm)	23.0	23.0	23.0	
Tolerance ±(dB)	1	1	1	
<b>WCDMA Band V HSDPA(sub-test 3)</b>				
Channel	Channel 4132	Channel 4183	Channel 4233	
Target (dBm)	23.0	23.0	23.0	
Tolerance ±(dB)	1	1	1	
<b>WCDMA Band V HSDPA(sub-test 4)</b>				
Channel	Channel 4132	Channel 4183	Channel 4233	
Target (dBm)	23.0	23.0	23.0	



Tolerance ±(dB)	1	1	1
<b>WCDMA Band V HSUPA(sub-test 1)</b>			
Channel	Channel 4132	Channel 4183	Channel 4233
Target (dBm)	23.0	23.0	23.0
Tolerance ±(dB)	1	1	1
<b>WCDMA Band V HSUPA(sub-test 2)</b>			
Channel	Channel 4132	Channel 4183	Channel 4233
Target (dBm)	23.0	23.0	23.0
Tolerance ±(dB)	1	1	1
<b>WCDMA Band V HSUPA(sub-test 3)</b>			
Channel	Channel 4132	Channel 4183	Channel 4233
Target (dBm)	23.0	23.0	23.0
Tolerance ±(dB)	1	1	1
<b>WCDMA Band V HSUPA(sub-test 4)</b>			
Channel	Channel 4132	Channel 4183	Channel 4233
Target (dBm)	23.0	23.0	23.0
Tolerance ±(dB)	1	1	1
<b>WCDMA Band V HSUPA(sub-test 5)</b>			
Channel	Channel 4132	Channel 4183	Channel 4233
Target (dBm)	23.0	23.0	23.0
Tolerance ±(dB)	1	1	1
<b>WCDMA Band II</b>			
Channel	Channel 9262	Channel 9400	Channel 9538
Target (dBm)	23.0	23.0	23.0
Tolerance ±(dB)	1	1	1
<b>WCDMA Band II HSDPA(sub-test 1)</b>			
Channel	Channel 9262	Channel 9400	Channel 9538
Target (dBm)	23.0	23.0	23.0
Tolerance ±(dB)	1	1	1
<b>WCDMA Band II HSDPA(sub-test 2)</b>			
Channel	Channel 9262	Channel 9400	Channel 9538
Target (dBm)	23.0	23.0	23.0
Tolerance ±(dB)	1	1	1
<b>WCDMA Band II HSDPA(sub-test 3)</b>			
Channel	Channel 9262	Channel 9400	Channel 9538
Target (dBm)	23.0	23.0	23.0
Tolerance ±(dB)	1	1	1
<b>WCDMA Band II HSDPA(sub-test 4)</b>			
Channel	Channel 9262	Channel 9400	Channel 9538
Target (dBm)	23.0	23.0	23.0
Tolerance ±(dB)	1	1	1
<b>WCDMA Band II HSUA(sub-test 1)</b>			
Channel	Channel 9262	Channel 9400	Channel 9538
Target (dBm)	23.0	23.0	23.0
Tolerance ±(dB)	1	1	1
<b>WCDMA Band II HSUA(sub-test 2)</b>			
Channel	Channel 9262	Channel 9400	Channel 9538
Target (dBm)	23.0	23.0	23.0
Tolerance ±(dB)	1	1	1
<b>WCDMA Band II HSUA(sub-test 3)</b>			
Channel	Channel 9262	Channel 9400	Channel 9538
Target (dBm)	23.0	23.0	23.0
Tolerance ±(dB)	1	1	1
<b>WCDMA Band II HSUA(sub-test 4)</b>			
Channel	Channel 9262	Channel 9400	Channel 9538
Target (dBm)	23.0	23.0	23.0
Tolerance ±(dB)	1	1	1
<b>WCDMA Band II HSUA(sub-test 5)</b>			
Channel	Channel 9262	Channel 9400	Channel 9538
Target (dBm)	23.0	23.0	23.0
Tolerance ±(dB)	1	1	1

**WLAN2450**

802.11b			
Channel	Channel 00	Channel 41	Channel 79
Target (dBm)	18.0	18.0	18.0
Tolerance ±(dB)	2	2	2
802.11g			
Channel	Channel 00	Channel 41	Channel 79
Target (dBm)	13.0	13.0	13.0
Tolerance ±(dB)	2	2	2
802.11n(20MHz)			
Channel	Channel 00	Channel 41	Channel 79
Target (dBm)	11.0	11.0	11.0
Tolerance ±(dB)	2	2	2

**Bluetooth v2.1+EDR**

GFSK			
Channel	Channel 00	Channel 41	Channel 79
Target (dBm)	8.0	8.0	8.0
Tolerance ±(dB)	1	1	1
8DPSK			
Channel	Channel 00	Channel 41	Channel 79
Target (dBm)	7.0	7.0	7.0
Tolerance ±(dB)	1	1	1
π/4DQPSK			
Channel	Channel 00	Channel 41	Channel 79
Target (dBm)	7.0	7.0	7.0
Tolerance ±(dB)	1	1	1

**5.2. Simultaneous TX SAR Considerations**

**5.2.1 Introduction**

The following procedures adopted from “FCC SAR Considerations for Cell Phones with Multiple Transmitters” are applicable to handsets with built-in unlicensed transmitters such as 802.11 a/b/g and Bluetooth devices which may simultaneously transmit with the licensed transmitter.

For the DUT, the BT module has a antenna; GSM and WCDMA module sharing same antenna, So we can get following combination that can transmit signal simultaneously.

Air-Interface	Band (MHz)	Type	Simultaneous Transmissions	Voice over Digital Transport(Data)
GSM	850	VO	Yes,WLAN or BT	N/A
	1900	VO		
	GPRS/EGPRS	DT		
WCDMA	Band II/Band V	DT	Yes,WLAN or BT	N/A
WLAN	2450	DT	Yes,GSM,GPRS,EGPRS,WCDMA	N/A
BT	2441	DT	Yes,GSM,GPRS,EGPRS,WCDMA	N/A

Note:VO-Voice Service only;DT-Digital Transport

**5.2.2 Transmit Antenna Separation Distances**

The product can support Bluetooth function, according to following picture 1 showed that the antenna position of the DUT. So according to KDB 616217 and KDB447498 for SAR testing.

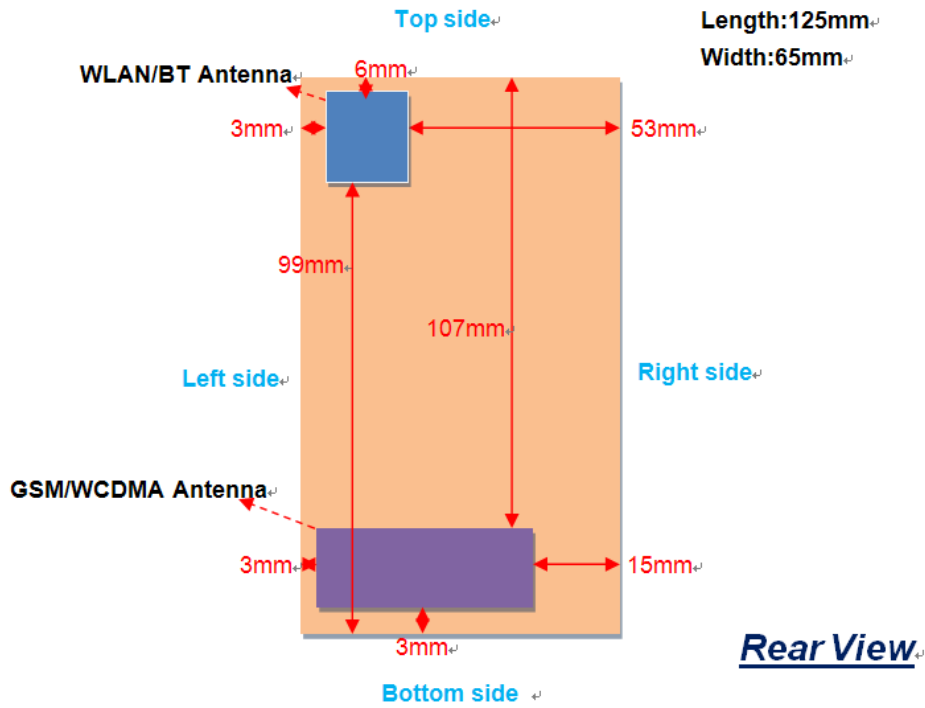

Figure 1: The antenna positions of the DUT

WWAN	WCDMA/GSM Antenna
WLAN/BT	WLAN/BT Antenna

**5.2.2 SAR Measurement Positions**

According to KDB941225, SAR must be measured for all sides (edges) and surfaces with a transmitting antenna located at  $\leq 25$  mm from that surface or edge.

**5.2.3 Standalone SAR Test Exclusion Considerations**

Standalone 1-g head or body SAR evaluation by measurement or numerical simulation is not required when the corresponding SAR Exclusion Threshold condition, listed below, is satisfied.

The 1-g SAR test exclusion threshold for 100 MHz to 6 GHz at test separation distances  $\leq 50$  mm are determined by:

$$[(\text{max. power of channel, including tune-up tolerance, mW}) / (\text{min. test separation distance, mm})] \cdot [\sqrt{f(\text{GHz})}] \leq 3.0 \text{ for 1-g SAR, where}$$

- f(GHz) is the RF channel transmit frequency in GHz
- Power and distance are rounded to the nearest mW and mm before calculation
- The result is rounded to one decimal place for comparison

Appendix A

SAR Test Exclusion Thresholds for 100 MHz – 6 GHz and ≤ 50 mm

Approximate SAR Test Exclusion Power Thresholds at Selected Frequencies and Test Separation Distances are illustrated in the following Table.

MHz	5	10	15	20	25	mm
150	39	77	116	155	194	SAR Test Exclusion Threshold (mW)
300	27	55	82	110	137	
450	22	45	67	89	112	
835	16	33	49	66	82	
900	16	32	47	63	79	
1500	12	24	37	49	61	
1900	11	22	33	44	54	
2450	10	19	29	38	48	
3600	8	16	24	32	40	
5200	7	13	20	26	33	
5400	6	13	19	26	32	
5800	6	12	19	25	31	

Picture 12.2 Power Thresholds

5.2.4 Estimated SAR

When standalone SAR is not required to be measured per FCC KDB 447498 D01, the following equation must be used to estimate the standalone 1g SAR for simultaneous transmission assessment involving that transmitter.

$$\text{Estimated SAR} = \frac{(\text{max. power of channel, including tune-up tolerance, mW}) * \sqrt{f(\text{GHz})}}{(\text{min. test separation distance, mm}) * 7.5}$$

Per FCC KD B447498 D01, simultaneous transmission SAR test exclusion may be applied when the sum of the 1-g SAR for all the transmitting antenna in a specific a physical test configuration is ≤ 1.6 W/Kg. When the sum is greater than the SAR limit, SAR test exclusion is determined by the SAR to peak location separation ratio.

$$\text{Ratio} = \frac{(\text{SAR}_1 + \text{SAR}_2)^{1.5}}{(\text{peak location separation, mm})} < 0.04$$

For Bluetooth, the Estimated SAR for Head at 5mm for estimate and 10mm to Estimated Body SAR

**Estimated SAR<sub>Head</sub> = ((7.10mW)/5mm) \* (1.5627/7.5) = 0.296W/Kg**

**Estimated SAR<sub>Body</sub> = ((7.10mW)/10mm) \* (1.5627/7.5) = 0.148W/Kg**

5.2.5 Evaluation of Simultaneous SAR

GSM/WCDMA & WLAN Mode

Test Position	GSM850 Reported SAR1g (W/Kg)	PCS1900 Reported SAR1g (W/Kg)	WCDMA Band V Reported SAR1g (W/Kg)	WCDMA Band II Reported SAR1g (W/Kg)	WLAN Reported SAR1g (W/Kg)	Summation Reported SAR(1g) (W/kg)	Simultaneous Measurement Required?
Left Head Touch	0.364	<b>0.308</b>	<b>0.266</b>	0.212	0.227	0.591	No
Left Head Title	<b>0.382</b>	0.286	0.252	0.204	0.247	0.629	No
Right Head Touch	0.341	0.255	0.233	0.220	0.287	0.628	No
Right Head Title	0.323	0.270	0.245	<b>0.246</b>	<b>0.309</b>	<b>0.632</b>	No
Body-Back Side	<b>0.569</b>	<b>0.587</b>	<b>0.552</b>	<b>0.360</b>	<b>0.418</b>	<b>1.005</b>	No
Body-Left Side	0.388	0.370	0.39	0.24	0.37	0.762	No
Body-Right Side	0.347	0.326	0.375	0.210	---	--	No
Body-Bottom Side	0.416	0.482	0.440	0.267	---	--	No

**GSM/WCDMA & BT Mode**

Test Position	GSM850 Reported SAR1g (W/Kg)	PCS1900 Reported SAR1g (W/Kg)	WCDMA Band V Reported SAR1g (W/Kg)	WCDMA Band II Reported SAR1g (W/Kg)	Bluetooth Estimated SAR (W/Kg)	Summation Reported SAR(1g) (W/kg)	Simultaneous Measurement Required?
Left Head Touch	0.364	<b>0.308</b>	<b>0.266</b>	0.212	0.296	0.660	No
Left Head Title	<b>0.382</b>	0.286	0.252	0.204	0.296	<b>0.678</b>	No
Right Head Touch	0.341	0.255	0.233	0.220	0.296	0.637	No
Right Head Title	0.323	0.270	0.245	<b>0.246</b>	0.296	0.619	No
Body-Back Side	<b>0.569</b>	<b>0.587</b>	<b>0.552</b>	<b>0.360</b>	0.148	<b>0.735</b>	No
Body-Left Side	0.388	0.370	0.392	0.247	0.148	0.540	No
Body-Right Side	0.347	0.326	0.375	0.210	0.148	0.523	No
Body-Bottom Side	0.416	0.482	0.440	0.267	0.148	0.630	No

Note:1. The value with green color is the maximum values of standalone  
 2. The value with blue color is the maximum values of ΣSAR<sub>1g</sub>  
 3. Body-Rear side values was the maximum values of GPRS,EDGE and Speech with Headset.

**5.3. SAR Measurement Results**

It is determined by user manual for the distance between the EUT and the phantom bottom.The distance is 5mm and just applied to the condition of body worn accessory.

The calculated SAR is obtained by the following formula:  
 Reported SAR=Measured SAR\*10<sup>(P<sub>target</sub>-P<sub>measured</sub>)/10</sup>  
 Scaling factor=10<sup>(P<sub>target</sub>-P<sub>measured</sub>)/10</sup>  
 Reported SAR= Measured SAR\* Scaling factor

Where P<sub>target</sub> is the power of manufacturing upper limit;  
 P<sub>measured</sub> is the measured power;  
 Measured SAR is measured SAR at measured power which including power drift)  
 Reported SAR which including Power Drift and Scaling factor

**Duty Cycle**

Test Mode	Duty Cycle
Speech for GSM850/1900	1:8.3
GPRS for GSM850/1900	1:2
WCDMA 850/1900	1:1
WiFi 2450	1:1

**SAR Values (GSM850-Head)**

Test Frequency		Side	Test Position	Maximum Allowed Power (dBm)	Conducted Power (dBm)	Measurement SAR over 1g(W/kg)	Power drift	Scaling Factor	Reported SAR over 1g(W/kg)	SAR limit 1g (W/kg)	Ref. Plot #
Ch	MHz										
190	836.60	Left	Touch	34.00	33.42	0.319	-0.10	1.14	0.364	1.60	--
190	836.60	Left	Tilt	34.00	33.42	<b>0.335</b>	<b>-0.06</b>	<b>1.14</b>	<b>0.382</b>	1.60	1
190	836.60	Right	Touch	34.00	33.42	0.299	-0.04	1.14	0.341	1.60	--
190	836.60	Right	Tilt	34.00	33.42	0.283	-0.06	1.14	0.323	1.60	--

**SAR Values (GSM850-Body)**

Test Frequency		Mode (number of timeslots)	Test Position	Maximum Allowed Power (dBm)	Conducted Power (dBm)	Measurement SAR over 1g(W/kg)	Power drift	Scaling Factor	Reported SAR over 1g(W/kg)	SAR limit 1g (W/kg)	Ref. Plot #
Ch	MHz										
190	836.60	GPRS (2)	Back	32.50	31.91	<b>0.495</b>	<b>-0.13</b>	<b>1.15</b>	<b>0.569</b>	1.60	2
190	836.60	GPRS (2)	Front	32.50	31.91	0.423	-0.01	1.15	0.486	1.60	--
190	836.60	GPRS (2)	Left	32.50	31.91	0.337	-0.07	1.15	0.388	1.60	--
190	836.60	GPRS (2)	Right	32.50	31.91	0.302	-0.08	1.15	0.347	1.60	--
190	836.60	GPRS (2)	Bottom	32.50	31.91	0.362	-0.04	1.15	0.416	1.60	--
190	836.60	EGPRS (2)	Rear	32.50	31.63	0.442	-0.15	1.22	0.539	1.60	--

Note: 1. The distance between the EUT and the phantom bottom is 10mm.  
 2. According to KDB447498, When the 1-g SAR for the mid-band channel, or the channel with highest output power satisfy the following conditions, testing of the other channels in the band is not required.  
 ≤0.8W/Kg and transmission band ≤100MHz;  
 ≤0.6W/Kg and 100MHz ≤transmission band ≤200MHz;  
 ≤0.4W/Kg and transmission band >200MHz

**SAR Values (PCS1900-Head)**

Test Frequency		Side	Test Position	Maximum Allowed Power (dBm)	Conducted Power (dBm)	Measurement SAR over 1g(W/kg)	Power drift	Scaling Factor	Reported SAR over 1g(W/kg)	SAR limit 1g (W/kg)	Ref. Plot #
Ch	MHz										
661	1880.0	Left	Touch	32.00	30.84	0.235	-0.07	1.31	0.308	1.60	3
661	1880.0	Left	Tilt	32.00	30.84	0.218	-0.11	1.31	0.286	1.60	--
661	1880.0	Right	Touch	32.00	30.84	0.195	-0.04	1.31	0.255	1.60	--
661	1880.0	Right	Tilt	32.00	30.84	0.206	-0.13	1.31	0.270	1.60	--

**SAR Values (PCS1900-Body)**

Test Frequency		Mode (number of timeslots)	Test Position	Maximum Allowed Power (dBm)	Conducted Power (dBm)	Measurement SAR over 1g(W/kg)	Power drift	Scaling Factor	Reported SAR over 1g(W/kg)	SAR limit 1g (W/kg)	Ref. Plot #
Ch	MHz										
661	1880.0	GPRS (2)	Back	29.50	28.57	0.473	-0.11	1.24	0.587	1.60	4
661	1880.0	GPRS (2)	Front	29.50	28.57	0.394	-0.02	1.24	0.489	1.60	--
661	1880.0	GPRS (2)	Left	29.50	28.57	0.298	-0.16	1.24	0.370	1.60	--
661	1880.0	GPRS (2)	Right	29.50	28.57	0.263	-0.07	1.24	0.326	1.60	--
661	1880.0	GPRS (2)	Bottom	29.50	28.57	0.389	-0.11	1.24	0.482	1.60	--
661	1880.0	EGPRS (2)	Rear	29.50	28.56	0.415	-0.15	1.24	0.515	1.60	--

Note: 1. The distance between the EUT and the phantom bottom is 10mm.

2. According to KDB447498, When the 1-g SAR for the mid-band channel, or the channel with highest output power satisfy the following conditions, testing of the other channels in the band is not required.

$\leq 0.8\text{W/Kg}$  and transmission band  $\leq 100\text{MHz}$ ;

$\leq 0.6\text{W/Kg}$  and  $100\text{MHz} \leq \text{transmission band} \leq 200\text{MHz}$ ;

$\leq 0.4\text{W/Kg}$  and transmission band  $> 200\text{MHz}$

**SAR Values (WCDMA Band V-Head)**

Test Frequency		Side	Test Position	Maximum Allowed Power (dBm)	Conducted Power (dBm)	Measurement SAR over 1g(W/kg)	Power drift	Scaling Factor	Reported SAR over 1g(W/kg)	SAR limit 1g (W/kg)	Ref. Plot #
Ch	MHz										
4182	836.40	Left	Touch	24.00	22.46	0.186	-0.08	1.43	0.266	1.60	5
4182	836.40	Left	Tilt	24.00	22.46	0.176	-0.09	1.43	0.252	1.60	--
4182	836.40	Right	Touch	24.00	22.46	0.163	-0.11	1.43	0.233	1.60	--
4182	836.40	Right	Tilt	24.00	22.46	0.171	-0.06	1.43	0.245	1.60	--

**SAR Values (WCDMA Band V-Body)**

Test Frequency		Mode (number of timeslots)	Test Position	Maximum Allowed Power (dBm)	Conducted Power (dBm)	Measurement SAR over 1g(W/kg)	Power drift	Scaling Factor	Reported SAR over 1g(W/kg)	SAR limit 1g (W/kg)	Ref. Plot #
Ch	MHz										
4182	836.40	RMC	Back	24.00	22.46	0.386	-0.05	1.43	0.552	1.60	6
4182	836.40	RMC	Front	24.00	22.46	0.314	-0.07	1.43	0.449	1.60	--
4182	836.40	RMC	Left	24.00	22.46	0.274	-0.11	1.43	0.392	1.60	--
4182	836.40	RMC	Right	24.00	22.46	0.262	-0.06	1.43	0.375	1.60	--
4182	836.40	RMC	Bottom	24.00	22.46	0.308	-0.03	1.43	0.440	1.60	--

Note: 1. The distance between the EUT and the phantom bottom is 10mm.

2. According to KDB447498, When the 1-g SAR for the mid-band channel, or the channel with highest output power satisfy the following conditions, testing of the other channels in the band is not required.

$\leq 0.8\text{W/Kg}$  and transmission band  $\leq 100\text{MHz}$ ;

$\leq 0.6\text{W/Kg}$  and  $100\text{MHz} \leq \text{transmission band} \leq 200\text{MHz}$ ;

$\leq 0.4\text{W/Kg}$  and transmission band  $> 200\text{MHz}$

**SAR Values (WCDMA Band II -Head)**

Test Frequency		Side	Test Position	Maximum Allowed Power (dBm)	Conducted Power (dBm)	Measurement SAR over 1g(W/kg)	Power drift	Scaling Factor	Reported SAR over 1g(W/kg)	SAR limit 1g (W/kg)	Ref. Plot #
Ch	MHz										
9400	1880.0	Left	Touch	24.00	22.64	0.148	-0.06	1.43	0.212	1.60	--
9400	1880.0	Left	Tilt	24.00	22.64	0.143	-0.11	1.43	0.204	1.60	--
9400	1880.0	Right	Touch	24.00	22.64	0.154	-0.06	1.43	0.220	1.60	--
9400	1880.0	Right	Tilt	24.00	22.64	0.172	-0.13	1.43	0.246	1.60	7

**SAR Values (WCDMA Band II -Body)**

Test Frequency		Mode (number of timeslots)	Test Position	Maximum Allowed Power (dBm)	Conducted Power (dBm)	Measurement SAR over 1g(W/kg)	Power drift	Scaling Factor	Reported SAR over 1g(W/kg)	SAR limit 1g (W/kg)	Ref. Plot #
Ch	MHz										
9400	1880.0	RMC	Back	24.00	22.64	0.252	-0.01	1.43	0.360	1.60	8
9400	1880.0	RMC	Front	24.00	22.64	0.194	-0.08	1.43	0.277	1.60	--
9400	1880.0	RMC	Left	24.00	22.64	0.173	-0.07	1.43	0.247	1.60	--
9400	1880.0	RMC	Right	24.00	22.64	0.147	-0.13	1.43	0.210	1.60	--
9400	1880.0	RMC	Bottom	24.00	22.64	0.187	-0.13	1.43	0.267	1.60	--

Note: 1. The distance between the EUT and the phantom bottom is 10mm.

2. According to KDB447498, When the 1-g SAR for the mid-band channel, or the channel with highest output power satisfy the following conditions, testing of the other channels in the band is not required.

$\leq 0.8\text{W/Kg}$  and transmission band  $\leq 100\text{MHz}$ ;

$\leq 0.6\text{W/Kg}$  and  $100\text{MHz} \leq \text{transmission band} \leq 200\text{MHz}$ ;

$\leq 0.4\text{W/Kg}$  and transmission band  $> 200\text{MHz}$

**SAR Values (WLAN2450-Head)**

Test Frequency		Side	Test Position	Maximum Allowed Power (dBm)	Conducted Power (dBm)	Measurement SAR over 1g(W/kg)	Power drift	Scaling Factor	Reported SAR over 1g(W/kg)	SAR limit 1g (W/kg)	Ref. Plot #
Ch	MHz										
2442	7	Left	Touch	20.00	18.77	0.171	-0.04	1.33	0.227	1.60	--
2442	7	Left	Tilt	20.00	18.77	0.186	-0.04	1.33	0.247	1.60	--
2442	7	Right	Touch	20.00	18.77	0.216	-0.10	1.33	0.287	1.60	--
2442	7	Right	Tilt	20.00	18.77	0.232	-0.05	1.33	0.309	1.60	9

**SAR Values (WLAN2450-Body)**

Test Frequency		Mode (number of timeslots)	Test Position	Maximum Allowed Power (dBm)	Conducted Power (dBm)	Measurement SAR over 1g(W/kg)	Power drift	Scaling Factor	Reported SAR over 1g(W/kg)	SAR limit 1g (W/kg)	Ref. Plot #
Ch	MHz										
2442	7	802.11b	Back	20.00	18.77	0.314	-0.07	1.33	0.418	1.60	10
2442	7	802.11b	Front	20.00	18.77	0.284	-0.06	1.33	0.378	1.60	--
2442	7	802.11b	Left	20.00	18.77	0.278	-0.04	1.33	0.370	1.60	--
2442	7	802.11b	Top	20.00	18.77	0.264	-0.10	1.33	0.351	1.60	--

Note: 1. The distance between the EUT and the phantom bottom is 10mm.

2. According to KDB447498, When the 1-g SAR for the mid-band channel, or the channel with highest output power satisfy the following conditions, testing of the other channels in the band is not required.

$\leq 0.8\text{W/Kg}$  and transmission band  $\leq 100\text{MHz}$ ;

$\leq 0.6\text{W/Kg}$  and  $100\text{MHz} \leq \text{transmission band} \leq 200\text{MHz}$ ;

$\leq 0.4\text{W/Kg}$  and transmission band  $> 200\text{MHz}$

**5.4. SAR Measurement Variability**

SAR measurement variability must be assessed for each frequency band, which is determined by the SAR probe calibration point and tissue-equivalent medium used for the device measurements. When both head and body tissue-equivalent media are required for SAR measurements in a frequency band, the variability measurement procedures should be applied to the tissue medium with the highest measured SAR, using the highest measured SAR configuration for that tissue-equivalent medium. The following procedures are applied to determine if repeated measurements are required.

- 1) Repeated measurement is not required when the original highest measured SAR is  $< 0.80\text{ W/kg}$ ; steps 2) through 4) do not apply.
- 2) When the original highest measured SAR is  $\geq 0.80\text{ W/kg}$ , repeat that measurement once.
- 3) Perform a second repeated measurement only if the ratio of largest to smallest SAR for the original and first repeated measurements is  $> 1.20$  or when the original or repeated measurement is  $\geq 1.45\text{ W/kg}$  ( $\sim 10\%$  from the 1-g SAR limit).
- 4) Perform a third repeated measurement only if the original, first or second repeated measurement is  $\geq 1.5\text{ W/kg}$  and the ratio of largest to smallest SAR for the original, first and second repeated measurements is  $> 1.20$ .

**5.5. Measurement Uncertainty (300MHz-3GHz)**

No.	Error Description	Type	Uncertainty Value	Probably Distribution	Div.	(Ci) 1g	(Ci) 10g	Std. Unc. (1g)	Std. Unc. (10g)	Degree of freedom
<b>Measurement System</b>										
1	Probe calibration	B	5.50%	N	1	1	1	5.50%	5.50%	∞
2	Axial isotropy	B	4.70%	R	$\sqrt{3}$	0.7	0.7	1.90%	1.90%	∞
3	Hemispherical isotropy	B	9.60%	R	$\sqrt{3}$	0.7	0.7	3.90%	3.90%	∞
4	Boundary Effects	B	1.00%	R	$\sqrt{3}$	1	1	0.60%	0.60%	∞
5	Probe Linearity	B	4.70%	R	$\sqrt{3}$	1	1	2.70%	2.70%	∞
6	Detection limit	B	1.00%	R	$\sqrt{3}$	1	1	0.60%	0.60%	∞
7	RF ambient conditions-noise	B	0.00%	R	$\sqrt{3}$	1	1	0.00%	0.00%	∞
8	RF ambient conditions-reflection	B	0.00%	R	$\sqrt{3}$	1	1	0.00%	0.00%	∞
9	Response time	B	0.80%	R	$\sqrt{3}$	1	1	0.50%	0.50%	∞
10	Integration time	B	5.00%	R	$\sqrt{3}$	1	1	2.90%	2.90%	∞
11	RF ambient	B	3.00%	R	$\sqrt{3}$	1	1	1.70%	1.70%	∞
12	Probe positioned mech. restrictions	B	0.40%	R	$\sqrt{3}$	1	1	0.20%	0.20%	∞
13	Probe positioning with respect to phantom shell	B	2.90%	R	$\sqrt{3}$	1	1	1.70%	1.70%	∞
14	Max.SAR evaluation	B	3.90%	R	$\sqrt{3}$	1	1	2.30%	2.30%	∞
<b>Test Sample Related</b>										
15	Test sample positioning	A	1.86%	N	1	1	1	1.86%	1.86%	∞
16	Device holder uncertainty	A	1.70%	N	1	1	1	1.70%	1.70%	∞
17	Drift of output power	B	5.00%	R	$\sqrt{3}$	1	1	2.90%	2.90%	∞
<b>Phantom and Set-up</b>										
18	Phantom uncertainty	B	4.00%	R	$\sqrt{3}$	1	1	2.30%	2.30%	∞
19	Liquid conductivity (target)	B	5.00%	R	$\sqrt{3}$	0.64	0.43	1.80%	1.20%	∞
20	Liquid conductivity (meas.)	A	0.50%	N	1	0.64	0.43	0.32%	0.26%	∞
21	Liquid permittivity (target)	B	5.00%	R	$\sqrt{3}$	0.64	0.43	1.80%	1.20%	∞
22	Liquid permittivity (meas.)	A	0.16%	N	1	0.64	0.43	0.10%	0.07%	∞



Combined standard uncertainty	$u_c = \sqrt{\sum_{i=1}^{22} c_i^2 u_i^2}$	/	/	/	/	/	10.20%	10.00%	$\infty$
Expanded uncertainty (confidence interval of 95 %)	$u_e = 2u_c$	/	R	K=2	/	/	20.40%	20.00%	$\infty$

## 5.6. System Check Results

### System Performance Check at 835 MHz Head

DUT: Dipole 835 MHz; Type: D835V2; Serial: 4d134

Date/Time: 15/09/2014 AM

Communication System: CW; Frequency: 835 MHz; Duty Cycle: 1:1

Medium parameters used (interpolated):  $f = 835$  MHz;  $\sigma = 0.92$  S/m;  $\epsilon_r = 41.53$ ;  $\rho = 1000$  kg/m<sup>3</sup>

Phantom section: Flat Section

DASY5 Configuration:

Probe: EX3DV4 - SN3842; ConvF(8.83, 8.83, 8.83); Calibrated: 06/06/2014;

Sensor-Surface: 3mm (Mechanical Surface Detection)

Electronics: DAE4 Sn1315; Calibrated: 25/11/2013

Phantom: SAM 1; Type: SAM;

Measurement SW: DASY52, Version 52.8 (2); SEMCAD X Version 14.6.5 (6469)

**Area Scan (61x91x1):** Measurement grid: dx=15.00 mm, dy=15.00 mm

Maximum value of SAR (interpolated) = 2.58 mW/g

**Zoom Scan (7x7x7)/Cube 0:** Measurement grid: dx=5mm, dy=5mm, dz=5mm

Reference Value = 52.994 V/m; Power Drift = 0.082 dB

Peak SAR (extrapolated) = 3.542 W/kg

**SAR(1 g) = 2.32 mW/g; SAR(10 g) = 1.48 mW/g**

Maximum value of SAR (measured) = 2.59 mW/g

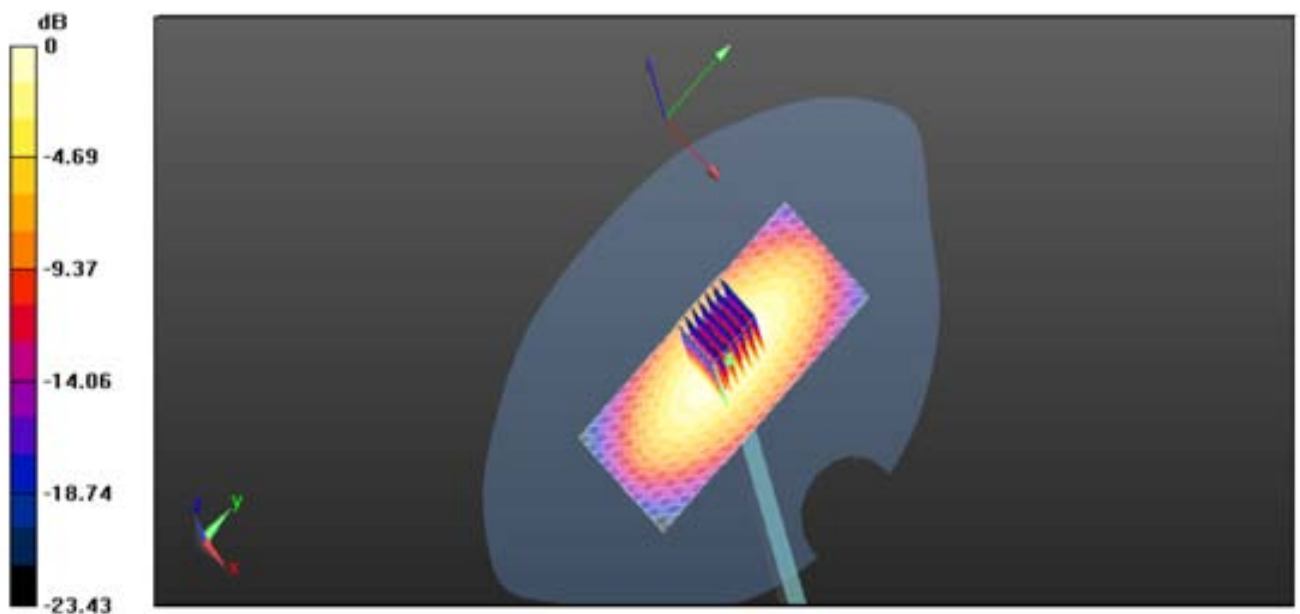

0 dB = 2.58mW/g=8.23dB mW/g

**System Performance Check at 835 MHz Body**

DUT: Dipole 835 MHz; Type: D835V2; Serial: 4d134

Date/Time: 15/09/2014 AM

Communication System: CW; Frequency: 835 MHz; Duty Cycle: 1:1

Medium parameters used (interpolated):  $f = 835$  MHz;  $\sigma = 0.96$  S/m;  $\epsilon_r = 55.95$ ;  $\rho = 1000$  kg/m<sup>3</sup>

Phantom section: Flat Section

DASY5 Configuration:

Probe: EX3DV4 - SN3842; ConvF(9.09, 9.09, 9.09); Calibrated: 06/06/2014;

Sensor-Surface: 3mm (Mechanical Surface Detection)

Electronics: DAE4 Sn1315; Calibrated: 25/11/2013

Phantom: SAM 1; Type: SAM;

Measurement SW: DASY52, Version 52.8 (2); SEMCAD X Version 14.6.5 (6469)

**Area Scan (61x91x1):** Measurement grid: dx=15.00 mm, dy=15.00 mm

Maximum value of SAR (interpolated) = 2.15 mW/g

**Zoom Scan (7x7x7)/Cube 0:** Measurement grid: dx=5mm, dy=5mm, dz=5mm

Reference Value = 46.528 V/m; Power Drift = -0.02 dB

Peak SAR (extrapolated) = 3.262 W/kg

**SAR(1 g) = 2.25 mW/g; SAR(10 g) = 1.48 mW/g**

Maximum value of SAR (measured) = 3.24 mW/g

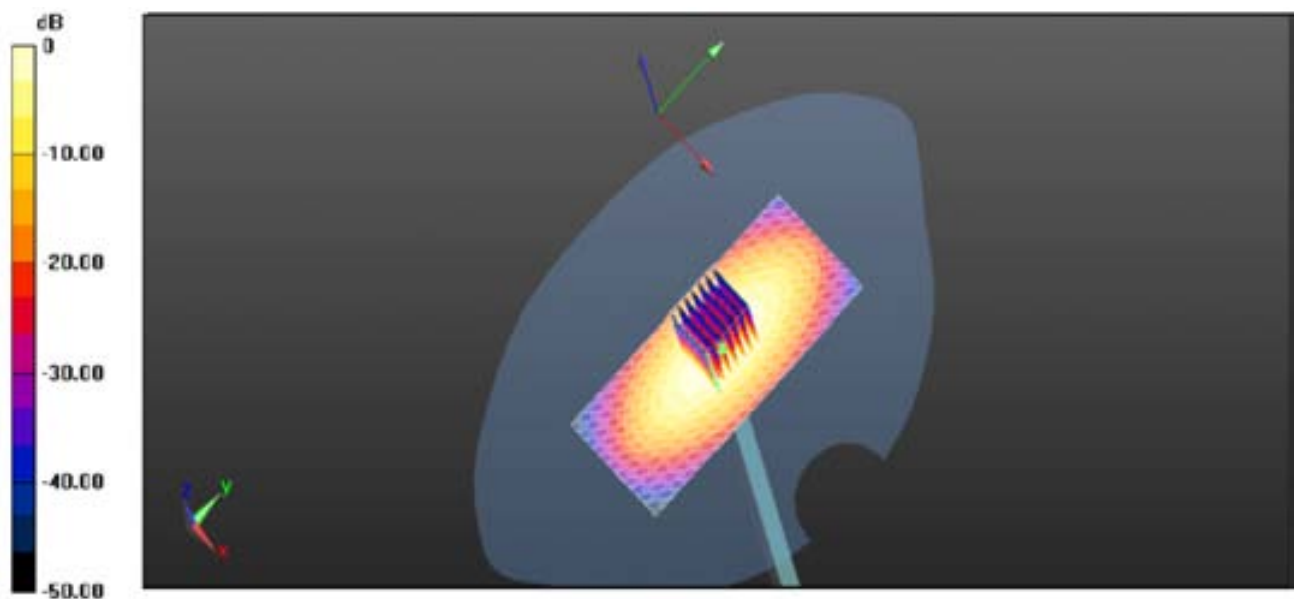

0 dB = 3.24 mW/g = 11.24 dB mW/g

System Performance Check 835MHz Body 250mW

**System Performance Check at 1900 MHz Head**

DUT: Dipole 1900 MHz; Type: D1900V2; Serial: 5d150

Date/Time: 17/09/2014 AM

Communication System: CW; Frequency: 1900 MHz; Duty Cycle: 1:1

Medium parameters used (interpolated):  $f = 1900$  MHz;  $\sigma = 1.45$  S/m;  $\epsilon_r = 39.83$ ;  $\rho = 1000$  kg/m<sup>3</sup>

Phantom section: Flat Section

DASY5 Configuration:

Probe: EX3DV4 - SN3842; ConvF(7.55, 7.55, 7.55); Calibrated: 06/06/2014;

Sensor-Surface: 3mm (Mechanical Surface Detection)

Electronics: DAE4 Sn1315; Calibrated: 25/11/2013

Phantom: SAM 1; Type: SAM;

Measurement SW: DASY52, Version 52.8 (1); SEMCAD X Version 14.6.5 (6469)

**Area Scan (61x91x1):** Measurement grid: dx=15.00 mm, dy=15.00 mm

Maximum value of SAR (interpolated) = 10.65 W/kg

**Zoom Scan (7x7x7)/Cube 0:** Measurement grid: dx=5mm, dy=5mm, dz=5mm

Reference Value = 94.818 V/m; Power Drift = -0.06 dB

Peak SAR (extrapolated) = 12.352 W/kg

**SAR(1 g) = 9.53 W/kg; SAR(10 g) = 4.96 W/kg**

Maximum value of SAR (measured) = 12.43 W/kg

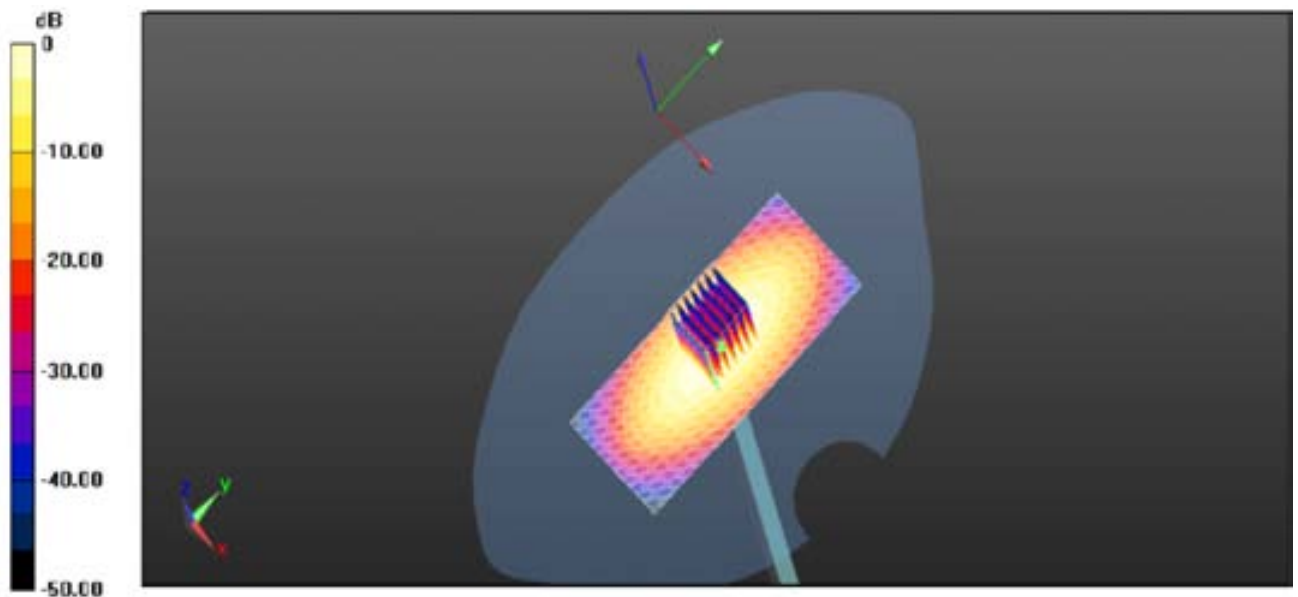

0 dB = 12.43 W/kg = 20.55 dB W/kg

System Performance Check 1900MHz Head 250mW

**System Performance Check at 1900 MHz Body**

DUT: Dipole 1900 MHz; Type: D1900V2; Serial: 5d150

Date/Time: 17/09/2014 AM

Communication System: CW; Frequency: 1900 MHz; Duty Cycle: 1:1

Medium parameters used (interpolated):  $f = 1900$  MHz;  $\sigma = 1.49$  S/m;  $\epsilon_r = 55.64$ ;  $\rho = 1000$  kg/m<sup>3</sup>

Phantom section: Flat Section

DASY5 Configuration:

Probe: EX3DV4 - SN3842; ConvF(7.43, 7.43, 7.43); Calibrated: 06/06/2014;

Sensor-Surface: 3mm (Mechanical Surface Detection)

Electronics: DAE4 Sn1315; Calibrated: 25/11/2013

Phantom: SAM 1; Type: SAM;

Measurement SW: DASY52, Version 52.8 (1); SEMCAD X Version 14.6.5 (6469)

**Area Scan (61x91x1):** Measurement grid: dx=15.00 mm, dy=15.00 mm

Maximum value of SAR (interpolated) = 11.46 mW/g

**Zoom Scan (7x7x7)/Cube 0:** Measurement grid: dx=5mm, dy=5mm, dz=5mm

Reference Value = 83.816 V/m; Power Drift = -0.07 dB

Peak SAR (extrapolated) = 16.826 W/kg

**SAR(1 g) = 9.71 mW/g; SAR(10 g) = 5.13 mW/g**

Maximum value of SAR (measured) = 16.34 mW/g

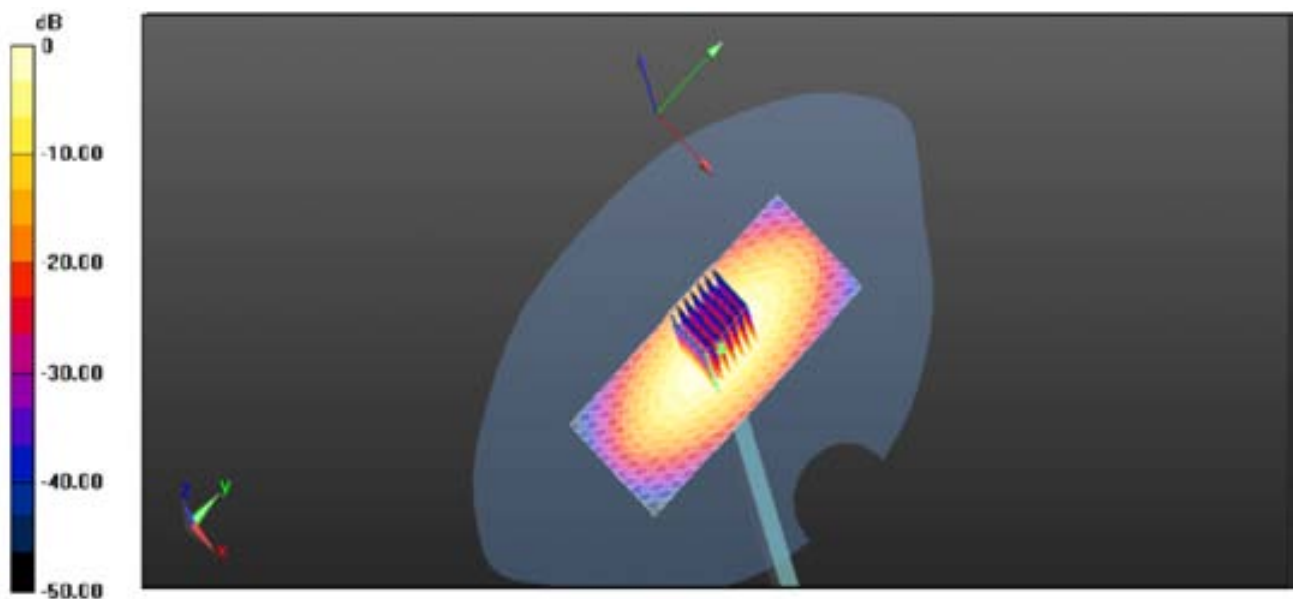

0 dB = 16.34 mW/g = 24.35 dB mW/g

System Performance Check 1900MHz Body 250mW

**System Performance Check at 2450 MHz Head**

DUT: Dipole 2450 MHz; Type: D2450V2; Serial: 884

Date/Time: 19/09/2014 AM

Communication System: CW; Frequency: 2450 MHz; Duty Cycle: 1:1

Medium parameters used (interpolated):  $f = 2450$  MHz;  $\sigma = 1.74$  S/m;  $\epsilon_r = 40.58$ ;  $\rho = 1000$  kg/m<sup>3</sup>

Phantom section: Flat Section

DASY5 Configuration:

Probe: EX3DV4 - SN3842; ConvF(7.26, 7.26, 7.26); Calibrated: 06/06/2014;

Sensor-Surface: 3mm (Mechanical Surface Detection)

Electronics: DAE4 Sn1315; Calibrated: 25/11/2013

Phantom: SAM 1; Type: SAM;

Measurement SW: DASY52, Version 52.8 (1); SEMCAD X Version 14.6.5 (6469)

**Area Scan (61x91x1):** Measurement grid: dx=10.00 mm, dy=10.00 mm

Maximum value of SAR (interpolated) = 14.9 mW/g

**Zoom Scan (7x7x7)/Cube 0:** Measurement grid: dx=5mm, dy=5mm, dz=5mm

Reference Value = 97.714 V/m; Power Drift = -0.05 dB

Peak SAR (extrapolated) = 26.08 mW/g

**SAR(1 g) = 12.47 mW/g; SAR(10 g) = 5.83 mW/g**

Maximum value of SAR (measured) = 14.8 mW/g

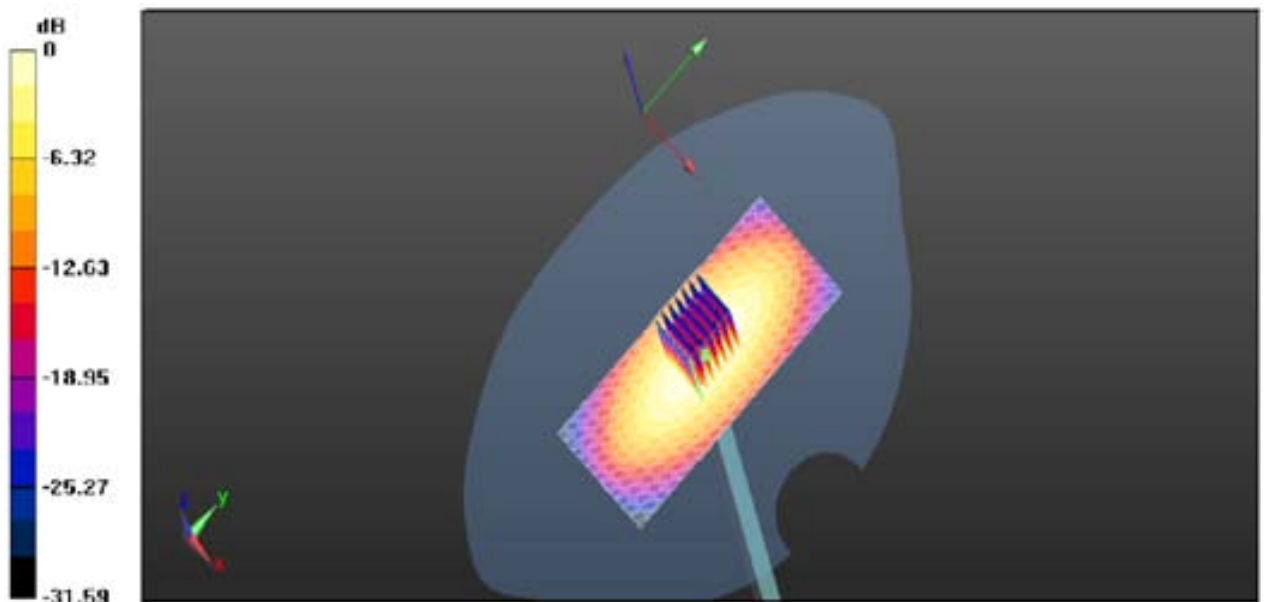

0 dB = 14.9 mW/g = 23.46 dB mW/g

System Performance Check 2450MHz Head 250mW

**System Performance Check at 2450 MHz Body**

DUT: Dipole 2450 MHz; Type: D2450V2; Serial: 884

Date/Time: 19/09/2014 AM

Communication System: CW; Frequency: 2450 MHz; Duty Cycle: 1:1

Medium parameters used (interpolated):  $f = 2450$  MHz;  $\sigma = 1.98$  S/m;  $\epsilon_r = 53.47$ ;  $\rho = 1000$  kg/m<sup>3</sup>

Phantom section: Flat Section

DASY5 Configuration:

Probe: EX3DV4 - SN3842; ConvF(6.93, 6.93, 6.93); Calibrated: 06/06/2014;

Sensor-Surface: 3mm (Mechanical Surface Detection)

Electronics: DAE4 Sn1315; Calibrated: 25/11/2013

Phantom: SAM 1; Type: SAM;

Measurement SW: DASY52, Version 52.8 (1); SEMCAD X Version 14.6.5 (6469)

**Area Scan (61x91x1):** Measurement grid: dx=10.00 mm, dy=10.00 mm

Maximum value of SAR (interpolated) = 13.15 mW/g

**Zoom Scan (7x7x7)/Cube 0:** Measurement grid: dx=5mm, dy=5mm, dz=5mm

Reference Value = 97.986 V/m; Power Drift = -0.08 dB

Peak SAR (extrapolated) = 16.08 mW/g

**SAR(1 g) = 12.53 mW/g; SAR(10 g) = 5.69 mW/g**

Maximum value of SAR (measured) = 16.08 mW/g

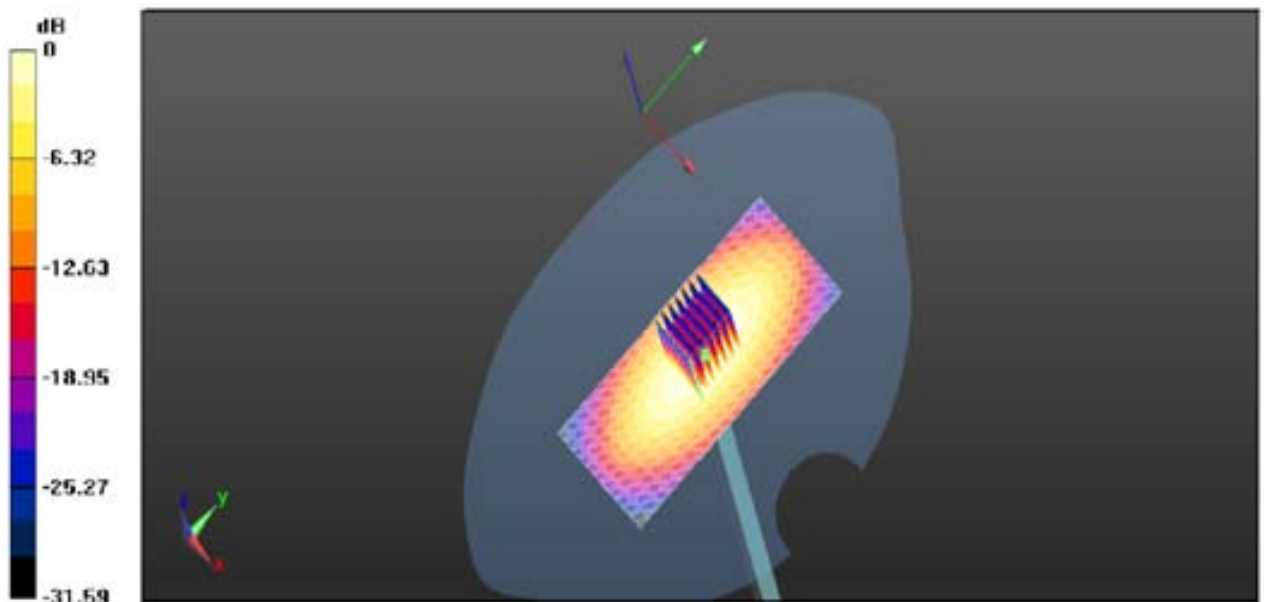

0 dB = 16.08 mW/g = 24.67 dB mW/g

System Performance Check 2450MHz Body 250mW

## 5.7. SAR Test Graph Results

### GSM850 Left Head Tilt Middle Channel

Communication System: Customer System; Frequency: 836.6 MHz; Duty Cycle: 1:8.3

Medium parameters used (interpolated):  $f = 836.6$  MHz;  $\sigma = 0.93$  S/m;  $\epsilon_r = 42.55$ ;  $\rho = 1000$  kg/m<sup>3</sup>

Phantom section : Left Head Section

Probe: EX3DV3 - SN3842; ConvF(8.83, 8.83, 8.83); Calibrated: 06/06/2014;

Electronics: DAE4 Sn1315; Calibrated: 25/11/2013

Phantom: SAM 1; Type: SAM;

Measurement SW: DASY52, Version 52.8 (2); SEMCAD X Version 14.6.6 (6824)

**Area Scan (81x101x1):** Measurement grid:  $dx=1.50$  mm,  $dy=1.50$  mm

Maximum value of SAR (interpolated) = 0.359 W/kg

**Zoom Scan (5x5x5)/Cube 0:** Measurement grid:  $dx=5$ mm,  $dy=5$ mm,  $dz=5$ mm

Reference Value = 8.224 V/m; Power Drift = -0.06 dB

Peak SAR (extrapolated) = 0.467 W/kg

**SAR(1 g) = 0.335 W/kg; SAR(10 g) = 0.227 W/kg**

Maximum value of SAR (measured) = 0.466 W/kg

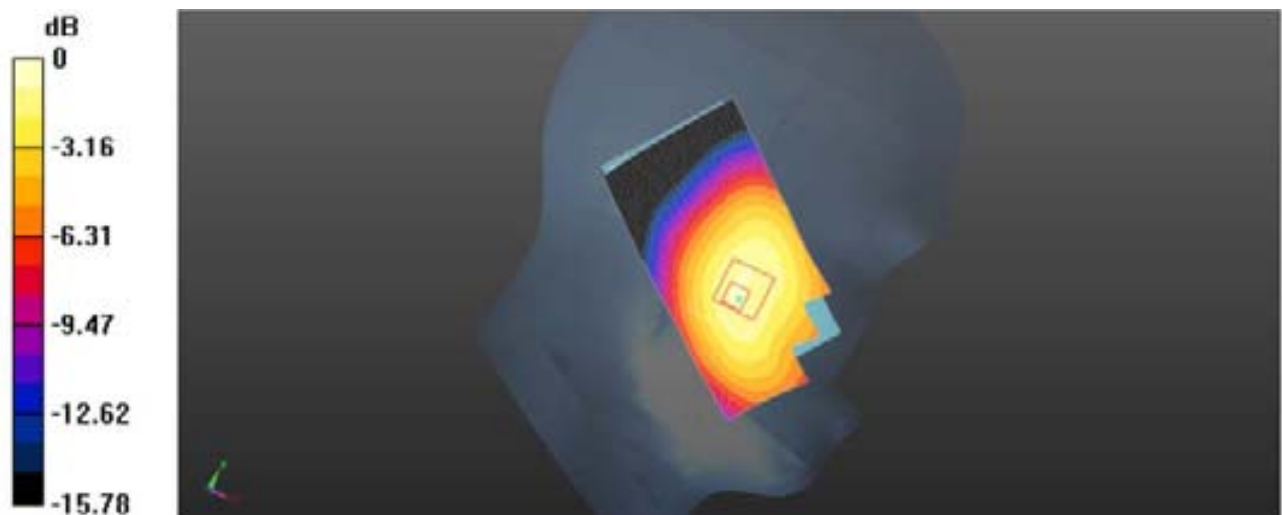

0dB = 0.466 W/kg = -5.34 dBW/kg

Plot 1: Left Head Title (GSM850 Middle Channel)



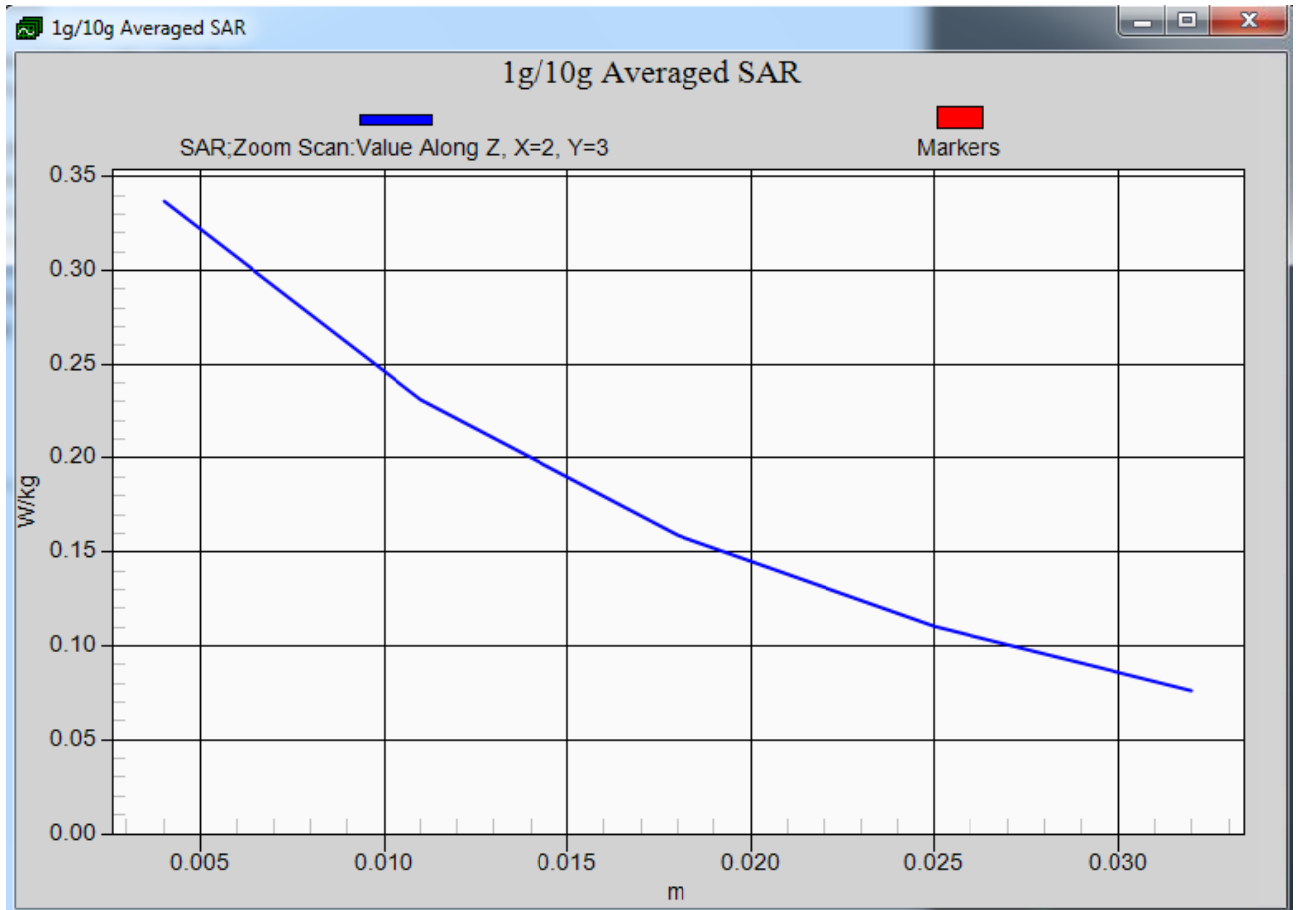

Z-Scan at power reference point- Left Head Tilt (GSM850 Middle Channel)

**GSM850 GPRS 4TS Body Back Side Middle Channel**

Communication System: Customer System; Frequency: 836.6 MHz; Duty Cycle: 1:2

Medium parameters used (interpolated):  $f = 836.6$  MHz;  $\sigma = 0.94$  S/m;  $\epsilon_r = 55.13$ ;  $\rho = 1000$  kg/m<sup>3</sup>

Phantom section : Body- worn

Probe: EX3DV4 - SN3842; ConvF(9.09, 9.09, 9.09); Calibrated: 06/06/2014;

Electronics: DAE4 Sn1315; Calibrated: 25/11/2013

Phantom: SAM 1; Type: SAM;

Measurement SW: DASY52, Version 52.8 (2); SEMCAD X Version 14.6.6 (6824)

**Area Scan (81x101x1):** Measurement grid: dx=1.50 mm, dy=1.50 mm

Maximum value of SAR (interpolated) = 0.592 W/kg

**Zoom Scan (5x5x5)/Cube 0:** Measurement grid: dx=5mm, dy=5mm, dz=5mm

Reference Value = 9.516 V/m; Power Drift = -0.13 dB

Peak SAR (extrapolated) = 0.735 W/kg

**SAR(1 g) = 0.495 W/kg; SAR(10 g) = 0.263 W/kg**

Maximum value of SAR (measured) = 0.730 W/kg

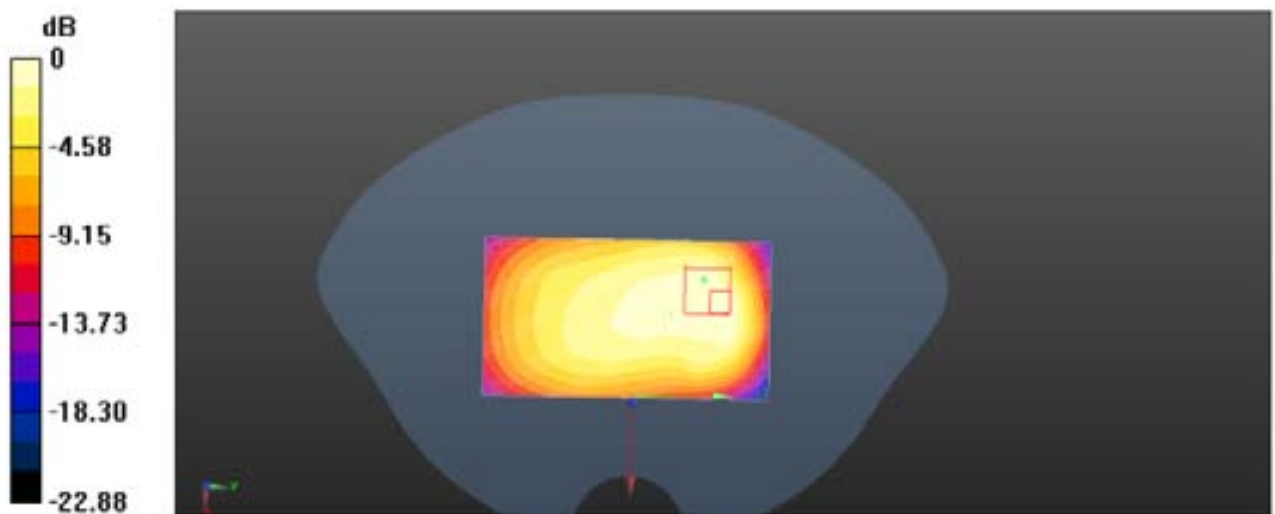

0dB = 0.730 W/kg = -1.27 dBW/kg

Plot 2: Body Back Side (GSM850 GPRS 4TS Middle Channel)

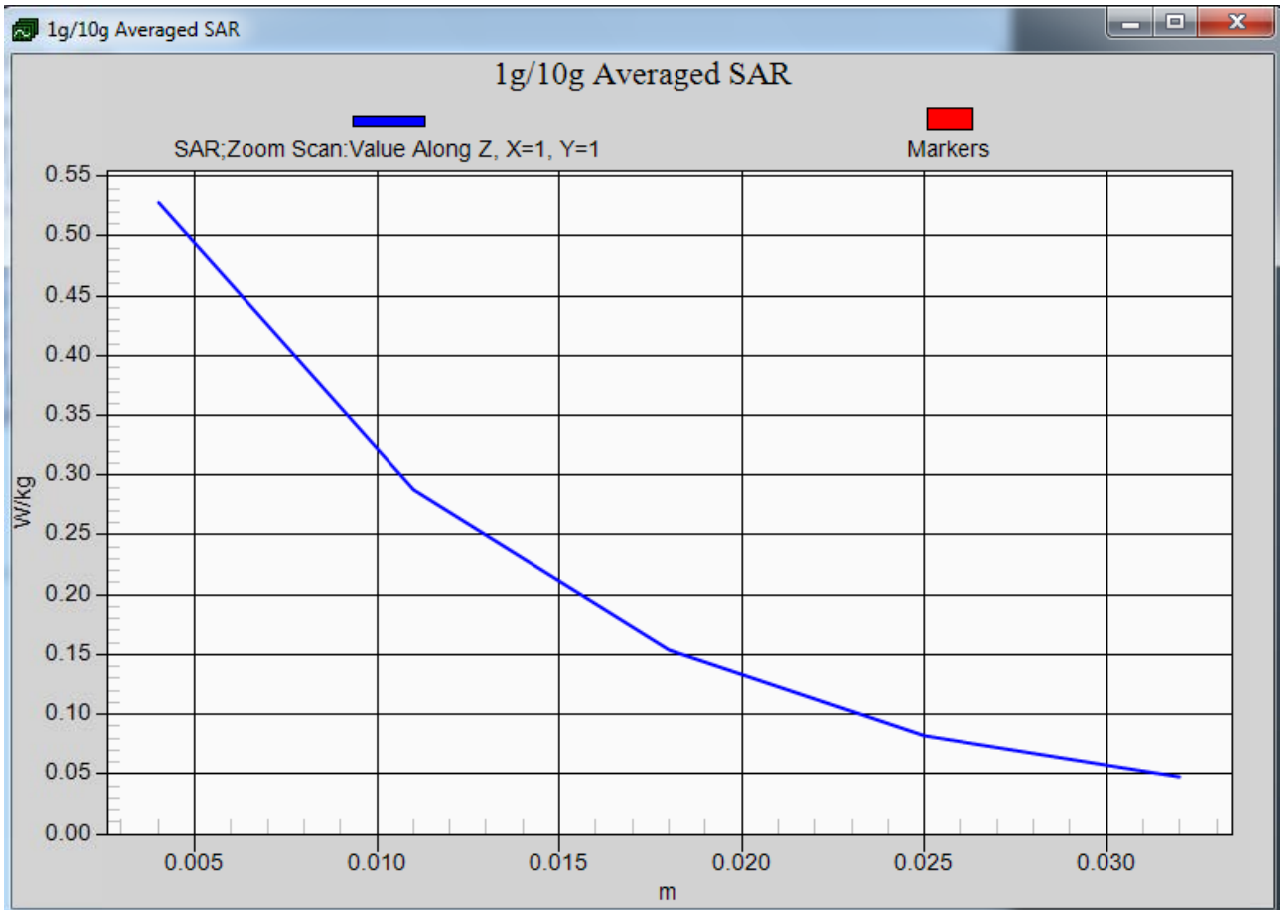

Z-Scan at power reference point-Body Back Side (GSM850 GPRS 4TS Middle Channel)

**PCS1900 Left Head Touch Middle Channel**

Communication System: Customer System; Frequency: 1880.0 MHz; Duty Cycle: 1:8.3

Medium parameters used (interpolated):  $f = 1880.0$  MHz;  $\sigma = 1.38$  S/m;  $\epsilon_r = 40.90$ ;  $\rho = 1000$  kg/m<sup>3</sup>

Phantom section : Left Head Section

Probe: EX3DV4 - SN3842; ConvF(7.55, 7.55, 7.55); Calibrated: 06/06/2014;

Sensor-Surface: 4mm (Mechanical Surface Detection)

Electronics: DAE4 Sn1315; Calibrated: 25/11/2013

Phantom: SAM 1; Type: SAM;

Measurement SW: DASY52, Version 52.8 (2); SEMCAD X Version 14.6.6 (6824)

**Area Scan (81x101x1):** Measurement grid: dx=1.50 mm, dy=1.50 mm

Maximum value of SAR (interpolated) = 0.426 W/kg

**Zoom Scan (5x5x5)/Cube 0:** Measurement grid: dx=5mm, dy=5mm, dz=5mm

Reference Value = 8.315 V/m; Power Drift = -0.07 dB

Peak SAR (extrapolated) = 0.468 W/kg

**SAR(1 g) = 0.235 W/kg; SAR(10 g) = 0.172 W/kg**

Maximum value of SAR (measured) = 0.463 W/kg

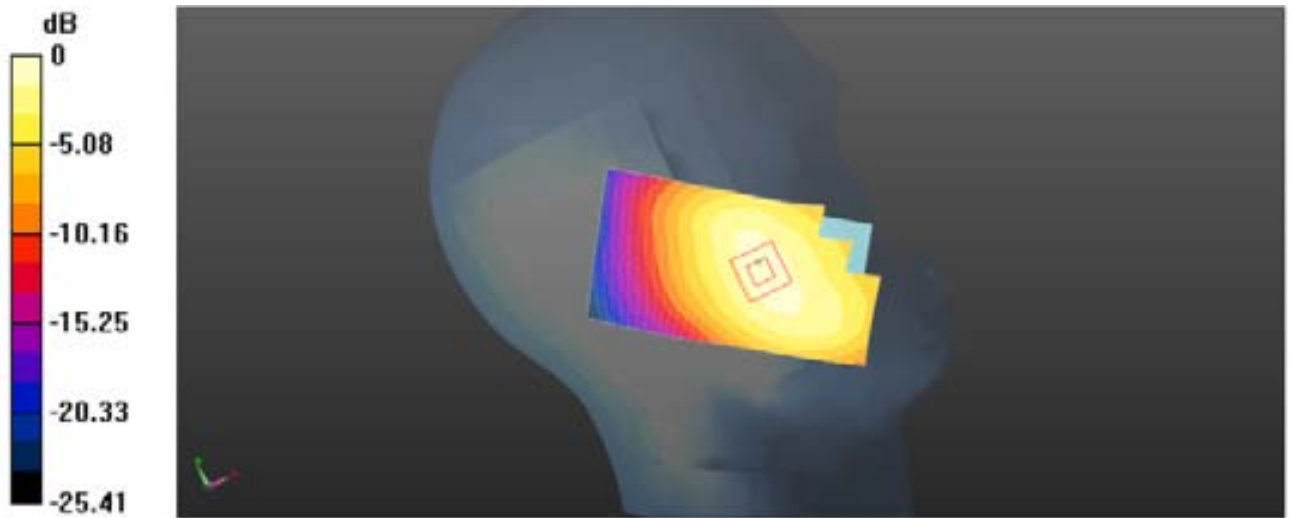

0dB = 0.463 W/kg = -5.26 dBW/kg

Plot 3: Left Head Touch (PCS1900 Middle Channel)

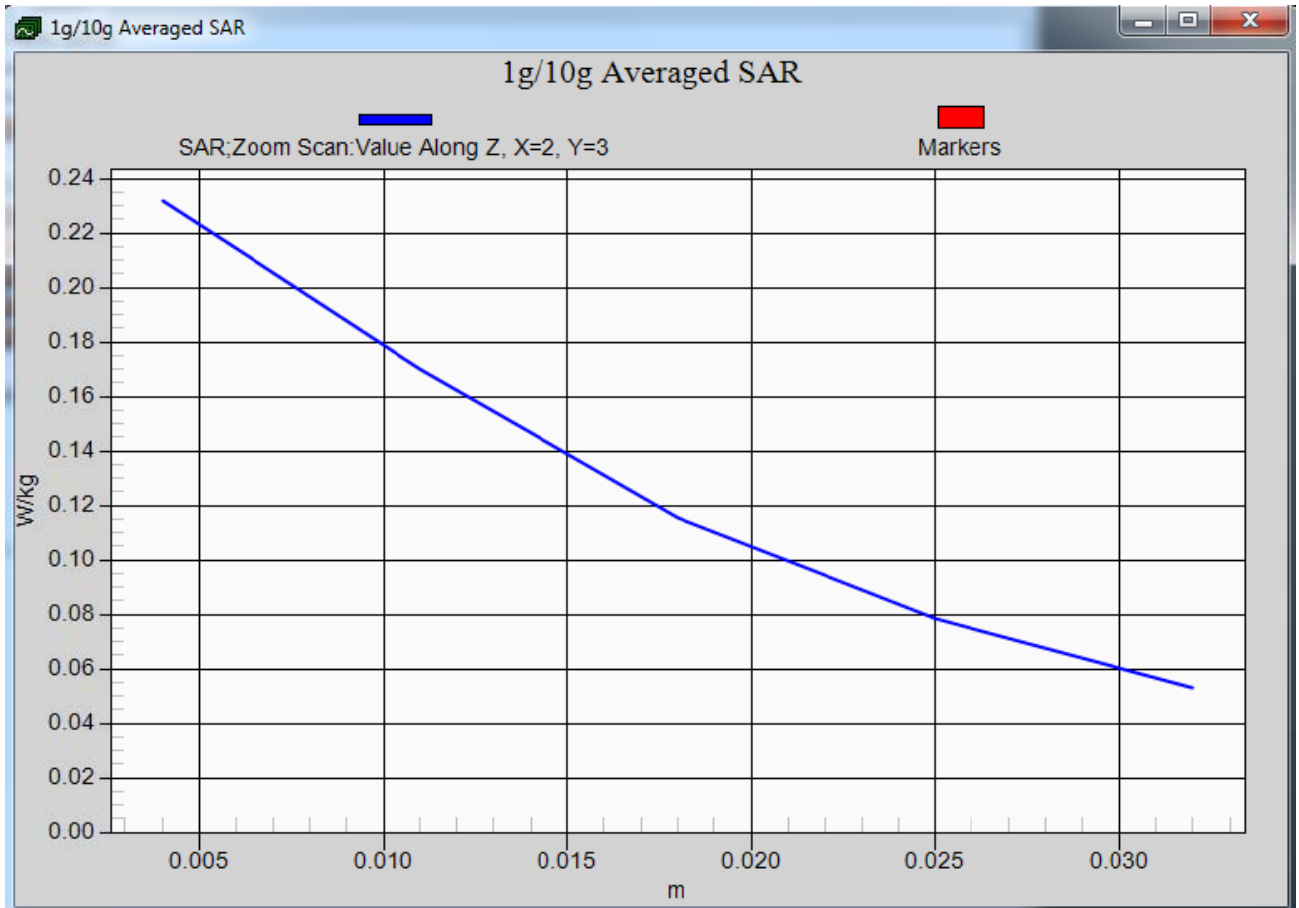

Z-Scan at power reference point- Left Head Touch (PCS1900 Middle Channel)

**PCS1900 GPRS 4TS Body Back Side Middle Channel**

Communication System: Customer System; Frequency: 1880.0 MHz; Duty Cycle: 1:2

Medium parameters used (interpolated):  $f = 1880.0$  MHz;  $\sigma = 1.53$  S/m;  $\epsilon_r = 53.53$ ;  $\rho = 1000$  kg/m<sup>3</sup>

Phantom section : Body- worn

Probe: EX3DV4 - SN3842; ConvF(7.43, 7.43, 7.43); Calibrated: 06/06/2014;

Sensor-Surface: 4mm (Mechanical Surface Detection)

Electronics: DAE4 Sn1315; Calibrated: 25/11/2013

Phantom: SAM 1; Type: SAM;

Measurement SW: DASY52, Version 52.8 (2); SEMCAD X Version 14.6.6 (6824)

**Area Scan (81x101x1):** Measurement grid: dx=1.50 mm, dy=1.50 mm

Maximum value of SAR (interpolated) = 0.435 W/kg

**Zoom Scan (5x5x5)/Cube 0:** Measurement grid: dx=5mm, dy=5mm, dz=5mm

Reference Value = 8.348 V/m; Power Drift = -0.11 dB

Peak SAR (extrapolated) = 0.568 W/kg

**SAR(1 g) = 0.473 W/kg; SAR(10 g) = 0.243 W/kg**

Maximum value of SAR (measured) = 0.457 W/kg

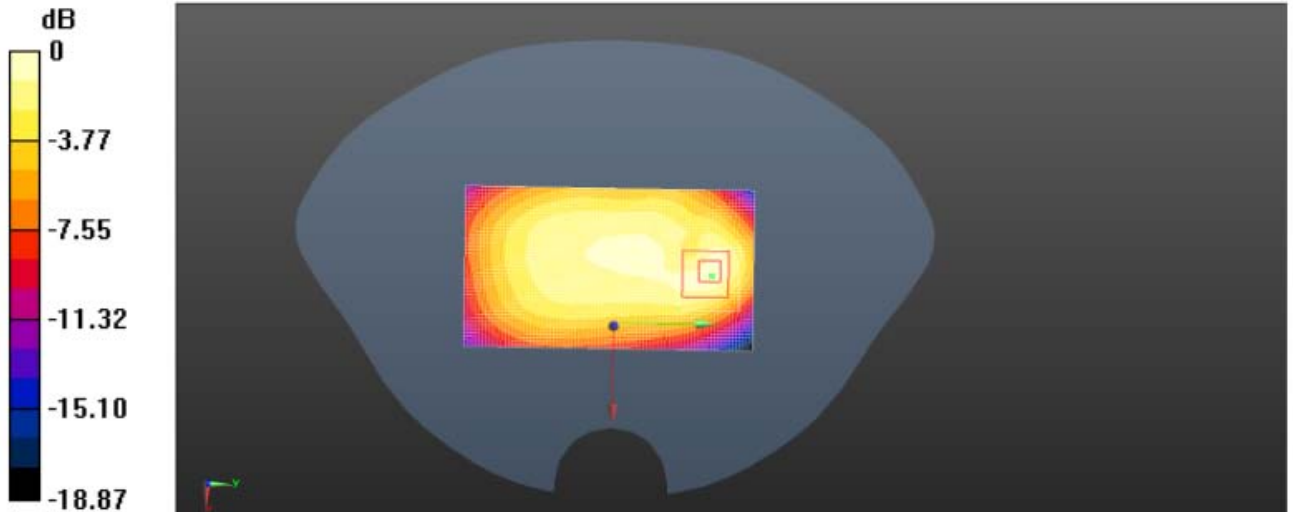

0dB = 0.457 W/kg = -3.86 dBW/kg

Plot 4: Body Back Side (PCS1900 GPRS 4TS Middle Channel)

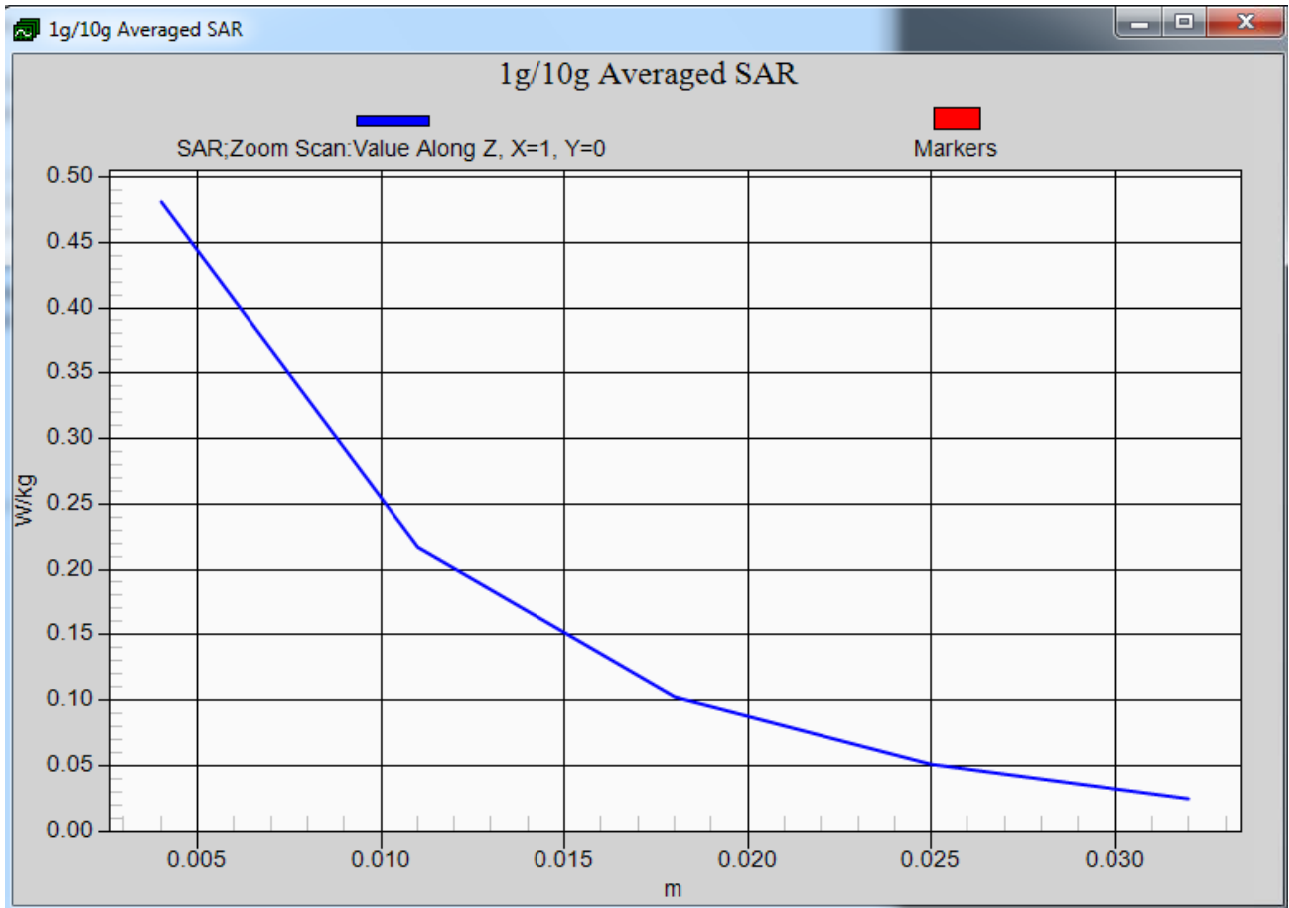

Z-Scan at power reference point- Body Back Side (PCS1900 GPRS 4TS Middle Channel)

**WCDMA Band V Left Head Touch Middle Channel**

Communication System: Customer System; Frequency: 836.4 MHz; Duty Cycle: 1:1

Medium parameters used (interpolated):  $f = 836.4$  MHz;  $\sigma = 0.90$  S/m;  $\epsilon_r = 42.02$ ;  $\rho = 1000$  kg/m<sup>3</sup>

Phantom section : Left Head Section

Probe: EX3DV4 - SN3842; ConvF(8.83, 8.83, 8.83); Calibrated: 06/06/2014;

Electronics: DAE4 Sn1315; Calibrated: 25/11/2013

Phantom: SAM 1; Type: SAM;

Measurement SW: DASY52, Version 52.8 (2); SEMCAD X Version 14.6.6 (6824)

**Area Scan (81x101x1):** Measurement grid: dx=1.50 mm, dy=1.50 mm

Maximum value of SAR (interpolated) = 0.286 W/kg

**Zoom Scan (5x5x5)/Cube 0:** Measurement grid: dx=5mm, dy=5mm, dz=5mm

Reference Value = 6.345 V/m; Power Drift = -0.08 dB

Peak SAR (extrapolated) = 0.324 W/kg

**SAR(1 g) = 0.186 W/kg; SAR(10 g) = 0.135 W/kg**

Maximum value of SAR (measured) = 0.289 W/kg

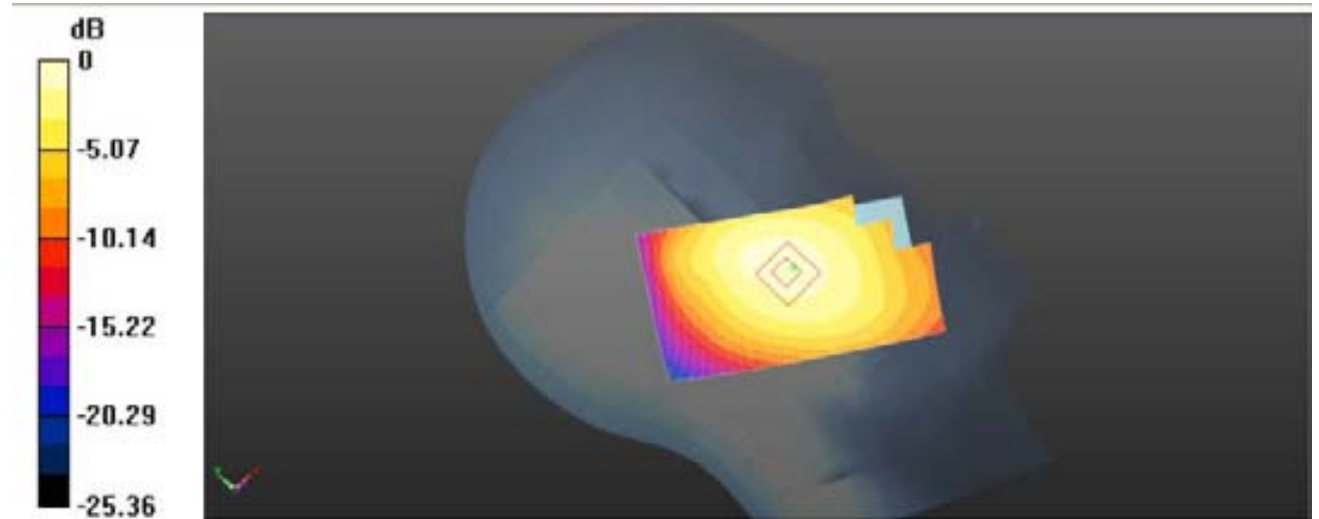

0dB = 0.289 W/kg = -5.14 dBW/kg

Plot 5: Left Head Touch (WCDMA Band V Middle Channel)



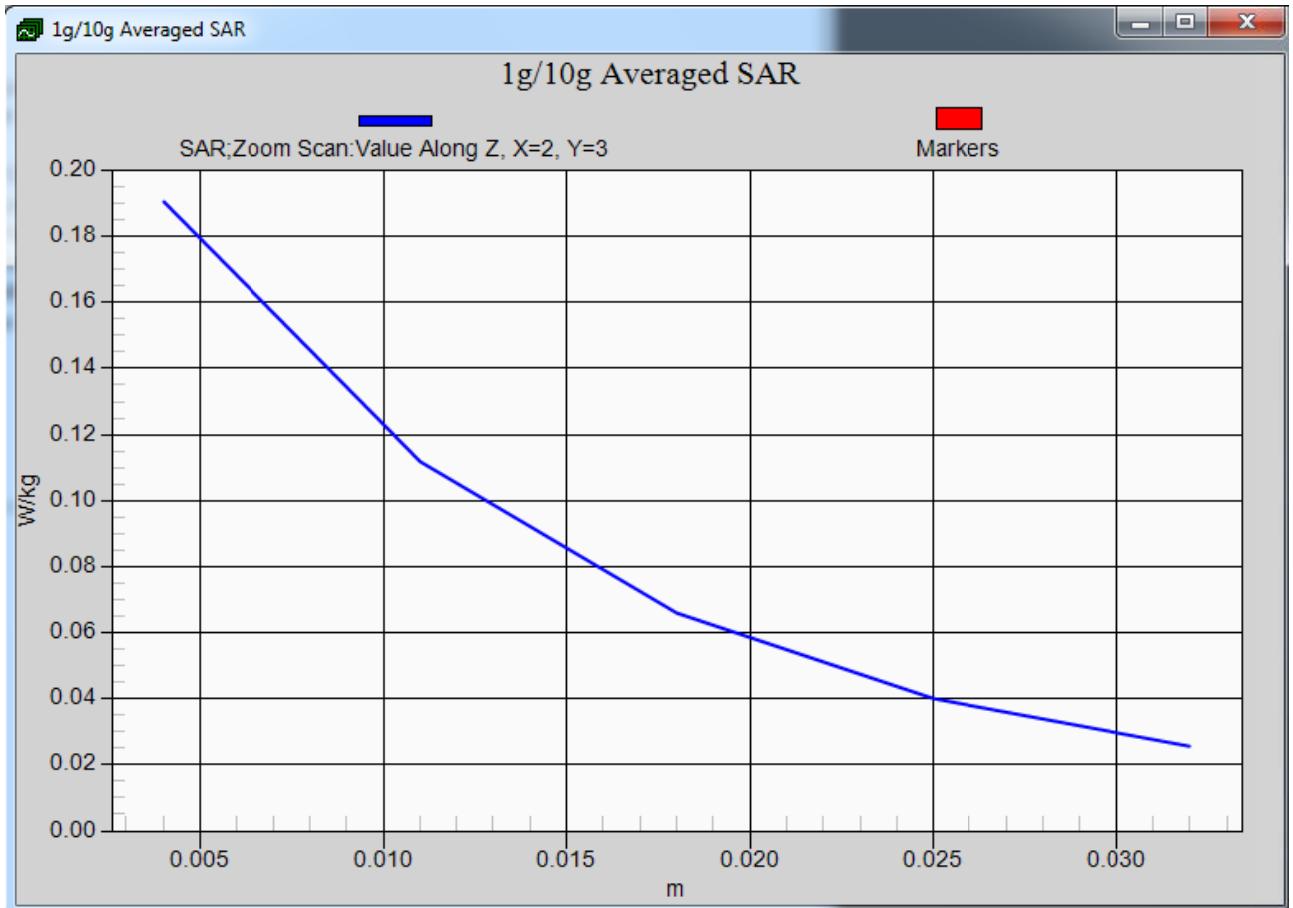

Z-Scan at power reference point- Left Head Touch (WCDMA Band V Middle Channel)

**WCDMA Band V RMC Body Back Side Middle Channel**

Communication System: Customer System; Frequency: 836.4 MHz; Duty Cycle: 1:1

Medium parameters used (interpolated):  $f = 836.4 \text{ MHz}$ ;  $\sigma = 0.95 \text{ S/m}$ ;  $\epsilon_r = 55.52$ ;  $\rho = 1000 \text{ kg/m}^3$

Phantom section : Body- worn

Probe: EX3DV4 - SN3842; ConvF(9.09, 9.09, 9.09); Calibrated: 06/06/2014;

Electronics: DAE4 Sn1315; Calibrated: 25/11/2013

Phantom: SAM 1; Type: SAM;

Measurement SW: DASY52, Version 52.8 (2); SEMCAD X Version 14.6.6 (6824)

**Area Scan (81x101x1):** Measurement grid:  $dx=1.50 \text{ mm}$ ,  $dy=1.50 \text{ mm}$

Maximum value of SAR (interpolated) =  $0.413 \text{ W/kg}$

**Zoom Scan (5x5x5)/Cube 0:** Measurement grid:  $dx=5\text{mm}$ ,  $dy=5\text{mm}$ ,  $dz=5\text{mm}$

Reference Value =  $8.140 \text{ V/m}$ ; Power Drift =  $-0.05 \text{ dB}$

Peak SAR (extrapolated) =  $0.598 \text{ W/kg}$

**SAR(1 g) =  $0.368 \text{ W/kg}$ ; SAR(10 g) =  $0.215 \text{ W/kg}$**

Maximum value of SAR (measured) =  $0.412 \text{ W/kg}$

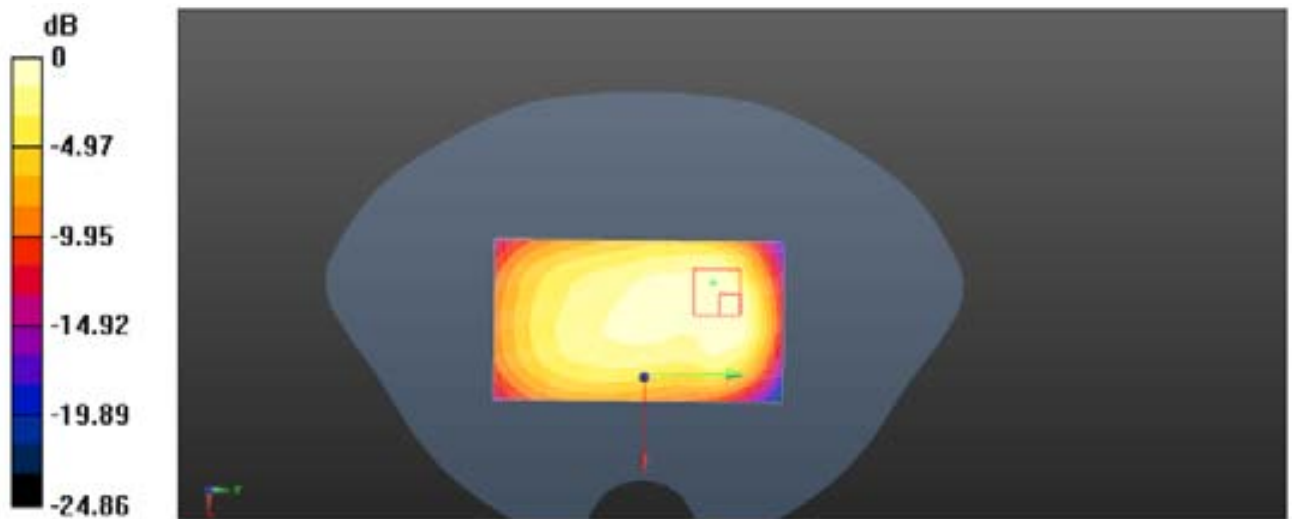

$0\text{dB} = 0.412 \text{ W/kg} = -5.14 \text{ dBW/kg}$

Plot 6: Body Back Side (WCDMA Band V RMC Middle Channel)

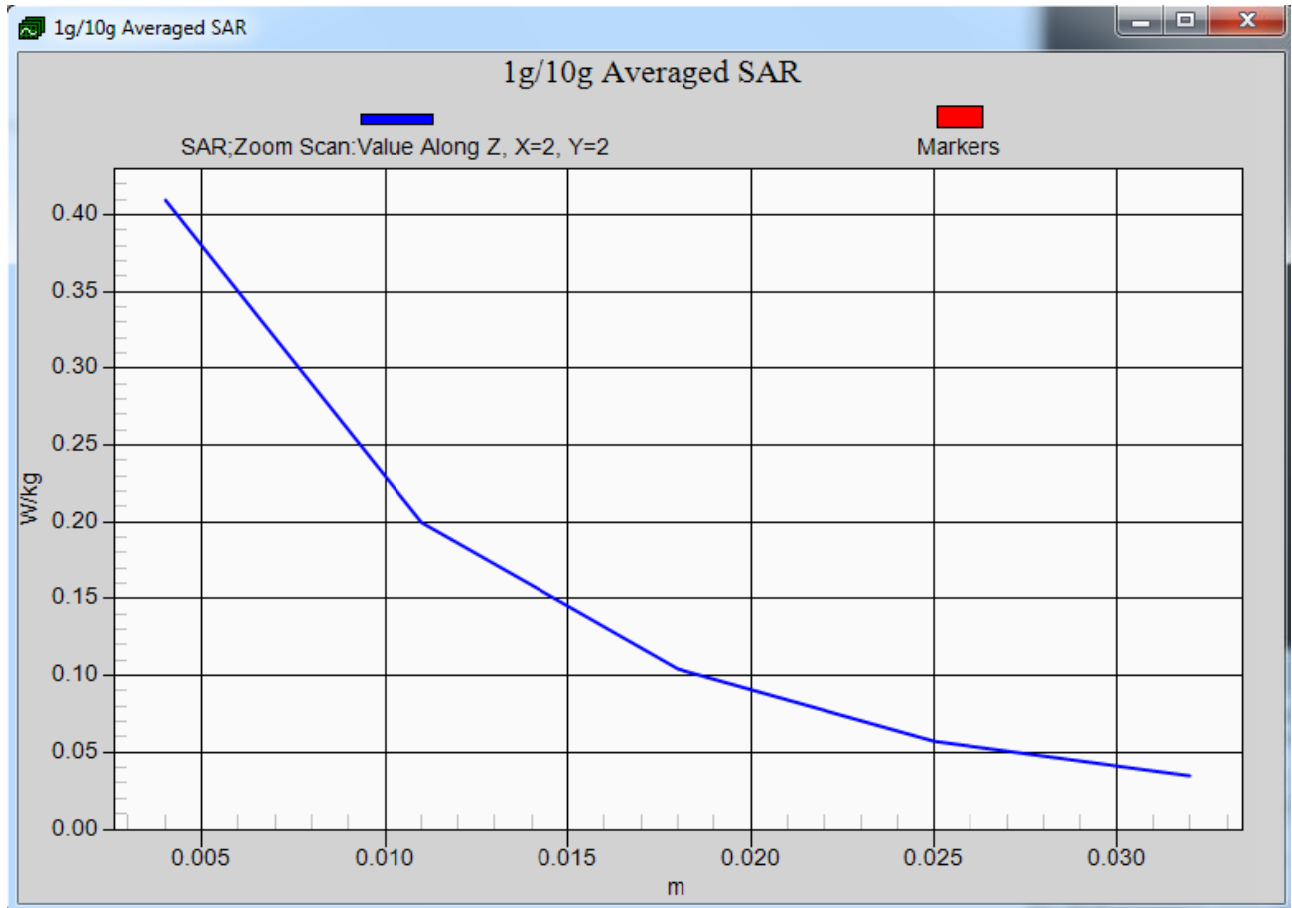

Z-Scan at power reference point- Body Back Side (WCDMA Band V RMC Middle Channel)

**WCDMA Band II Right Head Tilt Middle Channel**

Communication System: Customer System; Frequency: 1880.0 MHz; Duty Cycle: 1:1

Medium parameters used (interpolated):  $f = 1880.0$  MHz;  $\sigma = 1.37$  S/m;  $\epsilon_r = 40.12$ ;  $\rho = 1000$  kg/m<sup>3</sup>

Phantom section : Right Head Section

Probe: EX3DV4 - SN3842; ConvF(7.55, 7.55, 7.55); Calibrated: 06/06/2014;

Sensor-Surface: 4mm (Mechanical Surface Detection)

Electronics: DAE4 Sn1315; Calibrated: 25/11/2013

Phantom: SAM 1; Type: SAM;

Measurement SW: DASY52, Version 52.8 (2); SEMCAD X Version 14.6.6 (6824)

**Area Scan (81x101x1):** Measurement grid: dx=1.50 mm, dy=1.50 mm

Maximum value of SAR (interpolated) = 0.210 W/kg

**Zoom Scan (5x5x5)/Cube 0:** Measurement grid: dx=5mm, dy=5mm, dz=5mm

Reference Value = 7.648 V/m; Power Drift = -0.13 dB

Peak SAR (extrapolated) = 0.248 W/kg

**SAR(1 g) = 0.172 W/kg; SAR(10 g) = 0.131 W/kg**

Maximum value of SAR (measured) = 0.282 W/kg

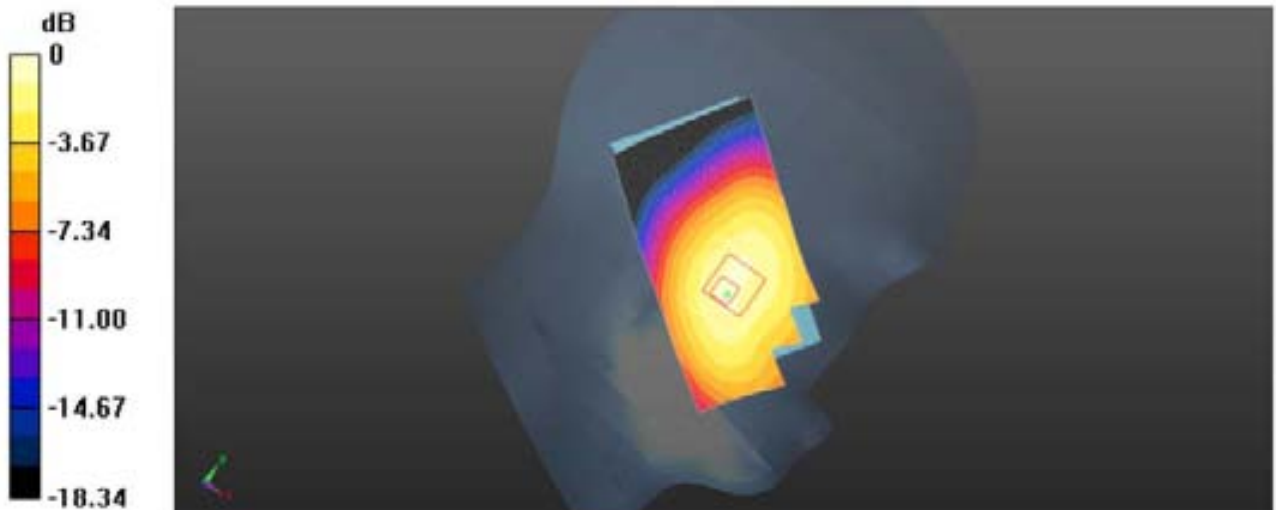

0dB = 0.282 W/kg = -7.16 dBW/kg

Plot 7: Right Head Tilt (WCDMA Band II Middle Channel)

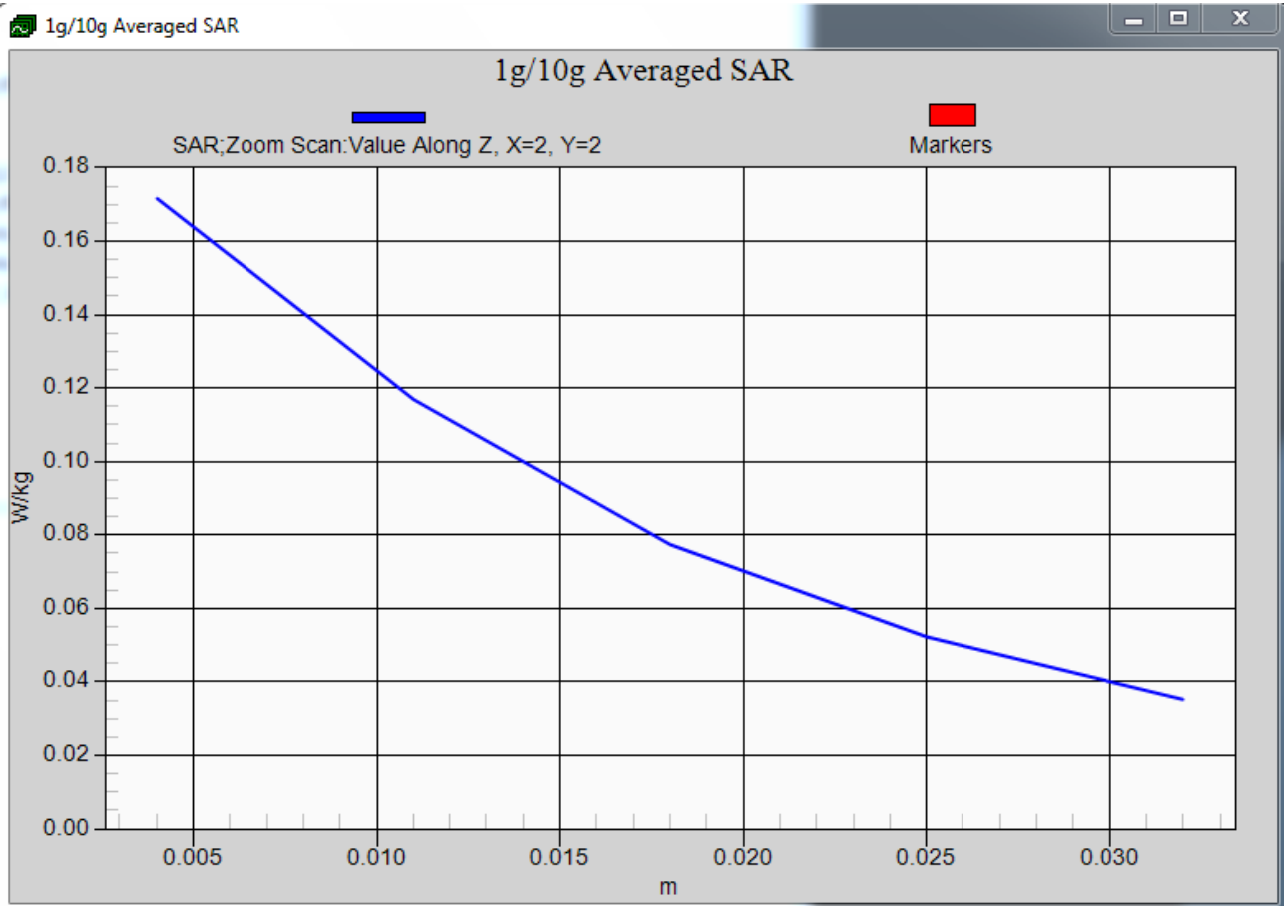

Z-Scan at power reference point- Left Head Touch (WCDMA Band II Middle Channel)

**WCDMA Band II RMC Body Back Side Middle Channel**

Communication System: Customer System; Frequency: 1880.0 MHz; Duty Cycle: 1:1

Medium parameters used (interpolated):  $f = 1880.0$  MHz;  $\sigma = 1.54$  S/m;  $\epsilon_r = 53.27$ ;  $\rho = 1000$  kg/m<sup>3</sup>

Phantom section : Body- worn

Probe: EX3DV4 - SN3842; ConvF(7.43, 7.43, 7.43); Calibrated: 06/06/2014;

Sensor-Surface: 4mm (Mechanical Surface Detection)

Electronics: DAE4 Sn1315; Calibrated: 25/11/2013

Phantom: SAM 1; Type: SAM;

Measurement SW: DASY52, Version 52.8 (2); SEMCAD X Version 14.6.6 (6824)

**Area Scan (81x101x1):** Measurement grid: dx=1.50 mm, dy=1.50 mm

Maximum value of SAR (interpolated) = 0.296 W/kg

**Zoom Scan (5x5x5)/Cube 0:** Measurement grid: dx=5mm, dy=5mm, dz=5mm

Reference Value = 7.816 V/m; Power Drift = -0.01 dB

Peak SAR (extrapolated) = 0.427 W/kg

**SAR(1 g) = 0.252 W/kg; SAR(10 g) = 0.179 W/kg**

Maximum value of SAR (measured) = 0.425 W/kg

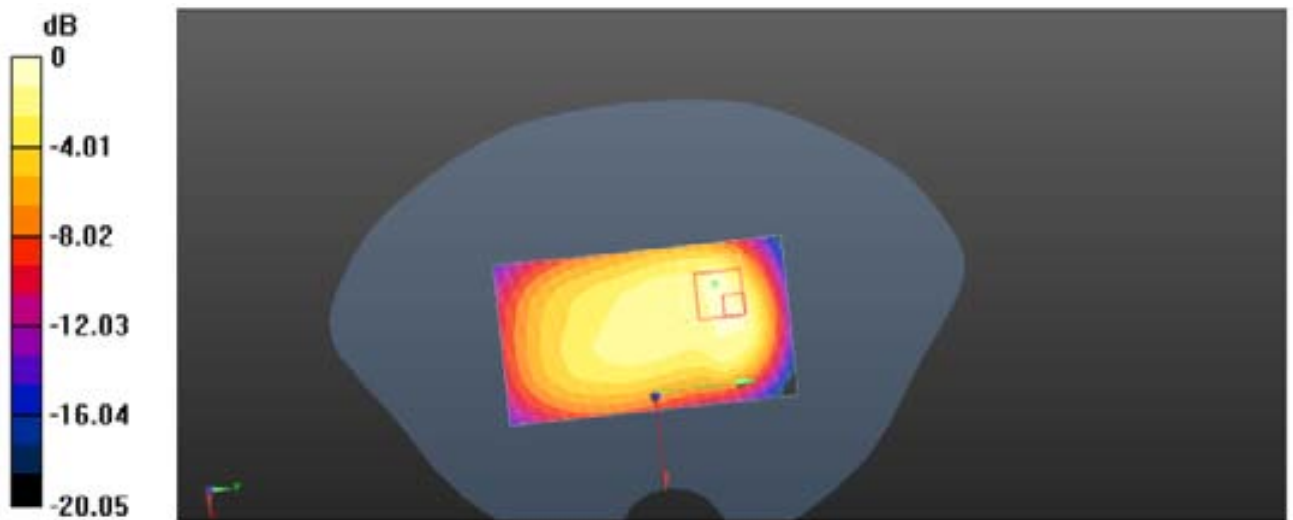

0dB = 0.425 W/kg = -5.39 dBW/kg

Plot 8: Body Back Side (WCDMA Band II RMC Middle Channel)

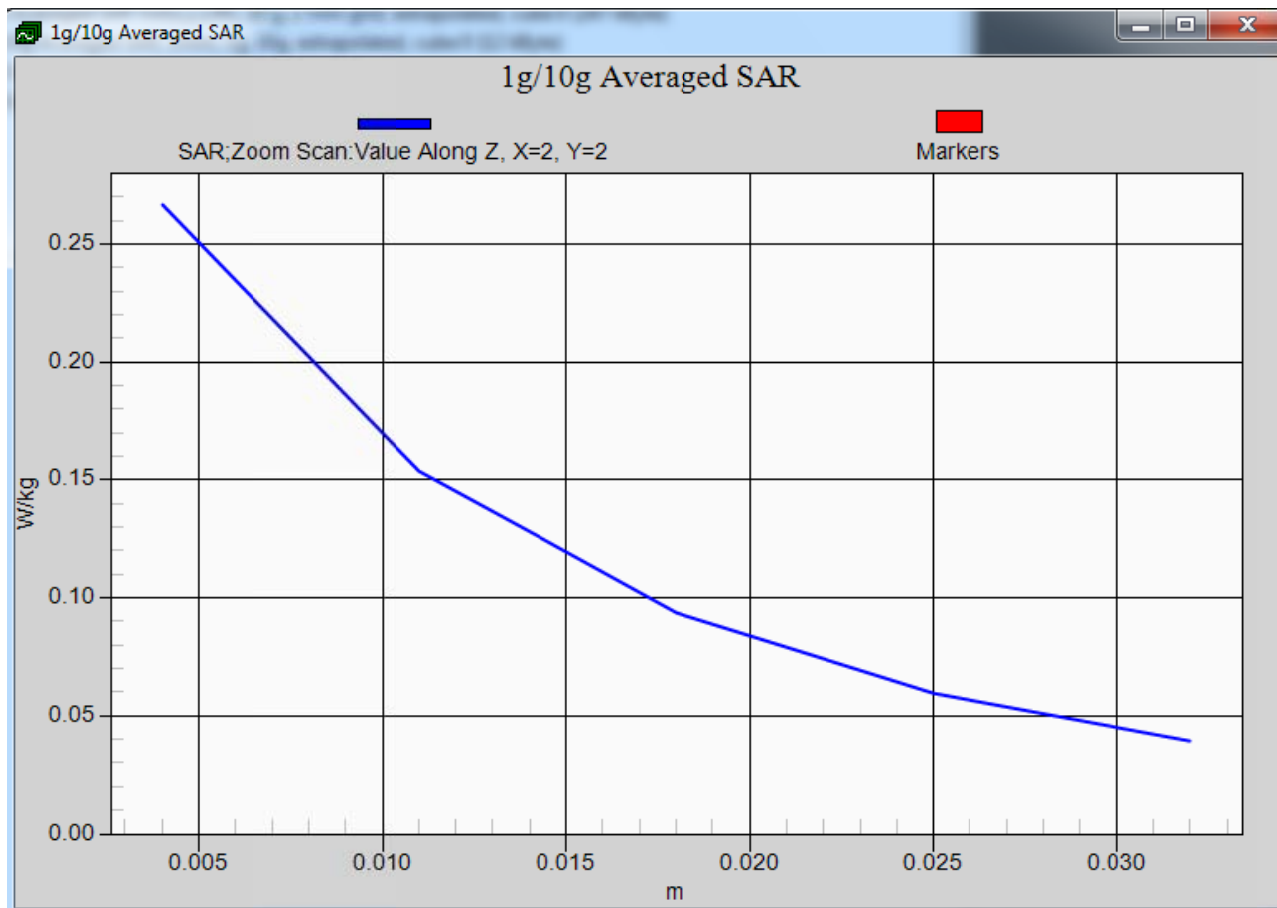

Z-Scan at power reference point- Body Back Side (WCDMA Band II RMC Middle Channel)

**Left Head Cheek (WLAN2450 Middle Channel)**

Communication System: Customer System; Frequency: 2442.0 MHz; Duty Cycle: 1:1

Medium parameters used (interpolated):  $f = 2442.0$  MHz;  $\sigma = 1.82$  S/m;  $\epsilon_r = 38.80$ ;  $\rho = 1000$  kg/m<sup>3</sup>

Phantom section: Left Head Section:

Probe: EX3DV4 - SN3842; ConvF(7.26, 7.26, 7.26); Calibrated: 06/06/2014;

Sensor-Surface: 4mm (Mechanical Surface Detection)

Electronics: DAE4 Sn1315; Calibrated: 25/11/2013

Phantom: SAM 1; Type: SAM;

Measurement SW: DASY52, Version 52.8 (2); SEMCAD X Version 14.6.6 (6824)

**Area Scan (91x51x1):** Measurement grid:  $dx=1.50$  mm,  $dy=1.50$  mm

Maximum value of SAR (interpolated) = 0.372 W/kg

**Zoom Scan (6x6x5)/Cube 0:** Measurement grid:  $dx=5$ mm,  $dy=5$ mm,  $dz=5$ mm

Reference Value = 5.235 V/m; Power Drift = -0.05 dB

Peak SAR (extrapolated) = 0.442 W/kg

**SAR(1 g) = 0.232 W/kg; SAR(10 g) = 0.168 W/kg**

Maximum value of SAR (measured) = 0.473 W/kg

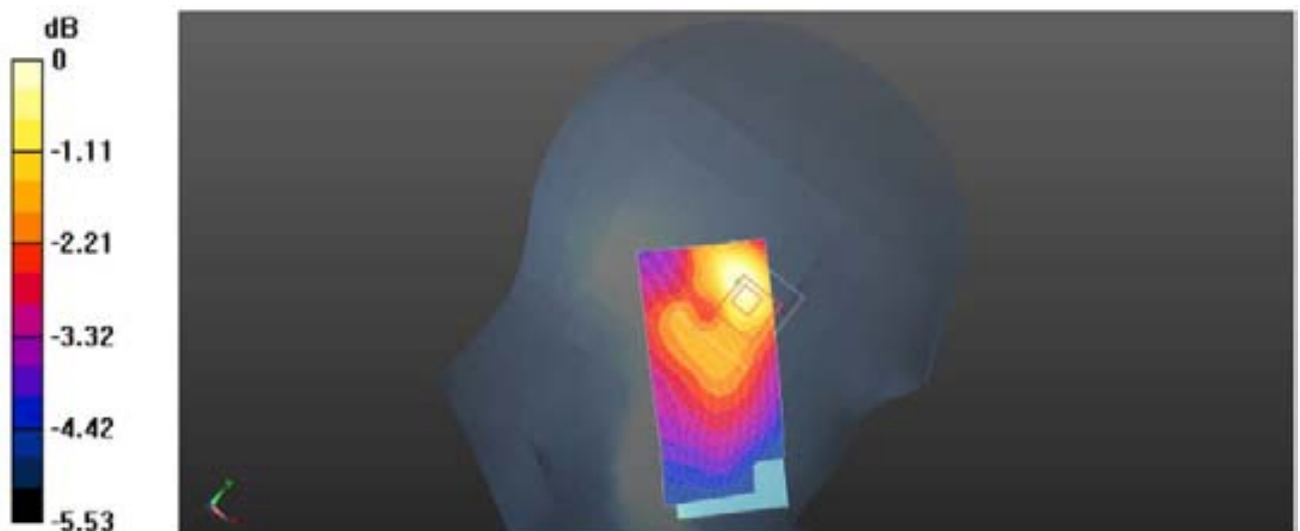

Plot 9: Left Head Cheek (WLAN2450 Middle Channel)



**Body- worn Rear side ( WLAN 802.11b Middle Channel)**

Communication System: Customer System; Frequency: 2442.0 MHz;Duty Cycle:1:1

Medium parameters used (interpolated):  $f = 2442.0$  MHz;  $\sigma = 1.82$  S/m;  $\epsilon_r = 38.80$ ;  $\rho = 1000$  kg/m<sup>3</sup>

Phantom section : Body- worn

Probe: EX3DV4 - SN3842; ConvF(6.93, 6.93, 6.93); Calibrated: 06/06/2014;

Electronics: DAE4 Sn1315; Calibrated: 25/11/2013

Phantom: SAM 1; Type: SAM;

Measurement SW: DASY52, Version 52.8 (2); SEMCAD X Version 14.6.6 (6824)

**Area Scan (61x81x1):** Measurement grid: dx=1.50 mm, dy=1.50 mm

Maximum value of SAR (interpolated) = 0.542 mW/g

**Zoom Scan (5x5x5)/Cube 0:** Measurement grid: dx=5mm, dy=5mm, dz=5mm

Reference Value = 6.373 V/m; Power Drift = -0.07 dB

Peak SAR (extrapolated) = 0.463 W/kg

**SAR(1 g) = 0.314 W/kg; SAR(10 g) = 0.188 W/kg**

Maximum value of SAR (measured) = 0.516 W/kg

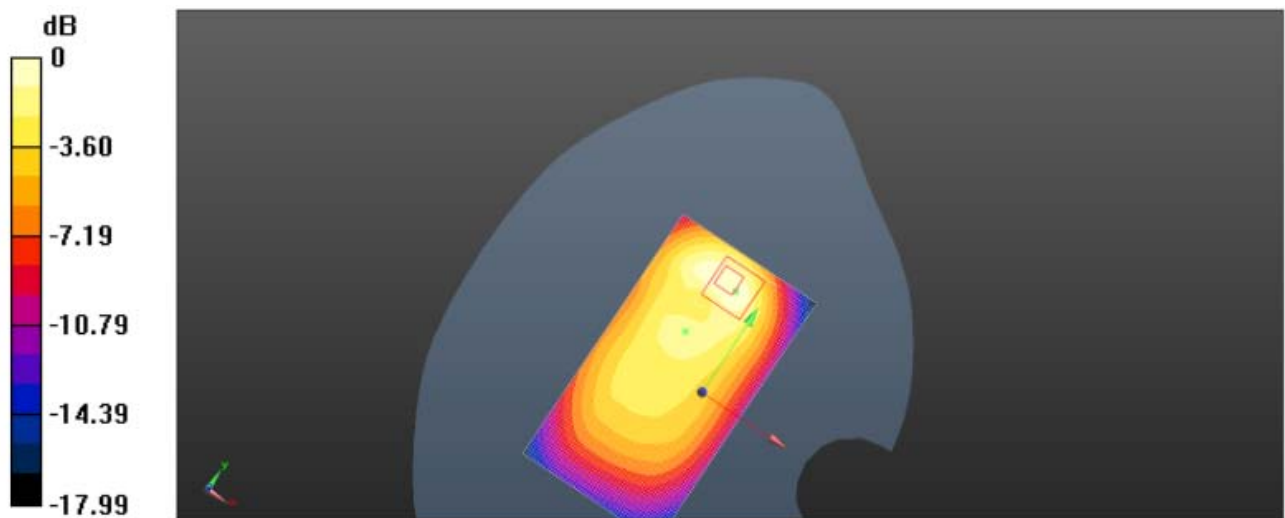

Plot 10: Body- worn Rear side (WLAN802.11b Middle Channel)

## 6. Calibration Certificate

### 6.1. Probe Calibration Certificate

**Calibration Laboratory of  
Schmid & Partner  
Engineering AG**  
Zeughausstrasse 43, 8004 Zurich, Switzerland



**S** Schweizerischer Kalibrierdienst  
**C** Service suisse d'étalonnage  
**S** Servizio svizzero di taratura  
**S** Swiss Calibration Service

Accredited by the Swiss Accreditation Service (SAS)  
The Swiss Accreditation Service is one of the signatories to the EA  
Multilateral Agreement for the recognition of calibration certificates

Accreditation No.: **SCS 108**

Client **CIQ-SZ (Auden)**

Certificate No: **EX3-3842\_Jun13**

### CALIBRATION CERTIFICATE

Object: **EX3DV4 - SN:3842**

Calibration procedure(s): **QA CAL-01.v8, QA CAL-12.v7, QA CAL-23.v4, QA CAL-25.v4  
Calibration procedure for dosimetric E-field probes**

Calibration date: **June 6, 2014**

This calibration certificate documents the traceability to national standards, which realize the physical units of measurements (SI).  
The measurements and the uncertainties with confidence probability are given on the following pages and are part of the certificate.

All calibrations have been conducted in the closed laboratory facility, environment temperature (22 ± 3)°C and humidity < 70%.

Calibration Equipment used (M&TE critical for calibration)

Primary Standards	ID	Cal Date (Certificate No.)	Scheduled Calibration
Power meter E4419B	GB41293874	04-Apr-13 (No. 217-01733)	Apr-14
Power sensor E4412A	MY41499087	04-Apr-13 (No. 217-01733)	Apr-14
Reference 3 dB Attenuator	SN: S5054 (3c)	04-Apr-13 (No. 217-01737)	Apr-14
Reference 20 dB Attenuator	SN: S5277 (20x)	04-Apr-13 (No. 217-01735)	Apr-14
Reference 30 dB Attenuator	SN: S5129 (30b)	04-Apr-13 (No. 217-01738)	Apr-14
Reference Probe ES3DV2	SN: 3013	28-Dec-12 (No. ES3-3013, Dec12)	Dec-13
DAE4	SN: 660	31-Jan-13 (No. DAE4-660, Jan13)	Jan-14
Secondary Standards	ID	Check Date (in house)	Scheduled Check
RF generator HP 8648C	US3642U01700	4-Aug-09 (in house check Apr-13)	In house check: Apr-15
Network Analyzer HP 8753E	US37390585	18-Oct-01 (in house check Oct-12)	In house check: Oct-13

	Name	Function	Signature
Calibrated by	Jeton Kastrati	Laboratory Technician	
Approved by:	Katja Pokovic	Technical Manager	

issued: June 6, 2014

This calibration certificate shall not be reproduced except in full without written approval of the laboratory.

**Calibration Laboratory of  
Schmid & Partner  
Engineering AG**  
Zeughausstrasse 43, 8004 Zurich, Switzerland



**S** Schweizerischer Kalibrierdienst  
**C** Service suisse d'étalonnage  
**S** Servizio svizzero di taratura  
Swiss Calibration Service

Accredited by the Swiss Accreditation Service (SAS)

Accreditation No.: **SCS 108**

The Swiss Accreditation Service is one of the signatories to the EA  
Multilateral Agreement for the recognition of calibration certificates

#### Glossary:

TSL	tissue simulating liquid
NORM <sub>x,y,z</sub>	sensitivity in free space
ConvF	sensitivity in TSL / NORM <sub>x,y,z</sub>
DCP	diode compression point
CF	crest factor (1/duty_cycle) of the RF signal
A, B, C, D	modulation dependent linearization parameters
Polarization $\varphi$	$\varphi$ rotation around probe axis
Polarization $\vartheta$	$\vartheta$ rotation around an axis that is in the plane normal to probe axis (at measurement center), i.e., $\vartheta = 0$ is normal to probe axis

#### Calibration is Performed According to the Following Standards:

- IEEE Std 1528-2013, "IEEE Recommended Practice for Determining the Peak Spatial-Averaged Specific Absorption Rate (SAR) in the Human Head from Wireless Communications Devices: Measurement Techniques", December 2013
- IEC 62209-1, "Procedure to measure the Specific Absorption Rate (SAR) for hand-held devices used in close proximity to the ear (frequency range of 300 MHz to 3 GHz)", February 2005

#### Methods Applied and Interpretation of Parameters:

- NORM<sub>x,y,z</sub>**: Assessed for E-field polarization  $\vartheta = 0$  ( $f \leq 900$  MHz in TEM-cell;  $f > 1800$  MHz: R22 waveguide). NORM<sub>x,y,z</sub> are only intermediate values, i.e., the uncertainties of NORM<sub>x,y,z</sub> does not affect the  $E^2$ -field uncertainty inside TSL (see below *ConvF*).
- NORM(f)<sub>x,y,z</sub>** = NORM<sub>x,y,z</sub> \* frequency\_response (see Frequency Response Chart). This linearization is implemented in DASY4 software versions later than 4.2. The uncertainty of the frequency response is included in the stated uncertainty of *ConvF*.
- DCP<sub>x,y,z</sub>**: DCP are numerical linearization parameters assessed based on the data of power sweep with CW signal (no uncertainty required). DCP does not depend on frequency nor media.
- PAR**: PAR is the Peak to Average Ratio that is not calibrated but determined based on the signal characteristics
- A<sub>x,y,z</sub>; B<sub>x,y,z</sub>; C<sub>x,y,z</sub>; D<sub>x,y,z</sub>; VR<sub>x,y,z</sub>**: A, B, C, D are numerical linearization parameters assessed based on the data of power sweep for specific modulation signal. The parameters do not depend on frequency nor media. VR is the maximum calibration range expressed in RMS voltage across the diode.
- ConvF and Boundary Effect Parameters**: Assessed in flat phantom using E-field (or Temperature Transfer Standard for  $f \leq 800$  MHz) and inside waveguide using analytical field distributions based on power measurements for  $f > 800$  MHz. The same setups are used for assessment of the parameters applied for boundary compensation (alpha, depth) of which typical uncertainty values are given. These parameters are used in DASY4 software to improve probe accuracy close to the boundary. The sensitivity in TSL corresponds to NORM<sub>x,y,z</sub> \* ConvF whereby the uncertainty corresponds to that given for ConvF. A frequency dependent ConvF is used in DASY version 4.4 and higher which allows extending the validity from  $\pm 50$  MHz to  $\pm 100$  MHz.
- Spherical isotropy (3D deviation from isotropy)**: in a field of low gradients realized using a flat phantom exposed by a patch antenna.
- Sensor Offset**: The sensor offset corresponds to the offset of virtual measurement center from the probe tip (on probe axis). No tolerance required.

EX3DV4 – SN:3842

June 6, 2014

# Probe EX3DV4

## SN:3842

Manufactured:	October 25, 2011
Repaired:	June 3, 2014
Calibrated:	June 6, 2014

Calibrated for DASY/EASY Systems  
(Note: non-compatible with DASY2 system!)

EX3DV4- SN:3842

June 6, 2014

## DASY/EASY - Parameters of Probe: EX3DV4 - SN:3842

### Basic Calibration Parameters

	Sensor X	Sensor Y	Sensor Z	Unc (k=2)
Norm ( $\mu\text{V}/(\text{V}/\text{m})^2$ ) <sup>A</sup>	0.35	0.52	0.42	± 10.1 %
DCP (mV) <sup>B</sup>	104.7	100.4	100.5	

### Modulation Calibration Parameters

UID	Communication System Name		A dB	B dB $\sqrt{\mu\text{V}}$	C	D dB	VR mV	Unc <sup>E</sup> (k=2)
0	CW	X	0.0	0.0	1.0	0.00	132.3	±3.5 %
		Y	0.0	0.0	1.0		162.7	
		Z	0.0	0.0	1.0		147.6	

The reported uncertainty of measurement is stated as the standard uncertainty of measurement multiplied by the coverage factor k=2, which for a normal distribution corresponds to a coverage probability of approximately 95%.

<sup>A</sup> The uncertainties of NormX,Y,Z do not affect the E<sup>2</sup>-field uncertainty inside TSL (see Pages 5 and 6).

<sup>B</sup> Numerical linearization parameter: uncertainty not required.

<sup>E</sup> Uncertainty is determined using the max. deviation from linear response applying rectangular distribution and is expressed for the square of the field value.

EX3DV4- SN:3842

June 6, 2014

## DASY/EASY - Parameters of Probe: EX3DV4 - SN:3842

### Calibration Parameter Determined in Head Tissue Simulating Media

f (MHz) <sup>C</sup>	Relative Permittivity <sup>F</sup>	Conductivity (S/m) <sup>F</sup>	ConvF X	ConvF Y	ConvF Z	Alpha	Depth (mm)	Unct. (k=2)
450	43.5	0.87	10.00	10.00	10.00	0.15	1.10	± 13.4 %
835	41.5	0.91	8.83	8.83	8.83	0.28	1.07	± 12.0 %
900	41.5	0.97	8.78	8.78	8.78	0.32	1.00	± 12.0 %
1810	40.0	1.40	7.68	7.68	7.68	0.38	0.88	± 12.0 %
1900	40.0	1.40	7.55	7.55	7.55	0.50	0.77	± 12.0 %
2450	39.2	1.80	7.26	7.26	7.26	0.71	0.63	± 12.0 %

<sup>C</sup> Frequency validity of ± 100 MHz only applies for DASY v4.4 and higher (see Page 2), else it is restricted to ± 50 MHz. The uncertainty is the RSS of the ConvF uncertainty at calibration frequency and the uncertainty for the indicated frequency band.

<sup>F</sup> At frequencies below 3 GHz, the validity of tissue parameters ( $\epsilon$  and  $\sigma$ ) can be relaxed to ± 10% if liquid compensation formula is applied to measured SAR values. At frequencies above 3 GHz, the validity of tissue parameters ( $\epsilon$  and  $\sigma$ ) is restricted to ± 5%. The uncertainty is the RSS of the ConvF uncertainty for indicated target tissue parameters.

EX3DV4- SN:3842

June 6, 2014

## DASY/EASY - Parameters of Probe: EX3DV4 - SN:3842

### Calibration Parameter Determined in Body Tissue Simulating Media

f (MHz) <sup>C</sup>	Relative Permittivity <sup>F</sup>	Conductivity (S/m) <sup>F</sup>	ConvF X	ConvF Y	ConvF Z	Alpha	Depth (mm)	Unct. (k=2)
450	56.7	0.94	10.34	10.34	10.34	0.09	1.00	± 13.4 %
835	55.2	0.98	9.09	9.09	9.09	0.42	0.84	± 12.0 %
900	55.0	1.05	9.16	9.16	9.16	0.47	0.79	± 12.0 %
1810	53.3	1.52	7.78	7.78	7.78	0.50	0.81	± 12.0 %
1900	53.3	1.52	7.43	7.43	7.43	0.29	1.07	± 12.0 %
2450	52.7	1.95	6.93	6.93	6.93	0.80	0.59	± 12.0 %

<sup>C</sup> Frequency validity of ± 100 MHz only applies for DASY v4.4 and higher (see Page 2), else it is restricted to ± 50 MHz. The uncertainty is the RSS of the ConvF uncertainty at calibration frequency and the uncertainty for the indicated frequency band.

<sup>F</sup> At frequencies below 3 GHz, the validity of tissue parameters ( $\epsilon$  and  $\sigma$ ) can be relaxed to ± 10% if liquid compensation formula is applied to measured SAR values. At frequencies above 3 GHz, the validity of tissue parameters ( $\epsilon$  and  $\sigma$ ) is restricted to ± 5%. The uncertainty is the RSS of the ConvF uncertainty for indicated target tissue parameters.

EX3DV4-SN:3842

June 6, 2014

### Frequency Response of E-Field (TEM-Cell:ifi110 EXX, Waveguide: R22)

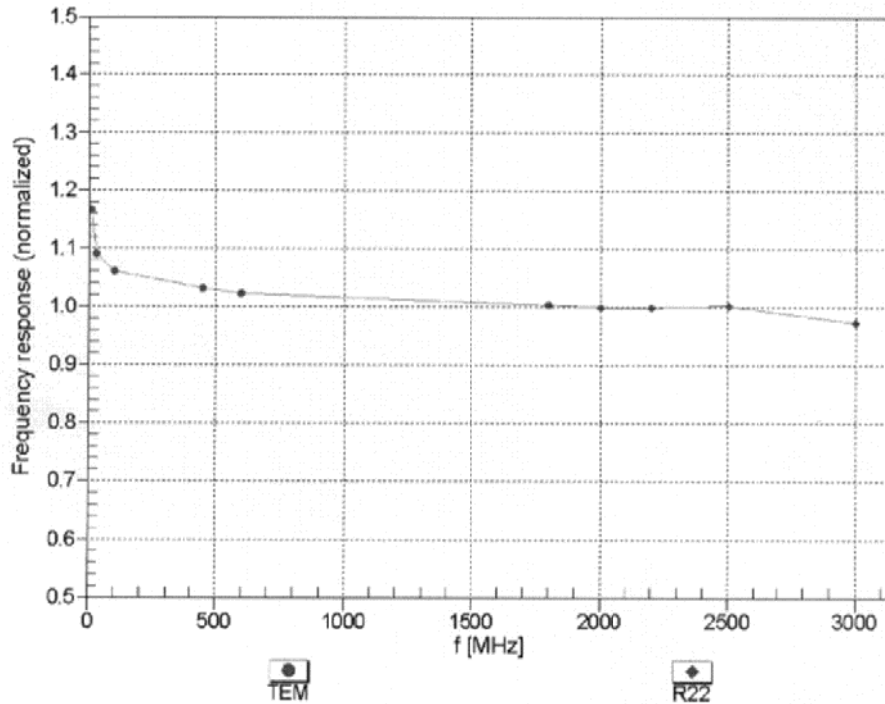

Uncertainty of Frequency Response of E-field:  $\pm 6.3\%$  (k=2)



EX3DV4- SN:3842

June 6, 2014

### Receiving Pattern ( $\phi$ ), $\theta = 0^\circ$

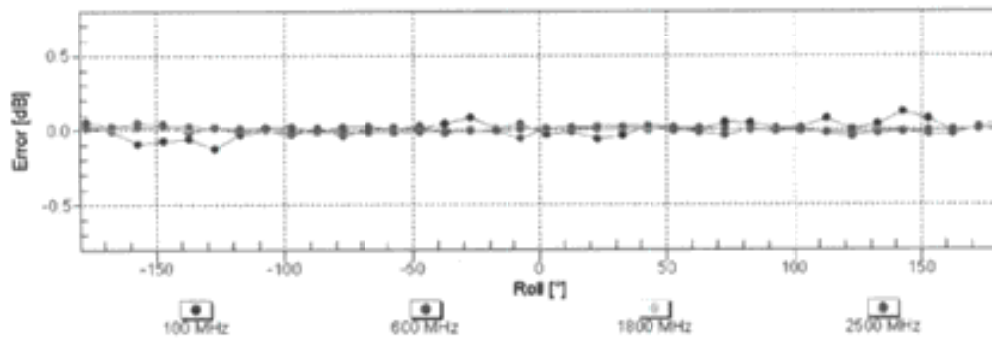
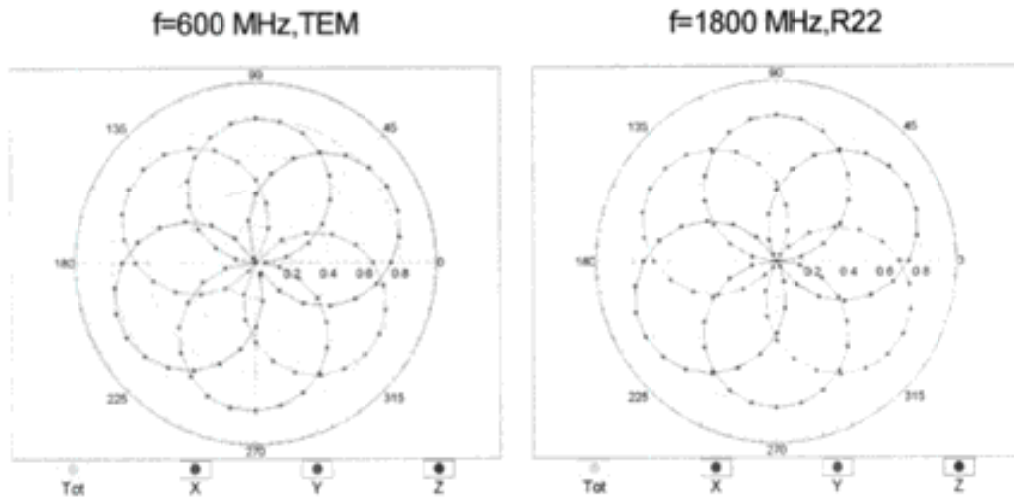

Uncertainty of Axial Isotropy Assessment:  $\pm 0.5\%$  ( $k=2$ )

EX3DV4- SN:3842

June 6, 2014

### Dynamic Range $f(\text{SAR}_{\text{head}})$ (TEM cell , $f = 900 \text{ MHz}$ )

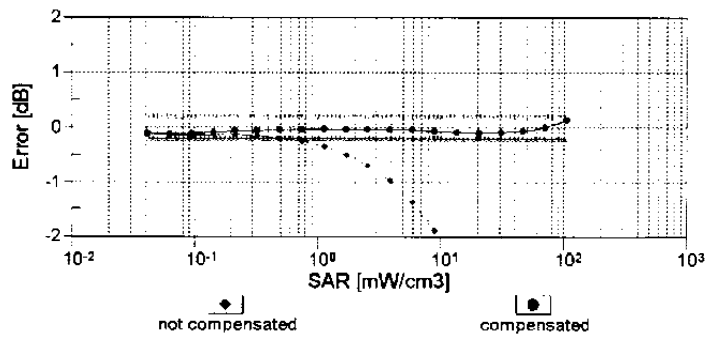
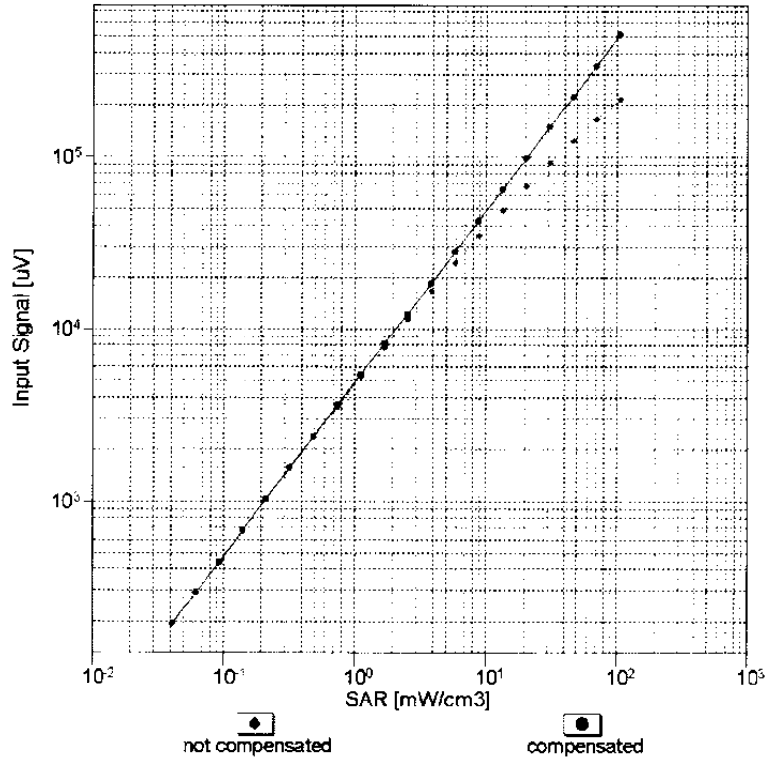

Uncertainty of Linearity Assessment:  $\pm 0.6\%$  ( $k=2$ )

EX3DV4- SN:3842

June 6, 2014

### Conversion Factor Assessment

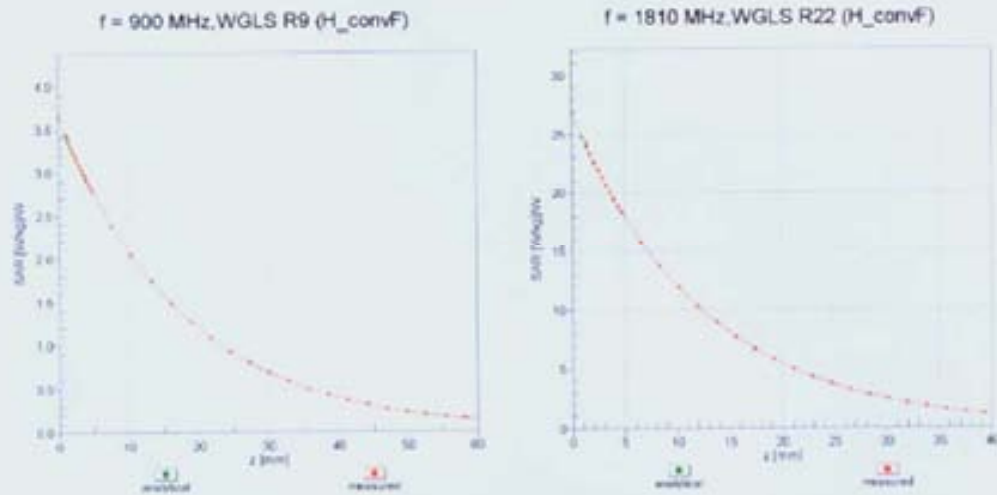

### Deviation from Isotropy in Liquid Error ( $\phi, \theta$ ), f = 900 MHz

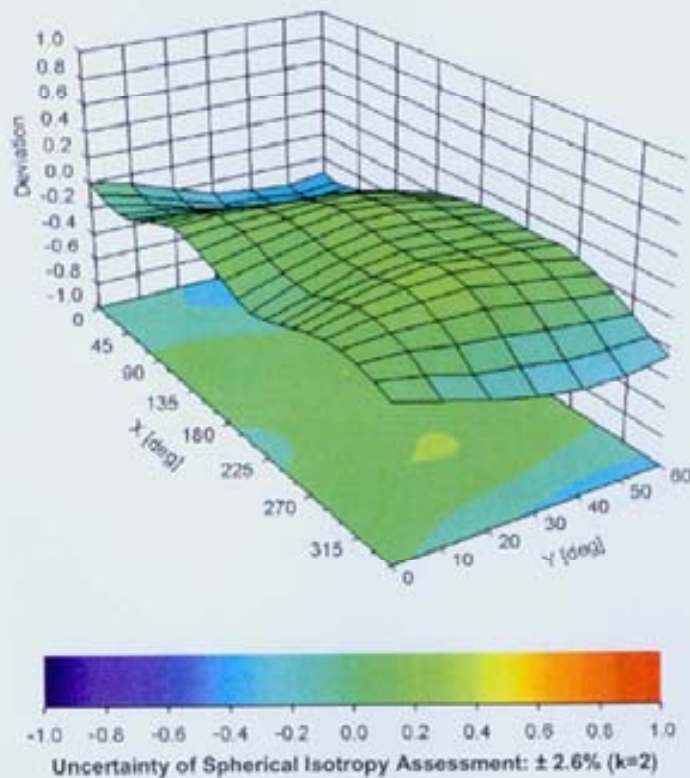

EX3DV4- SN:3842

June 6, 2014

**DASY/EASY - Parameters of Probe: EX3DV4 - SN:3842****Other Probe Parameters**

Sensor Arrangement	Triangular
Connector Angle (°)	-117,4
Mechanical Surface Detection Mode	enabled
Optical Surface Detection Mode	disabled
Probe Overall Length	337 mm
Probe Body Diameter	10 mm
Tip Length	9 mm
Tip Diameter	2.5 mm
Probe Tip to Sensor X Calibration Point	1 mm
Probe Tip to Sensor Y Calibration Point	1 mm
Probe Tip to Sensor Z Calibration Point	1 mm
Recommended Measurement Distance from Surface	2 mm

6.2. D835V2 Dipole Calibration Certificate



Add: No.52 Huayuanbei Road, Haidian District, Beijing, 100191, China  
 Tel: +86-10-62304833-2079 Fax: +86-10-62304833-2504  
 E-mail: Info@emcrite.com <http://www.emcrite.com>

In Collaboration with  
**s p e a g**  
 CALIBRATION LABORATORY



Client **CIQ SZ (Auden)**

Certificate No: **J13-2-3049**

**CALIBRATION CERTIFICATE**

Object **D835V2 - SN: 4d134**

Calibration Procedure(s) **TMC-OS-E-02-194**  
 Calibration procedure for dipole validation kits

Calibration date: **December 13, 2013**

This calibration Certificate documents the traceability to national standards, which realize the physical units of measurements(SI). The measurements and the uncertainties with confidence probability are given on the following pages and are part of the certificate.

All calibrations have been conducted in the closed laboratory facility: environment temperature(22±3)°C and humidity<70%.

Calibration Equipment used (M&TE critical for calibration)

Primary Standards	ID #	Cal Date(Calibrated by, Certificate No.)	Scheduled Calibration
Power Meter NRVD	102083	11-Sep-13 (TMC, No.JZ13-443)	Sep-14
Power sensor NRV-Z5	100595	11-Sep-13 (TMC, No. JZ13-443)	Sep -14
Reference Probe ES3DV3	SN 3149	5- Sep-13 (SPEAG, No.ES3-3149_Sep13)	Sep-14
DAE4	SN 777	22-Feb-13 (SPEAG, DAE4-777_Feb13)	Feb -14
Signal Generator E4438C	MY49070393	13-Nov-13 (TMC, No.JZ13-394)	Nov-14
Network Analyzer E8362B	MY43021135	19-Oct-13 (TMC, No.JZ13-278)	Oct-14

	Name	Function	Signature
Calibrated by:	Zhao Jing	SAR Test Engineer	
Reviewed by:	Qi Dianyuan	SAR Project Leader	
Approved by:	Lu Bingsong	Deputy Director of the laboratory	

Issued: December 17, 2013

This calibration certificate shall not be reproduced except in full without written approval of the laboratory.



In Collaboration with  
**s p e a g**  
 CALIBRATION LABORATORY

Add: No.52 Huayuanbei Road, Haidian District, Beijing, 100191, China  
 Tel: +86-10-62304633-2079 Fax: +86-10-62304633-2504  
 E-mail: Info@emcite.com [Http://www.emcite.com](http://www.emcite.com)

#### Glossary:

TSL	tissue simulating liquid
ConvF	sensitivity in TSL / NORM <sub>x,y,z</sub>
N/A	not applicable or not measured

#### Calibration is Performed According to the Following Standards:

- IEEE Std 1528-2013, "IEEE Recommended Practice for Determining the Peak Spatial-Averaged Specific Absorption Rate (SAR) in the Human Head from Wireless Communications Devices: Measurement Techniques", June 2013
- IEC 62209-1, "Procedure to measure the Specific Absorption Rate (SAR) For hand-held devices used in close proximity to the ear (frequency range of 300MHz to 3GHz)", February 2005
- KDB865664, SAR Measurement Requirements for 100 MHz to 6 GHz

#### Additional Documentation:

- DASY4/5 System Handbook

#### Methods Applied and Interpretation of Parameters:

- Measurement Conditions:* Further details are available from the Validation Report at the end of the certificate. All figures stated in the certificate are valid at the frequency indicated.
- Antenna Parameters with TSL:* The dipole is mounted with the spacer to position its feed point exactly below the center marking of the flat phantom section, with the arms oriented parallel to the body axis.
- Feed Point Impedance and Return Loss:* These parameters are measured with the dipole positioned under the liquid filled phantom. The impedance stated is transformed from the measurement at the SMA connector to the feed point. The Return Loss ensures low reflected power. No uncertainty required.
- Electrical Delay:* One-way delay between the SMA connector and the antenna feed point. No uncertainty required.
- SAR measured:* SAR measured at the stated antenna input power.
- SAR normalized:* SAR as measured, normalized to an input power of 1 W at the antenna connector.
- SAR for nominal TSL parameters:* The measured TSL parameters are used to calculate the nominal SAR result.

The reported uncertainty of measurement is stated as the standard uncertainty of Measurement multiplied by the coverage factor  $k=2$ , which for a normal distribution corresponds to a coverage probability of approximately 95%.



In Collaboration with  
**s p e a g**  
 CALIBRATION LABORATORY

Add: No.52 Huayuanbei Road, Haidian District, Beijing, 100191, China  
 Tel: +86-10-62304633-2079 Fax: +86-10-62304633-2504  
 E-mail: info@emcite.com Http://www.emcite.com

### Measurement Conditions

DASY system configuration, as far as not given on page 1.

DASY Version	DASY52	52.8.7.1137
Extrapolation	Advanced Extrapolation	
Phantom	Twin Phantom	
Distance Dipole Center - TSL	15 mm	with Spacer
Zoom Scan Resolution	dx, dy, dz = 5 mm	
Frequency	835 MHz $\pm$ 1 MHz	

### Head TSL parameters

The following parameters and calculations were applied.

	Temperature	Permittivity	Conductivity
Nominal Head TSL parameters	22.0 °C	41.5	0.90 mho/m
Measured Head TSL parameters	(22.0 $\pm$ 0.2) °C	41.7 $\pm$ 6 %	0.88 mho/m $\pm$ 6 %
Head TSL temperature change during test	<0.5 °C	---	---

### SAR result with Head TSL

SAR averaged over 1 cm <sup>3</sup> (1 g) of Head TSL	Condition	
SAR measured	250 mW input power	2.38 mW / g
SAR for nominal Head TSL parameters	normalized to 1W	9.66 mW / g $\pm$ 20.8 % (k=2)
SAR averaged over 10 cm <sup>3</sup> (10 g) of Head TSL	Condition	
SAR measured	250 mW input power	1.55 mW / g
SAR for nominal Head TSL parameters	normalized to 1W	6.27 mW / g $\pm$ 20.4 % (k=2)

### Body TSL parameters

The following parameters and calculations were applied.

	Temperature	Permittivity	Conductivity
Nominal Body TSL parameters	22.0 °C	55.2	0.97 mho/m
Measured Body TSL parameters	(22.0 $\pm$ 0.2) °C	56.3 $\pm$ 6 %	0.97 mho/m $\pm$ 6 %
Body TSL temperature change during test	<0.5 °C	---	---

### SAR result with Body TSL

SAR averaged over 1 cm <sup>3</sup> (1 g) of Body TSL	Condition	
SAR measured	250 mW input power	2.32 mW / g
SAR for nominal Body TSL parameters	normalized to 1W	9.36 mW / g $\pm$ 20.8 % (k=2)
SAR averaged over 10 cm <sup>3</sup> (10 g) of Body TSL	Condition	
SAR measured	250 mW input power	1.54 mW / g
SAR for nominal Body TSL parameters	normalized to 1W	6.20 mW / g $\pm$ 20.4 % (k=2)



In Collaboration with  
**s p e a g**  
 CALIBRATION LABORATORY

Add: No.52 Huayuanbei Road, Haidian District, Beijing, 100191, China  
 Tel: +86-10-62304633-2079 Fax: +86-10-62304633-2504  
 E-mail: info@emcite.com [Http://www.emcite.com](http://www.emcite.com)

## Appendix

### Antenna Parameters with Head TSL

Impedance, transformed to feed point	$52.5\Omega + 3.14j\Omega$
Return Loss	- 28.1dB

### Antenna Parameters with Body TSL

Impedance, transformed to feed point	$49.2\Omega + 2.90j\Omega$
Return Loss	- 30.4dB

### General Antenna Parameters and Design

Electrical Delay (one direction)	1.241 ns
----------------------------------	----------

After long term use with 100W radiated power, only a slight warming of the dipole near the feedpoint can be measured.

The dipole is made of standard semirigid coaxial cable. The center conductor of the feeding line is directly connected to the second arm of the dipole. The antenna is therefore short-circuited for DC-signals. On some of the dipoles, small end caps are added to the dipole arms in order to improve matching when loaded according to the position as explained in the "Measurement Conditions" paragraph. The SAR data are not affected by this change. The overall dipole length is still according to the Standard.

No excessive force must be applied to the dipole arms, because they might bend or the soldered connections near the feedpoint may be damaged.

### Additional EUT Data

Manufactured by	SPEAG
-----------------	-------



**DASY5 Validation Report for Head TSL**

Date: 12.11.2013

Test Laboratory: TMC, Beijing, China

**DUT: Dipole 835 MHz; Type: D835V2; Serial: D835V2 - SN: 4d134**

Communication System: CW; Frequency: 835 MHz

Medium parameters used:  $f = 835$  MHz;  $\sigma = 0.884$  mho/m;  $\epsilon_r = 41.65$ ;  $\rho = 1000$  kg/m<sup>3</sup>

Phantom section: Flat Section

Measurement Standard: DASY5 (IEEE/IEC/ANSI C63.19-2007)

**DASY5 Configuration:**

- Probe: ES3DV3 - SN3149; ConvF(6.21,6.21,6.21); Calibrated: 2013/9/5
- Sensor-Surface: 3mm (Mechanical Surface Detection)
- Electronics: DAE4 Sn777; Calibrated: 22/2/2013
- Phantom: SAM 1186; Type: QD000P40CC;
- Measurement SW: DASY52 52.8.7(1137); SEMCAD X Version 14.6.10 (7164)

**Dipole Calibration for Head Tissue/Pin=250mW, d=15mm/Zoom Scan****(7x7x7)/Cube 0:** Measurement grid: dx=5mm, dy=5mm, dz=5mm

Reference Value = 48.581 V/m; Power Drift = -0.01 dB

Peak SAR (extrapolated) = 3.57 W/kg

**SAR(1 g) = 2.38 W/kg; SAR(10 g) = 1.55 W/kg**

Maximum value of SAR (measured) = 2.80 W/kg

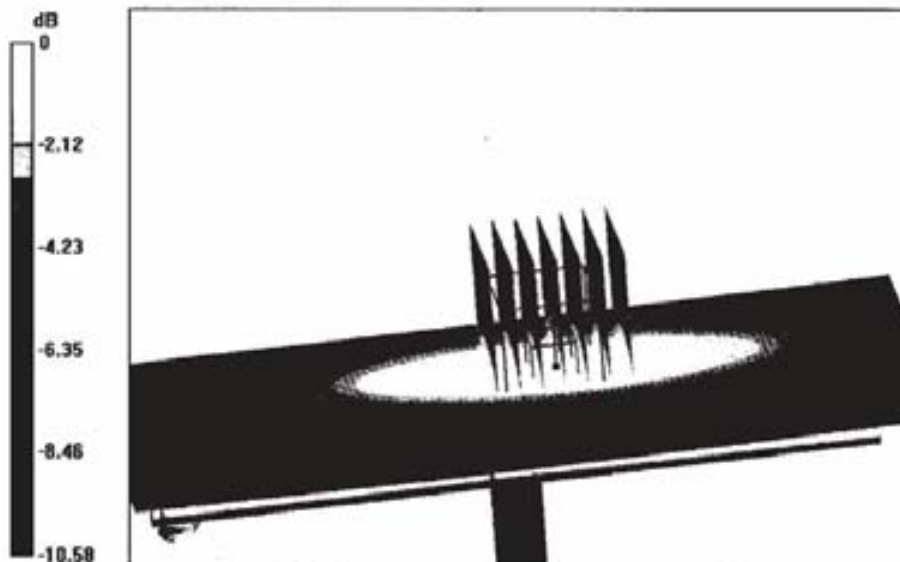

0 dB = 2.80 W/kg = 4.47 dBW/kg



In Collaboration with  
**s p e a g**  
CALIBRATION LABORATORY

Add: No.52 Huayuanbei Road, Haidian District, Beijing, 100191, China  
Tel: +86-10-82304633-2079 Fax: +86-10-82304633-2504  
E-mail: info@emcite.com [Http://www.emcite.com](http://www.emcite.com)

### Impedance Measurement Plot for Head TSL

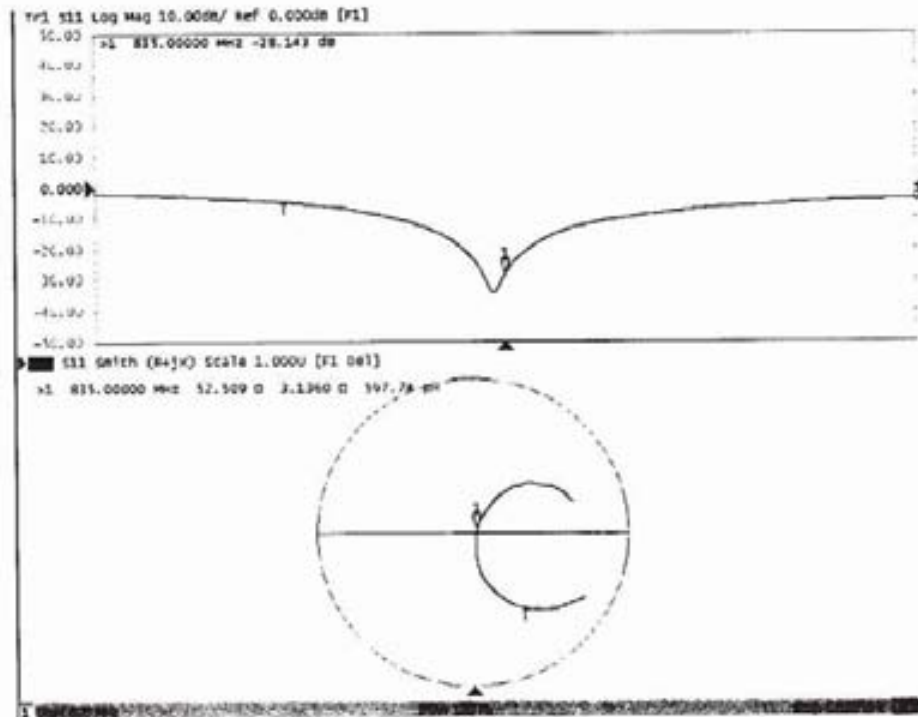

**DASY5 Validation Report for Body TSL**

Date: 12.13.2013

Test Laboratory: TMC, Beijing, China

**DUT: Dipole 835 MHz; Type: D835V2; Serial: D835V2 - SN: 4d134**

Communication System: CW; Frequency: 835 MHz;

Medium parameters used:  $f = 835$  MHz;  $\sigma = 0.965$  mho/m;  $\epsilon_r = 56.32$ ;  $\rho = 1000$  kg/m<sup>3</sup>

Phantom section: Flat Section

Measurement Standard: DASY5 (IEEE/IEC/ANSI C63.19-2007)

**DASY5 Configuration:**

- Probe: ES3DV3 - SN3149; ConvF(5.98,5.98,5.98) ; Calibrated: 2013/9/5
- Sensor-Surface: 3mm (Mechanical Surface Detection)
- Electronics: DAE4 Sn777; Calibrated: 22/2/2013
- Phantom: SAM 1186; Type: QD000P40CC;
- Measurement SW: DASY52 52.8.7(1137); SEMCAD X Version 14.6.10 (7164)

**Dipole Calibration for Body Tissue/Pin=250mW, d=15mm/Zoom Scan****(7x7x7)/Cube 0:** Measurement grid: dx=5mm, dy=5mm, dz=5mm

Reference Value = 52.271 V/m; Power Drift = -0.02 dB

Peak SAR (extrapolated) = 3.38 W/kg

**SAR(1 g) = 2.32 W/kg; SAR(10 g) = 1.54 W/kg**

Maximum value of SAR (measured) = 2.69 W/kg



0 dB = 2.69 W/kg = 4.30 dBW/kg



In Collaboration with  
**s p e a g**  
CALIBRATION LABORATORY

Add: No.52 Huayuanbei Road, Haidian District, Beijing, 100191, China  
Tel: +86-10-62304633-2079 Fax: +86-10-62304633-2504  
E-mail: Info@emcite.com [Http://www.emcite.com](http://www.emcite.com)

### Impedance Measurement Plot for Body TSL

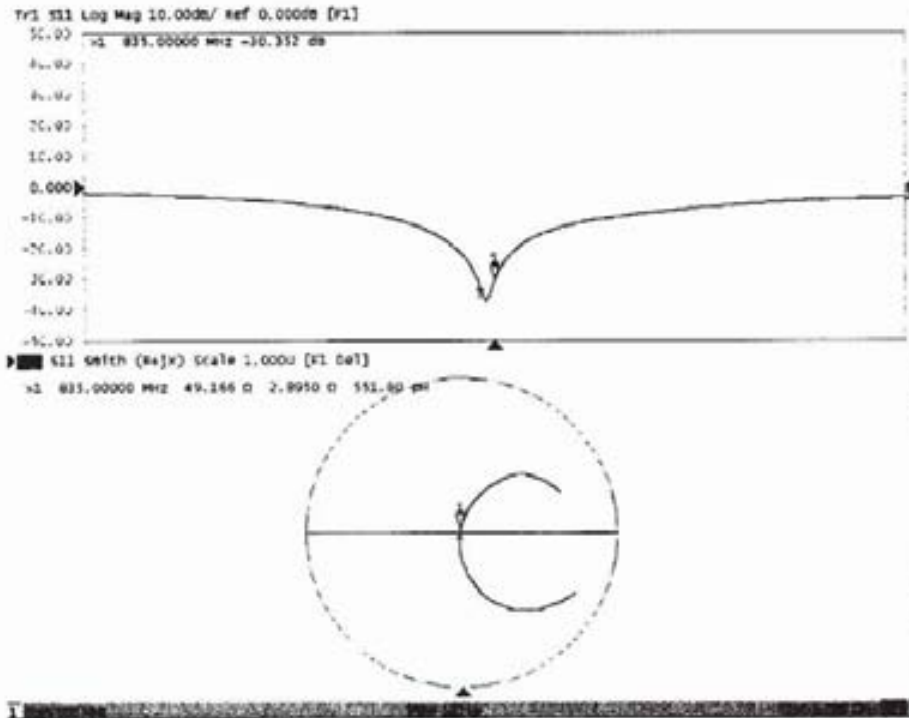

6.3. D1900V2 Dipole Calibration Certificate



In Collaboration with  
**s p e a g**  
 CALIBRATION LABORATORY

Add: No.52 Huayuanbei Road, Haidian District, Beijing, 100191, China  
 Tel: +86-10-62304633-2079 Fax: +86-10-62304633-2504  
 E-mail: info@emcite.com Http://www.emcite.com



Client **CIQ SZ (Auden)**

Certificate No: **J13-2-3052**

**CALIBRATION CERTIFICATE**

Object **D1900V2 - SN: 5d150**

Calibration Procedure(s) **TMC-OS-E-02-194**  
 Calibration procedure for dipole validation kits

Calibration date: **December 12, 2013**

This calibration Certificate documents the traceability to national standards, which realize the physical units of measurements(SI). The measurements and the uncertainties with confidence probability are given on the following pages and are part of the certificate.

All calibrations have been conducted in the closed laboratory facility: environment temperature(22±3)°C and humidity<70%.

Calibration Equipment used (M&TE critical for calibration)

Primary Standards	ID #	Cal Date(Calibrated by, Certificate No.)	Scheduled Calibration
Power Meter NRVD	102083	11-Sep-13 (TMC, No.JZ13-443)	Sep-14
Power sensor NRV-Z5	100595	11-Sep-13 (TMC, No. JZ13-443)	Sep -14
Reference Probe ES3DV3	SN 3149	5- Sep-13 (SPEAG, No.ES3-3149_Sep13)	Sep-14
DAE4	SN 777	22-Feb-13 (SPEAG, DAE4-777_Feb13)	Feb -14
Signal Generator E4438C	MY49070393	13-Nov-13 (TMC, No.JZ13-394)	Nov-14
Network Analyzer E8362B	MY43021135	19-Oct-13 (TMC, No.JZ13-278)	Oct-14

	Name	Function	Signature
Calibrated by:	Zhao Jing	SAR Test Engineer	
Reviewed by:	Qi Dianyuan	SAR Project Leader	
Approved by:	Lu Bingsong	Deputy Director of the laboratory	

Issued: December 17, 2013

This calibration certificate shall not be reproduced except in full without written approval of the laboratory.



Add: No.52 Huayuanbei Road, Haidian District, Beijing, 100191, China  
 Tel: +86-10-62304633-2079 Fax: +86-10-62304633-2504  
 E-mail: info@emcite.com [Http://www.emcite.com](http://www.emcite.com)

#### Glossary:

TSL	tissue simulating liquid
ConvF	sensitivity in TSL / NORM <sub>x,y,z</sub>
N/A	not applicable or not measured

#### Calibration is Performed According to the Following Standards:

- IEEE Std 1528-2013, "IEEE Recommended Practice for Determining the Peak Spatial-Averaged Specific Absorption Rate (SAR) in the Human Head from Wireless Communications Devices: Measurement Techniques", June 2013
- IEC 62209-1, "Procedure to measure the Specific Absorption Rate (SAR) For hand-held devices used in close proximity to the ear (frequency range of 300MHz to 3GHz)", February 2005
- KDB865664, SAR Measurement Requirements for 100 MHz to 6 GHz

#### Additional Documentation:

- DASY4/5 System Handbook

#### Methods Applied and Interpretation of Parameters:

- Measurement Conditions:* Further details are available from the Validation Report at the end of the certificate. All figures stated in the certificate are valid at the frequency indicated.
- Antenna Parameters with TSL:* The dipole is mounted with the spacer to position its feed point exactly below the center marking of the flat phantom section, with the arms oriented parallel to the body axis.
- Feed Point Impedance and Return Loss:* These parameters are measured with the dipole positioned under the liquid filled phantom. The impedance stated is transformed from the measurement at the SMA connector to the feed point. The Return Loss ensures low reflected power. No uncertainty required.
- Electrical Delay:* One-way delay between the SMA connector and the antenna feed point. No uncertainty required.
- SAR measured:* SAR measured at the stated antenna input power.
- SAR normalized:* SAR as measured, normalized to an input power of 1 W at the antenna connector.
- SAR for nominal TSL parameters:* The measured TSL parameters are used to calculate the nominal SAR result.

The reported uncertainty of measurement is stated as the standard uncertainty of Measurement multiplied by the coverage factor  $k=2$ , which for a normal distribution Corresponds to a coverage probability of approximately 95%.



In Collaboration with  
**s p e a g**  
 CALIBRATION LABORATORY

Add: No.52 Huiyuanbei Road, Haidian District, Beijing, 100191, China  
 Tel: +86-10-62304633-2079 Fax: +86-10-62304633-2504  
 E-mail: Info@emcite.com <http://www.emcite.com>

### Measurement Conditions

DASY system configuration, as far as not given on page 1.

DASY Version	DASY52	52.8.7.1137
Extrapolation	Advanced Extrapolation	
Phantom	Twin Phantom	
Distance Dipole Center - TSL	10 mm	with Spacer
Zoom Scan Resolution	dx, dy, dz = 5 mm	
Frequency	1900 MHz $\pm$ 1 MHz	

### Head TSL parameters

The following parameters and calculations were applied.

	Temperature	Permittivity	Conductivity
Nominal Head TSL parameters	22.0 °C	40.0	1.40 mho/m
Measured Head TSL parameters	(22.0 $\pm$ 0.2) °C	38.9 $\pm$ 6 %	1.42 mho/m $\pm$ 6 %
Head TSL temperature change during test	<0.5 °C	----	----

### SAR result with Head TSL

SAR averaged over 1 $cm^3$ (1 g) of Head TSL	Condition	
SAR measured	250 mW input power	9.71 mW / g
SAR for nominal Head TSL parameters	normalized to 1W	38.3 mW / g $\pm$ 20.8 % (k=2)
SAR averaged over 10 $cm^3$ (10 g) of Head TSL	Condition	
SAR measured	250 mW input power	5.08 mW / g
SAR for nominal Head TSL parameters	normalized to 1W	20.2 mW / g $\pm$ 20.4 % (k=2)

### Body TSL parameters

The following parameters and calculations were applied.

	Temperature	Permittivity	Conductivity
Nominal Body TSL parameters	22.0 °C	53.3	1.52 mho/m
Measured Body TSL parameters	(22.0 $\pm$ 0.2) °C	53.7 $\pm$ 6 %	1.53 mho/m $\pm$ 6 %
Body TSL temperature change during test	<0.5 °C	----	----

### SAR result with Body TSL

SAR averaged over 1 $cm^3$ (1 g) of Body TSL	Condition	
SAR measured	250 mW input power	9.98 mW / g
SAR for nominal Body TSL parameters	normalized to 1W	39.9 mW / g $\pm$ 20.8 % (k=2)
SAR averaged over 10 $cm^3$ (10 g) of Body TSL	Condition	
SAR measured	250 mW input power	5.26 mW / g
SAR for nominal Body TSL parameters	normalized to 1W	21.0 mW / g $\pm$ 20.4 % (k=2)



In Collaboration with  
**s p e a g**  
 CALIBRATION LABORATORY

Add: No.52 Huayuanbei Road, Haidian District, Beijing, 100191, China  
 Tel: +86-10-62304633-2079 Fax: +86-10-62304633-2504  
 E-mail: [Info@emcite.com](mailto:Info@emcite.com) <http://www.emcite.com>

## Appendix

### Antenna Parameters with Head TSL

Impedance, transformed to feed point	50.3Ω+ 3.17jΩ
Return Loss	- 30.0dB

### Antenna Parameters with Body TSL

Impedance, transformed to feed point	48.8Ω+ 3.92jΩ
Return Loss	- 27.7dB

### General Antenna Parameters and Design

Electrical Delay (one direction)	1.048 ns
----------------------------------	----------

After long term use with 100W radiated power, only a slight warming of the dipole near the feedpoint can be measured.

The dipole is made of standard semirigid coaxial cable. The center conductor of the feeding line is directly connected to the second arm of the dipole. The antenna is therefore short-circuited for DC-signals. On some of the dipoles, small end caps are added to the dipole arms in order to improve matching when loaded according to the position as explained in the "Measurement Conditions" paragraph. The SAR data are not affected by this change. The overall dipole length is still according to the Standard.

No excessive force must be applied to the dipole arms, because they might bend or the soldered connections near the feedpoint may be damaged.

### Additional EUT Data

Manufactured by	SPEAG
-----------------	-------





Add: No.52 Huayuanbei Road, Haidian District, Beijing, 100191, China  
Tel: +86-10-62304633-2079 Fax: +86-10-62304633-2504  
E-mail: Info@emcife.com Http://www.emcife.com

### DASY5 Validation Report for Head TSL

Date: 12.12.2013

Test Laboratory: TMC, Beijing, China

**DUT: Dipole 1900 MHz; Type: D1900V2; Serial: D1900V2 - SN: 5d150**

Communication System: CW; Frequency: 1900 MHz

Medium parameters used:  $f = 1900$  MHz;  $\sigma = 1.416$  mho/m;  $\epsilon_r = 38.91$ ;  $\rho = 1000$  kg/m<sup>3</sup>

Phantom section: Flat Section

Measurement Standard: DASY5 (IEEE/IEC/ANSI C63.19-2007)

#### DASY5 Configuration:

- Probe: ES3DV3 - SN3149; ConvF(5.06,5.06,5.06); Calibrated: 2013/9/5
- Sensor-Surface: 3mm (Mechanical Surface Detection)
- Electronics: DAE4 Sn777; Calibrated: 22/2/2013
- Phantom: SAM 1186; Type: QD000P40CC;
- DASY52 52.8.7(1137); SEMCAD X Version 14.6.10 (7164)

#### Dipole Calibration for Head Tissue/Pin=250mW, d=10mm/Zoom Scan

(7x7x7)/Cube 0: Measurement grid: dx=5mm, dy=5mm, dz=5mm

Reference Value = 90.054 V/m; Power Drift = 0.01 dB

Peak SAR (extrapolated) = 17.9 W/kg

**SAR(1 g) = 9.71 W/kg; SAR(10 g) = 5.08 W/kg**

Maximum value of SAR (measured) = 11.8 W/kg

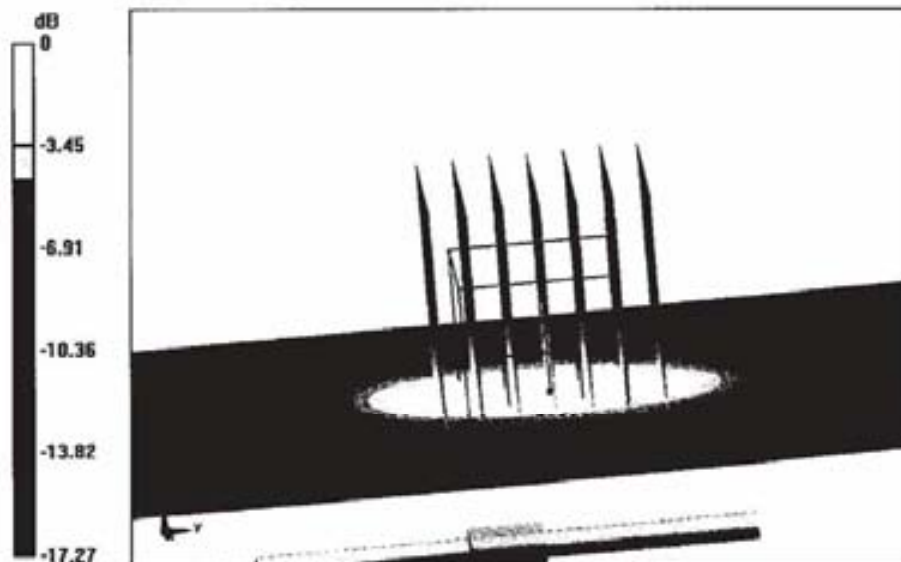

0 dB = 11.8 W/kg = 10.72 dBW/kg



In Collaboration with  
**s p e a g**  
CALIBRATION LABORATORY

Add: No.52 Huayuanbei Road, Haidian District, Beijing, 100191, China  
Tel: +86-10-62304633-2079 Fax: +86-10-62304633-2504  
E-mail: info@emcite.com [Http://www.emcite.com](http://www.emcite.com)

### Impedance Measurement Plot for Head TSL

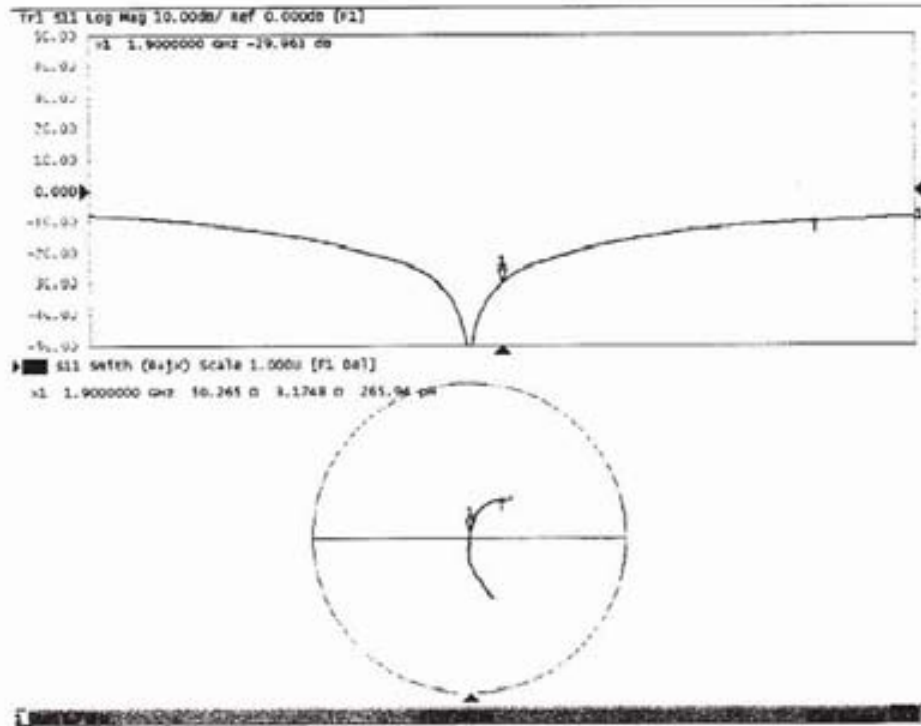



In Collaboration with

**s p e a g**  
 CALIBRATION LABORATORY

Add: No.52 Huayuanbei Road, Haidian District, Beijing, 100191, China  
 Tel: +86-10-62304633-2079 Fax: +86-10-62304633-2504  
 E-mail: Info@emcite.com [Http://www.emcite.com](http://www.emcite.com)

**DASY5 Validation Report for Body TSL**

Date: 12.10.2013

Test Laboratory: TMC, Beijing, China

**DUT: Dipole 1900 MHz; Type: D1900V2; Serial: D1900V2 - SN: 5d150**

Communication System: CW; Frequency: 1900 MHz;

Medium parameters used:  $f = 1900$  MHz;  $\sigma = 1.528$  mho/m;  $\epsilon_r = 53.74$ ;  $\rho = 1000$  kg/m<sup>3</sup>

Phantom section: Flat Phantom

Measurement Standard: DASY5 (IEEE/IEC/ANSI C63.19-2007)

**DASY5 Configuration:**

- Probe: ES3DV3 - SN3149; ConvF(4.72,4.72,4.72) ; Calibrated: 2013/9/5
- Sensor-Surface: 3mm (Mechanical Surface Detection)
- Electronics: DAE4 Sn777; Calibrated: 22/2/2013
- Phantom: SAM1186; Type: QD000P40CC;
- DASY52 52.8.7(1137); SEMCAD X Version 14.6.10 (7164)

**Dipole Calibration for Body Tissue/Pin=250mW, d=10mm/Zoom Scan****(7x7x7)/Cube 0:** Measurement grid: dx=5mm, dy=5mm, dz=5mm

Reference Value = 83.606 V/m; Power Drift = -0.06 dB

Peak SAR (extrapolated) = 17.7 W/kg

**SAR(1 g) = 9.98 W/kg; SAR(10 g) = 5.26 W/kg**

Maximum value of SAR (measured) = 12.1 W/kg

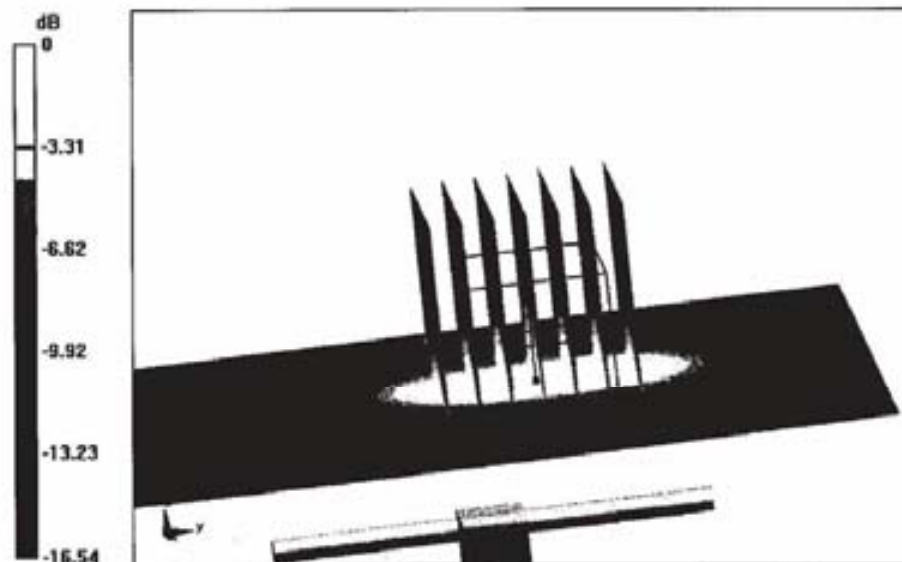

0 dB = 12.1 W/kg = 10.83 dBW/kg



Add: No.52 Huayuanbei Road, Haidian District, Beijing, 100191, China  
Tel: +86-10-62304633-2079 Fax: +86-10-62304633-2504  
E-mail: Info@emcite.com [Http://www.emcite.com](http://www.emcite.com)

### Impedance Measurement Plot for Body TSL

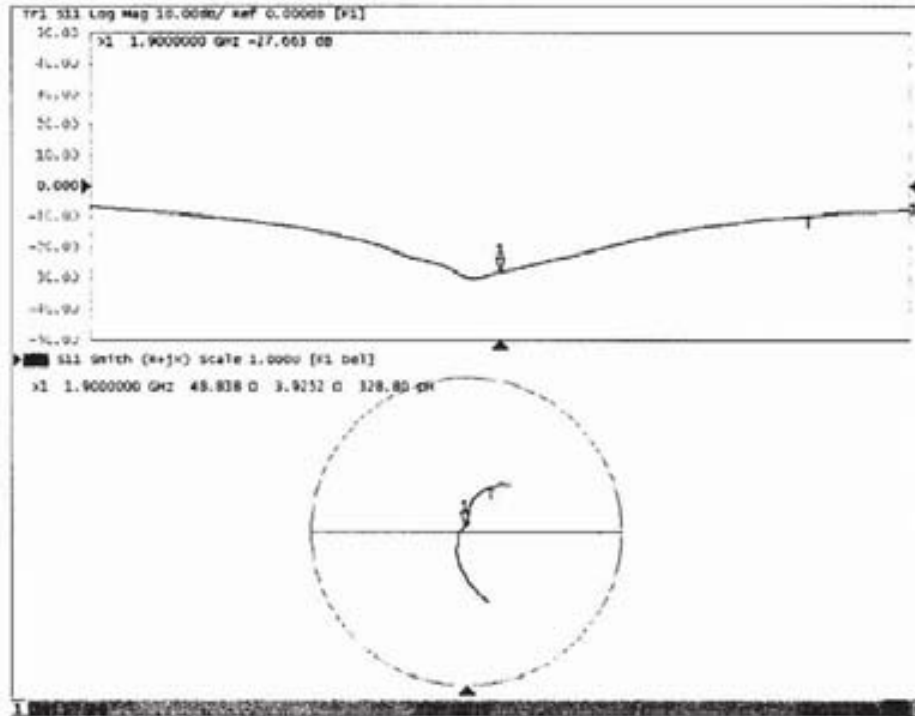

6.4. D2450V2 Dipole Calibration Certificate



In Collaboration with  
**s p e a g**  
CALIBRATION LABORATORY

Add: No.52 Huayuanbei Road, Haidian District, Beijing, 100191, China  
Tel: +86-10-62304633-2079 Fax: +86-10-62304633-2504  
E-mail: info@emcite.com [Http://www.emcite.com](http://www.emcite.com)



Client **CIQ SZ (Auden)**

Certificate No: **J13-2-3053**

**CALIBRATION CERTIFICATE**

Object **D2450V2 - SN: 884**

Calibration Procedure(s) **TMC-OS-E-02-194**  
**Calibration procedure for dipole validation kits**

Calibration date: **December 11, 2013**

This calibration Certificate documents the traceability to national standards, which realize the physical units of measurements(SI). The measurements and the uncertainties with confidence probability are given on the following pages and are part of the certificate.

All calibrations have been conducted in the closed laboratory facility: environment temperature(22±3)°C and humidity<70%.

Calibration Equipment used (M&TE critical for calibration)

Primary Standards	ID #	Cal Date(Calibrated by, Certificate No.)	Scheduled Calibration
Power Meter NRVD	102083	11-Sep-13 (TMC, No.JZ13-443)	Sep-14
Power sensor NRV-Z5	100595	11-Sep-13 (TMC, No. JZ13-443)	Sep -14
Reference Probe ES3DV3	SN 3149	5- Sep-13 (SPEAG, No.ES3-3149_Sep13)	Sep-14
DAE4	SN 777	22-Feb-13 (SPEAG, DAE4-777_Feb13)	Feb -14
Signal Generator E4438C	MY49070393	13-Nov-13 (TMC, No.JZ13-394)	Nov-14
Network Analyzer E8362B	MY43021135	19-Oct-13 (TMC, No.JZ13-278)	Oct-14

	Name	Function	Signature
Calibrated by:	Zhao Jing	SAR Test Engineer	
Reviewed by:	Qi Dianyuan	SAR Project Leader	
Approved by:	Lu Bingsong	Deputy Director of the laboratory	

Issued: December 17, 2013

This calibration certificate shall not be reproduced except in full without written approval of the laboratory.



In Collaboration with  
**s p e a g**  
 CALIBRATION LABORATORY

Add: No.52 Huayuanbei Road, Haidian District, Beijing, 100191, China  
 Tel: +86-10-82304633-2079 Fax: +86-10-82304633-2504  
 E-mail: Info@emcite.com [Http://www.emcite.com](http://www.emcite.com)

#### Glossary:

TSL	tissue simulating liquid
ConvF	sensitivity in TSL / NORM <sub>x,y,z</sub>
N/A	not applicable or not measured

#### Calibration is Performed According to the Following Standards:

- IEEE Std 1528-2013, "IEEE Recommended Practice for Determining the Peak Spatial-Averaged Specific Absorption Rate (SAR) in the Human Head from Wireless Communications Devices: Measurement Techniques", June 2013
- IEC 62209-1, "Procedure to measure the Specific Absorption Rate (SAR) For hand-held devices used in close proximity to the ear (frequency range of 300MHz to 3GHz)", February 2005
- KDB865664, SAR Measurement Requirements for 100 MHz to 6 GHz

#### Additional Documentation:

- DASY4/5 System Handbook

#### Methods Applied and Interpretation of Parameters:

- Measurement Conditions:** Further details are available from the Validation Report at the end of the certificate. All figures stated in the certificate are valid at the frequency indicated.
- Antenna Parameters with TSL:** The dipole is mounted with the spacer to position its feed point exactly below the center marking of the flat phantom section, with the arms oriented parallel to the body axis.
- Feed Point Impedance and Return Loss:** These parameters are measured with the dipole positioned under the liquid filled phantom. The impedance stated is transformed from the measurement at the SMA connector to the feed point. The Return Loss ensures low reflected power. No uncertainty required.
- Electrical Delay:** One-way delay between the SMA connector and the antenna feed point. No uncertainty required.
- SAR measured:** SAR measured at the stated antenna input power.
- SAR normalized:** SAR as measured, normalized to an input power of 1 W at the antenna connector.
- SAR for nominal TSL parameters:** The measured TSL parameters are used to calculate the nominal SAR result.

The reported uncertainty of measurement is stated as the standard uncertainty of Measurement multiplied by the coverage factor  $k=2$ , which for a normal distribution Corresponds to a coverage probability of approximately 95%.



In Collaboration with  
**s p e a g**  
CALIBRATION LABORATORY

Add: No.52 Huayuanbei Road, Haidian District, Beijing, 100191, China  
Tel: +86-10-62304633-2079 Fax: +86-10-62304633-2504  
E-mail: Info@emcite.com [Http://www.emcite.com](http://www.emcite.com)

### Measurement Conditions

DASY system configuration, as far as not given on page 1.

DASY Version	DASY52	52.8.7.1137
Extrapolation	Advanced Extrapolation	
Phantom	Twin Phantom	
Distance Dipole Center - TSL	10 mm	with Spacer
Zoom Scan Resolution	dx, dy, dz = 5 mm	
Frequency	2450 MHz $\pm$ 1 MHz	

### Head TSL parameters

The following parameters and calculations were applied.

	Temperature	Permittivity	Conductivity
Nominal Head TSL parameters	22.0 °C	39.2	1.80 mho/m
Measured Head TSL parameters	(22.0 $\pm$ 0.2) °C	39.0 $\pm$ 6 %	1.82 mho/m $\pm$ 6 %
Head TSL temperature change during test	<0.5 °C	---	---

### SAR result with Head TSL

SAR averaged over 1 $cm^3$ (1 g) of Head TSL	Condition	
SAR measured	250 mW input power	13.0 mW / g
SAR for nominal Head TSL parameters	normalized to 1W	51.7 mW / g $\pm$ 20.8 % (k=2)
SAR averaged over 10 $cm^3$ (10 g) of Head TSL	Condition	
SAR measured	250 mW input power	6.05 mW / g
SAR for nominal Head TSL parameters	normalized to 1W	24.1 mW / g $\pm$ 20.4 % (k=2)

### Body TSL parameters

The following parameters and calculations were applied.

	Temperature	Permittivity	Conductivity
Nominal Body TSL parameters	22.0 °C	52.7	1.95 mho/m
Measured Body TSL parameters	(22.0 $\pm$ 0.2) °C	52.8 $\pm$ 6 %	1.94 mho/m $\pm$ 6 %
Body TSL temperature change during test	<0.5 °C	---	---

### SAR result with Body TSL

SAR averaged over 1 $cm^3$ (1 g) of Body TSL	Condition	
SAR measured	250 mW input power	12.9 mW / g
SAR for nominal Body TSL parameters	normalized to 1W	51.8 mW / g $\pm$ 20.8 % (k=2)
SAR averaged over 10 $cm^3$ (10 g) of Body TSL	Condition	
SAR measured	250 mW input power	5.98 mW / g
SAR for nominal Body TSL parameters	normalized to 1W	24.0 mW / g $\pm$ 20.4 % (k=2)



In Collaboration with  
**s p e a g**  
 CALIBRATION LABORATORY

Add: No.52 Huayuanbei Road, Haidian District, Beijing, 100191, China  
 Tel: +86-10-62304633-2079 Fax: +86-10-62304633-2504  
 E-mail: Info@emcite.com [Http://www.emcite.com](http://www.emcite.com)

## Appendix

### Antenna Parameters with Head TSL

Impedance, transformed to feed point	46.8Ω+ 3.76jΩ
Return Loss	- 25.9dB

### Antenna Parameters with Body TSL

Impedance, transformed to feed point	55.2Ω+ 2.38jΩ
Return Loss	- 25.4dB

### General Antenna Parameters and Design

Electrical Delay (one direction)	1.199 ns
----------------------------------	----------

After long term use with 100W radiated power, only a slight warming of the dipole near the feedpoint can be measured.

The dipole is made of standard semirigid coaxial cable. The center conductor of the feeding line is directly connected to the second arm of the dipole. The antenna is therefore short-circuited for DC-signals. On some of the dipoles, small end caps are added to the dipole arms in order to improve matching when loaded according to the position as explained in the "Measurement Conditions" paragraph. The SAR data are not affected by this change. The overall dipole length is still according to the Standard.

No excessive force must be applied to the dipole arms, because they might bend or the soldered connections near the feedpoint may be damaged.

### Additional EUT Data

Manufactured by	SPEAG
-----------------	-------





Add: No.52 Huayuanbei Road, Haidian District, Beijing, 100191, China  
Tel: +86-10-62304633-2079 Fax: +86-10-62304633-2504  
E-mail: info@emcite.com [Http://www.emcite.com](http://www.emcite.com)

### DASY5 Validation Report for Head TSL

Date: 12.10.2013

Test Laboratory: TMC, Beijing, China

**DUT: Dipole 2450 MHz; Type: D2450V2; Serial: D2450V2 - SN: 884**

Communication System: CW; Frequency: 2450 MHz

Medium parameters used:  $f = 2450$  MHz;  $\sigma = 1.817$  mho/m;  $\epsilon_r = 38.96$ ;  $\rho = 1000$  kg/m<sup>3</sup>

Phantom section: Flat Section

Measurement Standard: DASY5 (IEEE/IEC/ANSI C63.19-2007)

#### DASY5 Configuration:

- Probe: ES3DV3 - SN3149; ConvF(4.48,4.48,4.48); Calibrated: 2013/9/5
- Sensor-Surface: 3mm (Mechanical Surface Detection)
- Electronics: DAE4 Sn777; Calibrated: 22/2/2013
- Phantom: SAM 1593; Type: QD000P40CC;
- DASY52 52.8.7(1137); SEMCAD X Version 14.6.10 (7164)

#### Dipole Calibration for Head Tissue/Pin=250mW, d=10mm/Zoom Scan

(7x7x7)/Cube 0: Measurement grid: dx=5mm, dy=5mm, dz=5mm

Reference Value = 86.529 V/m; Power Drift = -0.07 dB

Peak SAR (extrapolated) = 27.0 W/kg

**SAR(1 g) = 13 W/kg; SAR(10 g) = 6.05 W/kg**

Maximum value of SAR (measured) = 16.2 W/kg

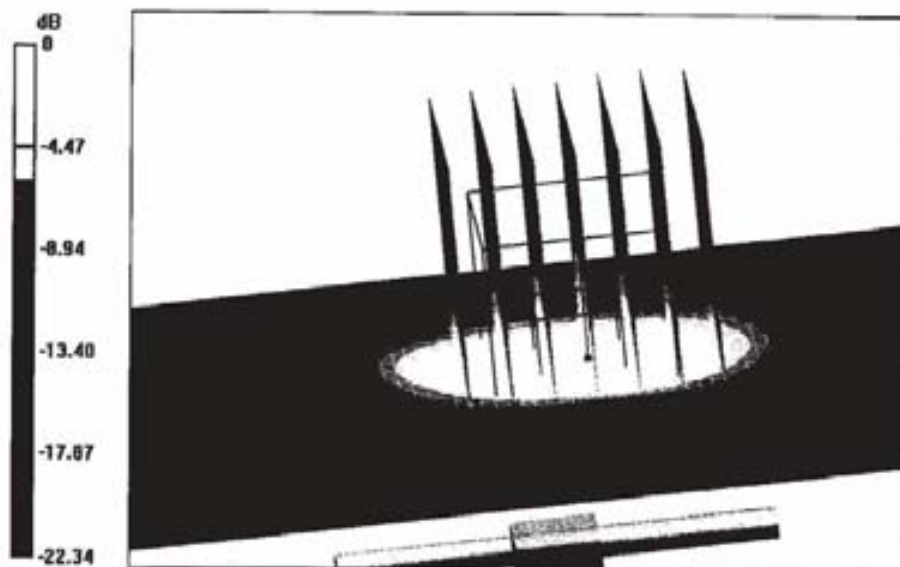



In Collaboration with  
**s p e a g**  
CALIBRATION LABORATORY

Add: No.52 Huayuanbei Road, Haidian District, Beijing, 100191, China  
Tel: +86-10-62304633-2079 Fax: +86-10-62304633-2504  
E-mail: info@emcite.com [Http://www.emcite.com](http://www.emcite.com)

### Impedance Measurement Plot for Head TSL

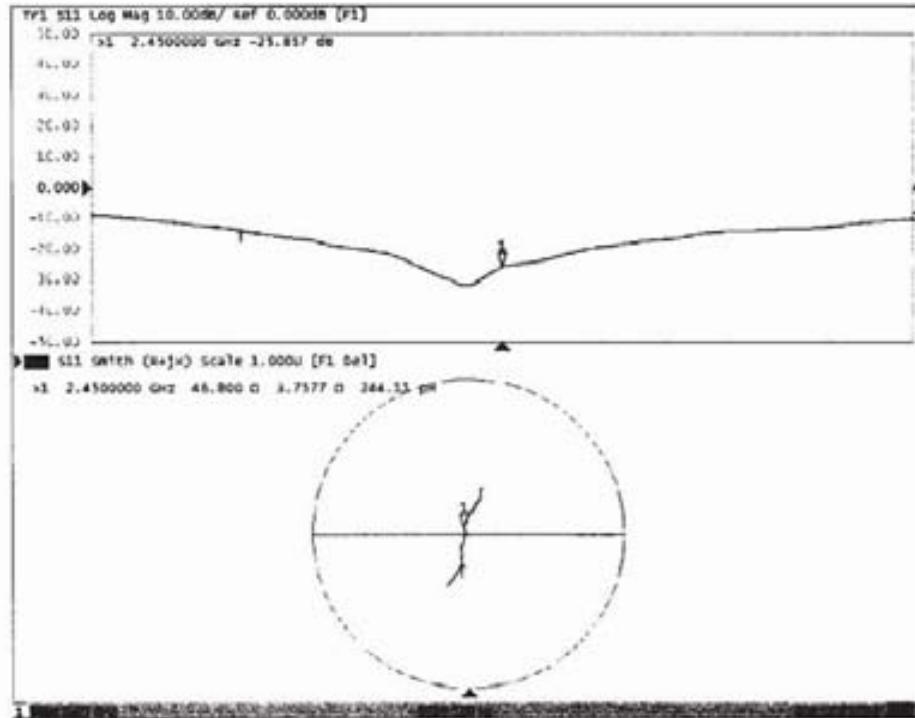



Add: No.52 Huayuanbei Road, Haidian District, Beijing, 100191, China  
Tel: +86-10-62304633-2079 Fax: +86-10-62304633-2504  
E-mail: info@emcite.com [Http://www.emcite.com](http://www.emcite.com)

**DASY5 Validation Report for Body TSL**

Date: 12.11.2013

Test Laboratory: TMC, Beijing, China

**DUT: Dipole 2450 MHz; Type: D2450V2; Serial: D2450V2 - SN: 884**

Communication System: CW; Frequency: 2450 MHz;

Medium parameters used:  $f = 2450$  MHz;  $\sigma = 1.939$  mho/m;  $\epsilon_r = 52.97$ ;  $\rho = 1000$  kg/m<sup>3</sup>

Phantom section: Flat Phantom

Measurement Standard: DASY5 (IEEE/IEC/ANSI C63.19-2007)

**DASY5 Configuration:**

- Probe: ES3DVS - SN3149; ConvF(4.21,4.21,4.21) ; Calibrated: 2013/9/5
- Sensor-Surface: 3mm (Mechanical Surface Detection)
- Electronics: DAE4 Sn777; Calibrated: 22/2/2013
- Phantom: SAM1186; Type: QD000P40CC;
- DASY52 52.8.7(1137); SEMCAD X Version 14.6.10 (7164)

**Dipole Calibration for Body Tissue/Pin=250mW, d=10mm/Zoom Scan****(7x7x7)/Cube 0:** Measurement grid: dx=5mm, dy=5mm, dz=5mm

Reference Value = 84.687 V/m; Power Drift = -0.03 dB

Peak SAR (extrapolated) = 27.1 W/kg

**SAR(1 g) = 12.9 W/kg; SAR(10 g) = 5.98 W/kg**

Maximum value of SAR (measured) = 16.0 W/kg

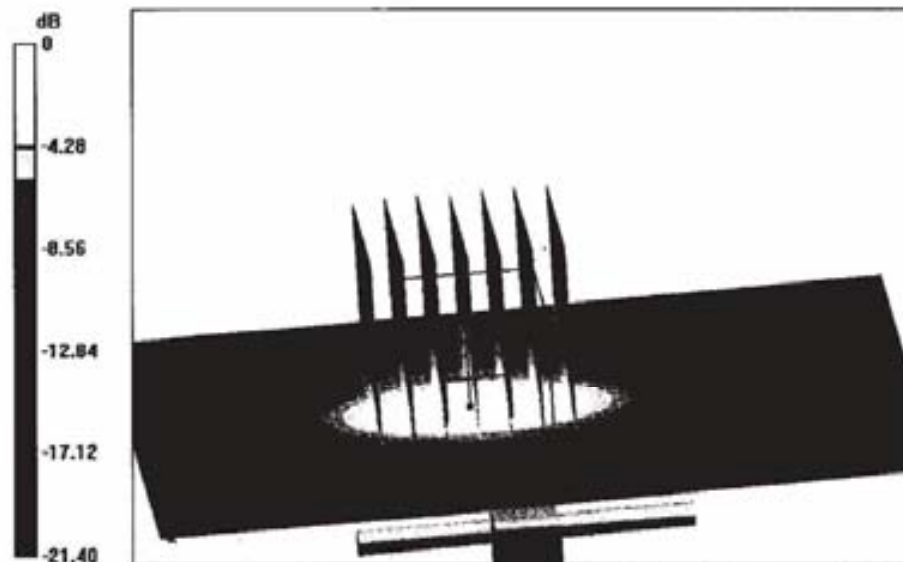



In Collaboration with  
**s p e a g**  
CALIBRATION LABORATORY

Add: No.52 Huayuanbei Road, Haidian District, Beijing, 100191, China  
Tel: +86-10-62304633-2079 Fax: +86-10-62304633-2504  
E-mail: [Info@emcite.com](mailto:Info@emcite.com) [Http://www.emcite.com](http://www.emcite.com)

### Impedance Measurement Plot for Body TSL

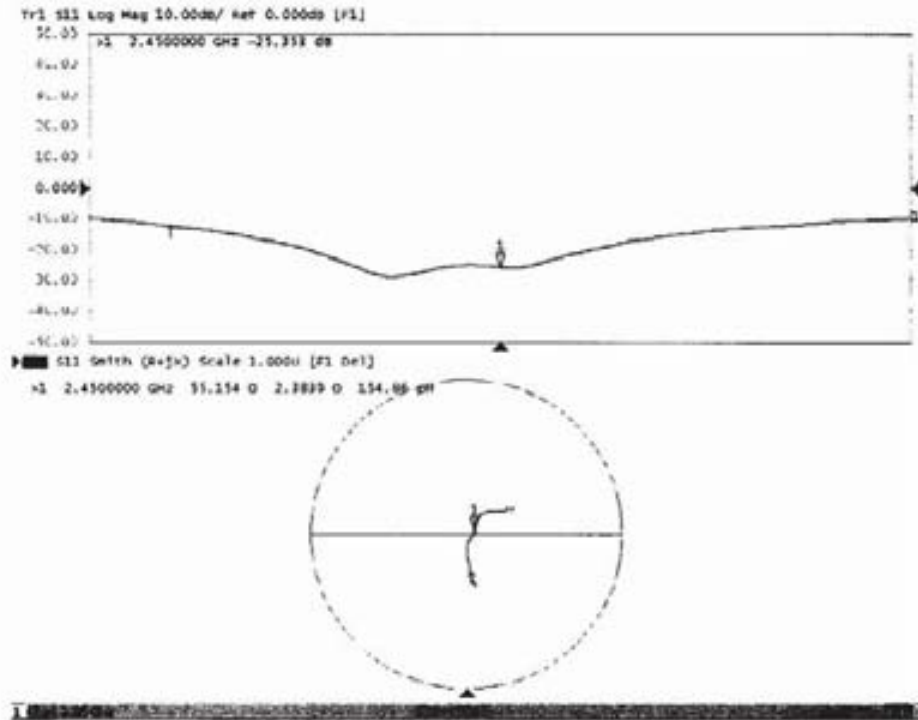

6.5. DAE4 Calibration Certificate



In Collaboration with  
**s p e a g**  
CALIBRATION LABORATORY

Add: No.52 Huayuanbei Road, Haidian District, Beijing, 100191, China  
Tel: +86-10-62304633-2079 Fax: +86-10-62304633-2504  
E-mail: info@emc.itc.com Http://www.emc.itc.com



Client : **CIQ SZ (Auden)**

Certificate No: **J13-2-3048**

**CALIBRATION CERTIFICATE**

Object **DAE4 - SN: 1315**

Calibration Procedure(s) **TMC-OS-E-01-198**  
**Calibration Procedure for the Data Acquisition Electronics (DAEx)**

Calibration date: **November 25, 2013**

This calibration Certificate documents the traceability to national standards, which realize the physical units of measurements(SI). The measurements and the uncertainties with confidence probability are given on the following pages and are part of the certificate.

All calibrations have been conducted in the closed laboratory facility: environment temperature(22±3)°C and humidity<70%.

Calibration Equipment used (M&TE critical for calibration)

Primary Standards	ID #	Cal Date(Calibrated by, Certificate No.)	Scheduled Calibration
Documenting Process Calibrator 753	1971018	01-July-13 (TMC, No:JW13-049)	July-14

	Name	Function	Signature
Calibrated by:	Yu zongying	SAR Test Engineer	
Reviewed by:	Qi Dianyuan	SAR Project Leader	
Approved by:	Lu Bingsong	Deputy Director of the laboratory	

Issued: November 25, 2013

This calibration certificate shall not be reproduced except in full without written approval of the laboratory.



In Collaboration with

**s p e a g**  
**CALIBRATION LABORATORY**

Add: No.52 Huayuanbei Road, Haidian District, Beijing, 100191, China  
Tel: +86-10-62304633-2079 Fax: +86-10-62304633-2504  
E-mail: [info@emcite.com](mailto:info@emcite.com) Http://www.emcite.com

**Glossary:**

DAE data acquisition electronics  
Connector angle information used in DASY system to align probe sensor X to the robot coordinate system.

**Methods Applied and Interpretation of Parameters:**

- *DC Voltage Measurement:* Calibration Factor assessed for use in DASY system by comparison with a calibrated instrument traceable to national standards. The figure given corresponds to the full scale range of the voltmeter in the respective range.
- *Connector angle:* The angle of the connector is assessed measuring the angle mechanically by a tool inserted. Uncertainty is not required.
- The report provide only calibration results for DAE, it does not contain other performance test results.



In Collaboration with

CALIBRATION LABORATORY

Add: No.52 Huayuanbei Road, Haidian District, Beijing, 100191, China

Tel: +86-10-62304633-2079

Fax: +86-10-62304633-2504

E-mail: [Info@emcite.com](mailto:Info@emcite.com)[Http://www.emcite.com](http://www.emcite.com)

### DC Voltage Measurement

A/D - Converter Resolution nominal

High Range: 1LSB = 6.1 $\mu$ V, full range = -100...+300 mV

Low Range: 1LSB = 61nV, full range = -1.....+3mV

DASY measurement parameters: Auto Zero Time: 3 sec; Measuring time: 3 sec

Calibration Factors	X	Y	Z
High Range	403.915 $\pm$ 0.15% (k=2)	405.171 $\pm$ 0.15% (k=2)	404.667 $\pm$ 0.15% (k=2)
Low Range	3.98903 $\pm$ 0.7% (k=2)	3.94180 $\pm$ 0.7% (k=2)	3.93862 $\pm$ 0.7% (k=2)

### Connector Angle

Connector Angle to be used in DASY system	162.5 $^{\circ}$ $\pm$ 1 $^{\circ}$
---	-------------------------------------

## 7. Test Setup Photos



Photograph of the depth in the Head Phantom (835MHz)



Photograph of the depth in the Body Phantom (835MHz)



Photograph of the depth in the Head Phantom (1900MHz)





Photograph of the depth in the Body Phantom (1900MHz)



Photograph of the depth in the Head Phantom (2450MHz)



Photograph of the depth in the Body Phantom (2450MHz)



**Right Head Tilt Setup Photo**



**Right Head Touch Setup Photo**

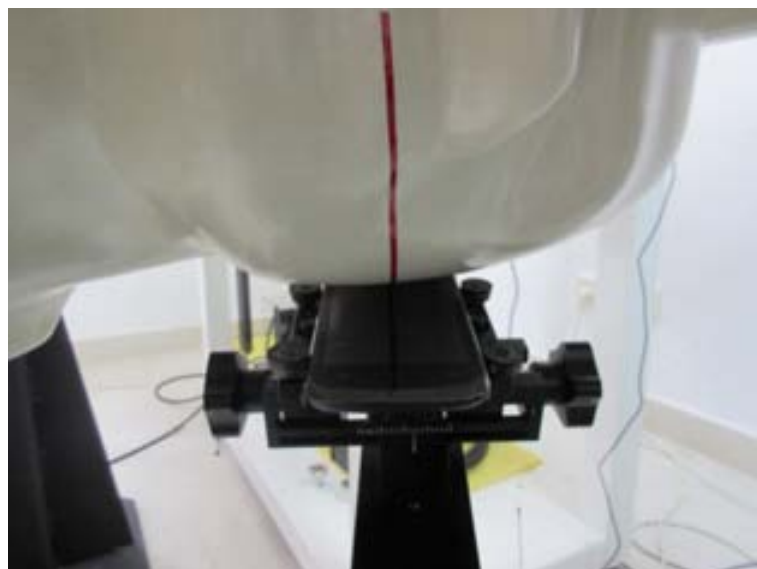

**Left Head Tilt Setup Photo**

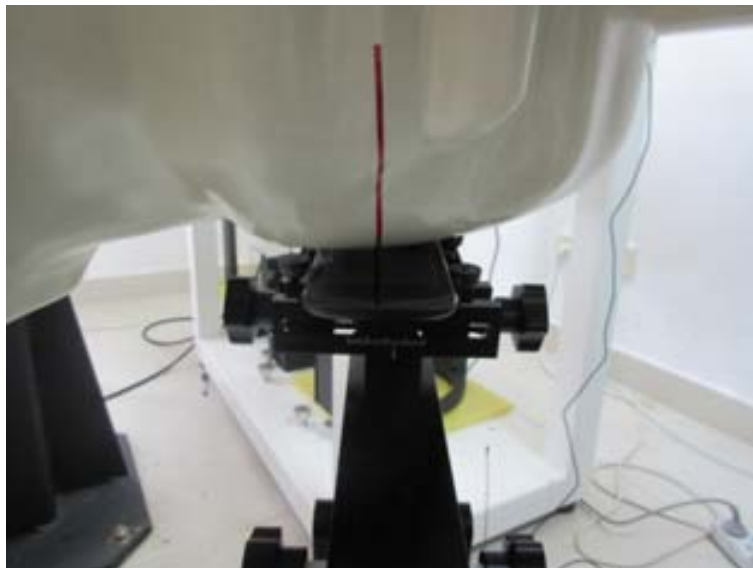

**Left Head Touch Setup Photo**



**10mm Body-worn Back Side Setup Photo**



**10mm Body-worn front Side Setup Photo**



10mm Body-worn Top Side Setup Photo



10mm Body-worn Bottom Side Setup Photo



10mm Body-worn Left Side Setup Photo



10mm Body-worn Right Side Setup Photo

## 8. External Photos of the EUT

### External photos of the EUT





**Internal photos of the EUT**

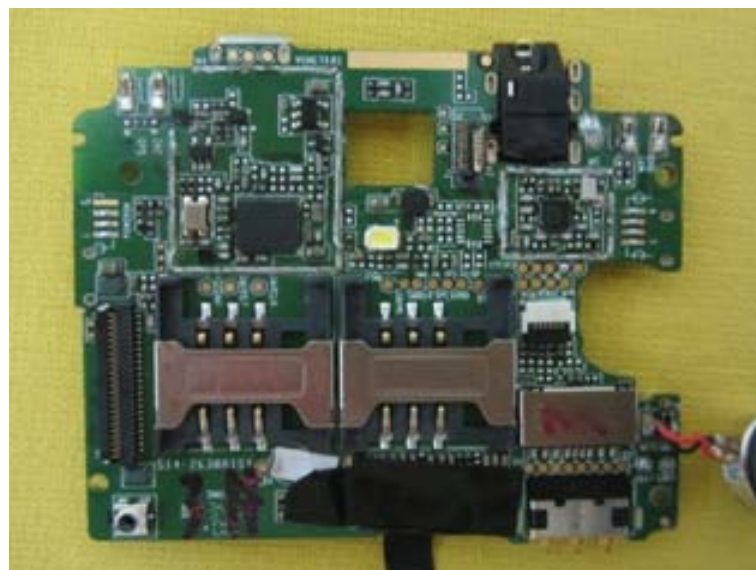





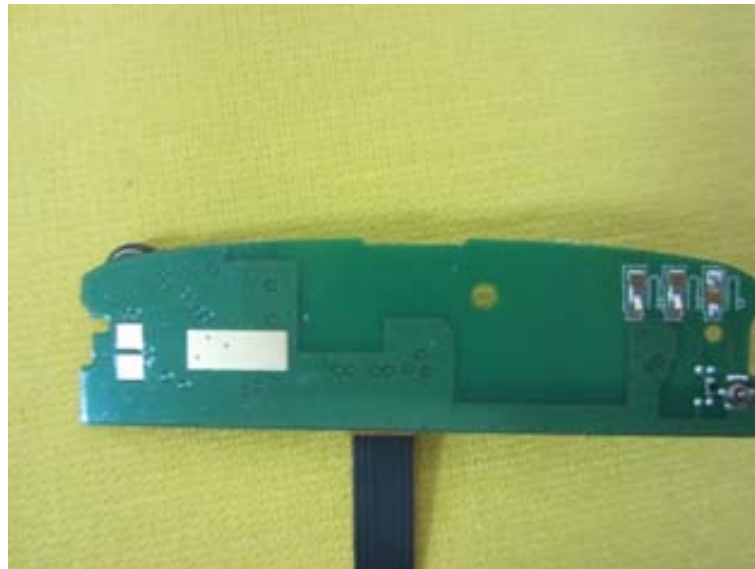

.....End of Report.....