

# Shenzhen Yupin Technology Co., Ltd

**dianxiaobao**

**Main Model: UP3  
Serial Model: N/A**

**November 26, 2013**



**Report No.: 13070485-FCC-E1-18**

**(This report supersedes NONE)**



Modifications made to the product : None

This Test Report is Issued Under the Authority of:

		
<b>David Huang</b> Compliance Engineer	<b>Alex Liu</b> Technical Manager	

This test report may be reproduced in full only.  
Test result presented in this test report is applicable to the representative sample only.

# EMC Test Report

To: FCC Part 18 Subpart C, FCC Measurement Procedure MP-5 (1986)

**SIEMIC, INC.**  
Accessing global markets



## Laboratory Introduction

SIEMIC, headquartered in the heart of Silicon Valley, with superior facilities in US and Asia, is one of the leading independent testing and certification facilities providing customers with one-stop shop services for Compliance Testing and Global Certifications.



In addition to [testing](#) and [certification](#), SIEMIC provides initial design reviews and [compliance management](#) through out a project. Our extensive experience with [China](#), [Asia Pacific](#), [North America](#), [European](#), and [international](#) compliance requirements, assures the fastest, most cost effective way to attain regulatory compliance for the [global markets](#).

### SIEMIC (Shenzhen-China) Laboratories Accreditations for Conformity Assessment

Country/Region	Scope
USA	EMC , RF/Wireless , Telecom
Canada	EMC, RF/Wireless , Telecom
Taiwan	EMC, RF, Telecom , Safety
Hong Kong	RF/Wireless ,Telecom
Australia	EMC, RF, Telecom , Safety
Korea	EMI, EMS, RF , Telecom, Safety
Japan	EMI, RF/Wireless, Telecom
Singapore	EMC , RF , Telecom
Europe	EMC, RF, Telecom , Safety



---

This page has been left blank intentionally.

# CONTENTS

<b>1</b>	<b>EXECUTIVE SUMMARY &amp; EUT INFORMATION .....</b>	<b>5</b>
<b>2</b>	<b>TECHNICAL DETAILS.....</b>	<b>6</b>
<b>3</b>	<b>MODIFICATION.....</b>	<b>7</b>
<b>4</b>	<b>TEST SUMMARY.....</b>	<b>8</b>
<b>5</b>	<b>MEASUREMENTS, EXAMINATION AND DERIVED RESULTS.....</b>	<b>9</b>
	<b>ANNEX A. TEST INSTRUMENTATION &amp; GENERAL PROCEDURES .....</b>	<b>16</b>
	<b>ANNEX B. EUT AND TEST SETUP PHOTOGRAPHS .....</b>	<b>21</b>
	<b>ANNEX C. TEST SETUP AND SUPPORTING EQUIPMENT.....</b>	<b>33</b>
	<b>ANNEX D. USER MANUAL / BLOCK DIAGRAM / SCHEMATICS / PART LIST .....</b>	<b>37</b>
	<b>ANNEX E. DECLARATION OF SIMILARITY .....</b>	<b>38</b>



## **1 EXECUTIVE SUMMARY & EUT INFORMATION**

**The purpose of this test programmer was to demonstrate compliance of the Shenzhen Yupin Technology Co., Ltd, dianxiaobao and Model: UP3 against the current Stipulated Standards. The dianxiaobao has demonstrated compliance with the FCC Part 18 Subpart C, FCC Measurement Procedure MP-5 (1986).**

### **EUT Information**

**EUT Description : dianxiaobao**

**Main Model : UP3**

**Serial Model : N/A**

**Input Power : DC 5V 2.0 A**

**Antenna Type : Coil antenna**

**Classification Per Stipulated Test Standard : Non-ISM frequency  
FCC Part 18 Subpart C: 2013, FCC Measurement Procedure MP-5 (1986)**



## 2 TECHNICAL DETAILS

<b>Purpose</b>	<b>Compliance testing of dianxiaobao with stipulated standards</b>
<b>Applicant / Client</b>	<b>Shenzhen Yupin Technology Co.,Ltd 4th Floor, Building Two, Dongpeng Industrial Park, Second Industrial District, Mabu New Village, Shiyan Street, Shenzhen City</b>
<b>Manufacturer</b>	<b>Shenzhen Yupin Technology Co.,Ltd 4th Floor, Building Two, Dongpeng Industrial Park, Second Industrial District, Mabu New Village, Shiyan Street, Shenzhen City</b>
<b>Laboratory performing the tests</b>	<b>SIEMIC (Shenzhen-China) Laboratories Zone A, Floor 1, Building 2, Wan Ye Long Technology Park, South Side of Zhoushi Road, Bao'an District, Shenzhen, Guangdong, China Tel: +86-0755-2601 4629 / 2601 4953 Fax: +86-0755-2601 4953-810 Email: China@siemic.com.cn</b>
<b>Test report reference number</b>	<b>13070485-FCC-E1-18</b>
<b>Date EUT received</b>	<b>November 04, 2013</b>
<b>Standard applied</b>	<b>FCC Part 18 Subpart C, FCC Measurement Procedure MP-5 (1986)</b>
<b>Dates of test (from – to)</b>	<b>November 11 to November 16, 2013</b>
<b>No of Units</b>	<b>#1</b>
<b>Equipment Category</b>	<b>Non-ISM frequency</b>
<b>Trade Name</b>	<b>Power Partner</b>
<b>RF Operating Frequency (ies)</b>	<b>110 kHz – 205 kHz</b>
<b>FCC ID</b>	<b>2ABGM-UPT002</b>



### **3 MODIFICATION**

**NONE**



## 4 TEST SUMMARY

The product was tested in accordance with the following specifications.  
All testing has been performed according to below product classification:

### Non-ISM frequency

#### Test Results Summary

Emissions			
Test Standard	Description	Product Class	Pass / Fail
FCC Part 18 Subpart C, FCC Measurement Procedure MP-5 (1986)	Field strength	See Above	Pass
FCC Part 18 Subpart C, FCC Measurement Procedure MP-5 (1986)	Conducted Emissions	See Above	Pass

All measurement uncertainty is not taken into consideration for all presented test result.





<b>Test Mode:</b>	<b>Operating Frequency: 157.31 kHz</b>
-------------------	--

**Fundamental Test Data**

Freq.(kHz)	Reading (dBuV)	Limit (dBuV/m)	Margin (dBuV/m)	Detect Mode
157.31	67.3	103.52	-36.22	Quasi-peak

**Spurious Test Data**

Freq.(kHz)	Reading (dBuV)	Limit (dBuV/m)	Margin (dBuV/m)	Detect Mode
116.51	37.2	103.52	-66.32	Quasi-peak
255.88	49.1	103.52	-54.42	Quasi-peak

Note: For operating non-ISM frequency equipment, the field strength limit of 300 meters distance is 15uV/m.  
 Measurement distance: 3 meters;  
 For 300m , distance correction factor= $40 * \log(300/3) = 80\text{dB}$ ;  
 So, the strength limit of 3 meters distance =  $20 \log 15 + 40 * \log(300/3) = 103.52\text{dBuV/m}$ .

**Detector: PK Frequency band: 110 kHz-150 kHz**

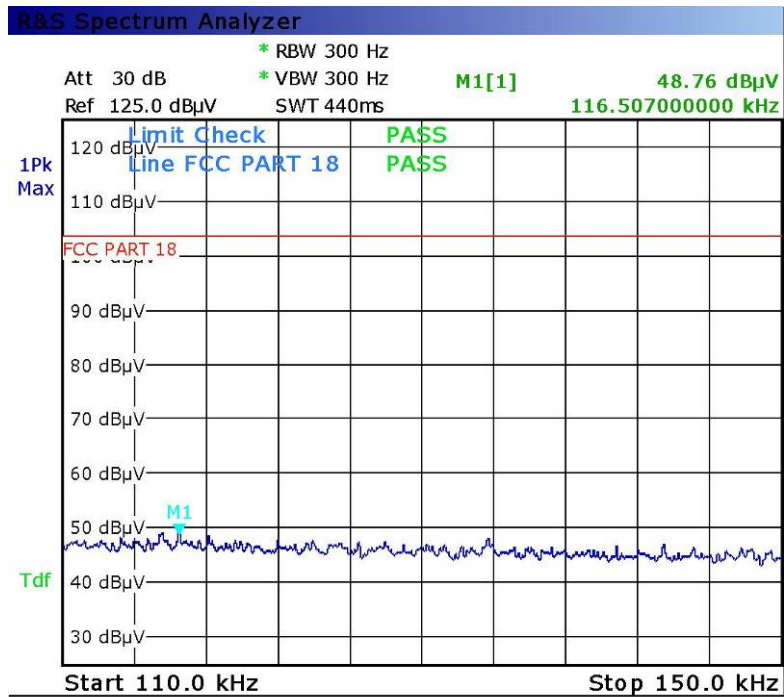

Date: 22.NOV.2013 05:59:42

**Detector: PK Frequency band: 150 kHz-30 MHz**



Date: 22.NOV.2013 06:13:13

**Detector: QP Frequency: 110 kHz-150 kHz**

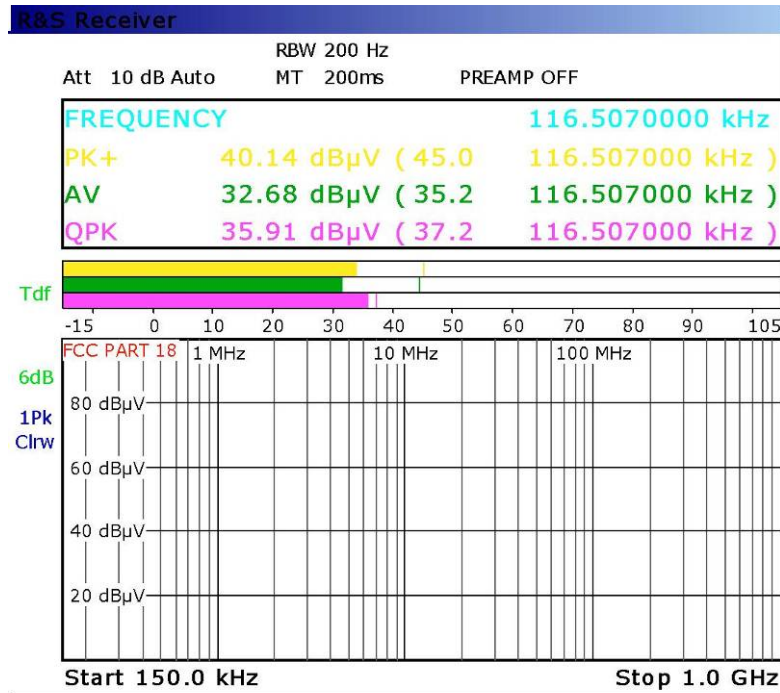

Date: 22.NOV.2013 06:03:56



**Detector: QP Frequency: 150 kHz -30 MHz**

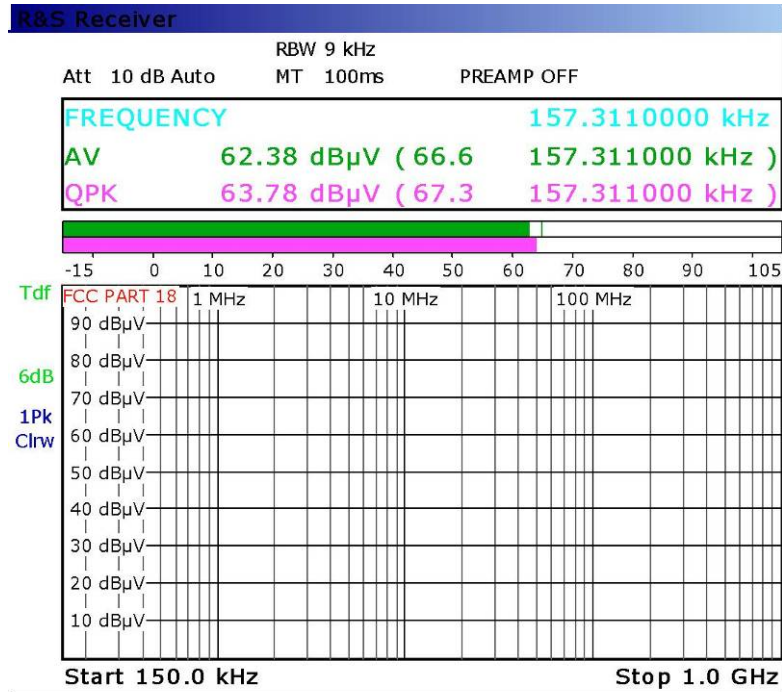

Date: 22.NOV.2013 06:17:35

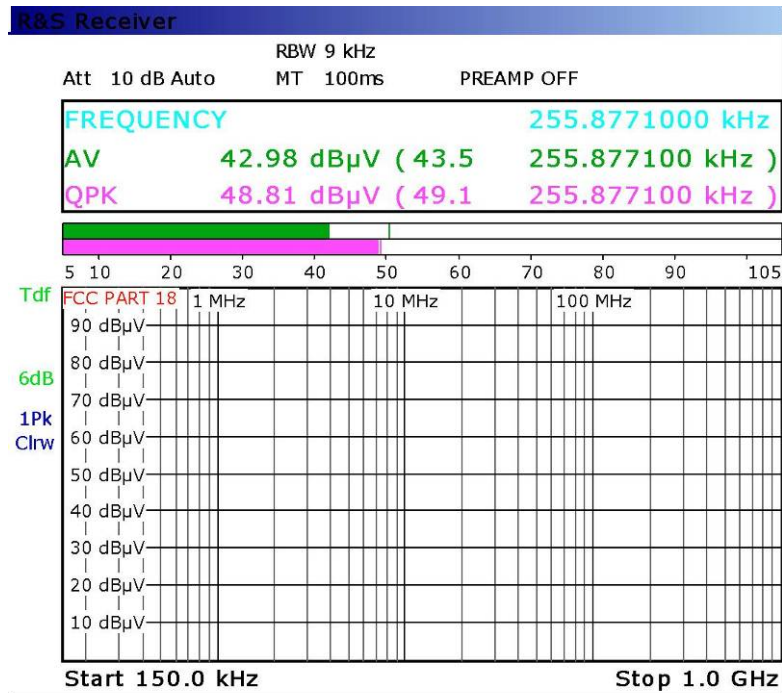

Date: 22.NOV.2013 06:21:19



<b>Test Mode:</b>	<b>Operating Frequency 157.31 kHz</b>
-------------------	---------------------------------------

Peak Detector		Quasi Peak Limit	
Average Detector		Average Limit	

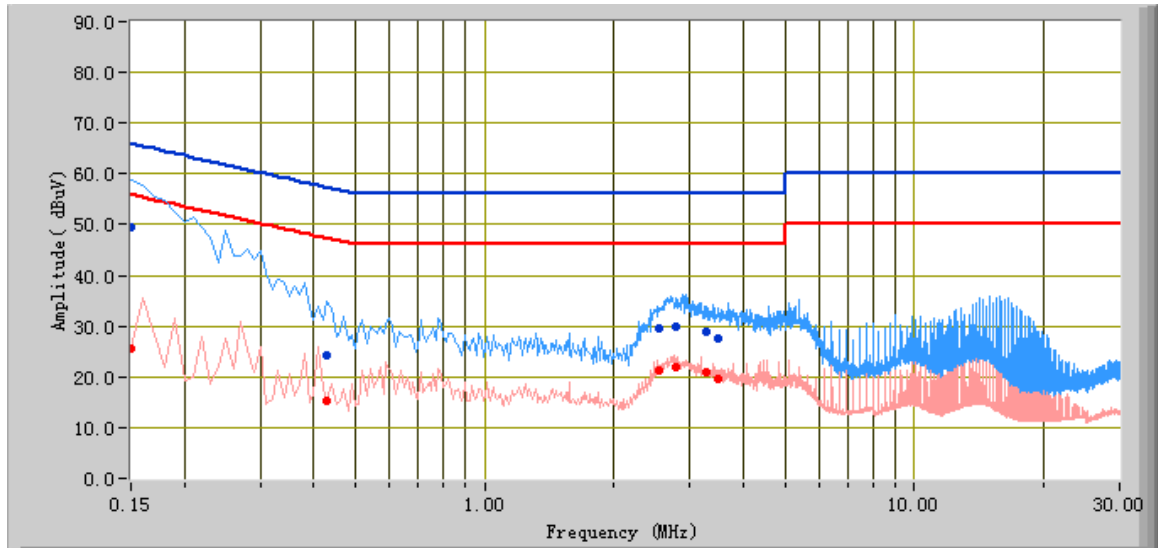

**Test Data**

**Phase Line Plot at 120V AC, 60Hz**

Frequency (MHz)	Quasi Peak (dBuV)	Limit (dBuV)	Margin (dB)	Average (dBuV)	Limit (dBuV)	Margin (dB)	Factors (dB)
0.15	49.35	66.00	-16.65	25.55	56.00	-30.45	10.10
2.78	29.76	56.00	-26.24	22.08	46.00	-23.92	10.13
3.26	28.80	56.00	-27.20	20.81	46.00	-25.19	10.15
0.43	24.21	57.25	-33.04	15.30	47.25	-31.95	10.10
2.54	29.49	56.00	-26.51	21.27	46.00	-24.73	10.13
3.50	27.69	56.00	-28.31	19.76	46.00	-26.24	10.15

**Test Mode: Operating Frequency 157.31 kHz**

**Peak Detector**     **Quasi Peak Limit**      
**Average Detector**     **Average Limit**    

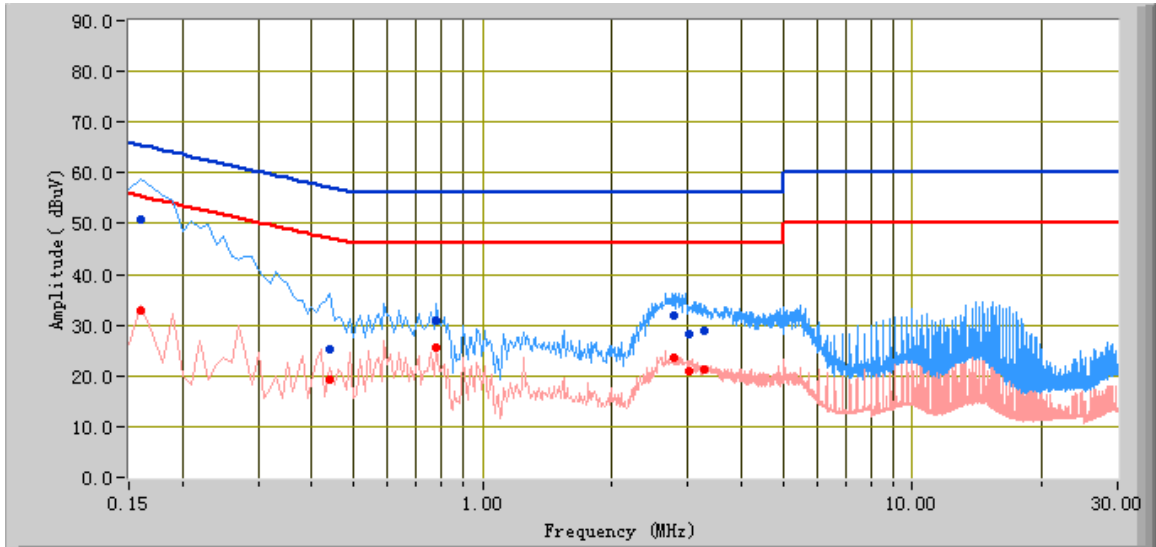

**Test Data**

**Phase Natural Plot at 120V AC, 60Hz**

Frequency (MHz)	Quasi Peak (dBuV)	Limit (dBuV)	Margin (dB)	Average (dBuV)	Limit (dBuV)	Margin (dB)	Factors (dB)
0.16	50.78	65.47	-14.69	33.00	55.47	-22.46	10.10
2.78	31.91	56.00	-24.09	23.52	46.00	-22.48	10.13
0.44	25.17	57.06	-31.89	19.22	47.06	-27.84	10.10
0.78	30.86	56.00	-25.14	25.67	46.00	-20.33	10.10
3.26	28.80	56.00	-27.20	21.25	46.00	-24.75	10.15
3.02	28.30	56.00	-27.70	21.02	46.00	-24.98	10.14



## **Annex A. TEST INSTRUMENTATION & GENERAL PROCEDURES**

### **Annex A. i. TEST INSTRUMENTATION**

<b>Instrument</b>	<b>Model</b>	<b>Serial #</b>	<b>Calibration Date</b>	<b>Calibration Due Date</b>
<b>AC Line Conducted Emissions</b>				
EMI test receiver	ESL6	100262	11/19/2012	11/19/2013
Line Impedance Stabilization Network	LI-125A	191106	11/14/2013	11/13/2014
Line Impedance Stabilization Network	LI-125A	191107	11/14/2013	11/13/2014
Transient Limiter	LIT-153	531118	03/03/2013	03/02/2014
<b>Radiated Emissions</b>				
EMI test receiver	ESL6	100262	11/19/2012	11/19/2013
Positioning Controller	UC3000	MF78020828 2	11/19/2012	11/19/2013
OPT 010 AMPLIFIER(0.1-1300MHz)	8447E	2727A02430	11/19/2012	11/19/2013
Bilog Antenna (30MHz~6GHz)	JB6	A110712	01/27/2013	01/26/2014
Active loop (9kHz -30 MHz)	AL-130	121031	11/20/2012	11/20/2013



## **Annex A. ii. AC LINE CONDUCTED EMISSIONS TEST DESCRIPTION**

### **Test Set-up**

1. The EUT and supporting equipment were set up in accordance with the requirements of the standard on top of a 1.5m x 1m x 0.8m high, non-metallic table, as shown in Annex B.
2. The power supply for the EUT was fed through a 50Ω/50μH EUT LISN, connected to filtered mains.
3. The RF OUT of the EUT LISN was connected to the EMI test receiver via a low-loss coaxial cable.
4. All other supporting equipments were powered separately from another main supply.

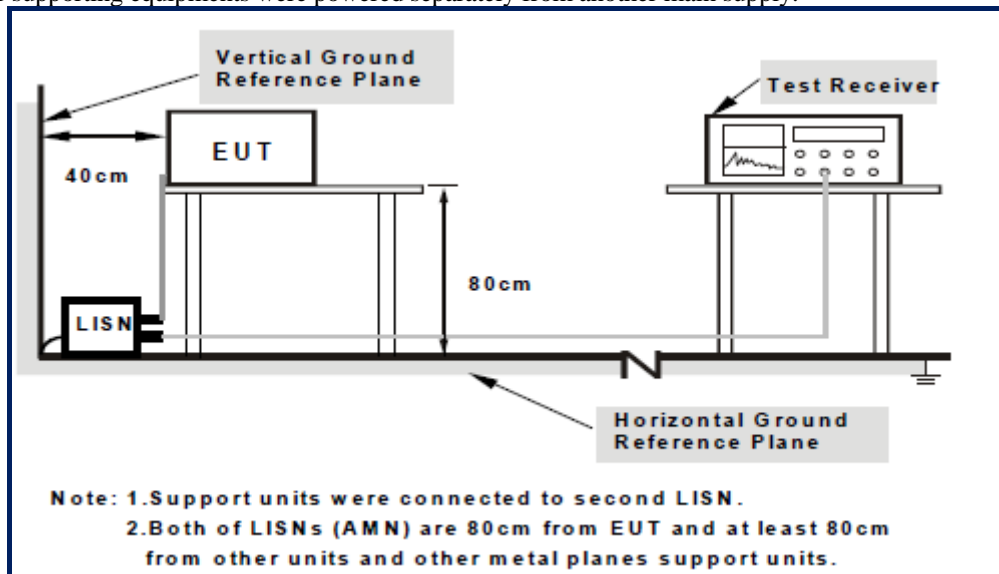

For the actual test configuration, please refer to the related item – Photographs of the Test Configuration1

### **Test Method**

1. The EUT was switched on and allowed to warm up to its normal operating condition.
2. A scan was made on the NEUTRAL line (for AC mains) or Earth line (for DC power) over the required frequency range using an EMI test receiver.
3. High peaks, relative to the limit line, were then selected.
4. The EMI test receiver was then tuned to the selected frequencies and the necessary measurements made with a receiver bandwidth setting of 10 kHz. For FCC tests, only Quasi-peak measurements were made; while for CISPR/EN tests, both Quasi-peak and Average measurements were made.
5. Steps 2 to 4 were then repeated for the LIVE line (for AC mains) or DC line (for DC power).

### **Description of Conducted Emission Program**

This EMC Measurement software run Lab View automation software and offers a common user interface for electromagnetic interference (EMI) measurements. This software is a modern and powerful tool for controlling and monitoring EMI test receivers and EMC test systems. It guarantees reliable collection, evaluation, and documentation of measurement results. Basically, this program will run a pre-scan measurement before it proceeds with the final measurement. The pre-scan routine will run the common scan range from 150 kHz to 30 MHz; the program will first start a peak and average scan on selectable measurement time and step size. After the program complete the pre-scan, this program will perform the Quasi Peak and Average measurement, based on the pre-scan peak data reduction result.



### **Sample Calculation Example**

At 20 MHz

limit =  $250 \mu\text{V} = 47.96 \text{ dB}\mu\text{V}$

Transducer factor of LISN, pulse limiter & cable loss at 20 MHz = 11.20 dB

Q-P reading obtained directly from EMI Receiver = 40.00 dB $\mu\text{V}$   
(Calibrated for system losses)

Therefore, Q-P margin =  $47.96 - 40.00 = 7.96$  i.e. **7.96 dB below limit**

## Annex A. iii. RADIATED EMISSIONS TEST DESCRIPTION

### EUT Characterization

EUT characterisation, over the frequency range from 150KHz to 30 MHz, was done in order to minimise radiated emissions testing time while still maintaining high confidence in the test results.

The EUT was placed in the chamber, at a height of about 0.8 m on a turntable. Its radiated emissions frequency profile was observed, using a spectrum analyzer /receiver with the appropriate broadband antenna placed 3m away from the EUT. Radiated emissions from the EUT were maximised by rotating the turntable manually and manipulating the EUT cables while observing the frequency profile on the spectrum analyzer / receiver. Frequency points at which maximum emissions occurred; clock frequencies and operating frequencies were then noted for the formal radiated emissions test at the Open Area Test Site (OATS) or 3m EMC chamber.

### Test Set-up

1. The EUT and supporting equipment were set up in accordance with the requirements of the standard on top of a 1.5mX1.0mX0.8m high, non-conductive table.
2. The filtered power supply for the EUT and supporting equipment were tapped from the appropriate power sockets located on the turntable.
3. The relevant broadband antenna was set at the required test distance away from the EUT and supporting equipment boundary.

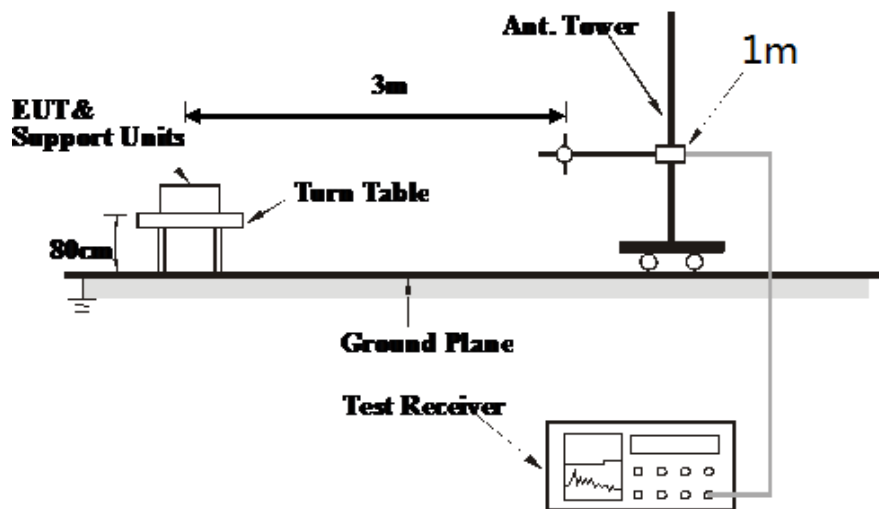

For the actual test configuration, please refer to the related item – Photographs of the Test Configuration2

**Test Method**

The following procedure was performed to determine the maximum emission axis of EUT:

1. Rotate the EUT in turns with three orthogonal axes to determine the axis of maximum emission.
2. Compare the results derived from above two steps. So, the axis of maximum emission from EUT was determined and the configuration was used to perform the final measurement.

**Final Radiated Emission Measurement**

1. Setup the configuration according to figure 1. Turn on EUT and make sure that it is in normal function.
2. For emission frequencies measured below 30MHz, a pre-scan is performed in a shielded chamber to determine the accurate frequencies of higher emissions will be checked on an open test site.
4. Change the orientation of EUT on test table over a range from 0° to 360° with a speed as slow as possible, and keep the azimuth that highest emission is indicated on the spectrum analyzer, Record the highest value as a final reading.
5. Repeat step 4 until all frequencies need to be measured was complete.

During the radiated emission test, the Spectrum Analyzer was set with the following configurations:

Scope	IF	RBW	VBW	Sweep
9KHz~150KHz	200Hz	200Hz	200Hz	Auto
150KHz~30MHz	9KHz	10KHz	30KHz	Auto

**Sample Calculation Example**

The field strength is calculated by adding the Antenna Factor and Cable Factor, and subtracting the Amplifier Gain (if any) from the measured reading. For the limit is employed average value, therefore the peak value can be transferred to average value by subtracting the duty factor. The basic equation with a sample calculation is as follows:

$$\text{Peak} = \text{Reading} + \text{Corrected Factor}$$

where

Corr. Factor = Antenna Factor + Cable Factor - Amplifier Gain (if any)

And the average value is

$$\text{Average} = \text{Peak Value} + \text{Duty Factor or}$$

$$\text{Set RBW} = 1\text{MHz, VBW} = 10\text{Hz.}$$

Note:

If the measured frequencies are fall in the restricted frequency band, the limit employed must be quasi peak value when frequencies are below 30MHz. And the measuring instrument is set to quasi peak detector function.



**SIEMIC, INC.**  
Accessing global markets

Title: EMC Test Report for dianxiaobao  
Main Model: UP3  
Serial Model: N/A  
To: FCC Part 18 Subpart C , FCC Measurement Procedure MP-5 (1986)

Report No.: 13070485-FCC-E1-18  
Issue Date: November 26, 2013  
Page: 21 of 38  
www.siemic.com.cn

## **Annex B. EUT AND TEST SETUP PHOTOGRAPHS**

### **Annex B. i. Photograph 1: EUT External Photo (there are two colour for the EUT's appearance: black and colourful)**



Whole Package – Top View



EUT - Front View(Black)



EUT - Bottom View(Black)

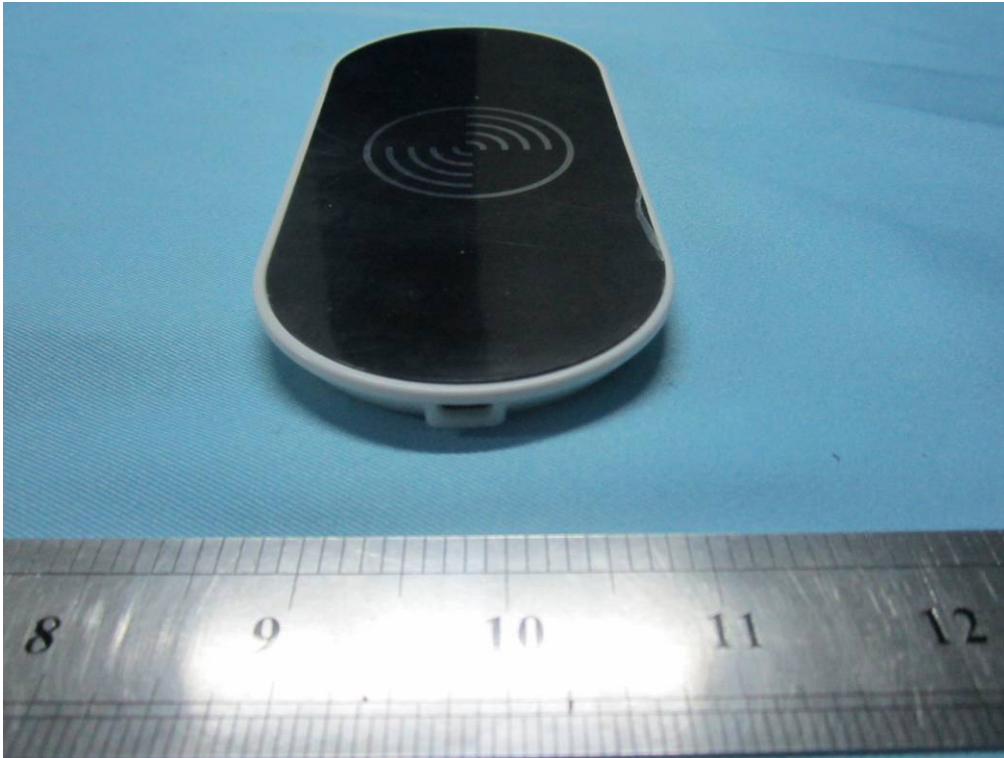

EUT - Top View(Black)

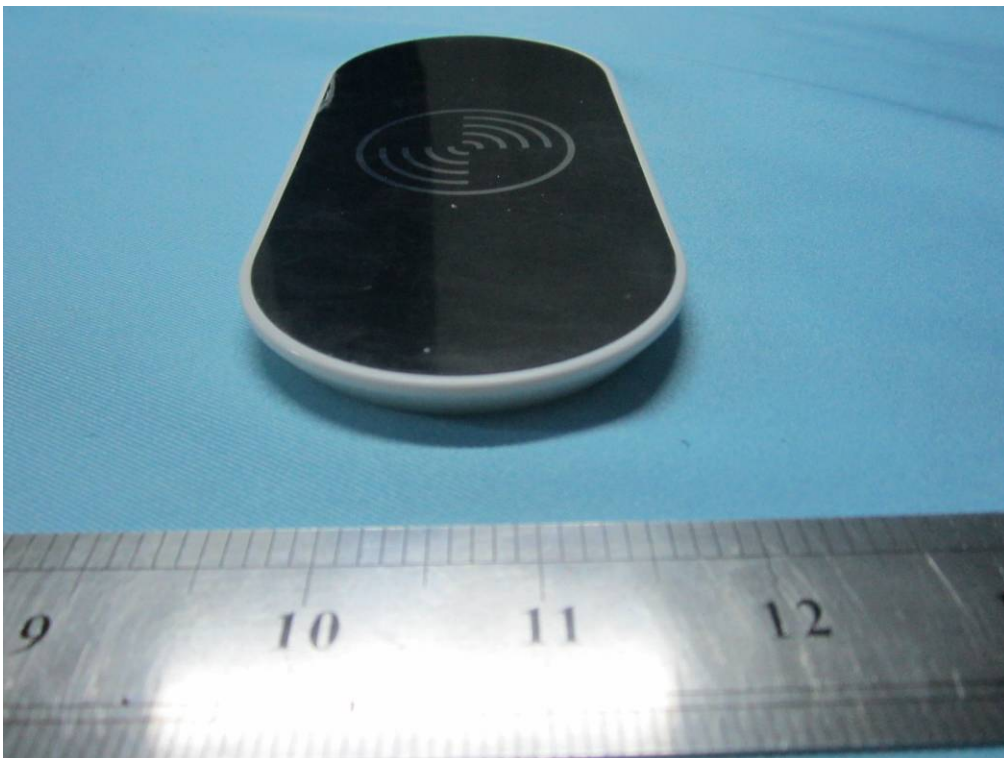

EUT - Rear View(Black)

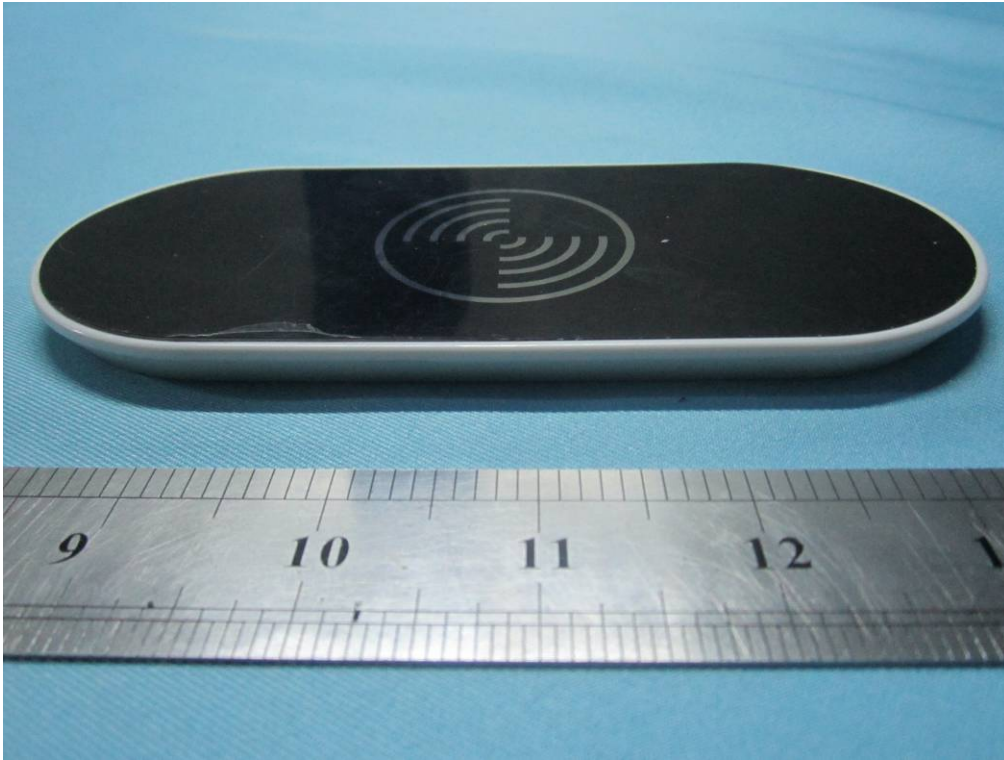

EUT - Left Side View(Black)

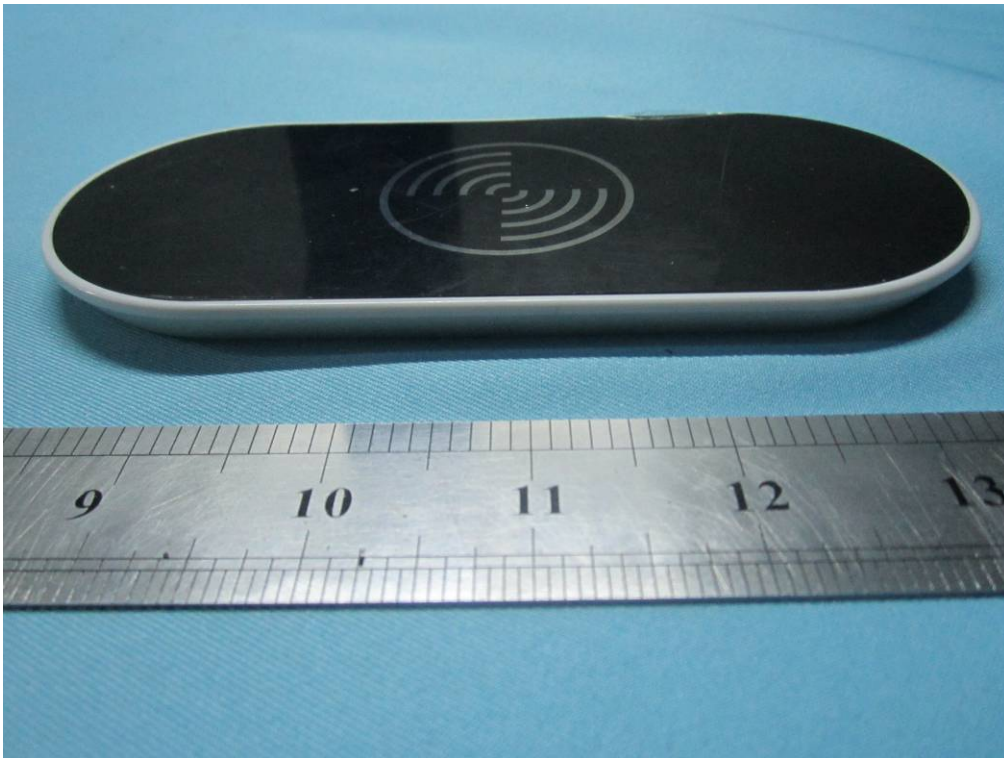

EUT - Right Side View(Black)





**SIEMIC, INC.**  
Accessing global markets

Title: EMC Test Report for dianxiaobao  
Main Model: UP3  
Serial Model: N/A  
To: FCC Part 18 Subpart C , FCC Measurement Procedure MP-5 (1986)

Report No.: 13070485-FCC-E1-18  
Issue Date: November 26, 2013  
Page: 25 of 38  
www.siemic.com.cn

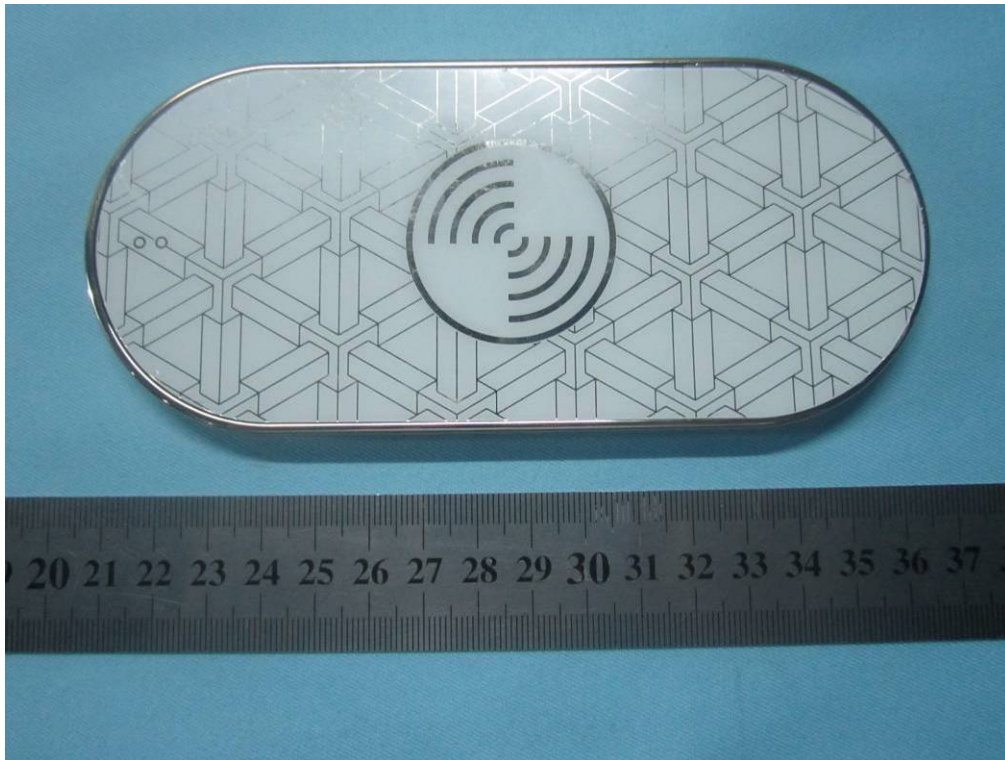

EUT - Top View(Colourful)

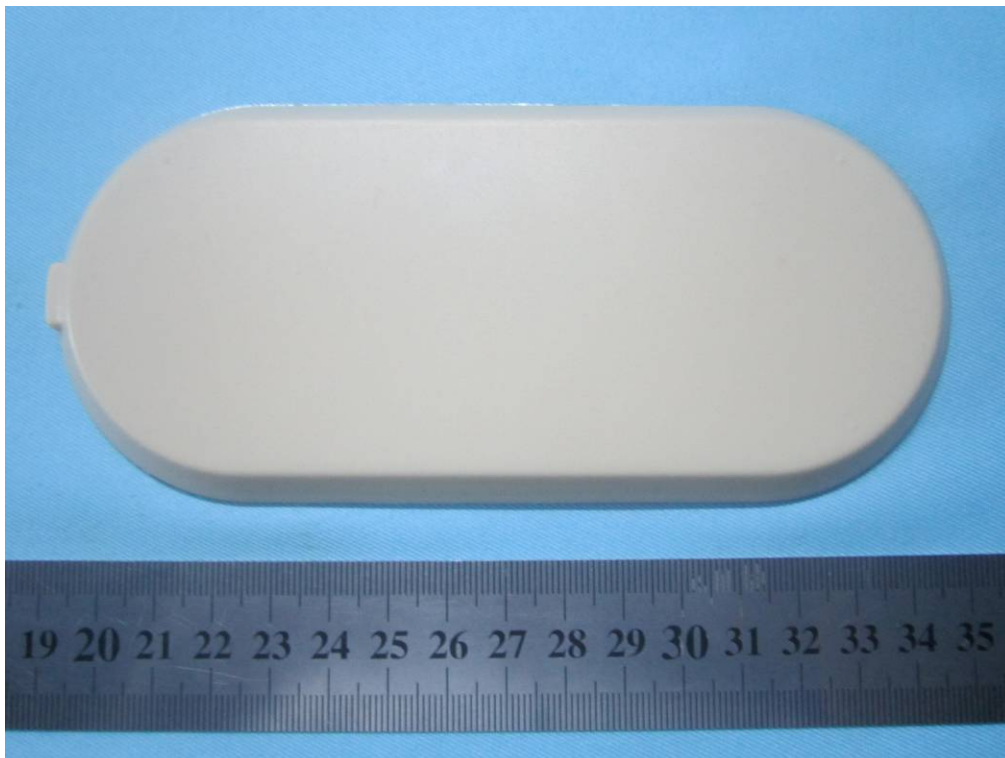

EUT - Bottom View(Colourful)



EUT - Front View(Colourful)

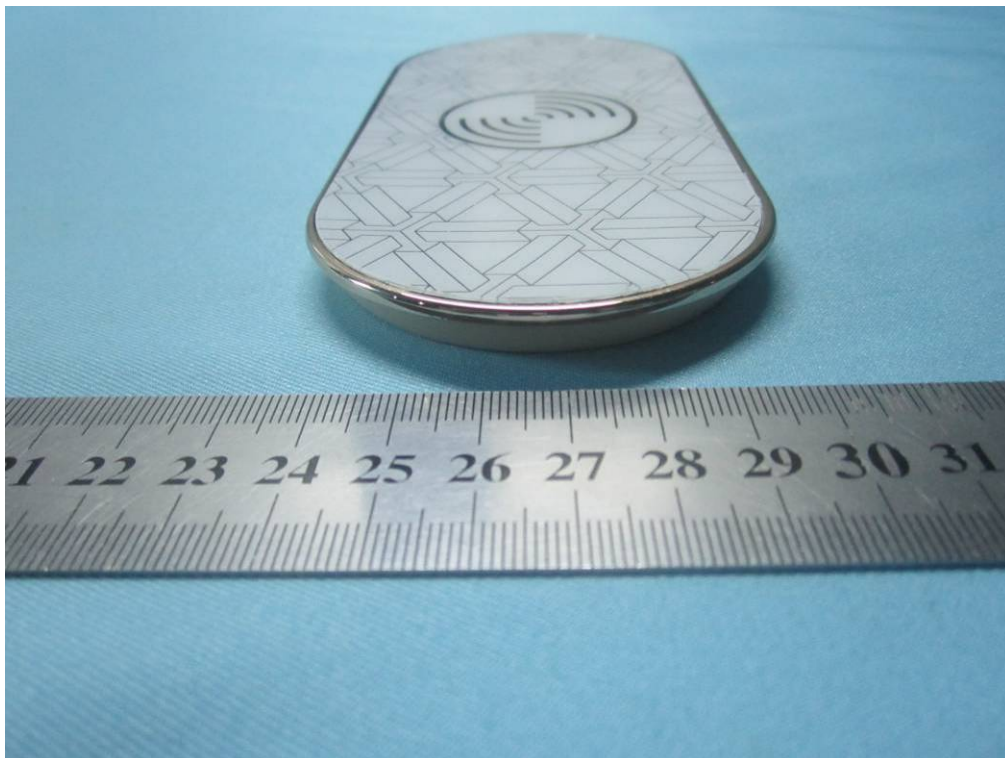

EUT - Rear View(Colourful)



EUT - Left Side View(Colourful)

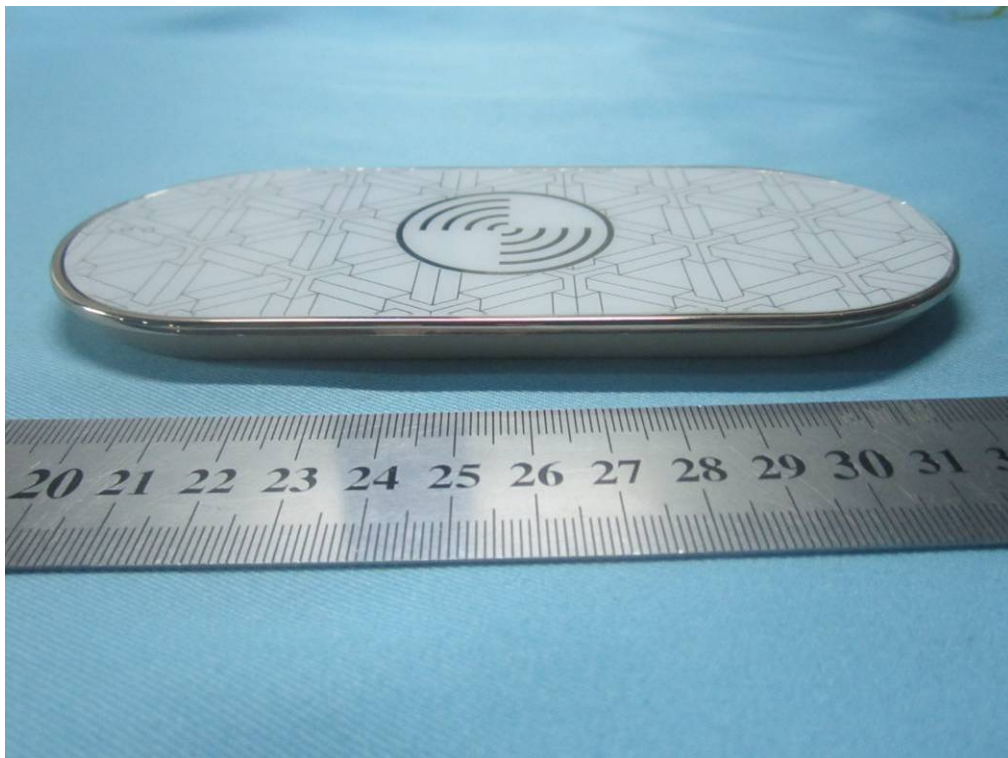

EUT - Right Side View(Colourful)

**Annex B. ii. Photograph 2: EUT Internal Photo**



EUT-Cover Off View

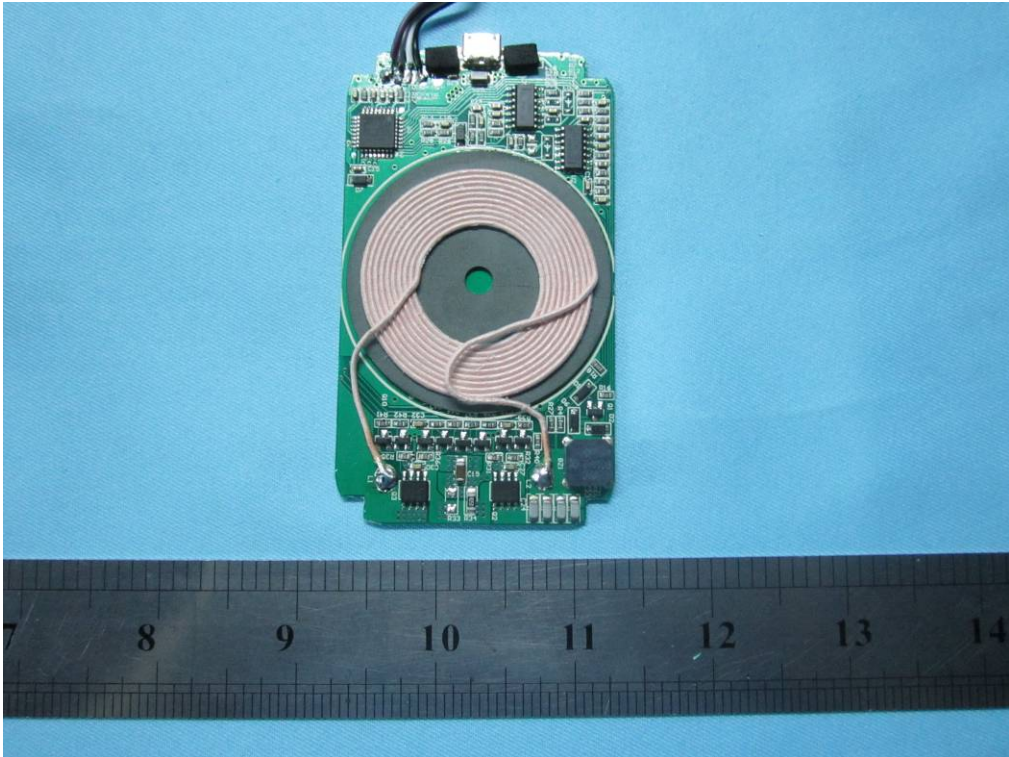

EUT Mainboard - Top View



EUT Mainboard - Bottom View

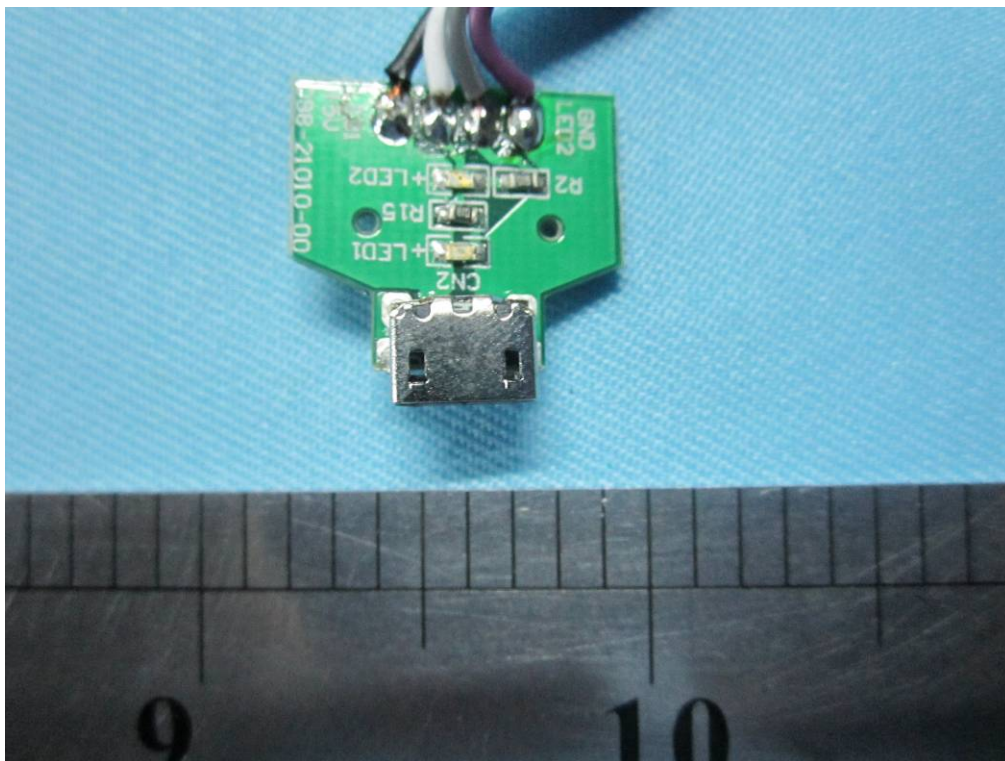

Small Board - Top View

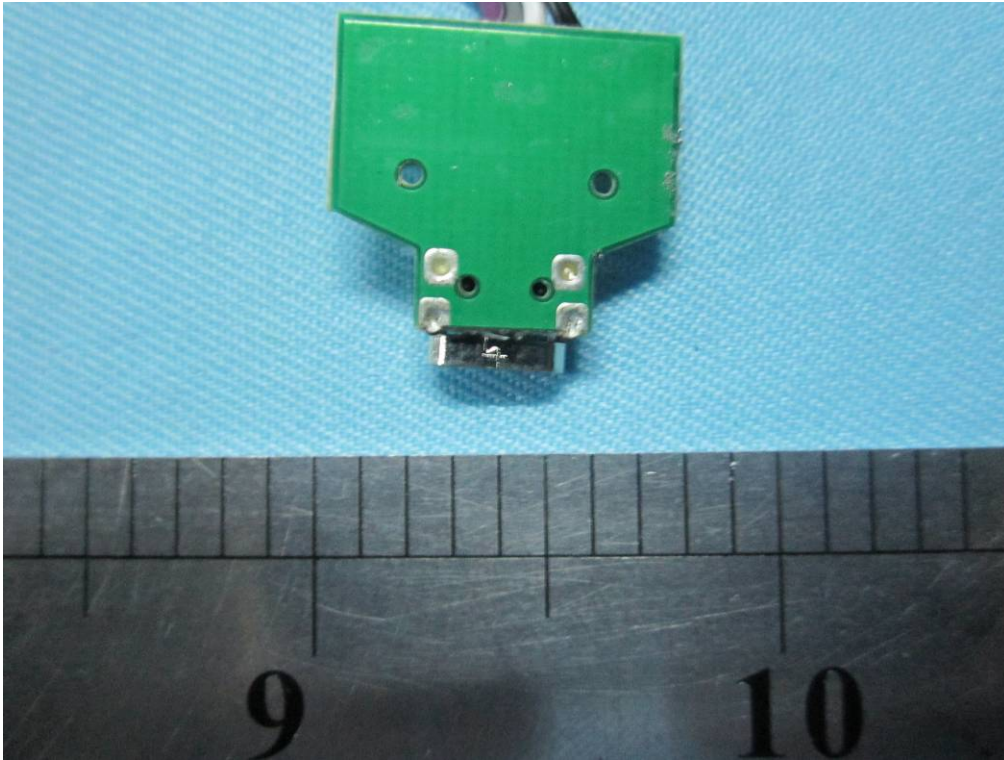

Small Board - Bottom View

**Annex B.iii. Photograph 3: Test Setup Photo**



Conducted Emissions Test Setup Front View

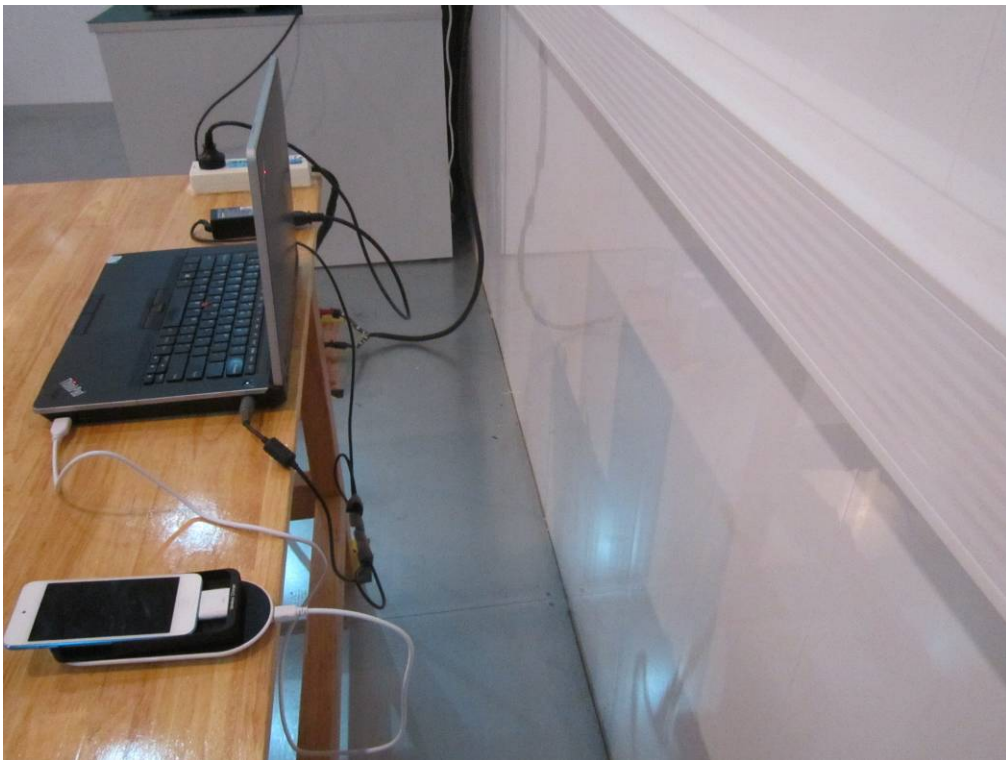

Conducted Emissions Test Setup Side View



Radiated Spurious Emissions Test Setup Below 30 MHz - Front View

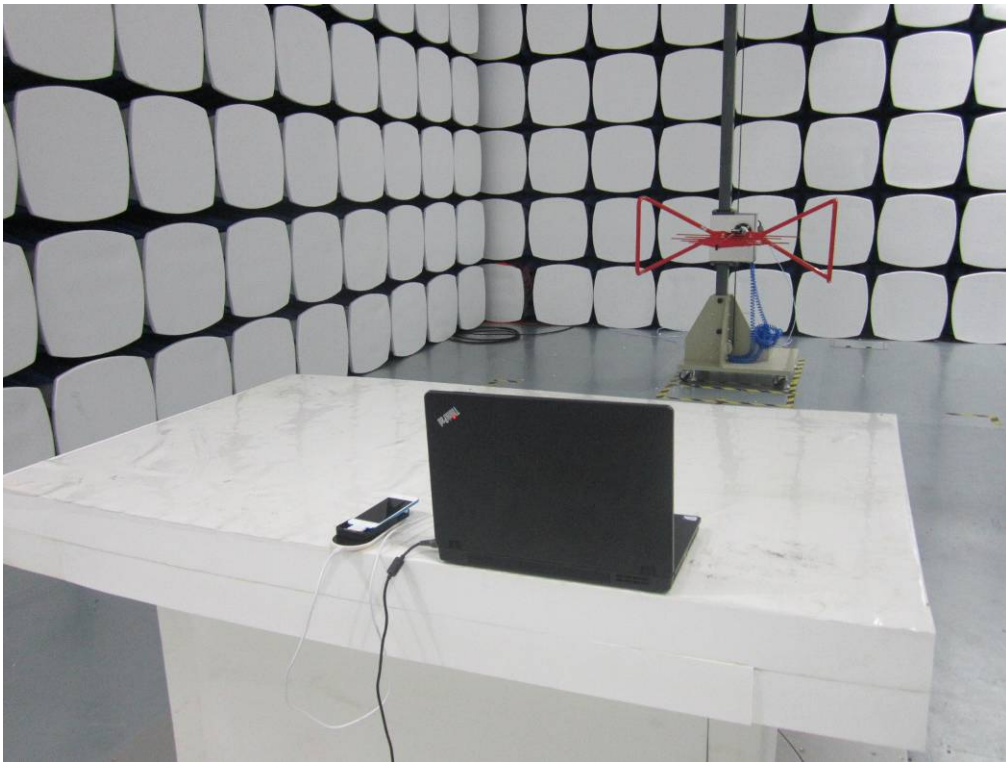

Radiated Spurious Emissions Test Setup Above 30 MHz - Front View





## **Annex C. TEST SETUP AND SUPPORTING EQUIPMENT**

### **EUT TEST CONDITIONS**

#### **Annex C. i. SUPPORTING EQUIPMENT DESCRIPTION**

The following is a description of supporting equipment and details of cables used with the EUT.

<b>Equipment Description (Including Brand Name)</b>	<b>Model &amp; Serial Number</b>	<b>Cable Description (List Length, Type &amp; Purpose)</b>
MP3/MP4	iPod touch 5 & N/A	N/A



## Block Configuration Diagram for Conducted Emissions Mode: Charging

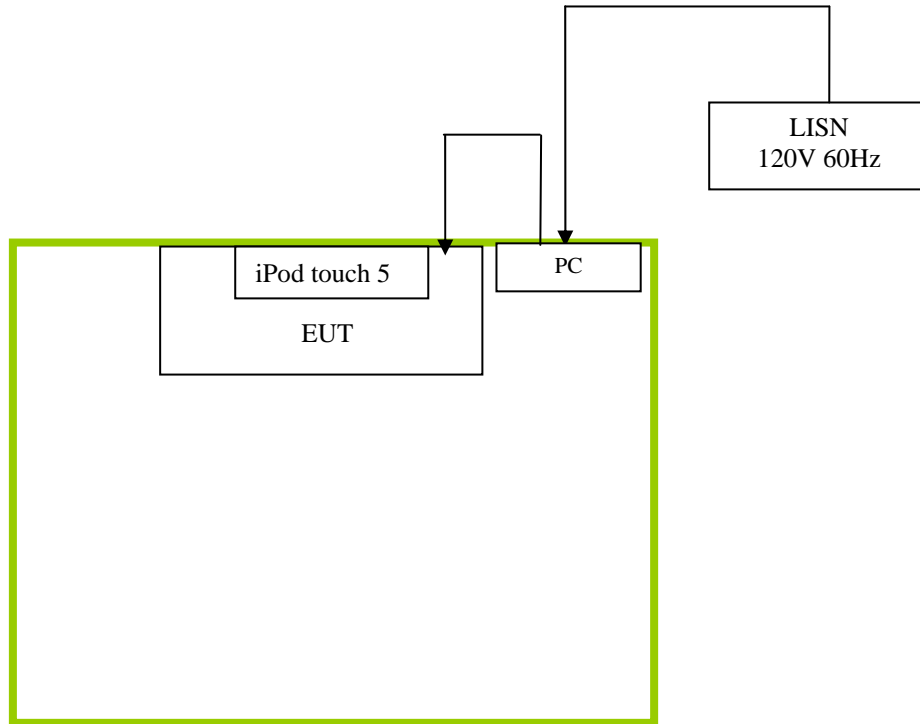



## Block Configuration Diagram for Radiated Emissions Mode: Charging & Downloading

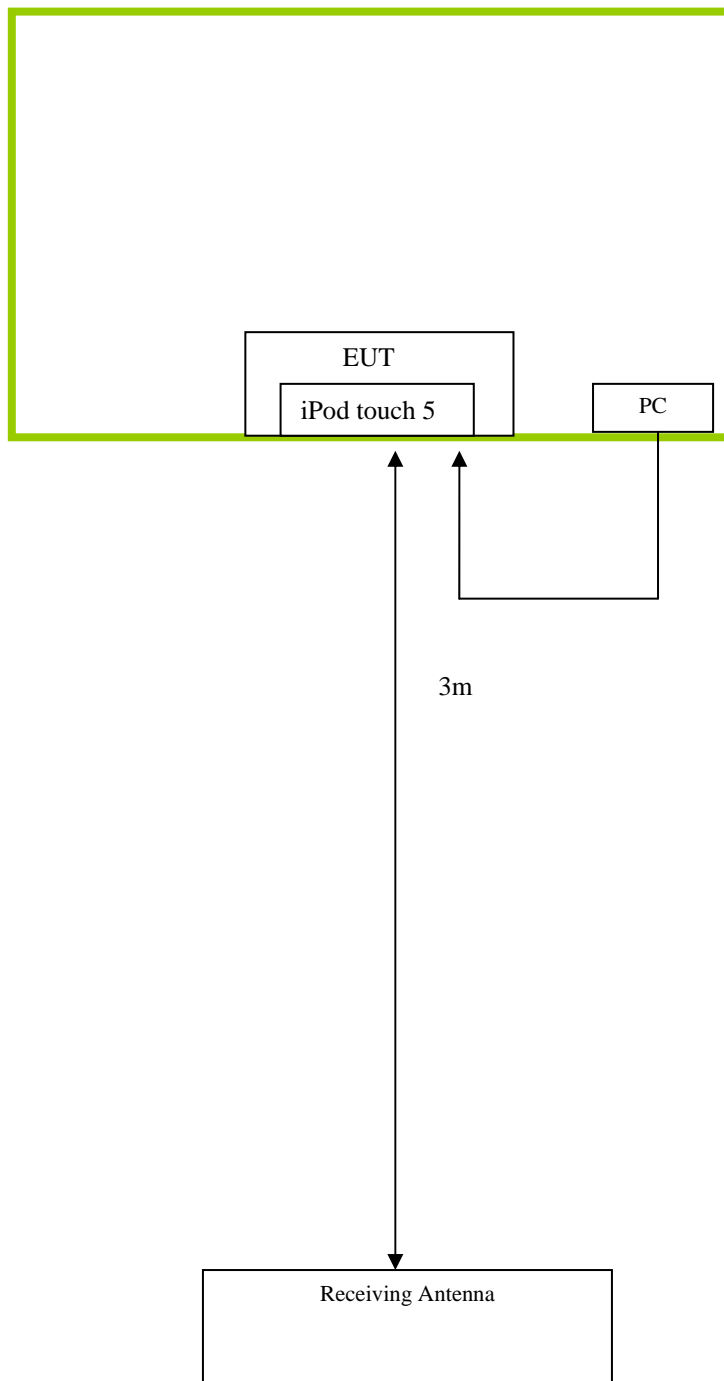



### **Annex C. ii. EUT OPERATING CONDITIONS**

The following is the description of how the EUT is exercised during testing.

<b>Test</b>	<b>Description Of Operation</b>
<b>Emissions</b>	Charging



**SIEMIC, INC.**  
Accessing global markets

Title: EMC Test Report for dianxiaobao  
Main Model: UP3  
Serial Model: N/A  
To: FCC Part 18 Subpart C , FCC Measurement Procedure MP-5 (1986)

Report No.: 13070485-FCC-E1-18  
Issue Date: November 26, 2013  
Page: 37 of 38  
[www.siemic.com.cn](http://www.siemic.com.cn)

## **Annex D. USER MANUAL / BLOCK DIAGRAM / SCHEMATICS / PART LIST**

**Please see attachment**



**SIEMIC, INC.**  
Accessing global markets

Title: EMC Test Report for dianxiaobao  
Main Model: UP3  
Serial Model: N/A  
To: FCC Part 18 Subpart C , FCC Measurement Procedure MP-5 (1986)

Report No.: 13070485-FCC-E1-18  
Issue Date: November 26, 2013  
Page: 38 of 38  
[www.siemic.com.cn](http://www.siemic.com.cn)

## **Annex E. DECLARATION OF SIMILARITY**

**N/A**