



TEST REPORT

Test Report No. : UL-RPT-RP13337971-1616A V2.0

Customer : Raspberry Pi (Trading) Ltd
Model No. : RPI-RM0
FCC ID : 2ABCB-RPIRM0
Technology : WLAN
Test Standard(s) : FCC Parts 15.403(i), 15.407(a)(1)(iv), 15.407(a)(2), 15.407(a)(3), 15.407(e), 15.407(g) & 15.407(h)(1)
Test Laboratory : UL International (UK) Ltd, Basingstoke, Hampshire, RG24 8AH, United Kingdom

1. This test report shall not be reproduced except in full, without the written approval of UL International (UK) Ltd.
2. The results in this report apply only to the sample(s) tested.
3. The sample tested is in compliance with the above standard(s).
4. The test results in this report are traceable to the national or international standards.
5. Version 2.0 supersedes all previous versions.

Date of Issue: 20 October 2020

Checked by:

Sarah Williams
RF Operations Leader, Radio Laboratory

Company Signatory:

Ben Mercer
Lead Project Engineer, Radio Laboratory



UL International (UK) Ltd

Unit 1-3 Horizon, Kingsland Business Park, Wade Road, Basingstoke, Hampshire, RG24 8AH, UK
Telephone: +44 (0)1256 312000
Facsimile: +44 (0)1256 312001

Customer Information

Company Name:	Raspberry Pi (Trading) Ltd
Address:	Maurice Wilkes Building Cowley Road Cambridge CB4 0DS United Kingdom

Report Revision History

Version Number	Issue Date	Revision Details	Revised By
1.0	02/07/2020	Initial Version	Sarah Williams
2.0	20/10/2020	Re-test with new Q values	Sarah Williams

Table of Contents

Customer Information.....	2
Report Revision History	2
Table of Contents.....	3
1. Attestation of Test Results.....	4
1.1. Description of EUT	4
1.2. General Information	4
1.3. Summary of Test Results	5
1.4. Deviations from the Test Specification	5
2. Summary of Testing.....	6
2.1. Facilities and Accreditation	6
2.2. Methods and Procedures	6
2.3. Calibration and Uncertainty	7
2.4. Test and Measurement Equipment	8
3. Equipment Under Test (EUT)	9
3.1. Identification of Equipment Under Test (EUT)	9
3.2. Modifications Incorporated in the EUT	9
3.3. Additional Information Related to Testing	9
3.4. Description of Available Antennas	12
3.5. Description of Test Setup	13
4. Antenna Port Test Results	17
4.1. Transmitter Duty Cycle	17
4.2. Transmitter 26 dB Emission Bandwidth	19
4.2.1. 5.15-5.25 GHz band	20
4.2.2. 5.25-5.35 GHz band	24
4.2.3. 5.47-5.725 GHz band	28
4.2.4. 5.725-5.85 GHz band	32
4.3. Transmitter Minimum 6 dB Bandwidth (5.725-5.85 GHz band)	36
4.3.1. 5.725-5.85 GHz band	37
4.4. Transmitter Maximum Conducted Output Power	41
4.4.1. 5.15-5.25 GHz band	41
4.4.2. 5.25-5.35 GHz band	46
4.4.3. 5.47-5.725 GHz band	51
4.4.4. 5.725-5.85 GHz band	56
4.5. Transmitter Maximum Power Spectral Density	61
4.5.1. 5.15-5.25 GHz band	61
4.5.2. 5.25-5.35 GHz band	63
4.5.3. 5.47-5.725 GHz band	65
4.5.4. 5.725-5.85 GHz band	67

1. Attestation of Test Results

1.1. Description of EUT

The equipment under test was a *Bluetooth* and WiFi radio module.

1.2. General Information

Specification Reference:	47CFR15.407 and 47CFR15.403
Specification Title:	Code of Federal Regulations Volume 47 (Telecommunications): Part 15 Subpart E (Unlicensed National Information Infrastructure Devices) – Sections 15.403 and 15.407
Site Registration:	621311
Location of Testing:	Unit 3 Horizon, Wade Road, Kingsland Business Park, Basingstoke, Hampshire, RG24 8AH, United Kingdom
Test Date:	19 October 2020

1.3. Summary of Test Results

FCC Reference (47CFR)	Measurement	Result
Part 15.35(c)	Transmitter Duty Cycle	Note 1
Part 15.403(i)	Transmitter 26 dB Emission Bandwidth	✔
Part 15.407(e)	Transmitter Minimum 6 dB Bandwidth (5.725-5.85 GHz band)	✔
Part 15.407(a)(1)(iv)	Transmitter Maximum Conducted Output Power (5.15-5.25 GHz band)	✔
Part 15.407(a)(2)	Transmitter Maximum Conducted Output Power (5.25-5.35 GHz & 5.47-5.725 GHz bands)	✔
Part 15.407(a)(3)	Transmitter Maximum Conducted Output Power (5.725-5.85 GHz band)	✔
Part 15.407(a)(1)(iv)	Transmitter Maximum Power Spectral Density (5.15-5.25 GHz band)	✔
Part 15.407(a)(2)	Transmitter Maximum Power Spectral Density (5.25-5.35 GHz & 5.47-5.725 GHz bands)	✔
Part 15.407(a)(3)	Transmitter Maximum Power Spectral Density (5.725-5.85 GHz band)	✔
Part 15.407(g)	Transmitter Frequency Stability (Temperature & Voltage Variation)	Note 2
Part 15.407(h)(1)	Transmitter Power Control	Note 3
Key to Results		
✔ = Complied ✘ = Did not comply		

Note(s):

1. The measurement was performed to assist in the calculation of the level of average output power, power spectral density and emissions as the EUT employs pulsed operation.
2. Frequency stability is better than 20 ppm which ensures that the signal remains in the allocated bands under all operational conditions stated in the user manual.
3. Transmit Power Control was not tested as the maximum EIRP is less than 500 mW (27 dBm).

1.4. Deviations from the Test Specification

For the measurements contained within this test report, there were no deviations from, additions to, or exclusions from the test specifications identified above.

2. Summary of Testing

2.1. Facilities and Accreditation

The test site and measurement facilities used to collect data are located at Unit 3 Horizon, Wade Road, Kingsland Business Park, Basingstoke, Hampshire, RG24 8AH, United Kingdom.

UL International (UK) Ltd is accredited by UKAS. The tests reported herein have been performed in accordance with its terms of accreditation.

2.2. Methods and Procedures

Reference:	ANSI C63.10-2013
Title:	American National Standard of Procedures for Compliance Testing of Unlicensed Wireless Devices
Reference:	KDB 789033 D02 General U-NII Test Procedures New Rules v02r01 December 14, 2017
Title:	Guidelines for Compliance Testing of Unlicensed National Information Infrastructure (U-NII) Devices (Part 15, Subpart E)

2.3. Calibration and Uncertainty

Measuring Instrument Calibration

In accordance with UKAS requirements all the measurement equipment is on a calibration schedule. All equipment was within the calibration period on the date of testing.

Measurement Uncertainty

No measurement or test can ever be perfect and the imperfections give rise to error of measurement in the results. Consequently the result of a measurement is only an approximation to the value measured (the specific quantity subject to measurement) and is only complete when accompanied by a statement of the uncertainty of the approximation.

The expression of uncertainty of a measurement result allows realistic comparison of results with reference values and limits given in specifications and standards.

The uncertainty of the result may need to be taken into account when interpreting the measurement results.

The reported expanded uncertainties below are based on a standard uncertainty multiplied by an appropriate coverage factor such that a confidence level of approximately 95% is maintained. For the purposes of this document “approximately” is interpreted as meaning “effectively” or “for most practical purposes”.

Measurement Type	Range	Confidence Level (%)	Calculated Uncertainty
Duty Cycle	5.15 GHz to 5.850 GHz	95%	±1.14 %
26 dB Emission Bandwidth	5.15 GHz to 5.850 GHz	95%	±4.59 %
Minimum 6 dB Emission Bandwidth	5.15 GHz to 5.850 GHz	95%	±4.59 %
Maximum Conducted Output Power	5.15 GHz to 5.850 GHz	95%	±1.13 dB
Maximum Power Spectral Density	5.15 GHz to 5.850 GHz	95%	±1.13 dB

The methods used to calculate the above uncertainties are in line with those recommended within the various measurement specifications. Where measurement specifications do not include guidelines for the evaluation of measurement uncertainty the published guidance of the appropriate accreditation body is followed.

2.4. Test and Measurement Equipment

Test Equipment Used for Transmitter Conducted Tests

Asset No.	Instrument	Manufacturer	Type No.	Serial No.	Date Calibration Due	Cal. Interval (Months)
M2004	Thermohygrometer	Testo	608-H1	45046425	05 Jan 2021	12
M2036	Signal Analyser	Rohde & Schwarz	FSV30	101791	18 May 2021	12
M2022	Power Sensor	Boonton	55006	9968	20 Jan 2021	12
A3027	Attenuator	Broadwave Technologies Inc.	351-311-006	#1	Calibrated before use	-
A3004	RF Switch	Pickering Interfaces	64-102-002	XZ363230	Calibrated before use	-
A3180	Attenuator	Pasternack	PE7047-3	Not stated	Calibrated before use	-
G0614	Signal Generator	Rohde & Schwarz	SMB100A	260473	19 May 2023	36
A3005	Replay Test Rack	N/A	N/A	N/A	Calibration not required	-

Test Measurement Software/Firmware Used

Name	Version	Release Date
UL VS LTD Replay	20190208	08 February 2019

3. Equipment Under Test (EUT)

3.1. Identification of Equipment Under Test (EUT)

Brand Name:	Raspberry Pi
Model Name or Number:	RPI-RM0
Test Sample Serial Number:	3157589 (<i>Conducted sample #1</i>)
Hardware Version:	V1.0
Software Version:	V1.0
FCC ID:	2ABCB-RPIRM0

3.2. Modifications Incorporated in the EUT

No modifications were applied to the EUT during testing.

3.3. Additional Information Related to Testing

Technology Tested:	WLAN (IEEE 802.11a,n,ac) / U-NII	
Type of Unit:	Transceiver	
Modulation:	BPSK, QPSK, 16QAM, 64QAM & 256QAM	
Data rates:	802.11a	6, 9, 12, 18, 24, 36, 48 & 54 Mbps
	802.11n HT20	MCS0 to MCS7 (SISO)
	802.11n HT40	MCS0 to MCS7 (SISO)
	802.11ac VHT20	MCS0 to MCS8 (SISO)
	802.11ac VHT40	MCS0 to MCS9 (SISO)
	802.11ac VHT80	MCS0 to MCS9 (SISO)
Power Supply Requirement(s):	Nominal	5.0 VDC
Maximum Conducted Output Power:	20 MHz	16.9 dBm
	40 MHz	18.2 dBm
	80 MHz	17.8 dBm

Additional Information Related to Testing (continued)

Channel Spacing:	20 MHz		
Transmit Frequency Band:	5150 MHz to 5250 MHz		
Transmit Channels Tested:	Channel ID	Channel Number	Channel Frequency (MHz)
	Bottom	36	5180
	Middle	40	5200
	Top	48	5240
Transmit Frequency Band:	5250 MHz to 5350 MHz		
Transmit Channels Tested:	Channel ID	Channel Number	Channel Frequency (MHz)
	Bottom	52	5260
	Middle	56	5280
	Top	64	5320
Transmit Frequency Band:	5470 MHz to 5725 MHz		
Transmit Channels Tested:	Channel ID	Channel Number	Channel Frequency (MHz)
	Bottom	100	5500
	Middle	116	5580
	Top	140	5700
Transmit Frequency Band:	5725 MHz to 5850 MHz		
Transmit Channels Tested:	Channel ID	Channel Number	Channel Frequency (MHz)
	Bottom	149	5745
	Middle	157	5785
	Top	165	5825

Additional Information Related to Testing (continued)

Channel Spacing:	40 MHz		
Transmit Frequency Band:	5150 MHz to 5250 MHz		
Transmit Channels Tested:	Channel ID	Channel Number	Channel Frequency (MHz)
	Bottom	38	5190
	Top	46	5230
Transmit Frequency Band:	5250 MHz to 5350 MHz		
Transmit Channels Tested:	Channel ID	Channel Number	Channel Frequency (MHz)
	Bottom	54	5270
	Top	62	5310
Transmit Frequency Band:	5470 MHz to 5725 MHz		
Transmit Channels Tested:	Channel ID	Channel Number	Channel Frequency (MHz)
	Bottom	102	5510
	Middle	110	5550
	Top	134	5670
Transmit Frequency Band:	5725 MHz to 5850 MHz		
Transmit Channels Tested:	Channel ID	Channel Number	Channel Frequency (MHz)
	Bottom	151	5755
	Top	159	5795

Additional Information Related to Testing (continued)

Channel Spacing:	80 MHz		
Transmit Frequency Band:	5150 MHz to 5250 MHz		
Transmit Channels Tested:	Channel ID	Channel Number	Channel Frequency (MHz)
	Single	42	5210
Transmit Frequency Band:	5250 MHz to 5350 MHz		
Transmit Channels Tested:	Channel ID	Channel Number	Channel Frequency (MHz)
	Single	58	5290
Transmit Frequency Band:	5470 MHz to 5725 MHz		
Transmit Channels Tested:	Channel ID	Channel Number	Channel Frequency (MHz)
	Bottom	106	5530
	Top	122	5610
Transmit Frequency Band:	5725 MHz to 5850 MHz		
Transmit Channels Tested:	Channel ID	Channel Number	Channel Frequency (MHz)
	Single	155	5775

3.4. Description of Available Antennas

The table below lists the internal niche antenna and the external antenna available.

Manufacturer	Type	Frequency Range (MHz)	Antenna Gain (dBi)
ProAnt	Internal	5150 to 5850	2.5
Raspberry Pi	External	5150 to 5850	2.0

3.5. Description of Test Setup

Support Equipment

The following support equipment was used to exercise the EUT during testing:

Description:	Pi4 board used as test jig
Brand Name:	Raspberry Pi4
Model Name or Number:	Pi4
Serial Number:	10000000ae575e0

Description:	Micro SD Card with OS image
Brand Name:	SanDisk
Model Name or Number:	16 GB card
Serial Number:	Not marked or stated

Description:	USB Mouse
Brand Name:	Raspberry Pi
Model Name or Number:	RPI-MOUSE
Serial Number:	Not marked or stated

Description:	USB Keyboard
Brand Name:	Raspberry Pi
Model Name or Number:	RPI-KYB
Serial Number:	Not marked or stated

Description:	Power Supply. 100-230 VAC Input / 5 VDC Output
Brand Name:	Belkin
Model Name or Number:	Not marked or stated
Serial Number:	Not marked or stated

Operating Modes

The EUT was tested in the following operating mode(s):

- Continuously transmitting with a modulated carrier at maximum power on the bottom, middle and top channels as required using the supported data rates/modulation types.

Configuration and Peripherals

The EUT was tested in the following configuration(s):

- The customer supplied 'wl' chipset commands. Test commands were provided in the wlan_testing.sh file located on the /home/pi drive of the EUT. The test commands were entered into the automated test system and used to configure the EUT to enable a continuous transmission and to select the test channels, data rates and modulation schemes as required.
- The customer declared the following data rates to be used for all measurements as.
 - 802.11a - BPSK / 6 Mbps
 - 802.11n HT20 - BPSK / MCS0
 - 802.11n HT40 - BPSK / MCS0
 - 802.11ac VHT80 - BPSK / MCS0
- RF cables and attenuators connecting the test equipment to the EUT were calibrated before use and the calibration data incorporated into the conducted measurement results.
- The EUT was powered via the Pi4 test jig which was powered from an AC/DC switch mode power supply.

Power Settings

The power settings below have been used for testing:

Channel:	Mode	Q value Used
36	a (6 Mbps)	66
40	a (6 Mbps)	74
48	a (6 Mbps)	73
52	a (6 Mbps)	73
56	a (6 Mbps)	72
64	a (6 Mbps)	65
100	a (6 Mbps)	58
116	a (6 Mbps)	66
140	a (6 Mbps)	66
149	a (6 Mbps)	63
157	a (6 Mbps)	65
165	a (6 Mbps)	66
36	HT20 (MCS0)	58
40	HT20 (MCS0)	58
48	HT20 (MCS0)	58
52	HT20 (MCS0)	65
56	HT20 (MCS0)	68
64	HT20 (MCS0)	61
100	HT20 (MCS0)	52
116	HT20 (MCS0)	63
140	HT20 (MCS0)	57
149	HT20 (MCS0)	64
157	HT20 (MCS0)	61
165	HT20 (MCS0)	60
38	HT40 (MCS0)	59
46	HT40 (MCS0)	70
54	HT40 (MCS0)	75
62	HT40 (MCS0)	63
102	HT40 (MCS0)	54
110	HT40 (MCS0)	71
134	HT40 (MCS0)	73
151	HT40 (MCS0)	70
159	HT40 (MCS0)	70
42	VHT80 (MCS0x1)	63
58	VHT80 (MCS0x1)	60
106	VHT80 (MCS0x1)	51
122	VHT80 (MCS0x1)	68
155	VHT80 (MCS0x1)	73

Test Setup Diagrams

Conducted Tests:

Test Setup for Transmitter Conducted Tests

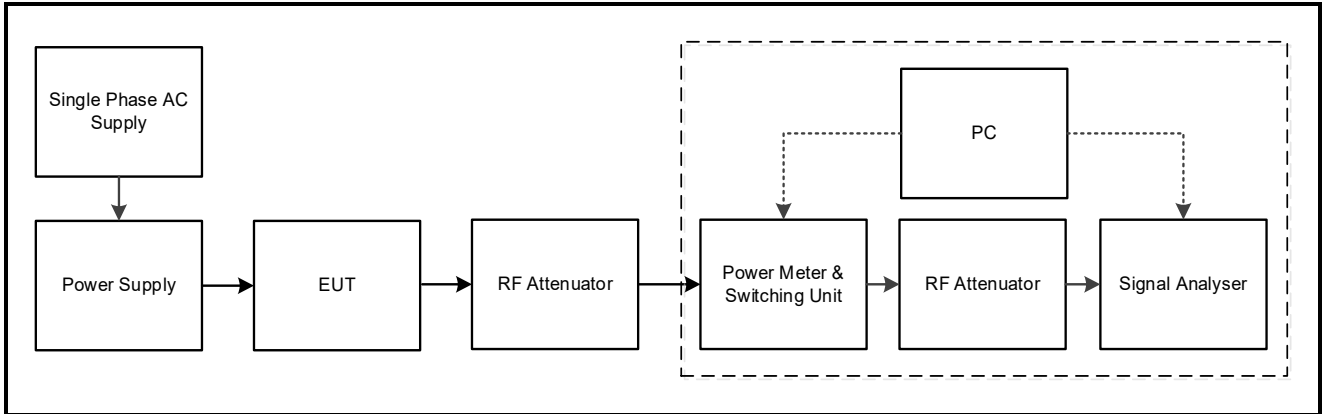

4. Antenna Port Test Results

4.1. Transmitter Duty Cycle

Test Summary:

Test Engineer:	Max Passell	Test Date:	19 October 2020
Test Sample Serial Number:	3157589		

FCC Reference:	Part 15.35(c)
Test Method Used:	KDB 789033 D02 Section II.B.2.b)

Environmental Conditions:

Temperature (°C):	24
Relative Humidity (%):	42

Note(s):

1. In order to assist with the determination of the average level of fundamental and spurious emissions field strength, measurements were made of duty cycle to determine the transmission duration and the silent period time of the transmitter. The transmitter duty cycle was measured using a spectrum analyser in the time domain and calculated by using the following calculation:

$$10 \log 1 / (\text{On Time} / [\text{Period or } 100\text{ms whichever is the lesser}]).$$

2. Plots below are for data rates with a duty cycle less than 98%. Results for all other modes having a duty cycle >98% are archived on the UL International (UK) Ltd IT server and available for inspection if required.

Transmitter Duty Cycle (continued)

Results: 802.11n / 40 MHz / MCS0

Pulse Duration (ms)	Period (ms)	Duty Cycle Correction Factor (dB)
0.941	0.966	0.1

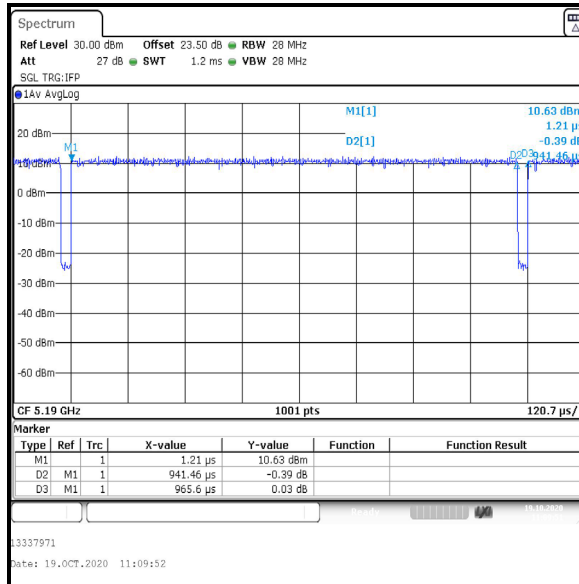

Results: 802.11ac / 80 MHz / MCS0x1

Pulse Duration (ms)	Period (ms)	Duty Cycle Correction Factor (dB)
0.459	0.482	0.2

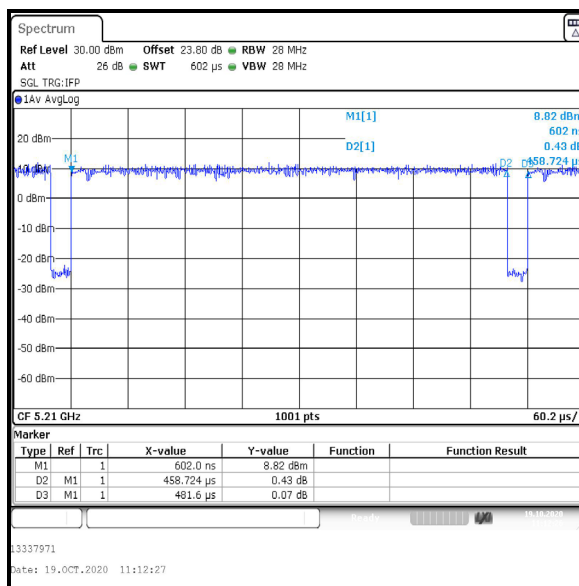

4.2. Transmitter 26 dB Emission Bandwidth

Test Summary:

Test Engineer:	Max Passell	Test Date:	19 October 2020
Test Sample Serial Number:	3157589		

FCC Reference:	Part 15.403(i)
Test Method Used:	KDB 789033 D02 Section II.C.1.

Environmental Conditions:

Temperatures (°C):	24
Relative Humidity (%):	42

Note(s):

1. Measurements were performed in accordance with KDB 789033 Section II.C.1 Emission Bandwidth (EBW) test procedure on the relevant channels in all supported operating bands.
2. The signal analyser's resolution bandwidth was set to approximately 1% of the measured 26 dB emission bandwidth.
3. The signal analyser was connected to the RF port on the EUT using an RF switch, suitable attenuation and RF cables. An RF level offset was entered on the signal analyser to compensate for the loss of the switch, attenuators and RF cables.

Transmitter 26 dB Emission Bandwidth (5.15-5.25 GHz band) (continued)

4.2.1. 5.15-5.25 GHz band

Results: 802.11a / 20 MHz / BPSK / 6 Mbps

Channel	Frequency (MHz)	26 dB Emission Bandwidth (MHz)
Bottom	5180	23.377
Middle	5200	25.654
Top	5240	31.409

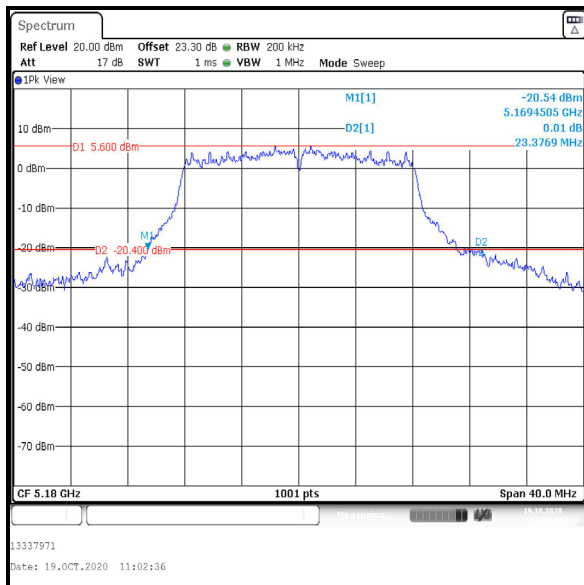

Bottom Channel

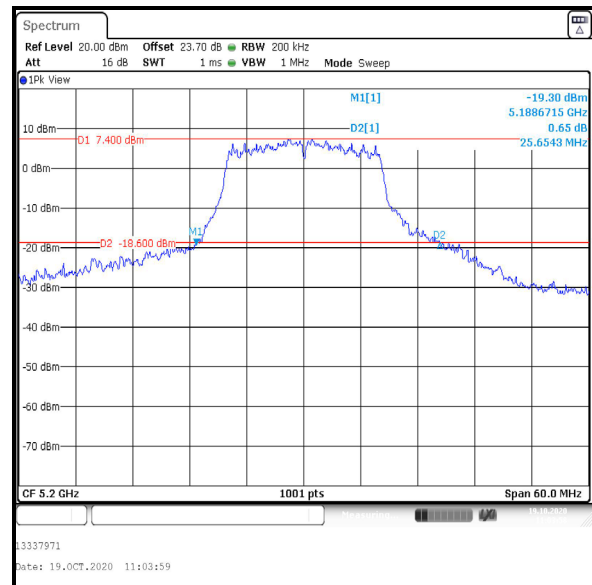

Middle Channel

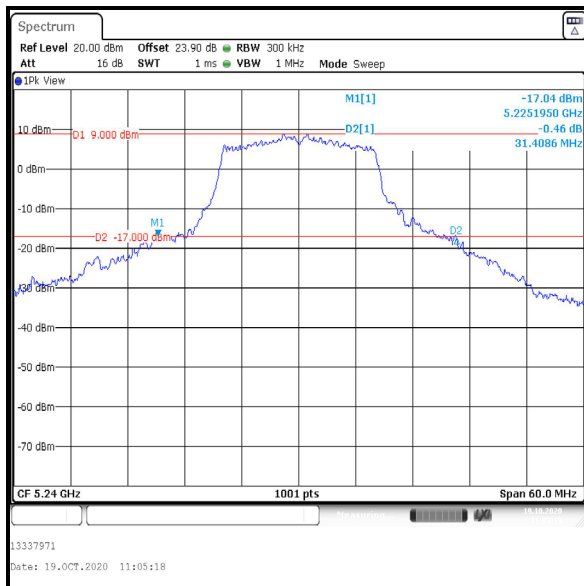

Top Channel

Transmitter 26 dB Emission Bandwidth (5.15-5.25 GHz band) (continued)

Results: 802.11n / 20 MHz / BPSK / MCS0

Channel	Frequency (MHz)	26 dB Emission Bandwidth (MHz)
Bottom	5180	21.498
Middle	5200	22.178
Top	5240	21.619

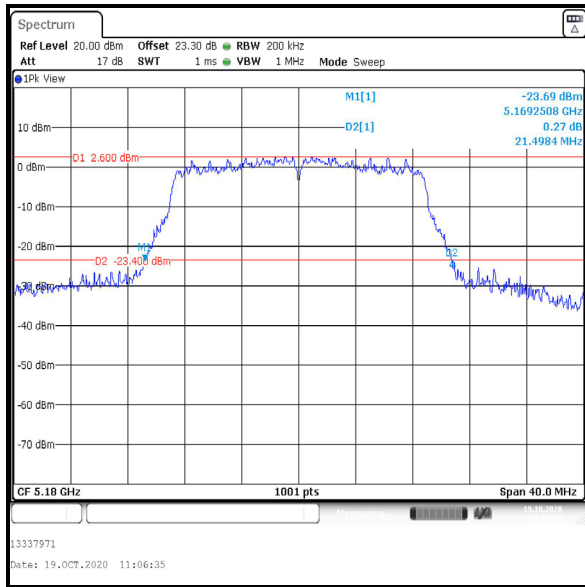

Bottom Channel

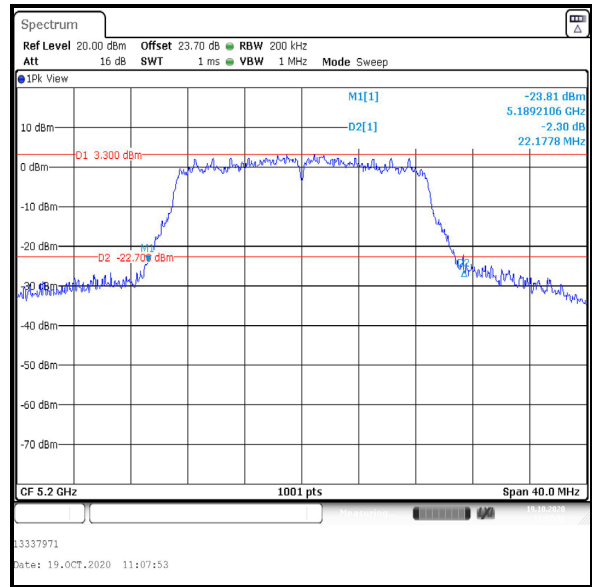

Middle Channel

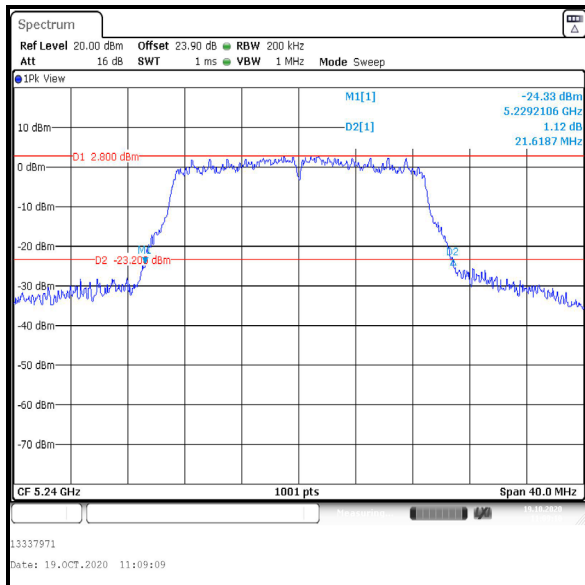

Top Channel

Transmitter 26 dB Emission Bandwidth (5.15-5.25 GHz band) (continued)

Results: 802.11n / 40 MHz / BPSK / MCS0

Channel	Frequency (MHz)	26 dB Emission Bandwidth (MHz)
Bottom	5190	46.913
Top	5230	71.241

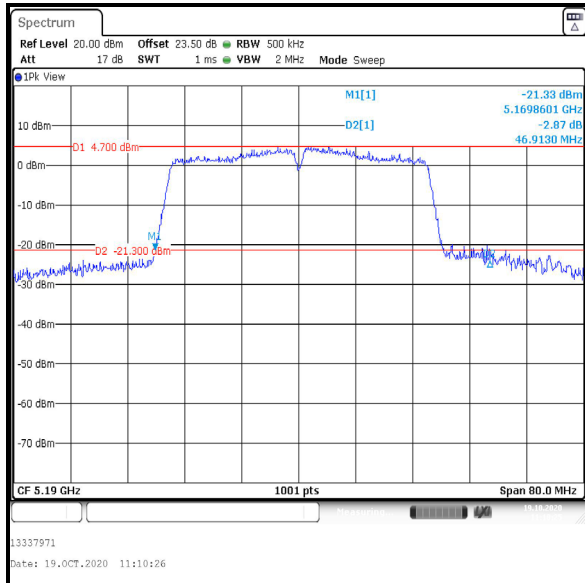

Bottom Channel

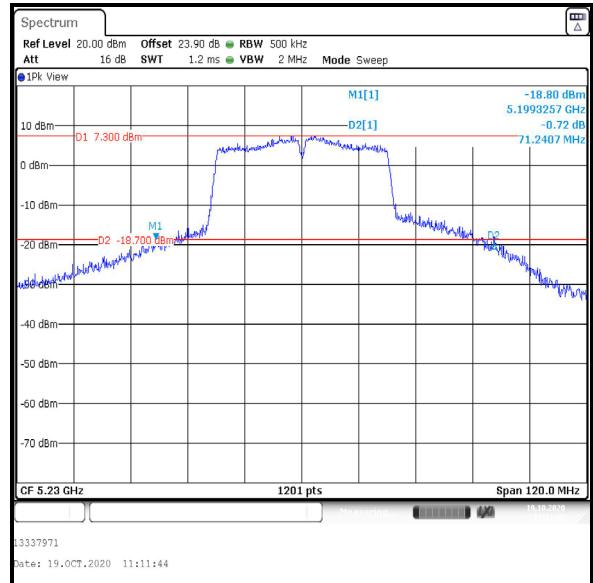

Top Channel

Transmitter 26 dB Emission Bandwidth (5.15-5.25 GHz band) (continued)

Results: 802.11ac / 80 MHz / BPSK / MCS0x1

Channel	Frequency (MHz)	26 dB Emission Bandwidth (MHz)
Single	5210	107.733

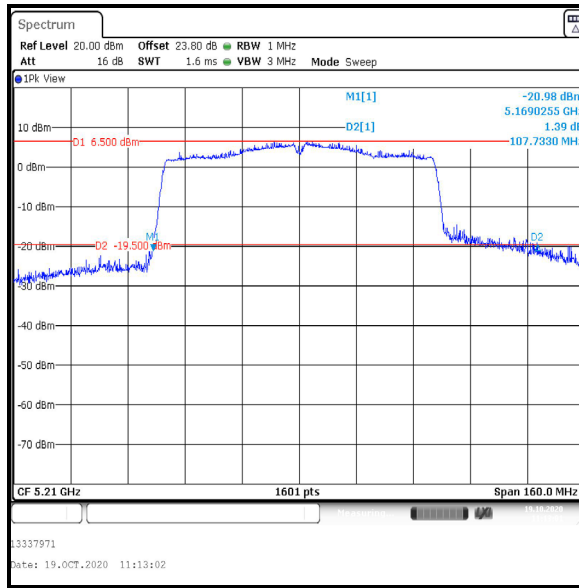

Single Channel

Transmitter 26 dB Emission Bandwidth (5.25-5.35 GHz band) (continued)

4.2.2. 5.25-5.35 GHz band

Results: 802.11a / 20 MHz / BPSK / 6 Mbps

Channel	Frequency (MHz)	26 dB Emission Bandwidth (MHz)
Bottom	5260	28.052
Middle	5280	29.910
Top	5320	23.137

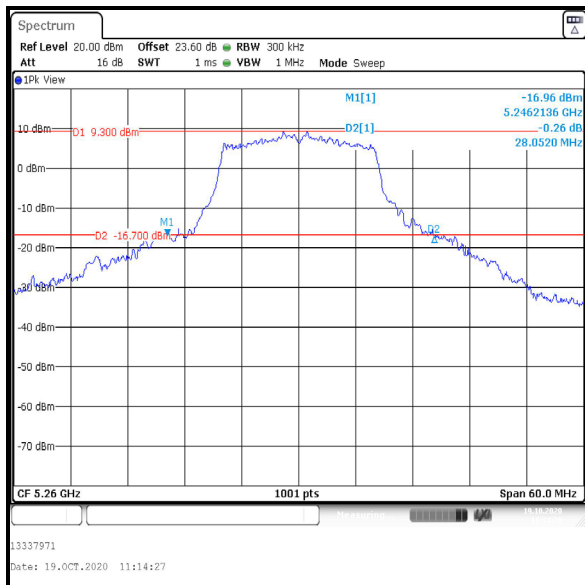

Bottom Channel

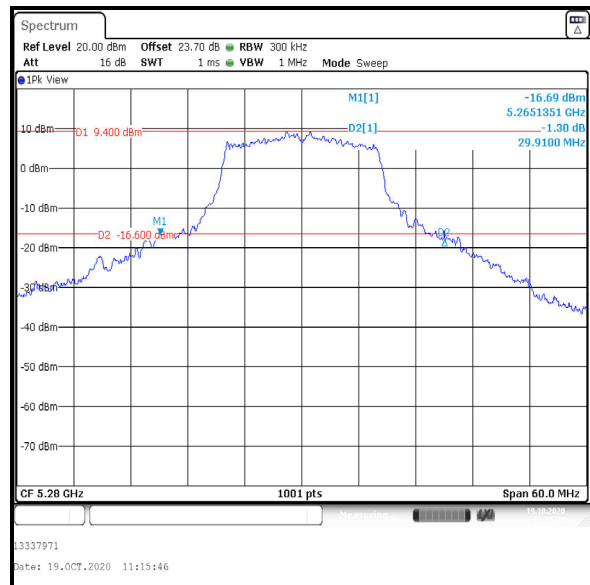

Middle Channel

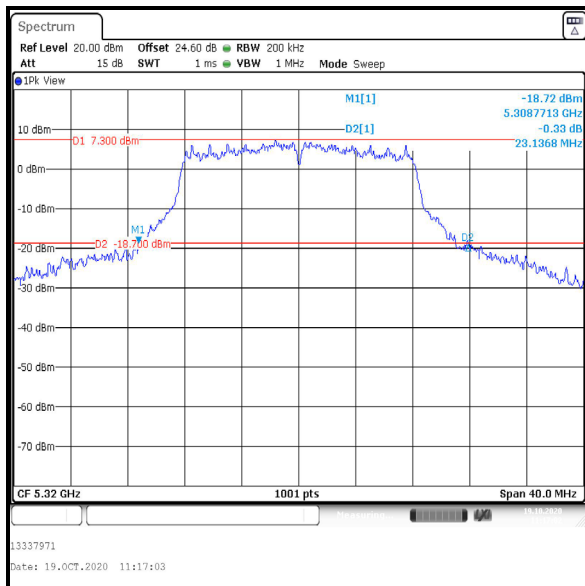

Top Channel

Transmitter 26 dB Emission Bandwidth (5.25-5.35 GHz band) (continued)

Results: 802.11n / 20 MHz / BPSK / MCS0

Channel	Frequency (MHz)	26 dB Emission Bandwidth (MHz)
Bottom	5260	24.056
Middle	5280	28.951
Top	5320	21.858

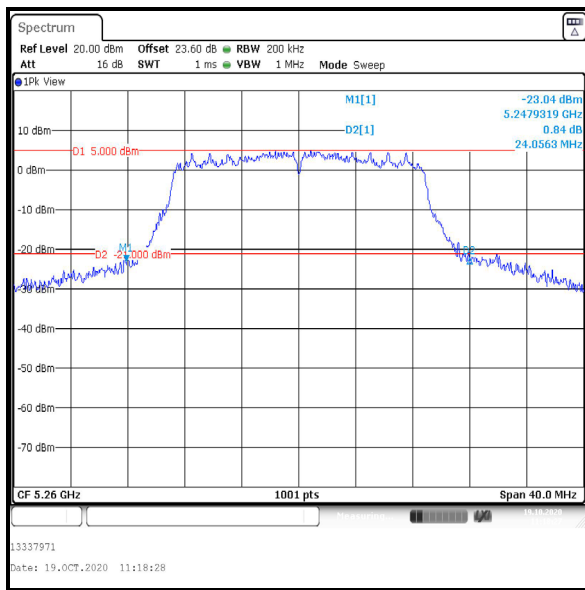

Bottom Channel

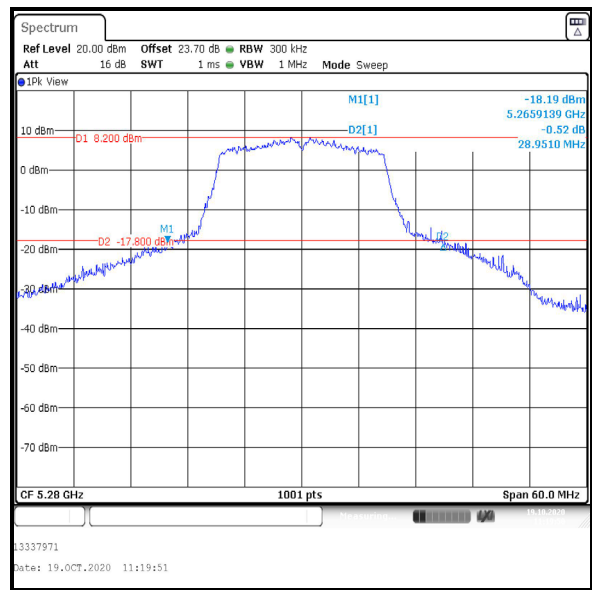

Middle Channel

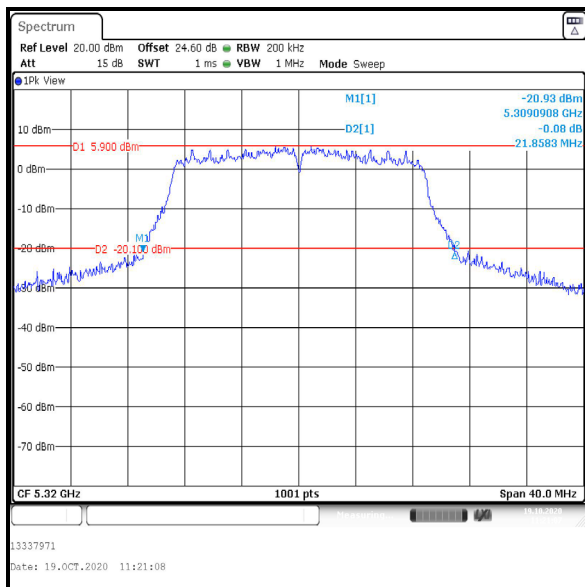

Top Channel

Transmitter 26 dB Emission Bandwidth (5.25-5.35 GHz band) (continued)

Results: 802.11n / 40 MHz / BPSK / MCS0

Channel	Frequency (MHz)	26 dB Emission Bandwidth (MHz)
Bottom	5270	69.542
Top	5310	52.827

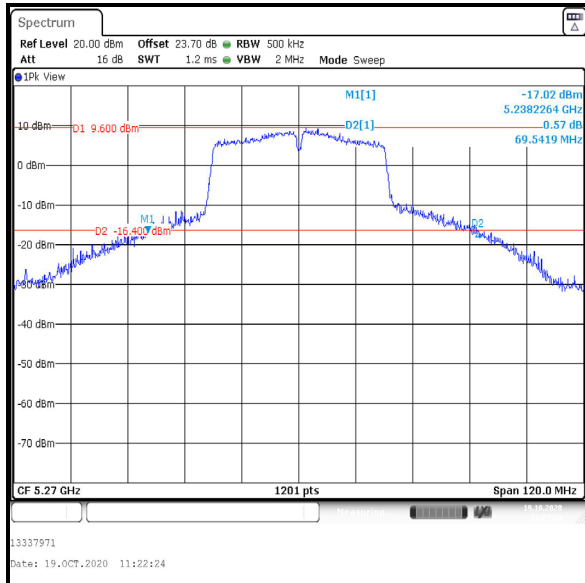

Bottom Channel

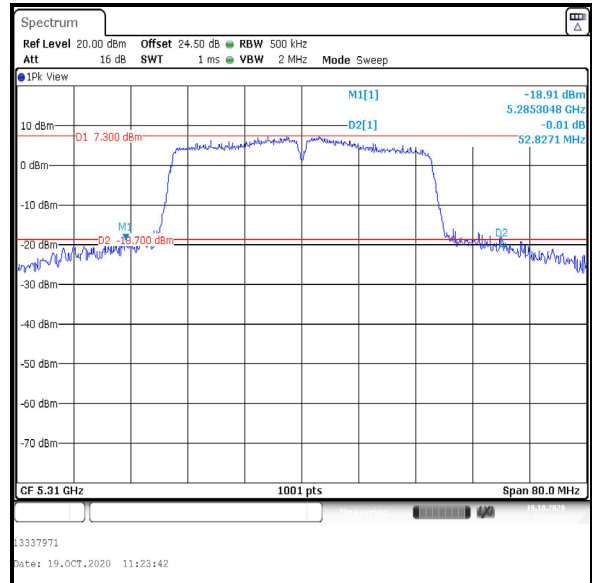

Top Channel

Transmitter 26 dB Emission Bandwidth (5.25-5.35 GHz band) (continued)

Results: 802.11ac / 80 MHz / BPSK / MCS0x1

Channel	Frequency (MHz)	26 dB Emission Bandwidth (MHz)
Single	5290	82.941

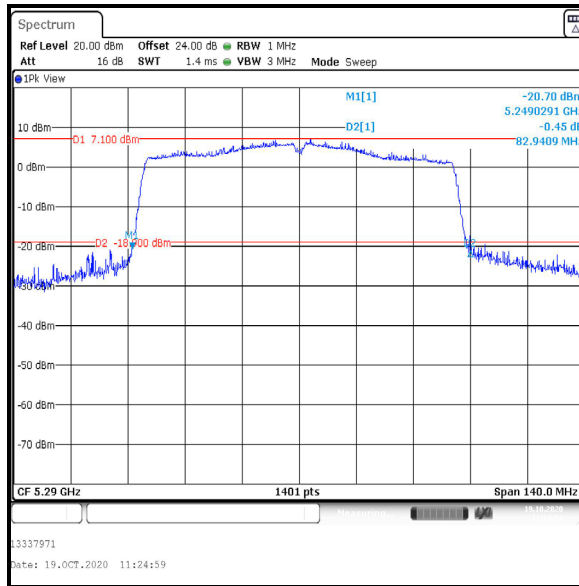

Single Channel

Transmitter 26 dB Emission Bandwidth (5.47-5.725 GHz band) (continued)

4.2.3. 5.47-5.725 GHz band

Results: 802.11a / 20 MHz / BPSK / 6 Mbps

Channel	Frequency (MHz)	26 dB Emission Bandwidth (MHz)
Bottom	5500	21.179
Middle	5580	21.099
Top	5700	21.179

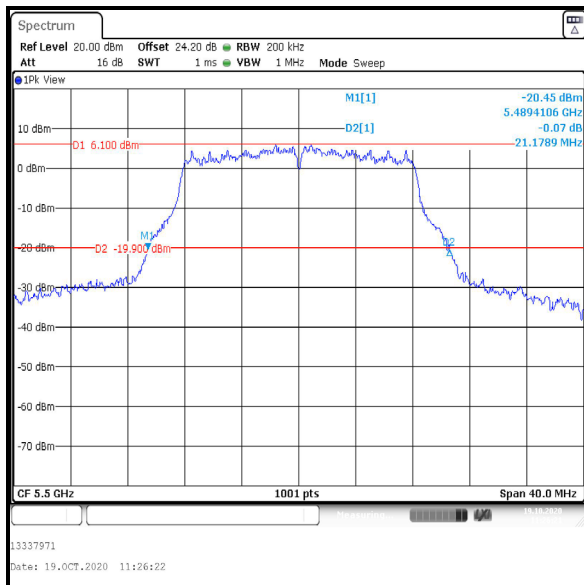

Bottom Channel

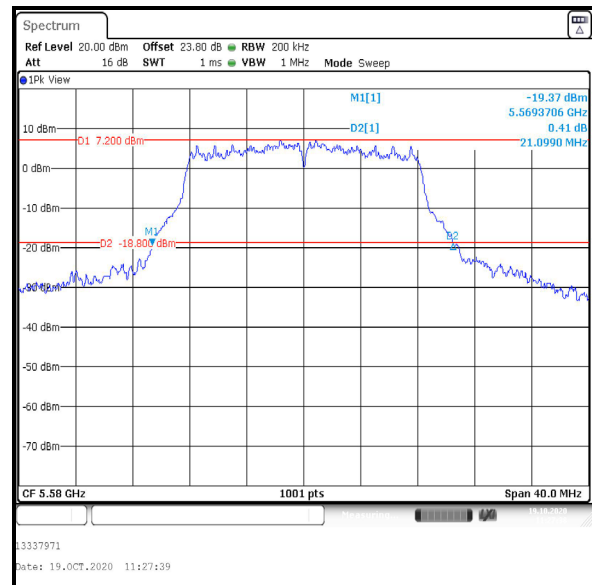

Middle Channel

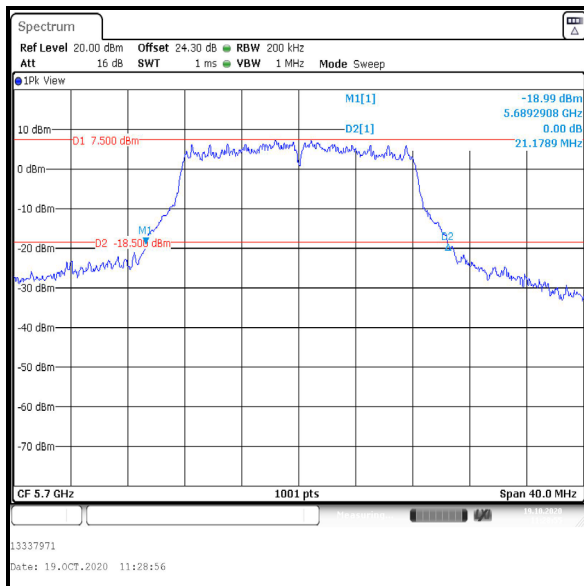

Top Channel

Transmitter 26 dB Emission Bandwidth (5.47-5.725 GHz band) (continued)

Results: 802.11n / 20 MHz / BPSK / MCS0

Channel	Frequency (MHz)	26 dB Emission Bandwidth (MHz)
Bottom	5500	21.379
Middle	5580	22.178
Top	5700	21.379

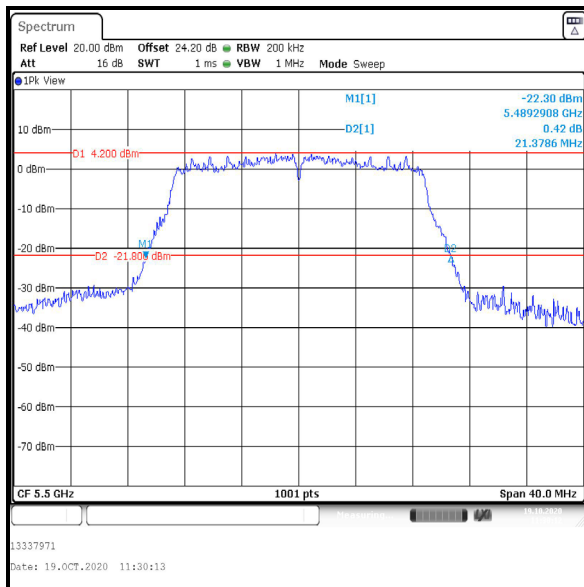

Bottom Channel

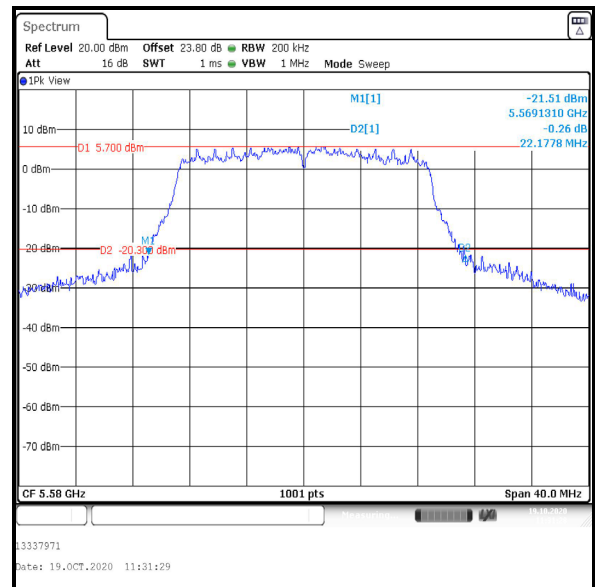

Middle Channel

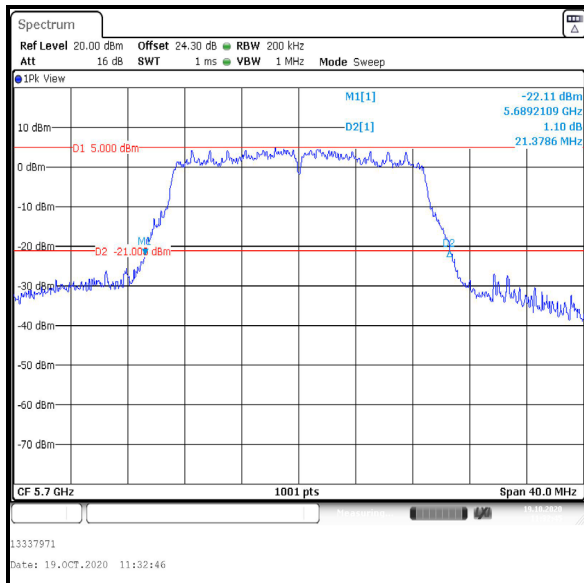

Top Channel

Transmitter 26 dB Emission Bandwidth (5.47-5.725 GHz band) (continued)

Results: 802.11n / 40 MHz / BPSK / MCS0

Channel	Frequency (MHz)	26 dB Emission Bandwidth (MHz)
Bottom	5510	40.520
Middle	5590	61.838
Top	5670	63.936

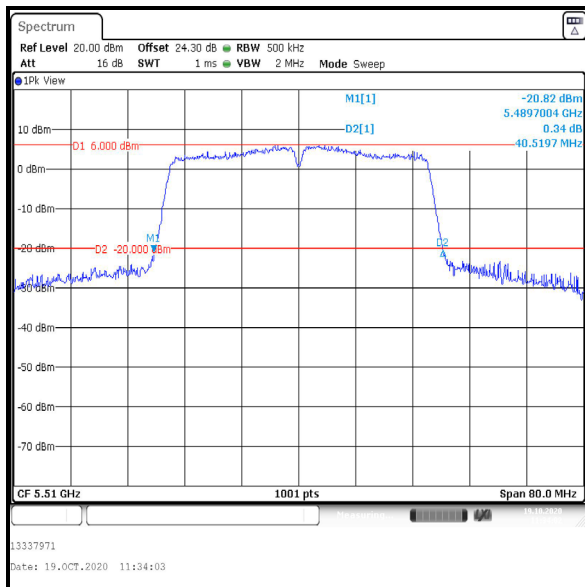

Bottom Channel

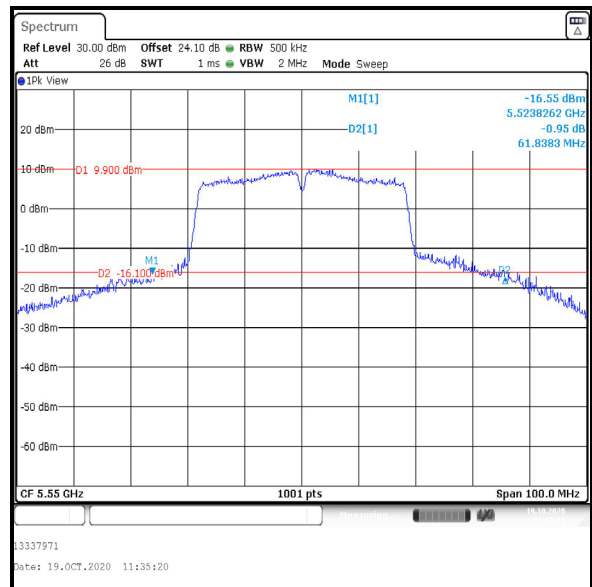

Middle Channel

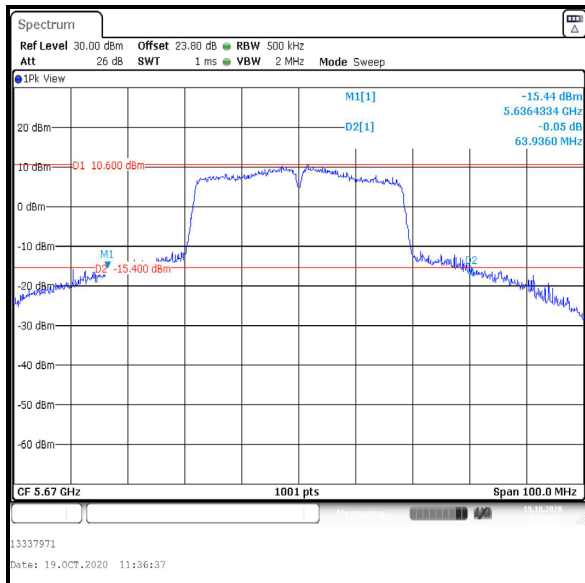

Top Channel

Transmitter 26 dB Emission Bandwidth (5.47-5.725 GHz band) (continued)

Results: 802.11ac / 80 MHz / BPSK / MCS0x1

Channel	Frequency (MHz)	26 dB Emission Bandwidth (MHz)
Bottom	5530	81.741
Top	5610	94.341

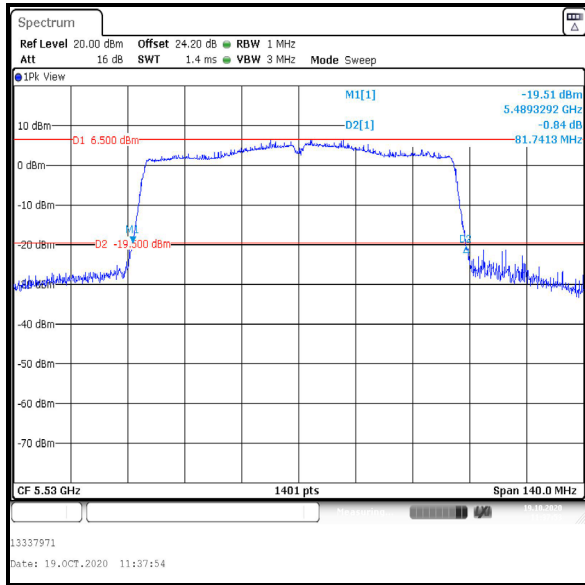

Bottom Channel

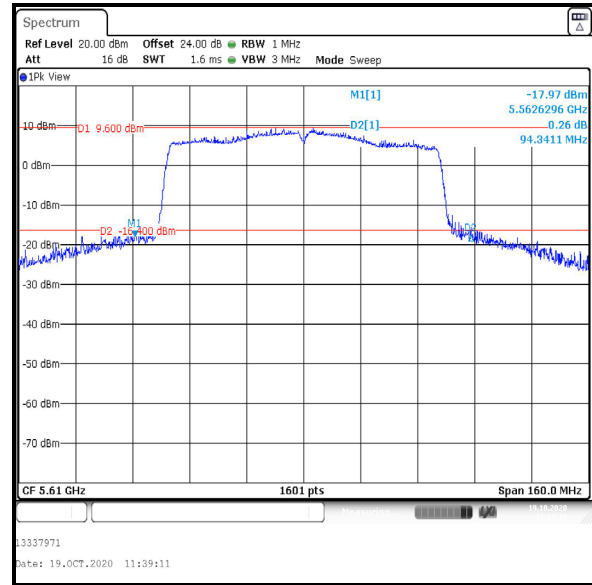

Top Channel