

43" 55" Intelligent Interactive Digital Signage

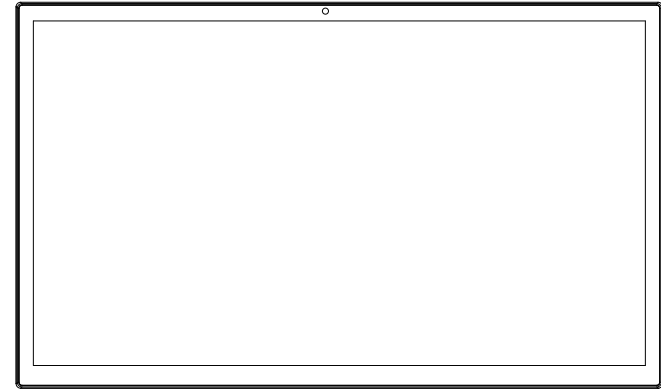

User Manual

Preface

Thank you for choosing Intelligent Interactive Digital Signage!
Before starting up, please carefully read this user manual to understand how to use the device and important precautions.

Warning

- * Use only the power adapter accessory provided by the original manufacturer.
- * The gaps and openings on the device are designed for ventilation and heat dissipation. Do not block or cover them.
- * Do not use or store the device in dusty, humid, or high-temperature environments.
- * Do not attempt to disassemble or repair the device if it malfunctions. Contact the original manufacturer or dealer for assistance.
- * Avoid stepping on the power cord or power adapter to prevent damage to the wires that may cause electrical hazards. If the power adapter's cord is damaged, do not continue to use it as it may be dangerous.
- * During thunderstorms or when the device will not be used for an extended period, unplug the power cord.
- * Do not place the device on the edge of a desk or in areas where children may easily access it to avoid damage or injury to the child.
- * During transport, do not apply excessive pressure on the display screen or scratch it with sharp or hard objects, as this may cause damage to the screen.
- * Use a dry, soft cloth or a slightly dampened soft cloth with a mild cleaning solution to clean the device. Do not use any type of solvent, such as alcohol or gasoline, as it may damage the surface treatment layer.
- * Make sure children understand the danger of climbing on the product, as dropping or tilting the product may cause serious injury.
- * Do not place the product in an unstable or tilted position.
- * Keep the cables connected to the product organized to avoid tripping, pulling or grabbing.

Warning:

Operation of this appliance in a residential environment may cause radio interference.

Packing List

After opening the package, please confirm the contents of the package below.

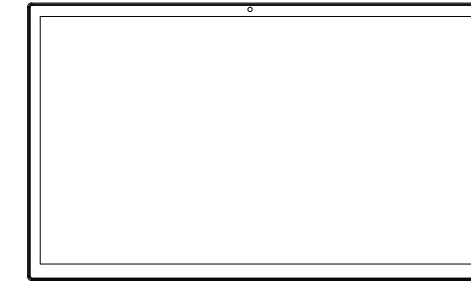

Intelligent Interactive Digital Signage

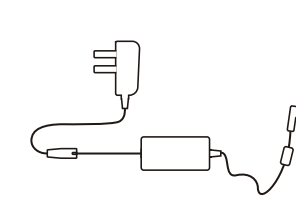

Power adapter x 1

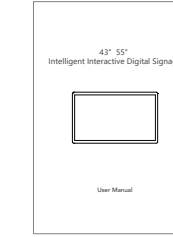

User manual x 1

Product Specifications

- RK3588 quad-core cortex A55+quad-core cortex A76
- Resolution: 1920x1080, HD LCD screen
- RAM 4GB / optional 8GB
- Memory 32GB / optional 64GB
- Android 12
- 10-point capacitive touchscreen
- Bluetooth 5.0
- Camera regular view 500W
- WiFi 802.11b/g/n/a/ac/ax (wifi 6)
- 10M/100M/1000M network port
- RJ45 Ethernet port
- SD card (supports up to 64GB)
- Type C
- USB host
- HDMI input
- 3.5mm stereo headphone output
- Operating temperature: 0-40 degrees

43" Exterior Components

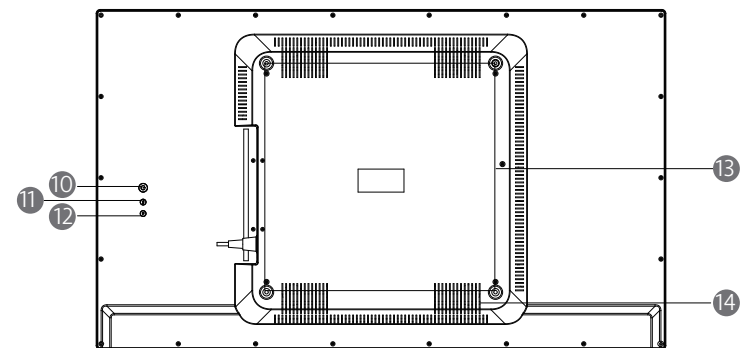
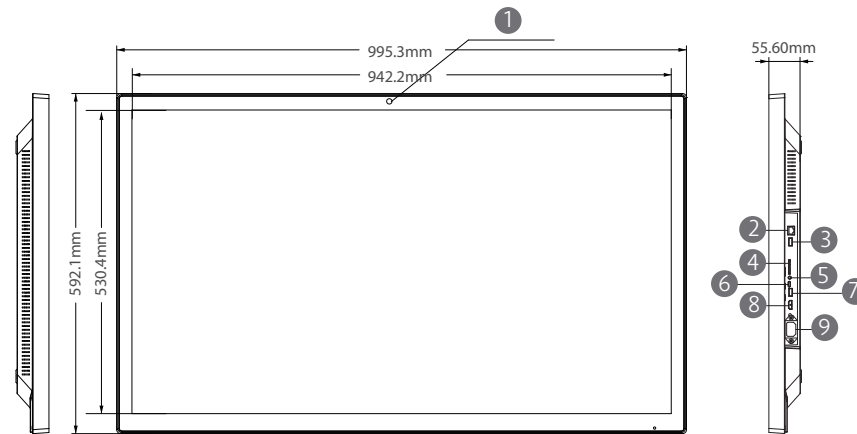

No	Function	No	Function
1	Camera	8	HDMI output
2	Ethernet port	9	AC in power supply port
3	USB host	10	Power ON/OFF
4	SD card slot	11	Vol+
5	3.5mm audio jack	12	Vol -
6	Type C	13	VESA 400*400mm
7	USB host	14	Speaker

55" Exterior Components

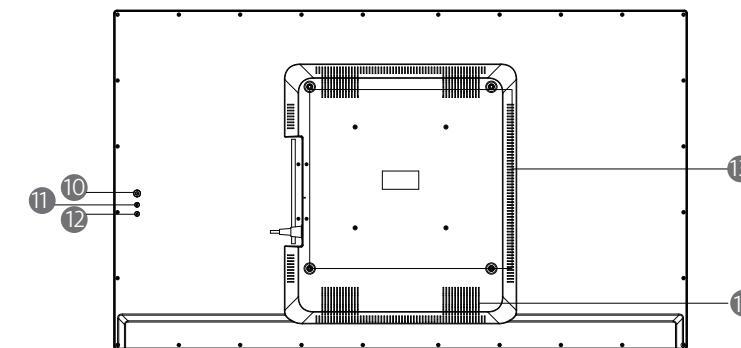
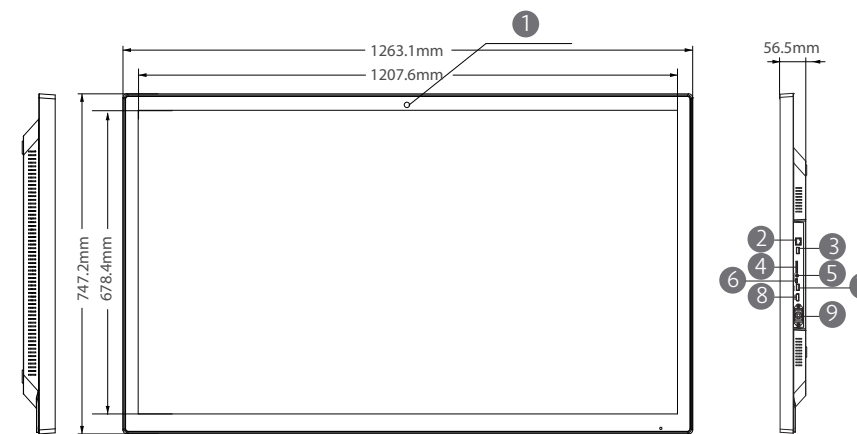

No	Function	No	Function
1	Camera	8	HDMI output
2	Ethernet port	9	AC in power supply port
3	USB host	10	Power ON/OFF
4	SD card slot	11	Vol+
5	3.5mm audio jack	12	Vol -
6	Type C	13	VESA 400*400mm
7	USB host	14	Speaker

FCC STATEMENT :

This device complies with Part 15 of the FCC Rules. Operation is subject to the following two conditions

1. This device may not cause harmful interference
2. This device must accept any interference received, including interference that may cause undesired operation.

Warning: Changes or modifications not expressly approved by the party responsible for compliance could void the user's authority to operate the equipment

NOTE: This equipment has been tested and found to comply with the limits for a Class B digital device, pursuant to Part 15 of the FCC Rules. These limits are designed to provide reasonable protection against harmful interference in a residential installation.

This equipment generates uses and can radiate radio frequency energy if not installed and used in accordance with the instructions, may cause harmful interference to radio communications. However, there is no guarantee that interference will not occur in a particular installation. If this equipment does cause harmful interference to radio or television reception which can be determined by turning the equipment off and on, the user is encouraged to try to correct the interference by one or more of the following measures:

Reorient or relocate the receiving antenna

Increase the separation between the equipment and receiver.

Connect the equipment into an outlet on a circuit different from that to which the receiver is connected

Consult the dealer or an experienced radio/TV technician for help.

The device for operation in the band 5150-5250 MHz is only for indoor use to reduce the potential for harmful interference to co-channel mobile satellite systems.

FCC Radiation Exposure Statement:

This equipment complies with FCC radiation exposure limits set forth for uncontrolled environment. This equipment should be installed and operated with minimum distance 20cm between the radiator & your body.

This device complies with parts of the FCC rules. Operation is subject to the following two conditions:

1. This device will not cause harmful interference;

2. This device must accept any interference received, including interference that may cause undesired operation

CE This product complies with the essential requirements of European safety regulations and has passed the product safety conformity assessment procedure. It also has a manufacturer's declaration of conformity to ensure that every product delivered to the customer is safe.

This symbol on the product or in the instructions means that your electrical and electronic equipment should be disposed of at the end of its life separately from your household waste. There are separate collection systems for recycling in your country. For more information, please contact the local authority or your retailer where you purchased the product.

