

FCC AND ISED CERTIFICATION TEST REPORT

FOR

Applicant	:	ION Audio, LLC
Address	:	200 Scenic View Drive, Cumberland, RI 02864 U.S.A.
Equipment under Test	:	SOLAR RECHARGEABLE OUTDOOR SPEAKER WITH MULTI-SYNC
Model No.	:	SOLAR SOUNDS
Project Code	:	iSP75C
Trade Mark	:	
FCC ID	:	2AB3E-ISP75C
IC	:	10541A-ISP75C
Manufacturer	:	ION Audio, LLC
Address	:	200 Scenic View Drive, Cumberland, RI 02864 U.S.A.

Issued By: Dongguan Dongdian Testing Service Co., Ltd.

Add.: No. 17, Zongbu Road 2, Songshan Lake Sci&Tech, Industry Park, Dongguan
City, Guangdong Province, China, 523808

Tel.: +86-0769-38826678, **E-mail:** ddt@dgddt.com, <http://www.dgddt.com>

REPORT

Table of Contents

	Test report declares.....	4
1.	Summary of Test Results.....	6
2.	General Test Information	7
2.1.	Description of EUT.....	7
2.2.	Accessories of EUT	8
2.3.	Assistant equipment used for test	8
2.4.	Block diagram of EUT configuration for test.....	8
2.5.	Deviations of test standard	9
2.6.	Test environment conditions	9
2.7.	Test laboratory	9
2.8.	Measurement uncertainty	10
3.	Equipment Used During Test.....	11
4.	20dB Bandwidth and 99% Bandwidth	13
4.1.	Block diagram of test setup	13
4.2.	Limits.....	13
4.3.	Test procedure	13
4.4.	Test result	13
5.	Maximum Peak Output Power.....	21
5.1.	Block diagram of test setup	21
5.2.	Limits.....	21
5.3.	Test procedure	21
5.4.	Test result	21
5.5.	Test graphs	22
6.	Carrier Frequency Separation	25
6.1.	Block diagram of test setup	25
6.2.	Limits.....	25
6.3.	Test procedure	25
6.4.	Test result	25
6.5.	Test graphs	26
7.	Dwell Time	27
7.1.	Block diagram of test setup	27
7.2.	Limits.....	27
7.3.	Test procedure	27
7.4.	Test result	27
7.5.	Test graphs	28
8.	Number of Hopping Channel.....	34
8.1.	Block diagram of test setup	34

8.2.	Limits.....	34
8.3.	Test procedure.....	34
8.4.	Test result	34
8.5.	Test graphs	34
9.	Band Edge Compliance (Conducted Method).....	36
9.1.	Block diagram of test setup	36
9.2.	Limit	36
9.3.	Test result	36
9.4.	Test graphs	36
10.	RF Conducted Spurious Emissions.....	41
10.1.	Block diagram of test setup	41
10.2.	Limits.....	41
10.3.	Test procedure.....	41
10.4.	Test result	42
10.5.	Test graphs	42
11.	Radiated Emission.....	52
11.1.	Block diagram of test setup	52
11.2.	Limit	53
11.3.	Test procedure.....	54
11.4.	Test result	57
12.	Band Edge Compliance (Radiated Method).....	61
12.1.	Block diagram of test setup	61
12.2.	Limit	61
12.3.	Test procedure.....	61
12.4.	Test result	61
13.	Power Line Conducted Emission	74
13.1.	Block diagram of test setup	74
13.2.	Power line conducted emission limits.....	74
13.3.	Test procedure.....	74
13.4.	Test result	75
14.	Antenna Requirements.....	78
14.1.	Limit	78
14.2.	Result.....	78

Test Report Declare

Applicant	:	ION Audio, LLC
Address	:	200 Scenic View Drive, Cumberland, RI 02864 U.S.A.
Equipment under Test	:	SOLAR RECHARGEABLE OUTDOOR SPEAKER WITH MULTI-SYNC
Model No.	:	SOLAR SOUNDS
Trade Mark	:	
Manufacturer	:	ION Audio, LLC
Address	:	200 Scenic View Drive, Cumberland, RI 02864 U.S.A.

Test Standard Used:

FCC Rules and Regulations Part 15 Subpart C, RSS-247 Issue 2 February 2017.

Test Procedure Used:

ANSI C63.10:2013, RSS-Gen Issue 5, Apr. 2018, Amendment 2 (February 2021).

We Declare:

The equipment described above is tested by Dongguan Dongdian Testing Service Co., Ltd. and in the configuration tested the equipment complied with the standards specified above. The test results are contained in this test report and Dongguan Dongdian Testing Service Co., Ltd. is assumed of full responsibility for the accuracy and completeness of these tests.

After test and evaluation, our opinion is that the equipment provided for test compliance with the requirement of the above FCC&ISED standards.

Report No.:	DDT-R21091611-2E01		
Date of Receipt:	Dec. 17, 2021	Date of Test:	Dec. 17, 2021 ~ Jan. 13, 2022

Prepared By:

Sam Li/Engineer

Approved By:

Damon Hu/EMC Manager

Note: This report applies to above tested sample only. This report shall not be reproduced in parts without written approval of Dongguan Dongdian Testing Service Co., Ltd.

Revision History

Rev.	Revisions	Issue Date	Revised By
---	Initial issue	Jan. 14, 2022	

1. Summary of Test Results

Description of Test Item	Standard	Verdict
Maximum Peak Output Power	FCC Part 15: 15.247(b)(1) ANSI C63.10:2013 RSS-247 Issue 2	Pass
20dB Bandwidth and 99% Bandwidth	FCC Part 15: 15.215 ANSI C63.10:2013 RSS-247 Issue 2	Pass
Carrier Frequency Separation	FCC Part 15: 15.247(a)(1) ANSI C63.10:2013 RSS-247 Issue 2	Pass
Number of Hopping Channel	FCC Part 15: 15.247(a)(1)(iii) ANSI C63.10:2013 RSS-247 Issue 2	Pass
Dwell Time	FCC Part 15: 15.247(a)(1)(iii) ANSI C63.10:2013 RSS-247 Issue 2	Pass
Radiated Emission	FCC Part 15: 15.209 FCC Part 15: 15.247(d) ANSI C63.10:2013 RSS-247 Issue 2 RSS-Gen Issue 5	Pass
Band Edge Compliance	FCC Part 15: 15.247(d) ANSI C63.10:2013 RSS-247 Issue 2 RSS-Gen Issue 5	Pass
Power Line Conducted Emissions	FCC Part 15: 15.207 ANSI C63.10:2013 RSS-Gen Issue 5	Pass
Antenna Requirement	FCC Part 15: 15.203 RSS-Gen Issue 5	Pass

2. General Test Information

2.1. Description of EUT

EUT* Name	: SOLAR RECHARGEABLE OUTDOOR SPEAKER WITH MULTI-SYNC
Model Number	: SOLAR SOUNDS
EUT Function Description	: Please reference user manual of this device
Power Supply	: DC 12V from external AC Adapter DC 7.4V Polymer Li-ion built-in battery
Hardware Version	: Main board: 1.5 Key board: 1.4
Software Version	: 2.6
Radio Specification	: Bluetooth V5.0
Operation Frequency	: 2402MHz-2480MHz
Modulation	: GFSK, $\pi/4$ -DQPSK, 8DPSK
Data Rate	: 1 Mbps, 2 Mbps, 3 Mbps
Antenna Gain	: Maximum PK gain: 4.24dBi
Sample Type	: Series Production
Serial Number	: N/A

Note: EUT is the ab. of equipment under test.

Channel information					
Channel	Frequency (MHz)	Channel	Frequency (MHz)	Channel	Frequency (MHz)
0	2402	27	2429	54	2456
1	2403	28	2430	55	2457
2	2404	29	2431	56	2458
3	2405	30	2432	57	2459
4	2406	31	2433	58	2460
5	2407	32	2434	59	2461
6	2408	33	2435	60	2462
7	2409	34	2436	61	2463
8	2410	35	2437	62	2464
9	2411	36	2438	63	2465
10	2412	37	2439	64	2466
11	2413	38	2440	65	2467
12	2414	39	2441	66	2468
13	2415	40	2442	67	2469
14	2416	41	2443	68	2470
15	2417	42	2444	69	2471
16	2418	43	2445	70	2472
17	2419	44	2446	71	2473
18	2420	45	2447	72	2474
19	2421	46	2448	73	2475
20	2422	47	2449	74	2476
21	2423	48	2450	75	2477

22	2424	49	2451	76	2478
23	2425	50	2452	77	2479
24	2426	51	2453	78	2480
25	2427	52	2454		
26	2428	53	2455		

2.2. Accessories of EUT

Assistant equipment	Manufacturer	Model number	Serial No.	Other
AC Adapter	DONG GUAN HP-POWER TECHNOLOGY., UNITED	NP36A-1203000-AU	N/A	Input: 100-240~, 50/60Hz, 1.0A; Output: DC 12V/3A

2.3. Assistant equipment used for test

Assistant equipment	Manufacturer	Model number	EMC Compliance	SN
N/A	N/A	N/A	N/A	N/A

2.4. Block diagram of EUT configuration for test

TX Mode for measurement of power line conducted emissions



TX Mode for RF measurement of radiated and conducted



Test software: BT FCC Tool V2.23

The test software was used to control EUT work in Continuous Tx mode, and select test channel, wireless mode as below table.

Tested mode, channel, information			
Mode	Channel	Frequency (MHz)	Setting Tx Power
GFSK hopping on Tx mode	CH0 to CH78	2402 to 2480	0
$\pi/4$ -DQPSK hopping on Tx mode	CH0 to CH78	2402 to 2480	0
8DPSK hopping on Tx mode	CH0 to CH78	2402 to 2480	0
GFSK hopping off Tx mode	CH0	2402	0
	CH39	2441	0
	CH78	2480	0
$\pi/4$ -DQPSK hopping off Tx mode	CH0	2402	0

	CH39	2441	0
	CH78	2480	0
8DPSK hopping off Tx mode	CH0	2402	0
	CH39	2441	0
	CH78	2480	0

2.5. Deviations of test standard

No deviation.

2.6. Test environment conditions

During the measurement the environmental conditions were within the listed ranges:

Temperature range:	21-25 °C
Humidity range:	40-75%
Pressure range:	86-106 kPa

2.7. Test laboratory

Dongguan Dongdian Testing Service Co., Ltd.

Add.: No. 17, Zongbu Road 2, Songshan Lake Sci&Tech, Industry Park, Dongguan City, Guangdong Province, China, 523808.

Tel.: +86-0769-38826678, <http://www.dgddt.com>, Email: ddt@dgddt.com.

CNAS Accreditation No. L6451; A2LA Accreditation Number: 3870.01

FCC Designation Number: CN1182, Test Firm Registration Number: 540522

Innovation, Science and Economic Development Canada Site Registration Number: 10288A

Conformity Assessment Body identifier: CN0048

VCCI facility registration number: C-20087, T-20088, R-20123, G-20118

2.8. Measurement uncertainty

Test Item	Uncertainty
Bandwidth	1.1%
Peak Output Power (Conducted) (Spectrum analyzer)	0.86 dB(10 MHz ≤ f < 3.6 GHz);
	1.38 dB(3.6 GHz ≤ f < 8 GHz)
Peak Output Power (Conducted) (Power Sensor)	0.74 dB
Power Spectral Density	0.74 dB(10 MHz ≤ f < 3.6 GHz);
	1.38 dB(3.6 GHz ≤ f < 8 GHz)
Frequencies Stability	6.7 x 10 ⁻⁸ (Antenna couple method)
	5.5 x 10 ⁻⁸ (Conducted method)
Conducted spurious emissions	0.86 dB(10 MHz ≤ f < 3.6 GHz);
	1.40 dB(3.6 GHz ≤ f < 8 GHz)
	1.66 dB(8 GHz ≤ f < 22 GHz)
Uncertainty for radio frequency (RBW<20 kHz)	3x10 ⁻⁸
Temperature	0.4 °C
Humidity	2 %
Uncertainty for Radiation Emission Test (9 kHz – 30 MHz)	3.44 dB
Uncertainty for Radiation Emission test (30 MHz-1 GHz)	4.70 dB (Antenna Polarize: V)
	4.84 dB (Antenna Polarize: H)
Uncertainty for Radiation Emission test (1 GHz-40 GHz)	4.10 dB(1-6 GHz)
	4.40 dB (6 GHz-18 GHz)
	3.54 dB (18 GHz-26 GHz)
	4.30 dB (26 GHz-40 GHz)
Uncertainty for Power line conduction emission test	3.32 dB (150 kHz-30 MHz)
Note: This uncertainty represents an expanded uncertainty expressed at approximately the 95% confidence level using a coverage factor of k=2.	

3. Equipment Used During Test

Equipment	Manufacturer	Model No.	Serial No.	Last Cal.	Cal. Interval
☐RF Connected Test (Tonscend RF Measurement System 1#)					
Spectrum analyzer	R&S	FSU26	200071	Sep. 02, 2021	1 Year
Wideband Radio Communication tester	R&S	CMW500	120259	Sep. 02, 2021	1 Year
Vector Signal Generator	Agilent	E8267D	US49060192	Sep. 18, 2021	1 Year
Vector Signal Generator	Agilent	N5182A	MY48180737	Jun. 01, 2021	1 Year
RF Control Unit	Tonsend	JS0806-2	158060010	Jun. 01, 2021	1 Year
Temp&Humi Programmable	ZHIXIANG	ZXGDJS-150L	ZX170110-A	Jun. 01, 2021	1 Year
Test Software	JS Tonscend	JS1120-3	Ver.2.6.77.0518	N/A	N/A
☐RF Connected Test (Tonscend RF Measurement System 3#)					
Signal analyzer	R&S	FSQ26	101272	Jun. 01, 2021	1 Year
Wideband Radio Communication tester	R&S	CMW500	117491	Jun. 01, 2021	1 Year
Vector Signal Generator	Agilent	N5182A	MY19060405	Jun. 01, 2021	1 Year
Vector Signal Generator	Agilent	N5182A	MY48180912	Jun. 01, 2021	1 Year
RF Control Unit	Tonsend	JS0806-2	DDT-ZC01449	Jun. 01, 2021	1 Year
Temp&Humi Programmable	ZHIXIANG	ZXGDJS-150L	ZX170110-A	Jun. 01, 2021	1 Year
Test Software	JS Tonscend	JS1120-3	Ver.2.6.77.0518	N/A	N/A
☑RF Connected Test (Tonscend RF Measurement System 4#)					
MXA SignalAnalyzer	Agilent	N9020A	MY49100362	Sep. 02, 2021	1 Year
Wideband Radio Communication tester	R&S	CMW500	120259	Jun. 01, 2021	1 Year
MXG Vector Signal Generator	Agilent	N5182B	MY59100192	Jun. 01, 2021	1 Year
Vector Signal Generator	Agilent	E8267D	US49060192	Sep. 18, 2021	1 Year
RF Control Unit	Tonsend	JS0806-2	2118060485	Oct. 18, 2021	1 Year
Temp&Humi Programmable	ZHIXIANG	ZXGDJS-150L	ZX170110-A	Jun. 01, 2021	1 Year
Test Software	JS Tonscend	JS1120-3	Ver.2.6.88.0346	N/A	N/A
☑Radiation 3#chamber					
EMI Test Receiver	R&S	ESU	100472	Jun. 01, 2021	1 Year
Spectrum analyzer	Agilent	E4447A	MY50180031	Jun. 01, 2021	1 Year
Active Loop antenna	Schwarzbeck	FMZB-1519	1519-038	Sep. 19, 2021	1 Year
Trilog Broadband Antenna	Schwarzbeck	VULB 9163	01429	Aug. 07, 2021	1 Year
Double Ridged Horn Antenna	Schwarzbeck	BBHA9120	02108	Jul. 17, 2021	1 Year
Broad Band Horn Antenna	Schwarzbeck	BBHA 9170	790	May 08, 2021	1 Year

Pre-amplifier	COM-POWER	PAM-118A	18040084	Sep. 02, 2021	1 Year
Pre-amplifier	COM-POWER	PAM-840A	461369	Mar. 15, 2021	1 Year
Test software	Audix	E3	V 6.1.1.1	N/A	N/A
<input type="checkbox"/> Power Line Conducted Emissions Test 1#					
Test Receiver	R&S	ESCI	100551	Sep. 02, 2021	1 Year
LISN 1	R&S	ENV216	101109	Sep. 02, 2021	1 Year
LISN 2	R&S	ESH2-Z5	100309	Sep. 02, 2021	1 Year
Pulse Limiter	R&S	ESH3-Z2	101242	Sep. 02, 2021	1 Year
CE Cable 1	HUBSER	N/A	W10.01	Sep. 02, 2021	1 Year
LISN 3	SCHWARZBECK	NSLK 8163	00017	Sep. 02, 2021	1 Year
Test software	Audix	E3	V 6.11111b	N/A	N/A
<input type="checkbox"/> Power Line Conducted Emissions Test 2#					
Test Receiver	R&S	ESCI	101028	Sep. 02, 2021	1 Year
LISN 1	R&S	ENV216	101170	Sep. 02, 2021	1 Year
Pulse Limiter	R&S	KH43101	431011801568-12#	Jun. 01, 2021	1 Year
CE Cable 2	HUBSER	RG214-5	N/A	Jun. 01, 2021	1 Year
Test software	Audix	E3	V 6.11111b	N/A	N/A
<input checked="" type="checkbox"/> Power Line Conducted Emissions Test 3#					
Test Receiver	R&S	ESCI	101032	Mar. 03, 2021	1 Year
LISN 1	R&S	ENV216	101725	Sep. 02, 2021	1 Year
LISN 2	R&S	ENV216	101726	Sep. 02, 2021	1 Year
LISN 3	SCHWARZBECK	NSLK 8163	00017	Sep. 02, 2021	1 Year
Pulse Limiter	SCHWARZBECK	VTSD 95	102766	Sep. 02, 2021	1 Year
CE Cable 3	HUBSER	Z806-NJ-NJ-2M	21070280	Sep. 02, 2021	1 Year
CE Cable 3	HUBSER	Z806-NJ-NJ-6M	21070275	Sep. 02, 2021	1 Year
Test software	Audix	E3	V 6.11111b	N/A	N/A

4. 20dB Bandwidth and 99% Bandwidth

4.1. Block diagram of test setup

Same as section 4.1

4.2. Limits

Intentional radiators operating under the alternative provisions to the general emission limits, as contained in § 15.217 through 15.257 and in Subpart E of this part, must be designed to ensure that the 20dB bandwidth of the emission, or whatever bandwidth may otherwise be specified in the specific rule section under which the equipment operates, is contained within the frequency band designated in the rule section under which the equipment is operated.

4.3. Test procedure

- (1) Connect EUT's antenna output to spectrum analyzer by RF cable.
- (2) The bandwidth of the fundamental frequency was measured by spectrum analyzer with 30 kHz RBW and 100 kHz VBW. The 20dB bandwidth is defined as the total spectrum the power of which is higher than peak power minus 20dB.

4.4. Test result

20dB Emission Bandwidth Test Result

TestMode	Antenna	Channel	20db EBW[MHz]	FL[MHz]	FH[MHz]	Limit[MHz]	Verdict
DH5	Ant1	2402	0.915	2401.574	2402.489	---	---
		2441	0.867	2440.562	2441.429	---	---
		2480	0.942	2479.559	2480.501	---	---
2DH5	Ant1	2402	1.185	2401.418	2402.603	---	---
		2441	1.185	2440.421	2441.606	---	---
		2480	1.188	2479.418	2480.606	---	---
3DH5	Ant1	2402	1.197	2401.427	2402.624	---	---
		2441	1.188	2440.433	2441.621	---	---
		2480	1.191	2479.433	2480.624	---	---

Test Graphs

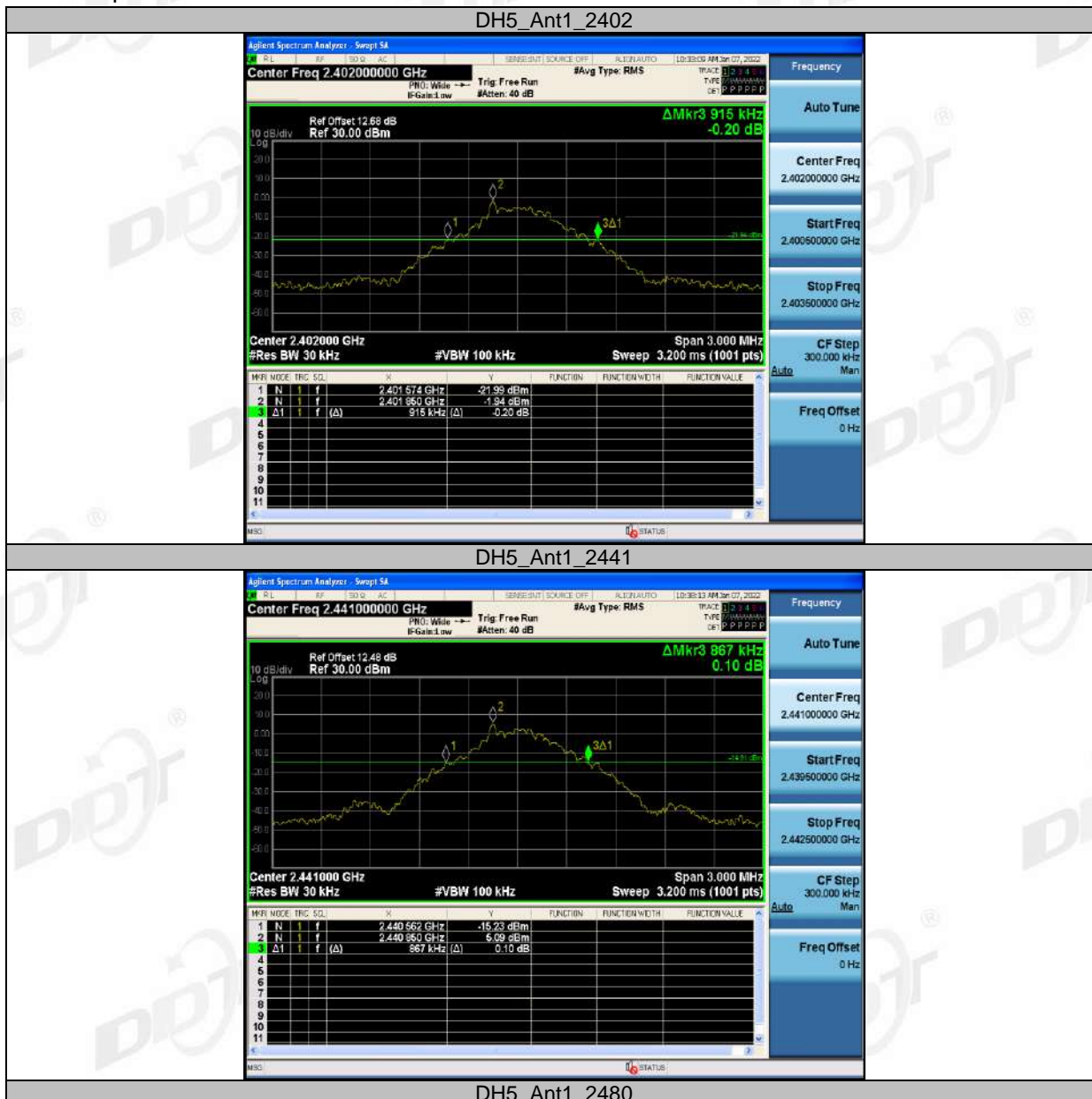



2DH5_Ant1_2402



2DH5_Ant1_2441



2DH5_Ant1_2480



3DH5_Ant1_2402



3DH5_Ant1_2441



3DH5_Ant1_2480



Occupied Channel Bandwidth Test Result

TestMode	Antenna	Channel	OCB [MHz]	FL[MHz]	FH[MHz]	Limit[MHz]	Verdict
DH5	Ant1	2402	0.85647	2401.588	2402.444	---	---
		2441	0.84829	2440.591	2441.439	---	---
		2480	0.85512	2479.588	2480.443	---	---
2DH5	Ant1	2402	1.1184	2401.458	2402.576	---	---
		2441	1.1435	2440.442	2441.586	---	---
		2480	1.1353	2479.447	2480.582	---	---
3DH5	Ant1	2402	1.1216	2401.458	2402.579	---	---
		2441	1.1359	2440.453	2441.589	---	---
		2480	1.1224	2479.455	2480.577	---	---

Test Graphs

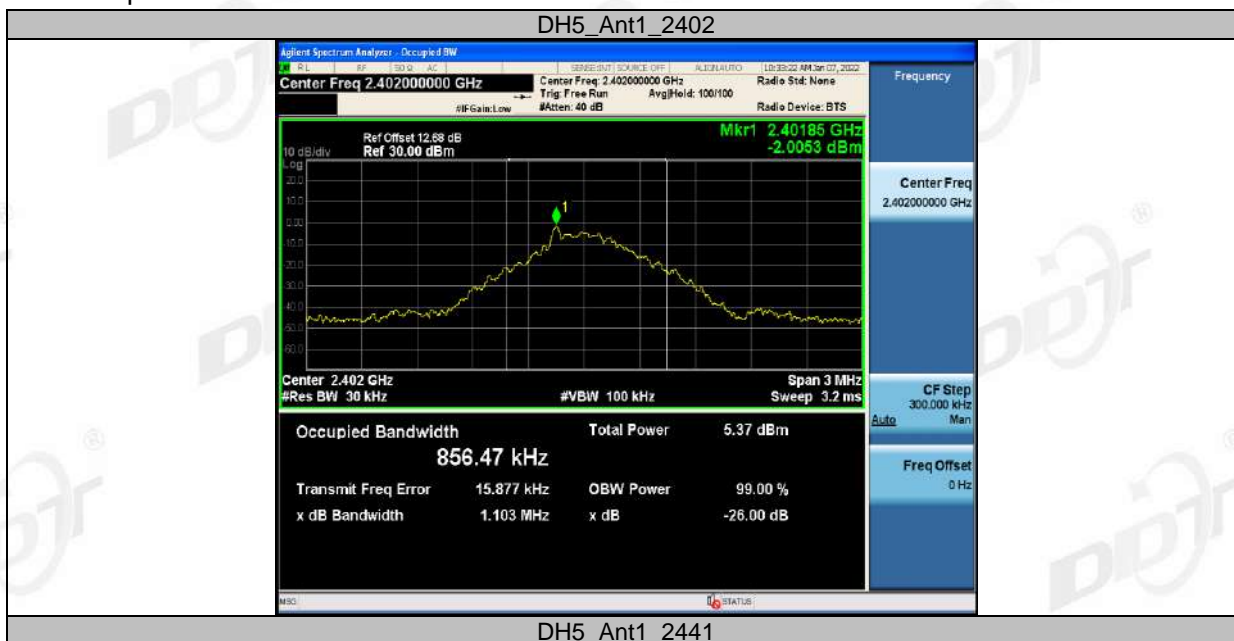



DH5_Ant1_2480



2DH5_Ant1_2402



2DH5_Ant1_2441



2DH5_Ant1_2480



3DH5_Ant1_2402



3DH5_Ant1_2441



3DH5_Ant1_2480



5. Maximum Peak Output Power

5.1. Block diagram of test setup

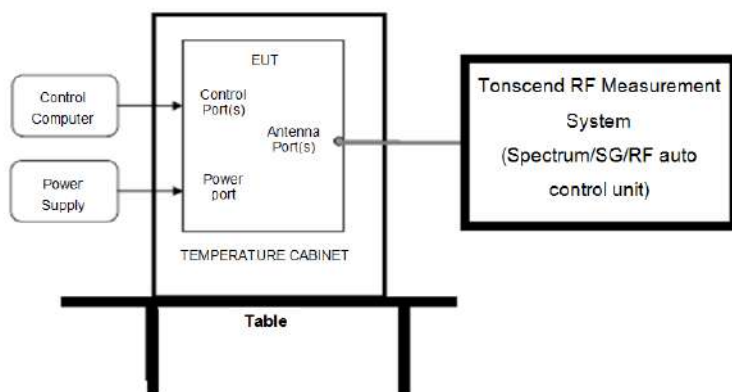

5.2. Limits

For frequency hopping systems operating in the 2400-2483.5 MHz band employing at least 75 non-overlapping hopping channels, and all frequency hopping systems in the 5725-5850 MHz band: 1 watt. For all other frequency hopping systems in the 2400-2483.5 MHz band: 0.125 watts, the e.i.r.p shall not exceed 4W.

5.3. Test procedure

- (1) Connect EUT's antenna output to spectrum analyzer by RF cable.
- (2) Measure the maximum output power of EUT by spectrum analyzer with PK detector and RBW=3MHz (above 20dB bandwidth of measured signal), VBW=8MHz

Note: The attenuator loss was inputted into spectrum analyzer as amplitude offset.

5.4. Test result

TestMode	Antenna	Channel	Result[dBm]	Limit[dBm]	Verdict
DH5	Ant1	2402	-0.84	≤20.97	PASS
		2441	-1.35	≤20.97	PASS
		2480	-2.07	≤20.97	PASS
2DH5	Ant1	2402	-0.99	≤20.97	PASS
		2441	-1.44	≤20.97	PASS
		2480	-2.39	≤20.97	PASS
3DH5	Ant1	2402	-1.08	≤20.97	PASS
		2441	-1.48	≤20.97	PASS
		2480	-2.21	≤20.97	PASS

5.5. Test graphs

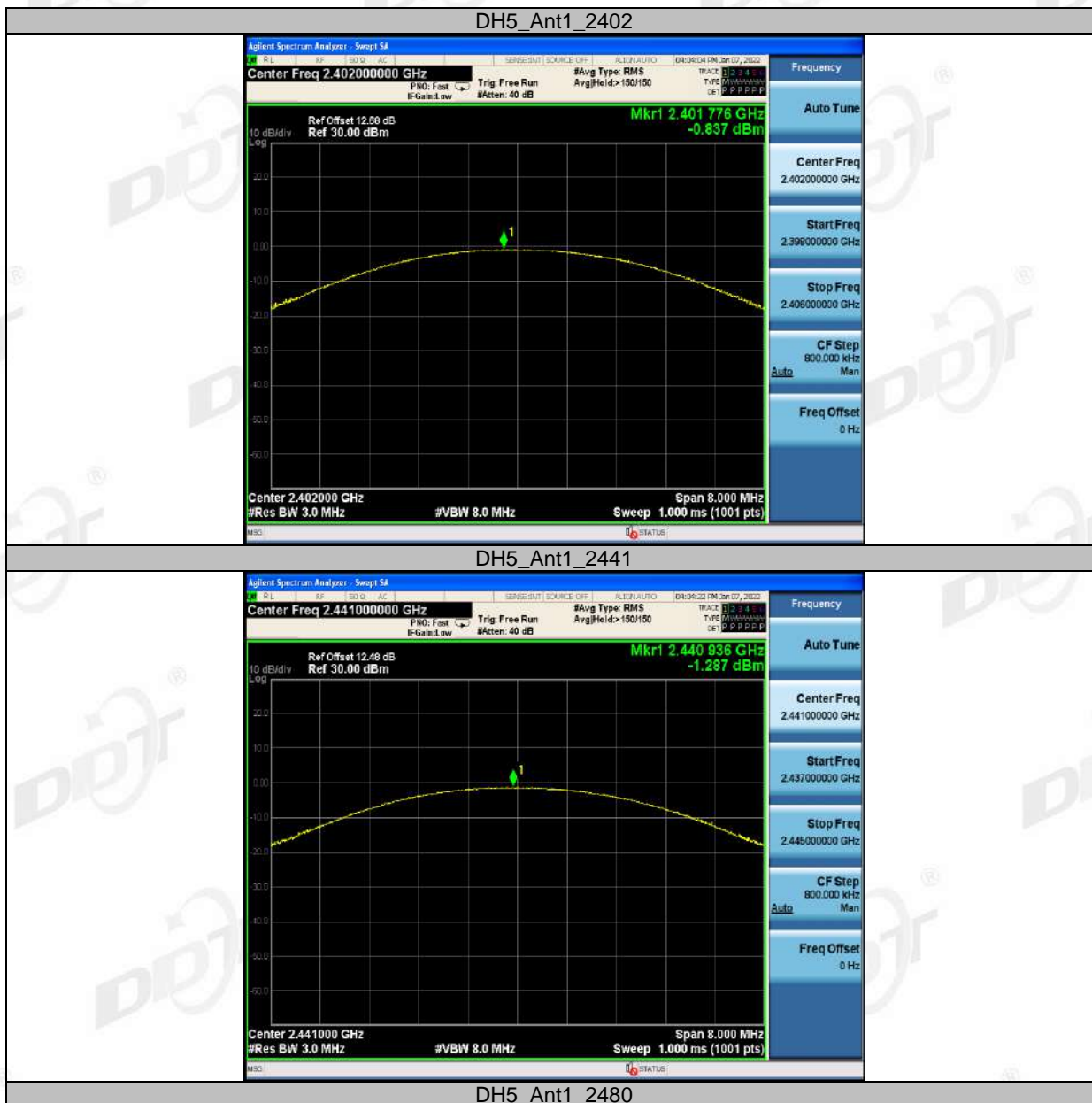



2DH5_Ant1_2402



2DH5_Ant1_2441



2DH5_Ant1_2480



3DH5_Ant1_2402



3DH5_Ant1_2441



3DH5_Ant1_2480



6. Carrier Frequency Separation

6.1. Block diagram of test setup

Same as section 4.1

6.2. Limits

Frequency hopping systems shall have hopping channel carrier frequencies separated by a minimum of 25 kHz or the 20dB bandwidth of the hopping channel, whichever is greater. Alternatively, frequency hopping systems operating in the 2400-2483.5 MHz band may have hopping channel carrier frequencies that are separated by 25 kHz or two-thirds of the 20dB bandwidth of the hopping channel, whichever is greater, provided the systems operate with an output power no greater than 125 mW.

6.3. Test procedure

- (1) Connect EUT's antenna output to spectrum analyzer by RF cable.
- (2) The carrier frequency was measured by spectrum analyzer with 300 kHz RBW and 300 kHz VBW.

6.4. Test result

TestMode	Antenna	Channel	Result[MHz]	Limit[MHz]	Verdict
DH5	Ant1	Hop	1.002	≥0.942	PASS
2DH5	Ant1	Hop	1.058	≥0.792	PASS
3DH5	Ant1	Hop	1.054	≥0.798	PASS

6.5. Test graphs

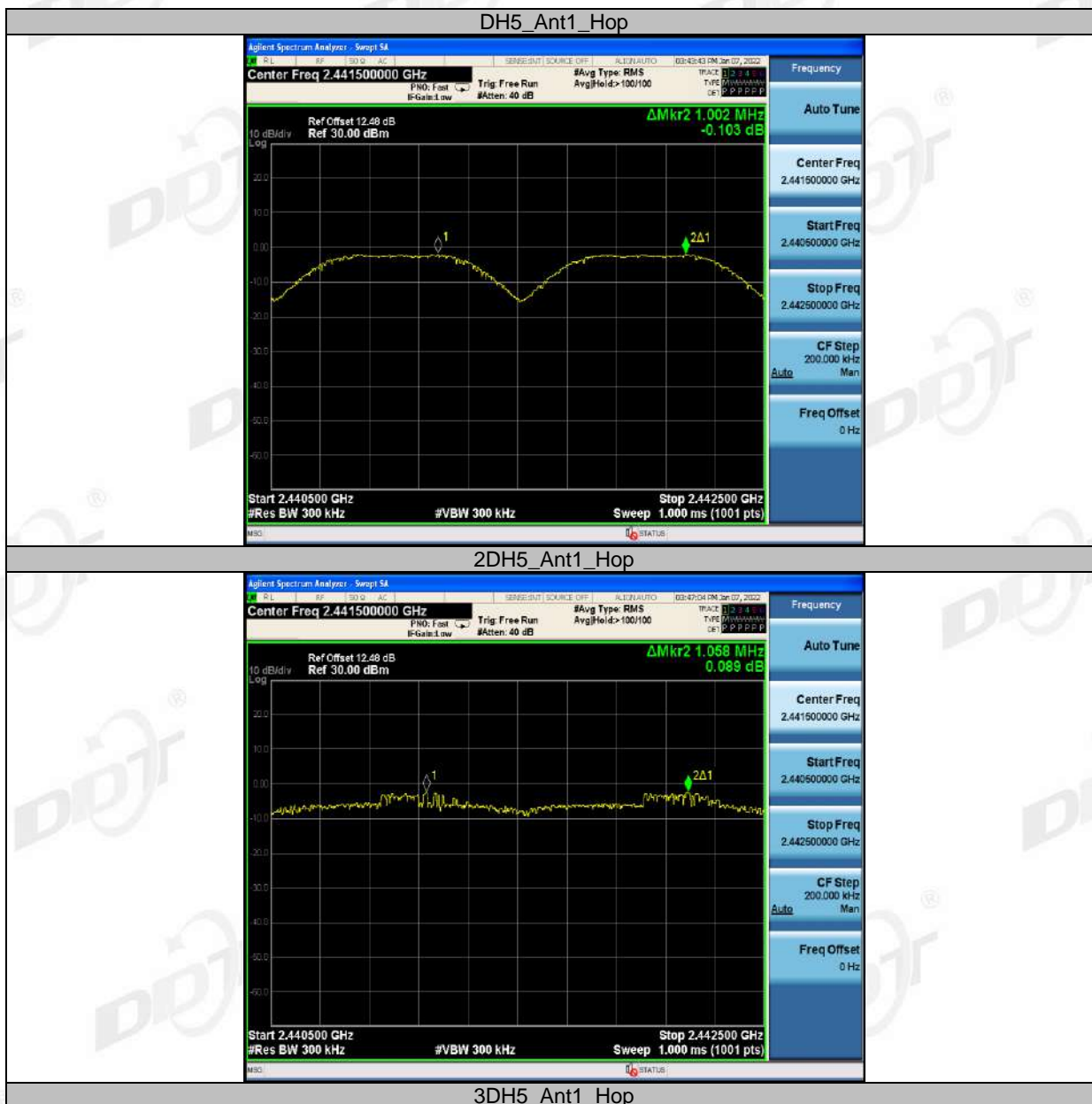



7. Dwell Time

7.1. Block diagram of test setup

Same as section 4.1

7.2. Limits

The average time of occupancy on any channel shall not be greater than 0.4 seconds within a period of 0.4 seconds multiplied by the number of hopping channels employed.

7.3. Test procedure

- (1) Connect EUT's antenna output to spectrum analyzer by RF cable.
- (2) The test period: $T = 0.4 \text{ Second/Channel} \times 79 \text{ Channel} = 31.6 \text{ s}$
- (3) Measure the hopping number and on time of each pulse with spectrum analyzer in zero span set, and calculate dwell time with formula $\text{Dwell time} = \text{total hops} \times \text{pulse's on time}$.

7.4. Test result

TestMode	Antenna	Channel	BurstWidth [ms]	TotalHops [Num]	Result[s]	Limit[s]	Verdict
DH1	Ant1	Hop	0.37	319	0.118	≤0.4	PASS
DH3	Ant1	Hop	1.62	159	0.257	≤0.4	PASS
DH5	Ant1	Hop	2.87	107	0.307	≤0.4	PASS
2DH1	Ant1	Hop	0.38	319	0.12	≤0.4	PASS
2DH3	Ant1	Hop	1.63	159	0.259	≤0.4	PASS
2DH5	Ant1	Hop	2.88	107	0.308	≤0.4	PASS
3DH1	Ant1	Hop	0.38	319	0.12	≤0.4	PASS
3DH3	Ant1	Hop	1.63	159	0.259	≤0.4	PASS
3DH5	Ant1	Hop	2.88	107	0.308	≤0.4	PASS

7.5. Test graphs

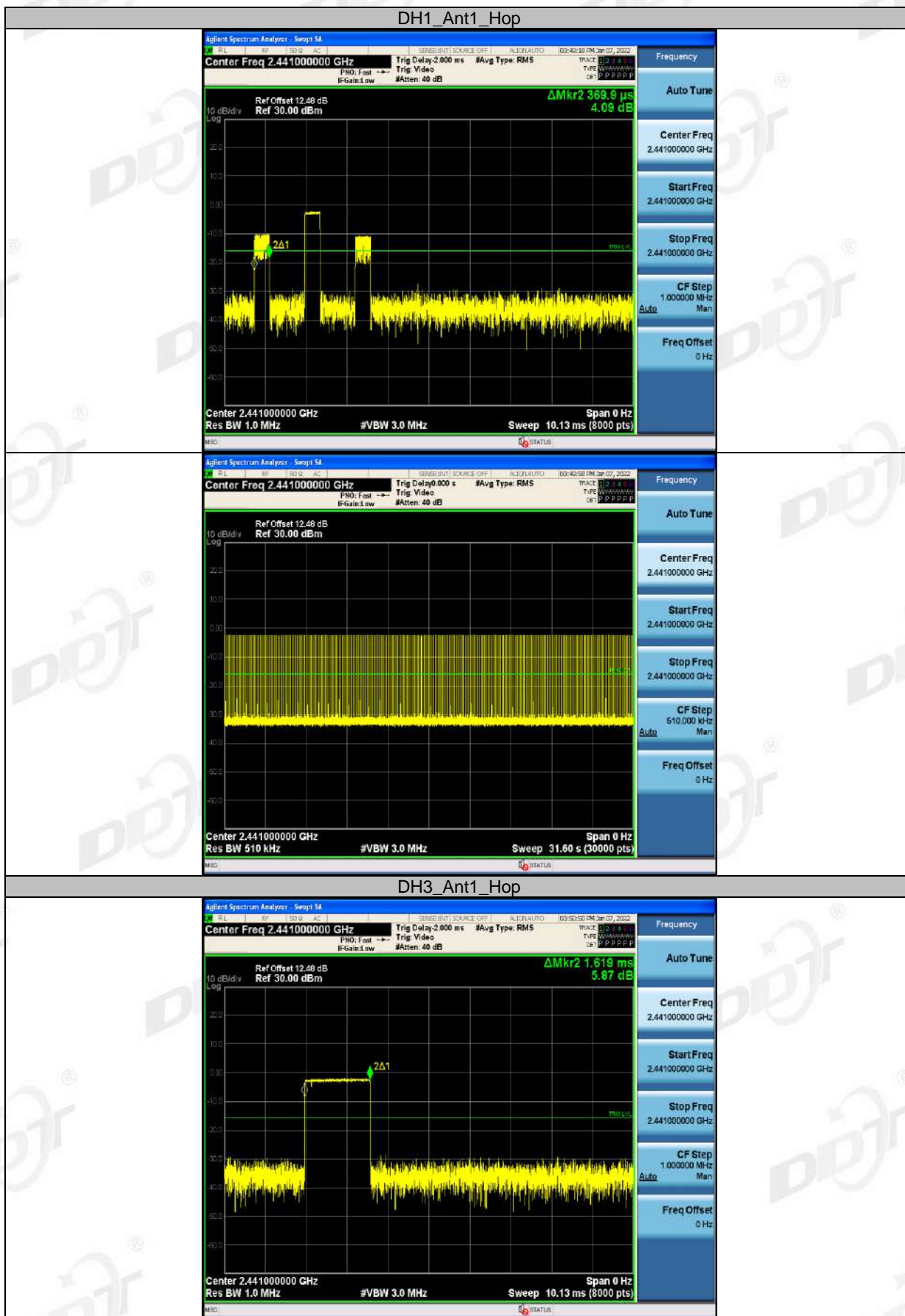

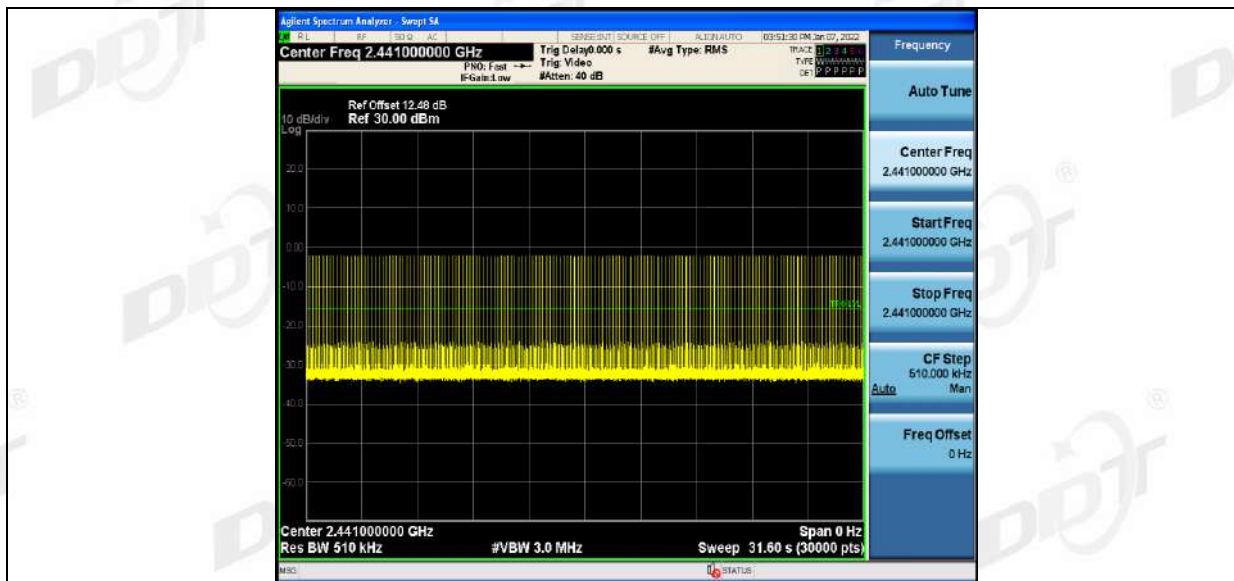

DH5_Ant1_Hop

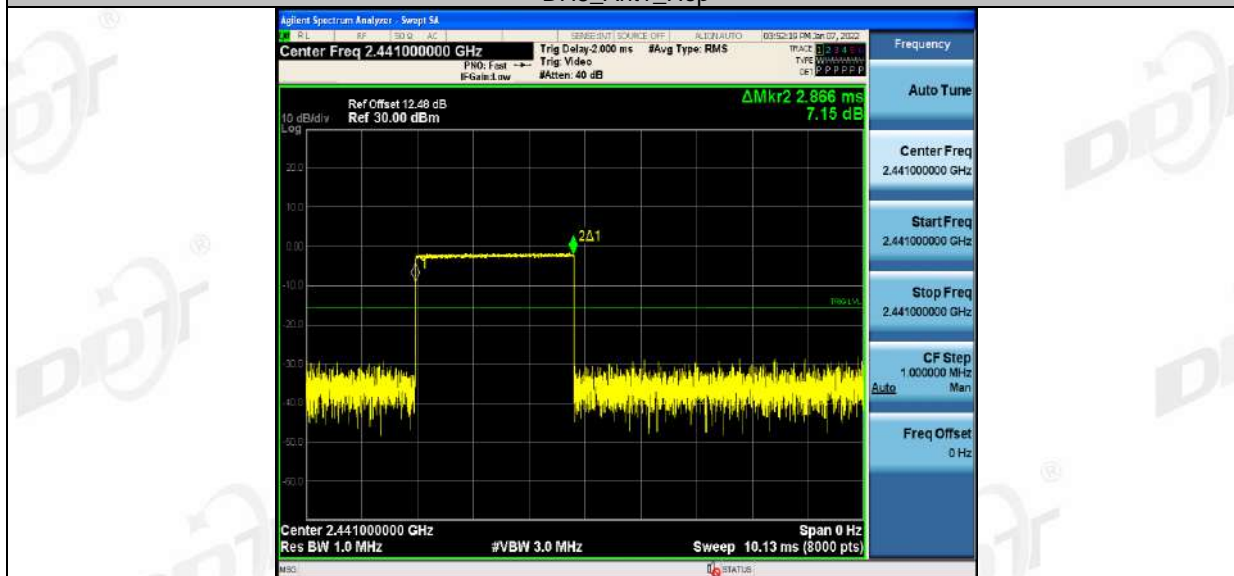

2DH1_Ant1_Hop

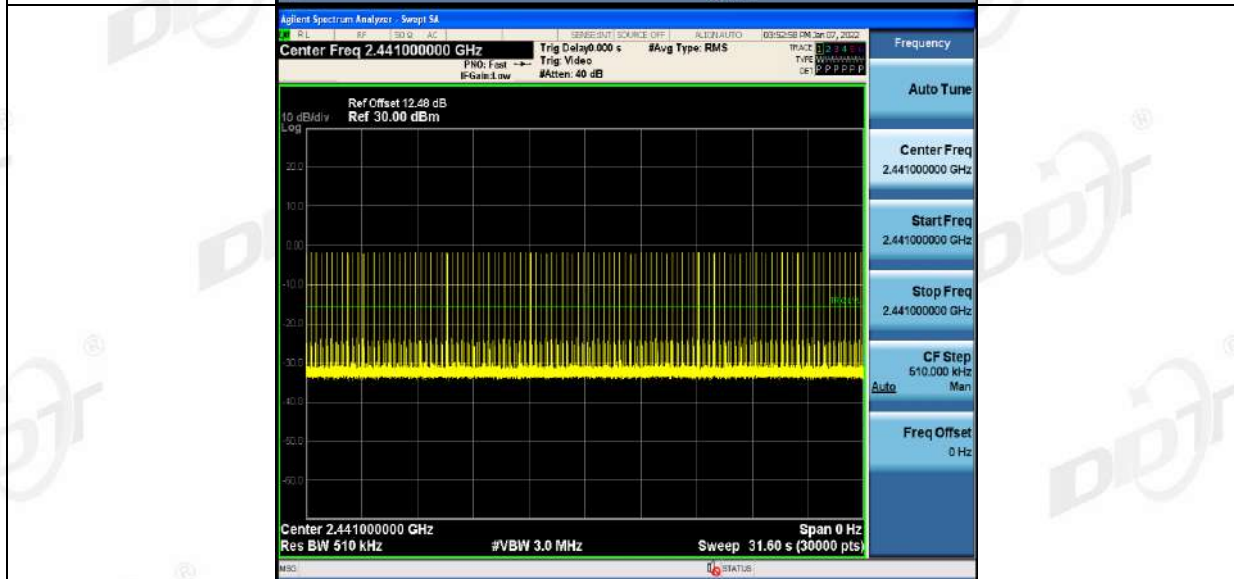

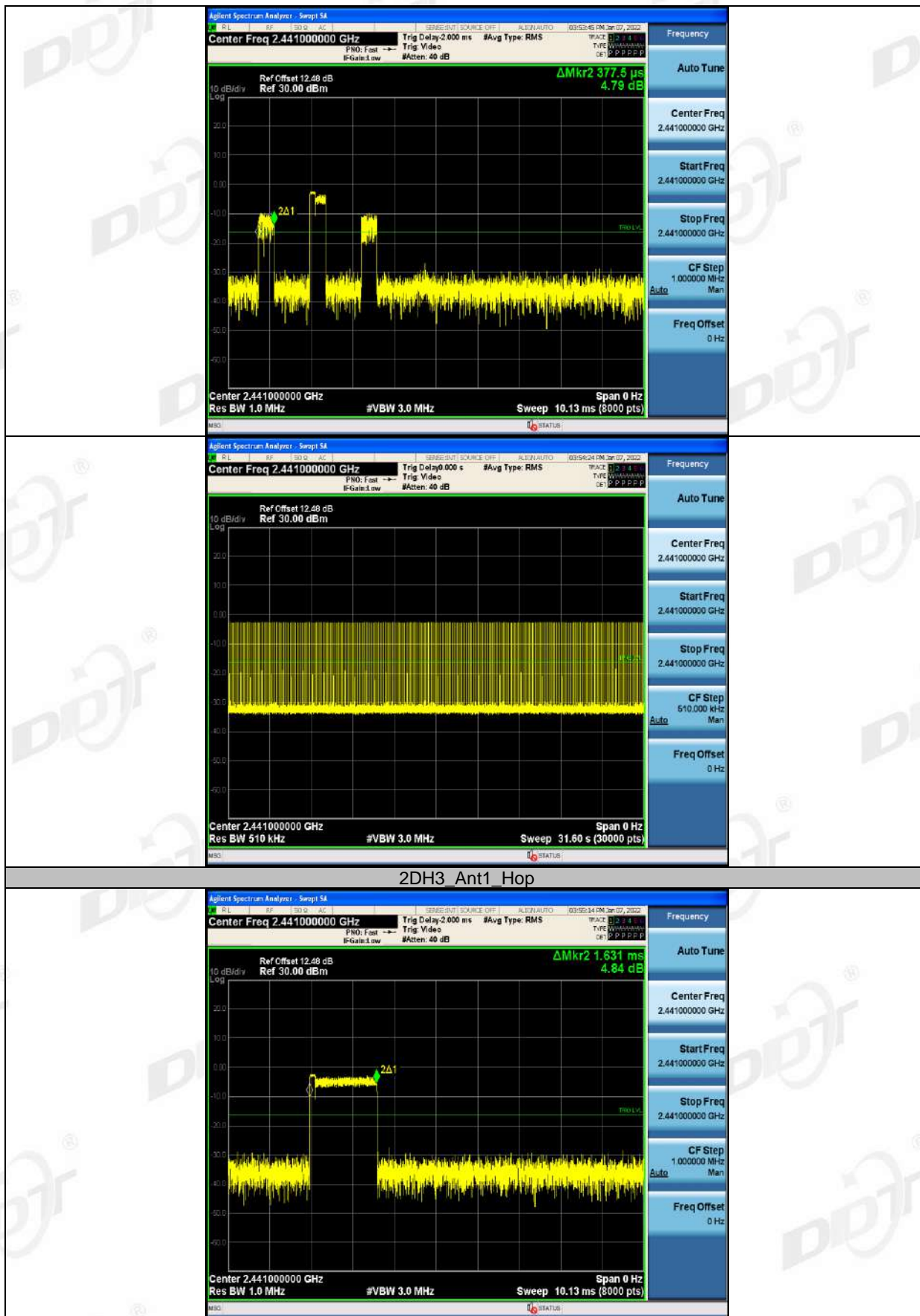

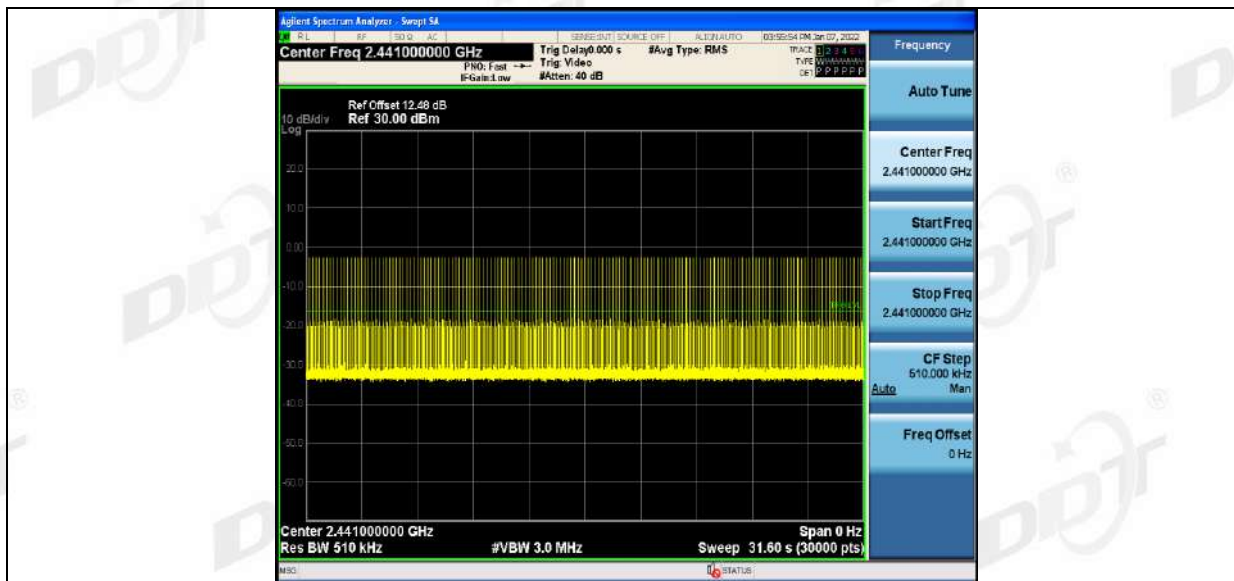

2DH5_Ant1_Hop

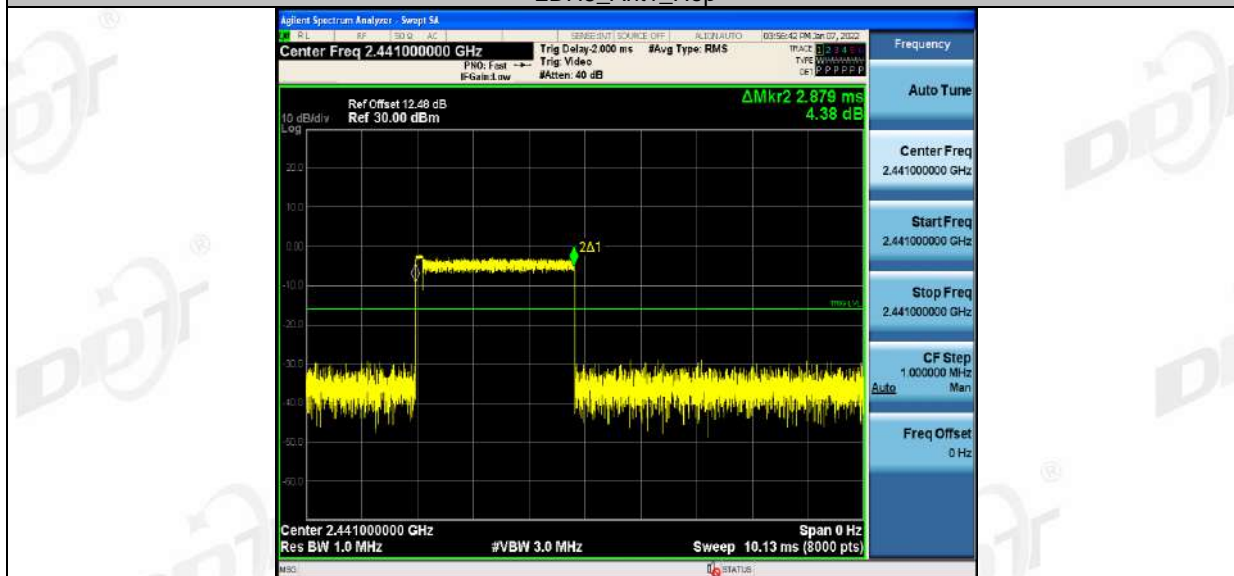

3DH1_Ant1_Hop

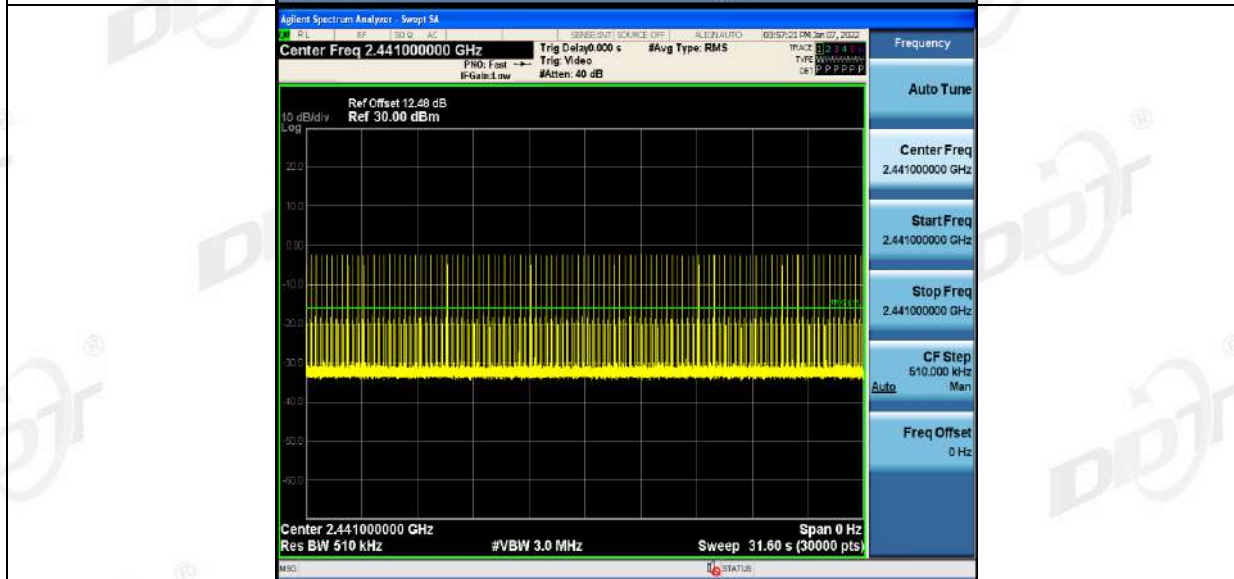

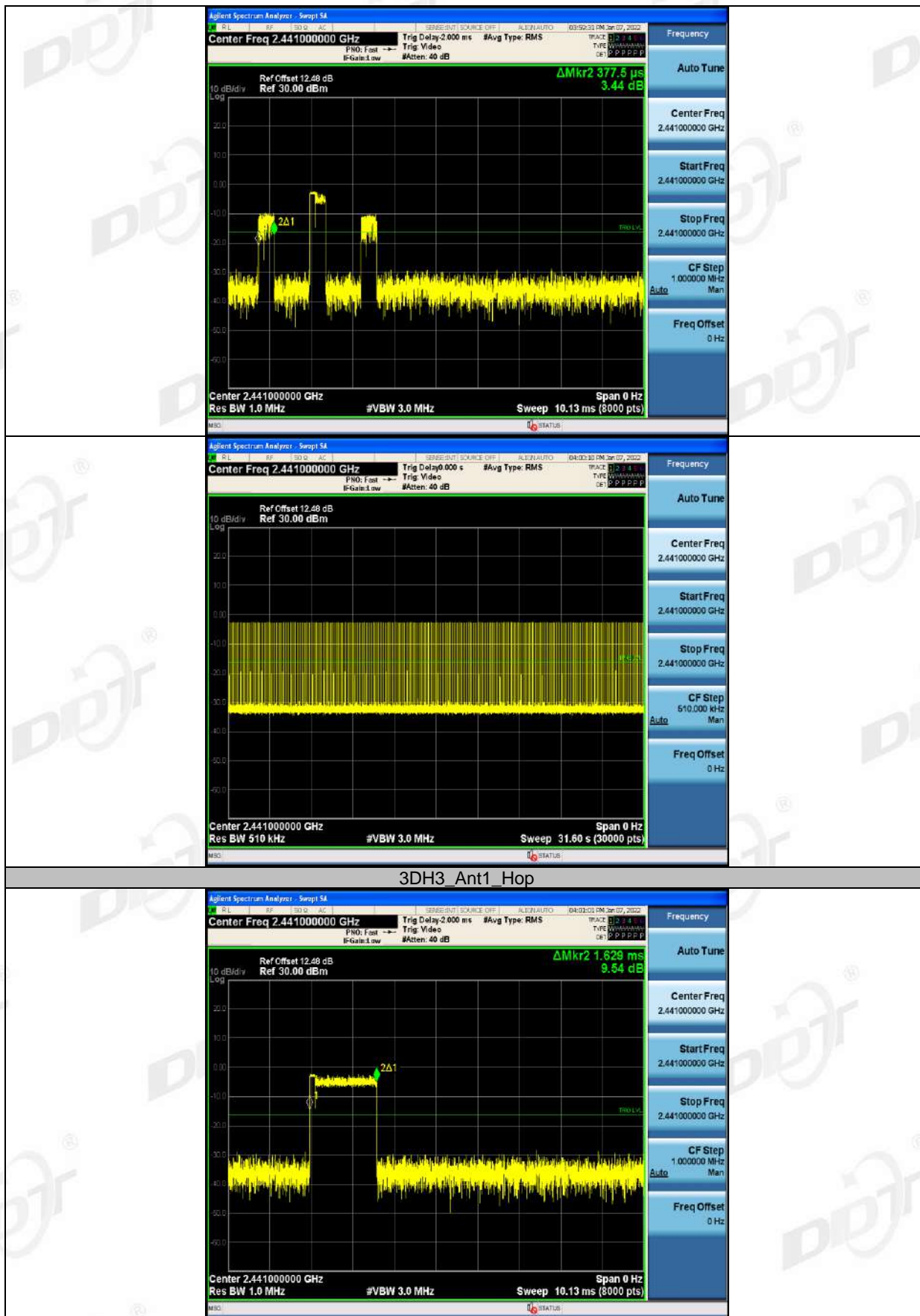

3DH3_Ant1_Hop

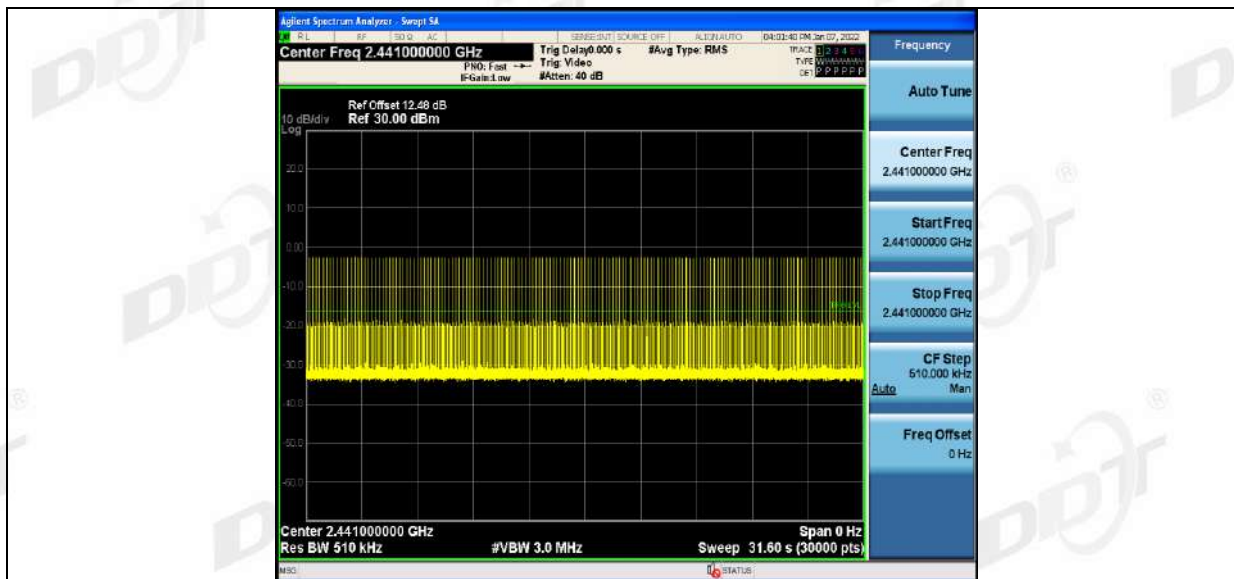

3DH5_Ant1_Hop

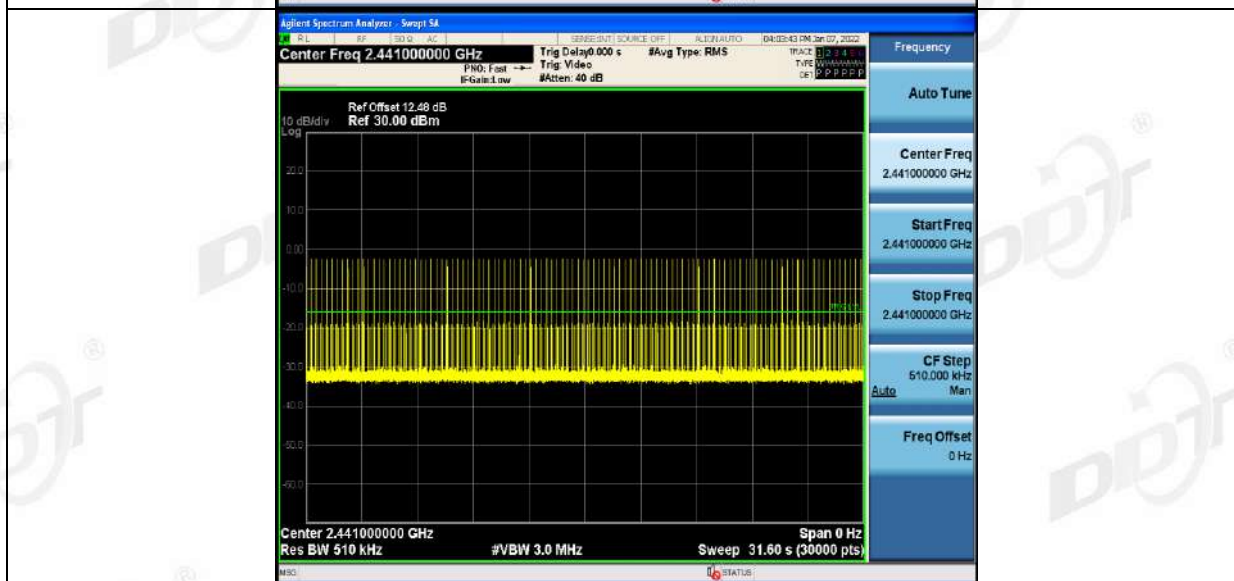
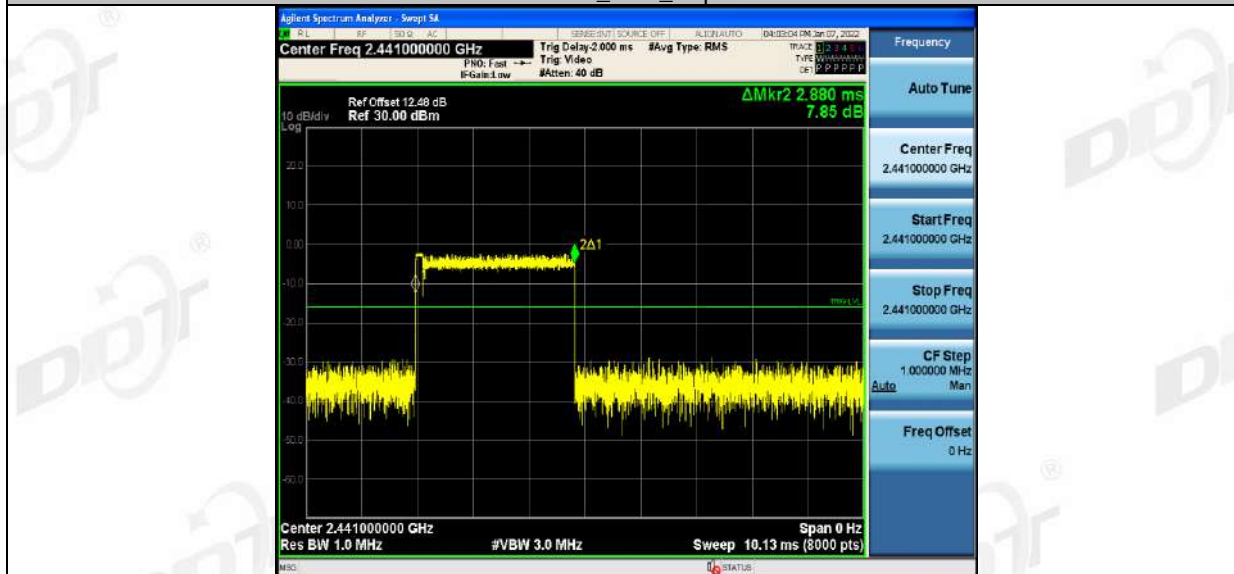

8. Number of Hopping Channel

8.1. Block diagram of test setup

Same as section 4.1

8.2. Limits

Frequency hopping systems in the 2400-2483.5 MHz band shall use at least 15 channels.

8.3. Test procedure

- (1) Connect EUT's antenna output to spectrum analyzer by RF cable.
- (2) The number of hopping channels was measured by spectrum analyzer with 300 kHz RBW and 300 kHz VBW.

8.4. Test result

TestMode	Antenna	Channel	Result[Num]	Limit[Num]	Verdict
DH5	Ant1	Hop	79	≥15	PASS
2DH5	Ant1	Hop	79	≥15	PASS
3DH5	Ant1	Hop	79	≥15	PASS

8.5. Test graphs

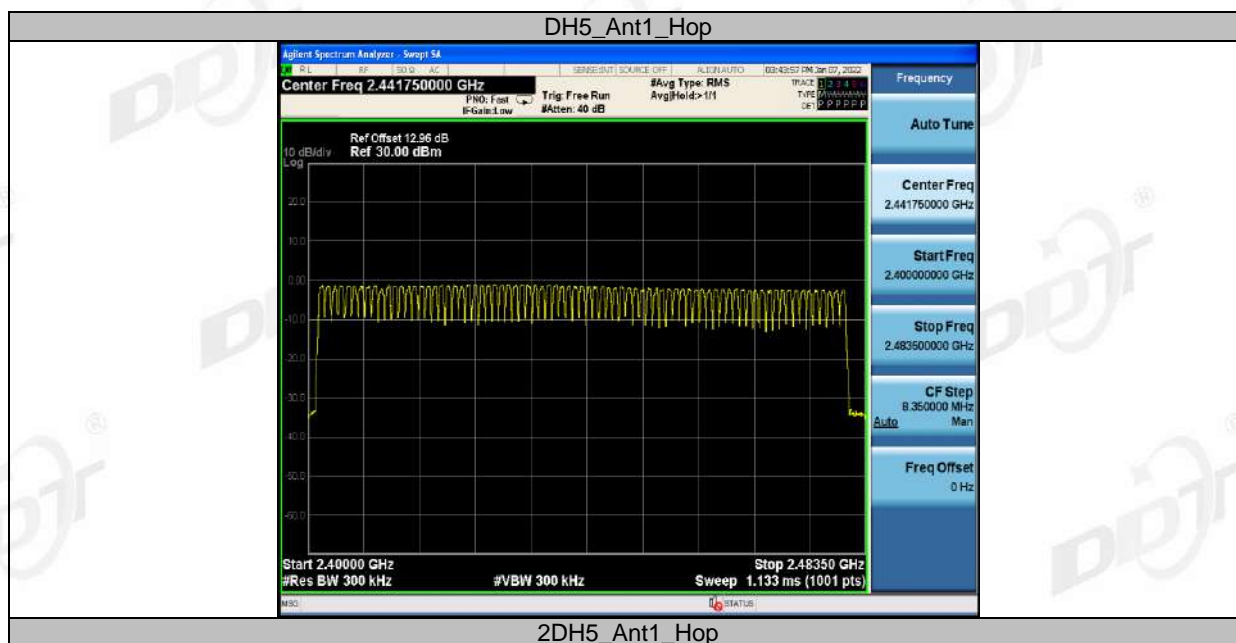



3DH5_Ant1_Hop



9. Band Edge Compliance (Conducted Method)

9.1. Block diagram of test setup

Same as section 4.1

9.2. Limit

All restriction band should comply with 15.209, other emission should be at least 20dB below the fundamental.

9.3. Test result

TestMode	Antenna	ChName	Channel	RefLevel [dBm]	Result [dBm]	Limit [dBm]	Verdict
DH5	Ant1	Low	2402	-1.93	-44.56	≤-21.93	PASS
		High	2480	-3.14	-45.99	≤-23.14	PASS
		Low	Hop_2402	-2.70	-44.73	≤-22.7	PASS
		High	Hop_2480	-3.51	-45.17	≤-23.51	PASS
2DH5	Ant1	Low	2402	-1.99	-44.52	≤-21.99	PASS
		High	2480	-3.23	-45.79	≤-23.23	PASS
		Low	Hop_2402	-4.20	-45.6	≤-24.2	PASS
		High	Hop_2480	-8.11	-45.06	≤-28.11	PASS
3DH5	Ant1	Low	2402	-2.03	-45	≤-22.03	PASS
		High	2480	-3.21	-45.68	≤-23.21	PASS
		Low	Hop_2402	-3.68	-45.44	≤-23.68	PASS
		High	Hop_2480	-5.48	-45.15	≤-25.48	PASS

9.4. Test graphs

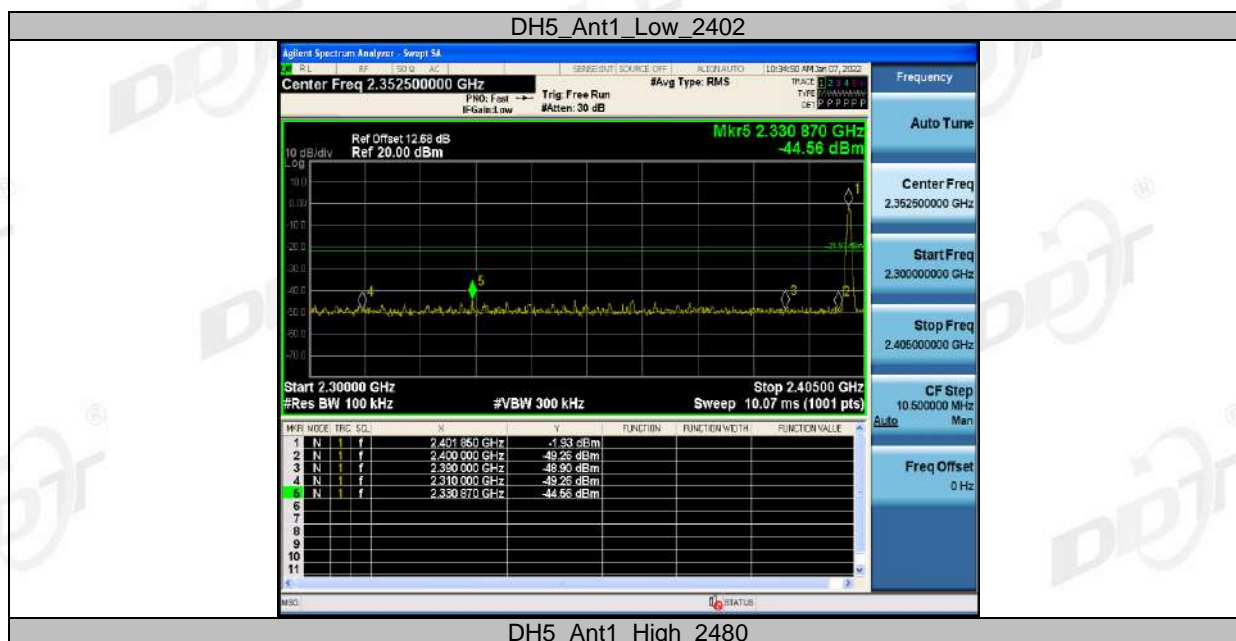

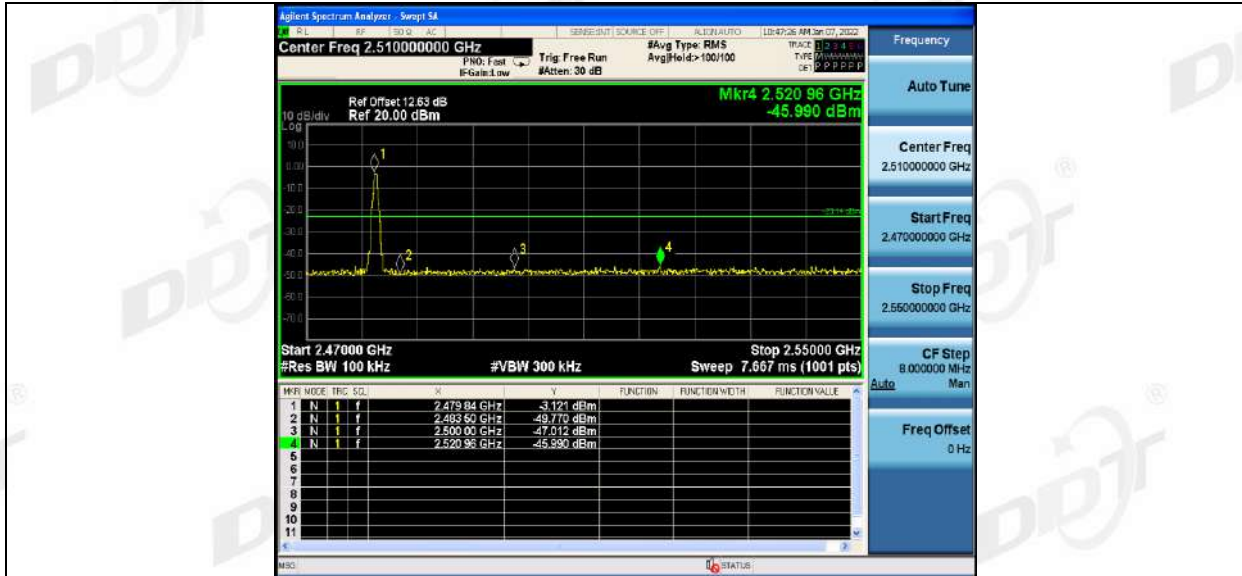

DH5_Ant1_Low_Hop_2402

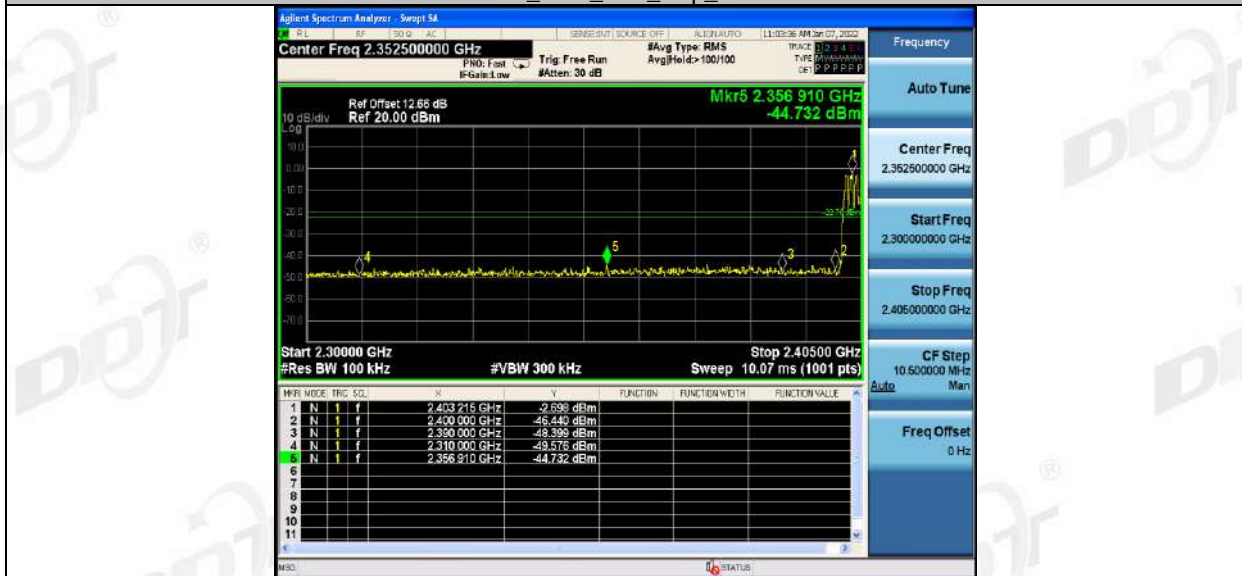

DH5_Ant1_High_Hop_2480

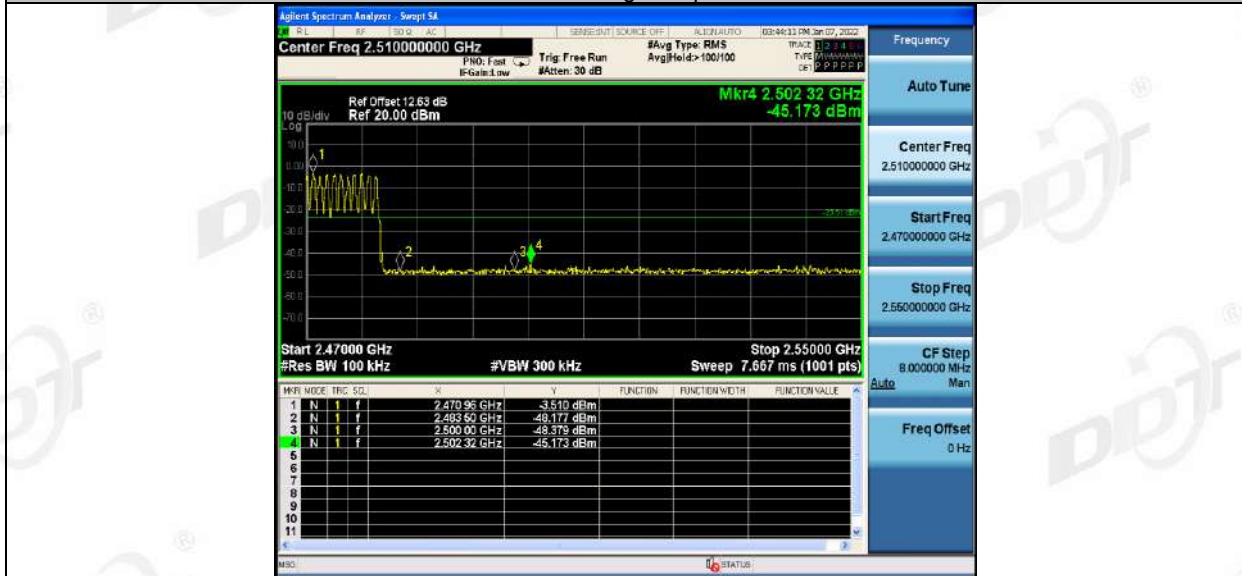

2DH5_Ant1_Low_2402

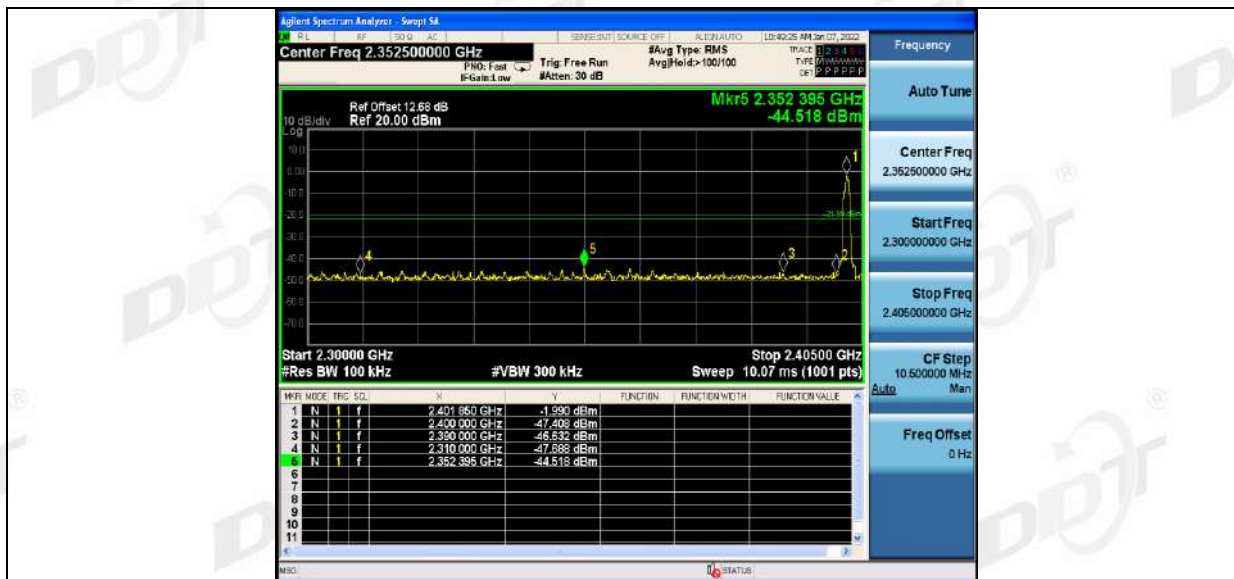

2DH5_Ant1_High_2480

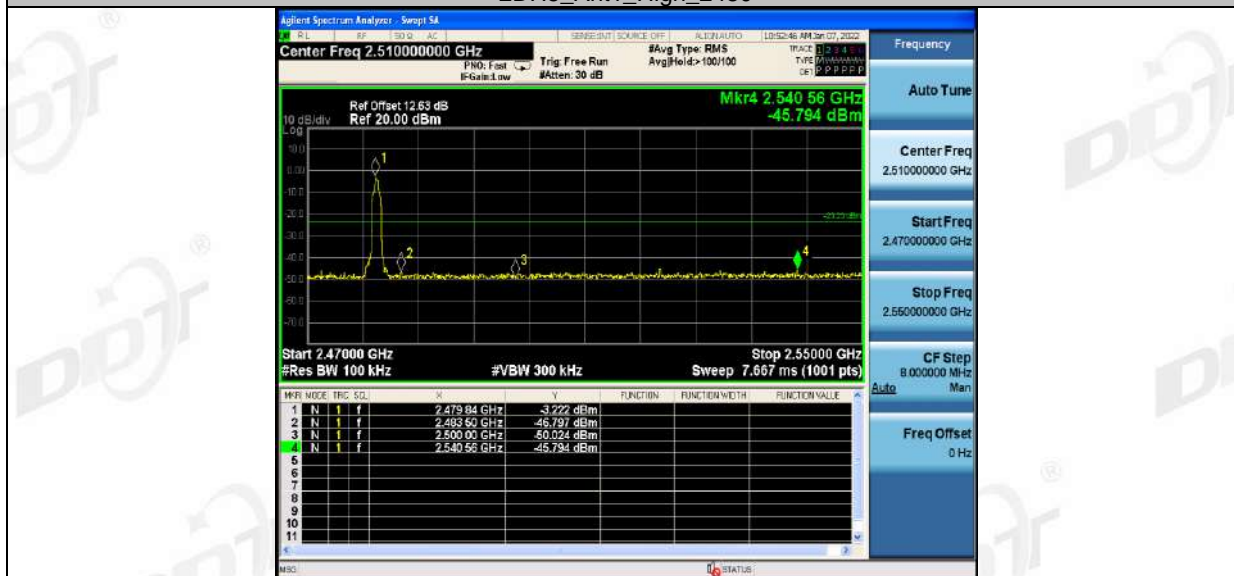

2DH5_Ant1_Low_Hop_2402

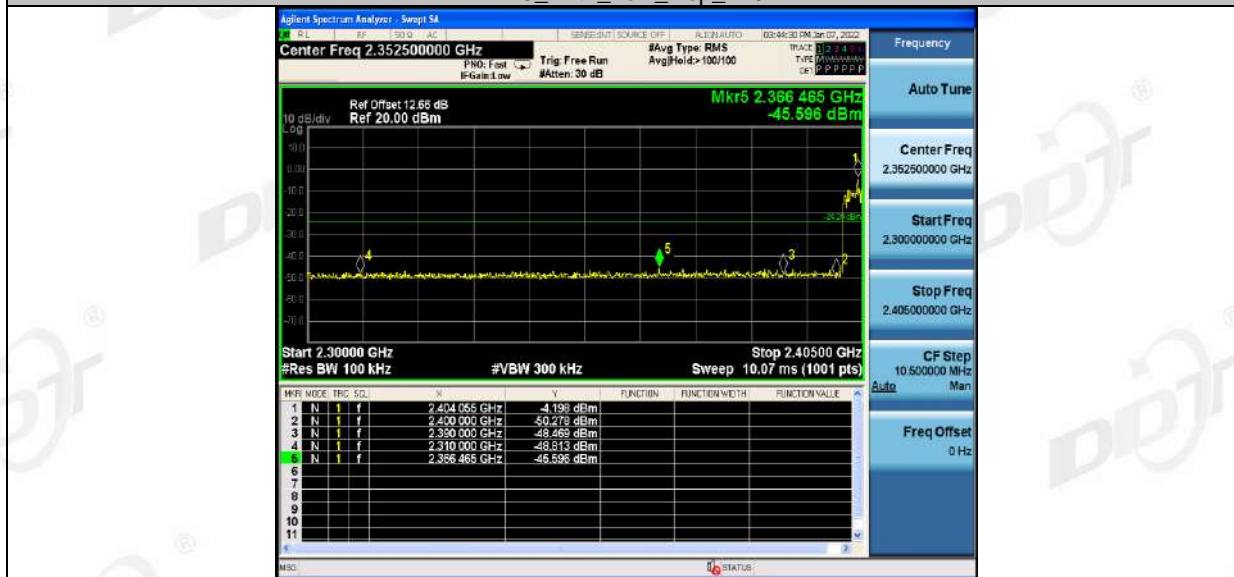

2DH5_Ant1_High_Hop_2480

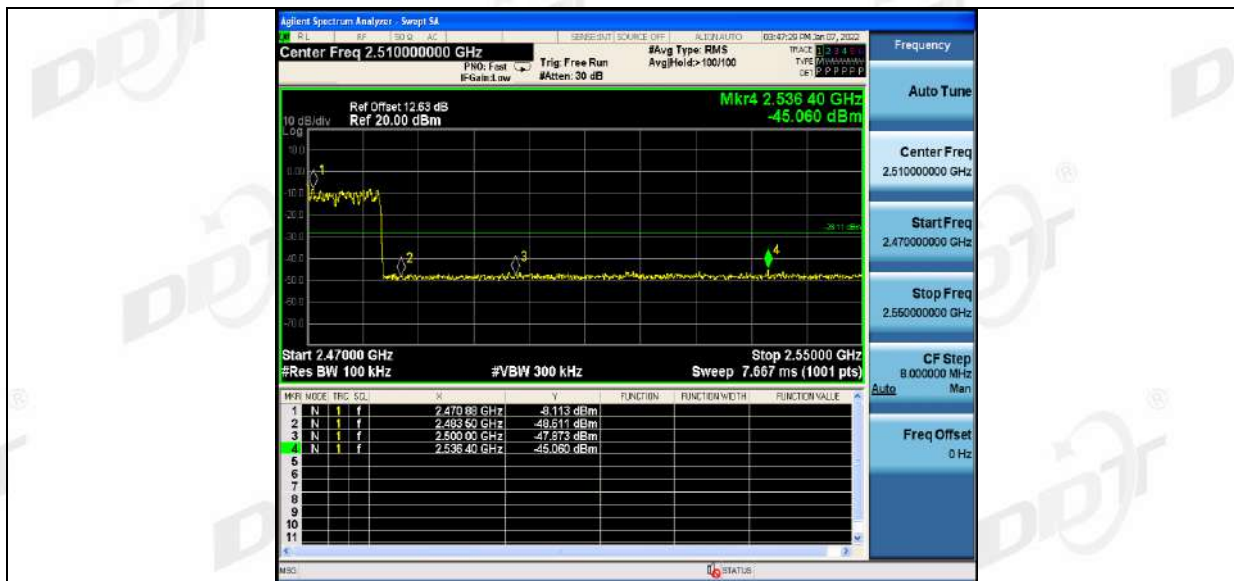

3DH5_Ant1_Low_2402

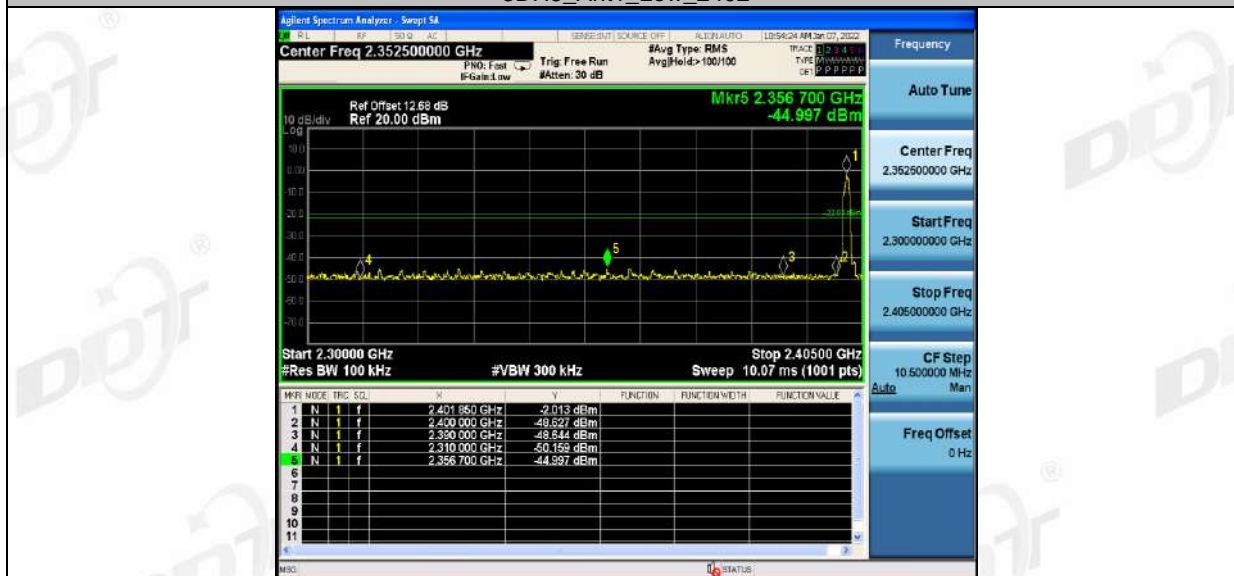

3DH5_Ant1_High_2480

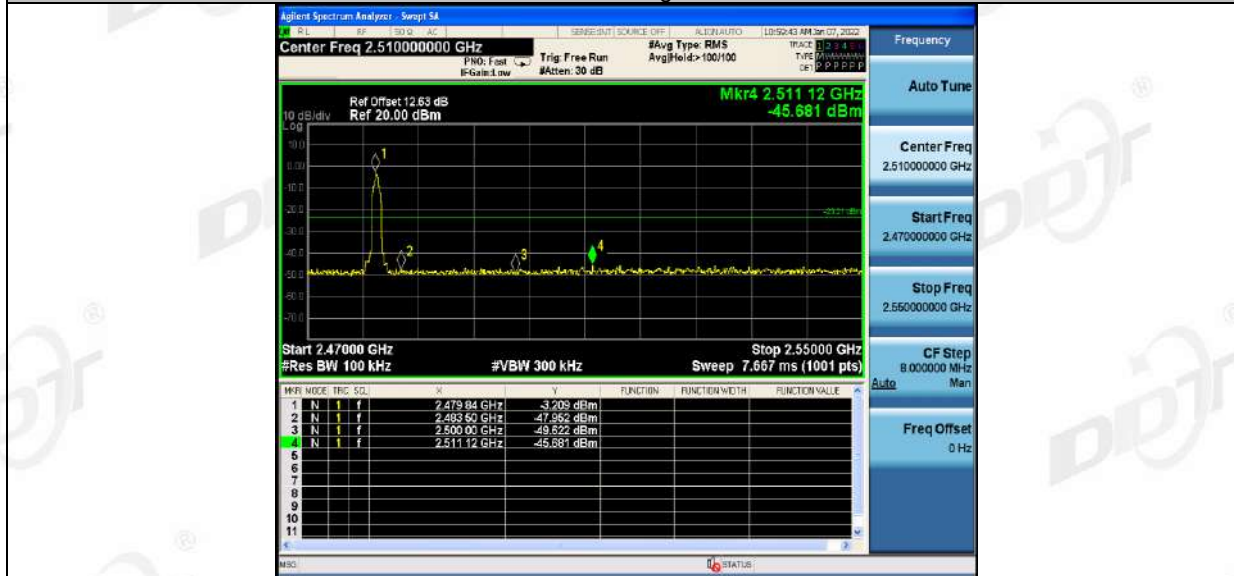

3DH5_Ant1_Low_Hop_2402

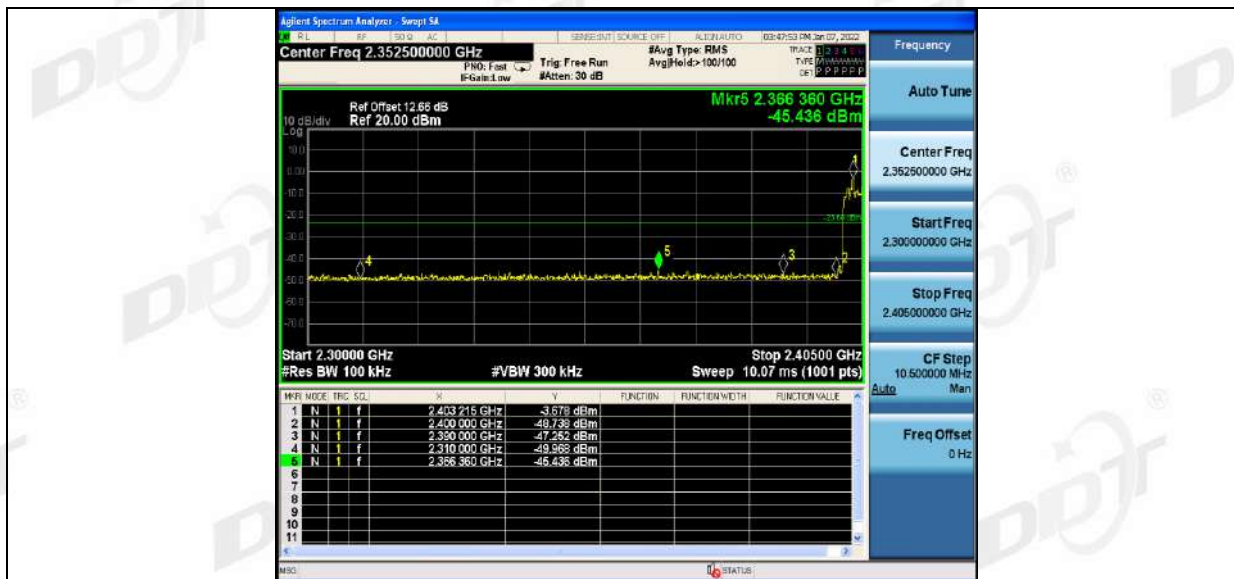

3DH5_Ant1_High_Hop_2480

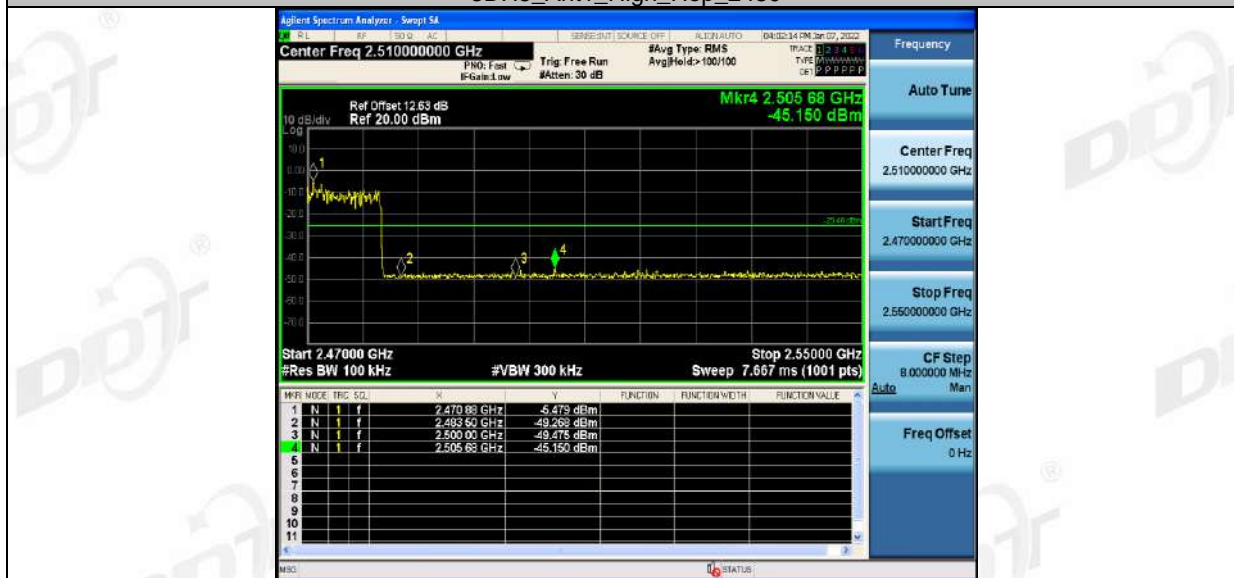

10. RF Conducted Spurious Emissions

10.1. Block diagram of test setup

Same as section 4.1

10.2. Limits

In any 100kHz bandwidth outside the frequency bands in which the spread spectrum intentional radiator is operating, the radio frequency power that is produced by the intentional radiator shall be at least 20dB below that in the 100kHz bandwidth within the band that contains the highest level of the desired power.

10.3. Test procedure

(1) Connect EUT's antenna output to spectrum analyzer by RF cable.

(2) Establish a reference level by using the following procedure:

Center frequency	Test frequency
RBW:	100kHz
VBW:	300kHz
Span	Wide enough to capture the peak level of the in-band emission
Detector Mode:	Peak
Sweep time:	auto
Trace mode	Max hold

(3) Allow the trace to stabilize, use the peak marker function to determine the maximum peak power level to establish the reference level.

(4) Set the spectrum analyzer as follows:

RBW:	100kHz
VBW:	300kHz
Span	Encompass frequency range to be measured
Number of measurement points	$\geq \text{span}/\text{RBW}$
Detector Mode:	Peak
Sweep time:	auto
Trace mode	Max hold

(5) Allow the trace to stabilize, use the peak marker function to determine the maximum amplitude of all unwanted emissions outside of the authorized frequency band

10.4. Test result

TestMode	Antenna	Channel	FreqRange [MHz]	RefLevel [dBm]	Result [dBm]	Limit [dBm]	Verdict
DH5	Ant1	2402	Reference	-1.91	-1.91	---	PASS
			30~1000	-1.91	-57.17	≤-21.91	PASS
			1000~26500	-1.91	-39.8	≤-21.91	PASS
		2441	Reference	5.17	5.17	---	PASS
			30~1000	5.17	-53.22	≤-14.83	PASS
			1000~26500	5.17	-38.87	≤-14.83	PASS
		2480	Reference	-3.12	-3.12	---	PASS
			30~1000	-3.12	-56.83	≤-23.12	PASS
			1000~26500	-3.12	-39.87	≤-23.12	PASS
2DH5	Ant1	2402	Reference	-2.01	-2.01	---	PASS
			30~1000	-2.01	-56.8	≤-22.01	PASS
			1000~26500	-2.01	-38.84	≤-22.01	PASS
		2441	Reference	-2.46	-2.46	---	PASS
			30~1000	-2.46	-55.92	≤-22.46	PASS
			1000~26500	-2.46	-40.3	≤-22.46	PASS
		2480	Reference	-3.22	-3.22	---	PASS
			30~1000	-3.22	-56.74	≤-23.22	PASS
			1000~26500	-3.22	-39.25	≤-23.22	PASS
3DH5	Ant1	2402	Reference	-1.98	-1.98	---	PASS
			30~1000	-1.98	-55.65	≤-21.98	PASS
			1000~26500	-1.98	-39.85	≤-21.98	PASS
		2441	Reference	-2.41	-2.41	---	PASS
			30~1000	-2.41	-57.61	≤-22.41	PASS
			1000~26500	-2.41	-39.03	≤-22.41	PASS
		2480	Reference	-3.23	-3.23	---	PASS
			30~1000	-3.23	-56.76	≤-23.23	PASS
			1000~26500	-3.23	-39.43	≤-23.23	PASS

10.5. Test graphs



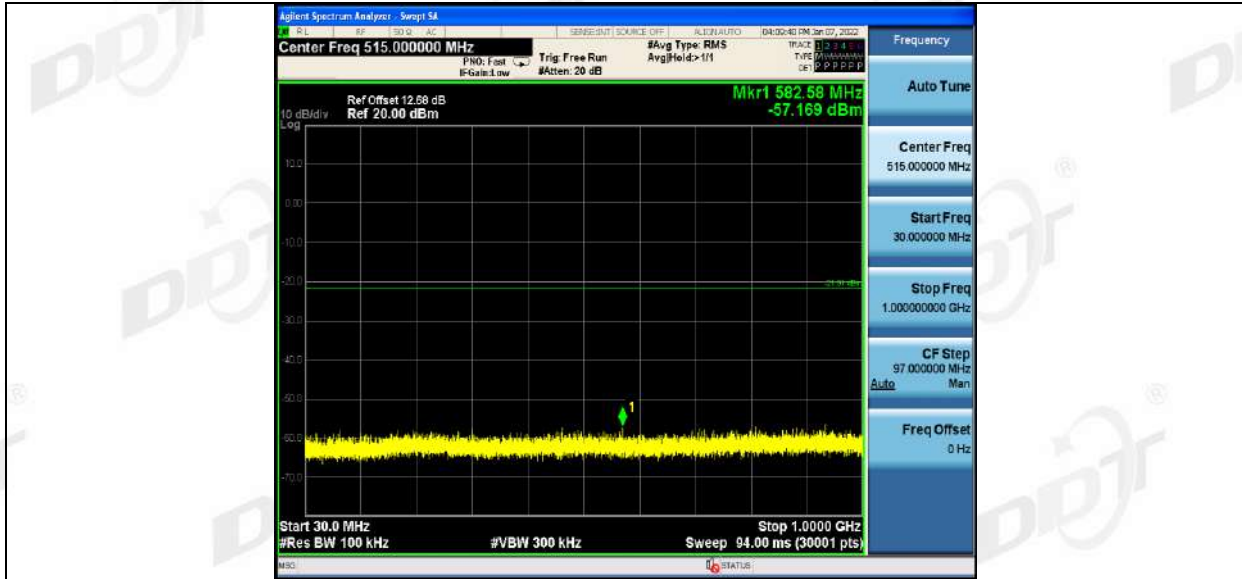

DH5_Ant1_2402_1000~26500



DH5_Ant1_2441_0~Reference



DH5_Ant1_2441_30~1000

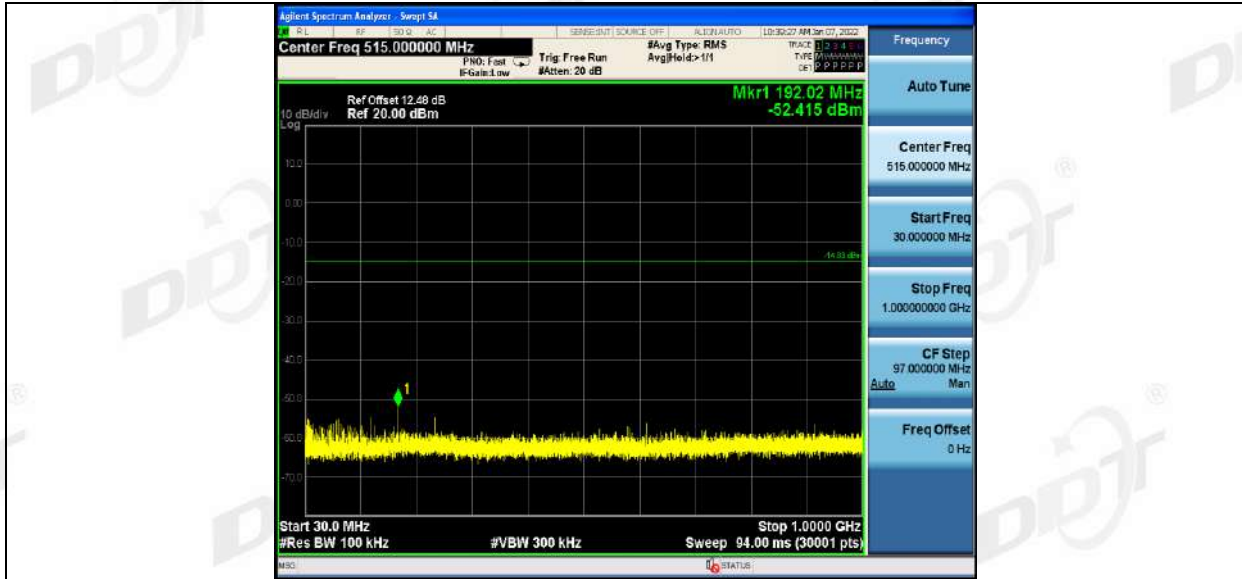

DH5_Ant1_2441_1000~26500



DH5_Ant1_2480_0-Reference



DH5_Ant1_2480_30~1000



DH5_Ant1_2480_1000~26500



2DH5_Ant1_2402_0~Reference



2DH5_Ant1_2402_30~1000

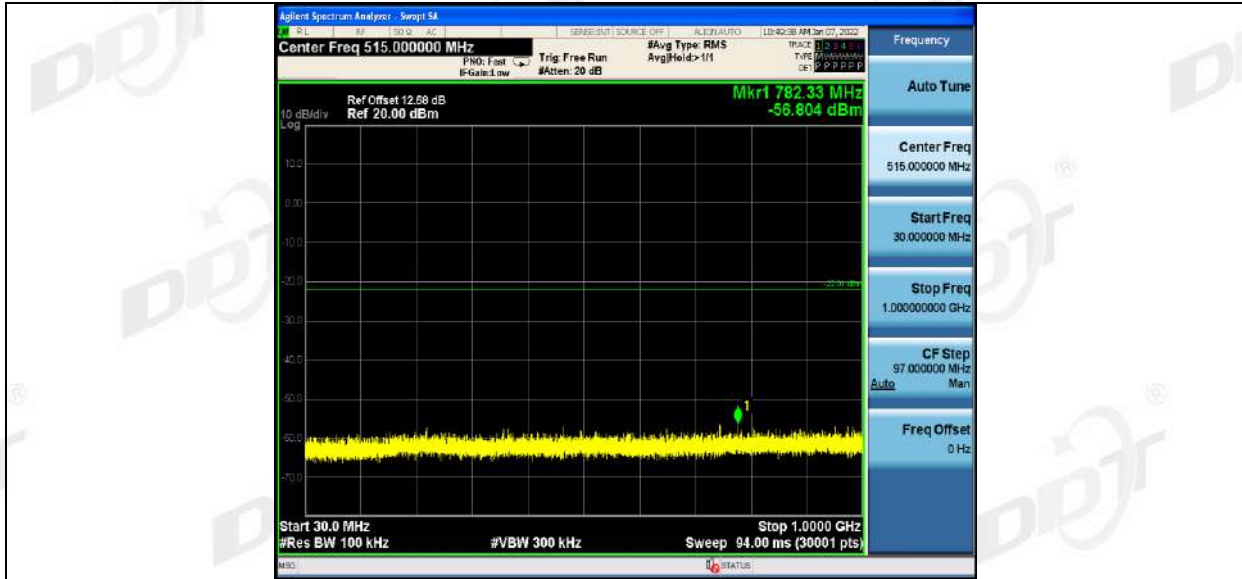

2DH5_Ant1_2402_1000~26500

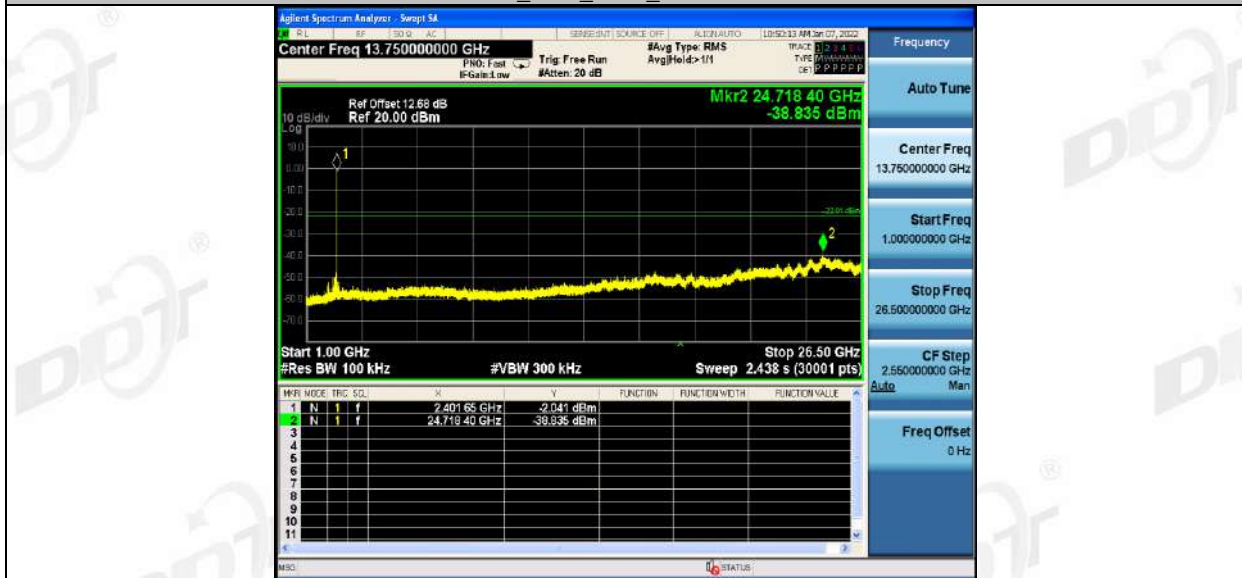

2DH5_Ant1_2441_0~Reference



2DH5_Ant1_2441_30~1000

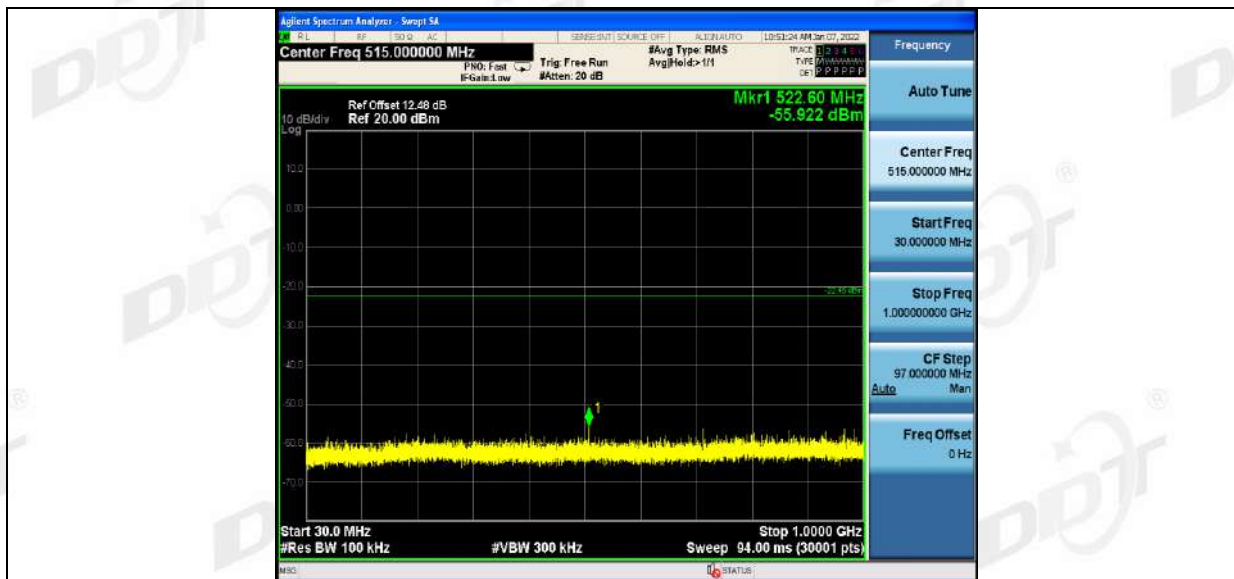

2DH5_Ant1_2441_1000~26500



2DH5_Ant1_2480_0~Reference



2DH5_Ant1_2480_30~1000



2DH5_Ant1_2480_1000~26500



3DH5_Ant1_2402_0~Reference



3DH5_Ant1_2402_30~1000

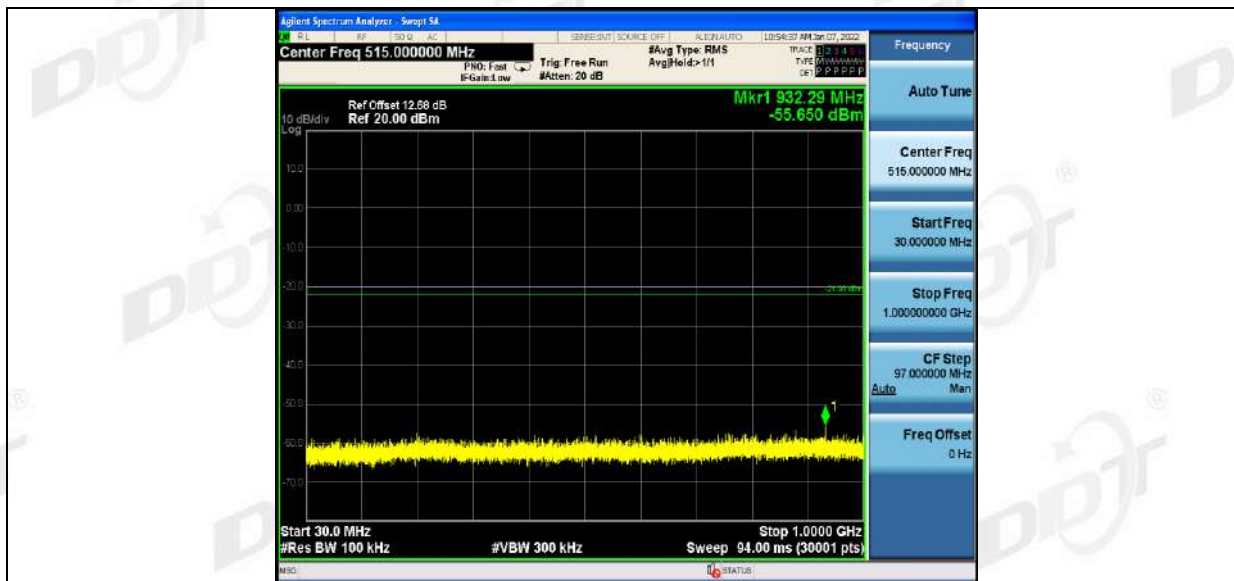

3DH5_Ant1_2402_1000~26500



3DH5_Ant1_2441_0~Reference



3DH5_Ant1_2441_30~1000

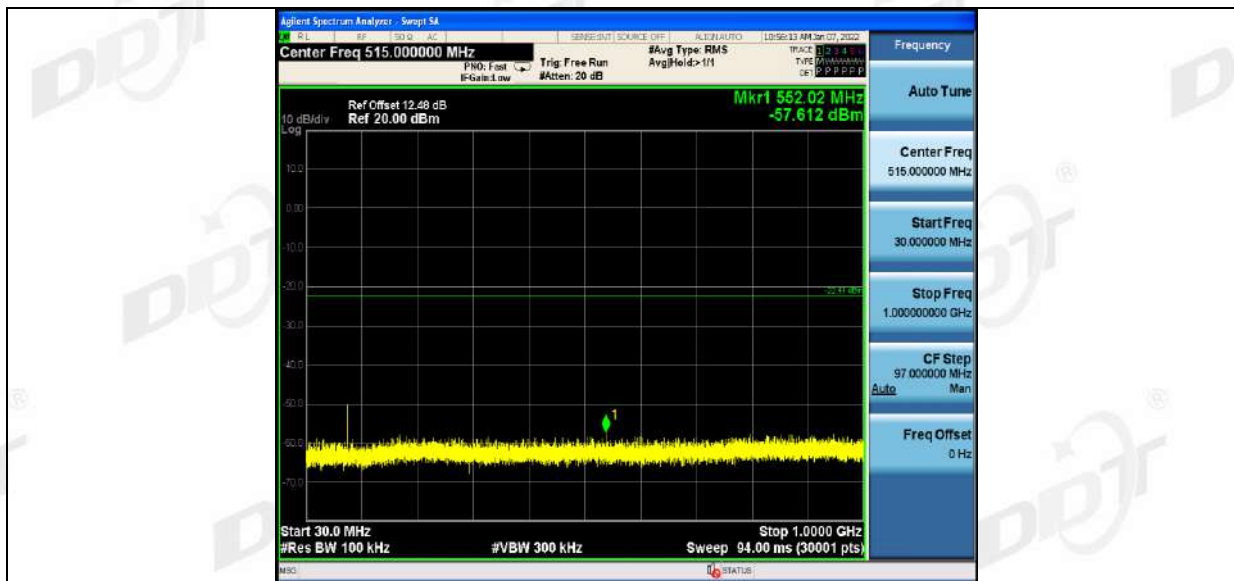

3DH5_Ant1_2441_1000~26500



3DH5_Ant1_2480_0~Reference



3DH5_Ant1_2480_30~1000

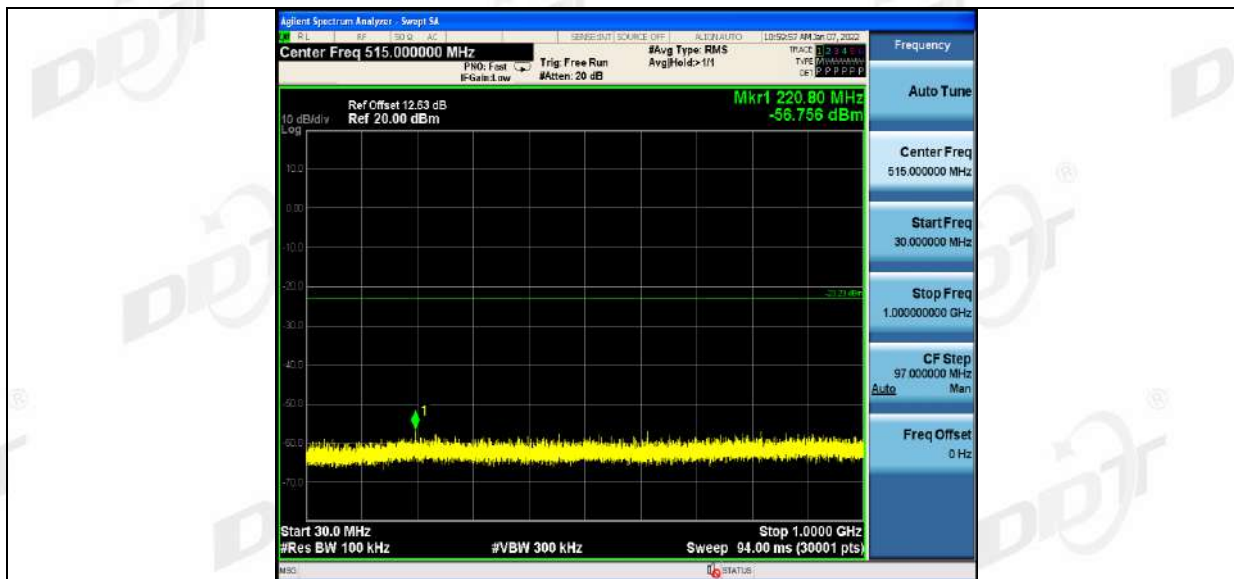

3DH5_Ant1_2480_1000~26500



11. Radiated Emission

11.1. Block diagram of test setup

In 3m Anechoic Chamber, test setup diagram for 9kHz-30MHz:

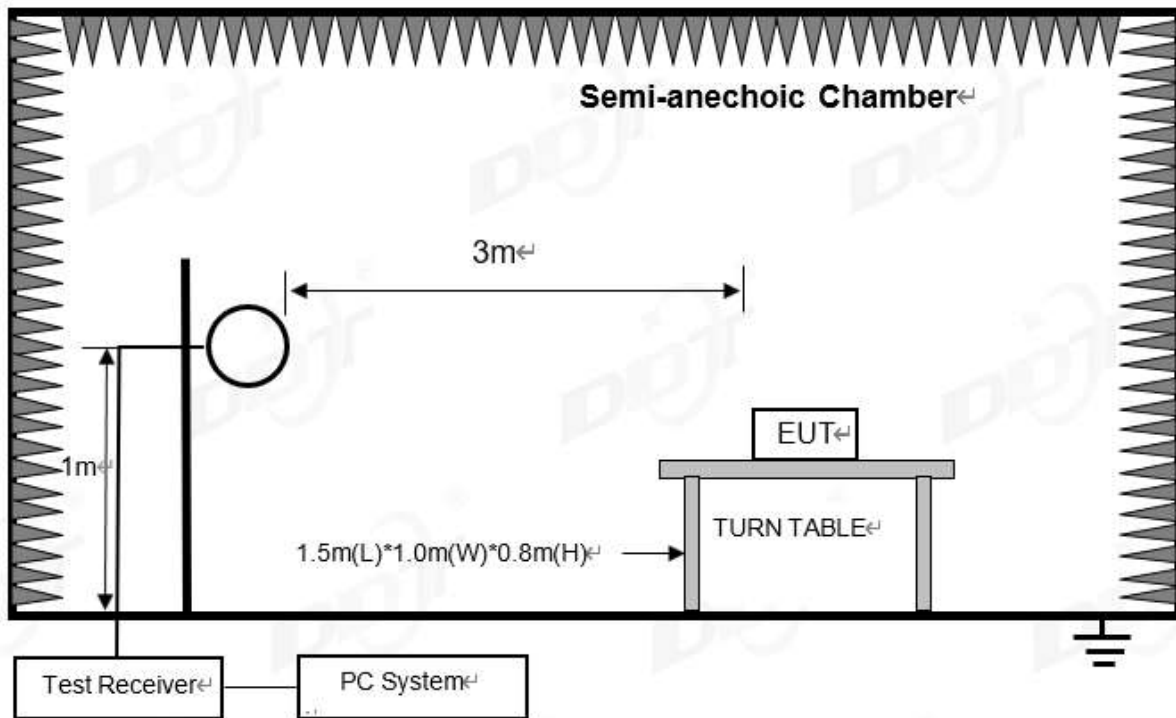

In 3m Anechoic Chamber, test setup diagram for 30MHz-1GHz:

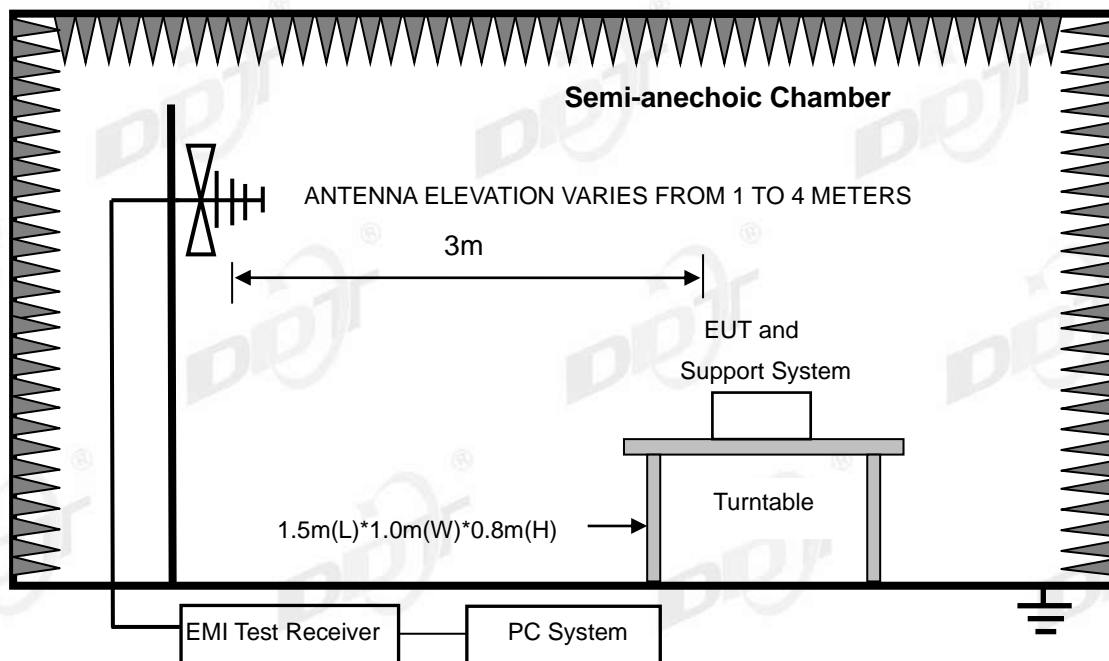

In 3m Anechoic Chamber, test setup diagram for frequency above 1GHz:

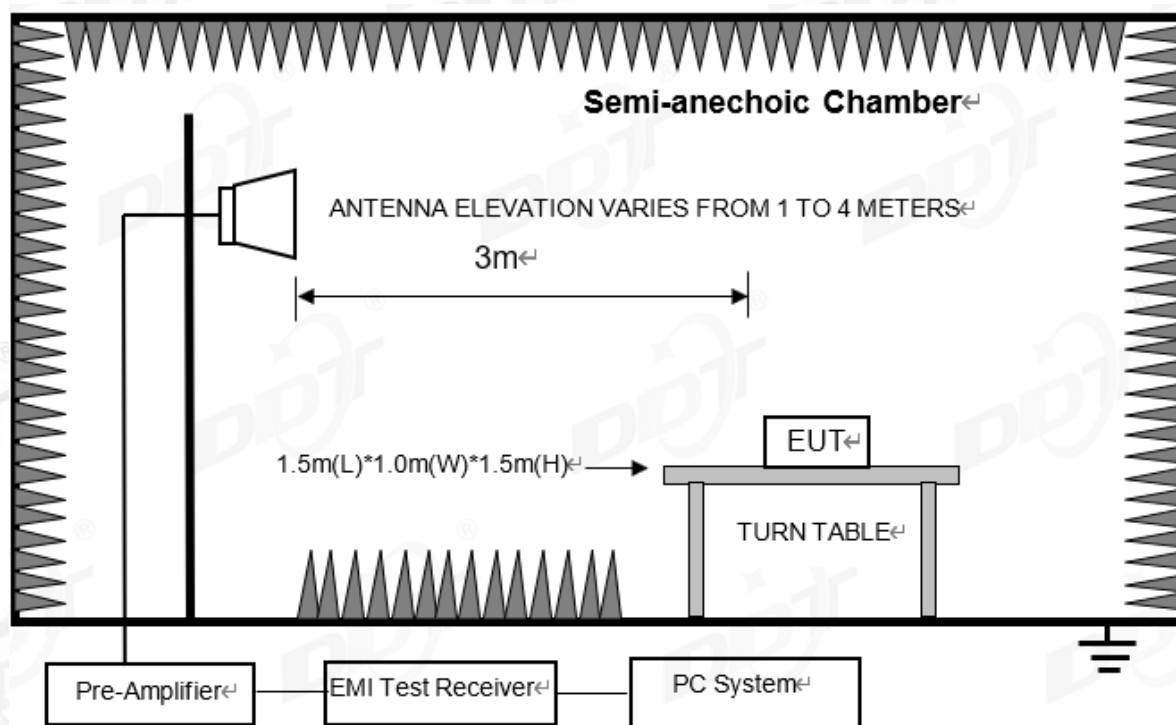

Note: For harmonic emissions test an appropriate high pass filter was inserted in the input port of AMP.

11.2. Limit

(1) FCC 15.205 Restricted frequency band

MHz	MHz	MHz	GHz
0.090-0.110	16.42-16.423	399.9-410	4.5-5.15
¹ 0.495-0.505	16.69475-16.69525	608-614	5.35-5.46
2.1735-2.1905	16.80425-16.80475	960-1240	7.25-7.75
4.125-4.128	25.5-25.67	1300-1427	8.025-8.5
4.1772&4.1775	37.5-38.25	1435-1626.5	9.0-9.2
4.2072&4.2075	73-74.6	1645.5-1646.5	9.3-9.5
6.215-6.218	74.8-75.2	1660-1710	10.6-12.7
6.26775-6.26825	108-121.94	1718.8-1722.2	13.25-13.4
6.31175-6.31225	123-138	2200-2300	14.47-14.5
8.291-8.294	149.9-150.05	2310-2390	15.35-16.2
8.362-8.366	156.52475-156.52525	2483.5-2500	17.7-21.4
8.37625-8.38675	156.7-156.9	2690-2900	22.01-23.12
8.41425-8.41475	162.0125-167.17	3260-3267	23.6-24.0
12.29-12.293	167.72-173.2	3332-3339	31.2-31.8
12.51975-12.52025	240-285	3345.8-3358	36.43-36.5
12.57675-12.57725	322-335.4	3600-4400	(²)
13.36-13.41			

¹Until February 1, 1999, this restricted band shall be 0.490-0.510 MHz.

²Above 38.6

(2) FCC 15.209 Limit.

FREQUENCY MHz	DISTANCE Meters	FIELD STRENGTHS LIMIT	
		$\mu\text{V}/\text{m}$	$\text{dB}(\mu\text{V})/\text{m}$
0.009 ~ 0.490	300	2400/F(kHz)	67.6-20log(F)
0.490 ~ 1.705	30	24000/F(kHz)	87.6-20log(F)
1.705 ~ 30.0	30	30	29.54
30 ~ 88	3	100	40.0
88 ~ 216	3	150	43.5
216 ~ 960	3	200	46.0
960 ~ 1000	3	500	54.0
Above 1000	3	74.0 $\text{dB}(\mu\text{V})/\text{m}$ (Peak) 54.0 $\text{dB}(\mu\text{V})/\text{m}$ (Average)	

Note: (1) The emission limits shown in the above table are based on measurements employing a CISPR QP detector except for the frequency bands 9-90kHz, 110-490kHz and above 1000MHz, radiated emissions limits in these three bands are based on measurements employing an average detector.

(2) At frequencies below 30MHz, measurement may be performed at a distance closer than that specified, and the limit at closer measurement distance can be extrapolated by below formula:

$$\text{Limit}_{3\text{m}}(\text{dB}\mu\text{V}/\text{m}) = \text{Limit}_{30\text{m}}(\text{dB}\mu\text{V}/\text{m}) + 40\text{Log}(30\text{m}/3\text{m})$$

(3) Limit for this EUT

All the emissions appearing within 15.205 restricted frequency bands shall not exceed the limits shown in 15.209, all the other emissions shall be at least 20dB below the fundamental emissions or comply with 15.209 limits.

11.3. Test procedure

(1) EUT was placed on a non-metallic table, 80 cm above the ground plane inside a semi-anechoic chamber for below 1Gand150 cm above the ground plane inside a fully-anechoic chamber for above 1GHz.

(2) Test antenna was located 3 m from the EUT on an adjustable mast, and the antenna used as below table.

Test frequency range	Test antenna used	Test antenna distance
9kHz-30MHz	Active Loop antenna	3m
30MHz-1GHz	Trilog Broadband Antenna	3m
1GHz-18GHz	Double Ridged Horn Antenna (1GHz-18GHz)	3m
18GHz-40GHz	Horn Antenna (18GHz-40GHz)	1m

According ANSI C63.10:2013 clause 6.4.4.2 and 6.5.3, for measurements below 30 MHz, the loop antenna was positioned with its plane vertical from the EUT and rotated about its vertical

axis for maximum response at each azimuth position around the EUT. And the loop antenna also is positioned with its plane horizontal at the specified distance from the EUT. The center of the loop is 1 m above the ground. For measurement above 30MHz, the trilob Broadband Antenna or Horn Antenna was located 3m from EUT, Measurements were made with the antenna positioned in both the horizontal and vertical planes of Polarization, and the measurement antenna was varied from 1 m to 4 m. in height above the reference ground plane to obtain the maximum signal strength.

(3) Below pre-scan procedure was first performed in order to find prominent frequency spectrum radiated emissions from 9 kHz to 25GHz:

(a) Scanning the peak frequency spectrum with the antenna specified in step (3), and the EUT was rotated 360 degree, the antenna height was varied from 1m to 4m (Except loop antenna, it's fixed 1m above ground.)

(b) Change work frequency or channel of device if practicable.

(c) Change modulation type of device if practicable.

(d) Change power supply range from 85% to 115% of the rated supply voltage

(e) Rotated EUT though three orthogonal axes to determine the attitude of EUT arrangement produces highest emissions.

Spectrum frequency from 9 kHz to 25GHz (tenth harmonic of fundamental frequency) was investigated, and no any obvious emission were detected from 18GHz to 25GHz, so below final test was performed with frequency range from 9 kHz to 18GHz.

(4) For final emissions measurements at each frequency of interest, the EUT was rotated and the antenna height was varied between 1m and 4m in order to maximize the emission. Measurements in both horizontal and vertical polarities were made and the data was recorded. In order to find the maximum emission, the relative positions of equipment and all of the interface cables were changed according to ANSI C63.10:2013 on Radiated Emission test.

(5) The emissions from 9 kHz to 1GHz were measured based on CISPR QP detector except for the frequency bands 9-90 kHz, 110-490 kHz, for emissions from 9 kHz-90 kHz, 110 kHz-490 kHz and above 1GHz were measured based on average detector, for emissions above 1GHz, peak emissions also be measured and need comply with Peak limit.

(6) The emissions from 9 kHz to 1GHz, QP or average values were measured with EMI receiver with below RBW.

Frequency band	RBW
9 kHz-150 kHz	200Hz
150 kHz-30MHz	9 kHz
30MHz-1GHz	120 kHz

(7) For emissions above 1GHz, both Peak and Average level were measured with Spectrum Analyzer, and the RBW is set at 1MHz, VBW is set at 3MHz for Peak measure; According ANSI C63.10:2013 clause 4.1.4.2.2 procedure for average measure.

(8) X axis, Y axis, Z axis are tested if applicable, and the worst setup is reported.

11.4. Test result

Pass. (See below detailed test result)

All the emissions except fundamental emission from 9 kHz to 25GHz were comply with 15.209 limits.

Note1: According exploratory test, the emission levels are 20 dB below the limit detected from 9kHz to 30MHz and 18GHz to 25GHz, so the final test was performed with frequency range from 30MHz to 18 GHz and recorded in below.

Note2: For emissions below 1GHz, according exploratory explorer test, when change Tx mode and channel, have no distinct influence on emissions level, so for emissions below 1GHz, the final test was only performed with EUT working in GFSK, Tx 2441MHz mode.

Note3: For emissions above 1GHz. If peak results comply with AV limit, AV Result is deemed to comply with AV limit.

Radiated Emission test (below 1GHz)

TR-4-E-009 Radiated Emission Test Result

Test Site : DDT 3m Chamber 3# D:\2021 report data\Q21091611-2E TBD\FCC BELOW 1G\FCC BELOW 1G_00001.EMI
Test Date : 2022-01-11 **Tested By** : Kennys Zhang
EUT : SOLAR RECHARGEABLE OUTDOOR SPEAKER WITH MULTI-SYNC **Model Number** : SOLAR SOUNDS
Power Supply : Battery **Test Mode** : TX Mode
Condition : Temp:23.2°,Humi:45.8%,Press:100.3kPa **Antenna/Distance** : VLAB 9163 3#/3m/HORIZONTAL
Memo : BT

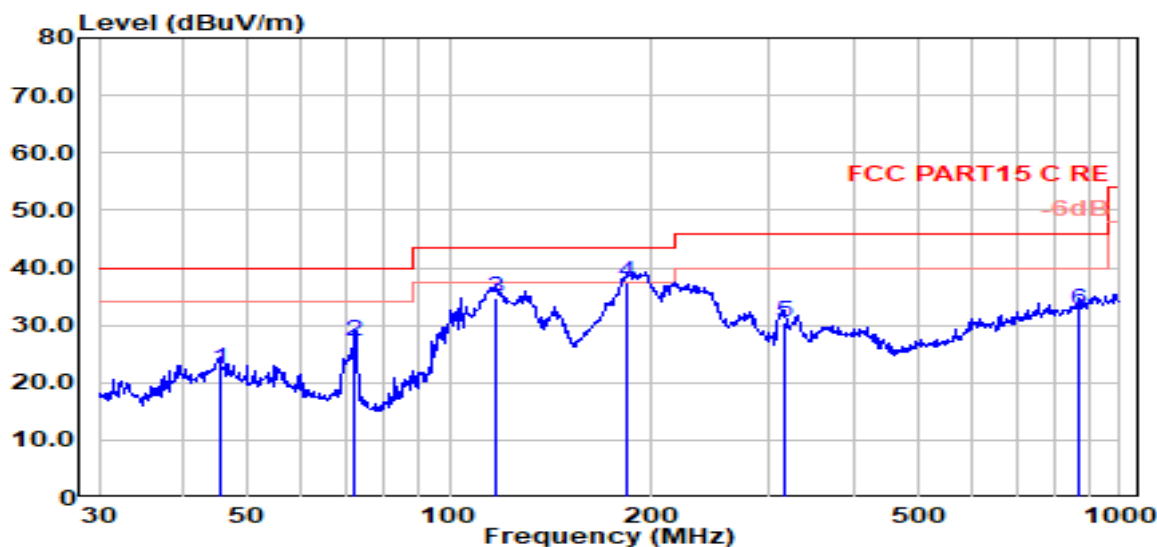

Item (Mark)	Freq. (MHz)	Read Level (dBuV)	Antenna Factor (dB/m)	Cable Loss (dB)	Result Level (dBuV/m)	Limit Line (dBuV/m)	Over Limit (dB)	Detector	Polarization
1	45.38	3.82	14.91	3.62	22.36	40.00	-17.64	QP	HORIZONTAL
2	72.08	14.51	8.89	3.81	27.21	40.00	-12.79	QP	HORIZONTAL
3	117.36	21.46	9.26	4.06	34.78	43.50	-8.72	QP	HORIZONTAL
4	183.20	23.20	9.72	4.37	37.29	43.50	-6.21	QP	HORIZONTAL
5	316.59	12.07	13.63	4.87	30.58	46.00	-15.42	QP	HORIZONTAL
6	872.18	4.62	21.54	6.40	32.57	46.00	-13.43	QP	HORIZONTAL

Note:

1. Result Level = Read Level + Antenna Factor + Cable loss.
2. If Peak Result complies with QP limit, QP Result is deemed to comply with QP limit.
3. Test setup: RBW: 120 kHz, VBW: 300 kHz, Sweep time: auto

TR-4-E-009 Radiated Emission Test Result

Test Site : DDT 3m Chamber 3#

D:\2021 report data\Q21091611-2E TBD\FCC BELOW 1G\FCC BELOW 1G_00002.EMI

Test Date : 2022-01-11

Tested By : Kennys Zhang

EUT : SOLAR RECHARGEABLE OUTDOOR SPEAKER WITH MULTI-SYNC

Model Number : SOLAR SOUNDS

Power Supply : Battery

Test Mode : TX Mode

Condition : Temp:23.2°,Humi:45.8%,Press:100.3kPa **Antenna/Distance** : VLAB 9163 3#/3m/VERTICAL

Memo : BT

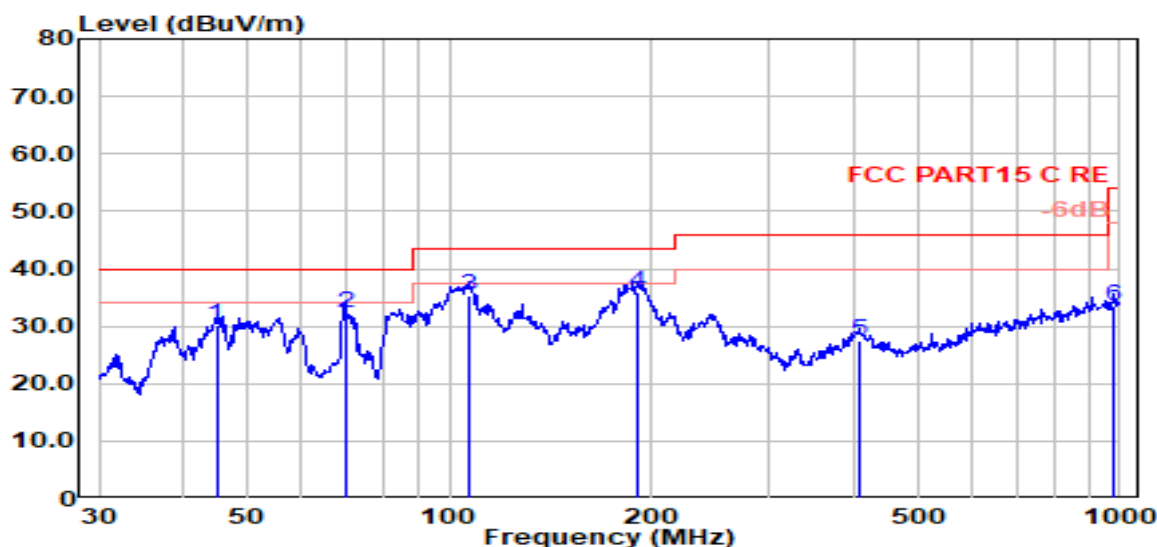

Item (Mark)	Freq. (MHz)	Read Level (dBμV)	Antenna Factor (dB/m)	Cable Loss (dB)	Result Level (dBUV/m)	Limit Line (dBUV/m)	Over Limit (dB)	Detector	Polarization
1	44.90	11.37	15.09	3.62	30.08	40.00	-9.92	QP	VERTICAL
2	69.84	19.64	9.00	3.79	32.43	40.00	-7.57	QP	VERTICAL
3	106.76	20.71	10.75	4.01	35.47	43.50	-8.03	QP	VERTICAL
4	191.07	20.54	10.91	4.41	35.87	43.50	-7.63	QP	VERTICAL
5	407.51	6.58	15.70	5.17	27.46	46.00	-18.54	QP	VERTICAL
6	979.18	4.62	22.30	6.73	33.65	54.00	-20.35	QP	VERTICAL

Note:

1. Result Level = Read Level + Antenna Factor + Cable loss.
2. If Peak Result complies with QP limit, QP Result is deemed to comply with QP limit.
3. Test setup: RBW: 120 kHz, VBW: 300 kHz, Sweep time: auto

Radiated Emission test (above 1GHz)

Freq. (MHz)	Read level (dB μ V)	ANT Factor (dB/m)	Cable Loss (dB)	PRM Factor (dB)	Result Level (dB μ V/m)	Limit (dB μ V/m)	Margin (dB)	Detector type	Polarization
Tx mode 2402MHz									
4804.00	53.54	32.47	5.36	40.36	51.02	74.00	-22.98	Peak	HORIZONTAL
7545.00	45.31	36.45	6.62	39.75	48.63	74.00	-25.37	Peak	HORIZONTAL
9602.00	44.96	38.64	7.38	40.32	50.66	74.00	-23.34	Peak	HORIZONTAL
12492.00	43.57	39.00	8.36	40.25	50.69	74.00	-23.31	Peak	HORIZONTAL
16130.00	41.97	37.90	9.40	39.93	49.34	74.00	-24.66	Peak	HORIZONTAL
17881.00	39.26	41.76	9.96	40.63	50.35	74.00	-23.65	Peak	HORIZONTAL
4791.00	47.89	32.43	5.36	40.36	45.32	74.00	-28.68	Peak	VERTICAL
6967.00	45.65	35.95	6.36	39.73	48.23	74.00	-25.77	Peak	VERTICAL
9602.00	44.86	38.64	7.38	40.32	50.56	74.00	-23.44	Peak	VERTICAL
11897.00	43.74	39.16	8.13	40.11	50.92	74.00	-23.08	Peak	VERTICAL
15756.00	41.61	38.34	9.29	39.83	49.41	74.00	-24.59	Peak	VERTICAL
17898.00	39.71	41.87	9.97	40.64	50.91	74.00	-23.09	Peak	VERTICAL
Tx mode 2441MHz									
4882.00	48.33	32.72	5.41	40.38	46.09	74.00	-27.91	Peak	HORIZONTAL
8174.00	44.39	37.28	6.90	39.82	48.75	74.00	-25.25	Peak	HORIZONTAL
10979.00	43.45	39.29	7.75	40.21	50.29	74.00	-23.71	Peak	HORIZONTAL
14022.00	42.59	39.90	9.01	39.70	51.81	74.00	-22.19	Peak	HORIZONTAL
16045.00	42.05	37.90	9.37	39.91	49.42	74.00	-24.58	Peak	HORIZONTAL
17864.00	39.91	41.66	9.96	40.62	50.91	74.00	-23.09	Peak	HORIZONTAL
5080.00	46.39	33.05	5.53	40.41	44.56	74.00	-29.44	Peak	VERTICAL
7647.00	45.22	36.58	6.67	39.76	48.70	74.00	-25.30	Peak	VERTICAL
9772.00	44.91	38.54	7.43	40.44	50.44	74.00	-23.56	Peak	VERTICAL
12118.00	43.30	39.15	8.22	40.14	50.54	74.00	-23.46	Peak	VERTICAL
14668.00	42.16	39.77	9.06	39.63	51.35	74.00	-22.65	Peak	VERTICAL
17864.00	39.60	41.66	9.96	40.62	50.60	74.00	-23.40	Peak	VERTICAL
Tx mode 2480MHz									
5063.00	45.52	33.06	5.52	40.41	43.70	74.00	-30.30	Peak	HORIZONTAL
7885.00	44.71	36.86	6.78	39.79	48.57	74.00	-25.43	Peak	HORIZONTAL
10605.00	43.37	39.06	7.65	40.36	49.73	74.00	-24.27	Peak	HORIZONTAL
13648.00	42.24	39.97	8.85	39.95	51.11	74.00	-22.89	Peak	HORIZONTAL
15705.00	41.48	38.43	9.28	39.81	49.38	74.00	-24.62	Peak	HORIZONTAL
17864.00	40.10	41.66	9.96	40.62	51.10	74.00	-22.90	Peak	HORIZONTAL
4825.00	46.41	32.54	5.38	40.37	43.96	74.00	-30.04	Peak	VERTICAL
7596.00	45.05	36.52	6.64	39.76	48.45	74.00	-25.55	Peak	VERTICAL
10044.00	43.49	38.45	7.50	40.58	48.86	74.00	-25.14	Peak	VERTICAL
12339.00	42.19	39.06	8.30	40.20	49.36	74.00	-24.64	Peak	VERTICAL
14855.00	41.05	39.62	9.07	39.61	50.12	74.00	-23.88	Peak	VERTICAL
17847.00	39.81	41.55	9.95	40.61	50.71	74.00	-23.29	Peak	VERTICAL
Verdict: Pass									

Note: 1. 30MHz~25GHz: (Scan with all mode GFSK, $\pi/4$ -DQPSK, 8DPSK, the worst case is GFSK Mode)

2. Result Level = Read Level + Antenna Factor + Cable loss - PRM Factor.

3. For emissions above 1GHz. If peak results comply with AV limit, AV Result is deemed to comply with AV limit.

12. Band Edge Compliance (Radiated Method)

12.1. Block diagram of test setup

In 3m Anechoic Chamber, test setup diagram for frequency above 1GHz:

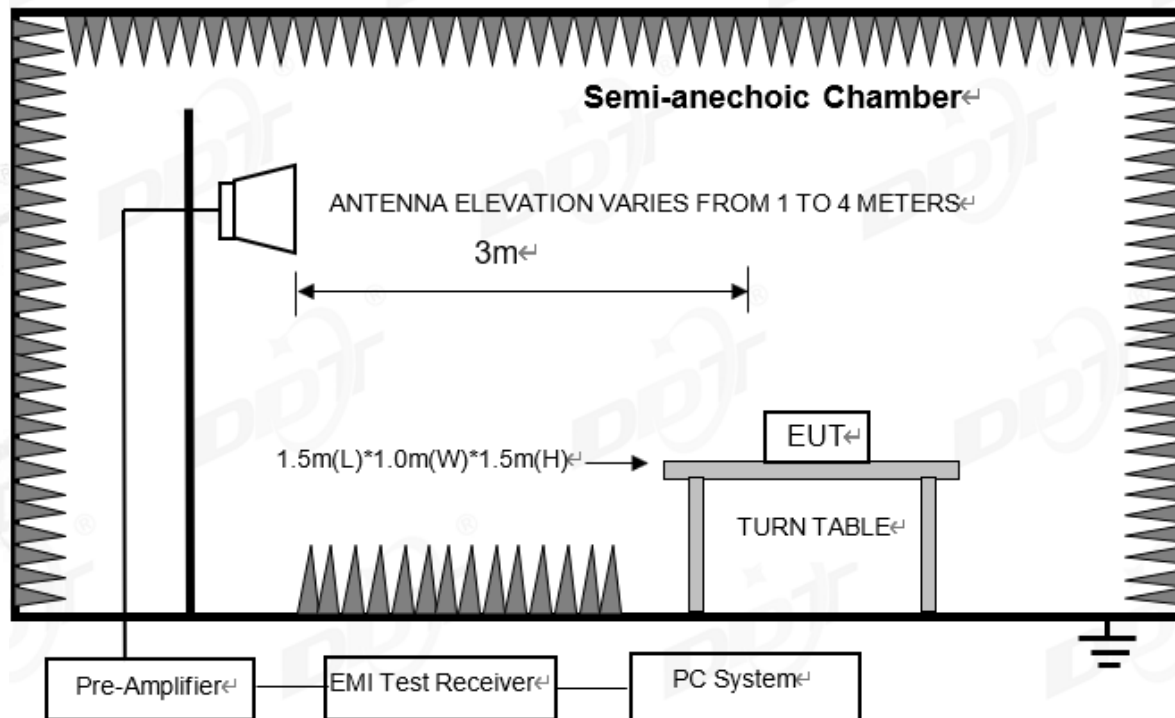

12.2. Limit

All restriction band should comply with 15.209, other emission should be at least 20dB below the fundamental.

12.3. Test procedure

- Same with clause 10.3 except change investigated frequency range from 2310MHz to 2410 MHz and 2475MHz to 2500MHz.

Remark: All restriction band have been tested, and only the worst case is shown in report.

12.4. Test result

Pass. (See below detailed test result)

Remark: hopping on and hopping off mode all have been test, hopping off mode is worse and reported only.

TR-4-E-009 Radiated Emission Test Result

Test Site : DDT 3m Chamber 3#

D:\2021 report data\Q21091611-2E TBD\FCC ABOVE
1G new\FCC ABOVE 1G_00003.EMI

Test Date : 2022-01-07

Tested By : James Gan

EUT : SOLAR RECHARGEABLE OUTDOOR
SPEAKER WITH MULTI-SYNC

Model Number : SOLAR SOUNDS

Power Supply : Battery

Test Mode : TX Mode

Condition : Temp:23.2°,Humi:45.8%,Press:100.3kPa **Antenna/Distance** : 2021 BBHA 9120D 3#
NEW/3m/HORIZONTAL

Memo : DH5 2402

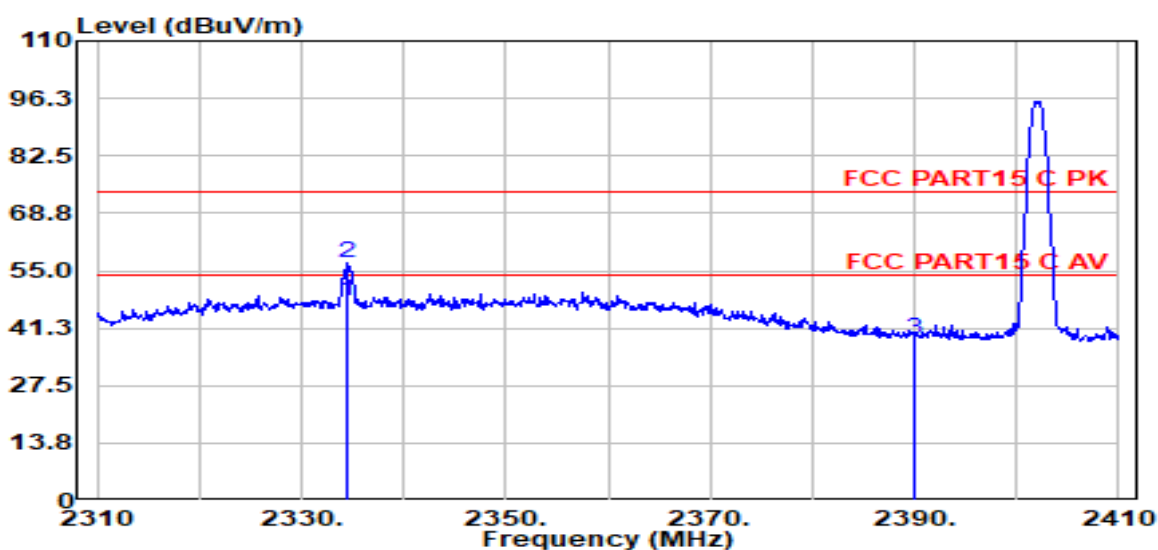

Item (Mark)	Freq. (MHz)	Read Level (dBUV)	Antenna Factor (dB/m)	Cable Loss (dB)	PRM Factor (dB)	Result Level (dBUV/m)	Limit Line (dBUV/m)	Over Limit (dB)	Detector	Polarization
1	2334.50	56.48	27.30	3.68	39.57	47.90	54.00	-6.10	Average	HORIZONTAL
2	2334.50	65.53	27.30	3.68	39.57	56.95	74.00	-17.05	Peak	HORIZONTAL
3	2390.00	47.17	27.40	3.73	39.60	38.70	74.00	-35.30	Peak	HORIZONTAL

Note:

1. Result Level = Read Level + Antenna Factor + Cable loss - PRM Factor.
2. If Peak Result complies with AV limit, AV Result is deemed to comply with AV limit.
3. Test setup: RBW: 1 MHz, VBW: 3 MHz, Sweep time: auto.

TR-4-E-009 Radiated Emission Test Result

Test Site : DDT 3m Chamber 3# D:\2021 report data\Q21091611-2E TBD\FCC ABOVE 1G new\FCC ABOVE 1G_00004.EMI
Test Date : 2022-01-07 **Tested By** : James Gan
EUT : SOLAR RECHARGEABLE OUTDOOR SPEAKER WITH MULTI-SYNC **Model Number** : SOLAR SOUNDS
Power Supply : Battery **Test Mode** : TX Mode
Condition : Temp:23.2°,Humi:45.8%,Press:100.3kPa **Antenna/Distance** : 2021 BBHA 9120D 3# NEW/3m/VERTICAL
Memo : DH5 2402

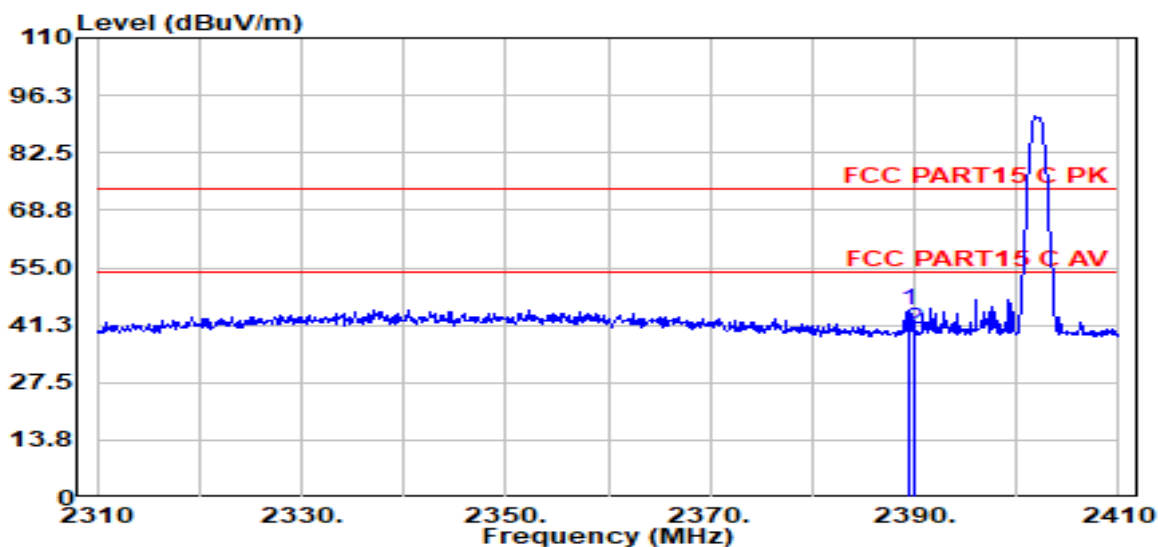

Item (Mark)	Freq. (MHz)	Read Level (dBµV)	Antenna Factor (dB/m)	Cable Loss (dB)	PRM Factor (dB)	Result Level (dBUV/m)	Limit Line (dBUV/m)	Over Limit (dB)	Detector	Polarization
1	2389.50	53.49	27.40	3.73	39.59	45.02	74.00	-28.98	Peak	VERTICAL
2	2390.00	48.87	27.40	3.73	39.60	40.41	74.00	-33.59	Peak	VERTICAL

Note:

1. Result Level = Read Level + Antenna Factor + Cable loss - PRM Factor.
2. If Peak Result complies with AV limit, AV Result is deemed to comply with AV limit.
3. Test setup: RBW: 1 MHz, VBW: 3 MHz, Sweep time: auto.

TR-4-E-009 Radiated Emission Test Result

Test Site : DDT 3m Chamber 3#

D:\2021 report data\Q21091611-2E TBD\FCC ABOVE
1G new\FCC ABOVE 1G_00005.EMI

Test Date : 2022-01-07

Tested By : James Gan

EUT : SOLAR RECHARGEABLE OUTDOOR
SPEAKER WITH MULTI-SYNC

Model Number : SOLAR SOUNDS

Power Supply : Battery

Test Mode : TX Mode

Condition : Temp:23.2°,Humi:45.8%,Press:100.3kPa

Antenna/Distance : 2021 BBHA 9120D 3#
NEW/3m/HORIZONTAL

Memo : DH5 2480

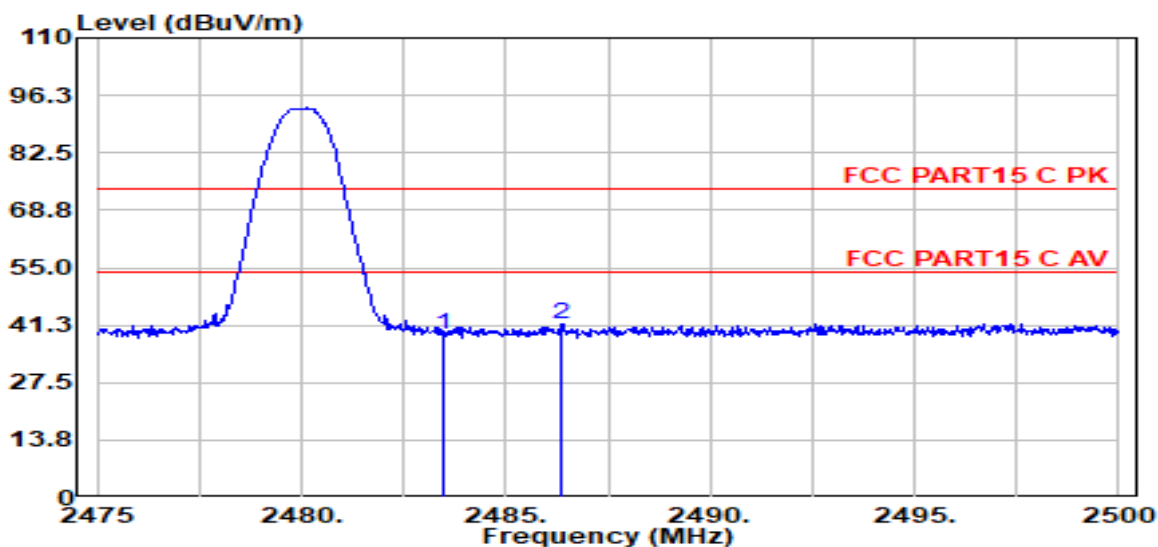

Item (Mark)	Freq. (MHz)	Read Level (dBUV)	Antenna Factor (dB/m)	Cable Loss (dB)	PRM Factor (dB)	Result Level (dBUV/m)	Limit Line (dBUV/m)	Over Limit (dB)	Detector	Polarization
1	2483.50	47.22	27.57	3.81	39.64	38.96	74.00	-35.04	Peak	HORIZONTAL
2	2486.33	49.97	27.58	3.81	39.64	41.71	74.00	-32.29	Peak	HORIZONTAL

Note:

1. Result Level = Read Level + Antenna Factor + Cable loss - PRM Factor.
2. If Peak Result complies with AV limit, AV Result is deemed to comply with AV limit.
3. Test setup: RBW: 1 MHz, VBW: 3 MHz, Sweep time: auto.

TR-4-E-009 Radiated Emission Test Result

Test Site : DDT 3m Chamber 3# D:\2021 report data\Q21091611-2E TBD\FCC ABOVE 1G new\FCC ABOVE 1G_00006.EMI
Test Date : 2022-01-07 **Tested By** : James Gan
EUT : SOLAR RECHARGEABLE OUTDOOR SPEAKER WITH MULTI-SYNC **Model Number** : SOLAR SOUNDS
Power Supply : Battery **Test Mode** : TX Mode
Condition : Temp:23.2°,Humi:45.8%,Press:100.3kPa **Antenna/Distance** : 2021 BBHA 9120D 3# NEW/3m/VERTICAL
Memo : DH5 2480

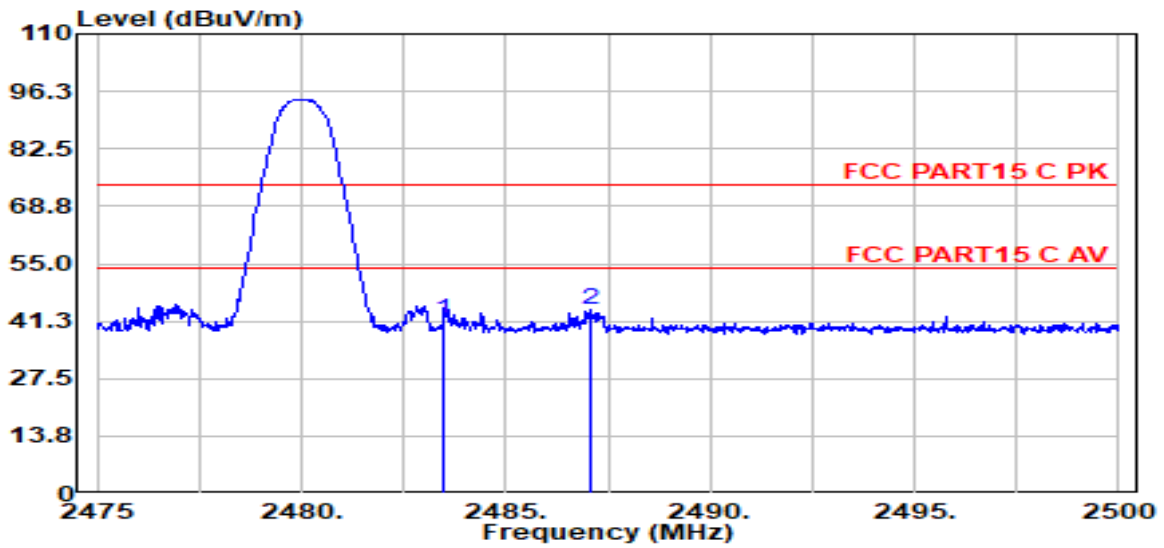

Item (Mark)	Freq. (MHz)	Read Level (dBµV)	Antenna Factor (dB/m)	Cable Loss (dB)	PRM Factor (dB)	Result Level (dBµV/m)	Limit Line (dBµV/m)	Over Limit (dB)	Detector	Polarization
1	2483.50	49.83	27.57	3.81	39.64	41.57	74.00	-32.43	Peak	VERTICAL
2	2487.08	52.31	27.58	3.81	39.64	44.05	74.00	-29.95	Peak	VERTICAL

Note:

1. Result Level = Read Level + Antenna Factor + Cable loss - PRM Factor.
2. If Peak Result complies with AV limit, AV Result is deemed to comply with AV limit.
3. Test setup: RBW: 1 MHz, VBW: 3 MHz, Sweep time: auto.

TR-4-E-009 Radiated Emission Test Result

Test Site : DDT 3m Chamber 3# D:\2021 report data\Q21091611-2E TBD\FCC ABOVE 1G new\FCC ABOVE 1G_00007.EMI
Test Date : 2022-01-07 **Tested By** : James Gan
EUT : SOLAR RECHARGEABLE OUTDOOR SPEAKER WITH MULTI-SYNC **Model Number** : SOLAR SOUNDS
Power Supply : Battery **Test Mode** : TX Mode
Condition : Temp:23.2°,Humi:45.8%,Press:100.3kPa **Antenna/Distance** : 2021 BBHA 9120D 3# NEW/3m/HORIZONTAL
Memo : 2DH5 2402

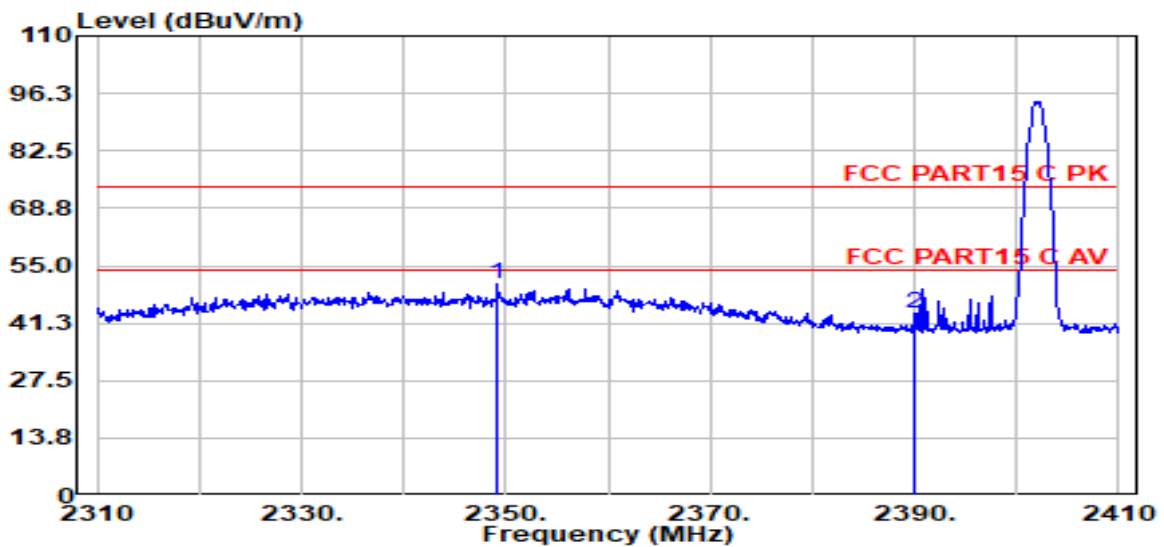

Item (Mark)	Freq. (MHz)	Read Level (dBμV)	Antenna Factor (dB/m)	Cable Loss (dB)	PRM Factor (dB)	Result Level (dBUV/m)	Limit Line (dBUV/m)	Over Limit (dB)	Detector	Polarization
1	2349.20	59.22	27.33	3.69	39.57	50.67	74.00	-23.33	Peak	HORIZONTAL
2	2390.00	51.98	27.40	3.73	39.60	43.51	74.00	-30.49	Peak	HORIZONTAL

Note:

1. Result Level = Read Level + Antenna Factor + Cable loss - PRM Factor.
2. If Peak Result complies with AV limit, AV Result is deemed to comply with AV limit.
3. Test setup: RBW: 1 MHz, VBW: 3 MHz, Sweep time: auto.

TR-4-E-009 Radiated Emission Test Result

Test Site : DDT 3m Chamber 3#

D:\2021 report data\Q21091611-2E TBD\FCC ABOVE
1G new\FCC ABOVE 1G_00008.EMI

Test Date : 2022-01-07

Tested By : James Gan

EUT : SOLAR RECHARGEABLE OUTDOOR
SPEAKER WITH MULTI-SYNC

Model Number : SOLAR SOUNDS

Power Supply : Battery

Test Mode : TX Mode

Condition : Temp:23.2°,Humi:45.8%,Press:100.3kPa **Antenna/Distance** : 2021 BBHA 9120D 3#
NEW/3m/VERTICAL

Memo : 2DH5 2402

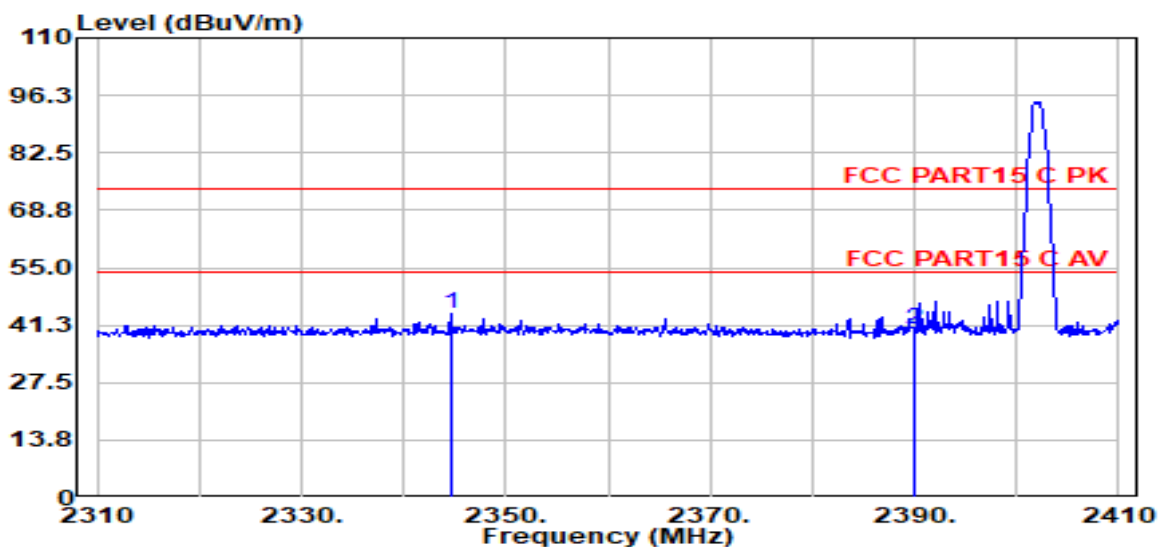

Item (Mark)	Freq. (MHz)	Read Level (dBµV)	Antenna Factor (dB/m)	Cable Loss (dB)	PRM Factor (dB)	Result Level (dBUV/m)	Limit Line (dBUV/m)	Over Limit (dB)	Detector	Polarization
1	2344.60	52.74	27.32	3.69	39.57	44.18	74.00	-29.82	Peak	VERTICAL
2	2390.00	48.66	27.40	3.73	39.60	40.20	74.00	-33.80	Peak	VERTICAL

Note:

1. Result Level = Read Level + Antenna Factor + Cable loss - PRM Factor.
2. If Peak Result complies with AV limit, AV Result is deemed to comply with AV limit.
3. Test setup: RBW: 1 MHz, VBW: 3 MHz, Sweep time: auto.

TR-4-E-009 Radiated Emission Test Result

Test Site : DDT 3m Chamber 3#

D:\2021 report data\Q21091611-2E TBD\FCC ABOVE
1G new\FCC ABOVE 1G_00009.EMI

Test Date : 2022-01-07

Tested By : James Gan

EUT : SOLAR RECHARGEABLE OUTDOOR
SPEAKER WITH MULTI-SYNC

Model Number : SOLAR SOUNDS

Power Supply : Battery

Test Mode : TX Mode

Condition : Temp:23.2°,Humi:45.8%,Press:100.3kPa **Antenna/Distance** : 2021 BBHA 9120D 3#
NEW/3m/HORIZONTAL

Memo : 2DH5 2480

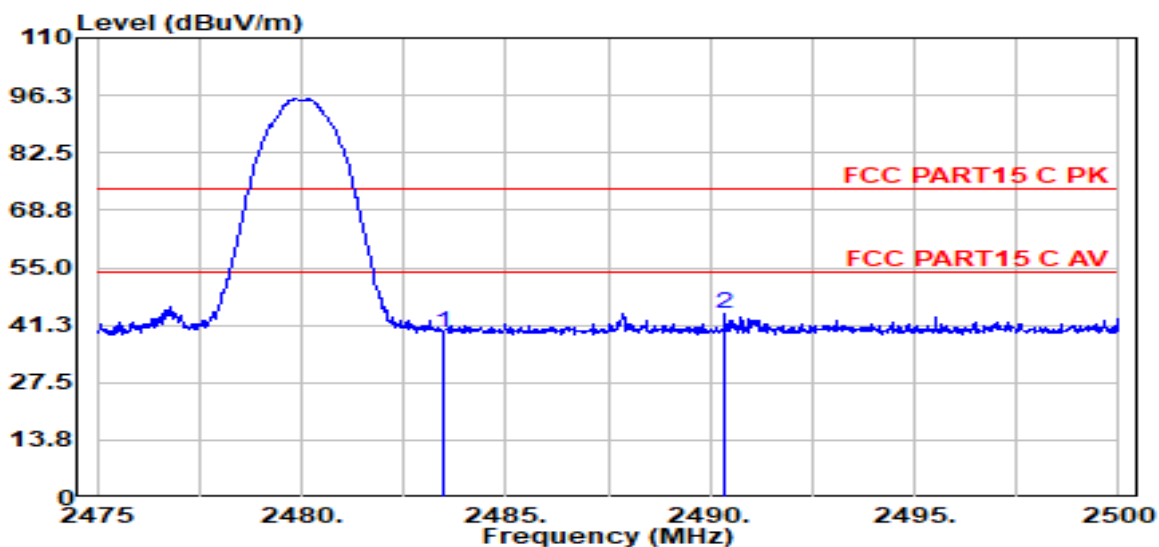

Item (Mark)	Freq. (MHz)	Read Level (dBμV)	Antenna Factor (dB/m)	Cable Loss (dB)	PRM Factor (dB)	Result Level (dBμV/m)	Limit Line (dBμV/m)	Over Limit (dB)	Detector	Polarization
1	2483.50	47.52	27.57	3.81	39.64	39.25	74.00	-34.75	Peak	HORIZONTAL
2	2490.38	52.16	27.58	3.81	39.65	43.91	74.00	-30.09	Peak	HORIZONTAL

Note:

1. Result Level = Read Level + Antenna Factor + Cable loss - PRM Factor.
2. If Peak Result complies with AV limit, AV Result is deemed to comply with AV limit.
3. Test setup: RBW: 1 MHz, VBW: 3 MHz, Sweep time: auto.

TR-4-E-009 Radiated Emission Test Result

Test Site : DDT 3m Chamber 3#

D:\2021 report data\Q21091611-2E TBD\FCC ABOVE
1G new\FCC ABOVE 1G_00010.EMI

Test Date : 2022-01-07

Tested By : James Gan

EUT : SOLAR RECHARGEABLE OUTDOOR
SPEAKER WITH MULTI-SYNC

Model Number : SOLAR SOUNDS

Power Supply : Battery

Test Mode : TX Mode

Condition : Temp:23.2°,Humi:45.8%,Press:100.3kPa

Antenna/Distance : 2021 BBHA 9120D 3#
NEW/3m/VERTICAL

Memo : 2DH5 2480

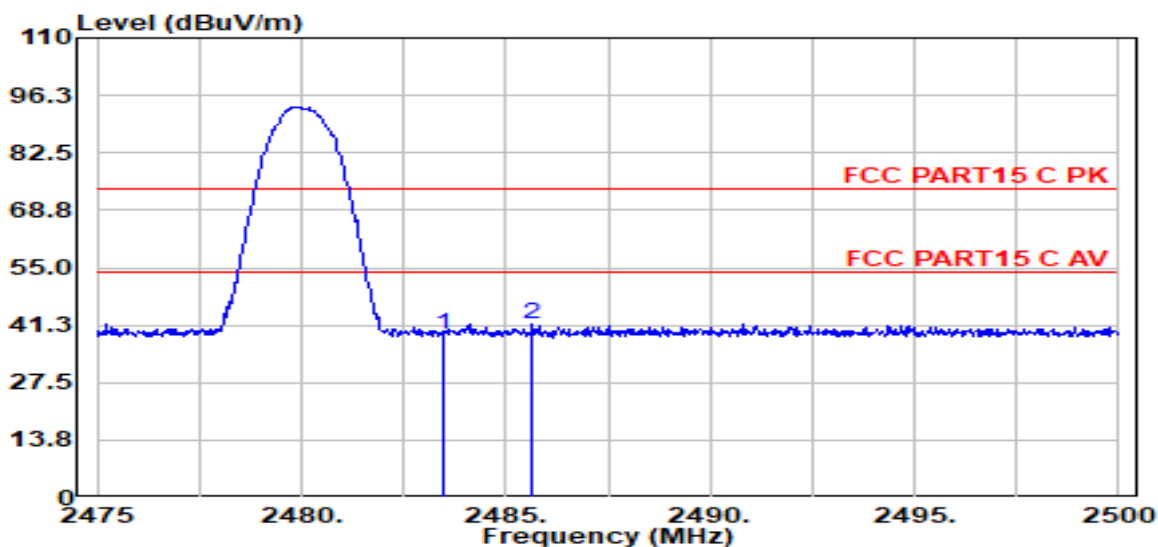

Item (Mark)	Freq. (MHz)	Read Level (dBµV)	Antenna Factor (dB/m)	Cable Loss (dB)	PRM Factor (dB)	Result Level (dBUV/m)	Limit Line (dBUV/m)	Over Limit (dB)	Detector	Polarization
1	2483.50	47.44	27.57	3.81	39.64	39.17	74.00	-34.83	Peak	VERTICAL
2	2485.65	49.88	27.57	3.81	39.64	41.62	74.00	-32.38	Peak	VERTICAL

Note:

1. Result Level = Read Level + Antenna Factor + Cable loss - PRM Factor.
2. If Peak Result complies with AV limit, AV Result is deemed to comply with AV limit.
3. Test setup: RBW: 1 MHz, VBW: 3 MHz, Sweep time: auto.

TR-4-E-009 Radiated Emission Test Result

Test Site : DDT 3m Chamber 3#

D:\2021 report data\Q21091611-2E TBD\FCC ABOVE
1G new\FCC ABOVE 1G_00011.EMI

Test Date : 2022-01-07

Tested By : James Gan

EUT : SOLAR RECHARGEABLE OUTDOOR
SPEAKER WITH MULTI-SYNC

Model Number : SOLAR SOUNDS

Power Supply : Battery

Test Mode : TX Mode

Condition : Temp:23.2°,Humi:45.8%,Press:100.3kPa

Antenna/Distance : 2021 BBHA 9120D 3#
NEW/3m/HORIZONTAL

Memo : 3DH5 2402

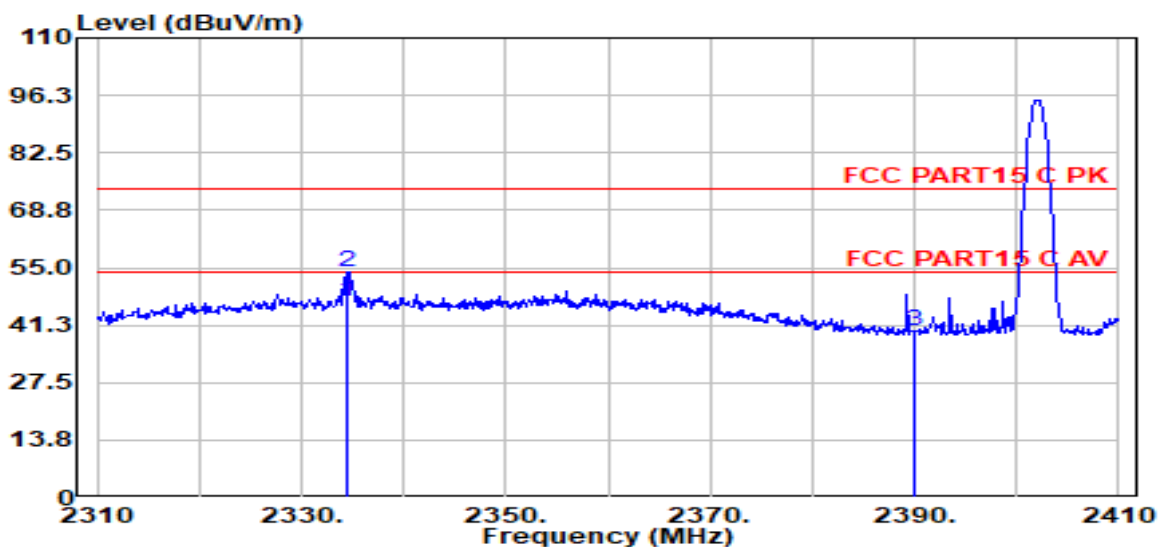

Item (Mark)	Freq. (MHz)	Read Level (dBuV)	Antenna Factor (dB/m)	Cable Loss (dB)	PRM Factor (dB)	Result Level (dBuV/m)	Limit Line (dBuV/m)	Over Limit (dB)	Detector	Polarization
1	2334.50	55.48	27.30	3.68	39.57	46.90	54.00	-7.10	Average	HORIZONTAL
2	2334.50	62.50	27.30	3.68	39.57	53.91	74.00	-20.09	Peak	HORIZONTAL
3	2390.00	48.52	27.40	3.73	39.60	40.06	74.00	-33.94	Peak	HORIZONTAL

Note:

1. Result Level = Read Level + Antenna Factor + Cable loss - PRM Factor.
2. If Peak Result complies with AV limit, AV Result is deemed to comply with AV limit.
3. Test setup: RBW: 1 MHz, VBW: 3 MHz, Sweep time: auto.

TR-4-E-009 Radiated Emission Test Result

Test Site : DDT 3m Chamber 3# D:\2021 report data\Q21091611-2E TBD\FCC ABOVE 1G new\FCC ABOVE 1G_00012.EMI
Test Date : 2022-01-07 **Tested By** : James Gan
EUT : SOLAR RECHARGEABLE OUTDOOR SPEAKER WITH MULTI-SYNC **Model Number** : SOLAR SOUNDS
Power Supply : Battery **Test Mode** : TX Mode
Condition : Temp:23.2°,Humi:45.8%,Press:100.3kPa **Antenna/Distance** : 2021 BBHA 9120D 3# NEW/3m/VERTICAL
Memo : 3DH5 2402

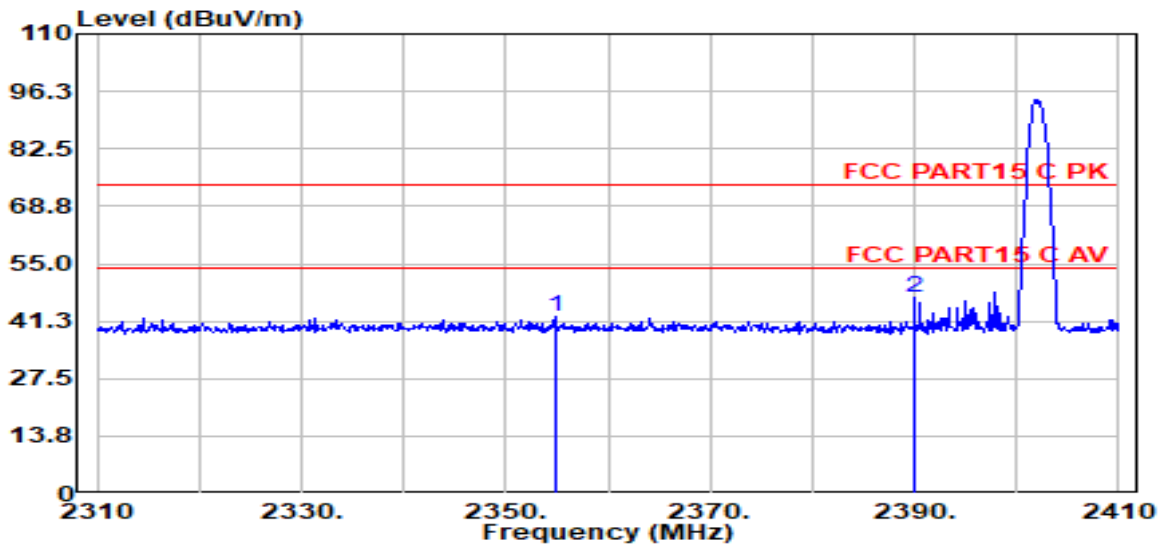

Item (Mark)	Freq. (MHz)	Read Level (dBµV)	Antenna Factor (dB/m)	Cable Loss (dB)	PRM Factor (dB)	Result Level (dBµV/m)	Limit Line (dBµV/m)	Over Limit (dB)	Detector	Polarization
1	2354.90	50.94	27.34	3.70	39.58	42.40	74.00	-31.60	Peak	VERTICAL
2	2390.00	55.48	27.40	3.73	39.60	47.01	74.00	-26.99	Peak	VERTICAL

Note:

1. Result Level = Read Level + Antenna Factor + Cable loss - PRM Factor.
2. If Peak Result complies with AV limit, AV Result is deemed to comply with AV limit.
3. Test setup: RBW: 1 MHz, VBW: 3 MHz, Sweep time: auto.

TR-4-E-009 Radiated Emission Test Result

Test Site : DDT 3m Chamber 3#

D:\2021 report data\Q21091611-2E TBD\FCC ABOVE 1G new\FCC ABOVE 1G_00013.EMI

Test Date : 2022-01-07

Tested By : James Gan

EUT : SOLAR RECHARGEABLE OUTDOOR SPEAKER WITH MULTI-SYNC

Model Number : SOLAR SOUNDS

Power Supply : Battery

Test Mode : TX Mode

Condition : Temp:23.2°,Humi:45.8%,Press:100.3kPa **Antenna/Distance** : 2021 BBHA 9120D 3# NEW/3m/HORIZONTAL

Memo : 3DH5 2480

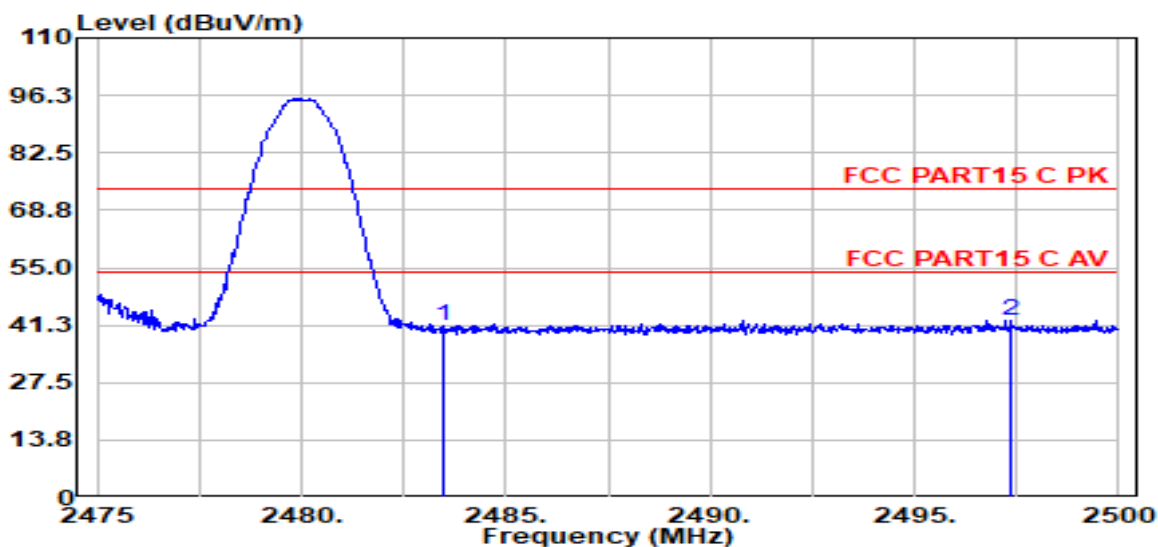

Item (Mark)	Freq. (MHz)	Read Level (dBUV)	Antenna Factor (dB/m)	Cable Loss (dB)	PRM Factor (dB)	Result Level (dBUV/m)	Limit Line (dBUV/m)	Over Limit (dB)	Detector	Polarization
1	2483.50	49.24	27.57	3.81	39.64	40.98	74.00	-33.02	Peak	HORIZONTAL
2	2497.38	50.56	27.60	3.82	39.65	42.32	74.00	-31.68	Peak	HORIZONTAL

Note:

1. Result Level = Read Level + Antenna Factor + Cable loss - PRM Factor.
2. If Peak Result complies with AV limit, AV Result is deemed to comply with AV limit.
3. Test setup: RBW: 1 MHz, VBW: 3 MHz, Sweep time: auto.

TR-4-E-009 Radiated Emission Test Result

Test Site : DDT 3m Chamber 3#

D:\2021 report data\Q21091611-2E TBD\FCC ABOVE
1G new\FCC ABOVE 1G_00014.EMI

Test Date : 2022-01-07

Tested By : James Gan

EUT : SOLAR RECHARGEABLE OUTDOOR
SPEAKER WITH MULTI-SYNC

Model Number : SOLAR SOUNDS

Power Supply : Battery

Test Mode : TX Mode

Condition : Temp:23.2°,Humi:45.8%,Press:100.3kPa **Antenna/Distance** : 2021 BBHA 9120D 3#
NEW/3m/VERTICAL

Memo : 3DH5 2480

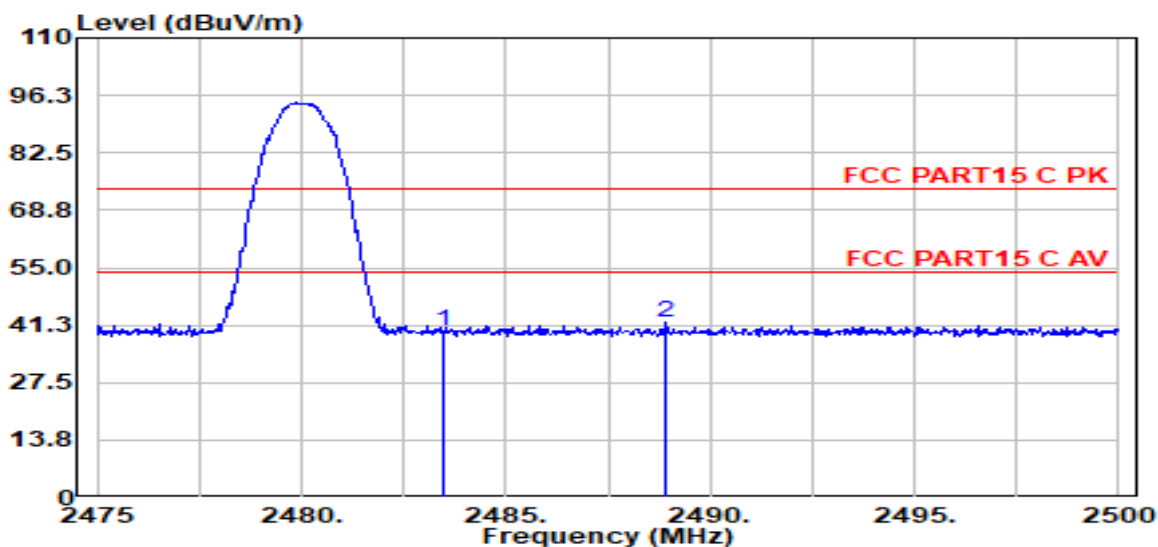

Item (Mark)	Freq. (MHz)	Read Level (dBuV)	Antenna Factor (dB/m)	Cable Loss (dB)	PRM Factor (dB)	Result Level (dBuV/m)	Limit Line (dBuV/m)	Over Limit (dB)	Detector	Polarization
1	2483.50	48.06	27.57	3.81	39.64	39.80	74.00	-34.20	Peak	VERTICAL
2	2488.90	50.17	27.58	3.81	39.64	41.92	74.00	-32.08	Peak	VERTICAL

Note:

1. Result Level = Read Level + Antenna Factor + Cable loss - PRM Factor.
2. If Peak Result complies with AV limit, AV Result is deemed to comply with AV limit.
3. Test setup: RBW: 1 MHz, VBW: 3 MHz, Sweep time: auto.

13. Power Line Conducted Emission

13.1. Block diagram of test setup

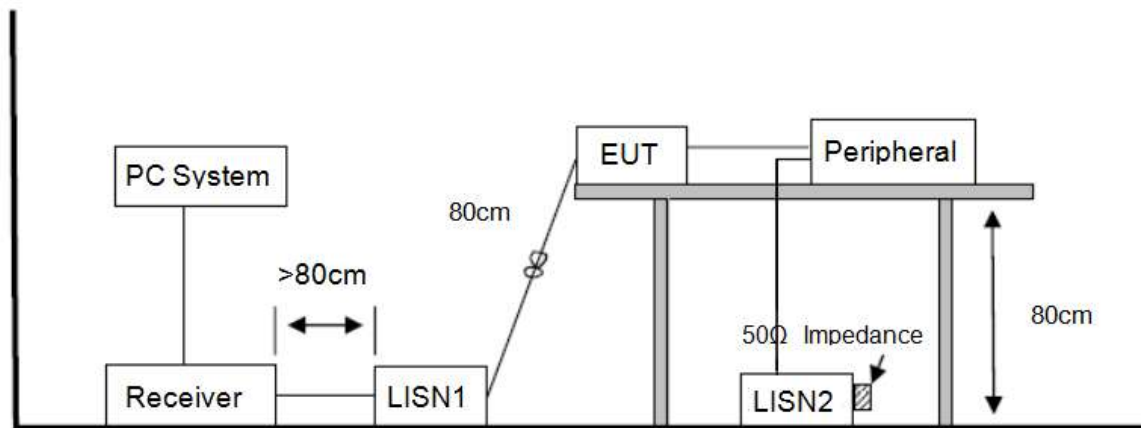

13.2. Power line conducted emission limits

Frequency	Quasi-Peak Level dB(μV)	Average Level dB(μV)
150kHz ~ 500kHz	66 ~ 56*	56 ~ 46*
500kHz ~ 5MHz	56	46
5MHz ~ 30MHz	60	50

Note 1: * Decreasing linearly with logarithm of frequency.

Note 2: The lower limit shall apply at the transition frequencies.

13.3. Test procedure

The EUT and Support equipment, if needed, were put placed on a non-metallic table, 80cm above the ground plane.

Configuration EUT to simulate typical usage as described in clause 2.4 and test equipment as described in clause 10.2 of this report.

All I/O cables were positioned to simulate typical actual usage as per ANSI C63.10.

All support equipment power received from a second LISN.

Emissions were measured on each current carrying line of the EUT using an EMI Test Receiver connected to the LISN powering the EUT.

The Receiver scanned from 150 kHz to 30MHz for emissions in each of the test modes.

During the above scans, the emissions were maximized by cable manipulation.

The test mode(s) described in clause 2.4 were scanned during the preliminary test.

After the preliminary scan, we found the test mode producing the highest emission level.

The EUT configuration and worse cable configuration of the above highest emission levels were recorded for reference of the final test.

EUT and support equipment were set up on the test bench as per the configuration with highest emission level in the preliminary test.

A scan was taken on both power lines, Neutral and Line, recording at least the six highest emissions.

Emission frequency and amplitude were recorded into a computer in which correction factors were used to calculate the emission level and compare reading to the applicable limit.

The test data of the worst-case condition(s) was recorded.

The bandwidth of test receiver is set at 9 kHz.

13.4. Test result

Pass. (See below detailed test result)

Note1: All emissions not reported below are too low against the prescribed limits.

Note2: “-----” means Peak detection; “-----” means Average detection.

Note3: Pre-test AC conducted emission at both voltage AC 120V/60Hz and AC 240V/50Hz, recorded worse case.

TR-4-E-010 Conducted Emission Test Result

Test Site : DDT 5# Shield Room D:\2021 report data\Q21091611-2E\FCC-CE.EM6
Test Date : 2022-01-12 **Tested By** : Kennys Zhang
EUT : SOLAR RECHARGEABLE OUTDOOR **Model Number** : SOLAR SOUNDS
 : SPEAKER WITH MULTI-SYNC **Test Mode** : TX Mode
Power Supply : AC 120V 60Hz **LISN** : 2021 ENV 216 3#/NEUTRAL
Condition : Temp:23.0°C,Humi:45.8%,Press:101.4kPa
Memo : BT

Data: 2

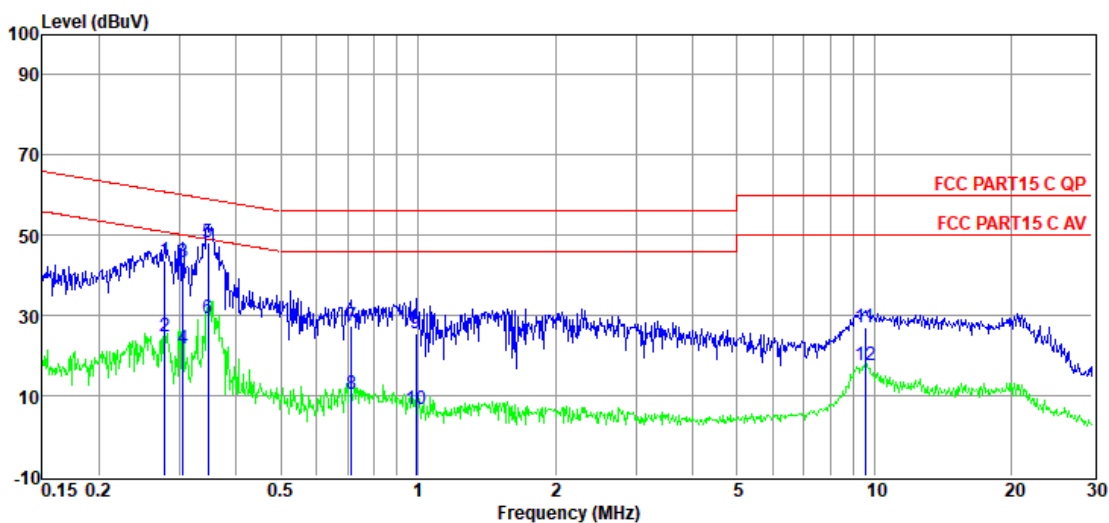

Item (Mark)	Freq. (MHz)	Read Level (dBuV)	LISN Factor (dB)	Cable Loss (dB)	Result Level (dBuV)	Limit Line (dBuV)	Over Limit (dB)	Detector	Phase
1	0.28	24.50	9.33	9.83	43.66	60.85	-17.19	QP	NEUTRAL
2	0.28	5.47	9.33	9.83	24.63	50.85	-26.22	Average	NEUTRAL
3	0.31	24.23	9.31	9.83	43.37	60.10	-16.73	QP	NEUTRAL
4	0.31	2.49	9.31	9.83	21.63	50.10	-28.47	Average	NEUTRAL
5	0.35	28.93	9.28	9.84	48.05	59.05	-11.00	QP	NEUTRAL
6	0.35	10.17	9.28	9.84	29.29	49.05	-19.76	Average	NEUTRAL
7	0.72	8.26	9.22	9.84	27.32	56.00	-28.68	QP	NEUTRAL
8	0.72	-8.58	9.22	9.84	10.48	46.00	-35.52	Average	NEUTRAL
9	0.99	6.13	9.49	9.85	25.47	56.00	-30.53	QP	NEUTRAL
10	0.99	-12.77	9.49	9.85	6.57	46.00	-39.43	Average	NEUTRAL
11	9.55	7.61	9.40	9.95	26.96	60.00	-33.04	QP	NEUTRAL
12	9.55	-1.86	9.40	9.95	17.49	50.00	-32.51	Average	NEUTRAL

- Note: 1. Result Level = Read Level +LISN Factor + Cable loss.
 2. If QP Result complies with AV limit, AV Result is deemed to comply with AV limit.
 3. Test setup: RBW: 200 Hz (9 kHz—150 kHz), 9 kHz (150 kHz—30 MHz).
 4. Step size: 80Hz (0.009MHz-0.15MHz), 4 kHz (0.15MHz-30MHz), Scan time: auto.

TR-4-E-010 Conducted Emission Test Result

Test Site : DDT 5# Shield Room D:\2021 report data\Q21091611-2E\FCC-CE.EM6
Test Date : 2022-01-12 **Tested By** : Kennys Zhang
EUT : SOLAR RECHARGEABLE OUTDOOR **Model Number** : SOLAR SOUNDS
 : SPEAKER WITH MULTI-SYNC **Test Mode** : TX Mode
Power Supply : AC 120V 60Hz **LISN** : 2021 ENV 216 3#/LINE
Condition : Temp:23.0°C,Humi:45.8%,Press:101.4kPa
Memo : BT

Data: 4

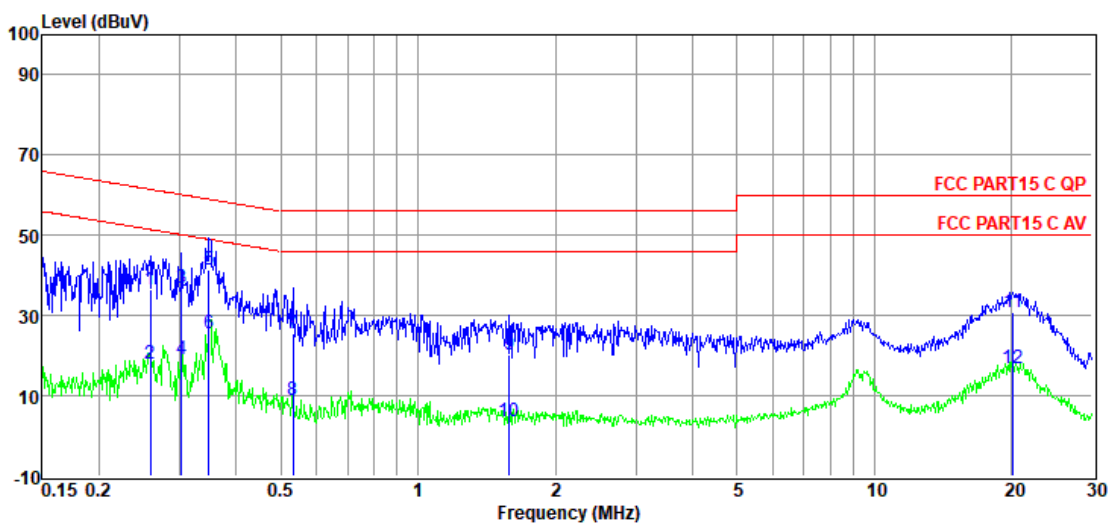

Item (Mark)	Freq. (MHz)	Read Level (dBμV)	LISN Factor (dB)	Cable Loss (dB)	Result Level (dBμV)	Limit Line (dBμV)	Over Limit (dB)	Detector	Phase
1	0.26	17.09	9.50	9.83	36.42	61.47	-25.05	QP	LINE
2	0.26	-1.18	9.50	9.83	18.15	51.47	-33.32	Average	LINE
3	0.30	17.52	9.50	9.83	36.85	60.15	-23.30	QP	LINE
4	0.30	-0.13	9.50	9.83	19.20	50.15	-30.95	Average	LINE
5	0.35	22.06	9.50	9.84	41.40	59.00	-17.60	QP	LINE
6	0.35	6.12	9.50	9.84	25.46	49.00	-23.54	Average	LINE
7	0.53	6.14	9.50	9.84	25.48	56.00	-30.52	QP	LINE
8	0.53	-10.62	9.50	9.84	8.72	46.00	-37.28	Average	LINE
9	1.59	0.70	9.47	9.90	20.07	56.00	-35.93	QP	LINE
10	1.59	-15.82	9.47	9.90	3.55	46.00	-42.45	Average	LINE
11	20.16	11.70	9.20	9.98	30.88	60.00	-29.12	QP	LINE
12	20.16	-2.33	9.20	9.98	16.85	50.00	-33.15	Average	LINE

- Note: 1. Result Level = Read Level +LISN Factor + Cable loss.
 2. If QP Result complies with AV limit, AV Result is deemed to comply with AV limit.
 3. Test setup: RBW: 200 Hz (9 kHz—150 kHz), 9 kHz (150 kHz—30 MHz).
 4. Step size: 80Hz (0.009MHz-0.15MHz), 4 kHz (0.15MHz-30MHz), Scan time: auto.

14. Antenna Requirements

14.1. Limit

For intentional device, according to FCC 47 CFR Section 15.203, an intentional radiator shall be designed to ensure that no antenna other than that furnished by the responsible party shall be used with the device. And according to FCC 47 CFR Section 15.247 (b), if transmitting antennas of directional gain greater than 6dBi are used, the power shall be reduced by the amount in dB that the directional gain of the antenna exceeds 6dBi.

14.2. Result

There is no antenna other than that furnished by the responsible party shall be used with the device, the maximum peak gain of antenna is 4.24dBi.

END OF REPORT