

DW1000 USER MANUAL

**HOW TO USE, CONFIGURE AND
PROGRAM THE DW1000 UWB
TRANSCEIVER**

This document is subject to change without notice

Table of Contents

LIST OF FIGURES	3	8.1	IC CALIBRATION – CRYSTAL OSCILLATOR TRIM ...	185
LIST OF TABLES	4	8.2	IC CALIBRATION – TRANSMIT POWER AND SPECTRUM	187
1 INTRODUCTION	7	8.3	IC CALIBRATION – ANTENNA DELAY	190
1.1 ABOUT THE DW1000	7	9 OPERATIONAL DESIGN CHOICES WHEN		
1.2 ABOUT THIS DOCUMENT	7	EMPLOYING THE DW1000.....		193
2 OVERVIEW OF THE DW1000	9	9.1	OPERATING RANGE	193
2.1 INTRODUCTION	9	9.2	CHANNEL AND BANDWIDTH SELECTION	193
2.2 INTERFACING TO THE DW1000	9	9.3	CHOICE OF DATA RATE, PREAMBLE LENGTH AND PRF	193
2.3 DW1000 OPERATIONAL STATES	13	9.4	POWER CONSUMPTION.....	194
2.4 POWER ON RESET (POR)	17	9.5	NODE DENSITY AND AIR UTILISATION	194
2.5 DEFAULT CONFIGURATION ON POWER UP	19	9.6	LOW DUTY CYCLE - AIR TIME.....	195
3 MESSAGE TRANSMISSION	23	9.7	LOCATION SCHEMES	196
3.1 BASIC TRANSMISSION.....	23	9.8	GENERAL CONSIDERATIONS.....	197
3.2 TRANSMISSION TIMESTAMP.....	24	10 APPENDIX 1: THE IEEE 802.15.4 UWB PHYSICAL		LAYER
3.3 DELAYED TRANSMISSION	24			199
3.4 EXTENDED LENGTH DATA FRAMES.....	25	10.1	FRAME STRUCTURE OVERVIEW	199
3.5 HIGH SPEED TRANSMISSION	26	10.2	DATA MODULATION SCHEME	199
4 MESSAGE RECEPTION	29	10.3	SYNCHRONISATION HEADER MODULATION SCHEME	200
4.1 BASIC RECEPTION.....	29	10.4	PHY HEADER	201
4.2 DELAYED RECEIVE.....	32	10.5	UWB CHANNELS AND PREAMBLE CODES	202
4.3 DOUBLE RECEIVE BUFFER.....	32	10.6	ADDITIONAL DETAILS ON THE STANDARD	203
4.4 LOW-POWER LISTENING.....	36	11 APPENDIX 2: THE IEEE 802.15.4 MAC LAYER ...		204
4.5 LOW-POWER SNIFF MODE.....	38	11.1	GENERAL MAC MESSAGE FORMAT	204
4.6 DIAGNOSTICS	41	11.2	THE FRAME CONTROL FIELD IN THE MAC HEADER	205
4.7 ASSESSING THE QUALITY OF RECEPTION AND THE RX		11.3	THE SEQUENCE NUMBER FIELD	207
TIMESTAMP	41	11.4	MAC LEVEL PROCESSING IN THE DW1000.....	208
5 MEDIA ACCESS CONTROL (MAC) HARDWARE		12 APPENDIX 3: TWO-WAY RANGING		209
FEATURES	45	13 APPENDIX 4: ABBREVIATIONS AND ACRONYMS		211
5.1 CYCLIC REDUNDANCY CHECK	45	14 APPENDIX 5: REFERENCES		214
5.2 FRAME FILTERING	45			
5.3 AUTOMATIC ACKNOWLEDGEMENT	47			
5.4 TRANSMIT AND AUTOMATICALLY WAIT FOR RESPONSE				
50				
6 OTHER FEATURES OF THE DW1000.....	51			
6.1 EXTERNAL SYNCHRONISATION.....	51			
6.2 EXTERNAL POWER AMPLIFICATION	54			
6.3 USING THE ON-CHIP OTP MEMORY	54			
6.4 MEASURING IC TEMPERATURE AND VOLTAGE	58			
7 THE DW1000 REGISTER SET	59			
7.1 REGISTER MAP OVERVIEW	59			
7.2 DETAILED REGISTER DESCRIPTION	61			
8 DW1000 CALIBRATION	185			

List of Figures

FIGURE 1: SPI READ AND WRITE TRANSACTIONS	10	FIGURE 19: POWER PROFILE FOR SNIFF WHERE A FRAME IS RECEIVED	40
FIGURE 2: SINGLE OCTET HEADER OF THE NON-INDEXED SPI TRANSACTION	11	FIGURE 20: POWER PROFILE FOR LOW DUTY-CYCLE SNIFF WHERE A FRAME IS NOT RECEIVED	41
FIGURE 3: EXAMPLE NON-INDEXED READ OF THE DEVICE ID REGISTER (0X00)	11	FIGURE 21: ESTIMATED RX LEVEL VERSUS ACTUAL RX LEVEL	44
FIGURE 4: TWO OCTET HEADER OF THE SHORT INDEXED SPI TRANSACTION	11	FIGURE 22: DW1000 EXTERNAL SYNCHRONISATION INTERFACE	51
FIGURE 5: EXAMPLE SHORT-INDEXED READ OF 3 RD AND 4 TH OCTETS OF REGISTER 0X00	12	FIGURE 23: SYNCHRONISED TRANSMISSION	53
FIGURE 6: THREE OCTET HEADER OF THE LONG INDEXED SPI TRANSACTION	12	FIGURE 24: OSRS MODE RECEIVE TIMEBASE SYNCHRONISATION	53
FIGURE 7: EXAMPLE LONG-INDEXED WRITE OF ONE OCTET TO INDEX 310 OF THE TX BUFFER	12	FIGURE 25: TRANSMIT POWER CONTROL OCTET	104
FIGURE 8: DW1000 STATE DIAGRAM	14	FIGURE 26: COMBINING EDG1 AND EDV2 TO GIVE AN ED NOISE FIGURE	115
FIGURE 9: TIMING DIAGRAM AND POWER PROFILE FOR COLD START POR	17	FIGURE 27: FLOW CHART FOR DIRECT READ OF AON ADDRESS	153
FIGURE 10: TRANSMIT FRAME FORMAT	23	FIGURE 28: PPM VS CRYSTAL TRIM SETTING, $V_{BATT} = 3.3V$	187
FIGURE 11: BASIC TRANSMIT SEQUENCE	23	FIGURE 29: TRANSMIT AND RECEIVE ANTENNA DELAY	191
FIGURE 12: BASIC RECEIVE SEQUENCE	29	FIGURE 30: UWB PHY FRAME STRUCTURE	199
FIGURE 13: FLOW CHART FOR USING DOUBLE RX BUFFERING	35	FIGURE 31:- BPM/BPSK DATA AND PHR MODULATION	199
FIGURE 14 : TRXOFF IN DOUBLE-BUFFERED MODE	36	FIGURE 32: PHR BIT ASSIGNMENT	202
FIGURE 15: LOW POWER LISTENING WITH TWO SLEEP TIMES	37	FIGURE 33: GENERAL MAC MESSAGE FORMAT	204
FIGURE 16: POWER PROFILE FOR LOW POWER LISTENING MODE WHERE NO FRAME IS RECEIVED	38	FIGURE 34: MAC MESSAGE FRAME CONTROL FIELD	205
FIGURE 17: STATE TRANSITIONS DURING SNIFF MODE	39	FIGURE 35: RANGING ALGORITHM AND RANGE CALCULATION	210
FIGURE 18: POWER PROFILE FOR SNIFF WHERE A FRAME IS NOT RECEIVED	40		

List of Tables

TABLE 1: MAIN DW1000 OPERATIONAL STATES / MODES	15	TABLE 25: REGISTER FILE: 0X26 – GPIO CONTROL AND STATUS OVERVIEW	119
TABLE 2: MODE 2 EXCERPT FROM DW1000 DATA SHEET OPERATIONAL MODES TABLE	19	TABLE 26: REGISTER FILE: 0X27 – DIGITAL RECEIVER CONFIGURATION OVERVIEW	131
TABLE 3: GPIO DEFAULT FUNCTIONS	19	TABLE 27: SUB-REGISTER 0X27:02 – DRX_TUNE0BVALUES	132
TABLE 4: REGISTER ACCESSES REQUIRED TO LOAD LDE MICROCODE	22	TABLE 28: SUB-REGISTER 0X27:04 – DRX_TUNE1AVALUES	133
TABLE 5: RECOMMENDED PAC SIZE	29	TABLE 29: SUB-REGISTER 0X27:06 – DRX_TUNE1B VALUES	133
TABLE 6: REGISTERS IN THE RX DOUBLE-BUFFERED SWINGING-SET	33	TABLE 30: SUB-REGISTER 0X27:08 – DRX_TUNE2VALUES	134
TABLE 7: AUTO-ACK PREAMBLE LENGTH DEPENDING ON RXPSR AND RXPACC	48	TABLE 31: REGISTER 0X27:26 DRX_TUNE4H VALUES	136
TABLE 8: AUTO-ACK PREAMBLE LENGTH SELECTION IN EXTENDED LENGTH FRAMES MODE	48	TABLE 32: REGISTER FILE: 0X28 – ANALOG RF CONFIGURATION BLOCK OVERVIEW	137
TABLE 9: OTP MEMORY MAP	55	TABLE 33: SUB-REGISTER 0X28:0B– RF_RXCTRLHVALUES	138
TABLE 10: OTP_SRDAT REGISTER	56	TABLE 34: SUB-REGISTER 0X28:0C– RF_TXCTRLVALUES	139
TABLE 11: REGISTER ACCESSES REQUIRED TO PROGRAM THE OTP	56	TABLE 35: REGISTER FILE: 0X2A – TRANSMITTER CALIBRATION BLOCK OVERVIEW	141
TABLE 12: AN EXAMPLE OF REGISTER ACCESSES REQUIRED TO READ FROM OTP	57	TABLE 36: SUB-REGISTER 0X2A:0B – TC_PGDELAY RECOMMENDED VALUES	144
TABLE 13: AN EXAMPLE OF REGISTER ACCESSES TO PERFORM A READ OF THE TEMPERATURE AND VOLTAGE SENSORS	58	TABLE 37: SUB-REGISTER 0X2A:0C – TC_PGTEST VALUES	145
TABLE 14: REGISTER MAP OVERVIEW	59	TABLE 38: REGISTER FILE: 0X2B – FREQUENCY SYNTHESIZER CONTROL BLOCK OVERVIEW	145
TABLE 15: PREAMBLE LENGTH SELECTION	73	TABLE 39: SUB-REGISTER 0X2B:07 – FS_PLLCFG VALUES	146
TABLE 16: PREAMBLE LENGTH REPORTING	90	TABLE 40: SUB-REGISTER 0X2B:0B – FS_PLLTUNE VALUES	146
TABLE 17: REFERENCE VALUES FOR REGISTER FILE: 0X1E – TRANSMIT POWER CONTROL, FOR SMART TRANSMIT POWER CONTROL	104	TABLE 41: REGISTER FILE: 0X2C – ALWAYS-ON SYSTEM CONTROL OVERVIEW	148
TABLE 18: REFERENCE VALUES REGISTER FILE: 0X1E – TRANSMIT POWER CONTROL FOR MANUAL TRANSMIT POWER CONTROL (SMART TRANSMIT POWER CONTROL DISABLED)	104	TABLE 42: CONFIGURATIONS MAINTAINED IN THE AON MEMORY ARRAY	152
TABLE 19: RECOMMENDED SFD SEQUENCE CONFIGURATIONS FOR BEST PERFORMANCE	110	TABLE 43: REGISTER FILE: 0X2D – OTP MEMORY INTERFACE OVERVIEW	158
TABLE 20: REGISTER FILE: 0X23 –AGC CONFIGURATION AND CONTROL OVERVIEW	110	TABLE 44: RECEIVER OPERATING PARAMETER SETS	162
TABLE 21: SUB-REGISTER 0X23:04 – AGC_TUNE1 VALUES	112	TABLE 45: REGISTER FILE: 0X2E – LEADING EDGE DETECTION INTERFACE OVERVIEW	163
TABLE 22: SUB-REGISTER 0X23:0C – AGC_TUNE2VALUES	113	TABLE 46: SUB-REGISTER 0X2E:1806– LDE_CFG2VALUES	166
TABLE 23: SUB-REGISTER 0X23:12 – AGC_TUNE3 VALUES	113	TABLE 47: SUB-REGISTER 0X2E:2804 – LDE_REPC CONFIGURATIONS FOR (850 Kbps & 6.8 Mbps)	167
TABLE 24: SCALING FACTOR FOR CHANNEL NOISE ENERGY ESTIMATION	115		

TABLE 48: REGISTER FILE: 0X2F – DIGITAL DIAGNOSTICS INTERFACE OVERVIEW	168
TABLE 49: REGISTER FILE: 0X36 – POWER MANAGEMENT AND SYSTEM CONTROL OVERVIEW	176
TABLE 50: REGISTER ACCESSES REQUIRED FOR TRANSMITTER CONFIGURATION PROCEDURE	188
TABLE 51: RECOMMENDED RX POWER LEVEL FOR ANTENNA CALIBRATION	191
TABLE 52: RECOMMENDED TX-RX SEPARATION FOR ANTENNA CALIBRATION	191
TABLE 53: RECOMMENDED PREAMBLE LENGTHS	194
TABLE 54: TRANSMISSIONS PER SECOND USING ALOHA	195
TABLE 55: TECHNIQUES TO SAVE POWER IN RECEIVING	197
TABLE 56: PREAMBLE PARAMETERS	201
TABLE 57: DW1000 SUPPORTED UWB CHANNELS AND RECOMMENDED PREAMBLE CODES	202
TABLE 58: FRAME TYPE FIELD VALUES	205
TABLE 59: DESTINATION ADDRESSING MODE FIELD VALUES	207
TABLE 60: SOURCE ADDRESSING MODE FIELD VALUES	207
TABLE 61: DOCUMENT HISTORY	215

DOCUMENT INFORMATION**Disclaimer**

DecaWave reserves the right to change product specifications without notice. As far as possible changes to functionality and specifications will be issued in product specific errata sheets or in new versions of this document. Customers are advised to check with DecaWave for the most recent updates on this product.

Copyright © 2014 DecaWave Ltd

LIFE SUPPORT POLICY

DecaWave products are not authorized for use in safety-critical applications (such as life support) where a failure of the DecaWave product would reasonably be expected to cause severe personal injury or death. DecaWave customers using or selling DecaWave products in such a manner do so entirely at their own risk and agree to fully indemnify DecaWave and its representatives against any damages arising out of the use of DecaWave products in such safety-critical applications.



Caution! ESD sensitive device. Precaution should be used when handling the device in order to prevent permanent damage.

REGULATORY APPROVALS

The DW1000, as supplied from DecaWave, has not been certified for use in any particular geographic region by the appropriate regulatory body governing radio emissions in that region although it is capable of such certification depending on the region and the manner in which it is used.

All products developed by the user incorporating the DW1000 must be approved by the relevant authority governing radio emissions in any given jurisdiction prior to the marketing or sale of such products in that jurisdiction and user bears all responsibility for obtaining such approval as needed from the appropriate authorities.

1 Introduction

1.1 About the DW1000

The DW1000 is a fully integrated low power, single chip CMOS radio transceiver IC compliant with the IEEE 802.15.4-2011 ultra-wideband (UWB) standard.

- It facilitates proximity detection to an accuracy of +/- 10 cm using two-way ranging time-of-flight (TOF) measurements.
- It facilitates real time location of assets in to an accuracy of +/- 10cm using either two-way ranging (TOF) measurements or one-way time difference of arrival (TDOA) Time Difference of Arrival schemes
- It spans 6 RF bands from 3.5 GHz to 6.5 GHz
- It supports data rates of 110 kbps, 850 kbps and 6.8 Mbps
- Its high data rates allow it to keep on-air time short and thereby save power and extending battery lifetimes
- Its ability to deal with severe multipath environments make it ideal for highly reflective RF environments

1.2 About this document

This user manual describes the operation and programming of the DW1000 and discusses some of the design choices to be considered when implementing systems using it.

Information already contained in the DW1000 data sheet is not reproduced here and it is intended that the reader should use this user manual in conjunction with the DW1000 data sheet.

The document is divided into a number of sections each of which deals with a particular aspect of the DW1000 as follows: -

Section No	Section Name	Information covered
2	Overview of the DW1000	Gives an overview of the DW1000, describes how to interface to the device and details its various operating modes
3	Message Transmission	Describes the functionality and use of the DW1000 transmitter
4	Message Reception	Describes the functionality and use of the DW1000 receiver
5	Media Access Control (MAC) hardware features	Describes the MAC level functionality provided in hardware by the DW1000.
6	Other features of the DW1000	Describes other features supported by the DW1000
7	The DW1000 register set	Describes DW1000 user-accessible register set in detail, lists all user accessible bit fields in each register and their respective functions.
8	DW1000 Calibration	Describes the parameters of the DW1000 that require calibration; the methodology that should be used in calibrating them and how often they require calibration.

Section No	Section Name	Information covered
9	Operational design choices when employing the DW1000	Discusses some of the issues to be considered and tradeoffs to be made when building systems based on the DW1000
10	APPENDIX 1: The IEEE 802.15.4 UWB physical layer	Provides background information on the UWB PHY layer of the IEEE802.15.4 standard
11	APPENDIX 2: The IEEE 802.15.4 MAC layer	Provides background information on the MAC layer of the IEEE802.15.4 standard
12	APPENDIX 3: Two-Way Ranging	Gives an introduction to the use of the DW1000 in two-way ranging proximity systems
13	APPENDIX 4: Abbreviations and acronyms	Provides a list and explanation of abbreviations and acronyms used in the rest of the document
14	APPENDIX 5: References	Lists the documents referred to in this user manual

Note: DecaWave also provides DW1000 device driver software as source code. This source code includes a set of API functions to initialise, configure and control the DW1000. It provides API functions for transmission and reception, and for driving the functionalities of the IC. The DW1000 driver source code is targeted for the ARM cortex M3 but is readily portable to other microprocessor systems. The code comes with a number of demo/test applications, (including a two-way ranging application), to exercise the API and the features of the DW1000.

Clock Periods and Frequencies

The chipping rate given by the IEEE 802.15.4-2011 standard [1] is 499.2 MHz. DW1000 system clocks are referenced to this frequency. Where the system clock frequency is given as 125 MHz, this is an approximation to the actual system clock frequency of 124.8 MHz. Similarly, where the system clock period is given as 8 ns, this is an approximation to the actual period of $1/(124.8 \times 10^6)$ seconds.

The 1 GHz PLL clock, where referenced, is an approximation to its actual frequency of 998.4 MHz.

A 63.8976 GHz sampling clock is associated with ranging for the IEEE 802.15.4-2011 standard, where a 15.65 picosecond time period is referred to, it is an approximation to the period of this clock.

PRF

PRF values of 16 MHz and 64 MHz are given in this document. These are approximations to the PRF values dictated by [1]. PRF mean values are slightly higher for SHR as opposed to the other portions of a frame. Mean PRF values are 16.1/15.6 MHz and 62.89/62.4 MHz. Refer to [1] for full details of peak and mean PRFs.

Data Rate

Where a data rate of 6.8 Mbps is referred to, this is equivalent to the 6.81/6.8 Mbps data rate in [1].

2 Overview of the DW1000

2.1 Introduction

The DW1000 consists of an analog front-end (both RF and baseband) containing a receiver and transmitter and a digital back-end that interfaces to a host processor, controls the analog front-end, accepts data from the host processor for transmission and provides received data to the host processor over an industry standard SPI interface. A variety of control schemes are implemented to maintain and optimize transceiver performance.

2.2 Interfacing to the DW1000

2.2.1 The SPI Interface

The DW1000 host communications interface is a slave-only Serial Peripheral Interface (SPI) compliant with the industry protocol. The host system must include a master SPI bus controller in order to communicate with the DW1000. The SPI bus signals, their voltage levels and signal timings are described in the DW1000 data sheet.

The host system reads and writes DW1000 registers via the SPI. This section describes the format of the SPI transactions. For details of the SPI physical circuits, operational mode configuration and timing parameters please refer to the DW1000 data sheet. The SPI-accessible registers of the DW1000 are detailed in section 7 – [The DW1000 register set](#).

2.2.1.1 SPI operating modes

The operating mode of the SPI is determined when the DW1000's digital control function is initialised as a result of a device reset or as it is woken up from a sleep state. At this time GPIO lines 5 and 6 are sampled and their values act to select the SPI mode.

It is possible to set the SPI mode within the DW1000's one-time programmable configuration block to avoid needing any external components and leave the GPIO free for alternative use. This is a one-time activity and cannot be reversed so care must be taken to ensure that the desired SPI mode is set. Please refer to section [6.3 – Using the on-chip OTP](#) memory for more details of OTP configuration, and [Register file: 0x2D – OTP Memory Interface](#).

For full details of the SPI operating modes and their configuration, please refer to the DW1000 data sheet.

2.2.1.2 Transaction formats of the SPI interface

Each SPI transaction starts with a one to three octet transaction header followed by a variable number of octets making up the transaction data. The number of data bytes allowed in an SPI transfer is not limited.

The transaction header selects whether the transaction is a read or a write and specifies the address to read from or write to. Physically the SPI interface is full duplex in that every transaction shifts bits both into and out of the DW1000. Logically however each transaction is either reading data from the DW1000 or writing data to it. As shown in Figure 1, for a read transaction all octets beyond the transaction header are ignored

by the DW1000, and for a write transaction all octets output by the DW1000 should be ignored by the host system.

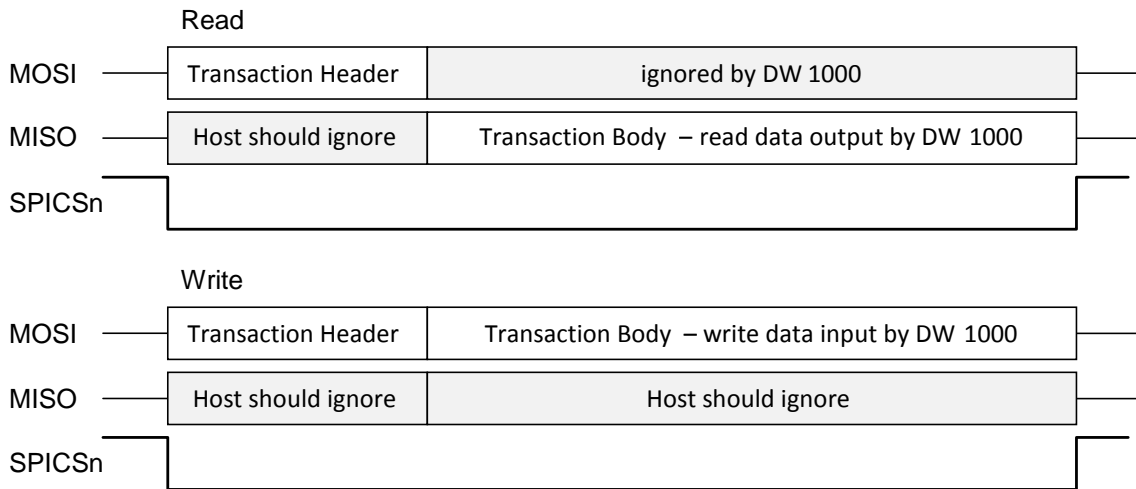

Figure 1: SPI Read and Write Transactions

Note: The octets are physically presented on the SPI interface data lines with the high order bit sent first in time.

SPI transactions are enveloped by the assertion of the active low chip select line, SPICSn. The high-to-low assertion (low) of SPICSn initialises the SPI transaction handler so that the DW1000 interprets the next octet(s) as a new transaction header. The low-to-high de-assertion of SPICSn ends the SPI transaction. Typically a software SPI interface driver will include a parameter to indicate the length of the transaction, i.e. how many octets to write to the device on the SPI bus, or how many bytes to read.

The SPI accessible parameters of the DW1000 are organised into 64 separate register file locations (detailed in section 7 – [The DW1000 register set](#)). Every SPI access transaction header includes a 6-bit register file ID that identifies which register file is being accessed by the transaction. Sub-addressing within the selected register file allows efficient access to all the parameters within the DW1000. Depending on the sub-addressing being used, the transaction header is either one, two or three octets long. These three types of transaction are described in the sub-sections below.

Note: when writing to any of the DW1000 registers care must be taken not to write extra data beyond the published length of the selected register (see section 7 – [The DW1000 register set](#)).

Figure 2 shows the fields within the one octet transaction header of a simple non-indexed SPI transaction. Bit-6 is zero indicating that a sub-index is not present. The register (file) ID selects the top level addressing of the DW1000 parameter or parameter block being accessed.

Bit number:	7	6	5	4	3	2	1	0	
Meaning:	Operation: 0 = Read 1 = Write	Bit = 0, says sub-index is not present	Register file ID – Range 0x00 to 0x3F (64 locations)						Transaction Header Octet

Figure 2: Single octet header of the non-indexed SPI transaction

The remaining octets of the transaction, the transaction body, immediately following this one-octet header are read from (or written to) the selected register file beginning at index zero. Figure 3 shows an example of a non-indexed read from the Device ID register using the single octet header.

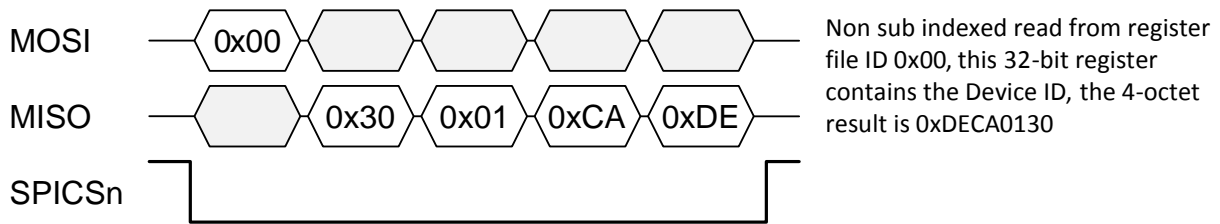

Figure 3: Example non-indexed read of the Device ID register (0x00)

Note: The octets of a multi-octet value are transferred on the SPI interface in octet order beginning with the low-order octet. This is shown in Figure 3.

2.2.1.2.1 SPI transaction with a 2-octet header

Figure 4 shows the fields within the two octet transaction header of a short-indexed SPI transaction. Bit-6 of the first octet is 1 indicating that a sub-index is present. The register (file) ID in the first octet selects the top level address of the DW1000 parameter block being accessed. In the second octet bit-7 is zero indicating that a further transaction header octet is not present and that the remaining 7 bits of octet-2 are a short sub-index into the register file.

Bit number:	7	6	5	4	3	2	1	0	
Meaning:	Operation: 0 = Read 1 = Write	Bit = 1, says sub-index is present	Register file ID – Range 0x00 to 0x3F (64 locations)						Transaction Header Octet 1
	Extended Address: 0 = no	7-bit Register File sub-address, range 0x00 to 0x7F (128 byte locations)							Octet 2

Figure 4: Two octet header of the short indexed SPI transaction

The remaining octets of the transaction, the transaction body, immediately following this two-octet header are read from (or written to) the selected register file beginning at the selected index address 0 to 127. Figure 5 shows an example of an indexed read from the Device ID register using the two octet transaction header.

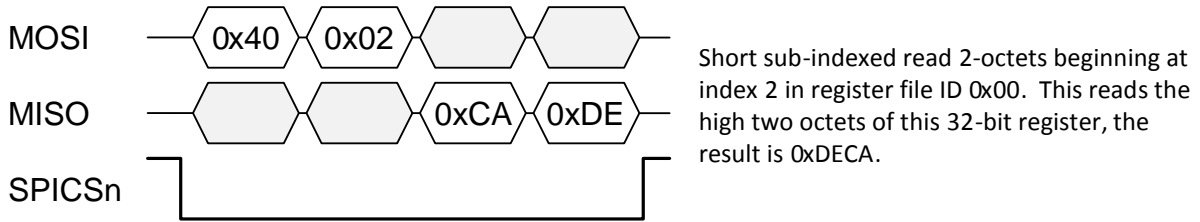

Figure 5: Example short-indexed read of 3rd and 4th octets of register 0x00

2.2.1.2.2 SPI transaction with a 3-octet header

Figure 6 shows the fields within the three octet transaction header of a long-indexed SPI transaction. Bit-6 of the first octet is 1 indicating that a sub-index is present. The register (file) ID in the first octet selects the top level addressing of the DW1000 parameter or parameter block being accessed. In the second transaction header octet bit-7 is set indicating the long form of indexed addressing is to be employed and thus the remaining seven bits of the second octet along with all of the third transaction header octet form a 15-bit sub-index into the selected register file.

Bit number:	7	6	5	4	3	2	1	0	
Meaning:	Operation: 0 = Read 1 = Write	Bit = 1, says sub-index is present	Register file ID – Range 0x00 to 0x3F (64 locations)						Transaction Header Octet 1
Extended Address: 1 = yes	Low order 7 bits of 15-bit Register file sub-address range 0x0000 to 0x7FFF (32768 byte locations)							Octet 2	
High order 8 bits of 15-bit Register file sub-address range 0x0000 to 0x7FFF (32768 byte locations)								Octet 3	

Figure 6: Three octet header of the long indexed SPI transaction

The octets of transaction body which immediately follow the transaction header are read from (or written to) the selected register file beginning at the selected sub-index address 0 to 32767.

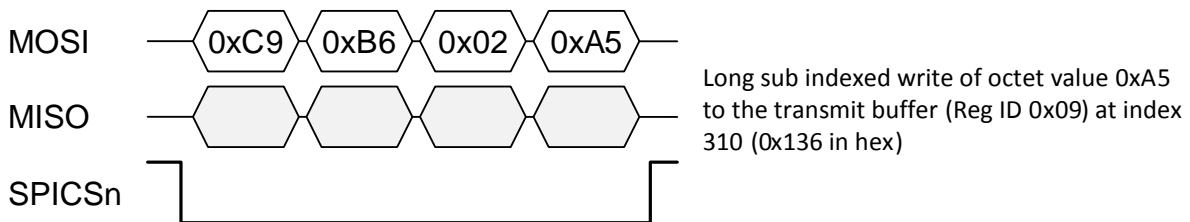

Figure 7: Example long-indexed write of one octet to index 310 of the TX buffer

Figure 7 shows an example of an indexed write that uses the longer the three octet header. This example is a write to the transmit data buffer at sub index 0x136. The TX buffer has register file ID of 0x09. Octet 1 of transaction header is thus 0xC9 as bit-7 is 1 to signal a write and bit-6 is 1 indicating a sub-address follows. The 15-bit sub-address has the binary value 000-0001-0011-0110. In octet 2 of the transaction header, bit 7 is set to indicate an extended sub-index and the remaining bits contain 0110110, the low 7 bits of the sub-address. Octet 3 of the transaction header then contains 00000010, the remaining eight high order bits of the sub-address index, which is 0x02 in hex.

The DW1000 parameters that may be read and written using these SPI transactions are detailed in section 7 – [The DW1000 register set](#).

2.2.2 Interrupts

The DW1000 can be configured to assert its IRQ pin on the occurrence of one or more status events. The assertion of the IRQ pin can be used to interrupt the host controller and redirect program flow to deal with the cause of the event.

The polarity of the IRQ pin may be configured via the HIRQ_POL bit in the [Register file: 0x0D – System Control Register](#). By default on power up the IRQ polarity is active high. This is the recommended polarity to ensure lowest power operation of the DW1000 in [SLEEP](#) and [DEEPSLEEP](#) device states. This pin will float in SLEEP and DEEPSLEEP states and may cause spurious interrupts unless pulled low.

The occurrence of a status event in [Register file: 0x0F – System Event Status Register](#) may assert the IRQ pin depending on the setting of the corresponding bit in the [Register file: 0x0E – System Event Mask Register](#).

By default, on power-up, all interrupt generating events are masked and interrupts are disabled.

2.2.3 General Purpose I/O

The DW1000 provides 8 GPIO pins. These can be individually configured at the user's discretion to be inputs or outputs. The state of any GPIO configured as an input can be read and reported to the host controller over the SPI interface. When configured as an output the host controller can set the state of the GPIO to high or low.

Some of the GPIO lines have multiple functions as listed in the DW1000 data sheet.

The configuration and operation of the GPIO pins is controlled via [Register file: 0x26 – GPIO control and status](#)

By default, on power-up, all GPIOs are configured as inputs.

2.2.4 The SYNC pin

This pin is used for external clock synchronisation purposes. See section [6.1 – External Synchronisation](#) for further details.

2.3 DW1000 Operational States

2.3.1 State diagram

The DW1000 has a number of different operational states (or modes). These are listed and described in Table 1 below and the transitions between them are illustrated in Figure 8.

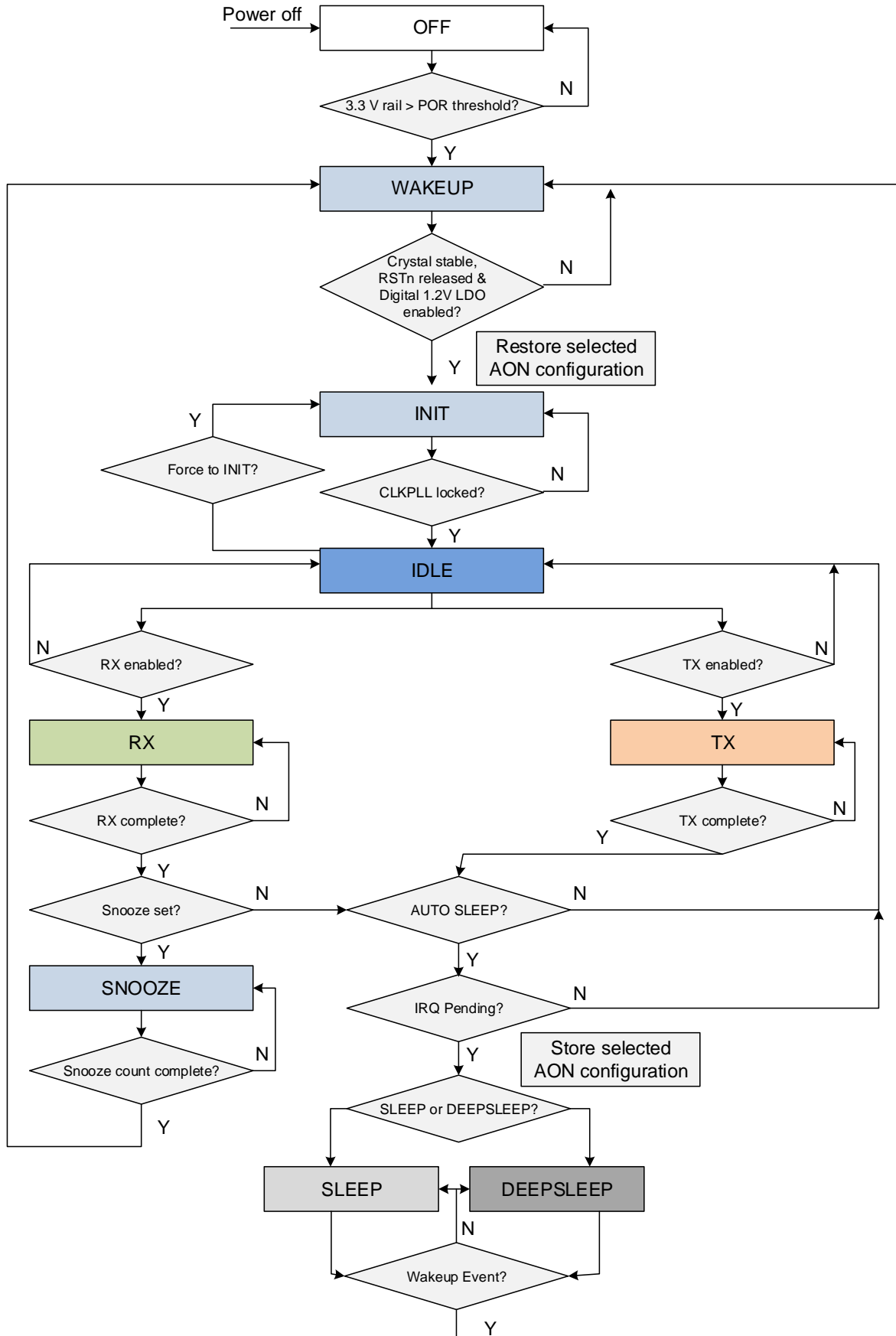

Figure 8: DW1000 State Diagram

2.3.2 Overview of main operational states

Table 1: Main DW1000 operational states / modes

State Name	State Description
OFF	In the OFF state the DW1000 is completely powered off, with no voltages applied to any of its input pins. Power consumption = 0uA. No I/O pins should be driven or power will leak through the I/O cells.
WAKEUP	During the WAKEUP state the crystal oscillator and the band-gap are enabled. After approximately 4 ms the digital LDO will be enabled and the RSTn (output) will de-assert allowing the DW1000 to enter the INIT state.
INIT	<p>In the INIT state the main crystal oscillator is running. The raw 38.4 MHz XTAL oscillator frequency is divided by 2 to give a 19.2 MHz internal clock called XTI. In the INIT state digital circuitry of the DW1000 is fed from this 19.2 MHz XTI clock.</p> <p>If the DW1000 has entered INIT state from a SLEEP or DEEPSLEEP state, (or as a result of a reset), then the register configurations can be automatically restored from the AON memory array.</p> <p>Then the DW1000 turns on the CLKPLL and after 5 μs the CLKPLL will be locked and the DW1000 will automatically transition into the IDLE state.</p> <p>SPI accesses from an external microcontroller are possible in the INIT state, but these are limited to a SPICLK input frequency of no greater than 3 MHz. Care should be taken not to have an active SPI access in progress at the CLKPLL lock time (i.e. at t = 5 μs) when the automatic switch from the INIT state to the IDLE state is occurring, because the switch-over of clock source can cause bit errors in the SPI transactions.</p>
IDLE	In the IDLE state the DW1000 internal clock generator CLKPLL is locked running and ready for use but is gated off to most circuitry to minimize power consumption. In the IDLE state SPI communications can operate at up to 20 MHz, the maximum SPICLK frequency. In the IDLE state the analog receive and transmit circuits are powered down. The external host can control the DW1000 to initiate a transmission or reception and thus cause the DW1000 to progress into TX state or RX state respectively. If a delayed TX or RX operation is initiated (see section 3.3 – Delayed Transmission and 4.2 – Delayed Receive) then the DW1000 will stay in the IDLE state until the delayed time has elapsed, after which it will enter the TX state or RX state.
SLEEP	In the SLEEP state the IC consumes < 1 μA from the external power supply inputs. All internal LDOs are turned off. In the SLEEP state the DW1000 internal low powered ring oscillator is running and is used to clock the sleep counter whose expiry is programmed to “wake up” the DW1000 and progress into the WAKEUP state. While in SLEEP power should not be applied to GPIO, SPICLK or SPIMISO pins as this will cause an increase in leakage current.

State Name	State Description
DEEPSLEEP	<p>With the exception of the OFF state, the DEEPSLEEP state is the lowest power state of the device.</p> <p>In DEEPSLEEP all internal circuitry is powered down with the exception of the always-on memory which can be used to hold the device configuration for restoration on wakeup</p> <p>Once in DEEPSLEEP the DW1000 remains there until the occurrence of a wakeup event. This can be either:</p> <ol style="list-style-type: none"> 1. the SPICSn line pulled low or 2. the WAKEUP line driven high <p>for the duration quoted in the DW1000 data sheet (nominally 500 μs).</p> <p>It is also recommended to use the SLP2INIT event status bit (in Register file: 0x0F – System Event Status Register) to drive the IRQ interrupt output line high to confirm the wake-up.</p> <p>Once the DW1000 has detected a wakeup event it progresses into the WAKEUP state. While in DEEPSLEEP power should not be applied to GPIO, SPICLK or SPIMISO pins as this will cause an increase in leakage current.</p>
TX state	<p>In the TX state the DW1000 actively transmits a frame the contents of the transmit buffer on the configured RF channel with the configured transmit parameters (PRF, data rate, preamble code etc.)</p> <p>Once the frame transmission is complete the DW1000 may enter one of three modes depending on the programmed configuration.</p> <p>After the frame transmission is complete the DW1000 will return to the IDLE state unless the ATXSLP bit is set (in Sub-Register 0x36:04 – PMSC_CTRL1) in which case the DW1000 will enter the SLEEP or DEEPSLEEP state automatically, (as long as no host interrupts are pending).</p>
RX state	<p>In the RX state, the DW1000 receiver is active, either hunting for preamble or (once it has detected preamble) actively receiving preamble searching for SFD, and subsequently receiving the PHR, decoding it and receiving the data part of the frame. In the RX state, the RF synthesizer and all RX blocks are active. After an event that ends the reception, (either a good frame RX, or some error or timeout event that aborts reception) the DW1000 will return to the IDLE state unless the ARXSLP bit is set (in Sub-Register 0x36:04 – PMSC_CTRL1) in which case the DW1000 will enter the SLEEP or DEEPSLEEP state automatically (as long as no host interrupts are pending).</p>
SNOOZE	<p>The SNOOZE state is similar to the INIT state except that a counter is running to cause the DW1000 to automatically go to the RX state (via INIT and IDLE) when the counter expires. The snooze count times are in units of the raw 19.2 MHz XTI clock rate, (since the 125 MHz digital PLL clock is not running).</p>

2.4 Power On Reset (POR)

When the external power source is applied to the DW1000 for the first time, the internal Power On Reset (POR) circuit compares the externally applied supply voltage to an internal power-on threshold (approximately 1.5 V), and once this threshold is passed the crystal oscillator is enabled and the external device enable pin EXTON is asserted. An internal counter running off the low power oscillator is used to hold the DW1000 in reset to ensure that the crystal oscillator is stable before it gets used. Once the digital reset is de-asserted the digital core wakes up and enters the **WAKEUP** state. From this state it will automatically turn on the CLKPLL and wait for it to lock before entering the **IDLE** state.

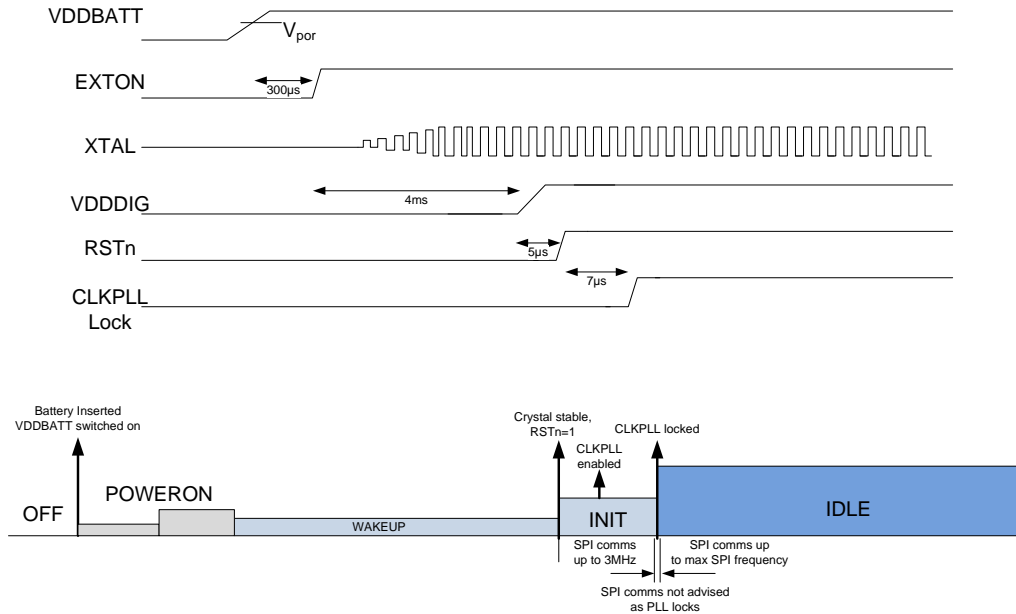

Figure 9: Timing diagram and power profile for cold start POR

2.4.1 SLEEP and DEEPSLEEP

In the DW1000 very low power **DEEPSLEEP** state the IC is almost completely powered down except for a small amount of memory necessary to maintain IC configurations. This is the lowest power mode of the IC where the power drain is < 100 nA. To wake the IC from **DEEPSLEEP** requires an external agent to assert the WAKEUP input line or the external host microprocessor to initiate an SPI transaction to assert the SPICSn input.

The DW1000 also includes a low power a **SLEEP** state where the IC can wake itself from sleeping as a result of the elapsing of a sleep timer that is running from a low-powered ring oscillator internal to the DW1000 IC. In this **SLEEP** state the power drain is < 1 µA. The DW1000 may wake from **SLEEP** state when the sleep timer elapses. The WAKEUP or SPICSn inputs may also be used to wake the device.

The frequency of the low power oscillator is dependent on process variations within the IC, but is generally somewhere in between 7,000 and 13,000 Hz. There are facilities within the IC to measure the length of an LP oscillator cycle, in counts of the IC crystal oscillator divided by two, (i.e. this is 38.4 MHz ÷ 2, or 19.2 MHz).

2.4.1.1 Waking from sleep

The return from **SLEEP** and **DEEPSLEEP** modes, is via

- Driving the **WAKEUP** pin high for approximately 500 μ s, (assuming the WAKE_PIN configuration bit is set in [Sub-Register 0x2C:06 – AON_CFG0](#)).
- Driving the **SPICSn** pin low for approximately 500 μ s, (assuming the WAKE_SPI configuration bit is set in [Sub-Register 0x2C:06 – AON_CFG0](#)). This can be achieved by doing a dummy SPI read of sufficient length.

NOTE: When using the SPICSn pin to wake up the device it is important that the SPIMOSI line is held low for the duration of the SPICSn to ensure that a spurious write operation does not occur.

In addition return from **SLEEP** also occurs when

- The internal sleep timer counter expires, (assuming the WAKE_CNT configuration bit is set in [Sub-Register 0x2C:06 – AON_CFG0](#) along with an appropriate SLEEP_TIM).

In all of three wakeup cases the device is returned to the **IDLE** state by default but additional state transitions can be automatically enacted thereafter depending on configurations.

2.4.1.2 Configuration register perseverance

Prior to entering the **SLEEP** and **DEEPSLEEP** states and prior to exiting the **WAKEUP** state, the main DW1000 configurations are copied to and from an Always-On memory (AON). Power is maintained to AON memory at all times, even in **SLEEP** and **DEEPSLEEP** states. The copying of configuration data (saving or restoring) takes about 7 μ s to complete. The detail of which configurations are saved and restored is given in [Table 42: Configurations maintained in the AON](#). Restoration of configurations during the **WAKEUP** state is only done if the ONW_LDC configuration bit is set in [7.2.45.1 – Sub-Register 0x2C:00 – AON_WCFG](#).

NB: The host system should avoid SPI access to general system registers or OTP Memory during the copying period to prevent any conflicts occurring. Access to the TX (or RX) buffer is not restricted during this period.

2.4.2 Specific state sequences supported by the DW1000

The DW1000 supports a number of state sequences intended to minimize power consumption in certain applications. These are: -

Mode Name	Mode Description
SNIFF MODE	In SNIFF mode the DW1000 alternates between the RX (on) and the IDLE (off) states. Further details on this mode are given in section 4.5.1 - SNIFF .

Mode Name	Mode Description
LOW DUTY CYCLE SNIFF MODE	In Low duty-cycle SNIFF mode, where the off time is larger, the DW1000 can be configured to spend this off time in the INIT state which is lower power than the IDLE state (used for the off period of a SNIFF). Further details of this mode are given in section 4.5.2 - Low duty-cycle SNIFF .
LOW POWER LISTENING	Low-Power Listening mode is a special mode where the receiver spends most its time in a low power (SLEEP or DEEPSLEEP) state only waking up occasionally to sample the air for a message. This feature is described in detail in section 4.4 - Low-Power Listening

2.5 Default Configuration on Power Up

DW1000 is a highly configurable transceiver with many features. The register reset values have been selected with the intention of minimising user configuration required. The default configuration may be summarised as being channel 5, preamble code 4 and mode 2. Channel numbers and preamble codes are as specified in the standard, IEEE 802.15.4-2011 [1] and mode 2 is as specified in the DW1000 data sheet modes and comprises the following configurations:

Table 2: Mode 2 Excerpt from DW1000 Data Sheet Operational Modes Table

Mode	Data Rate	PRF (MHz)	Preamble (Symbols)	Data Length (Bytes)	Packet Duration (µs)	Typical Use Case <small>(Refer to DW1000 user manual for further information)</small>
Mode 2	6.8 Mbps	16	128	12	152	RTLS, TDOA Scheme, Short Range, High Density

Some further details are given below on the specifics of the default device configuration. For full details the reader may refer to the register map where the default value of each register is given, section 7 – [The DW1000 register set](#).

2.5.1 Default System Configuration

Much of the system configuration is configured in the SYS_CFG register, please see section [Register file: 0x04 – System Configuration](#) for a full description of the register contents and defaults.

By default, interrupt polarity is active high and all interrupts are disabled, see the SYS_CFG register for interrupt polarity and the SYS_MASK and SYS_STATUS registers for interrupt configuration and information, see sections [Register file: 0x0E – System Event Mask Register](#) and [Register file: 0x0F – System Event Status Register](#).

GPIOs are set to mode 0, their default function as shown in Table 3.

Table 3: GPIO Default Functions

GPIO Pin	Default Function
GPIO0/RXOKLED	GPIO0

GPIO Pin	Default Function
GPIO1/SFDLED	GPIO1
GPIO2/RXLED	GPIO2
GPIO3/TXLED	GPIO3
GPIO4/EXTPA	GPIO4
GPIO5/EXTTXE/SPIPHA	GPIO5
GPIO6/EXTRXE/SPIPOL	GPIO6
SYNC/GPIO7	SYNC
IRQ/GPIO8	IRQ

Smart TX power is on by default, see section [Register file: 0x1E – Transmit Power Control](#) and [Smart Transmit Power Control](#) for configuration and operation information.

Sniff mode is off, see [Register file: 0x1D – SNIFF Mode](#) for details, frame wait timeout (see SYS_CFG register bit RXWTOE and [Register file: 0x0C – Receive Frame Wait Timeout Period](#)) and preamble detection timeout (see [Sub-Register 0x27:24 – DRX_PRETOC](#)) are off, whilst SFD detection timeout (see [Sub-Register 0x27:20 – DRX_SFDTOC](#)) is on.

Other SYS_CFG register settings such as Automatic Receiver Re-Enable (RXAUTR) and MAC functions such as frame filtering (FFEN), double buffering (DIS_DRXB) and automatic acknowledgement (AUTOACK) are all off by default. Automatic CRC generation is on and the CRC LFSR is initialised to 0's (FCS_INIT2F).

Note that CRC generation is selected as part of a transmit command, see [Register file: 0x0D – System Control Register](#).

External synchronisation and the use of external power amplifiers are deactivated by default, see sections [6.1 – External Synchronisation](#) and [6.2 – External Power Amplification](#).

2.5.2 Default Channel Configuration

Channel 5, preamble code 4 and 16 MHz PRF are set by default in the CHAN_CTRL register, see [Register file: 0x1F – Channel Control](#) for more information.

The transmit data rate is set to 6.8 Mbps in the TX_FCTRL register, see TXBR field in [Register file: 0x08 – Transmit Frame Control](#). The receive data rate is never set unless 110 kbps reception is required. Note that this must be configured in register SYS_CFG, field RXM110K, see [Register file: 0x04 – System Configuration](#).

The RF PLL and Clock PLL are configured for channel 5 operation by default, please refer to [Register file: 0x2B – Frequency synthesiser control block](#) for channel configuration settings for each channel.

2.5.3 Default Transmitter Configuration

Transmit RF channel configurations are set for channel 5 by default – see [Sub-Register 0x28:0C– RF_TXCTRL](#).

Transmit Smart power is enabled by default via the DIS_STXP bit in SYS_CFG register, refer to [Register file: 0x04 – System Configuration](#). Please see section [7.2.31.1 – Smart Transmit Power Control](#) for further information.

The transmit preamble symbol repetition length is 128 symbols, see [Register file: 0x08 – Transmit Frame Control](#), TXPSR and PE fields for configuration details.

2.5.4 Default Receiver Configuration

Receiver RF channel configurations are set for channel 5 by default – see [Sub-Register 0x28:0B–RF_RXCTRLH](#).

Digital receiver tuning registers; DRX_TUNE0b, DRX_TUNE1a, DRX_TUNE1band DRX_TUNE2 are configured by default for 16 MHz PRF, 6.8 Mbps data rate and a preamble symbol repetition of length 128. See [Sub-Register 0x27:02 – DRX_TUNE0b](#), [Sub-Register 0x27:04 – DRX_TUNE1a](#), [Sub-Register 0x27:06 – DRX_TUNE1b](#) and [Sub-Register 0x27:08 – DRX_TUNE2](#) for programming details.

The [LDERUNE](#) bit is enabled by default, which means that the microcode (the LDE algorithm) that has been loaded in RAM will execute on every frame reception, which in turn will calculate accurate frame time-of-arrival. However the DW1000 needs to load this microcode on power-on from a special ROM area in the DW1000. This is done by enabling the [LDELOAD](#) bit as part of DW1000 initialisation (because after powering up the DW1000 (or after exiting **SLEEP** or **DEEPSLEEP** states) the LDE RAM is empty). This should be done before the receiver is enabled if it is important to timestamp this received frame. If the LDE code is not being loaded before the receiver is enabled then the LDERUNE (LDE run enable) control in [Sub-Register 0x36:04 – PMSC_CTRL1](#) must be turned off (set to zero).

2.5.5 Default Configurations that should be modified

Although the DW1000 will power up in a usable mode for the default configuration outlined, some of the register defaults are sub optimal and should be overwritten before proceeding to use the device in the default mode.

2.5.5.1 AGC_TUNE1

AGC_TUNE1 is set to 0x889B by default which is not the optimal value for the default PRF of 16 MHz. For best performance the user should set this value to 0x8870 before proceeding to use the default device configuration. Refer to [Sub-Register 0x23:04 – AGC_TUNE1](#).

2.5.5.2 AGC_TUNE2

AGC_TUNE2 must be set as described in [Sub-Register 0x23:0C – AGC_TUNE2](#) for correct functioning of DW1000.

2.5.5.3 DRX_TUNE2

DRX_TUNE2 is set to 0x311E0035 by default which is not the optimal value for the default PRF and PAC. For best performance the user should set this value to 0x311A002D before proceeding to use the default device configuration. Refer to [Sub-Register 0x27:08 – DRX_TUNE2](#).

2.5.5.4 NSTDEV

NSTDEV is set to 0xC by default and may be set to 0xD for better performance, refer to [Sub-Register 0x2E:0806 – LDE_CFG1](#).

2.5.5.5 LDE_CFG2

LDE_CFG2 is set to 0x0000 by default and should be set to 0x1607 for 16 MHz PRF before proceeding to use the default configuration, refer to [Sub-Register 0x2E:1806– LDE_CFG2](#).

2.5.5.6 TX_POWER

The TX_POWER setting is 0x1E080222 by default. This value should be set to 0x0E082848 before proceeding to use the default configuration. Please see section [7.2.31.1 – Smart Transmit Power Control](#) for further information.

2.5.5.7 RF_TXCTRL

RF_TXCTRL is not set to the optimum values by default. This value should be set for channel 5 according to Table 34 before proceeding to use the default configuration. Please see [Sub-Register 0x28:0C– RF_TXCTRL](#) for further information.

2.5.5.8 TC_PGDELAY

TC_PGDELAY is set to 0xC5 by default, which is the incorrect value for channel 5. This value should be set to 0xC0 before proceeding to use the default configuration. Please see [Sub-Register 0x2A:0B – TC_PGDELAY](#) for further information.

2.5.5.9 FS_PLLTUNE

FS_PLLTUNE is set to 0x46 by default, which is not the optimal value for channel 5. This value should be set to 0xA6 before proceeding to use the default configuration. Please see [Sub-Register 0x2B:0B – FS_PLLTUNE](#) for further information.

2.5.5.10 LDELOAD

LDELOAD is reset to 0 by default. This needs to be set as part of DW1000 initialisation and before receiver enable, if it is important to get timestamp and diagnostic information from received frames. See description of **LDELOAD** bit for further information. The table below outlines the programming steps to load the microcode from ROM into RAM.

Table 4: Register accesses required to load LDE microcode

Step Number	Instruction	Register Address	Data Length (Bytes)	Data (Write/Read)
L-1	Write Sub-Register	0x36:00 (PMSC_CTRL0)	2	0x0301
L-2	Write Sub-Register Wait 150 μs	0x2D:06 (OTP_CTRL)	2	0x8000
L-3	Write Sub-Register	0x36:00 (PMSC_CTRL0)	2	0x0200

3 Message Transmission

3.1 Basic Transmission

The transmission of data frames is one of the basic functions of the DW1000 transceiver. Figure 10 shows the elements of the transmitted frame.

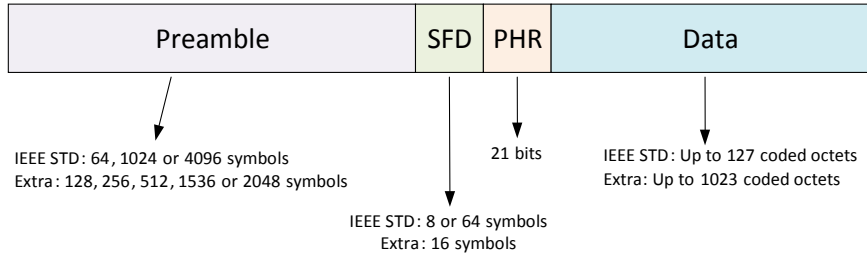

*Additional configurations marked "Extra" are proprietary to DecaWave

Figure 10: Transmit Frame format

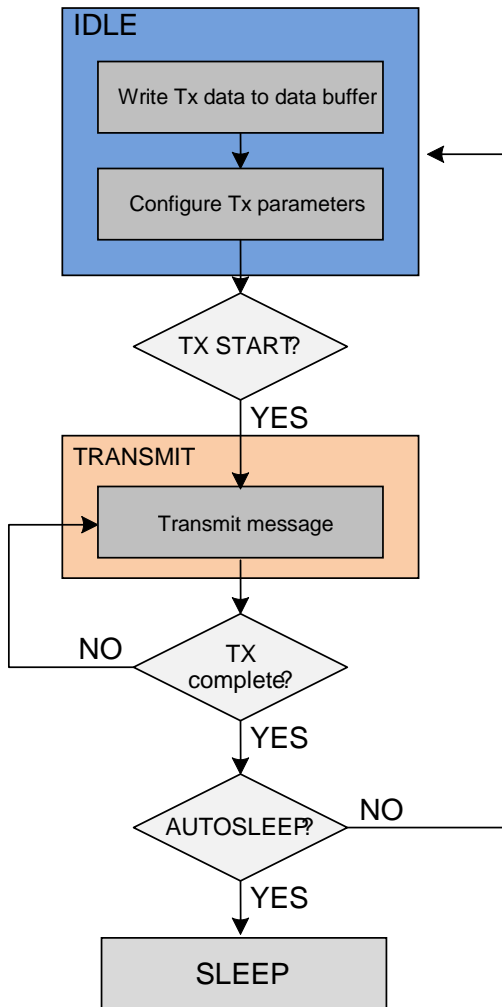

The modulation details of these frame elements can be found in section 10 – APPENDIX 1: The IEEE 802.15.4 UWB physical layer.

The transmit sequence is as shown in Figure 11. The DW1000 begins in the IDLE state awaiting instruction from the host controller.

In order to transmit, the host controller must write data for transmission to Register file: 0x09 – Transmit Data Buffer. The desired selections for preamble length, data rate and PRF must also be written to Register file: 0x08 – Transmit Frame Control. Transmitter configuration is carried out in the IDLE state, but frame configurations may be carried out during active transmit as described in section 3.5 – High Speed Transmission. Assuming all other relevant configurations have already been made, the host controller initiates the transmission by setting the TXSTRT control bit in Register file: 0x0D – System Control Register. After transmission has been requested, the DW1000 automatically sends the complete frame; preamble, SFD, PHR and data. The FCS (CRC) is automatically appended to the message as an aid to the MAC layer framing.

The end of frame transmission is signalled to the host via the TXFRS event status bit in Register file: 0x0F – System Event Status Register, and the DW1000 returns to IDLE mode to await new instructions.

Figure 11: Basic Transmit Sequence

Further transmission features are described in the following sections:

- Transmit message time-stamping – see section [3.2 –Transmission timestamp](#).
- Delayed transmission – see section [3.3 – Delayed Transmission](#).
- Long transmit frames – see section [3.4 –Extended Length Data Frames](#).
- High Speed transmit – see section [3.5-High Speed Transmission](#).

3.2 Transmission timestamp

During frame transmission the start of the PHR (PHY header) is the event nominated by the IEEE 802.15.4 UWB PHY standard for message time-stamping. The time the first symbol of the PHR launches from the antenna (defined as the RMARKER) is the event nominated as the transmit time-stamp.

The DW1000 digital transmit circuitry takes note of the system clock counter as the RAW transmit timestamp at the point when it begins sending the PHR. It then adds to this the transmit antenna delay (configured in [Register file: 0x18 – Transmitter Antenna Delay](#)) to get the antenna adjusted transmit time-stamp that it writes to the TX_STAMP field of [Register file: 0x17 – Transmit Time Stamp](#).

See also section [8.3 – IC Calibration – Antenna Delay](#).

3.3 Delayed Transmission

For delayed transmission, the transmit time is programmed into [Register file: 0x0A – Delayed Send or Receive Time](#) and then the delayed transmission is initiated by setting both TXDLYS and TXSTRT controls in [Register file: 0x0D – System Control Register](#).

One of the design goals of delayed transmission was that the specified transmission time would be predictable and aligned with the Transmit timestamp. This was achieved in that the transmission time specified is the time of transmission of the RMARKER (not including the TX antenna delay), that is the raw TX time, TX_RAWST in [Register file: 0x17 – Transmit Time Stamp](#) before the antenna delay is added. This allows for the time of transmission of a message to be pre-calculated and embedded in the message being transmitted.

NOTE: The low-order 9 bits of the delayed Transmit value programmed into [Register file: 0x0A – Delayed Send or Receive Time](#) are ignored giving a time resolution of 8 ns, or more precisely $4 \div (499.2 \times 10^6)$. To calculate the time of transmission of the RMARKER at the antenna, the low 9 bits of the delayed TX time should be zeroed before adding the TX antenna delay.

In performing a delayed transmission, the DW1000 calculates an *internal start time* for when to begin sending the preamble to make the RMARKER raw timestamp agree with the programmed transmit time. The DW1000 remains in idle state until the system time ([Register file: 0x06 – System Time Counter](#)) reaches the correct point to turn on the transmitter and begin preamble.

One use of delayed transmission (and reception), is in symmetric double-sided two-way ranging, (described in [APPENDIX 3: Two-Way Ranging](#)), where it is important to keep the response times the same at both ends to reduce the error in range estimate. Minimising the response time also reduces this error, and in working

to minimise this the host microprocessor may sometimes be late invoking the delayed TX, i.e. so that the system clock has passed the specified start time (i.e. *internal start time* mentioned above) and then the IC has to complete almost a whole clock count period before the start time is reached. The HPDWARN event status flag in [Register file: 0x0F – System Event Status Register](#) warns of this “lateness” condition so that during application development the delay may be chosen large enough to generally avoid this lateness. The HPDWARN status flag also serves to facilitate detection of this late invocation condition so that recovery measures may be taken should it ever occur in deployed product. For delayed transmission it is the *internal start time* mentioned above that is used when deciding whether to set the HPDWARN event for the delayed transmit. As long as the preamble start time is the near future, the HPDWARN event flag will not be set. If a long delay was intended then the HPDWARN flag can be ignored and the transmission will begin at the allotted time. If a long delay was not intended then the transmission can be stopped by issuing a TRXOFF via [Register file: 0x0D – System Control Register](#).

Under normal circumstances the IC transmitter needs a few microseconds to power up the transmitter – this time is correctly handled for the RMARKER positioning, but is not included in the HPDWARN calculation. So, if the initiation of a delayed transmission is commanded early enough so that it does not generate a HPDWARN event but not sufficiently early for the IC transmitter to power up before the start of preamble; then frame transmission will still occur and the RMARKER will be sent at the correct time, but, during the initial few symbols of preamble (while the transmitter is powering-up) the preamble may not be sent correctly. For most use cases this will not be an issue, as there is generally ample preamble remaining for good reception. However for shorter preamble sequences, especially the 64-symbol preamble sequence, losing a few symbols can have a performance effect.

When using delayed transmission with 64-symbol preambles then, designers should also be aware that the power-up time for the transmitter is not included in the HPDWARN calculation which means that if the preamble start time is too close then the initial few symbols of preamble (while the transmitter is powering-up) may not be sent correctly. This is flagged in a transient TXPUTE bit status and counted in [Sub-Register 0x2F:1A – Transmitter Power-Up Warning Counter](#), (assuming counting is enabled by the EVC_EN bit in [Sub-Register 0x2F:00 – Event Counter Control](#)). It is recommended that checks are added, during design validation, to ensure that the HPDWARN event does not happen and also (especially for short preambles) that the TXPUTE event does not happen, and take appropriate measures to avoid them (like increasing the response delay time).

3.4 Extended Length Data Frames

Standard IEEE 802.15.4 UWB frames carry up to 127 bytes of payload. The DW1000 supports a non-standard mode of operation with frame lengths up to 1023 bytes of data. This mode of operation is enabled via the PHR_MODE selection bits of [Register file: 0x04 – System Configuration](#).

In this proprietary mode the PHY header (PHR) is redefined to carry the 3 extra bits of frame length. In order to communicate extended length data frames between two DW1000 devices both ends must be set to the long frame PHY header mode via the PHR_MODE selection bits of [Register file: 0x04 – System Configuration](#). If the setting is only at one end of a link any attempt at communication will fail with PHR errors being reported. When long frame mode is selected the DW1000 will be unable to communicate with any device

operating with standard frame encoding because the SECDED error check sequence of the PHR in long frame mode is incompatible with the standard encoding.

Note also that the probability of an error occurring within a frame increases as the frame length is increased, and as a result of this increasing the frame length may or may not improve system throughput depending on the frame error rate and the need to retransmit frames when there is an error.

In long frame mode only the high order bit of the TXPSR value from [Register file: 0x08 – Transmit Frame Control](#) is sent in the PHR and reported in the RXPSR value in [Register file: 0x10 – RX Frame Information Register](#).

3.5 High Speed Transmission

Certain features of the DW1000 are designed to support maximum utilisation of the transmitter. These features are described below:

3.5.1 TX buffer offset index

The TXBOFFS field (in [Register file: 0x08 – Transmit Frame Control](#)) allows the TX_BUFFER to be used to hold more than one frame, (providing that data can fit within the 1024 octets of the buffer). In initiating a transmission then the host controller will set the TXBOFFS offset index to the first octet of the frame to be transmitted and set the length field to reflect the length of the frame to send. While sending is in progress, the host controller can prepare and write another frame to a different part of the TX_BUFFER. After transmission of the first frame then, the host has saved the time needed to write the next data frame, and just needs to set the offset and initiate the transmission of the next frame.

During a data streaming or bulk data transfer then the host controller might divide the TX_BUFFER into two areas of 512 octets each, sending from them alternately. For acknowledged data transfer then: the receipt of the acknowledgement for frame, frame “A” (say), can be used to trigger the sending of the next frame, frame “B” (say), that is already waiting in the other half of the buffer and at the same time signalling that the buffer half that contained the acknowledged frame “A” can now, (while frame “B” is being transmitted), be filled with the data for the subsequent frame, frame “C” (say). Where the acknowledgement for frame “A” is not received, the data for it is still in the TX_BUFFER ready to be retransmitted.

3.5.2 TX buffer write while sending

For fast turnaround it is possible to initiate preamble sending before writing the frame data to the TX_BUFFER or writing the frame length to the length as specified in the TFLEN and TFLE fields of the [Register file: 0x08 – Transmit Frame Control](#). So preamble transmission can begin before the TX data is written into the DW1000. The host microprocessor then has the time of the any fixed response delay, and the time for sending preamble and SFD before it needs to have the frame length set in TFLEN and TFLE ready for the DW1000 to insert into the PHR, and thereafter the host microprocessor needs to have the individual octets of data written into the TX_BUFFER before they are consumed by the DW1000 transmitter.

Clearly to do this care needs to be taken to have the frame length setup ready for inclusion in the PHR and to have the data written into the TX_BUFFER before it is consumed, and, mechanisms are needed to ensure

that the wrong data cannot be sent as a good frame. The mechanisms to achieve this involves using SFCST to suppress FCS transmission until all data is written to the TX_BUFFER and then CANSFCS to cancel this suppression so that the FCS will be sent. (Both SFCST and CANSFCS are in [Register file: 0x0D – System Control Register](#)).

While this technique is of use for fast responses, it could also be used for streaming in cases where the use of the scheme described in section [3.5.1 – TX buffer offset index](#) is not suitable, i.e. where the frame size is between 513 and 1023 octets.

The following are the points of note for optimum throughput or fast response turnaround:

- (a) The frame length should be set up as early as possible:

For streaming, TFLEN, TFLE, TXBOFFS, may be reprogrammed for the next frame as soon as the PHR is sent, i.e. after the TXPHS (Transmit PHY Header Sent) event has been signalled.

For transmission of a response, depending on the application the length of the response may be known before the soliciting message has arrived. This is often true for example in two-way ranging.

- (b) Initiate transmission as early as possible:

For streaming this is as soon as the previous transmission has finished. This is signalled by the activation of the TXFRS (Transmit Frame Sent) event status bit is set in [Register file: 0x0F – System Event Status Register](#), an event that would generally be picked up by an interrupt handler in the host system.

For transmission of a response, the application may have to parse some of the message before deciding whether a response is required. This parsing could perhaps be begun early but in any case the initiation of transmission will in general be as soon as possible after the arrival of the message soliciting the response. Message arrival is signalled by the RXDFR (Receiver Data Frame Ready) event status bit in [Register file: 0x0F – System Event Status Register](#), an event also generally picked up by an interrupt handler in the host system.

Issue the TXSTRT with SFCST (Transmit Start with Suppress auto-FCS Transmission) instruction in [Register file: 0x0D – System Control Register](#) to initiate the transmission. This will kick off preamble transmission.

- (c) Write the frame data to the TX_BUFFER as fast as possible.

This might be done in the interrupt handler or in a high priority task scheduled by it.

- (d) Cancel the suppression of FCS as soon as possible thereafter.

This is done by issuing the CANSFCS (Cancel Suppression of auto-FCS transmission) instruction in [Register file: 0x0D – System Control Register](#). Assuming that the host has written every octet of data to the TX_BUFFER before the DW1000 needed to consume it, then this will be successful and the frame will be sent with a good CRC, and that is essentially the end of the discussion on this technique.

If the host system has not been quick enough in writing the data this will result in the frame being sent with the wrong data but with a bad CRC also. The DW1000 transmitter includes a circuit to detect the host microprocessor writing to the buffer between the selected TXBOFFS and any address the IC has already consumed the data from, which is taken to mean that the data is being written too late for transmission. This “*Transmit Buffer Error*” condition will cause the DW1000 to ignore the CANSFCS command so the frame is sent with a bad CRC. It is signalled by the TXBERR bit in [Register file: 0x0F – System Event Status Register](#). Clearly this is a bad condition that will not help system performance. It is up to system designers to avoid this condition, debugging and removing it during the design phase, by ensuring the system responsiveness is sufficient that this never happens, (e.g. by employing a faster processor or a faster SPI, or by increasing the response/inter-frame delay or increasing the preamble length).

4 Message Reception

4.1 Basic Reception

The reception of a frame is enabled by a host request or by an automatic re-enabling of the receiver. The receiver will search for preamble continually until preamble has been detected or acquired, when a demodulation will be attempted. A preamble detection timeout may be set to allow the receiver to stop searching for preamble after a desired period. A basic receive sequence is shown in Figure 12.

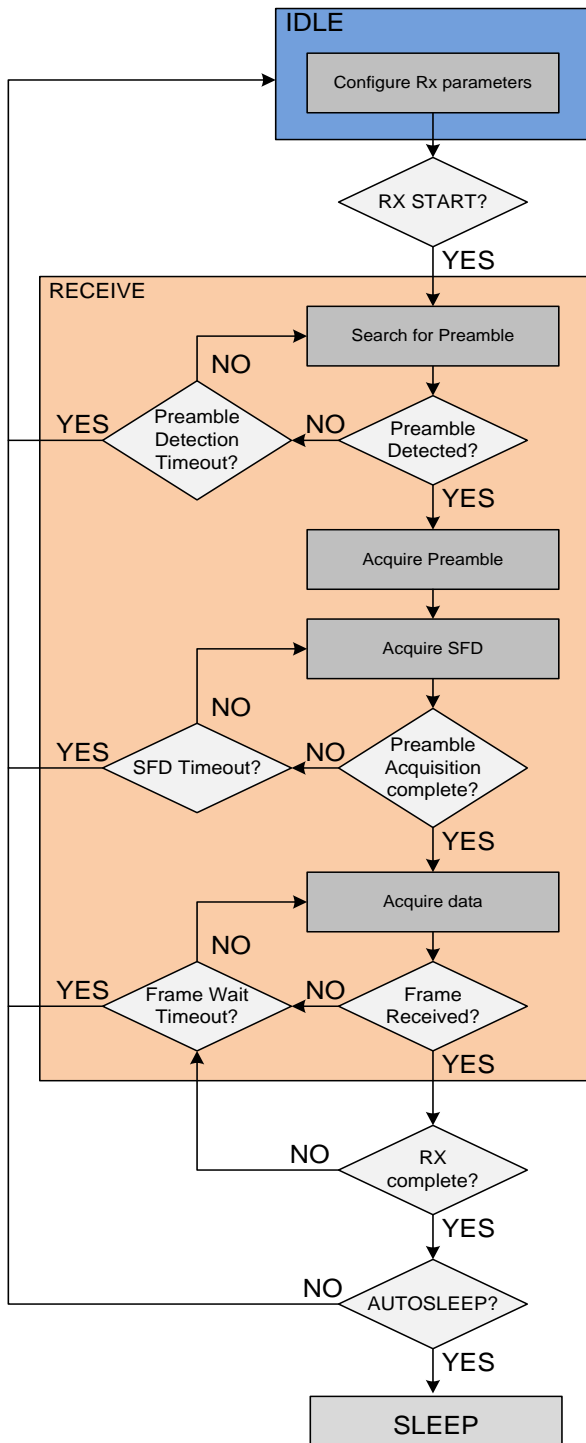

Figure 12: Basic receive sequence

4.1.1 Preamble Detection

The preamble sequence is detected by cross-correlating in chunks which are a number of preamble symbols long. The size of chunk used is selected by the PAC configuration in [Sub-Register 0x27:08 – DRX_TUNE2](#). The PAC size should be selected depending on the expected preamble size. A larger PAC size gives better performance when the preamble is long enough to allow it. But if the PAC is too large for the preamble length then receiver performance will be impaired, or fail to work at the extremes – (e.g. a PAC of 64 will never receive frames with just 64 preamble symbols). Table 5 gives the recommended PAC size configuration to use in the receiver depending on the preamble length being used in the transmitter.

Table 5: Recommended PAC size

Expected preamble length of frames being received	Recommended PAC size
64	8
128	8
256	16
512	16
1024	32
1536	64
2048	64
4096	64

The choice of preamble length is discussed in section [9.3 – Choice of data rate, preamble length and PRF](#).

It is possible to abort reception if a valid preamble is not detected within a configured time. This is done by using

the preamble detection timeout, programmable in [Sub-Register 0x27:24 – DRX_PRETOC](#). This may be useful after sending a message where a response is being awaited. Here if the preamble is not detected then the awaited response is not coming. The preamble detection time-out can be used to abandon the reception at the earliest possible time, saving power.

The preamble detection state also has the possibility of operating in a mode called pulsed preamble detection mode (PPDM), or SNIFF mode, programmable through [Register file: 0x1D – SNIFF Mode](#). This is a technique that where the receiver samples (“sniffs”) the air periodically on a timed basis, e.g. 50% or 25% of the time, to reduce the power needed during preamble detection.

4.1.2 Preamble Accumulation

Once the preamble sequence is detected, the receiver begins accumulating correlated preamble symbols, while looking for the SFD sequence (a particular sequence of preamble symbols, see section [10.3 – Synchronisation header modulation scheme](#) for details). Accumulation stops when the SFD is detected, but may stop earlier if the accumulator grows quickly, (as is the case in close line-of-sight conditions for instance), in this case the receiver continues receiving preamble, without accumulating, searching for the SFD sequence.

4.1.3 SFD Detection

The detection of SFD is a key event in the reception of a frame, because it marks the start of the PHY header, which defines the RMARKER that is time-stamped (see section [4.1.6–RX Message timestamp](#)), and it marks the change from preamble demodulation to the BPM/BPSK demodulation of the PHR (and data subsequently).

It is possible to abort reception if the SFD is not detected within a certain time after preamble is detected. This functionality is configured via [Sub-Register 0x27:20 – DRX_SFDTOC](#). This SFD detection timeout guards against false detection of preamble (which has a finite chance of happening) that could otherwise lead to a prolonged period receiving nothing. By default the SFD detection timeout is 4161 symbol times, (i.e. greater than the largest possible preamble), but it can be set lower if it is known that all nodes in the network are using shorter preambles. It is possible to disable the SFD detection timeout but this is not advised.

The SFD sequence is 64 symbols long for 110 kbps data rate and 8 symbols long for the other two supported data rates of 850 kbps and 6.8 Mbps. The receiver needs to be configured to look for either the short 8-symbol SFD or the long 64-symbol SFD. This is done via the RXM110K configuration bit in [Register file: 0x04 – System Configuration](#).

The DW1000 also has the capability of programming non-standard SFD sequences that give improved performance, see [Register file: 0x21 – User defined SFD](#) sequence.

4.1.4 PHR Demodulation

The main role of the PHY Header (PHR) is to convey the length of the data portion of the frame, and to indicate the data rate being employed for data demodulation. See section [10.4 – PHY header](#) for details of the PHY header. For data rates of 850 kbps and 6.8 Mbps the PHR is modulated / demodulated as per the

850 kbps data rate (note that because Reed Solomon encoding is not applied to the PHR, its bit rate is approximately 1 Mbps). If the PHR is indicating 850 kbps then the data demodulation continues at this rate, but if the PHR is indicating 6.8 Mbps then the demodulation changes to this rate at the end of the PHR as data demodulation begins.

4.1.5 Data Demodulation

Section [10.2 – Data modulation scheme](#) describes the modulation scheme. In the receiver a Viterbi decoder is used to recover the data bits (this is also used for PHR reception) which are then passed through the Reed Solomon decoder to apply any further correction it can. Every octet thus received is passed through a CRC checker to which at the end of the frame is checked against the transmitted FCS.

As the data octets are received they may also be parsed by the frame filtering function if enabled, see section [5.2 – Frame filtering](#) for more details.

Successful reception of a frame is signalled to the host via the RXDFR and RXFCG event status bits in [Register file: 0x0F – System Event Status](#) Register. Other status bits in this register may be used to flag reception of other parts of the frame or, events indicating failure, i.e. RXPTO (Preamble detection Timeout), RXSFDTO (SFD timeout), RXPHE (PHY Header Error), RXRFSL (Reed Solomon error), RXRFTO (Frame wait timeout), etc.

Other related features are:

- Delayed reception – see section [4.2 – Delayed Receive](#).
- Long receive frames – see section [3.4 – Extended Length Data Frames](#).
- Double buffering – see section [4.3 – Double Receive Buffer](#).
- Receive message time-stamping – see section [4.1.6 – RX Message timestamp](#).

4.1.6 RX Message timestamp

During frame reception the SFD detection event marking the end of the preamble and the start of the PHR is the nominal point which is time-stamped by the IC. The IEEE 802.15.4 UWB standard nominates the time when this RMARKER arrives at the antenna as the significant event that is time-stamped.

The DW1000 digital receiver circuitry takes a coarse timestamp of the symbol in which the RMARKER event occurs and adds a various correction factors to give a resultant adjusted time stamp value, which is the time at which the RMARKER arrived at the antenna. This includes subtracting the receive antenna delay as configured in [Sub-Register 0x2E:1804 – LDE_RXANTD](#) and adding the correction factor determined by the first path (leading edge) detection algorithm embedded in the DW1000. The resulting fully adjusted RX timestamp is written into [Register file: 0x15 – Receive Time](#) Stamp.

See also section [8.3 – IC Calibration – Antenna Delay](#).

N.B. Due to an issue in the re-initialisation of the receiver, it is necessary to apply a receiver reset after an error or timeout event (i.e. RXPTO (Preamble detection Timeout), RXSFDTO (SFD timeout), RXPHE (PHY Header Error), RXRFSL (Reed Solomon error), RXRFTO (Frame wait timeout), etc.). This ensures that the next good frame will have correctly calculated timestamp. For details on how to apply a receiver-only reset see SOFTRESET field of [Sub-Register 0x36:00 – PMSC_CTRL0](#).

4.2 Delayed Receive

In Delayed receive operation the receiver turn-on time is programmed into [Register file: 0x0A – Delayed Send or Receive Time](#) and then the delayed receiving is initiated by setting both RXDLYE and RXENAB controls in [Register file: 0x0D – System Control Register](#).

The DW1000 remains in idle state until the system time ([Register file: 0x06 – System Time Counter](#)) reaches the value programmed in [Register file: 0x0A – Delayed Send or Receive Time](#) and then the IC receiver is turned on. This point marks the start time for any programmed timeouts that apply to the reception process, i.e. the preamble detection timeout (which is set and enabled by [Sub-Register 0x27:24 – DRX_PRETOC](#)) and the frame wait timeout (which is enabled by the RXWTOE configuration bit in [Register file: 0x04 – System Configuration](#), and whose period is programmed in [Register file: 0x0C – Receive Frame Wait Timeout Period](#)).

The benefit of delayed receive is that the receiver can be turned on at just the right moment to receive an expected response, especially when that response is coming from a DW1000 employing delayed transmit to send the response message at a precise time. This saves power because the idle mode power counting down to the RX enable time is significantly less than the power required during frame reception.

One use of delayed receive, and especially delayed transmission, is in symmetric double-sided two-way ranging, (described in [APPENDIX 3: Two-Way Ranging](#)), where it is important to keep the response times the same at both ends to reduce the error in range estimate. Minimising the response time also reduces this error, and here it is possible for the host microprocessor to be late invoking the delayed TX or RX, so that the system clock is beyond the specified start time and then the IC has to complete almost a whole clock count period before the specified start time is reached. The HPDWARN event status flag in [Register file: 0x0F – System Event Status Register](#) warns of this “lateness” condition so that during development a delay may be chosen large enough to generally avoid this lateness. The HPDWARN status flag also serves to facilitate detection of this late invocation condition so that recovery measures may be taken should it ever occur in deployed product.

4.3 Double Receive Buffer

This DW1000 has a pair of receive buffers offering the capability to receive into one of the pair while the host system is reading previously received data from the other buffer of the pair. This is useful in a TDOA RTLS anchor node where it is desired to have the receiver on as much as possible to avoid missing any tag blink messages. A number of ancillary registers (timestamps, quality indicators and status bits) are also doubly-buffered. The registers that are part of this “RX double-buffered swinging-set” are listed in Table 6.

N.B. If overruns occur (see section 4.3.5), received frame data will be corrupted. Double buffering must not be used in systems where overruns may be likely or frequent and is best used in systems where host processing of the received frames is such that overruns will never occur.

Table 6: Registers in the RX double-buffered swinging-set

RX double-buffered registers
LDEDONE, RXDFR, RXFCE and RXFCG bits in Register file: 0x0F – System Event Status Register
All of Register file: 0x10 – RX Frame Information Register
All of Register file: 0x11 – RX Frame Buffer
All of Register file: 0x12 – Rx Frame Quality Information
All of Register file: 0x13 – Receiver Time Tracking Interval
All of Register file: 0x14 – Receiver Time Tracking Offset
All of Register file: 0x15 – Receive Time Stamp

4.3.1 Enabling double-buffered operation

By default the DW1000 operates in a single buffered mode that is appropriate for many applications. When using double-buffered mode it is appropriate to also configure the DW1000 to automatically re-enable the receiver (moving on to the other buffer of the swinging set) as soon as it has completed receiving any previous frame. Double-buffered receiving is enabled by setting the DIS_DRXB bit to zero, (in [Register file: 0x04 – System Configuration](#)). The RX auto-re-enable function is enabled by setting the RXAUTR bit to 1 (in [Register file: 0x04 – System Configuration](#)).

DW1000 may be operated in double buffered mode without automatically re-enabling the receiver also, which requires the host to manually enable the receiver to receive the next frame. The receiver can be enabled in advance of processing the previously received frame. This operation will reduce the amount of time for which the receiver may be actively listening for frames on the air, but will prevent both buffers being full (at the same time) and will prevent overflows. This simplifies the buffer operation, see sections 4.3.3 and 4.3.5.

Note: When enabling or re-enabling the receiver in double-buffered mode, it is important to align both host and IC receivers. That is, it is important to ensure that the buffer set that the IC receiver will first receive into is the same set that the host system is pointing to and will first process when the first frame arrives. Please refer to section 4.3.2 below for a discussion of this and how to achieve it.

4.3.2 Controlling which buffer is being accessed

There are two register sets, register-set-0 and register-set-1, but the host may only access one set at a time through the register addresses listed in Table 6. To swap between sets the host issues the HRBPT (Host Side Receive Buffer Pointer Toggle) command in [Register file: 0x0D – System Control Register](#). The register-set currently being accessed is reported by the HSRBP (Host Side Receive Buffer Pointer) status bit in [Register file: 0x0F – System Event Status Register](#). Every time the HRBPT command is issued the HSRBP status bit will toggle.

There is also a read-only IC side buffer pointer index indicating which register-set the IC receiver is using or will use for the next frame received, this is the ICRBP status bit (also in [Register file: 0x0F – System Event](#)

Status Register). Reception of a new frame with good CRC will cause the ICRBP bit to increment (or toggle). In the case that a received frame is rejected by frame filtering or bad CRC the ICRBP will not move on and the buffer will be reused for the next incoming frame.

Thus, as noted in section 4.3.1 above, before enabling the receiver it is important to align both host and IC receivers. This is done by reading the SYS_STATUS register 0x0F to checking that the HSRBP and ICRBP status bits are the same, (i.e. both 1 or both 0), and if not issuing the HRBPT command to toggle HSRBP to be the same as ICRBP.

4.3.3 Operation of double buffering

In normal operation the IC will receive a frame into the RX buffer (pointed to by ICRBP) and when the frame is complete the IC will set the RXFCG interrupting the host and move on to receive into the other buffer of the double-buffered swinging-set. Following this the host system should see this interrupt and service it by reading the received data from the buffer along with any of the other ancillary registers it wants, and then issue the HRBPT command to move to point to the other buffer. This HRBPT command also serves as the mechanism to tell the IC that the host has finished with processing this received buffer (and is moving on to the next one) essentially allowing the IC to reuse it for follow on frames. Figure 13 below is a flow chart showing the use of double buffering in the receiver.

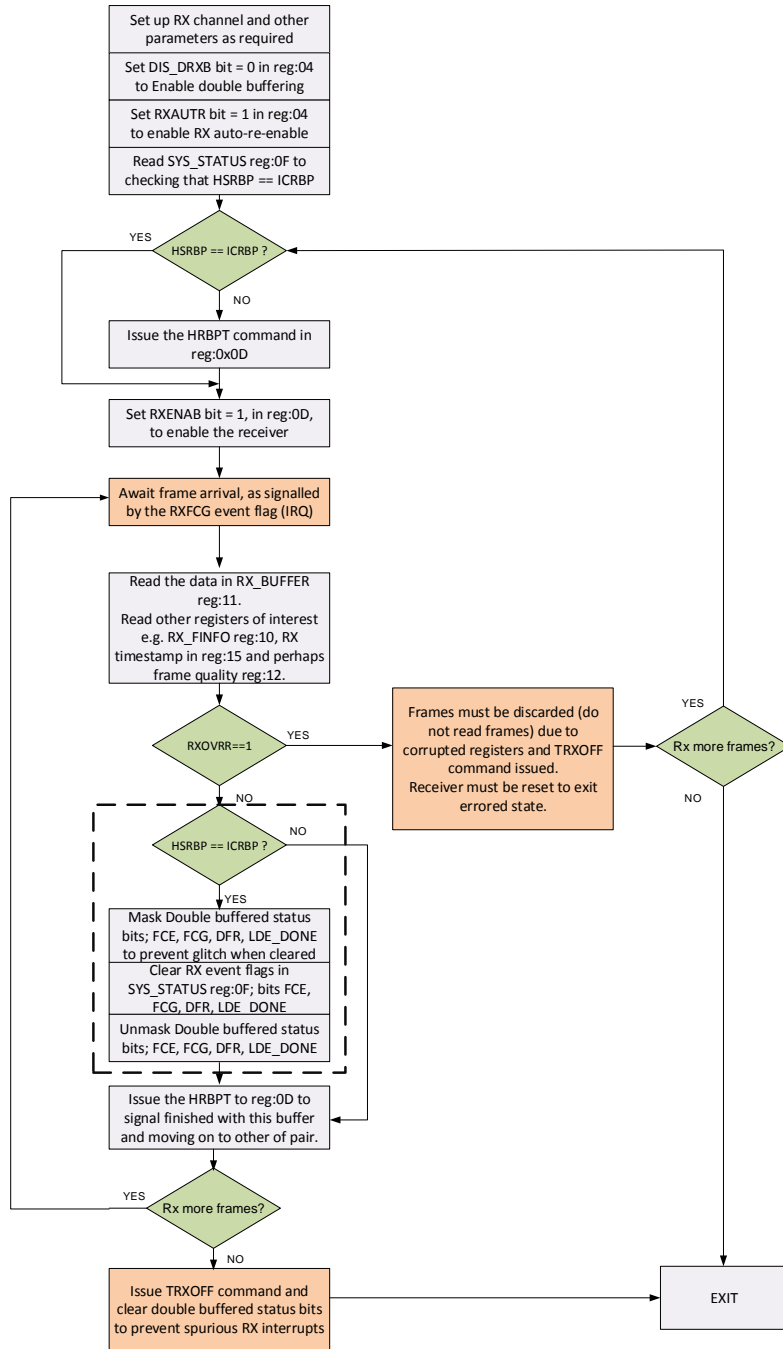

Figure 13: Flow chart for using double RX buffering

In Figure 13 the section marked by the dashed black line can be omitted if the host system is able to service the buffers with sufficient speed so that both buffers are never full at the same time. If this can be guaranteed then an overrun (RXOVR) can never occur and so cannot corrupt good frames, see section 4.3.5. In this case, buffer handling is simplified.

4.3.4 TRXOFF when using Double Buffering

To prevent spurious interrupts and for predictable behavior, TRXOFF should be applied as shown below. The double-buffered status bits should be cleared after the TRXOFF is applied and the interrupts on double-buffered status bits should be masked while the bits are cleared.

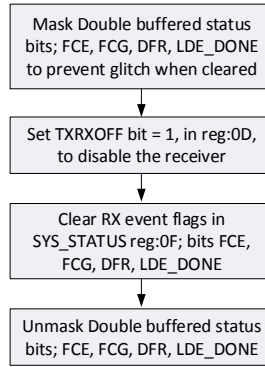

Figure 14 : TRXOFF in Double-Buffered Mode

4.3.5 Overrun

An overrun condition may occur in the IC receiver if the host side is not keeping up with the arrival rate of frames. So for example, say the IC receives a frame into the first buffer, moves on to the other buffer and places a receive frame in it also. The IC will then move back to point to the first buffer again. If the host has not completed reading the data from this first buffer (i.e. not yet issued the HRBPT) then the IC will not overwrite that buffer with any new frame if one arrives. If a new frame arrives and the IC is unable to write data to the buffer (because the host has not issued the HRBPT), then this gives rise to an overrun condition. The overrun condition occurs at the point the receiver finishes processing a good PHY header and needs to write the first octet of data to the RX buffer. This event is detected by the IC and reported in the RXOVRR status bit in *Register file: 0x0F – System Event Status Register*.

When a receiver overrun occurs, the frame reception in progress will be aborted and, assuming RX auto-re-enable is enabled (by RXAUTR) the receiver will begin looking for preamble again. The overrun condition and the RXOVRR status bit will be cleared as soon as the host issues the HRBPT command. Receiver overrun events are also counted in *Sub-Register 0x2F:0E – RX Overrun Error Counter*, assuming that counting is enabled by the EVC_EN bit in *Sub-Register 0x2F:00 – Event Counter Control*.

The overrun condition results in the corruption of the good frames previously received. The RX_FINFO, RX_TIME and RX_FQUAL registers are affected. Received frames must be discarded due to corruption if an overrun (RXOVRR) occurs. A receiver-only reset must be applied to the receiving device to clear the errored state which may persist, see Figure 13. See the SOFTRESET field of *Sub-Register 0x36:00 – PMSC_CTRL0* for details of how to apply the receiver-only reset.

The impact of overrun corruption of previously received frames needs to be evaluated carefully in the intended application. For instance, if overruns can occur the system should not use automatic acknowledgements (see AUTOACK in SYS_CFG), as a corrupt frame will be acknowledged but then discarded.

4.4 Low-Power Listening

Low-power listening is a feature whereby the DW1000 is predominantly in the **SLEEP** state but wakes periodically for a very short time to sample the air for a preamble sequence. If no preamble is seen the DW1000 automatically returns to **SLEEP** for another period, however if preamble is seen the DW1000 does

not return to sleep but continues to receive preamble and the data frame, and after successful reception can generate a receive frame interrupt to wake the host microprocessor to process the frame.

A typical example of this would be to use a sleep time of 1 second and a wake-up period of 2 PAC intervals, where the average current for briefly listening and going back to sleep is very low. To wake up a device operating in this low-power listening receiver mode, a transmitting device then has to send sufficient data to ensure that it is heard by the listener. Essentially then the transmitter has to send > 1 second of message to ensure that it intersects with the short listening period of the receiving device. In practice this is done by sending the same message repeatedly and then there is a finite chance that the listener listens at a time when the preamble is not present. To avoid this, and give a better performing wakeup, the DW1000 includes the ability to do a two-phase listen. This has a long sleep period followed by a sampling of the air, followed by a short sleep period and then another sampling of the air. The short sleep time period is set to ensure that if the first listen hits a message (missing the preamble) then the next listen will see preamble. Figure 15 below shows the periodic listening for preamble and a wakeup sequence where the first listening period intersects with the PHR or DATA, but where the second listening period allows successful reception.

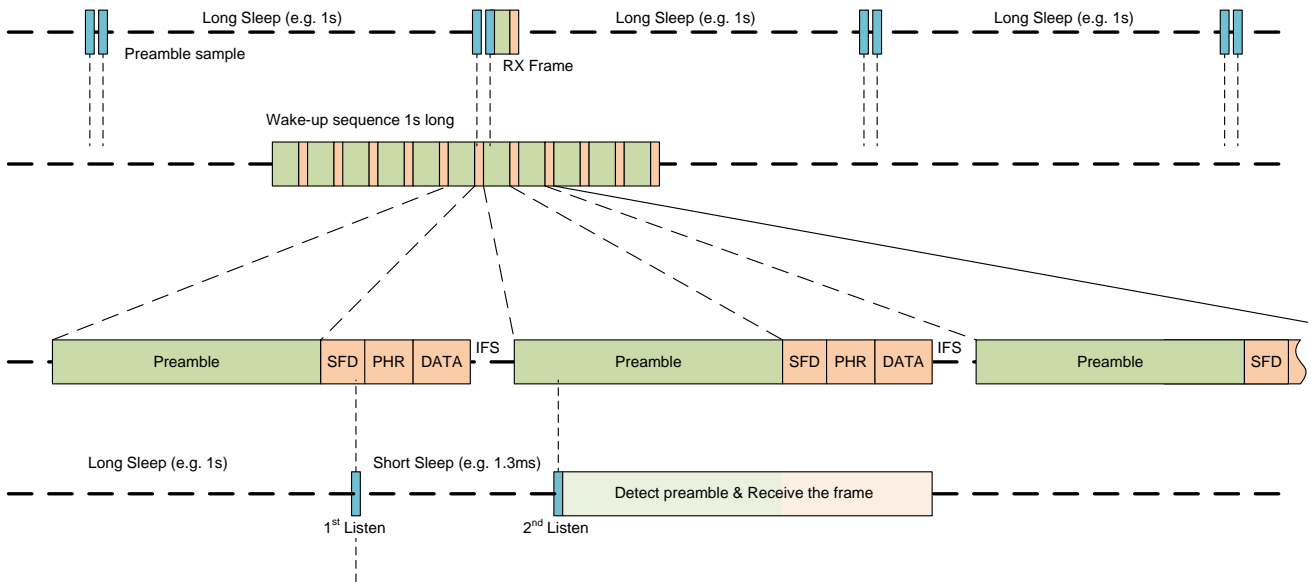

Figure 15: Low power listening with two sleep times

NOTE: Low-power listening works best for infrequent wake-ups across a population of listening nodes. The reason is that every listening node will see preamble and wake-up and consume power receiving the packet (even if the packet is not addressed to it).

In Figure 15 there is a long period in **SLEEP** (or **DEEPSLEEP**) followed by a wakeup to the **RX** state (on) to sniff for preamble, followed by (assuming no preamble is detected) a short period in **SNOOZE** state, followed by the second **RX** state (on) to look for preamble, and (again assuming no preamble is detected) a return to **SLEEP** (or **DEEPSLEEP**). Figure 16 shows the power profile associated with Low-Power Listening. If a preamble is detected in either of the two receive windows, then the frame will be demodulated and an interrupt set (if configured to do so).

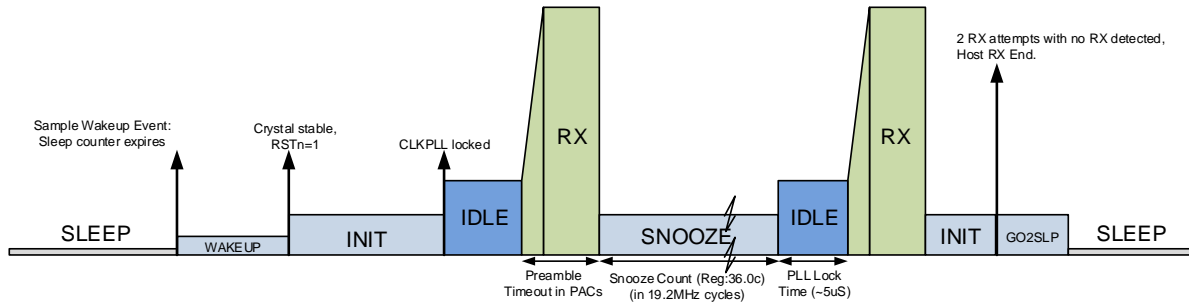

Figure 16: Power profile for low power listening mode where no frame is received

4.4.1 Configuring low-power listening

Configure the receiver parameters for channel, data rate, PRF, preamble code, etc. as required for normal receive operation. Then enable and configure the Low-Power Listening functionality as follows:

- Set ARXSLP (after RX automatically sleep) bit in *Sub-Register 0x36:04 – PMSC_CTRL1*.
- Set SNOZ_TIM (snooze time) field of *Sub-Register 0x36:0C – PMSC_SNOZT*.
- Set SNOZE (snooze enable) bit in *Sub-Register 0x36:04 – PMSC_CTRL1*.
- Set SNOZR (snooze repeat) bit in *Sub-Register 0x36:04 – PMSC_CTRL1*.
- Set SLEEP_TIM (sleep time period) field in *Sub-Register 0x2C:06 – AON_CFG0*.
- Set ONW_LDC (on wake load configurations) bit in *Sub-Register 0x2C:00 – AON_WCFG*.
- Set PRES_SLEEP (preserve sleep) bit in *Sub-Register 0x2C:00 – AON_WCFG*.
- Set only MRXFCG bit in *Register file: 0x0E – System Event Mask Register*.
- Set the RXENAB bit in *Register file: 0x0D – System Control Register*.

The DW1000 will then begin the low power listening, and will only generate an interrupt when a frame is received. Frame filtering can be enabled to further restrict the interrupt to only be generated when a correctly addressed frame is received. To save power in such a system the host microprocessor (if sufficiently capable) can enter a low power state awaiting the DW1000 interrupt to wake it when a frame arrives.

4.5 Low-Power SNIFF mode

Low-Power SNIFF mode is a lower power preamble hunt mode, also known as pulsed preamble detection mode (PPDM), where the receiver (RF and digital) is sequenced on and off rather than being on all the time. These on and off times are configurable in *Register file: 0x1D – SNIFF Mode*, and have default values of zero, disabling the feature. Using SNIFF mode causes a reduction in sensitivity depending on the ratio and durations of the on and off periods.

There are two variations of low power SNIFF mode; these are termed SNIFF and Low duty-cycle SNIFF described in the sub-sections below. The difference between the two modes is that in SNIFF mode the DW1000 alternates between the **RX** state (on) and the **IDLE** (off) state, while in Low duty-cycle SNIFF mode the IC spends the off time in the **INIT** state, transitioning only briefly through the **IDLE** state when entering the **RX** state. The choice of mode has implications for calculating the Sniff Off time, which is described below. The Low duty-cycle SNIFF mode will consume less power than SNIFF mode during the off period, but

both consume the same power during the on period. Figure 17 shows a simplified view of the state transitions during SNIFF mode.

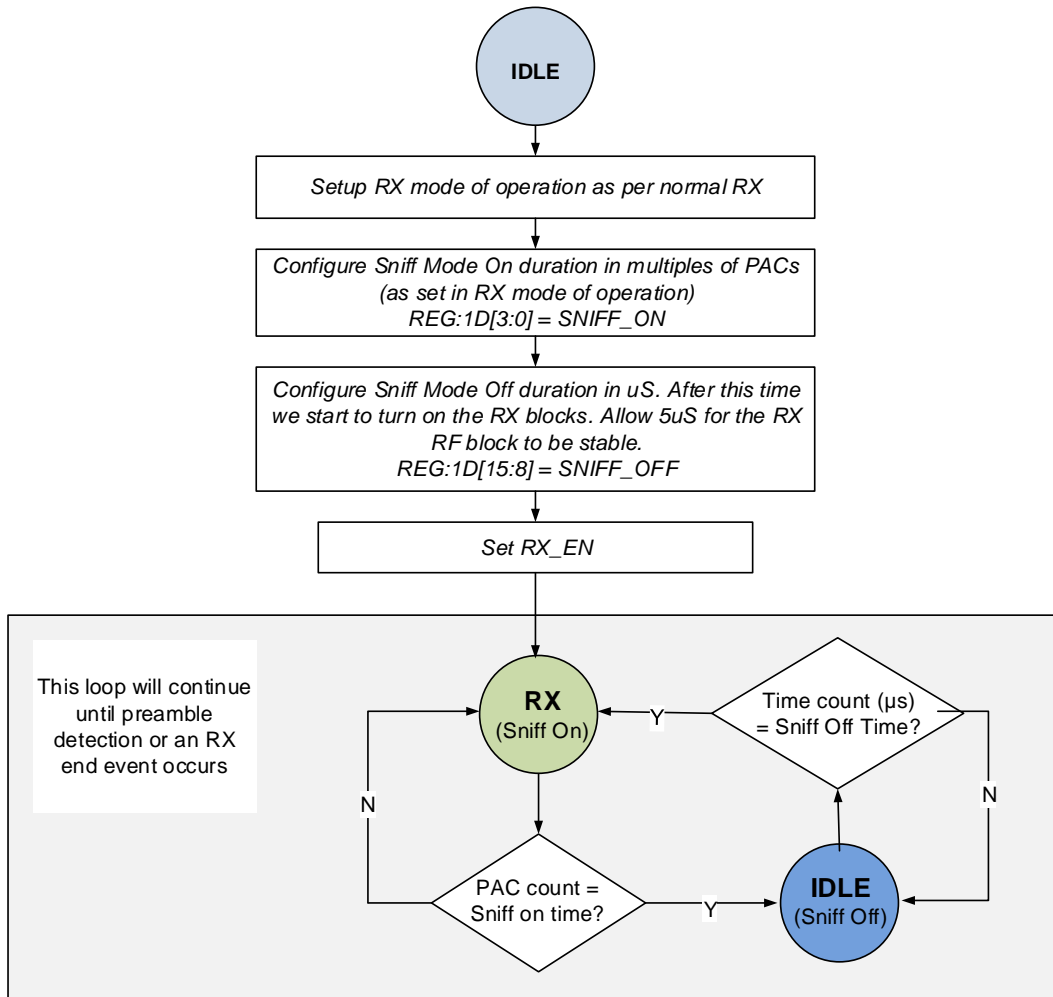

Figure 17: State transitions during SNIFF mode

4.5.1 SNIFF mode

In SNIFF mode the DW1000 alternates between the **RX** (on) and the **IDLE** (off) states. To enable SNIFF mode two parameters SNIFF_ONT (sniff on time) and SNIFF_OFFT (the off time) need to be configured in [Register file: 0x1D – SNIFF Mode](#). The on duration is programmed in units of PAC, (these are described in section [4.1.1 – Preamble Detection](#)), and must be set to at a minimum value of 2 for functional preamble detection. The off duration is programmed in units of 1 µs. When both on and off durations are programmed with non-zero values SNIFF will be operational from the next RX enable.

As an example if the PAC size is 8 symbols, (this is approximately 8 µs), and we want to have a 50:50 on-off duty cycle, then we could set SNIFF_ONT to its minimum of 2 PAC intervals and the SNIFF_OFFT to a value of 16 µs.

Figure 18 shows the power profile associated with SNIFF mode where the IC wakes up from **SLEEP** and progress into the repeated **IDLE-RX-IDLE-RX...** duty-cycle of the pulsed preamble detection mode. A timeout ends this and the DW1000 is returned to **SLEEP**.

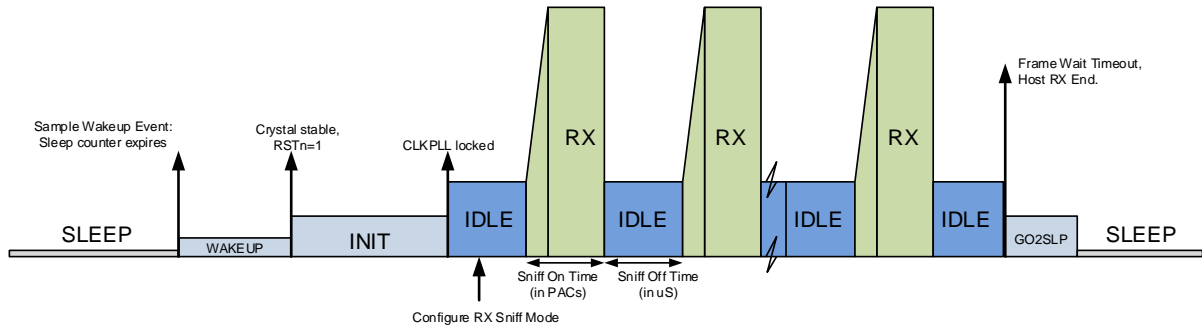

Figure 18: Power profile for SNIFF where a frame is not received

Figure 19 shows a power profile for SNIFF mode, similar to Figure 18, except in this case preamble is detected on the second period of RX sampling, and the DW1000 completes the reception of a frame.

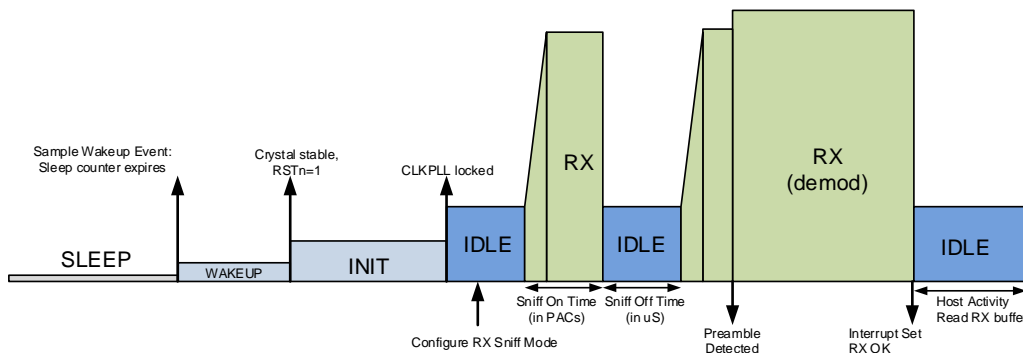

Figure 19: Power profile for SNIFF where a frame is received

4.5.2 Low duty-cycle SNIFF mode

In Low duty-cycle SNIFF mode, where the off time is larger, the DW1000 can be configured to spend this off time in the **INIT** state which is lower power than the **IDLE** state (used for the off period of a SNIFF). This is enabled by setting the ARX2INIT bit in *Sub-Register 0x36:04 – PMSC_CTRL1*, in addition to configuring the on and off times, SNIFF_ONT and SNIFF_OFFT, in *Register file: 0x1D – SNIFF Mode*. This instructs the receiver to go to the **INIT** state for the off period of the Low-Power SNIFF mode.

NOTE: In the **INIT** state the 125 MHz digital PLL clock is not running, instead the system is clocked at the raw 19.2 MHz XTI clock rate. Thus, in Low duty-cycle SNIFF mode the off period configured in the SNIFF_OFFT is in multiples of 6.6 μ s (instead of the 1 μ s units that apply in the SNIFF mode).

The power saving of Low duty-cycle SNIFF mode is only realised when the off period is greater than 1 (i.e. > 6.6 μ s). This is because after the timer expiry the DW1000 will enter the **IDLE** state as the PLL is turned on and locks (this takes approximately 5 μ s) before progressing into the **RX** state.

Figure 20 shows the power profile associated with Low duty-cycle SNIFF mode where the IC wakes up from **SLEEP** and progress into the repeated **INIT-(IDLE)-RX-INIT-(IDLE)-RX** cycles of the pulsed preamble detection mode. A timeout ends this and the DW1000 is returned to **SLEEP**.

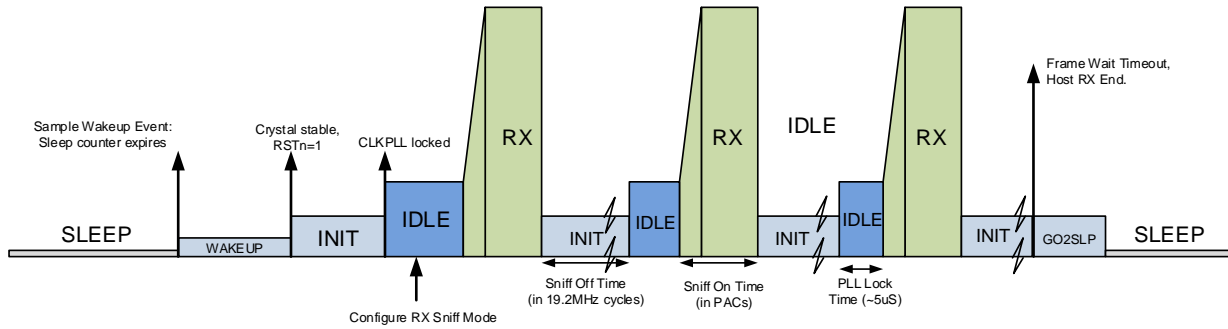

Figure 20: Power profile for Low duty-cycle SNIFF where a frame is not received

4.6 Diagnostics

The DW1000 includes the following diagnostic aids: -

- The ability to drive LEDs to show TX and RX activity, which may be useful during product development and in non-battery powered devices. The LED driving feature is an option on GPIO lines, and is configurable via [Sub-Register 0x26:00 – GPIO_MODE](#). Please refer to the register description for details of the supported functionality.
- Access to accumulator – of use during product development diagnostics. This is provided via [Register file: 0x25 – Accumulator CIR](#) memory. Please refer to its description for details.
- RX frame quality indications – of use for both product development diagnostics and for working diagnostics, e.g. for network management or for deciding on confidence level for an RTLS or ranging measurement. These are available through [Register file: 0x12 – Rx Frame Quality Information](#). Please refer to its description for details, and to section 4.7 – [Assessing the quality of reception and the RX timestamp](#).

4.7 Assessing the quality of reception and the RX timestamp

The DW1000 receiver is capable of receiving messages under many different conditions. In some circumstances it can be useful to assess the quality of the received signals and any timestamp data based on them.

In a network it may be useful to assess the quality of message reception from a particular node in order to change network routing or configurations related to that node to improve the reliability of the communications. For example to improve communications reliability the frame length might be shortened, or the data rate might be reduced, or the preamble length might be increased. In other situations with consistently good communications the preamble length might be shortened to reduce the transmission time, saving power and leaving more air-time free for other nodes to communicate.

In a TDOA RTLS system where a particular tag’s transmission is received at multiple anchors the quality of reception and more particularly the quality of the RX timestamp information might be used to select which anchors’ RX message timestamps to feed into the location engine.

The following details the elements of receive status reported by the DW1000 that may be used to assess the quality of a received message and any related timestamp.

- The *Standard Deviation of Channel Impulse Response Estimate (CIRE) Noise* value, reported in the STD_NOISE field of [Register file: 0x12 – Rx Frame Quality Information](#) may be used to give a measure of the noise associated with this and the received frame’s timestamp measurement. The STD_NOISE can be used as an absolute value or it may be compared with the *First Path Amplitude* value – in this latter case it is recommended that the amplitude value used for comparison is the value reported in FP_AMPL2 field of [Register file: 0x12 – Rx Frame Quality Information](#).

With a higher absolute CIRE noise figure it is more likely that the quality of receive timestamp will be poorer. High noise may mean that the real first path is irretrievably buried in the noise. Comparing the noise with the *First Path Amplitude* can give additional indication as to the quality of the first path measurement. Where the *First Path Amplitude* has a large headroom over the noise, then the received frame’s timestamp is likely to have been determined more precisely than when the *First Path Amplitude* is closer to the noise level.

- It is possible to compute an estimated receive power figure (using the equation and details given in section [4.7.2 – Estimating the receive signal power](#)) – for the purposes of this discussion this will be called RX_POWER. It is also possible to compute an estimated power for just the first path signal (using the equation and details given in section [4.7.1 – Estimating the signal power in the first path](#)) – for the purposes of this discussion this will be called FP_POWER. Using these two calculations it may be possible to say whether the channel is line-of-sight (LOS) or non-line-of-sight signal (NLOS). As a rule of thumb, if the difference between RX_POWER and FP_POWER, i.e. RX_POWER - FP_POWER, is less than 6dB the channel is likely to be LOS, whilst if the difference is greater than 10dB the channel is likely to be NLOS.

Where the RX timestamp relates to a frame that is received in the presence of a higher CIRE noise power, or relates to a non-line-of-sight path with attenuated first path, then that receive timestamp is naturally likely to be of lower quality than that determined from a crisp line of sight first path signal that is well above the noise floor.

Where a location system has an excess number receive timestamps to choose from then a quality estimate relating to each timestamp may be used to weight the timestamps or to choose the highest quality set to feed into the multilateration function of the location engine.

4.7.1 Estimating the signal power in the first path

An estimate of the power in the first path signal may be calculated (in dBm) using the formula:

$$\text{First Path Power Level} = 10 \times \log_{10} \left(\frac{F_1^2 + F_2^2 + F_3^2}{N^2} \right) - A \text{ dBm}$$

Where:

F_1 = the *First Path Amplitude (point 1)* magnitude value reported in the FP_AMPL1 field of [Register file: 0x15 – Receive Time Stamp](#),

- $F2$ = the *First Path Amplitude (point 2)* magnitude value reported in the FP_AMPL2 field of [Register file: 0x12 – Rx Frame Quality Information](#).
- $F3$ = the *First Path Amplitude (point 3)* magnitude value reported in the FP_AMPL3 field of [Register file: 0x12 – Rx Frame Quality Information](#).
- N = the *Preamble Accumulation Count* value reported in the RXPACC field of [Register file: 0x10 – RX Frame Information Register](#), and
- A = is the constant 115.72 for a PRF of 16 MHz, or, the constant 121.74 for a PRF of 64 MHz.

The resultant *First Path Power Level* (in dBm) may be compared with the estimated receive power figure calculated as per section [4.7.2 – Estimating the receive signal power](#).

4.7.2 Estimating the receive signal power

It is possible to calculate an estimate of the receive power level (in dBm) using the formula:

$$RX\ Level = 10 \times \log_{10} \left(\frac{C \times 2^{17}}{N^2} \right) - A\ dBm$$

Where:

- C = the *Channel Impulse Response Power* value reported in the CIR_PWR field of [Register file: 0x12 – Rx Frame Quality Information](#),
- N = the *Preamble Accumulation Count* value reported in the RXPACC field of [Register file: 0x10 – RX Frame Information Register](#), and
- A = is the value 115.72 for a PRF of 16 MHz, and, the value 121.74 for a PRF of 64 MHz.

This resultant receive power estimate is very close to the actual receive power at lower receive levels, but is lower than the actual receive power level at higher levels. Figure 21 below shows the relationship between the actual receive power and the power estimated by this technique.

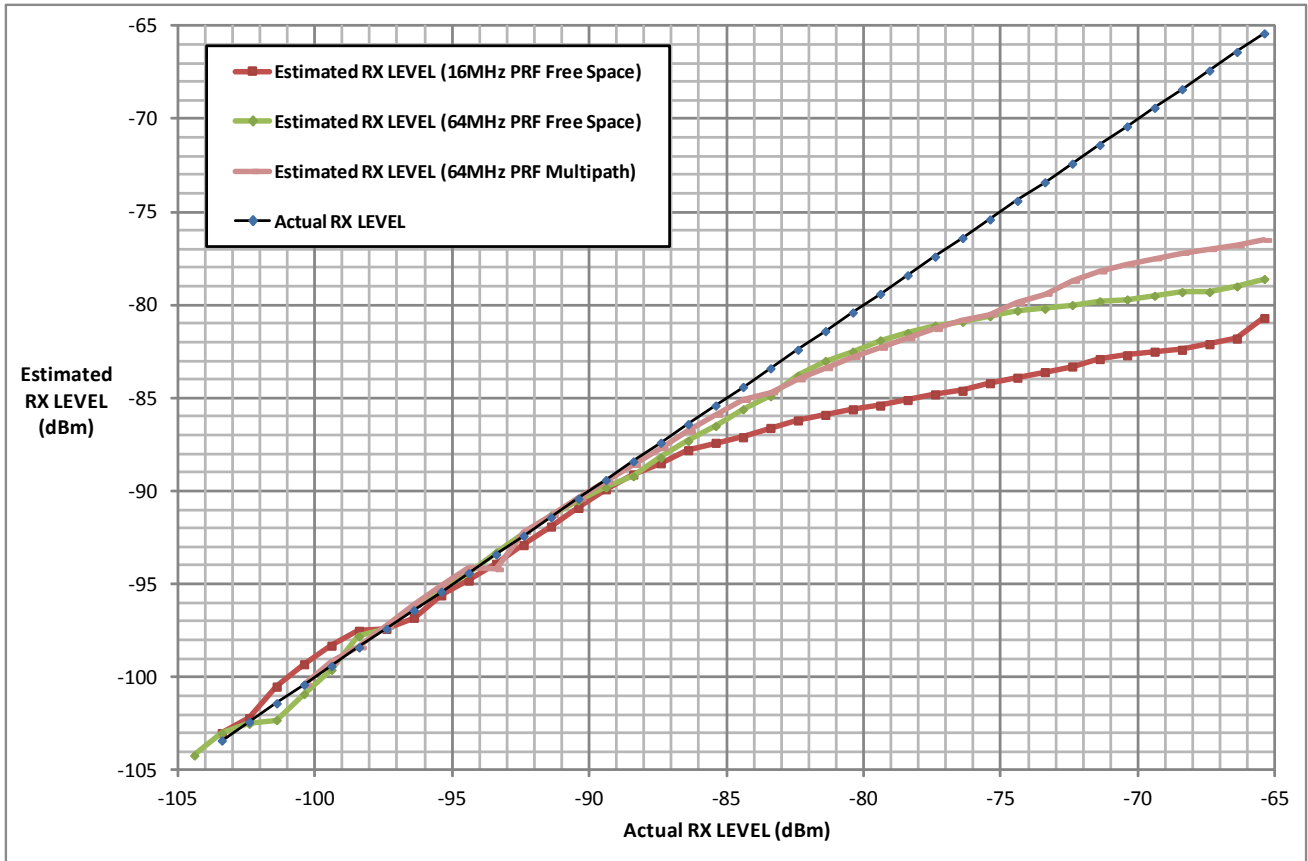

Figure 21: Estimated RX level versus actual RX level

5 Media Access Control (MAC) hardware features

This section describes the features for media access control (MAC) that have been implemented in the DW1000.

5.1 Cyclic redundancy check

The DW1000 includes a CRC generation function capable of automatically calculating and appending the 16-bit CRC frame check sequence (FCS) at the end of each transmitted frame.

The DW1000 includes a CRC checking function capable of automatically calculating the 16-bit CRC frame check sequence (FCS) during frame reception and comparing this calculated CRC with the final two octets of the received frame to check that the calculated CRC matches with CRC transmitted by the frame's originator. A mismatch between received and calculated CRC typically indicates that the received frame contains errors (generally handled by discarding the received frame). At the end of the frame reception as reported via the RXDFR event status bit, the result of the CRC comparison is reported by either the RXFCG or the RXFCE status bit being set, i.e. depending on whether or not the CRCs matched. These three status bits are in [Register file: 0x0F – System Event Status Register](#).

Where a CRC is not required it is possible to suppress the CRC transmission by employing the SFCST (suppress FCS transmission) bit in [Register file: 0x0D – System Control Register](#). This might be done when using a different MAC layer protocol. This SFCST control is also employed during a throughput maximising (response-time minimising) technique, as described in section [3.5.2 - TX buffer write while sending](#).

5.2 Frame filtering

Frame filtering is a feature of the DW1000 IC that can parse the received data of a frame that complies with the MAC encoding defined in the IEEE 802.15.4–2011 standard, identifying the frame type and its destination address fields, match these against the IC's own address information, and only accept frames that pass the filtering rules. See section [11 – APPENDIX 2: The IEEE 802.15.4 MAC](#) layer for an introduction to the message format defined in the standard.

The frame filtering functionality allows the IC to be placed into receive mode and only interrupt the host processor when a frame arrives that passes the frame filtering criteria. When frame filtering is disabled all frames with good CRC are accepted, typically to interrupt the host with event status indicating a frame has been received with good CRC (i.e. the RXDFR and RXFCG event status bits are set in [Register file: 0x0F – System Event Status Register](#)). When frame filtering is enabled the frame filtering rules have to be passed before these event status (interrupt) bits are set. See section [4.1 - Basic Reception](#) for general details of reception.

Frame filtering is enabled by the FFEN configuration bit in [Register file: 0x04 – System Configuration](#). This register contains seven additional configuration bits (FFAB, FFAD, FFAA, FFAM, FFAR, FFA4 and FFA5) for fine filtering control of the frame types.

5.2.1 Frame Filtering Rules

If frame filtering is enabled frames will be accepted or rejected based on the following rules:

- The frame type must be allowed for reception:
 - The FFAB configuration bit must be set to allow a Beacon frame to be received.
 - The FFAD configuration bit must be set to allow a Data frame to be received.
 - The FFAA configuration bit must be set to allow an Acknowledgment frame to be received.
 - The FFAM configuration bit must be set to allow a MAC command frame to be received.
 - The FFAR configuration bit allows IEEE 802.15.4 reserved types, 4 to 7 to be received, excluding those rejected due to the frame length check described below.
 - The FFA4 configuration bit allows IEEE 802.15.4 reserved type 4 to be received, excluding those rejected due to the frame length check described below.
 - The FFA5 configuration bit allows IEEE 802.15.4 reserved type 5 to be received, excluding those rejected due to the frame length check described below.

NB: For reserved frame types 4 to 7, if they are allowed here that is the end of the frame filtering, the remaining rules below only apply for standard frame types 0 to 3. However, the frame header will be interpreted as for frame types 0-3 to determine the size of the received frame and reject it if it is shorter than expected. This can make the use of frame types 4, 5, 6 and 7 problematic and frame filtering may need to be carried out in software if use of frames of type 4, 5, 6, or 7 with different encodings for frame control bits affecting the header length is planned. The frame control bits concerned are the address mode fields and the PID compression field.

- The frame version field must be 0x00 or 0x01
- The Destination PAN ID if present must:
 - Be the broadcast PAN ID (0xFFFF)
 - Or match the PAN_ID programmed in [Register file: 0x03 – PAN Identifier and Short Address](#)
- The Destination Address if present must:
 - Be the (short 16-bit) broadcast address (0xFFFF)
 - Or be a short (16-bit) address matching the SHORT_ADDR programmed in [Register file: 0x03 – PAN Identifier and Short Address](#)
 - Or be a long (64-bit) address matching the [Register file: 0x01 – Extended Unique Identifier](#).
- If the frame is a beacon frame then the Source PAN ID must match the PAN_ID programmed in [Register file: 0x03 – PAN Identifier and Short Address](#), (or be 0xFFFF)
- If only the source address is present, in a data or MAC command frame, then the frame will only be accepted if the IC is configured to be a coordinator, (via the FFBC configuration bit in [Register file: 0x04 – System Configuration](#)) and the Source PAN ID matches the PAN_ID programmed in [Register file: 0x03 – PAN Identifier and Short Address](#).
- The FCS (CRC) must be correct for the frame to be accepted.

5.2.2 Frame Filtering Notes

The frame filtering does not take any notice of the Security Enabled field, in the frame control, so it is up to the host software to decode any security information and accept/reject the frame as it sees fit. See section [11.2.2 – Security enabled Field](#) for details.

The decisions on frame rejection/acceptance with respect to illegal frame control octets is made after the first two octets of data are decoded, and at the end of reception of the address fields (as specified by the frame control octets) for the relevant addressing rules. When a frame is rejected, the reception is aborted immediately and the rejection is reported by the AFFREJ event bit in [Register file: 0x0F – System Event Status Register](#).

While frame filtering can save some work on the part of the host system, prolonged listening with the DW1000 receiver on is a relatively power hungry activity best employed only on equipment with a mains powered source.

All the configuration bits related to frame filtering are in [Register file: 0x04 – System Configuration](#).

5.3 Automatic Acknowledgement

The automatic acknowledgement functionality of the DW1000 allows the IC to automatically send acknowledgement frames when a frame is received and validated that includes an acknowledgement request. The automatic acknowledgement functionality only operates when frame filtering is enabled and automatic acknowledgement is enabled.

In order for automatic acknowledgement to operate:

- Frame filtering must be enabled and the received data or MAC command frame must be correctly addressed and pass through the receive frame filtering, (see section [5.2 - Frame filtering](#) for details of frame filtering configuration).
- The ACK request bit in the frame control field of the received frame must be set.
- Auto-acknowledgement must be enabled by the AUTOACK configuration in [Register file: 0x04 – System Configuration](#).

When these conditions are met the DW1000 will at the end of the reception automatically transition into transmit mode to send the 5-octet MAC acknowledgement frame as defined by IEEE 802.15.4-2011.

If automatic acknowledgement and double buffering are intended to be used together, the system must be designed such that overruns cannot occur, or if they can occur, that the system can deal with acknowledgement of frames which subsequently become corrupted, see section 4.3.5.

5.3.1 Preamble length in Automatic Acknowledge Frame

The preamble length of the frame requesting acknowledgement (ACK) is encoded in the PHR of that frame, (see section 10.4 – PHY header), and decoded in the DW1000 receiver (and reported in the RXPSR field of [Register file: 0x10 – RX Frame Information Register](#)). This only covers preamble lengths defined in the IEEE 802.14.4 standard, but the DW1000 supports other preamble lengths. To cope with this the DW1000 selects preamble length as reported in the RXPSR field but also uses the Preamble Accumulation Count value

reported in the RXPACC field of Register file: 0x10 – RX Frame Information Register. Table 7 presents the resulting preamble length used for the ACK frame as a function of RXPSR and RXPACC fields.

Table 7: Auto-ACK preamble length depending on RXPSR and RXPACC

PSR carried in PHR& reported in RXPSR	PSR accumulated and reported in the RXPACC value	Resultant Preamble Length of auto ACK
64	Less than 65	64
	Between 65 and 128	128
	Between 129 and 256	256
	Greater than 256	512
1024	Less than 1025	1024
	Between 1025 and 1536	1536
	Greater than 1536	2048
4096	Any value	4096

Table 7 relates to standard frames. In extended length frame mode, (as described in section 3.4 - *Extended Length Data Frames*), just the Preamble Accumulation Count value (reported in the RXPACC field of *Register file: 0x10 – RX Frame Information Register*) is used to determine the preamble length of the ACK. Table 8 presents the preamble lengths used for the ACK frame in *extended length frame mode* as a function of the RXPACC field.

Table 8: Auto-ACK preamble length selection in extended length frames mode

PSR accumulated and reported in the RXPACC value	Resultant Preamble Length of auto ACK
Less than 17	16 *
Between 17 and 32	32 *
Between 33 and 64	64
Between 65 and 128	128
Between 129 and 256	256
Between 257 and 512	512
Between 513 and 1024	1024
Between 1025 and 1536	1536
Between 1537 and 2048	2048
Greater than 2048	4096

NOTE *: These (asterisked) short preamble lengths will not be received by the DW1000. Use cases where this is likely to occur frequently should be avoided by one of the following strategies: (a) using a longer preamble for retransmission when no ACK is received, (b) not using the extended length frames mode, or, (c) by using the host microprocessor to generate the ACK in place of the DW1000’s auto-ACK feature.

NOTE 1: It is possible for the Preamble Accumulation Count value (reported in the RXPACC field of *Register file: 0x10 – RX Frame Information Register*) to be significantly shorter than the transmitted preamble length, because the accumulation stops when any tap value grows to be a 16-bit number. This is typically when the

sending device is close to the receiver, but in any case the number reported has been sufficient for correct reception of the frame being acknowledged, so even if this results in a shorter preamble for the auto-ACK frame this preamble should still have ample length for correct reception.

NOTE 2: It is also possible for the Preamble Accumulation Count (reported in RXPACC) to be a little larger than the transmitted preamble length. This can occur with early detection of preamble and because the accumulation count may include accumulation that continues through the SFD (until the SFD is detected). If this occurs it can result in the automatic acknowledgement frame being sent with a longer preamble than the frame soliciting the ACK. In the worst case this will be one size bigger. Allowance for this fact should be made when programming a shorter than default SFD detection timeout in [Sub-Register 0x27:20 – DRX_SFDTOC](#), e.g. set a time-out consistent with the next greater preamble size. And similarly if setting a very tight time for the RX frame timeout (in [Register file: 0x0C – Receive Frame Wait Timeout Period](#)) allowance should be made for the possible additional duration of the preamble sequence.

5.3.2 Automatic Receiver Re-Enable

Automatic acknowledgement can also operate correctly when the RX auto-re-enable function is enabled (by the RXAUTR bit in [Register file: 0x04 – System Configuration](#)), as may be the case in double-buffered mode (see section [4.3 - Double Receive Buffer](#)). Here when frame filtering and automatic acknowledgements are enabled, the DW1000 will automatically transition from receiving into transmit mode to send the acknowledgement frame and when the transmission is complete, the DW1000 will automatically return into receive mode to await the next frame.

5.3.3 Automatic ACK Turnaround Time

The IEEE 802.15.4 standard specifies a 12 symbol +/- 0.5 symbols turnaround time for ACK transmission. In the DW1000 this period is configurable via the ACK_TIM parameter in [Register file: 0x1A – Acknowledgement time and response time](#).

5.3.4 Frame Pending bit

The standard IEEE 802.15.4-2011 MAC includes a frame pending bit in the frame control at the start of each frame (see section [11.2.3 – Frame pending field](#)). This bit can be set to indicate more data is coming or in the case of the ACK frame to indicate that the responding node has data to send to the node soliciting the ACK. Please refer to the standard [1] for details of this. The DW1000 does not automatically determine the frame pending bit, inserted into the automatically-generated ACK frames. Instead it copies the value of the AACKPEND configuration bit (from [Register file: 0x04 – System Configuration](#)), which is zero by default.

5.3.5 Host Notification

The AAT status bit ([Register file: 0x0F – System Event Status Register](#)) indicates that an acknowledgement has been requested. The AAT bit is set at the same time as the RXFCG event status (indicating a good CRC at the end of frame reception).

If automatic acknowledgement is enabled then the AAT bit can be used during receive interrupt processing to detect that acknowledgement is in progress and so avoid taking any action until the transmission of the acknowledgement is completed, and signalled by the TXFRS (Transmit Frame Sent) event.

N. B.: If automatic acknowledgement is not enabled, then the AAT status bit must be ignored.

5.4 Transmit and automatically wait for response

The DW1000 has the ability to automatically turn on its receiver after a transmission has completed in order to receive a response. This may also include an optional delay configuration between the end of the transmission and the enabling of the receiver. This is controlled by the WAIT4RESP bit in [Register file: 0x0D – System Control Register](#) and the W4R_TIM parameter in the [Register file: 0x1A – Acknowledgement time and response time](#).

Note: If the response that is received is a frame requesting an acknowledgement frame, the DW1000 will transmit the ACK, if automatic acknowledge is enabled, but the receiver will re-enable following the transmission of the ACK. Depending on host response times this may allow the acknowledge-requesting frame to be overwritten, or other behaviour such as receiver timeouts resulting from the device being in the RX state rather than in IDLE.

6 Other features of the DW1000

6.1 External Synchronisation

This feature is used to synchronise DW1000 with external clocks or events or with other DW1000's. For example, this would be required in a TDOA RTLS system employing wired clock synchronisation of the anchor nodes.

The DW1000 external synchronisation features allow the following functions:

- a) The ability to reset the internal system counter in a deterministic way with respect to the assertion of the SYNC input pin, and an external 38.4 MHz clock supplied on the EXTCLK pin.
- b) The ability to initiate the transmission of a frame in a deterministic way with respect to the assertion of the SYNC input pin, and an external 38.4 MHz clock supplied on the EXTCLK pin.
- c) The ability to synchronise receive time stamping to an external counter

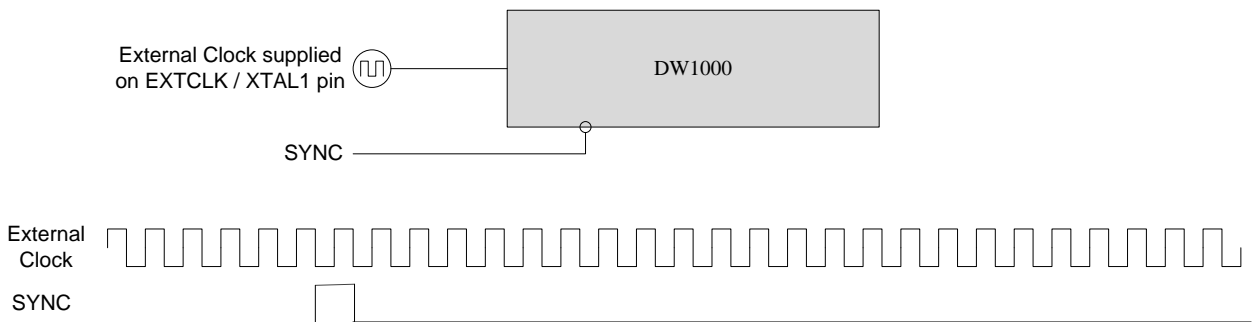

Figure 22: DW1000 External Synchronisation Interface

The SYNC input pin must be source synchronous with an external 38.4 MHz frequency reference clock supplied on the EXTCLK pin. The SYNC input pin is sampled on the rising edge of EXTCLK. Refer to the DW1000 datasheet for setup and hold times of the SYNC pin. The SYNC input provides a common reference point in time to synchronise the DW1000 with the accuracy necessary to achieve high resolution location estimation.

6.1.1 One Shot Timebase Reset (OSTR) Mode

One Shot Timebase Reset (OSTR) mode allows a reset to be applied to the timebase counter used for timestamping in DW1000 at a deterministic and predictable time relative to a synchronisation event. Any given device will reset the counter at a repeatable time to within 300ps (typically less than 100ps) variation. Process variation between parts introduces a deterministic error that can be calibrated out as part of the necessary calibration process to compensate for cable transmission delays in a wired synchronisation system. When several DW1000s are driven by the same reference clock and external SYNC signal their internal timebases can be synchronised very accurately (allowing for the deterministic delays associated with the distribution network for the reference clock and SYNC signal).

To configure DW1000 for OSTR mode, the OSTRM bit in the EC_CTRL register is set and the WAIT value is set to the desired delay value. When a counter running on the 38.4 MHz external clock and initiated on the rising edge of the SYNC signal equals the WAIT programmed value, the DW1000 timebase counter will be reset. See [Register file: 0x24 – External Synchronisation Control](#) for register details.

At the time the SYNC signal is asserted, the clock PLL dividers generating the DW1000 125 MHz system clock are reset, to ensure that a deterministic phase relationship exists between the system clock and the asynchronous 38.4 MHz external clock. For this reason, the WAIT value programmed will dictate the phase relationship and should be chosen to give the desired phase relationship, as given by WAIT modulo 4. A WAIT value of 33 decimal is recommended, but if a different value is chosen it should be chosen so that WAIT modulo 4 is equal to 1, i.e. 29, 37, and so on.

6.1.2 One Shot Transmit Synchronisation (OSTS) Mode

DW1000 allows the transmission of a frame at a deterministic time after the SYNC signal is asserted, using the One Shot Transmit Synchronisation (OSTS) mode. OSTS mode provides for the transmission of a frame at a well-defined time relative to the assertion of the SYNC DW1000 input. This time will vary slightly per part, typically 12 ps, but may vary up to 3 ns across process for all parts.

This feature will be used where a local master locationing device is using the DW1000 as a slave to provide additional location data. Calibration can be employed by the master device to tune for the constant offset due to the SYNC trace and process variation and in that case, the delay variation across all parts will be less than 100 ps.

Note that OSTS mode works identically to OSTR in every respect except for the final action performed, e.g. to reset the timebase or to initiate a transmission.

To configure OSTSmode the OSTSM bit must be set in the EC_CTRL register and the WAIT value set to the desired delay value, see [Register file: 0x24 – External Synchronisation Control](#). A value of 33 is recommended; see [6.1.1 – One Shot Timebase Reset \(OSTR\) Mode](#). When a counter running on the 38.4 MHz external clock and initiated on the rising edge of the SYNC signal equals the WAIT programmed value, the DW1000 will initiate a transmission, by issuing a TX START signal from the external synchronisation circuit in the clock PLL to the transmitter. The rising edge of the TX START signal is synchronised to the 125 MHz system clock domain before it is used to enable the transmission.

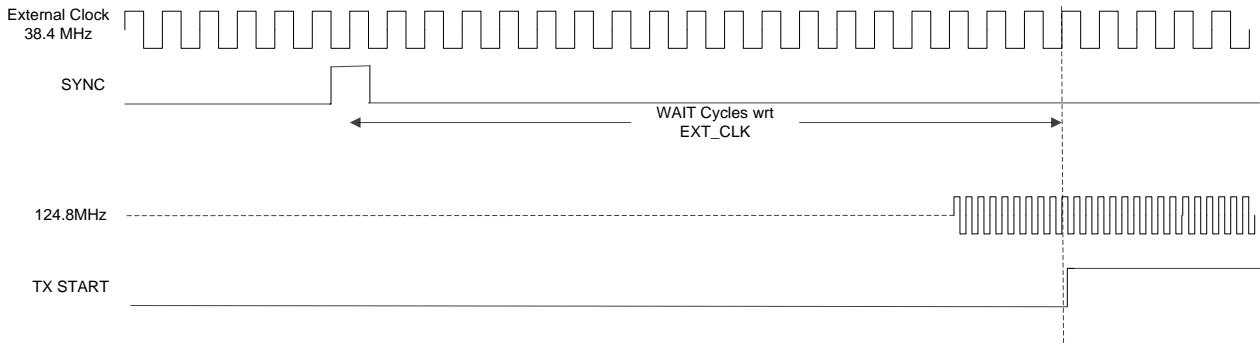

Figure 23: Synchronised Transmission

6.1.3 One Shot Receive Synchronisation (OSRS) Mode

One Shot Receive Synchronisation (OSRS) mode provides a second timebase in DW1000 that can be synchronised to an external timebase and used to timestamp receive events. This allows a user to have a timebase outside the DW1000, and to receive timing information about the receive events in this timebase. OSRS mode is configured by setting the OSRSM bit in the EC_CTRL register, see [Register file: 0x24 – External Synchronisation Control](#). A 1 GHz clock for an offset counter, EC_GOLP, must also be activated in this mode, by setting the PLLSYN field (bit 15) in the PMSC_CTRL1 register, see [Sub-Register 0x36:04 – PMSC_CTRL1](#).

In normal operation, a ranging timestamp is calculated based on the DW1000 internal timebase; see section [4.1.6 – RX Message timestamp](#). The timebase counter is captured at the receive event, RMARKER, and a number of offset values are combined with this capture value to give the ranging timestamp.

When timestamping the receive event relative to an external timebase, the procedure is similar to the normal method except that an offset is introduced to compensate for the error introduced by the use of the internal 125 MHz clock to capture a value on the external 38.4 MHz clock domain. As in normal operation, these offsets and captured values are combined to give the ranging timestamp.

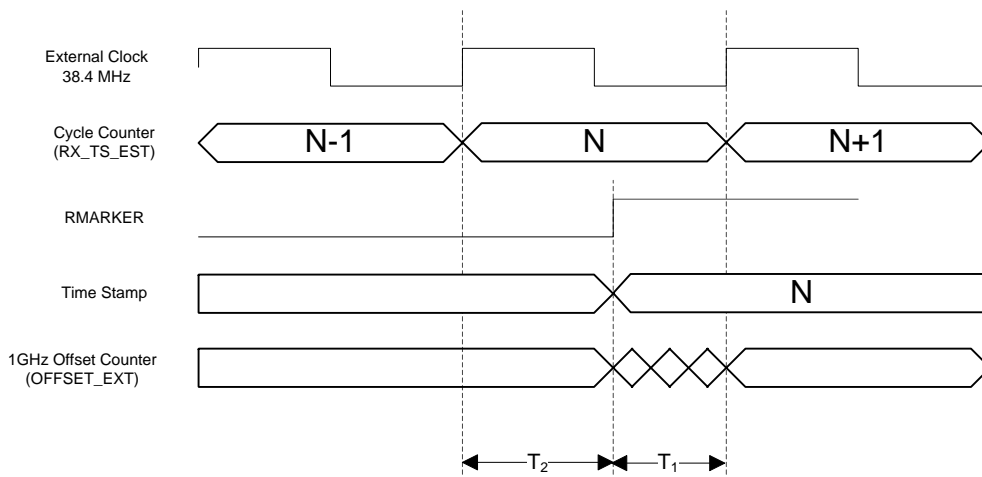

Figure 24: OSRS Mode Receive Timebase Synchronisation

Now the timestamp in the external timebase may be computed as:

$$T_{rx} = N \times T_{External} + T_2 + T_3.$$

$$= (N+1) \times T_{\text{External}} - T_1 + T_3.$$

Where:

- N is the number of external clock cycles since the SYNC signal captured in timestamp and may be read from EC_RXTC in the RS_TS_EST field, see [Sub-Register 0x24:04 EC_RXTC](#).
- T_{External} is the period of the external clock.
- T_2 is time from the rising edge of the external clock to the RMARKER.
- T_1 is the time in ns reported by EC_GOLP in the OFFSET_EXT field, see [Sub-Register 0x24:08 EC_GOLP](#).
- T_3 the leading path delay, calculated by subtracting the raw receive timestamp from the receive timestamp, the difference between these will give the leading path delay, see [Register file: 0x15 – Receive Time Stamp](#).

$$T_3 = \text{RX_STAMP} - \text{RX_RAWST}$$

6.2 External Power Amplification

In some geographic regions for certain situations (e.g. for emergency first responder use in ETSI UWB regulations for EU) it is permitted to send at +20dB above the normal UWB regulation levels. To achieve this with the DW1000 it is necessary to employ external amplification of the transmitted signal. The DW1000 provides signals (using the GPIO lines in a special mode) to control the turn-on of the power amplifier and to control the analog switching of the transmitter and receiver signal paths appropriately. This mode of operation utilises the DW1000 pins EXTPA, EXTTXE and EXTRXE as configured via the enabled via the fields MSGP4, MSGP5 and MSGP6 in [Sub-Register 0x26:00 – GPIO_MODE](#).

Can also be used to control an external power amplifier to provide a transmit power in excess of that available from the DW1000 alone. Care should be taken when using this feature to ensure that necessary regulatory requirements have been fulfilled.

There is a separate application note giving details of the external power amplification. This includes the circuit diagram, details of configuration and various design considerations that apply. Please consult with DecaWave applications support team for details.

6.3 Using the on-chip OTP memory

The DW1000 has a small amount of one-time-programmable (OTP) memory intended for device specific configuration or calibration data. Some areas of the OTP memory are used to save device calibration values determined during DW1000 testing, while other OTP memory locations are intended to be set by the customer during module manufacture and test.

For example, an OTP memory area is reserved for customers to programme the EUI that is loaded into [Register file: 0x01 –Extended Unique Identifier](#) as the IC comes out of reset (see [Register file: 0x01 –Extended Unique Identifier](#) for details of the EUI functionality).

This section lists the OTP memory areas defining their functionality and describes the algorithm for programming values into the OTP memory, and how to read values from the OTP memory. Access to OTP memory is achieved using [Register file: 0x2D – OTP Memory Interface](#).

6.3.1 OTP memory map

The OTP memory locations are as defined in Table 9. The OTPmemory locations are each 32-bits wide, OTPaddresses are word addresses so each increment of address specifies a different 32-bit word.

Table 9: OTP memory map

OTP Address	Size (Used Bytes)	Byte [3]	Byte [2]	Byte [1]	Byte [0]	Programmed By
0x000	4	64 bit EUID (These 64 bits get automatically copied over to Register File 0x01:EUI on each reset.)				Customer
0x001	4					
0x002	0	-	-	-	-	Reserved
0x003	0	-	-	-	-	
0x004	0	-	-	-	-	Reserved
0x005	0	-	-	-	-	
0x006	4	{“0001,0000,0001”, “CHIP ID (20 bits)”}				DecaWave Test
0x007	4	{“0001”, “LOT ID (28bits)”}				DecaWaveTest
0x008	2	-	-	V _{meas} @ 3.7 V	V _{meas} @ 3.3 V	DecaWaveTest
0x009	1	-	-	T _{meas} @ Ant Cal	T _{meas} @ 23 °C	Customer/Deca-WaveTest
0x00A	0	-				Reserved
0x00B	4	-				Reserved
0x00C	2	-				Reserved
0x00D	4	-				Reserved
0x00E	4	-				Reserved
0x00F	4	-				Reserved
0x010	4	CH1 TX Power Level PRF 16				Customer
0x011	4	CH1 TX Power Level PRF 64				Customer
0x012	4	CH2 TX Power Level PRF 16				Customer
0x013	4	CH2 TX Power Level PRF 64				Customer
0x014	4	CH3 TX Power Level PRF 16				Customer
0x015	4	CH3 TX Power Level PRF 64				Customer
0x016	4	CH4 TX Power Level PRF 16				Customer
0x017	4	CH4 TX Power Level PRF 64				Customer
0x018	4	CH5 TX Power Level PRF 16				Customer
0x019	4	CH5 TX Power Level PRF 64				Customer
0x01A	4	CH7 TX Power Level PRF 16				Customer
0x01B	4	CH7 TX Power Level PRF 64				Customer
0x01C	4	TX/RX Antenna Delay - PRF 64		TX/RX Antenna Delay - PRF 16		Customer
0x01D	0	-	-	-	-	Customer
0x01E	1	-	-	OTP Revision	XTAL_Trim[4:0]	Customer
0x01F	0	-	-	-	-	Customer
:	:	:	:	:	:	Reserved
0x400	4	SR Register (see below)				Customer

The SR (“Special Register”) is a 32-bit segment of OTP that is directly readable via the register interface upon power up. To programme the SR register follow the normal OTP programming method but set the OTP address to 0x400. The value of the SR register can be directly read back at address [Register file: 0x2D – OTP Memory](#) Interface.

Table 10: OTP_SRDAT Register

Bit	Function
31:5	<i>Reserved. Defaults to all “0”. If programming the OTP_SRDATA register these bits must be set to “0”</i>
4:3	SPI_SR_EN[1:0] . Set to “01” to enable bits [1:0] to be used instead of GPIO[6:5] boot strapping. If set, this will disable the external selection of SPI mode via GPIO6 and 5.
2	<i>Reserved. Defaults to “0”. If programming the OTP_SRDATA register these bits must be set to “0”</i>
1	SPI_SR_PH . Set SPI Phase mode to this value if bits [4:3] are set to “01”
0	SPI_SR_POL . Set SPI Polarity mode to this value if bits [4:3] are set to “01”

6.3.2 Programming a value into OTP memory

The programming of the OTP requires a number of setup steps to be carried out in sequence. Optimal programming requires that the VDDIO pin be driven to 3.7 V (or the VDDIOA pin if access to VDDIO is not available). The table below outlines the programming steps to place the OTP into its programming state and to programme a single location.

Table 11: Register accesses required to program the OTP

Step Number	Instruction	Register Address	Data Length (Bytes)	Data (Write/Read)
<i>Configure OTP for Programming - Stage 1:</i>				
C-1	<i>Write Sub-Register</i>	0x36:00 (PMSC_CTRL0)	1	0x01
C-2	<i>Write Sub-Register</i>	0x2D:07 (OTP_CTRL+1)	1	0x03
C-3	<i>Write Sub-Register</i>	0x2D:00 (OTP_WDAT)	2	0x9220
C-4	<i>Write Sub-Register</i>	0x2D:06 (OTP_CTRL)	1	0x08
	<i>Wait 1ms</i>			
C-5	<i>Write Sub-Register</i>	0x2D:07 (OTP_CTRL+1)	1	0x02
C-6	<i>Write Sub-Register</i>	0x2D:06 (OTP_CTRL)	1	0x88
C-7	<i>Write Sub-Register</i>	0x2D:06 (OTP_CTRL)	1	0x80
C-8	<i>Write Sub-Register</i>	0x2D:06 (OTP_CTRL)	1	0x00
<i>Configure OTP for Programming - Stage 2:</i>				
C-9	<i>Write Sub-Register</i>	0x2D:07 (OTP_CTRL+1)	1	0x05
C-10	<i>Write Sub-Register</i>	0x2D:00 (OTP_WDAT)	2	0x000E
C-11	<i>Write Sub-Register</i>	0x2D:06 (OTP_CTRL)	1	0x08
	<i>Wait 1ms</i>			
C-12	<i>Write Sub-Register</i>	0x2D:07 (OTP_CTRL+1)	1	0x04
C-13	<i>Write Sub-Register</i>	0x2D:06 (OTP_CTRL)	1	0x88
C-14	<i>Write Sub-Register</i>	0x2D:06 (OTP_CTRL)	1	0x80

Step Number	Instruction	Register Address	Data Length (Bytes)	Data (Write/Read)
C-15	Write Sub-Register	0x2D:06 (OTP_CTRL)	1	0x00
<i>Configure OTP for Programming - Stage 3:</i>				
C-16	Write Sub-Register	0x2D:07 (OTP_CTRL+1)	1	0x01
C-17	Write Sub-Register	0x2D:00 (OTP_WDAT)	2	0x1024
C-18	Write Sub-Register	0x2D:06 (OTP_CTRL)	1	0x08
	Wait 1ms			
C-19	Write Sub-Register	0x2D:07 (OTP_CTRL+1)	1	0x00
<i>Programming a single 32 bit word <DATA> to address <ADDR>:</i>				
P-1	Write Sub-Register	0x2D:06 (OTP_CTRL)	1	0x00
P-2	Write Sub-Register	0x2D:00 (OTP_WDAT)	4	<DATA[31:0]>
P-3	Write Sub-Register	0x2D:04 (OTP_ADR)	2	<ADDR[10:0]>
P-4	Write Sub-Register	0x2D:06 (OTP_CTRL)	1	0x40
P-5	Write Sub-Register	0x2D:06 (OTP_CTRL)	1	0x00
	Wait 1 ms before reading back to verify			

After programming an OTPword, it should be read back using the procedure in [6.3.3 – Reading a value from OTP memory](#) and verified for correctness. If it does not match the expected value, then the steps P-4 through P-5 should be repeated up to a maximum of 10 times (the address and data values in the registers will still be valid and as such do not require re-programming). During the programming stages the OTP is configured to stress the read back circuits to their limits. This may result in continuous read verify failures. In the event that 10 attempts have been made to programme a location then a final read verify is recommended after a full IC reset, this will reset the OTP configuration to normal read operation.

When all OTP programming is finished it is recommended to reset the IC to revert back to the default settings.

6.3.3 Reading a value from OTP memory

The OTP memory may be read by following the steps given in Table 12.

Table 12: An example of register accesses required to read from OTP

Step Number	Instruction	Register Address	Data Length (Bytes)	Data (Write/Read)
1	Write Register	0x2D:04 (OTP_ADDR)	2	OTP Address
2	Write Sub-Register	0x2D:06 (OTP_CTRL)	1	0x03
3	Write Sub-Register	0x2D:06 (OTP_CTRL)	1	0x01
4	Read Register	0x2A:04 (OTP_RDAT)	1	OTP Read Value
5	Write Sub-Register	0x2D:06 (OTP_CTRL)	1	0x00

6.4 Measuring IC temperature and voltage

The DW1000 is equipped with a low speed 8-bit SAR A/D convertor which can be configured to sample values from an internal IC temperature sensor and also from a battery voltage monitor on the VDDAON power supply input. These readings can be manually run under host control, or they can be configured to be run automatically each time the DW1000 enters the **WAKEUP** state. This automatic mode allows the temperature and voltage to be read while the device is in a low power state, which will give the ambient temperature and unloaded battery voltage.

The automatic mode is controlled by the ONW_RADC bit in *Sub-Register 0x2C:00 – AON_WCFG*. When this is used the temperature and voltage readings are available in *Sub-Register 0x2A:06 – TC_SARW* as soon as the IC reaches the **IDLE** state.

The procedure for host initiated reading of temperature sensor (or battery voltage) is as follows:

Table 13: An example of register accesses to perform a read of the temperature and voltage sensors

Step Number	Instruction	Register Address	Data Length (Bytes)	Data (Write/Read)
1	Write Sub-Register	28:11	1	0x80
2	Write Sub-Register	28:12	1	0x0A
3	Write Sub-Register	28:12	1	0x0F
4	Write Register	2A:00	1	0x01
5	Write Register	2A:00	1	0x00
6	Read Register	2A:03	1	8 bit Voltage reading
7	Read Register	2A:04	1	8 bit Temperature reading

When in the ADC is configured for automatic operation on wakeup *Register: 2C – ONWAKE_RUN_SAR*, then the ADC values for both the voltage and temperature sensors will be ready to read as soon as the **IDLE** state is entered. These values can be read by performing steps 6 and 7 from the table above.

In the automatic mode it is possible to configure an interrupt to assert if the latest readings of temperature or voltage differ from the previously recorded values by a value of 0x0A. This is approximately equal to 60 mV for the voltage reading and 10 °C for the temperature reading.

The previous values are also available to the host to read at:

Register: 2A – SAR_LAST_VBAT,

Register: 2A – SAR_LAST_TEMP

7 The DW1000 register set

The DW1000 is controlled by an associated host microcontroller system using the SPI interface to access a series of registers within the device. The DW1000 register set includes configuration registers, status registers, control registers, data buffer registers, and diagnostic registers. Section 2.2 – *The SPI Interface* described the SPI interface and the low level transactions for reading and writing the parameters of the DW1000. This section begins with 7.1– *Register map overview* and then 7.2– *Detailed register description*, where each individual parameter is described in detail.

7.1 Register map overview

The register map overview is given in Table 14. This lists the registers in address order, by register file ID, giving the register file length in octets, its type (RO = Read-Only, RW = Read & Write, SRW = Special Read Write – see individual register descriptions for details about how the Read/Write access is special), and a brief high level description of the register. Section 7.2 gives a detailed description of each register.

Note: When writing to any of the DW1000 registers care must be taken not to write beyond the published length of the selected register and not to write to any of the reserved register locations. Doing so may cause the device to malfunction.

Table 14: Register map overview

ID	Length (octets)	Type	Mnemonic	Description
0x00	4	RO	DEV_ID	Device Identifier – includes device type and revision info
0x01	8	RW	EUI	Extended Unique Identifier
0x02	-	-	-	Reserved
0x03	4	RW	PANADR	PAN Identifier and Short Address
0x04	4	RW	SYS_CFG	System Configuration bitmap
0x05	-	-	-	Reserved
0x06	5	RO	SYS_TIME	System Time Counter (40-bit)
0x07	-	-	-	Reserved
0x08	5	RW	TX_FCTRL	Transmit Frame Control
0x09	1024	RW	TX_BUFFER	Transmit Data Buffer
0x0A	5	RW	DX_TIME	Delayed Send or Receive Time (40-bit)
0x0B	-	-	-	Reserved
0x0C	2	RW	RX_FWTO	Receive Frame Wait Timeout Period
0x0D	4	SRW	SYS_CTRL	System Control Register
0x0E	4	RW	SYS_MASK	System Event Mask Register
0x0F	5	SRW	SYS_STATUS	System Event Status Register
0x10	4	ROD	RX_FINFO	RX Frame Information (in double buffer set)
0x11	1024	RWD	RX_BUFFER	Receive Data Buffer (in double buffer set)
0x12	8	ROD	RX_FQUAL	Rx Frame Quality information (in double buffer set)
0x13	4	ROD	RX_TTCKI	Receiver Time Tracking Interval (in double buffer set)
0x14	5	ROD	RX_TTCKO	Receiver Time Tracking Offset (in double buffer set)

ID	Length (octets)	Type	Mnemonic	Description
0x15	14	ROD	RX_TIME	Receive Message Time of Arrival (in double buffer set)
0x16	-	-	-	Reserved
0x17	10	RO	TX_TIME	Transmit Message Time of Sending
0x18	2	RW	TX_ANTD	16-bit Delay from Transmit to Antenna
0x19	5	RO	SYS_STATE	System State information
0x1A	4	RW	ACK_RESP_T	Acknowledgement Time and Response Time
0x1B	-	-	-	Reserved
0x1C	-	-	-	Reserved
0x1D	4	RW	RX_SNIFF	Pulsed Preamble Reception Configuration
0x1E	4	RW	TX_POWER	TX Power Control
0x1F	4	RW	CHAN_CTRL	Channel Control
0x20	-	-	-	Reserved
0x21	41	RW	USR_SFD	User-specified short/long TX/RX SFD sequences
0x22	-	-	-	Reserved
0x23	32	RW	AGC_CTRL	Automatic Gain Control configuration
0x24	12	RW	EXT_SYNC	External synchronisation control.
0x25	4064	RO	ACC_MEM	Read access to accumulator data
0x26	44	RW	GPIO_CTRL	Peripheral register bus 1 access - GPIO control
0x27	44	RW	DRX_CONF	Digital Receiver configuration
0x28	58	RW	RF_CONF	Analog RF Configuration
0x29	-	-	-	Reserved
0x2A	52	RW	TX_CAL	Transmitter calibration block
0x2B	21	RW	FS_CTRL	Frequency synthesiser control block
0x2C	12	RW	AON	Always-On register set
0x2D	18	RW	OTP_IF	One Time Programmable Memory Interface
0x2E	-	RW	LDE_CTRL	Leading edge detection control block
0x2F	41	RW	DIG_DIAG	Digital Diagnostics Interface
0x30 to 0x35	-	-	-	Reserved
0x36	48	RW	PMSC	Power Management System Control Block
0x37 to 0x3F	-	-	-	Reserved

Note the "Type" mnemonic in the table above has the following meaning:

- RO – Read Only,
- RW – Read and Write,
- SRW – Special type of Read and Write, refer to individual register description for details,
- ROD – Read Only part of RX Double buffered swinging set of RX frame related information,
- RWD – Read and Write part of RX Double buffered swinging set of RX frame related information.

7.2 Detailed register description

7.2.1 Terminology

Section 7.1 gives an overview of the DW1000 register set presenting all top level register file ID addresses in Table 14. This section describes in detail the contents and functionality of these register files in separate sub sections. In each case the row from Table 14 is reproduced with hex register file ID, its length, type, mnemonic and one line description as follows:

ID	Length (octets)	Type	Mnemonic	Description

This is followed by a description of the parameters within that register file. All parameters are presented with format REG:RR:SS, where RR is register file ID and SS is the sub address. Where a register is made up of individual bits or bit-fields these are identified with mnemonic and default values as follows:

REG:RR:SS – Mnemonic – one line description																															
31	30	29	28	27	26	25	24	23	22	21	20	19	18	17	16	15	14	13	12	11	10	9	8	7	6	5	4	3	2	1	0
<i><bits or bit-fields identified by a quoted mnemonic></i>																															
<i><default power-on-reset values are quoted as bits or values></i>																															

Then the fields or bits identified are described individually in detail.

Because many parameters are 4-octets long, the default presentation of the register values is as a 32-bit value. This may be sub-divided into fields of various bit widths down to single bit values. It should be noted that when reading these values via the SPI interface the octets are output least significant octet first. Also of note is the fact that the indexed addressing modes allow individual octets to be accessed – a technique that may be employed to reduce SPI traffic when only part of a register needs to be read or written.

Each register file is described below:

7.2.2 Register file: 0x00 – Device Identifier

ID	Length (octets)	Type	Mnemonic	Description
0x00	4	RO	DEV_ID	Device Identifier – includes device type and revision information

[Register map](#) register file 0x00 is the device identifier. This is hard-coded into the silicon. The value in this register is read-only and cannot be overwritten by the host system. The device ID will be changed for any silicon updates. The device ID register is ideal to use in the host μ P to validate that the SPI interface is operational. It is expected that the host system will validate that the device ID is the expected value, supported by its software, before proceeding to use the IC.

The Device Identifier register contains the following sub-fields:

REG:00:00 – DEV_ID – Device Identifier																															
31	30	29	28	27	26	25	24	23	22	21	20	19	18	17	16	15	14	13	12	11	10	9	8	7	6	5	4	3	2	1	0
RIDTAG																MODEL						VER				REV					
1	1	0	1	1	1	1	0	1	1	0	0	1	0	1	0	0	0	0	0	0	0	0	1	0	0	1	1	0	0	0	0

Definition of the sub fields of REG:00:00 – DEV_ID: Device Identifier:

Field	Description of fields within Register file: 0x00 – Device Identifier
REV reg:00:00 bits:3–0	Revision: This number will be updated for minor corrections and changes in operation
VER reg:00:00 bits:7–4	Version: This number will be updated if a new version is produced that has significant differences from the previous version.
MODEL reg:00:00 bits:15–8	The MODEL identifies the device. The DW1000 is device type 0x01.
RIDTAG reg:00:00 bits:31–16	Register Identification Tag. It is planned that this will remain constant for all DecaWave parts. The value is 0xDECA in hex.

For the production DW1000 the Device ID is set to 0xDECA0130. The register descriptions in this user manual relate to that DW1000 device and are not valid for any earlier sample parts.

7.2.3 Register file: 0x01 –Extended Unique Identifier

ID	Length (octets)	Type	Mnemonic	Description
0x01	8	RW	EUI	Extended Unique Identifier – the 64-bit IEEE device address

Register map register file 0x01 is the Extended Unique Identifier register. For IEEE 802.15.4 compliance every device should have a unique 64-bit device identifier. The high-order 24-bits of the EUI are a *company identifier* assigned by the IEEE Registration Authority, (see <http://standards.ieee.org/develop/regauth/oui/>), to the manufacturer. The low 40-bits of the EUI are the *extension identifier* uniquely chosen by the manufacturer for each device manufactured and never repeated. The resultant EUI is a globally uniquely identifier. It is expected that manufacturers who need to comply with this requirement will register with the IEEE Registration Authority and generate and maintain their own EUI *extension identifier* numbering space to ensure its uniqueness for every device made.

Manufacturers may store the EUI externally to the DW1000 or as an alternative the DW1000 has a one-time-programmable memory area that may be programmed with the EUI during product manufacturing. Please refer to section 6.3 – *Using the on-chip OTP memory* for details of programming values into OTP. [Table 43: Register file: 0x2D – OTP Memory Interface overview](#) gives an overview of OTP contents and addresses.

During DW1000 initialisation, or upon waking up from sleep mode, the [Register file: 0x01 –Extended Unique Identifier](#) register value is loaded from its OTP memory area. After this the EUI register value may be overwritten by the host system if necessary.

Certain IEEE 802.15.4 defined frames use a 64-bit source address. The software (MAC) generating such frames is expected to insert the EUI within the frame before the frame is written to the DW1000’s transmit buffer.

The EUI register is used by the Receive Frame Filtering function, see section 5.2 details. When frame filtering is operational the DW1000 decodes each received frame according to the IEEE 802.15.4 MAC rules and any 64-bit destination address present must match the EUI register before the frame will be accepted.

The 8-octets of the Extended Unique Identifier may be accessed as a single 8-octet access to the EUI register file starting at index 0. The bytes of the EUI are output/input in the following order:

REG:01:00 – EUI – Extended Unique Identifier								Octet Index	Description
7	6	5	4	3	2	1	0		
0xHH								0	Bits 7 to 0 of the extension identifier
0xHH								1	Bits 15 to 8 of the extension identifier
0xHH								2	Bits 23 to 16 of the extension identifier
0xHH								3	Bits 31 to 24 of the extension identifier
0xHH								4	Bits 39 to 32 of the extension identifier
0xNN								5	Bits 7 to 0 of the OUI (manufacturer company ID)
0xNN								6	Bits 15 to 8 of the OUI (manufacturer company ID)
0xNN								7	Bits 23 to 16 of the OUI (manufacturer company ID)

The ordering of octets read from the Extended Unique Identifier register is designed to be directly compatible with the octet ordering of the 64-bit source address fields of IEEE 802.15.4 standard MAC frames easing the task of inserting it into a frame for transmission.

7.2.4 Register file: 0x02 – Reserved

ID	Length (octets)	Type	Mnemonic	Description
0x02	-	-	-	Reserved – this register file is reserved

[Register map](#) register file 0x02 is reserved for future use. Please take care not to write to this register as doing so may result in cause the DW1000 to malfunction.

7.2.5 Register file: 0x03 – PAN Identifier and Short Address

ID	Length (octets)	Type	Mnemonic	Description
0x03	4	RW	PANADR	PAN Identifier and Short Address

[Register map](#) register file 0x03 contains two 16-bit parameters, the *PAN Identifier* and the *Short Address*. When the DW1000 is powered-up or reset both the PAN Identifier and the Short Address in this register are reset to the value 0xFFFF. The host software (MAC) should program the appropriate values into this register if it wishes to use the DW1000’s receive frame filtering or automatic acknowledgement generation functions.

In an IEEE 802.15.4 personal area network (PAN), the PAN coordinator node determines the PAN Identifier for the network, and assigns it and short 16-bit addresses to devices (nodes) associating with the PAN. The nodes in the PAN then should (at the MAC layer) use their assigned short address as the source address and include it along with the PAN Identifier in the frames they transmit. When a node receives a frame it should only process those with a destination address and PAN Identifier which matches their assigned node address and network ID.

When the receive frame filtering and automatic acknowledgement functionality is operational the DW1000 decodes each received frame according to the IEEE 802.15.4 MAC specification and when it determines that a 16-bit destination address is present in the frame, the DW1000 will compare the destination address with the short address value programmed in this register before accepting/acknowledging the frame, and will similarly only accept received frames when the PAN Identifier in the frame matches the PAN Identifier programmed in this register. See sections 5.2 and 5.3 for details of the frame filtering and automatic acknowledgement functionality.

The PAN Identifier and Short Address register contains the following sub-fields:

REG:03:00 – PANADR – PAN Identifier and Short Address																															
31	30	29	28	27	26	25	24	23	22	21	20	19	18	17	16	15	14	13	12	11	10	9	8	7	6	5	4	3	2	1	0
PAN_ID																SHORT_ADDR															
0xFFFF																0xFFFF															

The host software (MAC) only needs to program this register if it is using the DW1000’s receive frame filtering and automatic acknowledgement generation functions. The sub-fields are:

Field	Description of fields within Register file: 0x03 – PAN Identifier and Short Address
SHORT_ADDR reg:03:00 bits:15–0	Short Address. The host software needs to program this register if it is using the DW1000’s receive frame filtering functionality, with or without the automatic acknowledgement generation function. The short address is typically assigned to a node by the coordinator function at MAC (or higher) layer as part of network association. The value may alternatively be pre-defined in a closed network where the network association phase is being skipped.
PAN_ID reg:03:00 bits:31–16	PAN Identifier. The host software needs to program this register if it is using the DW1000’s receive frame filtering functionality, with or without the automatic acknowledgement generation function. The PAN ID is typically assigned as part of network association. A predefined PAN ID might be used in a closed network where the network association phase is being skipped.

7.2.6 Register file: 0x04 – System Configuration

ID	Length (octets)	Type	Mnemonic	Description
0x04	4	RW	SYS_CFG	System Configuration bitmap

[Register map](#) register file 0x04 is the system configuration register. This is a bitmapped register. Each bit field is separately identified and described below. The System Configuration register contains the following bitmapped sub-fields:

REG:04:00 – SYS_CFG – System Configuration bit map																															
31	30	29	28	27	26	25	24	23	22	21	20	19	18	17	16	15	14	13	12	11	10	9	8	7	6	5	4	3	2	1	0
AACKPEND	AUTOACK	RXAUTR	RXWTOE	-	-	-	-	-	RXM110K	-	-	-	DIS_STXP	PHR_MODE	FCS_INIT2F	DIS_RSDE	DIS_PHE	DIS_DRXB	DIS_FCE	SPI_EDGE	HIRO_POL	FFA5	FFA4	FFAR	FFAM	FFAA	FFAD	FFAB	FFBC	FFEN	
0	0	0	0	0	0	0	0	0	0	0	0	0	0	0	0	0	0	0	1	0	0	1	0	0	0	0	0	0	0	0	0

Definition of the bit fields within REG:04:00 – SYS_CFG: System Configuration bitmap: -

Field	Description of fields within Register file: 0x04 – System Configuration
FFEN reg:04:00 bit:0	Frame Filtering Enable. This bit enables the frame filtering functionality in the DW1000 receiver. The frame filtering is designed to follow the rules defined in the IEEE 802.15.4-2011 standard. When frame filtering is enabled receive frames must pass the frame filtering rules before being considered as a good frame. This includes the destination address matching the PAN_ID and SHORT_ADDR as defined in Register file: 0x03 – PAN Identifier and Short Address , or the long 64-bit defined by Register file: 0x01 – Extended Unique Identifier . These addresses and the other frame filtering control bits of Register file: 0x04 – System Configuration should be configured correctly before enabling frame filtering with this FFEN bit. Section 5.2 describes frame filtering in more detail.

Field	Description of fields within Register file: 0x04 – System Configuration
FFBC reg:04:00 bit:1	Frame Filtering Behave as a Co-ordinator. FFEN must be set to enable this frame filtering operation. A coordinator will accept a frame without a destination address if the source address has the PAN_ID matching the coordinator's PAN_ID. For an ordinary (non-coordinator) node the destination address (if present) must match the node's own address or the frame will not be accepted. When FFBC is set to 1 the DW1000 will behave as a coordinator. When FFBC is clear the DW1000 will behave as an ordinary normal node. Section 5.2 describes frame filtering in more detail.
FFAB reg:04:00 bit:2	Frame Filtering Allow Beacon frame reception. IEEE 802.15.4-2011 frames begin with three bits, indicating the frame type for beacon frames these are binary 000. When FFAB is set to 1 beacon frames will be accepted (assuming all other frame filtering rules are passed) and when FFAB is clear beacon frames will be ignored. Section 5.2 describes frame filtering in detail.
FFAD reg:04:00 bit:3	Frame Filtering Allow Data frame reception. IEEE 802.15.4-2011 frames begin with three bits, indicating the frame type, b3 to b0, for data frames these are binary 001. When FFAD is set to 1 data frames will be accepted (assuming all other frame filtering rules are passed) and when FFAD is clear data frames will be ignored. Section 5.2 describes frame filtering in more detail.
FFAA reg:04:00 bit:4	Frame Filtering Allow Acknowledgment frame reception. IEEE 802.15.4-2011 frames begin with three frame type bits, b3 to b0, for acknowledgment frames these are binary 010. When FFAA is set to 1 acknowledgment frames will be accepted (assuming all other frame filtering rules are passed) and when FFAA is clear acknowledgment frames will be ignored. Section 5.2 describes frame filtering in more detail.
FFAM reg:04:00 bit:5	Frame Filtering Allow MAC command frame reception. IEEE 802.15.4-2011 frames begin with three frame type bits, b3 to b0, for MAC command frames these are binary 011. When FFAM is set to 1 MAC command frames will be accepted (assuming all other frame filtering rules are passed) and when FFAM is clear MAC command frames will be ignored. Section 5.2 describes frame filtering in more detail.
FFAR reg:04:00 bit:6	Frame Filtering Allow Reserved frame types. IEEE 802.15.4-2011 frames begin with three frame type bits, b3 to b0. The values of binary 100 through 111 (4 to 7) are not defined in IEEE 802.15.4-2011 and would normally be rejected. When FFAR is 0 these frames may be ignored (depending also on FFA4 and FFA5 which modify this behaviour). When FFAR is set to 1 these frames are accepted. Since these frame types are unknown no further frame decoding is done (e.g. no address matching etc.) and the software will thus be responsible for validating and interpreting these frames. Section 5.2 describes frame filtering in more detail. Note that the frame filter does decode the frame control fields to determine the minimum length of the expected frame and will reject the frame if it is too short, see section 5.2.
FFA4 reg:04:00 bit:7	Frame Filtering Allow frames with frame type field of 4, (binary 100). IEEE 802.15.4-2011 frames begin with three frame type bits, b3 to b0. The value of binary 100 is not defined in IEEE 802.15.4-2011. When FFA4 is set to 1, frames of type 4 will be accepted, but no further frame decoding is done (e.g. no address matching etc.) so software will be responsible for validating and interpreting these frames. When FFA4 is set to 0, frames of type 4 will be ignored unless FFAR is set. Section 5.2 describes frame filtering in more detail. Note that the frame filter does decode the frame control fields to determine the minimum length of the expected frame and will reject the frame if it is too short, see section 5.2.

Field	Description of fields within Register file: 0x04 – System Configuration
FFA5 reg:04:00 bit:8	<p>Frame Filtering Allow frames with frame type field of 5, (binary 101). IEEE 802.15.4-2011 frames begin with three frame type bits, b3 to b0. The value of binary 100 is not defined in IEEE 802.15.4-2011. When FFA5 is set to 1, frames of type 5 will be accepted, but no further frame decoding is done (e.g. no address matching etc.) so software will be responsible for validating and interpreting these frames. When FFA5 is set to 0, frames of type 5 will be ignored unless FFAR is set. Section 5.2 describes frame filtering in more detail.</p> <p>Note that the frame filter does decode the frame control fields to determine the minimum length of the expected frame and will reject the frame if it is too short, see section 5.2.</p>
HIRQ_POL reg:04:00 bit:9	<p>Host interrupt polarity. This bit allows the system integrator the ability to control the polarity of the IRQ line from the DW1000. When HIRQ_POL is 1 the IRQ output line from the DW1000 is active high, and, when HIRQ_POL is 0 the IRQ output line from the DW1000 is active low.</p> <p>Active high operation is recommended for low power applications so that the interrupt is in its 0 V logical inactive state when the DW1000 is in SLEEP or DEEPSLEEP states.</p>
SPI_EDGE reg:04:00 bit:10	<p>SPI data launch edge. This bit allows the system integrator the ability to control the launch edge used for SPI data from the DW1000 on the MISO SPI data output line. This may be used to select the MISO output operation most suitable to the target system. When SPI_EDGE is 0 the DW1000 uses the sampling edge to launch MISO data. This setting should give the highest rate operation. When SPI_EDGE is 1 the DW1000 uses the opposite edges to launch the data. This setting may give a more robust operation.</p>
DIS_FCE reg:04:00 bit:11	<p>Disable frame check error handling. This might be of use for protocols using a different encoding scheme for error handling not based on standard IEEE 802.15.4-2011, but for normal IEEE 802.15.4-2011 operation this bit should be set to 0. Setting this bit to one makes the DW1000 treat the frame as valid, ignoring errors, so that in double buffering mode (for example) it will move on to the next buffer. In normal operation (when DIS_FCE is 0) with double buffering, a CRC error causes the current RX frame to be discarded and the buffer to be reused for next frame's reception.</p>
DIS_DRXB reg:04:00 bit:12	<p>Disable Double RX Buffer. The DW1000 has a double buffered receiver allowing reception of a new frame to proceed in one buffer while the host processor is in the process of unloading the last frame received into the other buffer of the buffer pair. The double buffering is enabled when DIS_DRXB is set to 0, and disabled when DIS_DRXB is set to 1. More details on the operation of double buffering are given in section 4.3.</p>
DIS_PHE reg:04:00 bit:13	<p>Disable receiver abort on PHR error. When DIS_PHE is 0 (recommended) the receiver will discontinue reception when it detects a non-correctable error in the PHY header, see section 10.4 –PHY header for details of PHR encoding and error correction. The PHR error is reported by the RXPHE event status bit in Register file: 0x0F – System Event Status Register. This bit is for debug only and should never be set in an application as it can seriously impair receiver performance when set.</p>

Field	Description of fields within Register file: 0x04 – System Configuration
DIS_RSDE reg:04:00 bit:14	Disable Receiver Abort on RSD error. During normal reception (i.e. with the DIS_RSDE bit cleared to its recommended default zero value) when the Reed Solomon decoder detects a non-correctable error then frame reception is aborted and the receiver will be disabled, (unless the RXAUTR control bit is set in which case the receiver will automatically re-enable and begin preamble hunt again). The Reed Solomon decoder error is generated when an error is found that cannot be corrected using the Reed Solomon FEC (forward error correction) data. The Reed Solomon decoder error is flagged in the RXRFSL event status bit in Register file: 0x0F – System Event Status Register . When the DIS_RSDE bit is set the receiver will not abort reception when the Reed Solomon error occurs, but will instead continue to demodulate the data to the end of the frame (i.e. for the length specified in the PHY Header). Typically the non-correctable Reed Solomon error will mean that the frame is corrupted and that the CRC will not be correct.
FCS_INIT2F reg:04:00 bit:15	This bit allows selection of the initial seed value for the FCS generation and checking function that is set at the start of each frame transmission and reception. By default the FCS_INIT2F bit is 0 selecting the FCS generation/checking seed initialisation to be all zero (0x0000) – this is the standard setting required for IEEE 802.15.4 compliance. When the FCS_INIT2F bit is 1 the FCS generation/checking initialisation value will be all ones (0xFFFF).
PHR_MODE reg:04:00 bits:17,16	This configuration allows selection of PHR type to be one of two options. The default setting gives IEEE standard PHR encoding and a maximum data payload of 127 octets. The other option enables the proprietary long frames mode which allows a data payload of up to 1023 octets. In this mode the PHR encoding does not follow the IEEE standard. For successful communications between two nodes both must be configured for the same PHR mode. Supported PHR_MODE configurations are: 00 –Standard Frame mode. Use this setting is for IEEE 802.15.4 compliance. 11 –Long Frames mode. Proprietary PHR encoding. Frame Length 0-1023.
DIS_STXP reg:04:00 bit:18	Disable Smart TX Power control. Smart TX power control applies at the 6.8 Mbps data rate. When sending short data frames at this rate (and providing that the frame transmission rate is < 1 frame per millisecond) it is possible to increase the transmit power and still remain within regulatory power limits which are typically specified as average power per millisecond. When DIS_STXP is 0, the transmitter automatically sets the transmitter power levels us when sending a frame at the 6.8 Mbps data rate, depending the frame length specified in the TFLEN field of Register file: 0x08 – Transmit Frame Control . The actual power levels used are selected by the values configured in Register file: 0x1E – Transmit Power Control , described in section 7.2.31. NB: It is up to the external system to keep the frame rate below the 1 frame per millisecond to ensure that the power boost is not breaking the regulations. When DIS_STXP is 1, the transmitter power levels the smart TX power control function is disabled and TX power does not depend on data rate and frame length. In this case the values configured in Register file: 0x1E – Transmit Power Control are used to specify the power in different phases of the TX frame separately, see section 7.2.31.
- reg:04:00 bits:21–19	These bits are reserved and should always be set to zero to avoid any malfunction of the device.

Field	Description of fields within Register file: 0x04 – System Configuration
RXM110K reg:04:00 bit:22	Receiver Mode 110 kbps data rate. This configuration when set to 1 will cause the receiver to look for long SFD and process the PHY Header and RX data as per the 110 kbps frame mode. When this configuration is 0, (the default), the receiver will look for short SFD and will determine the RX data rate from the PHY header as either 850 kbps or 6.8 Mbps.
- reg:04:00 bits:27–23	These bits are reserved and should always be set to zero to avoid any malfunction of the device.
RXWTOE reg:04:00 bit:28	Receive Wait Timeout Enable. When set RX Enable will initialise an RX_FWTO down count which will disable receiver if no valid frame is received before the timeout occurs. The timeout period is set Register file: 0x0C – Receive Frame Wait Timeout Period . The occurrence of the timeout is signalled by the RXRFTO event status bit in Register file: 0x0F – System Event Status Register .
RXAUTR reg:04:00 bit:29	Receiver Auto-Re-enable. This bit is used to cause the receiver to re-enable automatically. Its operation changes depending on whether the IC is operating in single or double buffered modes. The default value of 0. With this setting, the IC will not automatically re-enable the receiver but will stop receiving and return to idle mode whenever any receive events happen. This includes receiving a frame but also failing to receive a frame because of some error condition, for example an error in the PHY header (as reported by the RXPHE event status bit in Register file: 0x0F – System Event Status Register). In such cases if the host wants to re-enable the receiver it must do it explicitly, using the RXENAB bit in Register file: 0x0D – System Control Register . The operation when RXAUTR = 1 is as follows: <ul style="list-style-type: none"> (a) Double-buffered mode: After a frame reception event or failure (except a frame wait timeout), the receiver will re-enable to receive another frame. (b) Single-buffered mode: After a frame reception failure (except a frame wait timeout), the receiver will re-enable to re-attempt reception. For more information on frame reception see section 4 – Message Reception . Note: In double-buffered mode when automatic frame acknowledgement is enabled (by the AUTOACK bit below) the receiver will be re-enabled after the ACK frame has been transmitted.
AUTOACK reg:04:00 bit:30	Automatic Acknowledgement Enable. Default value 0. This is the enable for the Automatic Acknowledgement function. See section 5.3– Automatic Acknowledgement for details of operation of Automatic Acknowledgement.
AACKPEND reg:04:00 bit:31	Automatic Acknowledgement Pending bit control. Default value 0. The value of the AACKPEND bit is copied into the <i>Frame Pending</i> bit in the <i>Frame Control</i> field of the DW1000 automatically generated ACK frame. See section 5.2 – Frame filtering for details of operation of frame filtering.

7.2.7 Register file: 0x05 – Reserved

ID	Length (octets)	Type	Mnemonic	Description
0x05	-	-	-	Reserved – this register file is reserved

[Register map](#) register file 0x05 is reserved for future use. Please take care not to write to this register as doing so may cause the DW1000 to malfunction.

7.2.8 Register file: 0x06 – System Time Counter

ID	Length (octets)	Type	Mnemonic	Description
0x06	5	RO	SYS_TIME	System Time Counter (40-bit)

[Register map](#) register file 0x06 is the System Time Counter register. System time and time stamps are designed to be based on the time units which are nominally at 64 GHz, or more precisely 499.2 MHz × 128 which is 63.8976 GHz. In line with this when the DW1000 is in idle mode with the digital PLL enabled, the System Time Counter is incremented at a rate of 125 MHz in units of 512. The nine low-order bits of this register are thus always zero. The counter wrap period of the clock is then: $2^{40} \div (128 \times 499.2e6) = 17.2074$ seconds.

- Notes (a) On power up, before the digital PLL is enabled, the System Time Counter increments are still in units of 512 however the increment rate is half the external crystal frequency, (e.g. at 19.2 MHz for the 38.4 MHz crystal). The counter wrap period is then: $2^{31} \div 19.2e6 = 111.8481$ seconds.
- (b) In sleep modes the system time counter is disabled and this register is not updated.

7.2.9 Register file: 0x07 – Reserved

ID	Length (octets)	Type	Mnemonic	Description
0x07	-	-	-	Reserved – this register file is reserved

[Register map](#) register file 0x07 is reserved for future use. Please take care not to write to this register as doing so may cause the DW1000 to malfunction.

7.2.10 Register file: 0x08 – Transmit Frame Control

ID	Length (octets)	Type	Mnemonic	Description
0x08	5	RW	TX_FCTRL	Transmit Frame Control

[Register map](#) register file 0x08, the transmit frame control register, contains a number of TX control fields. Each field is separately identified and described below. (For a general discussion of transmission please refer to section3 – [Message Transmission](#)).

REG:08:00 – TX_FCTRL – Transmit Frame Control (Octets 0 to 3, 32-bits)																																	
31	30	29	28	27	26	25	24	23	22	21	20	19	18	17	16	15	14	13	12	11	10	9	8	7	6	5	4	3	2	1	0		
TXBOFFS										PE	TXPSR	TXPRF	TR	TXBR	R	TFLE	TFLEN																
0	0	0	0	0	0	0	0	0	0	0	0	0	0	0	0	0	0	0	0	0	0	0	0	0	0	0	0	0	0	1	1	0	0

REG:08:04 – TX_FCTRL – Transmit Frame Control (Octet 4, 8-bits)																															
31	30	29	28	27	26	25	24	23	22	21	20	19	18	17	16	15	14	13	12	11	10	9	8	7	6	5	4	3	2	1	0
																												IFSDELAY			
																												0	0	0	0

The fields of the TX_FCTRL register identified above are individually described below:

Field	Description of fields within Register file: 0x08 – Transmit Frame Control															
TFLEN reg:08:00 bits:6–0	Transmit Frame Length. Standard IEEE 802.15.4 UWB frames can be up to 127 bytes long. The value specified here determines the length of the data portion of the transmitted frame. This length includes the two-octet CRC appended automatically at the end of the frame, unless SFCST (in Register file: 0x0D – System Control Register) is used to suppress the FCS. The frame length is also copied into the PHY Header of the TX frame so that the receiving device knows how much data to decode.															
TFLE reg:08:00 bits:9–7	Transmit Frame Length Extension. The DW1000 supports a non-standard mode of operation with data frame lengths up to 1023 bytes. This mode of operation is enabled via the PHR_MODE selection bits of Register file: 0x04 – System Configuration . In this long frame mode TFLE adds three high-order bits to TFLEN to extend the frame length to 10-bits, allowing frame length from 0 up to 1023 bytes to be sent. Please refer to section 3.4 –Extended Length Data Frames for more details of this non-standard mode.															
R	Reserved. Bits 12, 11 & 10 are reserved for future expansion. They should be set to zero.															
TXBR reg:08:00 bits:14,13	Transmit Bit Rate. This sets the user bit rate for the data portion of the frame as follows: <table border="1" style="margin-left: auto; margin-right: auto;"> <thead> <tr> <th>Bit 14</th> <th>Bit 13</th> <th>Bit Rate</th> </tr> </thead> <tbody> <tr> <td>0</td> <td>0</td> <td>110 kbps</td> </tr> <tr> <td>0</td> <td>1</td> <td>850 kbps</td> </tr> <tr> <td>1</td> <td>0</td> <td>6.8 Mbps</td> </tr> <tr> <td>1</td> <td>1</td> <td>reserved</td> </tr> </tbody> </table>	Bit 14	Bit 13	Bit Rate	0	0	110 kbps	0	1	850 kbps	1	0	6.8 Mbps	1	1	reserved
Bit 14	Bit 13	Bit Rate														
0	0	110 kbps														
0	1	850 kbps														
1	0	6.8 Mbps														
1	1	reserved														
TR reg:08:00 bit: 15	Transmit Ranging enable. This bit has no operational effect on the DW1000; however it is copied into the ranging bit in the PHY header (PHR) of the transmitted frame, identifying the frame as a ranging frame. In some receiver implementations this may be used to enable hardware or software associated with time-stamping the frame. In the DW1000 receiver the time-stamping of the receive frame does not depend or use the ranging bit in the received PHR.															

Field	Description of fields within Register file: 0x08 – Transmit Frame Control															
TXPRF reg:08:00 bits:17,16	<p>Transmit Pulse Repetition Frequency. This sets the mean Pulse Repetition Frequency (PRF) used in the transmitter:</p> <table border="1" style="margin-left: auto; margin-right: auto;"> <thead> <tr> <th>Bit 17</th> <th>Bit 16</th> <th>Nominal PRF</th> </tr> </thead> <tbody> <tr> <td>0</td> <td>0</td> <td>4 MHz</td> </tr> <tr> <td>0</td> <td>1</td> <td>16 MHz</td> </tr> <tr> <td>1</td> <td>0</td> <td>64 MHz</td> </tr> <tr> <td>1</td> <td>1</td> <td>reserved</td> </tr> </tbody> </table> <p>Note: (a) For successful reception of a frame the PRF in the receiver needs to be configured to be the same as the PRF used for transmitting the frame. (b) The choice of preamble code also needs to be appropriate to the configured PRF and needs to be the same in both transmitting and receiving ends for successful communication – please use Table 57 to select the appropriate preamble code. (c) The DW1000 receiver does not support the 4 MHz PRF.</p>	Bit 17	Bit 16	Nominal PRF	0	0	4 MHz	0	1	16 MHz	1	0	64 MHz	1	1	reserved
Bit 17	Bit 16	Nominal PRF														
0	0	4 MHz														
0	1	16 MHz														
1	0	64 MHz														
1	1	reserved														
TXPSR reg:08:00 bits:19,18	<p>Transmit Preamble Symbol Repetitions (PSR). This sets the length of the transmitted preamble sequence in symbols. Each preamble symbol is approximately 1 μs in duration¹. The two TXPSR bits are copied into the PHY Header. The receiving end is thus made aware of how much preamble was sent. This might inform its choice of preamble length in any reply message. There are four standard preamble lengths defined for the 802.15.4 UWB PHY – these are 16, 64, 1024 and 4096 symbols. The DW1000 has facility via the PE (Preamble Extension) configuration to send preambles of additional (non-standard) intermediary lengths. Table 15 below lists the selectable preamble lengths.</p>															

¹ The duration of preamble symbols is 993.59 ns with the 16 MHz PRF setting and 1017.63 ns with for 64 MHz PRF.

Field	Description of fields within Register file: 0x08 – Transmit Frame Control																																																		
<p>PE</p> <p>reg:08:00 bits:21,20</p>	<p>Preamble Extension. This field allows specification of a non-standard number of preamble symbol repetitions, thus extending the set of preamble lengths that are available to optimise system performance. The resultant preamble lengths depend the setting of both PE and TXPSR above. Table 15 below lists the useful preamble lengths that can be selected.</p> <p style="text-align: center;">Table 15: Preamble length selection</p> <table border="1" style="margin-left: auto; margin-right: auto;"> <thead> <tr> <th>Bit 19</th> <th>Bit 18</th> <th>Bit 21</th> <th>Bit 20</th> <th></th> </tr> <tr> <th colspan="2">TXPSR</th> <th colspan="2">PE</th> <th>Preamble Length</th> </tr> </thead> <tbody> <tr> <td>0</td> <td>1</td> <td>0</td> <td>0</td> <td>64</td> </tr> <tr> <td>0</td> <td>1</td> <td>0</td> <td>1</td> <td>128</td> </tr> <tr> <td>0</td> <td>1</td> <td>1</td> <td>0</td> <td>256</td> </tr> <tr> <td>0</td> <td>1</td> <td>1</td> <td>1</td> <td>512</td> </tr> <tr> <td>1</td> <td>0</td> <td>0</td> <td>0</td> <td>1024</td> </tr> <tr> <td>1</td> <td>0</td> <td>0</td> <td>1</td> <td>1536</td> </tr> <tr> <td>1</td> <td>0</td> <td>1</td> <td>0</td> <td>2048</td> </tr> <tr> <td>1</td> <td>1</td> <td>0</td> <td>0</td> <td>4096</td> </tr> </tbody> </table> <p style="text-align: center;">The bit numbers quoted above are the bit numbers in the TX_FCTRL register.</p> <p>The choice of preamble length has a bearing on operating range and system performance, a discussion of the factors affecting the choice of preamble length (and other parameters) may be found in section 9.3 below.</p>	Bit 19	Bit 18	Bit 21	Bit 20		TXPSR		PE		Preamble Length	0	1	0	0	64	0	1	0	1	128	0	1	1	0	256	0	1	1	1	512	1	0	0	0	1024	1	0	0	1	1536	1	0	1	0	2048	1	1	0	0	4096
Bit 19	Bit 18	Bit 21	Bit 20																																																
TXPSR		PE		Preamble Length																																															
0	1	0	0	64																																															
0	1	0	1	128																																															
0	1	1	0	256																																															
0	1	1	1	512																																															
1	0	0	0	1024																																															
1	0	0	1	1536																																															
1	0	1	0	2048																																															
1	1	0	0	4096																																															
<p>TXBOFFS</p> <p>reg:08:00 bits:31–22</p>	<p>Transmit buffer index offset. This 10-bit field is used to specify an index in the transmit buffer of the first octet to be transmitted. The TX frame begins with the octet at the TXBOFFS index and continues for the number octets specified by the frame length (TFLEN and TFLE) less 2 for the CRC. Care should be taken that the TXBOFFS plus the frame length does not extend past the end of the TX_BUFFER. Some uses for TXBOFFS are outlined in section 3.5.1.</p>																																																		
<p>IFSDELAY</p> <p>reg:08:04 bits:7–0</p>	<p>Inter-Frame Spacing. This delay in preamble symbol times will be applied between successive transmitted frames. One use of the IFSDELAY is to allow the receiver time to unload and process the frame before another frame is sent to it. For this reason IFSDELAY is logically considered to be a post-amble to the transmitted frame, and it begins counting down after the last symbol of data is sent. Where the transmitter is enabled to begin a new frame the DW1000 makes sure that IFSDELAY symbol times have passed. A new value of IFSDELAY for the next frame should not be set until after the end-of-frame TXFRS (Transmit Frame Sent) event has occurred. The IFSDELAY sets a minimum time between frames enforced by the DW1000, assuming that the host has initiated a new transmission. Note: Because of internal IC delays the on-air gap between the end of the previous frame and the start of the new one is actually 6 symbol times larger than specified here, e.g. an IFSDELAY setting of 34 will result in an on-air gap of 40 preamble symbols.</p>																																																		

7.2.11 Register file: 0x09 – Transmit Data Buffer

ID	Length (octets)	Type	Mnemonic	Description
0x09	1024	RW	TX_BUFFER	Transmit Data Buffer

[Register map](#) register file 0x09 is the transmit data buffer. Data from the transmit buffer is transmitted during the data payload portion of the transmitted frame. Section 3 – [Message Transmission](#) discusses the basics of frame transmission and details the various parts of the TX frame.

The general procedure is to write the data frame for transmission into the TX_BUFFER set the frame length and other details in the TX_FCTRL register and initiate transmission using in the TXSTRT control bit in [Register file: 0x0D – System Control Register](#).

7.2.12 Register file: 0x0A – Delayed Send or Receive Time

ID	Length (octets)	Type	Mnemonic	Description
0x0A	5	RW	DX_TIME	Delayed Send or Receive Time (40-bit)

[Register map](#) register file 0x0A, the Delayed Send or Receive Time, is used to specify a time in the future to either turn on the receiver to be ready to receive a frame, or to turn on the transmitter and send a frame. The low-order 9-bits of this register are ignored. Delayed send is initiated by the TXDLYS control bit in [Register file: 0x0D – System Control Register](#). Delayed receive is initiated by the RXDLYE bit. [Register file: 0x0D – System Control Register](#). For more information see section 3.3 – [Delayed Transmission](#) and section 4.2 – [Delayed Receive](#).

Refer to the TX_PSTM field of [Sub-Register 0x2F:24 – Digital Diagnostics Test Mode Control](#) for details of how to program this register for use in Transmit Power Spectrum Test Mode and note that bits 31:0 only are used in this mode, whilst the 9 least significant bits are ignored in functional modes.

7.2.13 Register file: 0x0B – Reserved

ID	Length (octets)	Type	Mnemonic	Description
0x0B	-	-	-	Reserved – this register file is reserved

[Register map](#) register file 0x0B is reserved for future use. Please take care not to write to this register as doing so may cause the DW1000 to malfunction.

7.2.14 Register file: 0x0C – Receive Frame Wait Timeout Period

ID	Length (octets)	Type	Mnemonic	Description
0x0C	2	RW	RX_FWTO	Receive Frame Wait Timeout period

[Register map](#) register file 0x0C is the receive frame wait timeout period. The receive frame wait timeout function is provided to allow the external microprocessor to enter a low power state awaiting a valid receive frame and be woken up by the DW1000 when either a frame is received or the programmed timeout has elapsed. While many microcontrollers have timers that might be used for this purpose, including this RX timeout functionality in the DW1000 allows additional flexibility to the system designer in selecting the microprocessor to optimise the solution. The frame wait timeout is enabled by the RXWTOE bit in [Register file: 0x04 – System Configuration](#).

When the receiver is enabled (and begins hunting for the preamble sequence) and RXWTOE is set, then the frame wait timeout counter starts counting the timeout period programmed. Thereafter, assuming no action is taken to change the operation, one of two things should happen:

- a) The Receive Frame Wait Timeout period elapses. This disables the receiver and sets the RXRFTO (Receiver Frame Wait Timeout) bit in the status register, (and resets the counter).
- b) A valid receive frame arrives and sets the RXDFR and RXFCG bits in the status register. This stops the receive frame wait timer counter so RXRFTO will not be set.

The receiver will not re-enable immediately following a RXRFTO (Receiver Frame Wait Timeout) irrespective of whether the device is using the Double Receive Buffer, see section 4.3, or the Automatic Receiver Re-enable, see section 5.3.2.

The timeout period should only be programmed when the device IDLE. Programming the timeout value at other times is not prevented but may result in unpredictable behaviour.

The MRXFCG and MRXRFTO mask bits in the SYS_MASK register may be configured (before enabling the receiver) to generate interrupts to the controlling microprocessor. If RXWTOE is cleared while the countdown is running the countdown will be disabled, and RXRFTO will not be set.

When frame filtering is employed, any frames rejected are not treated as valid RX frames (neither RXDFR or RXFCG are set) so the receiver and the receive frame wait timeout just continues its countdown

[Register file: 0x0C – Receive Frame Wait Timeout Period](#) contains the following fields:

REG:0C:00 – RX_FWTO – Receive Frame Wait Timeout Period																															
31	30	29	28	27	26	25	24	23	22	21	20	19	18	17	16	15	14	13	12	11	10	9	8	7	6	5	4	3	2	1	0
-	-	-	-	-	-	-	-	-	-	-	-	-	-	-	-	RXFWTO															
0	0	0	0	0	0	0	0	0	0	0	0	0	0	0	0	0															

The individual sub-fields are described below:

Field	Description of fields within Register file: 0x0C – Receive Frame Wait Timeout Period
-------	--

Field	Description of fields within Register file: 0x0C – Receive Frame Wait Timeout Period
RXFWTO reg:0C:00 bits:15–0	The Receive Frame Wait Timeout period is a 16-bit field. The units for this parameter are roughly 1µs, (the exact unit is 512counts of the fundamental 499.2 MHz UWB clock, or 1.026 µs). When employing the frame wait timeout, RXFWTO should be set to a value greater than the expected RX frame duration and include an allowance for any uncertainty attaching to the expected transmission start time of the awaited frame. The Receive Frame Wait Timeout feature is enabled by the RXWTOE in Register file: 0x04 – System Configuration . When RXWTOE is set then each time the receiver is enabled a timer is started with the RXFWTO specified period, and if no data is received before this RX Frame Wait Timeout timer expires, then the receiver is returned to its idle state and the timeout is signalled by the RXRFTO event status bit in Register file: 0x0F – System Event Status Register .
- reg:0C:00 bits:31–16	These bits reserved and should always be written as zero.

Note: The frame wait timeout may also be employed with double buffering, where after a frame is received the DW1000 automatically re-enables the receiver (moving on to potentially receive a new frame in the next buffer). Here when RXWTOE is set the countdown will be restarted as the receiver re-enables to receive into the next buffer. See section [4.3 - Double Receive Buffer](#) for more information on double buffering.

7.2.15 Register file: 0x0D – System Control Register

ID	Length (octets)	Type	Mnemonic	Description
0x0D	4	SRW	SYS_CTRL	System Control Register

[Register map](#) register file 0x0D is the system control register, contains a number of TX control fields. Each field is separately identified and described below. For a general discussion of transmission please refer to section [3 – Message Transmission](#). The control bits within the system control register are typically automatically clearing. The host controller sets the appropriate bit to invoke an activity and the bit is automatically cleared by the DW1000 as that commanded activity begins.

REG:0D:00 – SYS_CTRL – System Control																																
31	30	29	28	27	26	25	24	23	22	21	20	19	18	17	16	15	14	13	12	11	10	9	8	7	6	5	4	3	2	1	0	
.	HRBPT	RXDLYE	RXENAB	WAIT4RESP	TRXOFF	.	.	CANSFCS	TXDLYS	TXSTRT	SFCST
0	0	0	0	0	0	0	0	0	0	0	0	0	0	0	0	0	0	0	0	0	0	0	0	0	0	0	0	0	0	0	0	

Field	Description of fields within Register file: 0x0D – System Control Register
-	Bits marked '-' in register 0x0D are reserved and should always be written as zero.

Field	Description of fields within Register file: 0x0D – System Control Register
SFCST reg:0D:00 bit:0	<p>Suppress auto-FCS Transmission (on this next frame). This control works in conjunction with the TXSTRT (Transmit Start) bit below to control whether or not the DW1000 automatically calculates and appends the two Frame-Check-Sequence bytes. It is expected that the host will decide this as transmission is invoked and set SFCST at the same time as TXSTRT is set if FCS suppression is required. Normally SFCST is not set when transmission is started and the DW1000 calculates the FCS on the octets fetched from the TX buffer, and automatically appends the two-byte FCS sequence at the end of the frame. The FCS sequence follows the IEEE 802.15.4 standard polynomial, $x^{16} + x^{12} + x^5 + 1$, also known as CRC-16-CCITT or CRC-16 ITU-T. When SFCST is set (as transmission is started) the DW1000 will not append the FCS to the data frame but instead fetches the two bytes from the TX buffer. The frame length is determined by the TFLEN field of Register file: 0x08 – Transmit Frame Control. So, when SFCST is clear, TFLEN-2 (frame length minus two) octets are fetched and sent from the TX buffer, and the final two octets sent are the automatically generated FCS bytes. And, when SFCST is set, TFLEN (frame length) octets are sent from the TX buffer. SFCST may be of use if a non-standard IEEE 802.15.4 frame protocol is being employed, and can also be of use to induce a FCS error in the remote receiver during testing. The SFCST bit will clear as soon as the DW1000 sees TXSTRT and initiates transmission.</p>
TXSTRT reg:0D:00 bit:1	<p>Transmit Start. This bit commands the DW1000 to begin transmission. When the DW1000 is in idle mode and the TXSTRT bit is set it the IC will begin transmission of a frame immediately, unless TXDLYS is set (see below). In general it would be expected that the user has a prepared frame in the transmit buffer and has configured the desired transmit mode and set the frame length, in Register file: 0x08 – Transmit Frame Control, before setting TXSTRT to invoke transmission. For a general discussion of transmission see section3 – Message Transmission. The TXSTRT bit will clear as soon as the DW1000 sees it and initiates transmission.</p>
TXDLYS reg:0D:00 bit:2	<p>Transmitter Delayed Sending. This control works in conjunction with TXSTRT and the DX_TIME value specified by Register file: 0x0A – Delayed Send or Receive Time. When the user wants to control the time of sending of a frame, the send time is programmed into DX_TIME, and then both TXDLYS and TXSTRT should be set at the same time to correctly invoke the delayed sending feature. The TXDLYS bit will clear along with the TXSTRT bit when the delay has completed and the frame transmission begins and initiates the delayed transmission.</p> <p>When delayed sending is used the DW1000 precisely controls the transmission start time so that the internal TX timestamp occurs at the point when SYS_TIME is equal to the DX_TIME value. The actual time of TX then is calculable as DX_TIME plus the TX antenna delay.</p> <p>TXDLYS has a number of uses: -</p> <ul style="list-style-type: none"> • It can be used to give precise control of the transmission time of a response message, which would allow a receiver that knows this response time to only turn on at the correct time to receive the response, thus saving power. • In symmetric double-sided two-way ranging, the RX to TX response times at either end should be the same so that their differences in local clocks correctly cancel out. This may be ensured by setting TXDLYS to a value that is a fixed delta added the RX timestamp. • In two-way ranging the TX timestamp of the final message exchange needs to be communicated to the receiving end to allow the round-trip delay to be calculated. Using TXDLYS allows this time to be predicted, pre-calculated and embedded into the final message itself. This may save the need for an additional message interchange which will give a power saving, and save time too. • Embedding the TX time in this way may also reduce the number of messages in a wireless clock synchronisation scheme.

Field	Description of fields within Register file: 0x0D – System Control Register
CANSFCS reg:0D:00 bit:3	Cancel Suppression of auto-FCS transmission (on the current frame). This bit is intended to be used when transmission is kicked off before the data is actually written to the transmit buffer, which can be used to speed response times and/or system data throughput. A general discussion of these techniques may be found in section 3.5 – High Speed Transmission . The general principle is that not to send the FCS (marking a good frame) until all the data is written to the TX_BUFFER. So transmission is initiated with SFCST set to suppress the FCS and when all data is written to the TX_BUFFER the FCS transmission is enabled allowed setting this CANSFCS bit to cancel the suppression, i.e. allow the transmission of the FCS. The DW1000 transmitter includes a circuit to detect the host microprocessor writing to the buffer between the configured TXBOFFS and any address it has already consumed data from, which is taken to mean the HOST has written the data too late for transmission, in which case the setting of CANSFCS will be ignored and the frame will be transmitted with a bad CRC. This condition is signalled by the TXBERR bit in Register file: 0x0F – System Event Status Register . The CANSFCS bit will clear as soon as the DW1000 sees and acts on it.
TRXOFF reg:0D:00 bit:6	Transceiver Off. When this is set the DW1000 returns to idle mode immediately. Any TX or RX activity that is in progress at that time will be aborted. The TRXOFF bit will clear as soon as the DW1000 sees it and returns the IC to idle mode.
WAIT4RESP reg:0D:00 bit:7	Wait for Response. The WAIT4RESP control works in conjunction with TXSTRT bit above and the W4R_TIM value in Register file: 0x1A – Acknowledgement time and response time . When WAIT4RESP is set at the same time as the TXSTRT then when the DW1000 has finished transmitting the frame it will automatically turn-around, disabling the transmitter and enabling the receiver, to await a response frame. The W4R_TIM value may be programmed with a delay between TX end and RX enable. Delaying turning on the receiver will save power in cases where the response is known to be a delayed by a certain amount. The WAIT4RESP bit will clear at the time when DW1000 enables the receiver, (or when a TRXOFF is employed). NB: When in use the WAIT4RESPbit must be set at the same time as the TXSTRT bit is set, (i.e. by the same write).
RXENAB reg:0D:00 bit:8	Enable Receiver. This bit commands the DW1000 to turn on its receiver and begin looking for the configured preamble sequence. It is assumed that the all necessary configurations have been made before turning on the receiver. For a general discussion of reception see section 4 – Message Reception . The RXENAB bit will clear as soon as the DW1000 sees it and initiates reception.
RXDLYE reg:0D:00 bit:9	Receiver Delayed Enable. This control works in conjunction with RXENAB and the DX_TIME value specified by Register file: 0x0A – Delayed Send or Receive Time . When the user wants to control the time of turning on the receiver, the turn on time is programmed into DX_TIME, and then both RXDLYE and RXENAB should be set to correctly invoke the delayed receiving feature. The DW1000 then precisely controls the RX turn on time so that it is ready to receive the first symbol of preamble at the specified DX_TIME start time. In cases when the received time can be known precisely, for example when a response is expected at a well-defined time, employing RXDLYE will give a power saving as it allows the IC to remain idle until the moment it is required to act for the reception.
HRBPT reg:0D:00 bit:24	Host Side Receive Buffer Pointer Toggle. In the doubly buffered receiver mode the host uses this bit to change which of the buffer pairs it is reading from. The half being accessed is reported by the HSRBP (Host Side Receive Buffer Pointer) status bit in Register file: 0x0F – System Event Status Register . See section 4.3 – Double Receive Buffer for more details.

7.2.16 Register file: 0x0E – System Event Mask Register

ID	Length (octets)	Type	Mnemonic	Description
0x0E	4	RW	SYS_MASK	System Event Mask Register

[Register map](#) register file 0x0E is the system event mask register. These are aligned with the event status bits in the SYS_STATUS register. Whenever a bit in the SYS_MASK is set (to 1) and the corresponding bit in the SYS_STATUS register is also set, then an interrupt will be generated asserting the hardware IRQ output line. The interrupt condition may be removed by clearing the corresponding bit in this SYS_MASK register (by setting it to 0) or by clearing the corresponding latched bit in the SYS_STATUS register (generally by writing a 1 to the bit – please refer to individual SYS_STATUS register bit definitions for details).

The SYS_STATUS register contains the system event status bits identified and described below:

REG:0E:00 – SYS_MASK – System Event Mask																															
31	30	29	28	27	26	25	24	23	22	21	20	19	18	17	16	15	14	13	12	11	10	9	8	7	6	5	4	3	2	1	0
-	-	MAFFREJ	MTXBERR	MHPDWARN	MRXSFDTO	MPLLILO	MRFPLLLL	MSLP2INIT	MGPIOIRQ	MRXPTO	MRXOVRR	-	MLDEERR	MRXRFTO	MRXRFSL	MRXFCE	MRXFCG	MRXDFR	MRXPHE	MRXPHD	MLDEDON	MRXSDDD	MRXPRD	MTXFERS	MTXPHS	MTXPRS	MTXFRB	MAAT	MESYNCR	MCPLOCK	-
0	0	0	0	0	0	0	0	0	0	0	0	0	0	0	0	0	0	0	0	0	0	0	0	0	0	0	0	0	0	0	0

The system event mask bits of the SYS_MASK register identified above are individually described below:

Field	Description of fields within Register file: 0x0E – System Event Mask Register
– reg:0E:00 bit:0	This bit is reserved.
MCPLOCK reg:0E:00 bit:1	Mask clock PLL lock event. When MCPLOCK is 0 the CPLOCK event status bit will not generate an interrupt. When MCPLOCK is 1 and the CPLOCK event status bit is 1, the hardware IRQ interrupt line will be asserted to generate an interrupt.
MESYNCR reg:0E:00 bit:2	Mask external sync clock reset event. When MESYNCR is 0 the ESYNCR event status bit will not generate an interrupt. When MESYNCR is 1 and the ESYNCR event status bit is 1, the hardware IRQ interrupt line will be asserted to generate an interrupt.
MAAT reg:0E:00 bit:3	Mask automatic acknowledge trigger event. When MAAT is 0 the AAT event status bit will not generate an interrupt. When MAAT is 1 and the AAT event status bit is 1, the hardware IRQ interrupt line will be asserted to generate an interrupt. AAT should be masked when the automatic acknowledge is not enabled so that spurious interrupts cannot affect system behaviour.
MTXFRB reg:0E:00 bit:4	Mask transmit frame begins event. When MTXFRB is 0 the TXFRB event status bit will not generate an interrupt. When MTXFRB is 1 and the TXFRB event status bit is 1, the hardware IRQ interrupt line will be asserted to generate an interrupt.
MTXPRS reg:0E:00 bit:5	Mask transmit preamble sent event. When MTXPRS is 0 the TXPRS event status bit will not generate an interrupt. When MTXPRS is 1 and the TXPRS event status bit is 1, the hardware IRQ interrupt line will be asserted to generate an interrupt.

Field	Description of fields within Register file: 0x0E – System Event Mask Register
MTXPHS reg:0E:00 bit:6	Mask transmit PHY Header Sent event. When MTXPHS is 0 the TXPHS event status bit will not generate an interrupt. When MTXPHS is 1 and the TXPHS event status bit is 1, the hardware IRQ interrupt line will be asserted to generate an interrupt.
MTXFRS reg:0E:00 bit:7	Mask transmit frame sent event. When MTXFRS is 0 the TXFRS event status bit will not generate an interrupt. When MTXFRS is 1 and the TXFRS event status bit is 1, the hardware IRQ interrupt line will be asserted to generate an interrupt.
MRXPRD reg:0E:00 bit:8	Mask receiver preamble detected event. When MRXPRD is 0 the RXPRD event status bit will not generate an interrupt. When MRXPRD is 1 and the RXPRD event status bit is 1, the hardware IRQ interrupt line will be asserted to generate an interrupt.
MRXSFD	Mask receiver SFD detected event. When MRXSFD is 0 the RXSFD event status bit will not generate an interrupt. When MRXSFD is 1 and the RXSFD event status bit is 1, the hardware IRQ interrupt line will be asserted to generate an interrupt.
MLDEDONE reg:0E:00 bit:10	Mask LDE processing done event. When MLDEDONE is 0 the LDEDONE event status bit will not generate an interrupt. When MLDEDONE is 1 and the LDEDONE event status bit is 1, the hardware IRQ interrupt line will be asserted to generate an interrupt.
MRXPHD reg:0E:00 bit:11	Mask receiver PHY header detect event. When MRXPHD is 0 the RXPHD event status bit will not generate an interrupt. When MRXPHD is 1 and the RXPHD event status bit is 1, the hardware IRQ interrupt line will be asserted to generate an interrupt.
MRXPHE reg:0E:00 bit:12	Mask receiver PHY header error event. When MRXPHE is 0 the RXPHE event status bit will not generate an interrupt. When MRXPHE is 1 and the RXPHE event status bit is 1, the hardware IRQ interrupt line will be asserted to generate an interrupt.
MRXDFR reg:0E:00 bit:13	Mask receiver data frame ready event. When MRXDFR is 0 the RXDFR event status bit will not generate an interrupt. When MRXDFR is 1 and the RXDFR event status bit is 1, the hardware IRQ interrupt line will be asserted to generate an interrupt.
MRXFCG reg:0E:00 bit:14	Mask receiver FCS good event. When MRXFCG is 0 the RXFCG event status bit will not generate an interrupt. When MRXFCG is 1 and the RXFCG event status bit is 1, the hardware IRQ interrupt line will be asserted to generate an interrupt.
MRXFCE reg:0E:00 bit:15	Mask receiver FCS error event. When MRXFCE is 0 the RXFCE event status bit will not generate an interrupt. When MRXFCE is 1 and the RXFCE event status bit is 1, the hardware IRQ interrupt line will be asserted to generate an interrupt.
MRXRFSL reg:0E:00 bit:16	Mask receiver Reed Solomon Frame Sync Loss event. When MRXRFSL is 0 the RXRFSL event status bit will not generate an interrupt. When MRXRFSL is 1 and the RXRFSL event status bit is 1, the hardware IRQ interrupt line will be asserted to generate an interrupt.
MRXRFTO reg:0E:00 bit:17	Mask Receive Frame Wait Timeout event. When MRXRFTO is 0 the RXRFTO event status bit will not generate an interrupt. When MRXRFTO is 1 and the RXRFTO event status bit is 1, the hardware IRQ interrupt line will be asserted to generate an interrupt.
MLDEERR reg:0E:00 bit:18	Mask leading edge detection processing error event. When MLDEERR is 0 the LDEERR event status bit will not generate an interrupt. When MLDEERR is 1 and the LDEERR event status bit is 1, the hardware IRQ interrupt line will be asserted to generate an interrupt.
– reg:0F:00 bit:19	This bit is reserved.
MRXOVRR reg:0E:00 bit:20	Mask Receiver Overrun event. When MRXOVRR is 0 the RXOVRR event status bit will not generate an interrupt. When MRXOVRR is 1 and the RXOVRR event status bit is 1, the hardware IRQ interrupt line will be asserted to generate an interrupt.

Field	Description of fields within Register file: 0x0E – System Event Mask Register
MRXPTO reg:0E:00 bit:21	Mask Preamble detection timeout event. When MRXPTO is 0 the RXPTO event status bit will not generate an interrupt. When MRXPTO is 1 and the RXPTO event status bit is 1, the hardware IRQ interrupt line will be asserted to generate an interrupt.
MGPIOIRQ reg:0E:00 bit:22	Mask GPIO interrupt event. When MGPIOIRQ is 0 the GPIOIRQ event status bit will not generate an interrupt. When MGPIOIRQ is 1 and the GPIOIRQ event status bit is 1, the hardware IRQ interrupt line will be asserted to generate an interrupt.
MSLP2INIT reg:0E:00 bit:23	Mask SLEEP to INIT event. When MSLP2INIT is 0 the SLP2INIT event status bit will not generate an interrupt. When MSLP2INIT is 1 and the SLP2INIT event status bit is 1, the hardware IRQ interrupt line will be asserted to generate an interrupt.
MRFPLLLL reg:0E:00 bit:24	Mask RF PLL Losing Lock warning event. When MRFPLLLL is 0 the RFPLL_LL event status bit will not generate an interrupt. When MRFPLLLL is 1 and the RFPLL_LL event status bit is 1, the hardware IRQ interrupt line will be asserted to generate an interrupt.
MCPLLLL reg:0E:00 bit:25	Mask Clock PLL Losing Lock warning event. When MCPLLLL is 0 the CLKPLL_LL event status bit will not generate an interrupt. When MCPLLLL is 1 and the CLKPLL_LL event status bit is 1, the hardware IRQ interrupt line will be asserted to generate an interrupt.
MRXSFDTO reg:0E:00 bit:26	Mask Receive SFD timeout event. When MRXSFDTO is 0 the RXSFDTO event status bit will not generate an interrupt. When MRXSFDTO is 1 and the RXSFDTO event status bit is 1, the hardware IRQ interrupt line will be asserted to generate an interrupt.
MHPDWARN reg:0E:00 bit:27	Mask Half Period Delay Warning event. When MHPDWARN is 0 the HPDWARN event status bit will not generate an interrupt. When MHPDWARN is 1 and the HPDWARN event status bit is 1, the hardware IRQ interrupt line will be asserted to generate an interrupt.
MTXBERR reg:0E:00 bit:28	Mask Transmit Buffer Error event. When MTXBERR is 0 the TXBERR event status bit will not generate an interrupt. When MTXBERR is 1 and the TXBERR event status bit is 1, the hardware IRQ interrupt line will be asserted to generate an interrupt.
MAFFREJ reg:0E:00 bit:29	Mask Automatic Frame Filtering rejection event. When MAFFREJ is 0 the AFFREJ event status bit will not generate an interrupt. When MAFFREJ is 1 and the AFFREJ event status bit is 1, the hardware IRQ interrupt line will be asserted to generate an interrupt.
– reg:0E:00 bits:30,31	These bits are reserved.

7.2.17 Register file: 0x0F – System Event Status Register

ID	Length (octets)	Type	Mnemonic	Description
0x0F	5	SRW	SYS_STATUS	System Event Status Register

[Register map](#) register file 0x0F is the system event status register, SYS_STATUS. It contains status bits that indicate the occurrence of different system events or status changes. It is possible to enable particular events as interrupt sources, by employing the SYS_MASK, [Register file: 0x0E – System Event Mask Register](#), so that the setting of the event status bit will generate an interrupt, asserting the hardware IRQ output line. This can be used, for example, to allow the host processor to enter a low-power state during frame transmission or reception awaiting an interrupt to wake upon the completion of the TX or RX activity.

Reading the SYS_STATUS register returns the state of the status bits. Generally these event status bits are latched so that the event is captured. Such latched bits need to be explicitly cleared by writing a '1' to the bit position (writing '0' has no effect).

The SYS_STATUS register contains the system event status bits identified and described below:

REG:0F:00 – SYS_STATUS – System Status Register (octets 0 to 3)																															
31	30	29	28	27	26	25	24	23	22	21	20	19	18	17	16	15	14	13	12	11	10	9	8	7	6	5	4	3	2	1	0
ICRBP	HSRBP	AFFREJ	TXBERR	HPDWARN	RXSFDTO	CLKPLL_LL	RFPLL_LL	SLP2INIT	GPIOIRQ	RXPTO	RXOVRR	-	LDEERR	RXRFTO	RXRFLS	RXFCE	RXFCEG	RXDFR	RXPHE	RXPHD	LDEDONE	RXSFD	RXPRD	TXFRS	TXPHS	TXPRS	TXFRB	AAT	ESYNCR	CPLOCK	IRQS
0	0	0	0	0	0	0	0	0	0	0	0	0	0	0	0	0	0	0	0	0	0	0	0	0	0	0	0	0	0	0	0

REG:0F:04 – SYS_STATUS – System Status Register (octet 4)																															
31	30	29	28	27	26	25	24	23	22	21	20	19	18	17	16	15	14	13	12	11	10	9	8	7	6	5	4	3	2	1	0
																								-	-	-	-	-	TXPUJE	RXPRES	RXRSCS
																								0	0	0	0	0	0	0	0

The system event status bits of the SYS_STATUS register identified above are individually described below:

Field	Description of fields within Register file: 0x0F – System Event Status Register
IRQS reg:0F:00 bit:0	Interrupt Request Status. This is a READ ONLY status flag – it cannot be cleared or overwritten. Whenever a status bit in <i>Register file: 0x0F – System Event Status Register</i> is activated (i.e. has a value of 1) and the corresponding bit in <i>Register file: 0x0E – System Event Mask Register</i> is enabled (i.e. has a value of 1 also) then the IRQ interrupt request line will be driven to its active ON level. If there are no active mask enabled status bits then the IRQ interrupt request line will be set to its inactive OFF level. This IRQS flag reflects the overall status of interrupts. If there are any unmasked interrupt sources active then the IRQS bit will be 1 (and IRQ interrupt request line will be at its active ON level) the otherwise IRQS will be zero (and IRQ interrupt request line at its OFF level). The polarity of the IRQ interrupt request line is controllable via the HIRQ_POL configuration bit in <i>Register file: 0x04 – System Configuration</i> .
CPLOCK reg:0F:00 bit:1	Clock PLL Lock. The CPLOCK event status bit indicates that the digital clock PLL has locked. This may be used as an interrupt to indicate that the DW1000 clock is operating at full speed, after which the SPI can be run at its maximum rate also. The CPLOCK bit is cleared by writing a 1 to it. The clock PLL lock status is also available via the CPLLLOCK status bit in <i>Sub-Register 0x28:2C – RF_STATUS</i> . Note that this lock detect flag may not be reliable and is only used for debug purposes.
ESYNCR reg:0F:00 bit:2	External Sync Clock Reset. This event status bit is set when the system counter is reset as a result of the reception of an external synchronisation clock reset signal on the SYNC pin. The ESYNCR flag bit is cleared by writing a 1 to it. Section <i>6.1 – External Synchronisation</i> describes this feature.

Field	Description of fields within Register file: 0x0F – System Event Status Register
AAT reg:0F:00 bit:3	<p>Automatic Acknowledge Trigger. This status event status bit is set when frame filtering is enabled and a data frame (or MAC command frame) is received (correctly addressed and with a good CRC) with the acknowledgement request bit set in its frame control field.</p> <p>If the automatic acknowledgement is enabled (by the AUTOACK bit in Register file: 0x04 – System Configuration) then the AAT bit can be used during receive interrupt processing to detect that acknowledgement is in progress and so avoid taking any action until the transmission of the acknowledgement is completed – an event that might be detected by awaiting the TXFRS (Transmit Frame Sent) status interrupt.</p> <p>If automatic acknowledgement is not enabled, then the AAT status bit must be ignored.</p> <p>The AAT bit can be cleared explicitly by writing a 1 to it. It is also automatically cleared by the next receiver enable, (including those caused by the RXAUTR auto-re-enable).</p>
TXFRB reg:0F:00 bit:4	<p>Transmit Frame Begins. This event status bit is set at the start of a frame transmission as the transmitter begins to send preamble. The TXFRB bit is automatically cleared at the next transmitter enable. It can also be cleared explicitly by writing a 1 to it.</p>
TXPRS reg:0F:00 bit:5	<p>Transmit Preamble Sent. This event status bit is set at the end of preamble when SDF sending begins. The TXPRS bit is automatically cleared at the next transmitter enable. It can also be cleared explicitly by writing a 1 to it.</p>
TXPHS reg:0F:00 bit:6	<p>Transmit PHY Header Sent. This event status bit is set when the PHR has been transmitted. This marks the start of sending the data part of the frame (assuming the frame length is non-zero) at the configured transmit data rate. The TXPHS bit is automatically cleared at the next transmitter enable. It can also be cleared explicitly by writing a 1 to it.</p>
TXFRS reg:0F:00 bit:7	<p>Transmit Frame Sent. This event status bit is set at the end of sending the data part of the frame. It is expected that this will be used as the main “Transmit Done” (interrupt) event signalling the completion of frame transmission. (In the case where frame length is zero the TXFRS bit is set soon after the TXPHS event flag). The TXFRS bit is automatically cleared at the next transmitter enable. It can also be cleared explicitly by writing a 1 to it.</p>
RXPRD reg:0F:00 bit:8	<p>Receiver Preamble Detected status. This event status bit is set to indicate that the receiver has detected (and confirmed) the presence of the preamble sequence. Preamble reception continues after RXPRD has been set until the SFD is detected as signalled by the RXSFDD event status bit or an SFD timeout occurs as signalled by the RXSFDTO event status bit. Section 4 – Message Reception gives details of the frame reception process. The RXPRD bit can be cleared explicitly by writing a 1 to it. It is also automatically cleared by the next receiver enable, including those caused by the RXAUTR auto-re-enable.</p>
RXSFDD reg:0F:00 bit:9	<p>Receiver SFD Detected. This event status bit is set to indicate that the receiver has detected the SFD sequence and is moving on to decode the PHR. Section 4 – Message Reception gives details of the frame reception process. The RXSFDD bit can be cleared explicitly by writing a 1 to it. It is also automatically cleared by the next receiver enable, including those caused by the RXAUTR auto-re-enable.</p>

Field	Description of fields within Register file: 0x0F – System Event Status Register
LDEDONE reg:0F:00 bit:10	LDE processing done. This event status bit is set to indicate the completion of the leading edge detection and other adjustments of the receive timestamp information. The resultant adjusted message RX timestamp is then available in Register file: 0x15 – Receive Time Stamp . The detection of SFD as reported by the RXSFDD event status bit marks the end of the SFD and the start of the PHR, which also marks the RMARKER whose arrival at the antenna is the event that defines the frame arrival timestamp. To accurately determine this timestamp the DW1000 employs an internal algorithm to adjust the RMARKER receive time. Among other functions this performs a leading edge detection search on the channel impulse response and subtracts the receive antenna delay as programmed in Sub-Register 0x2E:1804 – LDE_RXANTD . For more information on the LDE and the process on message time-stamping see section 4.1.6 – RX Message timestamp . The LDEDONE event status flag bit is included in the RX double-buffered swinging-set . It is automatically cleared by the RX enable. It can also be cleared explicitly by writing a 1 to it.
RXPHD reg:0F:00 bit:11	Receiver PHY Header Detect. This event status bit is set to indicate that the receiver has completed the decoding of the PHR. Section 4 – Message Reception gives details of the frame reception process. The RXPHD bit can be cleared explicitly by writing a 1 to it. It is also automatically cleared by the next receiver enable, including those caused by the RXAUTR auto-re-enable.
RXPHE reg:0F:00 bit:12	Receiver PHY Header Error. This event status bit is set to indicate that the receiver has found a non-correctable error in the PHR. The PHR includes a SECDED error check sequence (see section 10.4) that can correct a single bit error and detect a double bit error. The double error is not correctable and its detection is the event that the RXPHE event status flag is notifying. Generally this error means that correct frame reception is not possible, and so typically this event will abort frame reception (depending on the DIS_PHE configuration in Register file: 0x04 – System Configuration) after which the receiver may return to preamble search (depending on the RXAUTR configuration also in Register file: 0x04 – System Configuration). Section 4 – Message Reception gives details of the frame reception process. The RXPHE bit can be cleared explicitly by writing a 1 to it. It is also automatically cleared by the next receiver enable, including those caused by the RXAUTR auto-re-enable. PHY Header Error events are counted in Sub-Register 0x2F:04 – PHR Error Counter , as long as counting is enabled by the EVC_EN bit in Sub-Register 0x2F:00 – Event Counter Control .
RXDFR reg:0F:00 bit:13	Receiver Data Frame Ready. This event status bit is set to indicate that the completion of the frame reception process. Section 4 – Message Reception gives details of the frame reception process. It is expected that this will be used as the main “Receive” (interrupt) event signalling the completion of a frame reception, and, that the receive event processing routine will examine the RXFCG and RXFCE to determine whether the frame has been received without error (or not), and also to check the LDEDONE event status flag to validate the receive timestamp information. In order to ensure that the receive timestamp information is valid before any receive interrupt processing takes place, the setting of RXDFR is delayed until the LDE adjustments of the timestamp have completed, at which time the LDEDONE event status bit will be set (or possibly LDEERR). The RXDFR event status flag bit is included in the RX double-buffered swinging-set . It is automatically cleared by the RX enable. It can also be cleared explicitly by writing a 1 to it.

Field	Description of fields within Register file: 0x0F – System Event Status Register
RXFCG reg:0F:00 bit:14	Receiver FCS Good. This event status bit reflects the result of the frame CRC checking. It is set (or not) at the end of frame reception coincidentally with the setting of the RXDFR event status flag. When RXFCG is set to 1 it indicates that the CRC check result generated on the received data matches with the 2-octet FCS sequence at the end of the frame. RXDFR with RXFCG then indicates the correct reception a valid frame. The RXFCG bit is in the <u>RX double-buffered swinging-set</u> . It is automatically cleared by RX enable. It can also be cleared explicitly by writing a 1 to it.
RXFCE reg:0F:00 bit:15	Receiver FCS Error. This event status bit also reflects the result of the frame CRC checking. It is valid at the end of frame reception coincidentally with the setting of the RXDFR event status flag. When RXFCE is set to 1 it indicates that the CRC check result generated on the received data FAILED to match with the 2-octet FCS sequence at the end of the frame. The RXFCE bit is included in the <u>RX double-buffered swinging-set</u> . It is automatically cleared by RX enable. It can also be cleared explicitly by writing a 1 to it. RXFCE events are also counted in Sub-Register 0x2F:0A – FCS Error Counter , as long as counting is enabled by the EVC_EN bit in Sub-Register 0x2F:00 – Event Counter Control .
RXRFSL reg:0F:00 bit:16	Receiver Reed Solomon Frame Sync Loss. The RXRFSL event status bit is set to indicate that the receiver has found anon-correctable error during the Reed Solomon decoding of the data portion of the frame. Generally this means that correct frame reception is not possible, and so typically this event will abort frame reception (depending on the DIS_RSDE configuration in Register file: 0x04 – System Configuration) after which the receiver may return to preamble search (depending on the RXAUTR configuration also in Register file: 0x04 – System Configuration). Section 4– Message Reception gives details of the frame reception process. The RXRFSL bit can be cleared explicitly by writing a 1 to it. It is also automatically cleared by the next receiver enable, including those caused by the RXAUTR auto-re-enable. Reed Solomon Frame Sync Loss Error events are also counted in Sub-Register 0x2F:06 – RSD Error Counter , as long as counting is enabled by the EVC_EN bit in Sub-Register 0x2F:00 – Event Counter Control .
RXRFTO reg:0F:00 bit:17	Receive Frame Wait Timeout. This event status bit is set to indicate that a receive frame wait timeout has occurred. The receive frame wait timeout is enabled by the RXWTOE bit in Register file: 0x04 – System Configuration , with the timeout being set by Register file: 0x0C – Receive Frame Wait Timeout Period . The receive frame wait timeout starts running when the receiver is enabled and stops running either when a valid frame is received or when the timeout occurs and is signalled by this RXRFTO event status flag bit. The RXRFTO bit is automatically cleared at the next receiver enable. It can also be cleared explicitly by writing a 1 to it. Receive frame wait timeout events are also counted in Sub-Register 0x2F:14 – RX Frame Wait Timeout Event Counter , as long as counting is enabled by the EVC_EN bit in Sub-Register 0x2F:00 – Event Counter Control .
LDEERR reg:0F:00 bit:18	Leading edge detection processing error. A large part of the leading edge detection algorithm is a search in the channel impulse response to find the first arriving ray of the RMARKER. This should be bounded and finish in reasonably short time, but in case not the LDE includes a failsafe mechanism of a watchdog timer (60 μs) that is initialized at the start of each LDE search (when a good PHR has been detected). We do not expect DW1000 users to ever see this event, however if the watchdog timer expires before the LDE has completed its RX timestamp adjustments then the LDE search will be aborted and the error will be reported by the LDEERR event status flag. The LDEERR bit is automatically cleared at the next receiver enable. It can also be cleared explicitly by writing a 1 to it.
– reg:0F:00 bit:19	This bit is reserved.

Field	Description of fields within Register file: 0x0F – System Event Status Register
RXOVRR reg:0F:00 bit:20	Receiver Overrun. This event status bit only applies when double RX buffering is enabled (by clearing the DIS_DRXB bit in Register file: 0x04 – System Configuration). The RXOVRR event flag is set to indicate that an overrun error has occurred in the receiver. See section 4.3.5 – Overrun for more details of double buffering and the use of this RXOVRR error flag. The RXOVRR event status bit is a READ ONLY bit. It will clear when HRBPT is used to signal the completion of processing for a receiver buffer, freeing that buffer for data reception. Receiver Overrun events are also counted in Sub-Register 0x2F:0E – RX Overrun Error Counter , assuming that counting is enabled by the EVC_EN bit in Sub-Register 0x2F:00 – Event Counter Control .
RXPTO reg:0F:00 bit:21	Preamble detection timeout. This event status bit is set when the preamble detection timeout occurs. The preamble detection timer is started when the receiver is enabled and begins preamble hunt. This may be immediately in the case of issuing an RXENAB command or after a delay in the case of issuing a RXDLYE command. The preamble detection timeout value is programmed in Sub-Register 0x27:24 – DRX_PRETOC . The preamble detection timeout may be useful to save power by turning off the receiver if an expected response frame does not begin. If a response message is expected with a certain fixed timing and preamble is not detected at the appropriate time then this is likely to mean that the response will not come. Reception can thus be aborted early, saving power. The RXPTO bit is automatically cleared at the next receiver enable. It can also be cleared explicitly by writing a 1 to it.
GPIOIRQ reg:0F:00 bit:22	GPIO interrupt. The GPIOIRQ event status bit is set when an interrupt condition occurs in the GPIO block. Various configurations are possible to enable interrupts coming from GPIO input lines. The GPIO block may need to be interrogated to determine the source of the interrupt if more than one input line is configured to interrupt. The GPIOIRQ bit is cleared by writing a 1 to it. For details of GPIO programming see Register file: 0x26 – GPIO control and status .
SLP2INIT reg:0F:00 bit:23	SLEEP to INIT . This event status bit is set to indicate that the DW1000 has completed the activities associated with awaking from SLEEP (or DEEPSLEEP) and is now in the INIT state.
RFPLL_LL reg:0F:00 bit:24	RF PLL Losing Lock. This event status bit is set to indicate that the RFPLL is having locking issues. This should not happen in healthy devices operating in their normally range. Its occurrence may indicate a bad configuration, a faulty part or a problem in the power or clock inputs to the device. If this bit is set it may be advisable to turn off the transmitter to avoid sending signals that are out of regulation. The RFPLL_LL bit is cleared by writing a 1 to it.
CLKPLL_LL reg:0F:00 bit:25	Clock PLL Losing Lock. This event status bit is set to indicate that the system’s digital clock PLL is having locking issues. This should not happen in healthy devices operating in their normally range. Its occurrence may indicate a bad configuration, a faulty part or a problem in the power or clock inputs to the device. If this bit is set it may be advisable to turn off the transmitter to avoid sending spurious signals. The CLKPLL_LL bit is cleared by writing a 1 to it.

Field	Description of fields within Register file: 0x0F – System Event Status Register
<p>RXSFDTO</p> <p>reg:0F:00 bit:26</p>	<p>Receive SFD timeout. This event status bit is set when the SFD detection timeout occurs. The SFD detection timeout starts running as soon as preamble is detected. If the SFD sequence is not detected before the timeout period expires then the timeout will act to abort the reception currently in progress. The period of the SFD detection timeout is in Sub-Register 0x27:20 – DRX_SFDTOC. By default this has a value of 4096+64 representing the longest possible preamble and SFD. Where it is known that a shorter preamble and SFD are being employed this value can be reduced. The RXSFDTO event status bit can be cleared explicitly by writing a 1 to it. It is also automatically cleared by the next receiver enable, including those caused by the RXAUTR auto-re-enable. SFD timeout events are also counted in Sub-Register 0x2F:10 – SFD Timeout Error Counter, assuming that counting is enabled by the EVC_EN bit in Sub-Register 0x2F:00 – Event Counter Control.</p>
<p>HPDWARN</p> <p>reg:0F:00 bit:27</p>	<p>Half Period Delay Warning. This event status bit relates to the use of delayed transmit and delayed receive functionality. It indicates the delay is more than half a period of the system clock.</p> <p>For delayed send/receive the send/receive time is programmed into Register file: 0x0A – Delayed Send or Receive Time and then the delayed sending/receiving is initiated by the TXDLYS/RXDLYE controls in Register file: 0x0D – System Control Register. The delayed transmit and receive functionality is described in detail in sections 3.3 – Delayed Transmission and 4.2 – Delayed Receive.</p> <p>The HPDWARN event status flag gets set if the time left to actually beginning transmission / reception is more than half a period of the system clock (Register file: 0x06 – System Time Counter) away. Assuming that the intent was not to schedule transmission/reception at a time that is over 8 seconds in the future, the HPDWARN status flag can be polled after the TXDLYS/RXDLYE is commanded, to check whether the delayed send/ receive invocation was given in time (HPDWARN ==0) or not (HPDWARN == 1).</p> <p>Typically when the HPDWARN event is detected the host controller will abort the delayed TX/RX by issuing a TRXOFF transceiver off command and then take whatever remedial action is deemed appropriate for the application.</p> <p>The HPDWARN event status flag is READ ONLY. It will clear when the delayed TX/RX is cancelled or when the delay remaining is no longer greater than half a period of the system clock.</p> <p>HPDWARN events are counted in Sub-Register 0x2F:18 – Half Period Warning Counter, assuming counting is enabled by the EVC_EN bit in Sub-Register 0x2F:00 – Event Counter Control.</p>

Field	Description of fields within Register file: 0x0F – System Event Status Register
TXBERR reg:0F:00 bit:28	Transmit Buffer Error. The TXBERR event status flag bit indicates that a write to a transmitted data buffer location has occurred whilst CRC was suppressed. Section 3.5 – High Speed Transmission describes the DW1000 features for maximising data throughput. One technique involves writing the frame data to the TX buffer after initiating the transmission of that frame. During this data writing then, CRC sending is temporarily suppressed to protect against sending the wrong data as a good frame (with good CRC). This CRC suppression is cancelled when all the frame data has been written. If the frame data has been written to the buffer in good time then the frame will be sent and a good CRC will be appended. If the data is written late, (i.e. the host writes to the buffer area that is part of the TX frame after the DW1000 has already consumed data from that area), then this is detected and flagged here in this TXBERR event status flag bit. In this case CRC suppression cannot be cancelled (so no CRC is appended). This will prevent transmission of a “bad” data frame with a good CRC. The TXBERR bit is cleared by writing a 1 to it.
AFFREJ reg:0F:00 bit:29	Automatic Frame Filtering rejection. The AFFREJ event status flag bit is set to indicate when a frame has been rejected in receiver due to it not passing through the frame filtering. See section 5.2 – Frame filtering for details of the operation of frame filtering. The AFFREJ event status bit can be cleared explicitly by writing a 1 to it. It is also automatically cleared by the next receiver enable, including those caused by the RXAUTR auto-re-enable. Frame Filtering rejection events are also counted in Sub-Register 0x2F:0C – Frame Filter Rejection Counter , assuming counting is enabled by the EVC_EN bit in Sub-Register 0x2F:00 – Event Counter Control .
HSRBP reg:0F:00 bit:30	Host Side Receive Buffer Pointer. This is status flag relating to the operation of the receiver in double-buffered mode. Section 4.3 – Double Receive Buffer describes this operation in detail. Essentially HSRBP is an index indicating which of the buffer pairs the host side is accessing (reading from currently or awaiting to read from when filled by the IC), while ICRBP is an index indicating which of the buffer pairs the IC is accessing (writing to currently or will write to as soon as a frame data arrives). The HSRBP bit is a READ ONLY status bit, its state is changed by issuing the HRBPT command in Register file: 0x0D – System Control Register .
ICRBP reg:0F:00 bit:31	IC side Receive Buffer Pointer. This is status flag relating to the operation of the receiver in double-buffered mode. Section 4.3 – Double Receive Buffer describes this operation in detail. Essentially ICRBP is an index indicating which of the buffer pairs the IC is accessing (writing to currently or will write to as soon as a frame data arrives). The ICRBP bit is a READ ONLY status bit.
RXRSCS reg:0F:04 bit:0	Receiver Reed-Solomon Correction Status. This status bit indicates that the Reed-Solomon has corrected at least one error in the frame being received. This is a low-level event status flag. The RXRSCS bit probably not of interest to the host system. It was used during the verification of the Reed-Solomon implementation. The RXRSCS bit cannot be used as an interrupt source. The RXRSCS status bit can be cleared explicitly by writing a 1 to it. It is also automatically cleared by the next receiver enable, including those caused by the RXAUTR auto-re-enable.
RXPRES reg:0F:04 bit:1	Receiver Preamble Rejection. This is a low-level event status flag, which is probably not of interest to the host system. It was used during the IC implementation as part of tuning the preamble detection algorithm. In the DW1000, preamble detection a two stage process where preamble is initially seen and then has to be confirmed as continuing for a number of symbols before the RXSFDD event status bit actually gets set. If the preamble is not confirmed then the RXSFDD event status bit will not be set, but instead this RXPRES status will be set. The RXPRES bit cannot be used as an interrupt source. The RXPRES event status bit can be cleared explicitly by writing a 1 to it. It is also automatically cleared by the next receiver enable, including those caused by the RXAUTR auto-re-enable.

Field	Description of fields within Register file: 0x0F – System Event Status Register
TXPUTE reg:0F:04 bit:2	<p>Transmit power up time error. This is a low-level event status flag. It applies when delayed transmission is being used. Frame transmission will continue if this condition is detected, and the RMARKER will be sent at the correct time, but that the initial few preamble symbols may not transmit correctly. This may have a performance effect when a short preamble sequence is being employed. The TXPUTE event status flag is READ ONLY. It will clear as soon as the DW1000 begins to send preamble, (or if the DW1000 is returned to idle). Since the TX power-up time is only a few symbol times in duration and because the TXPUTE bit clears at the start of preamble, it is unlikely that the host system will see the TXPUTE bit set. The condition therefore should be detected using the event counted in Sub-Register 0x2F:1A – Transmitter Power-Up Warning Counter, (when counting is enabled by the EVC_EN bit in Sub-Register 0x2F:00 – Event Counter Control).</p> <p>The delayed transmit and receive functionality is described in detail in sections 3.3 – Delayed Transmission and 4.2 – Delayed Receive.</p>
- reg:0F:04 bits:7-3	These bits are reserved

7.2.18 Register file: 0x10 – RX Frame Information Register

ID	Length (octets)	Type	Mnemonic	Description
0x10	4	ROD	RX_FINFO	RX Frame Information - included in swinging set

[Register map](#) register file 0x10 gives information on the received frame. It is updated after the reception of a good PHR, i.e. PHR where the SECDDED has not flagged anon-correctable error (see section 10.4).

Register file: 0x10 – RX Frame Information Register is in the RX double-buffered swinging-set. See section 4.3 – Double Receive Buffer for more details.

Note: During double buffered operation, a receiver overrun condition results in the corruption of this RX_FINFO register 0x10, please refer to section 4.3.3 Operation of double buffering for details of the correct handling of this condition.

This RX_FINFO register contains a number of fields, separately identified and described below:

REG:10:00 – RX_FINFO – RX Frame Information																															
31	30	29	28	27	26	25	24	23	22	21	20	19	18	17	16	15	14	13	12	11	10	9	8	7	6	5	4	3	2	1	0
RXPACC												RXPSR	RXPRF	RNG	RXBR	RXNSPL	-	RXFLE	RXFLEN												
0												0	0	0	0	0	0	0	0												

The individual sub-fields are described below:

Field	Description of fields within Register file: 0x10 – RX Frame Information Register																																																		
RXFLEN reg:10:00 bits:6–0	Receive Frame Length. This value is copied from the PHR of the received frame when a good PHR is detected (when the RXPHD status bit is set). The frame length from the PHR is used in the receiver to know how much data to receive and decode, and where to find the FCS (CRC) to validate the received data. The frame length also tells the host system how much data to read from the RX_BUFFER. This field is 7-bits wide to accommodate the standard IEEE 802.15.4 UWB frames which can be up to 127 bytes long. The DW1000 also supports a non-standard mode of operation with data frame lengths up to 1023 octets, where the frame length reported is extended by the RXFLE field.																																																		
RXFLE reg:10:00 bits:9–7	Receive Frame Length Extension. The DW1000 supports a non-standard mode of operation with data frame lengths up to 1023 bytes. This mode of operation is enabled via the PHR_MODE selection bits of Register file: 0x04 – System Configuration . In this long frame mode RXFLE adds three high-order bits to RXFLEN extending it to 10-bits, and allowing frame lengths from 0 up to 1023 bytes be reported. See also section 3.4 – Extended Length Data Frames . This value is updated when a good PHR is detected (when the RXPHD status bit is set).																																																		
- reg:10:00 bit:10	This bit is reserved.																																																		
RXNSPL reg:10:00 bits:12,11	<p>Receive non-standard preamble length. The DW1000 is able to send non-standard preamble lengths to allow system designers more choice in optimising performance. The RXNSPL field operate in conjunction with the RXPSR field to report the received preamble length. The RXPSR field reports the preamble length as signalled in the PHR (see 10.4 for details). The receiver determines additional information about the transmitted preamble length from the count of preamble accumulation, as reported by the RXPACC field, and uses this to set the RXNSPL value.</p> <p>Table 16 below lists the preamble lengths that can be reported by considering RXNSPL and the RXPSR fields together:</p> <p style="text-align: center;">Table 16: preamble length reporting</p> <table border="1" style="margin-left: auto; margin-right: auto;"> <thead> <tr> <th>Bit 19</th> <th>Bit 18</th> <th>Bit 12</th> <th>Bit 11</th> <th></th> </tr> <tr> <th colspan="2">RXPSR</th> <th colspan="2">RXNSPL</th> <th>RX Preamble Length</th> </tr> </thead> <tbody> <tr> <td>0</td> <td>1</td> <td>0</td> <td>0</td> <td>64</td> </tr> <tr> <td>0</td> <td>1</td> <td>0</td> <td>1</td> <td>128</td> </tr> <tr> <td>0</td> <td>1</td> <td>1</td> <td>0</td> <td>256</td> </tr> <tr> <td>0</td> <td>1</td> <td>1</td> <td>1</td> <td>512</td> </tr> <tr> <td>1</td> <td>0</td> <td>0</td> <td>0</td> <td>1024</td> </tr> <tr> <td>1</td> <td>0</td> <td>0</td> <td>1</td> <td>1536</td> </tr> <tr> <td>1</td> <td>0</td> <td>1</td> <td>0</td> <td>2048</td> </tr> <tr> <td>1</td> <td>1</td> <td>0</td> <td>0</td> <td>4096</td> </tr> </tbody> </table> <p style="text-align: center;">The bit numbers quoted above are the bit numbers in the RX_FINFO register.</p> <p>Where preamble length is not predetermined and hard coded in the application, the received preamble length information may be used to select the preamble length for any response message, by copying RXNSPL and RXPSR fields into the PE and TXPSR configurations respectively.</p> <p>This value is updated when a good PHR is detected (when the RXPHD status bit is set).</p>	Bit 19	Bit 18	Bit 12	Bit 11		RXPSR		RXNSPL		RX Preamble Length	0	1	0	0	64	0	1	0	1	128	0	1	1	0	256	0	1	1	1	512	1	0	0	0	1024	1	0	0	1	1536	1	0	1	0	2048	1	1	0	0	4096
Bit 19	Bit 18	Bit 12	Bit 11																																																
RXPSR		RXNSPL		RX Preamble Length																																															
0	1	0	0	64																																															
0	1	0	1	128																																															
0	1	1	0	256																																															
0	1	1	1	512																																															
1	0	0	0	1024																																															
1	0	0	1	1536																																															
1	0	1	0	2048																																															
1	1	0	0	4096																																															

Field	Description of fields within Register file: 0x10 – RX Frame Information Register
RXBR reg:10:00 bits:14,13	Receive Bit Rate report. This field reports the received bit rate. This information is signalled in the received frame’s PHR (see 10.4 for details). Expected values supported by the DW1000 are: 00 = 110 kbps, 01 =850 kbps, and 10 = 6.8Mbps This value is updated when a good PHR is detected (when the RXPHD status bit is set).
RNG reg:10:00 bit:10	Receiver Ranging. This reflects the ranging bit in the received PHY header identifying the frame as a ranging packet. This value is updated when a good PHR is detected (when the RXPHD status bit is set).
RXPRFR reg:10:00 bits:17,16	RX Pulse Repetition Rate report. This field reports the PRF being employed in the receiver. This is simply a copy of the RXPRF configuration from Register file: 0x1F – Channel Control . The values are:01 = 16 MHz, 10 = 64 MHz
RXPSR reg:10:00 bits:19,18	RX Preamble Repetition. This field reports the received frame preamble length as signalled in the frame’s PHR (see 10.4 for details). The values of these two bits are defined by the standard as: 00= 16 symbols, 01 = 64 symbols, 10= 1024 symbols, and, 11= 4096 symbols In addition to these standard preamble lengths, the DW1000 also supports the transmission of non-standard preamble lengths. These non-standard lengths cannot be signalled in the PHR; instead the DW1000 gives an estimate of the preamble length based on the RXPSR from the PHR and the RXPACC value. The estimate is reported using RXPSR and RXNSPL fields together as per Table 16above. This value is updated when a good PHR is detected (when the RXPHD status bit is set).
RXPACC reg:10:00 bits:31–20	Preamble Accumulation Count. This reports the number of symbols of preamble accumulated. This may be used to estimate the length of TX preamble received and also during diagnostics as an aid to interpreting the accumulator data. It is possible for this count to be a little larger than the transmitted preamble length, because of very early detection of preamble and because the accumulation count may include accumulation that continues through the SFD (until the SFD is detected). This value is updated when a good PHR is detected (when the RXPHD status bit is set).

7.2.19 Register file: 0x11 – RX Frame Buffer

ID	Length (octets)	Type	Mnemonic	Description
0x11	1024	RWD	RX_BUFFER	RX Frame Data Buffer - included in swinging set

[Register map](#) register file 0x11 is the receive data buffer. The data from the received frame is available in the received buffer. Assuming successful reception of a good frame, the full length of received data (as reported by the RXFLEN and RXFLE fields of [Register file: 0x10 – RX Frame Information Register](#)), will be available in the RX_BUFFER beginning at offset 0. Note since the reported length includes the FCS the host system will probably choose not to read these final two octets.

Register file: 0x11 – RX Frame Buffer is part of the RX double-buffered swinging-set. See section 4.3 – Double Receive Buffer for more details.

7.2.20 Register file: 0x12 – Rx Frame Quality Information

ID	Length (octets)	Type	Mnemonic	Description
0x12	8	ROD	RX_FQUAL	Rx Frame Quality information - included in swinging set

[Register map](#) register file 0x12 gives information about quality of reception for the current frame. This register consists of a number of sub-fields separately identified and described below:

Register file: 0x12 – Rx Frame Quality Information is in the RX double-buffered swinging-set. See section 4.3 – Double Receive Buffer for more details.

The RX_FQUAL register contains the following sub-fields:

REG:12:00 – RX_FQUAL – Rx Frame Quality Information (Octets 0 to 3, 2x16-bit values)																																
31	30	29	28	27	26	25	24	23	22	21	20	19	18	17	16	15	14	13	12	11	10	9	8	7	6	5	4	3	2	1	0	
FP_AMPL2																STD_NOISE																
0	0	0	0	0	0	0	0	0	0	0	0	0	0	0	0	0	0	0	0	0	0	0	0	0	0	0	0	0	0	0	0	0

REG:12:04 – RX_FQUAL – Rx Frame Quality Information (Octets 4 to 7, 2x16-bit values)																																
31	30	29	28	27	26	25	24	23	22	21	20	19	18	17	16	15	14	13	12	11	10	9	8	7	6	5	4	3	2	1	0	
CIR_PWR																PP_AMPL3																
0	0	0	0	0	0	0	0	0	0	0	0	0	0	0	0	0	0	0	0	0	0	0	0	0	0	0	0	0	0	0	0	0

The sub-fields of [Register file: 0x12 – Rx Frame Quality Information](#) are described below and are updated when the LDE execution has completed successfully is detected (when the LDEDONE status bit is set):

Field	Description of fields within Register file: 0x12 – Rx Frame Quality Information
STD_NOISE reg:12:00 bits:15–0	Standard Deviation of Noise. This is a 16-bit value reporting the standard deviation of the noise level seen during the LDE algorithm’s analysis of the accumulator data. This value can be used in assessing the quality of the received signal and/or the receive timestamp produced by the LDE. For more details please refer to section 4.7 – Assessing the quality of reception and the RX timestamp .
FP_AMPL2 reg:12:00 bits:31–16	First Path Amplitude point 2. This is a 16-bit value that is part of reporting the magnitude of the leading edge signal seen in the accumulator data memory during the LDE algorithm’s analysis. The amplitude of the sample reported in the FP_AMPL2 parameter is the magnitude of the accumulator tap at the index 2 beyond the integer portion of the rising edge FP_INDEX reported in Register file: 0x15 – Receive Time Stamp . The FP_AMPL2 amplitude value can be used, in conjunction with the FP_AMPL3 value below and the FP_AMPL1 value reported in Register file: 0x15 – Receive Time Stamp , as part of assessing the quality of the receive timestamp produced by the LDE algorithm. For more details please refer to section 4.7 – Assessing the quality of reception and the RX timestamp .

Field	Description of fields within <i>Register file: 0x12 – Rx Frame Quality Information</i>
FP_AMPL3 reg:12:04 bits:15–0	<p>First Path Amplitude point 3. This is a 16-bit value that is part of reporting the magnitude of the leading edge signal seen in the accumulator data memory during the LDE algorithm’s analysis. The amplitude of the sample reported in the FP_AMPL3 parameter is the magnitude of the accumulator tap at the index 3 beyond the integer portion of the rising edge FP_INDEX reported in <i>Register file: 0x15 – Receive Time Stamp</i>. This amplitude value can be used in assessing the quality of the received signal and/or the receive timestamp produced by the LDE. For more details please refer to section <i>4.7 – Assessing the quality of reception and the RX timestamp</i>.</p> <p>The FP_AMPL3 amplitude value can be used, in conjunction with the FP_AMPL2 value above and the FP_AMPL1 value reported in <i>Register file: 0x15 – Receive Time Stamp</i>, as part of assessing the quality of the receive timestamp produced by the LDE algorithm. For more details please refer to section <i>4.7 – Assessing the quality of reception and the RX timestamp</i>.</p>
CIR_PWR reg:12:04 bits:31–16	<p>Channel Impulse Response Power. This is a 16-bit value reporting the sum of the squares of the magnitudes of the accumulator from the estimated highest power portion of the channel, which is related to the receive signal power. This value can be used in assessing the quality of the received signal and/or the receive timestamp produced by the LDE algorithm. For more details please refer to section <i>4.7 – Assessing the quality of reception and the RX timestamp</i>.</p>

7.2.21 Register file: 0x13 – Receiver Time Tracking Interval

ID	Length (octets)	Type	Mnemonic	Description
0x13	4	ROD	RX_TTCKI	Receiver Time Tracking Interval- included in swinging set

Register map register file 0x13 operates with *Register file: 0x14 – Receiver Time Tracking Offset* to give a measure of the clock offset (or crystal offset) between the local receiver and the remote end transmitter device.

Register file: 0x13 – Receiver Time Tracking Interval is in the RX double-buffered swinging-set. See section 4.3 – Double Receive Buffer for more details.

The RX_TTCKI register contains the following sub-fields which are updated when a frame demodulation is completed successfully:

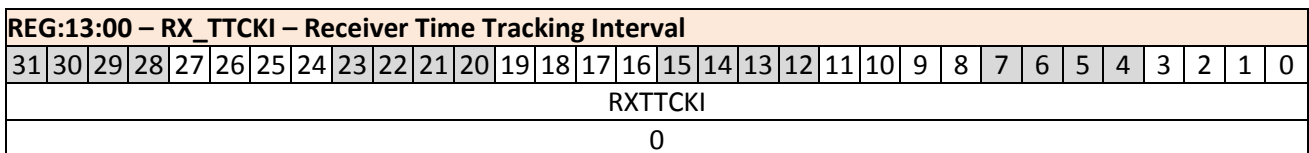

Field	Description of fields within Register file: 0x13 – Receiver Time Tracking Interval
RXTTCKI reg:13:00 bits:31–0	<p>RX time tracking interval. The value here is the interval over which the timing offset reported in the RXTOFS field of <i>Register file: 0x14 – Receiver Time Tracking Offset</i> is measured. The clock offset is calculated by dividing RXTTCKI by RXTOFS. The value in RXTTCKI will take just one of two values depending on the PRF: 0x01F00000 @ 16 MHz PRF, and 0x01FC0000 @ 64 MHz PRF.</p>

7.2.22 Register file: 0x14 – Receiver Time Tracking Offset

ID	Length (octets)	Type	Mnemonic	Description
0x14	5	ROD	RX_TTCKO	Receiver Time Tracking Offset- included in swinging set

Register map register file: 0x14 operates with [Register file: 0x13 – Receiver Time Tracking Interval](#) to give a measure of the clock offset (or crystal offset) between the local receiver and the remote end transmitter device.

Register file: 0x14 – Receiver Time Tracking Offset is in the RX double-buffered swinging-set. See section 4.3 – Double Receive Buffer for more details.

The RX_TTCKO register contains the following sub-fields which are updated when a frame demodulation is completed successfully:

REG:14:00 – RX_TTCKO – Receiver Time Tracking Offset (Octets 0 to 3, 32-bits)																																				
31	30	29	28	27	26	25	24	23	22	21	20	19	18	17	16	15	14	13	12	11	10	9	8	7	6	5	4	3	2	1	0					
RSMPDEL								-	-	-	-	-	RXTOFS																							
0								-	-	-	-	-	0																							

REG:14:04 – RX_TTCKO – Receiver Time Tracking Offset (Octet 4, 8-bits)							
7	6	5	4	3	2	1	0
-	RCPHASE						
-	0						

The individual sub-fields are described below:

Field	Description of fields within Register file: 0x14 – Receiver Time Tracking Offset
RXTOFS reg:14:00 bits:18–0	<p>RX time tracking offset. The value here is the offset measured over the interval reported in the RXTTCKI field of Register file: 0x13 – Receiver Time Tracking Interval. This RXTOFS value is a 19-bit signed quantity. The clock offset is calculated by dividing RXTTCKI by RXTOFS.</p> <p>Example (a): Say RXTOFS is reported as 0x000e4, and RXTTCKI is 0x01f00000 then this gives a clock offset of $228 \div 32505856$, which is 7.014E-06 or 7 ppm offset. So, the remote transmitter’s clock is running faster than the local receiver’s clock by this 7 ppm amount.</p> <p>Example (b): Say RXTOFS is reported as 0x7FF5C, and RXTTCKI is 0x01f00000 then this gives a clock offset of $-164 \div 32505856$, which is -5.045E-06 or -5 ppm offset. So, the remote transmitter’s clock is running slower than the local receiver’s clock by this 5 ppm amount.</p>
-	Bits marked ‘-’ are reserved and should always be written as zero.
RSMPDEL reg:14:00 bits:31–24	This 8-bit field reports an internal re-sampler delay value. This is not expected to be of any direct use to the host system. It was of interest in the past during the development of the IC receiver and the leading edge determination algorithm.
RCPHASE reg:14:04 bits:6–0	This 7-bit field reports the receive carrier phase adjustment at time the ranging timestamp is made. This may be of use as a diagnostic for certain applications.

7.2.23 Register file: 0x15 – Receive Time Stamp

ID	Length (octets)	Type	Mnemonic	Description
0x15	14	ROD	RX_TIME	Receive Time Stamp- included in swinging set

Register map register file 0x15 reports the receive time stamp and related information. During frame reception the SFD detection event marking the end of the preamble and the start of the PHR is the nominal point which is time-stamped by the IC. The IEEE 802.15.4 UWB standard calls this point the RMARKER. DW1000 takes a coarse timestamp of the symbol in which the RMARKER event occurs and to this adds various correction factors to give a resultant time stamp value. Please refer to section 4.1.6 – RX Message timestamp for more details of the corrections applied.

Register file: 0x15 – Receive Time Stamp is in the RX double-buffered swinging-set. See section 4.3 – Double Receive Buffer for more details.

The RX_TIME register contains the following sub-fields:

REG:15:00 – RX_TIME – Receive Time Stamp (Octets 0 to 3, 32-bits)																																
31	30	29	28	27	26	25	24	23	22	21	20	19	18	17	16	15	14	13	12	11	10	9	8	7	6	5	4	3	2	1	0	
RX_STAMP(low 32 bits of 40-bit value)																																
0	0	0	0	0	0	0	0	0	0	0	0	0	0	0	0	0	0	0	0	0	0	0	0	0	0	0	0	0	0	0	0	0

REG:15:04 – RX_TIME – Receive Time Stamp (Octets 4 to 7, 32-bits)																																
31	30	29	28	27	26	25	24	23	22	21	20	19	18	17	16	15	14	13	12	11	10	9	8	7	6	5	4	3	2	1	0	
FP_AMPL1(low 8 bits of 16)								FP_INDEX																RX_STAMP(high 8 bits of 40)								
0	0	0	0	0	0	0	0	0	0	0	0	0	0	0	0	0	0	0	0	0	0	0	0	0	0	0	0	0	0	0	0	0

REG:15:08 – RX_TIME – Receive Time Stamp (Octets 8 to 11, 32-bits)																															
31	30	29	28	27	26	25	24	23	22	21	20	19	18	17	16	15	14	13	12	11	10	9	8	7	6	5	4	3	2	1	0
RX_RAWST(low 24 bits of 40-bit value)																								FP_AMPL1(high 8-bits of 16)							
0	0	0	0	0	0	0	0	0	0	0	0	0	0	0	0	0	0	0	0	0	0	0	0	0	0	0	0	0	0	0	0

REG:15:0C – RX_TIME – Receive Time Stamp (Octets 12 to 13, 16-bits)																																													
31	30	29	28	27	26	25	24	23	22	21	20	19	18	17	16	15	14	13	12	11	10	9	8	7	6	5	4	3	2	1	0														
																RX_RAWST(high 16 bits of 40-bit value)																													
																0	0	0	0	0	0	0	0	0	0	0	0	0	0	0	0	0	0	0	0	0	0	0	0	0	0	0	0	0	0

The sub fields of Register file: 0x15 – Receive Time Stamp are laid out above in a map that is 32 bits wide, however some parameters are larger than 32 bits. It is possible to read a variable number of bytes any byte index and it is also possible to read the whole register file in a single block SPI read. The individual sub-fields are described below:

Field	Description of fields within Register file: 0x15 – Receive Time Stamp
-------	---

Field	Description of fields within Register file: 0x15 – Receive Time Stamp
RX_STAMP reg:15:00 bits:39–0	This 40-bit (5-octet) field reports the fully adjusted time of reception. Please refer to section 4.1.6 – RX Message timestamp for more details of the adjustments applied. The units of the low order bit are approximately 15.65picoseconds. The actual unit may be calculated as $1/(128*499.2 \times 10^6)$ seconds. The value is available here when the leading edge determination and timestamp adjustments are completed (when the LDEDONE status bit is set).
FP_INDEX reg:15:05 bits:15–0	<p>First path index. This is a 16-bit value reporting the position within the accumulator that the LDE algorithm has determined to be the first path. This value is set during the LDE algorithm’s analysis of the accumulator data and is updated when the LDE execution has completed (when the LDEDONE status bit is set). This value may be of use during diagnostic graphing of the accumulator data, and may also be of use in assessing the quality of the received message and/or the receive timestamp produced by the LDE. For more details of that please refer to section 4.7 – Assessing the quality of reception and the RX timestamp.</p> <p>The first path (or leading edge) is a sub-nanosecond quantity. Each tap in the accumulator corresponds to a sample time, which is approximately 1 nanosecond (or 30 cm in terms of the radio signal’s flight time through air). To report the position of the leading edge more accurately than this 1 nanosecond step size, the index value consist of a whole part and a fraction part. The 10 most significant bits of FP_INDEX represent the integer portion of the number and the 6 least significant bits represent the fractional part.</p>
FP_AMPL1 reg:15:05 bits:31–16	<p>First Path Amplitude point 1. This is a 16-bit unsigned value that is part of reporting the magnitude of the leading edge signal seen in the accumulator data memory during the LDE algorithm’s analysis. The amplitude of the sample reported in the FP_AMPL1 parameter is the magnitude of the accumulator tap at the index 1 beyond the integer portion of the rising edge FP_INDEX reported in this register. The FP_AMPL1 amplitude value can be used, in conjunction with the FP_AMPL2 and FP_AMPL3 values reported in Register file: 0x12 – Rx Frame Quality Information, as part of assessing the quality of the receive timestamp produced by the LDE algorithm. For more details please refer to section 4.7 – Assessing the quality of reception and the RX timestamp.</p> <p>This value updated when the LDE execution has completed (when the LDEDONE status bit is set).</p>
RX_RAWST reg:15:09 bits:39–0	This 40-bit (5-octet) field reports the Raw Timestamp for the frame. This is the value of the system clock (125 MHz) captured at the time of the first chip of the first PHR symbol. The precision here is approximately 125 MHz, i.e. the 9 least significant bits are zero. When the PHR has been decoded successfully (when the RXPHD status bit is set), the timestamp will be available for reading. If a PHR error is detected, the timestamp will not be updated.

7.2.24 Register file: 0x16 – Reserved

ID	Length (octets)	Type	Mnemonic	Description
0x16	-	-	-	Reserved – this register file is reserved

[Register map](#) register file 0x16 is reserved for future use. Please take care not to write to this register as doing so may cause the DW1000 to malfunction.

7.2.25 Register file: 0x17 – Transmit Time Stamp

ID	Length (octets)	Type	Mnemonic	Description
0x17	10	RO	TX_TIME	Transmit Time Stamp

Register map register file 0x17 reports the transmit time stamp information. During frame transmission the start of the PHR is the nominal point which is time-stamped by the IC. The IEEE 802.15.4 UWB standard calls this point the RMARKER. The DW1000 takes a timestamp of the symbol in which the RMARKER event occurs and to this adds the antenna delay to give a resultant time stamp value, of when the RMARKER is launched from the antenna.

This TX_TIME register contains the following sub-fields:

REG:17:00 – TX_TIME – Transmit Time Stamp (Octets 0 to 3, 32-bits)																																
31	30	29	28	27	26	25	24	23	22	21	20	19	18	17	16	15	14	13	12	11	10	9	8	7	6	5	4	3	2	1	0	
TX_STAMP (low 32 bits of 40-bit value)																																
0	0	0	0	0	0	0	0	0	0	0	0	0	0	0	0	0	0	0	0	0	0	0	0	0	0	0	0	0	0	0	0	0

REG:17:04 – TX_TIME – Transmit Time Stamp (Octets 4 to 7, 32-bits)																															
31	30	29	28	27	26	25	24	23	22	21	20	19	18	17	16	15	14	13	12	11	10	9	8	7	6	5	4	3	2	1	0
TX_RAWST (low 24 bits of 40-bit value)																								TX_STAMP (high 8 bits of 40)							
0	0	0	0	0	0	0	0	0	0	0	0	0	0	0	0	0	0	0	0	0	0	0	0	0	0	0	0	0	0	0	0

REG:17:08 – TX_TIME – Transmit Time Stamp (Octets 8 to 9, 16-bits)																															
31	30	29	28	27	26	25	24	23	22	21	20	19	18	17	16	15	14	13	12	11	10	9	8	7	6	5	4	3	2	1	0
																TX_RAWST (high 16 bits of 40-bit value)															
																0	0	0	0	0	0	0	0	0	0	0	0	0	0	0	

The sub fields of *Register file: 0x17 – Transmit Time Stamp* are laid out above in a map that is 32 bits wide. It is possible to read a variable number of bytes any byte index. The individual sub-fields are described below:

Field	Description of fields within Register file: 0x17 – Transmit Time Stamp
TX_STAMP reg:17:00 bits:39–0	This 40-bit (5-octet) field reports the fully adjusted time of transmission. The unit of the least significant bit is approximately 15.65 picoseconds. The actual unit may be calculated as $1/(128 \cdot 499.2 \times 10^6)$ seconds. The value is available here when the PHR transmission has completed.
TX_RAWST reg:17:05 bits:39–0	This 40-bit (5-octet) field reports the Raw Timestamp for the frame. This is the value of the system clock (125 MHz) captured at the time of the first chip of the first PHR symbol. The precision here is approximately 125 MHz, i.e. the 9 least significant bits are zero.

7.2.26 Register file: 0x18 – Transmitter Antenna Delay

ID	Length (octets)	Type	Mnemonic	Description
0x18	2	RW	TX_ANTD	16-bit Delay from Transmit to Antenna

[Register map](#) register file 0x18, the Transmitter Antenna Delay, is used to account for the delay between the internal digital timestamp of the RMARKER (at the start of the PHR) and the time the RMARKER is at the antenna. The value programmed here is automatically added to the raw timestamp TX_RAWST to get the TX_STAMP reported in [Register file: 0x17 – Transmit Time Stamp](#). Refer to section [8.3 – IC Calibration – Antenna Delay](#) for details of calibration of antenna delay. The units here are the same as those used for system time and time stamps, i.e. 499.2 MHz × 128, so the least significant bit is about 15.65 picoseconds.

NB: This register is not preserved during SLEEP or DEEPSLEEP and so needs reprogramming after a wakeup event in order to obtain the correct adjustment of the TX_STAMP.

The TX_ANTD is corrupted during wake-up (assuming the ONW_LDC bit in [Sub-Register 0x2C:00 – AON_WCFG](#) is set to restore configurations) the high-octet of the receive antenna delay as configured in [Sub-Register 0x2E:1804 – LDE_RXANTD](#) overwrites the low-octet of TX_ANTD.

7.2.27 Register file: 0x19 – Reserved

ID	Length (octets)	Type	Mnemonic	Description
0x19	5	RO	SYS_STATE	System State information

[Register map](#) register file 0x19 is reserved.

7.2.28 Register file: 0x1A – Acknowledgement time and response time

ID	Length (octets)	Type	Mnemonic	Description
0x1A	4	RW	ACK_RESP_T	Acknowledgement Time and Response Time

[Register map](#) register file 0x1A is a configuration register used for specifying turn-around times for DW1000 to use when automatically switching between TX mode and RX modes. The ACK_RESP_T register contains the following bitmapped sub-fields:

REG:1A:00 – ACK_RESP – RX Frame Information																																			
31	30	29	28	27	26	25	24	23	22	21	20	19	18	17	16	15	14	13	12	11	10	9	8	7	6	5	4	3	2	1	0				
ACK_TIM								-	-	-	-	W4R_TIM																							
0								0	0	0	0	0																							

The individual sub-fields are described below:

Field	Description of fields within Register file: 0x1A – Acknowledgement time and response time								
W4R_TIM reg:1A:00 bits:19–0	Wait-for-Response turn-around Time. This 20-bit field is used to configure the turn-around time between TX complete and RX enable when the wait for response function is being used. This function is enabled by the WAIT4RESP control in Register file: 0x0D – System Control Register . The time specified by this W4R_TIM parameter is in units of approximately 1 μs, or 128 system clock cycles. This configuration may be used to save power by delaying the turn-on of the receiver, to align with the response time of the remote system, rather than turning on the receiver immediately after transmission completes. For more details see section 5.4 – Transmit and automatically wait for response .								
ACK_TIM reg:1A:00 bits:31–24	Auto-Acknowledgement turn-around Time. This 8-bit field is used to configure the turn-around time between the correct receipt of a data frame (or a MAC command frame) and the transmission by the DW1000 of the acknowledgement frame. The time here is specified in units of preamble symbols. (This resultant time is slightly different depending on whether the PRF is 16 or 64 MHz, see Table 56 for details the preamble symbol lengths). This timer only applies if auto-acknowledgement is in use and then only acts when the frame is correctly received, passing through the RX frame filtering rules, and when the ACK bit in the frame’s MAC header is set to request acknowledgement. Please refer to section 5.3 – Automatic Acknowledgement for details of the Automatic Acknowledgement function. To ensure that the receiver is ready for the first preamble symbol, and assuming that the remote DW1000 has a its W4R_TIM parameter set to 0, the recommended minimum ACK_TIM settings are as follows: <table border="1" style="margin: 10px auto;"> <thead> <tr> <th>Data Rate</th> <th>Recommend min. ACK_TIM</th> </tr> </thead> <tbody> <tr> <td>110 kbps</td> <td>0</td> </tr> <tr> <td>850 kbps</td> <td>2</td> </tr> <tr> <td>6.8 Mbps</td> <td>3</td> </tr> </tbody> </table> This is most important at the 6.8 Mbps data rate, where preamble sequences are generally short, and losing even a few preamble symbols could potentially compromise ACK reception. Where the W4R_TIM parameter is larger than zero, the ACK_TIM setting should be increased also to ensure that none of the frame is sent before the remote receiver is listening.	Data Rate	Recommend min. ACK_TIM	110 kbps	0	850 kbps	2	6.8 Mbps	3
Data Rate	Recommend min. ACK_TIM								
110 kbps	0								
850 kbps	2								
6.8 Mbps	3								
-	Bits marked ‘-’ are reserved and should always be written as zero.								

7.2.29 Register files: 0x1B and 0x1C – Reserved

ID	Length (octets)	Type	Mnemonic	Description
0x1B	-	-	-	Reserved – this register file is reserved
0x1C	-	-	-	Reserved – this register file is reserved

[Register map](#) register file 0x1B and 0x1C are reserved for future use. Please take care not to write to these registers as doing so may cause the DW1000 to malfunction.

7.2.30 Register file: 0x1D – SNIFF Mode

ID	Length (octets)	Type	Mnemonic	Description
0x1D	4	RW	RX_SNIFF	Sniff Mode Configuration

Register map register file 0x1D is used for configuration of SNIFF mode, which is a power saving technique that can be employed to reduce the power consumption of preamble detection. For normal preamble reception the receiver searches for preamble continually, while SNIFFin mode the receiver samples (“sniffs”) the air periodically on a timed basis returning to receiver idle mode in between.

The transmitting device needs to be sending a sufficiently long preamble to allow for the SNIFF mode to operate and leave sufficient preamble remaining thereafter to get a good reception and RX timestamp. The power saving is dependent on the configured on/off times for this sampling. See additionally section [2.4.2– Specific state sequences supported by the DW1000](#) and [4.5 – Low-Power SNIFF mode](#) for additional discussion. The configuration consists of the fields identified and described below:

REG:1D:00 – RX_SNIFF – SNIFFMode Configuration																															
31	30	29	28	27	26	25	24	23	22	21	20	19	18	17	16	15	14	13	12	11	10	9	8	7	6	5	4	3	2	1	0
-	-	-	-	-	-	-	-	-	-	-	-	-	-	-	-	SNIFF_OFFT						-	-	-	-	SNIFF_ONT					
-	-	-	-	-	-	-	-	-	-	-	-	-	-	-	-	0						0	0	0	0	0					

The individual sub-fields are described below:

Field	Description of fields within Register file: 0x1D – SNIFF Mode
-	Bits marked ‘-’ are reserved.
SNIFF_ONT reg:1D:00 bits:3–0	SNIFFMode ON time. This parameter is specified in units of PAC. For details of PAC and its role in Preamble Detection, please refer to section 4.1.1 – Preamble Detection . A value of zero will disable SNIFFMode. A non-zero value will enable Preamble Detection Mode and select how long the receiver is turned on during the preamble hunt. NB: This must be a minimum of 2 for the IC to correctly make a preamble detection decision. If preamble is detected during this time window the receiver will remain on and will continue to attempt reception of the frame. If no preamble is detected the receiver will be returned to idle mode for the time configured by the SNIFF_OFFT parameter before sampling the air again.
SNIFF_OFFT reg:1D:00 bits:15–8	SNIFF Mode OFF time specified in μ s. This parameter is specified in units of approximately 1 μ s, or 128 system clock cycles. A value of zero will disable SNIFFMode. A non-zero value will enable SNIFFMode and select how long the receiver is turned off for during the preamble hunt. Please refer to the SNIFF_ONT description above for more details of this feature.

As an example, with a 1024 preamble length, a roughly 50% duty cycle (on 50% and off 50%) can be configured with a PAC of 8 symbols, SNIFF_ONT set to 3 PAC intervals, and SNIFF_OFFT set to 24 microseconds. The performance cost of this in terms of range is < 1 dB.

7.2.31 Register file: 0x1E – Transmit Power Control

ID	Length (octets)	Type	Mnemonic	Description
0x1E	4	RW	TX_POWER	TX Power Control

[Register map](#) register file 0x1E is used for configuration and control of the transmitter output power.

Normally it is desired to transmit at (just under) the maximum power allowed by the regulations for the geographic area of deployment simply because the higher the power the further the signal will go, although in some circumstances it may be desired to reduce the power to limit the operating range or for other reasons.

To optimise performance it is necessary (because of variations in the RF circuitry both internal to the IC and in the external components) to verify the output power during module manufacture testing and store a calibration value to set the module's output power as high as possible within the limits of the regulations. (The DW1000 has an area of OTP memory reserved for this. Please refer to section 8–[DW1000 Calibration](#) and section [6.3 – Using the on-chip OTP memory](#) for more details).

The transmitter output power can be adjusted using this [Register file: 0x1E – Transmit Power Control](#). This contains four octets each of which specifies a separate transmit power setting. These separate settings are applied by the IC in one of two ways. These two alternatives are described in section [7.2.31.1 – Smart Transmit Power Control](#) and section [7.2.31.1 – Manual Transmit Power Control](#) below. The choice between these two alternatives is selected by the setting of the DIS_STXP bit in [Register file: 0x04 – System Configuration](#).

7.2.31.1 Smart Transmit Power Control

This functionality applies when the *Disable Smart TX Power Control* bit DIS_STXP in [Register file: 0x04 – System Configuration](#) is zero (not set).

The power output regulations typically specify limits as -41 dBm in each 1 MHz bandwidth, and generally measure this using a 1ms dwell time in each 1 MHz segment. When sending short frames at 6.8 Mbps it is possible for a single frame to be sent in a fraction of a millisecond. So long as the transmitter does not transmit again within that same millisecond, the power of that transmission can be increased whilst complying with the regulations. This power increase will increase the transmission range. To make use of this the DW1000 includes functionality called Smart Transmit Power Control which automatically boosts the TX power for a transmission when the frame is short.

Smart TX power control acts at the 6.8 Mbps data rate. When sending short data frames at this rate (and providing that the frame transmission rate is < 1 frame per millisecond) it is possible to increase the transmit power and still remain within regulatory power limits which are typically specified as average power per millisecond.

When DIS_STXP is 0, the transmitter automatically sets the transmitter power levels when sending a frame at the 6.8 Mbps data rate, depending the frame length specified in the TFLEN field of [Register file: 0x08 – Transmit Frame Control](#), and in the fields of the TX Power Control register are defined as follows:

REG:1E:00 – TX_POWER – Transmit Power Control (When DIS_STXP = 0)																															
31	30	29	28	27	26	25	24	23	22	21	20	19	18	17	16	15	14	13	12	11	10	9	8	7	6	5	4	3	2	1	0
BOOSTP125								BOOSTP250								BOOSTP500								BOOSTNORM							
0x0E								0x08								0x02								0x22							

The individual sub-fields are described below:

Field	Description of fields within in Register file: 0x1E – Transmit Power Control (when DIS_STXP is 0)
BOOSTNORM reg:1E:00 bits:7–0	This is the normal power setting used for frames that do not fall within the data rate and frame length criteria required for a boost. Section 7.2.31.3 – Units of TX Power Control details the programming of this value.
BOOSTP500 reg:1E:00 bits:15–8	This value sets the power applied during transmission at the 6.8 Mbps data rate frames that are less than 0.5 ms duration which is determined by the following criteria: -- Preamble Length of 64 symbols and Frame Length of <= 333 bytes. -- Preamble Length of 128 symbols and Frame Length of <= 281 bytes. -- Preamble Length of 256 symbols and Frame Length of <= 166 bytes. A 3 dB power boost can be configured here so long as the external system keeps the frame rate below 1 frame per millisecond to ensure the power boost is not breaking regulations. Section 7.2.31.3 – Units of TX Power Control details the programming of this value.
BOOSTP250 reg:1E:00 bits:23–16	This value sets the power applied during transmission at the 6.8 Mbps data rate frames that are less than 0.25 ms duration which is determined by the following criteria: -- Preamble Length of 64 symbols and Frame Length of <= 123 bytes. -- Preamble Length of 128 symbols and Frame Length of <= 67 bytes. A 6 dB power boost can be configured here so long as the external system keeps the frame rate below 1 frame per millisecond to ensure the power boost is not breaking regulations. Section 7.2.31.3 – Units of TX Power Control details the programming of this value.
BOOSTP125 reg:1E:00 bits:31–24	This value sets the power applied during transmission at the 6.8 Mbps data rate frames that are less than 0.125 ms duration which is determined by the following criteria: -- Preamble Length of 64 symbols, SFD Length <=16 symbols and Frame Length of <= 15 bytes. -- Preamble Length of 64 symbols, SFD Length <=12 symbols and Frame Length of <= 19 bytes. -- Preamble Length of 64 symbols, SFD Length of 8 symbols and Frame Length of <= 23 bytes. At 64 MHz PRF a 9 dB power boost can be configured here so long as the external system keeps the frame rate below 1 frame per millisecond to ensure the power boost is not breaking regulations. At 16 MHz PRF the power boost should be set to the same 6 dB value used for the BOOSTP250 configuration to avoid exceeding peak power regulations. Section 7.2.31.3 – Units of TX Power Control details the programming of this value.

7.2.31.2 Manual Transmit Power Control

This functionality applies when the *Disable Smart TX Power Control* bit DIS_STXP in [Register file: 0x04 – System Configuration](#) is set to 1. In this case it is possible to exercise power control over individual parts of the transmit frame. Please refer to section [10.1– Frame structure overview](#) for details of frame structure.

When DIS_STXP is 1, the fields of the TX Power Control register are defined as follows:

REG:1E:00 – TX_POWER – Transmit Power Control (When DIS_STXP = 1)																															
31	30	29	28	27	26	25	24	23	22	21	20	19	18	17	16	15	14	13	12	11	10	9	8	7	6	5	4	3	2	1	0
Not applicable								TXPOWSD								TXPOWPHR								Not applicable							
0x0E								0x08								0x02								0x22							

The individual sub-fields are described below:

Field	Description of fields within in Register file: 0x1E – Transmit Power Control (when DIS_STXP is 0)
TXPOWPHR reg:1E:00 bits:15–8	This power setting is applied during the transmission of the PHY header (PHR) portion of the frame. Section 7.2.31.3 – Units of TX Power Control details the programming of this. WARNING: The default value here may be appropriate for the smart power control mode of operation (as described in section 7.2.31.1 above) but is probably too high for the manual use case. In order to comply with regional spectrum regulations it should be reduced to the level appropriate for the external RF circuitry and compliance to the regulations.
TXPOWSD reg:1E:00 bits:23–16	This power setting is applied during the transmission of the synchronisation header (SHR) and data portions of the frame. The SHR consists of the preamble and SFD portions of the frame that precede the PHR, and the Data portion of the frame is the piece following the PHR. Section 7.2.31.3 – Units of TX Power Control details the programming of this value. WARNING: The default value here may be appropriate for the smart power control mode of operation (as described in section 7.2.31.1 above) but is probably too high for the manual use case. In order to comply with regional spectrum regulations it should be reduced to a level appropriate for the external RF circuitry and compliance to the regulations.

7.2.31.3 Units of TX Power Control

Each power control octet, in [Register file: 0x1E – Transmit Power Control](#), specifies the power as a combination of a coarse gain parameter and a fine gain parameter.

The gain control range is 33.5 dB consisting of 32 fine (mixer gain) control steps of 0.5 dB and 7 coarse (DA gain) steps of 3 dB, see Figure 25.

For optimum performance, (as noted in section 7.2.31), manufacturers have to calibrate the TX power of each unit to account for IC to IC variations and different IC to antenna losses. Usually the TX power is set to the maximum allowed by spectral emission regulations (-41.3 dBm/MHz) and such that no other out-of-band limits are exceeded.

Reference values for setting [Register file: 0x1E – Transmit Power Control](#) are given below in Table 17 and Table 18. These may be used as starting point for transmit power calibration. They are based on a typical IC and an assumed IC to antenna loss of 1.5 dB with a 0 dBi antenna. Generally to avoid out of band spectral emissions the mixer gain should be kept low however increasing the DA gain will increase current consumption. The Table 17 and Table 18 values are dependent on the selected channel (frequency) and on the configured PRF. These settings are designed to deliver a nominal power spectrum density of -41.3 dBm/MHz to the antenna, assuming a 1.5 dB loss (due to balun and RF traces) between the IC output and the antenna.

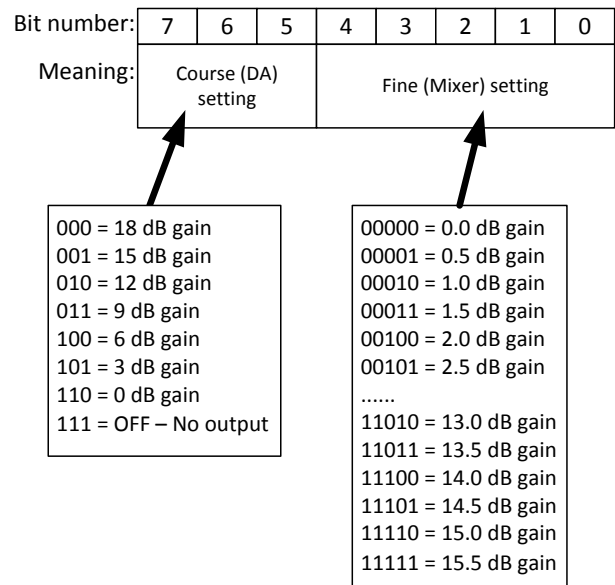

Figure 25: Transmit power control octet

The Table 17 values apply when smart TX power is being employed (i.e. the *Disable Smart TX Power Control* bit DIS_STXP in [Register file: 0x04 – System Configuration](#) is zero, not set), and, the Table 18 values apply when smart TX power is disabled (i.e. DIS_STXP=1).

Table 17: Reference values for Register file: 0x1E – Transmit Power Control, for Smart Transmit Power Control

TX Channel	Example Register file: 0x1E – Transmit Power Control values for 16 MHz, with DIS_STXP = 0	Example Register file: 0x1E – Transmit Power Control values for 64 MHz, with DIS_STXP = 0
1, 2	0x15355575	0x07274767
3	0x0F2F4F6F	0x2B4B6B8B
4	0x1F1F3F5F	0x3A5A7A9A
5	0x0E082848	0x25456585
7	0x32527292	0x5171B1D1

Table 18: Reference values Register file: 0x1E – Transmit Power Control for Manual Transmit Power Control (Smart Transmit Power Control disabled)

TX Channel	Example Register file: 0x1E – Transmit Power Control values for 16 MHz, with DIS_STXP = 1	Example Register file: 0x1E – Transmit Power Control values for 64 MHz, with DIS_STXP = 1
1, 2	0x75757575	0x67676767
3	0x6F6F6F6F	0x8B8B8B8B
4	0x5F5F5F5F	0x9A9A9A9A
5	0x48484848	0x85858585
7	0x92929292	0xD1D1D1D1

Note: High and low octets of the 32-bit values in Table 18 are not relevant when smart TX power is disabled.

7.2.32 Register file: 0x1F – Channel Control

ID	Length (octets)	Type	Mnemonic	Description
0x1F	4	SRW	CHAN_CTRL	Channel Control Register

Register map register file 0x1F is the channel control register. This is used to select transmit and receive channels, and configure preamble codes and some related parameters.

The fields of the Channel Control Register are defined as follows:

REG:1F:00 – CHAN_CTRL – Channel Control Register																																		
31	30	29	28	27	26	25	24	23	22	21	20	19	18	17	16	15	14	13	12	11	10	9	8	7	6	5	4	3	2	1	0			
RX_PCODE				TX_PCODE								RNSSFD	TNSSFD	RXPRF		DWSFD	-	-	-	-	-	-	-	-	RX_CHAN					TX_CHAN				
0	0	0	0	0	0	0	0	0	0	0	0	0	0	0	0	0	0	0	0	0	0	0	0	0	0	0	0	0	0	0	0			
																							5					5						

The individual sub-fields are described below:

Field	Description of fields within Register file: 0x1F – Channel Control
TX_CHAN reg:1F:00 bits:3–0	<p>This selects the transmit channel. Supported channels are 1, 2, 3, 4, 5, and 7. Other values should not be used. Both TX_CHAN and RX_CHAN (below) should be set to the same value. Full selection of TX channel requires that the following parameters are also set appropriately:</p> <ul style="list-style-type: none"> • Sub-Register 0x28:0C – RF_TXCTRL • Sub-Register 0x2A:0B – TC_PGDELAY • Sub-Register 0x2B:07 – FS_PLLCFG <p>For correct operation of the DW1000 and compliance to the IEEE 802.15.4 UWB standard, the preamble code should be set according to the operating channel. For details of centre frequencies and preamble codes for the supported channels, please refer to section 10.5 – <i>UWB channels and preamble codes</i>.</p>
RX_CHAN reg:1F:00 bits:7–4	<p>This selects the receive channel. Supported channels are 1, 2, 3, 4, 5, and 7. Other values should not be used. Both RX_CHAN and TX_CHAN (above) should be set to the same value. Full selection of RX channel requires that the following parameters are also set appropriately:</p> <ul style="list-style-type: none"> • Sub-Register 0x28:0B – RF_RXCTRLH • Sub-Register 0x2B:07 – FS_PLLCFG <p>For correct operation of the DW1000 and compliance to the IEEE 802.15.4 UWB standard, the preamble code should be set according to the operating channel. For details of centre frequencies and preamble codes for the supported channels, please refer to section 10.5 – <i>UWB channels and preamble codes</i>.</p>
- reg:1F:00 bits:16–8	Bits marked '-' in register 0x1F are reserved.

Field	Description of fields within Register file: 0x1F – Channel Control
DWSFD reg:1F:00 bit:17	<p>This bit enables a non-standard DecaWave proprietary SFD sequence. When DWSFD is 0, and TNSSFD and RNSSFD are deasserted low, then the SFD sequence used by the DW1000 will be the one prescribed by the IEEE 802.15.4-2011 standard.</p> <p>When DWSFD is set a special DecaWave defined SFD sequence will be employed in the transmitter and looked for in the receiver. For the 110 kbps this SFD is 64 symbols long (as normal), but for 850 kbps the SFD may be either 8 or 16 symbols long, this is selected by the SFD length field within Register file: 0x21 – User defined SFD sequence. Other length values are invalid and should not be used. (For 6.8 Mbps the standard 8-symbol SFD). For more details please refer to Register file: 0x21 – User defined SFD sequence, and see Table 19: Recommended SFD sequence configurations for best performance for details of the optimum selection of SFD sequence.</p>
RXPRF reg:1F:00 bits:19–18	<p>This two bit field selects the PRF used in the receiver. Values allowed here are binary 01 to select the 16 MHz PRF or binary 10 to select the 64 MHz PRF. Other values are reserved and should not be set.</p>
TNSSFD reg:1F:00 bit:20	<p>This bit enables the use of a user specified (non-standard) SFD in the transmitter. When TNSSFD is 0, and as long as DWSFD not set, then the transmitted SFD sequence will be that prescribed by the IEEE 802.15.4 standard. When TNSSFD is set the transmitted SFD sequence is defined by the programming of Register file: 0x21 – User defined SFD sequence. For correct operation the SFD sequence used in the receiver has to be programmed to match the transmitted SFD sequence. The RNSSFD bit enables the use of user programmed non-standard SFD sequence in the receiver. For more details please see Register file: 0x21 – User defined SFD sequence.</p>
RNSSFD reg:1F:00 bit:21	<p>This bit enables the use of a user specified (non-standard) SFD in the receiver. When RNSSFD is 0, and as long as DWSFD not set, then the SFD sequence searched for in the receiver will be that prescribed by the IEEE 802.15.4 standard. When RNSSFD is set the receiver SFD sequence is defined by the programming of Register file: 0x21 – User defined SFD sequence. For correct operation the SFD sequence used in the transmitter has to be programmed to match the SFD sequence being hunted for in the receiver. The TNSSFD bit enables the use of user programmed non-standard SFD sequence in the transmitter. For more details please refer to Register file: 0x21 – User defined SFD sequence.</p>
TX_PC <small>ODE</small> reg:1F:00 bits:26–22	<p>This field selects the preamble code used in the transmitter. The user should select the preamble code from those recommended for the selected channel and PRF setting. Section 10.5 – UWB channels and preamble codes details the preamble codes allowed in the supported channels.</p>
RX_PC <small>ODE</small> reg:1F:00 bits:31–27	<p>This field selects the preamble code used in the receiver. The user should select the preamble code from those recommended for the selected channel and PRF setting. Section 10.5 – UWB channels and preamble codes details the preamble codes allowed in the supported channels.</p>

7.2.33 Register file: 0x20 – Reserved

ID	Length (octets)	Type	Mnemonic	Description
0x20	-	-	-	Reserved – this register file is reserved

[Register map](#) register file 0x20 is reserved for future use. Please take care not to write to this register as doing so may cause the DW1000 to malfunction.

7.2.34 Register file: 0x21 – User defined SFD sequence

ID	Length (octets)	Type	Mnemonic	Description
0x21	41	RW	USR_SFD	User-specified short/long TX/RX SFD sequences

[Register map](#) register file 0x21 is the user defined SFD sequence. This allows the possibility for a non-standard SFD sequence to be programmed. The use of a non-standard SFD sequence is separately configurable for the transmitter and receiver by the TNSSFD and RNSSFD bits in the [Register file: 0x1F – Channel Control](#).

In addition, the SFD_LENGTH part of this register file is used to select between 8 and 16 length SFD when the special DecaWave defined (non-standard) SFD is being used. This is enabled by the DWSFD bit in the [Register file: 0x1F – Channel Control](#). NB: when this is being used, length values of 8 or 16 are valid, other values should not be used.

The length of an SFD sequence for 110 kbps is always 64 symbols, but the length of the SFD sequence for other data rates may be configured to a value between 8 and 16 using the SFD_LENGTH register at sub address 0x00.

The SFD pattern consists of the preamble symbols either not sent, or sent as normal or sent inverted (i.e. positive and negative pulses reversed) see section 10.3 for more details of the standard SFD.

To program an SFD we set two elements per SFD symbol: A magnitude defining presence or not of a physical transmission for that symbol time, and, a sign defining for symbols that are sent whether the symbol is sent in its normal positive sense or inverted into a negative symbol.

The individual sub-fields of [Register file: 0x21 – User defined SFD sequence](#) are described below, giving the index within the register file, and defining the parameter at that index:

NOTE: Designing SFD sequences is a complicated task, beyond the scope of this manual. Where improved performance is desired and standard compliance is not required it is recommend to use the DecaWave defined (non-standard) SFD enabled by setting the DWSFD bit. Only experts should consider designing and programming their own SFD sequences.

See [Table 19: Recommended SFD sequence configurations for best performance](#) for details of the optimum selections of SFD sequence.

Sub-Index	Field	Description of fields within Register file: 0x21 – User defined SFD sequence
0 reg:21:00	SFD_LENGTH	This is the length of the SFD sequence used when the data rate is 850 kbps and higher. Valid length configuration values must be between 8 and 16 symbols. $8 \leq \text{SFD_LENGTH} \leq 16$ When the DWSFD bit in (Register file: 0x1F – Channel Control) is one, SFD_LENGTH must be set to either 8 or 16. Other values should not be used.
1 reg:21:01	TX_SSFd_MAGL (Symbols 7..0)	This field sets the short SFD magnitude data for the transmitted SFD sequence, for the first 8 symbol intervals. The low order bits define the part of the SFD sequence sent first in time.

Sub-Index	Field	Description of fields within Register file: 0x21 – User defined SFD sequence
2 reg:21:02	TX_SSFD_MAGH (Symbols 15..8)	This field sets the short SFD magnitude data for the transmitted SFD sequence, for the second 8 symbol intervals. The values here are used when SFD_LENGTH is greater than 8. Where SFD_LENGTH is less than 16 the low order bits are applicable up to the specified length.
3 reg:21:03	TX_SSFD_SGNL (Symbols 7..0)	This field sets the short SFD polarity data for the transmitted SFD sequence, for the first 8 symbol intervals. The low order bits define the part of the SFD sequence sent first in time.
4 reg:21:04	TX_SSFD_SGNH (Symbols 15..8)	This field sets the short SFD polarity data for the transmitted SFD sequence, for the second 8 symbol intervals. The values here are used when SFD_LENGTH is greater than 8. Where SFD_LENGTH is less than 16 the low order bits are applicable up to the specified length.
5 reg:21:05	RX_SSFD_MAGL (Symbols 7..0)	This field sets the short SFD magnitude data for the receive SFD sequence, for the first 8 symbol intervals. The low order bits define the part of the SFD sequence sent first in time.
6 reg:21:06	TX_SSFD_SGNH (Symbols 15..8)	This field sets the short SFD magnitude data for the receive SFD sequence, for the second 8 symbol intervals. The values here are used when SFD_LENGTH is greater than 8. Where SFD_LENGTH is less than 16 the low order bits are applicable up to the specified length.
7 reg:21:07	RX_SSFD_SGNL (Symbols 7..0)	This field sets the short SFD polarity data for the receive SFD sequence, for the first 8 symbol intervals. The low order bits define the part of the SFD sequence sent first in time.
8 reg:21:08	TX_SSFD_SGNH (Symbols 15..8)	This field sets the short SFD polarity data for the receive SFD sequence, for the second 8 symbol intervals. The values here are used when SFD_LENGTH is greater than 8. Where SFD_LENGTH is less than 16 the low order bits are applicable up to the specified length.
9 reg:21:09	TX_LSFD_MAG0 (Symbols 7..0)	This field sets the long (64-symbol) SFD magnitude data for the transmitted SFD sequence. This byte covers the first 8 symbol intervals, symbols 7 to 0. The low order bits define the part of the SFD sequence sent first in time.
10 reg:21:0A	TX_LSFD_MAG1 (Symbols 15..8)	This field sets the long (64-symbol) SFD magnitude data for the transmitted SFD sequence, for symbol intervals 15 to 8.
11 reg:21:0B	TX_LSFD_MAG2 (Symbols 23..16)	This field sets the long (64-symbol) SFD magnitude data for the transmitted SFD sequence, for symbol intervals 23 to 16.
12 reg:21:0C	TX_LSFD_MAG3 (Symbols 31..24)	This field sets the long (64-symbol) SFD magnitude data for the transmitted SFD sequence, for symbol intervals 31 to 24.
13 reg:21:0D	TX_LSFD_MAG4 (Symbols 39..32)	This field sets the long (64-symbol) SFD magnitude data for the transmitted SFD sequence, for symbol intervals 39 to 32.
14 reg:21:0E	TX_LSFD_MAG5 (Symbols 47..40)	This field sets the long (64-symbol) SFD magnitude data for the transmitted SFD sequence, for symbol intervals 47 to 40.
15 reg:21:0F	TX_LSFD_MAG6 (Symbols 55..48)	This field sets the long (64-symbol) SFD magnitude data for the transmitted SFD sequence, for symbol intervals 55 to 48.
16 reg:21:10	TX_LSFD_MAG7 (Symbols 63..56)	This field sets the long (64-symbol) SFD magnitude data for the transmitted SFD sequence, for symbol intervals 63 to 56.
17 reg:21:11	TX_LSFD_SGN0 (Symbols 7..0)	This field sets the long (64-symbol) SFD polarity data for the transmitted SFD sequence. This byte covers the first 8 symbol intervals, symbols 7 to 0. The low order bits define the part of the SFD sequence sent first in time.
18 reg:21:12	TX_LSFD_SGN1 (Symbols 15..8)	This field sets the long (64-symbol) SFD polarity data for the transmitted SFD sequence, for symbol intervals 15 to 8.
19 reg:21:13	TX_LSFD_SGN2 (Symbols 23..16)	This field sets the long (64-symbol) SFD polarity data for the transmitted SFD sequence, for symbol intervals 23 to 16.
20 reg:21:14	TX_LSFD_SGN3 (Symbols 31..24)	This field sets the long (64-symbol) SFD polarity data for the transmitted SFD sequence, for symbol intervals 31 to 24.
21 reg:21:15	TX_LSFD_SGN4 (Symbols 39..32)	This field sets the long (64-symbol) SFD polarity data for the transmitted SFD sequence, for symbol intervals 39 to 32.

Sub-Index	Field	Description of fields within Register file: 0x21 – User defined SFD sequence
22 reg:21:16	TX_LSFD_SGN5 (Symbols 47..40)	This field sets the long (64-symbol) SFD polarity data for the transmitted SFD sequence, for symbol intervals 47 to 40.
23 reg:21:17	TX_LSFD_SGN6 (Symbols 55..48)	This field sets the long (64-symbol) SFD polarity data for the transmitted SFD sequence, for symbol intervals 55 to 48.
24 reg:21:18	TX_LSFD_SGN7 (Symbols 63..56)	This field sets the long (64-symbol) SFD polarity data for the transmitted SFD sequence, for symbol intervals 63 to 56.
25 reg:21:19	RX_LSFD_MAG0 (Symbols 7..0)	This field sets the long (64-symbol) SFD magnitude data for the receive SFD sequence. This byte covers the first 8 symbol intervals, symbols 7 to 0. The low order bits define the part of the SDF sequence arriving first in time.
26 reg:21:1A	RX_LSFD_MAG1 (Symbols 15..8)	This field sets the long (64-symbol) SFD magnitude data for the receive SFD sequence, for symbol intervals 15 to 8.
27 reg:21:1B	RX_LSFD_MAG2 (Symbols 23..16)	This field sets the long (64-symbol) SFD magnitude data for the receive SFD sequence, for symbol intervals 23 to 16.
28 reg:21:1C	RX_LSFD_MAG3 (Symbols 31..24)	This field sets the long (64-symbol) SFD magnitude data for the receive SFD sequence, for symbol intervals 31 to 24.
29 reg:21:1D	RX_LSFD_MAG4 (Symbols 39..32)	This field sets the long (64-symbol) SFD magnitude data for the receive SFD sequence, for symbol intervals 39 to 32.
30 reg:21:1E	RX_LSFD_MAG5 (Symbols 47..40)	This field sets the long (64-symbol) SFD magnitude data for the receive SFD sequence, for symbol intervals 47 to 40.
31 reg:21:1F	RX_LSFD_MAG6 (Symbols 55..48)	This field sets the long (64-symbol) SFD magnitude data for the receive SFD sequence, for symbol intervals 55 to 48.
32 reg:21:20	RX_LSFD_MAG7 (Symbols 63..56)	This field sets the long (64-symbol) SFD magnitude data for the receive SFD sequence, for symbol intervals 63 to 56.
33 reg:21:21	RX_LSFD_SGN0 (Symbols 7..0)	This field sets the long (64-symbol) SFD polarity data for the receive SFD sequence. This byte covers the first 8 symbol intervals, symbols 7 to 0. The low order bits define the part of the SDF sequence arriving first in time.
34 reg:21:22	RX_LSFD_SGN1 (Symbols 15..8)	This field sets the long (64-symbol) SFD polarity data for the receive SFD sequence, for symbol intervals 15 to 8.
35 reg:21:23	RX_LSFD_SGN2 (Symbols 23..16)	This field sets the long (64-symbol) SFD polarity data for the receive SFD sequence, for symbol intervals 23 to 16.
36 reg:21:24	RX_LSFD_SGN3 (Symbols 31..24)	This field sets the long (64-symbol) SFD polarity data for the receive SFD sequence, for symbol intervals 31 to 24.
37 reg:21:25	RX_LSFD_SGN4 (Symbols 39..32)	This field sets the long (64-symbol) SFD polarity data for the receive SFD sequence, for symbol intervals 39 to 32.
38 reg:21:26	RX_LSFD_SGN5 (Symbols 47..40)	This field sets the long (64-symbol) SFD polarity data for the receive SFD sequence, for symbol intervals 47 to 40.
39 reg:21:27	RX_LSFD_SGN6 (Symbols 55..48)	This field sets the long (64-symbol) SFD polarity data for the transmitted SFD sequence, for symbol intervals 55 to 48. receive
40 reg:21:28	RX_LSFD_SGN7 (Symbols 63..56)	This field sets the long (64-symbol) SFD polarity data for the receive SFD sequence, for symbol intervals 63 to 56.

Table 19: Recommended SFD sequence configurations for best performance

Data Rate	DWSFD	TNSSFD	RNSSFD	SFD Length	DESCRIPTION
6.8 Mbps	0	0	0	8	The IEEE standard SFD gives best performance at 6.8 Mbps as the data is the weakest part of the frame
850 kbps	1	0	0	16	The DecaWave defined non-standard SFD gives better performance than the standard SFD, especially the 16-symbols long form, as selected when the value of 16 is programmed into SFD_LENGTH (reg:21:00)
110 kbps	1	0	0	64	The DecaWave defined non-standard SFD gives better performance than the standard SFD.

Note: The selection [SFD](#) sequences other than the IEEE 802.15.4-2011 UWB standard compliant SFD sequence may improve performance, but it will of course make it impossible to interwork with a DW1000 configured to use the standard SFD (or with a third party standard compliant device).

7.2.35 Register file: 0x22 – Reserved

ID	Length (octets)	Type	Mnemonic	Description
0x22	-	-	-	Reserved – this register file is reserved

[Register map](#) register file 0x22 is reserved for future use. Please take care not to write to this register as doing so may cause the DW1000 to malfunction.

7.2.36 Register file: 0x23 –AGC configuration and control

ID	Length (octets)	Type	Mnemonic	Description
0x23	32	RW	AGC_CTRL	Automatic Gain Control configuration and control

[Register map](#) register file 0x23 is for configuration and control of the receiver gain control block. It contains a number of sub-registers, some of which need user control. Table 20 gives an overview of the sub-registers within [Register file: 0x23 –AGC configuration and control](#), and these sub-registers are individually described in sub-sections below.

Table 20: Register file: 0x23 –AGC configuration and control overview

OFFSET in Register 0x23	Mnemonic	Description
0x00	-	reserved
0x02	AGC_CTRL1	AGC Control #1

OFFSET in Register 0x23	Mnemonic	Description
0x04	AGC_TUNE1	AGC Tuning register 1
0x06	-	reserved
0x0C	AGC_TUNE2	AGC Tuning register 2
0x10	-	reserved
0x12	AGC_TUNE3	AGC Tuning register 3
0x14	-	reserved
0x1E	AGC_STAT1	AGC Status

7.2.36.1 Sub-Register 0x23:00 – AGC_RES1

ID	Length (octets)	Type	Mnemonic	Description
23:00	2	-	AGC_RES1	Reserved area 1

Register file: 0x23 –AGC configuration and control, sub-register 0x00 is a reserved register. Please take care not to write to this register as doing so may cause the DW1000 to malfunction.

7.2.36.2 Sub-Register 0x23:02 – AGC_CTRL1

ID	Length (octets)	Type	Mnemonic	Description
23:02	2	RW	AGC_CTRL1	AGC Control #1

Register file: 0x23 –AGC configuration and control, sub-register 0x02 is a 16-bit control register for the measurement function of the AGC. This register contains the fields identified and described below:

REG:23:02 – AGC_CTRL1 – AGC measurement control Register																																
31	30	29	28	27	26	25	24	23	22	21	20	19	18	17	16	15	14	13	12	11	10	9	8	7	6	5	4	3	2	1	0	
																-	-	-	-	-	-	-	-	-	-	-	-	-	-	-	-	DIS_AM
																0	0	0	0	0	0	0	0	0	0	0	0	0	0	0	0	

The bits of the AGC_CTRL1 register are described below:

Field	Description of fields within Sub-Register 0x23:02 – AGC_CTRL1
DIS_AM reg:23:02 bit:0	<p>Disable AGC Measurement. The DIS_AM bit is set by default to disable the AGC measurement function. The AGC measurement function might be used as an energy measurement for an “Energy Scan” as part of determining what channel to use. When DIS_AM bit is clear and the receiver is enabled the AGC will settle on an estimate of the background energy level and the result will be available via the EDG1 and EDV2 values in <i>Sub-Register 0x23:1E – AGC_STAT1</i>. To save power in the receiver, when this facility is not required or is not in use, it is recommended to set DIS_AM bit to 1 to disable this AGC measurement function.</p> <p>The recommended procedure to measure background energy level is as follows:</p> <ol style="list-style-type: none"> Set up the operating channel and related parameters as required*. Set DIS_AM bit to 0. Turn on the receiver with the RXENAB bit in <i>Register file: 0x0D – System Control Register</i>. Wait 32 μs for the AGC to settle. Set DIS_AM bit to 1 to freeze the result. Read EDG1 and EDV2 values and calculate noise energy, (as per Figure 26 below). Turn off the DW1000 with the TRXOFF bit in <i>Register file: 0x0D – System Control Register</i>. <p>* The important settings are the channel frequency related settings.</p>
– reg:22:02 bits:15–1	These bits are reserved.

7.2.36.3 Sub-Register 0x23:04 – AGC_TUNE1

ID	Length (octets)	Type	Mnemonic	Description
23:04	2	RW	AGC_TUNE1	AGC Tuning register 1

Register file: 0x23 – AGC configuration and control, sub-register 0x04 is a 16-bit tuning register for the AGC. The value here needs to change depending on the PRF. The values needed depending on the RXPRF configuration are given in Table 21 below. Please take care not to write other values to this register as doing so may cause the DW1000 to malfunction.

Table 21: Sub-Register 0x23:04 – AGC_TUNE1 values

RXPRF configuration	Value to program to Sub-Register 0x23:04 – AGC_TUNE1
(1) = 16 MHz PRF	0x8870
(2) = 64 MHz PRF	0x889B

7.2.36.4 Sub-Register 0x23:06 – AGC_RES2

ID	Length (octets)	Type	Mnemonic	Description
23:06	6	-	AGC_RES2	Reserved area 2

Register file: 0x23 –AGC configuration and control, sub-register 0x06 is a reserved area. Please take care not to write to this area as doing so may cause the DW1000 to malfunction.

7.2.36.5 Sub-Register 0x23:0C – AGC_TUNE2

ID	Length (octets)	Type	Mnemonic	Description
23:0C	4	RW	AGC_TUNE2	AGC Tuning register 2

Register file: 0x23 –AGC configuration and control, sub-register 0x0C is a 32-bit tuning register for the AGC. The default value of this register needs to be reconfigured for optimum operation of the AGC. Please ensure to program it to the value given in Table 22 below. Please take care not to write other values to this register as doing so may cause the DW1000 to malfunction.

Table 22:Sub-Register 0x23:0C – AGC_TUNE2values

Value to program to Sub-Register 0x23:0C – AGC_TUNE2
0X2502A907

7.2.36.6 Sub-Register 0x23:14 – AGC_RES3

ID	Length (octets)	Type	Mnemonic	Description
23:10	2	-	AGC_RES3	Reserved area 3

Register file: 0x23 –AGC configuration and control, sub-register 0x10 is a reserved register. Please take care not to write to this register as doing so may cause the DW1000 to malfunction.

7.2.36.7 Sub-Register 0x23:12 – AGC_TUNE3

ID	Length (octets)	Type	Mnemonic	Description
23:12	2	RW	AGC_TUNE3	AGC Tuning register 3

Register file: 0x23 –AGC configuration and control, sub-register 0x12 is a 16-bit tuning register for the AGC. The default value of this register needs to be reconfigured for optimum operation of the AGC. Please ensure to program it to the value given in Table 23 below. Please take care not to write other values to this register as doing so may cause the DW1000 to malfunction.

Table 23: Sub-Register 0x23:12 – AGC_TUNE3 values

Value to program to Sub-Register 0x23:12 – AGC_TUNE3
0x0055

7.2.36.8 Sub-Register 0x23:14 – AGC_RES4

ID	Length (octets)	Type	Mnemonic	Description
23:14	10	-	AGC_RES4	Reserved area 4

Register file: [0x23 –AGC configuration and control](#), sub-register 0x14 is a reserved area. Please take care not to write to this area as doing so may cause the DW1000 to malfunction.

7.2.36.9 Sub-Register 0x23:1E – AGC_STAT1

ID	Length (octets)	Type	Mnemonic	Description
23:1E	3	RO	AGC_STAT1	AGC Status

Register file: [0x23 –AGC configuration and control](#), sub-register 0x1E is a 24-bit status register for the measurement function of the AGC. This register contains the fields identified and described below:

REG:23:1E – AGC_STAT1 – AGC Status Register																															
31	30	29	28	27	26	25	24	23	22	21	20	19	18	17	16	15	14	13	12	11	10	9	8	7	6	5	4	3	2	1	0
								EDV2									EDG1					-		-	-	-	-	-			
								0									0					-		-	-	-	-	-			

The bits of the AGC_STAT1 register are described below:

Field	Description of fields within Sub-Register 0x23:1E – AGC_STAT1
EDG1 reg:23:1E bits:10–6	This 5-bit gain value relates to input noise power measurement. EDG1 can be used in conjunction with the EDV2 value to give a measure of the background in-band noise energy level. This might be used for an Energy Detect (<i>ED channel scan</i>) as part of implementing the IEEE 802.15.4 standard’s MLME-SCAN.request primitive. The noise energy level is given by combining EDG1 and EDV2 value as described in Figure 26 below.
EDV2 reg:23:1E bits:19–11	This 9-bit value relates to the input noise power measurement. EDV2 can be used in conjunction with the EDG1 value to give a measure of the background in-band noise energy level. This might be used for an Energy Detect (<i>ED channel scan</i>) as part of implementing the IEEE 802.15.4 standard’s MLME-SCAN.request primitive. The noise energy level is given by combining EDG1 and EDV2 value as described in Figure 26 below.
– reg:23:1E	These bits are reserved.

Combining EDG1 and EDV2 value to get a noise energy level is achieved by the equation:

$$(EDV2 - 40) \times 10^{EDG1} \times S_{ch}$$

Where S_{ch} is a scaling factor dependant on channel as per Table 24 below: -

Table 24: Scaling factor for channel noise energy estimation

Channel	S_{ch} scaling factor
1 to 4	1.3335
5 and 7	1.0000

The above formula does not give an absolute level but instead gives a relative level that allows comparison between channels in order to select the channel with least noise.

Figure 26: Combining EDG1 and EDV2 to give an ED noise figure

7.2.37 Register file: 0x24 – External Synchronisation Control

ID	Length (octets)	Type	Mnemonic	Description
0x24	12	RW	EXT_SYNC	External synchronisation control

[Register map](#) register file 0x24 is for control of the DW1000 synchronisation hardware.

There is a separate application note giving details of the external synchronisation. Please consult with DecaWave applications support team for details. The capabilities of the DW1000 with respect to external synchronisation are described briefly in section [6.1 - External Synchronisation](#).

OFFSET in Register 0x24	Mnemonic	Description
0x00	EC_CTRL	External clock synchronisation counter configuration
0x04	EC_RXTC	External clock counter captured on RMARKER
0x08	EC_GOLP	External clock offset to first path 1 GHz counter

7.2.37.1 Sub-Register 0x24:00 EC_CTRL

ID	Length (octets)	Type	Mnemonic	Description
24:00	4	RW	EC_CTRL	External clock synchronisation counter configuration

[Register file: 0x24 – External Synchronisation Control](#), sub-register 0x00 is the External clock synchronisation counter configuration register, EC_CTRL. The EC_CTRL register is used to configure the external synchronisation mode. The EC_CTRL register contains the following sub-fields:

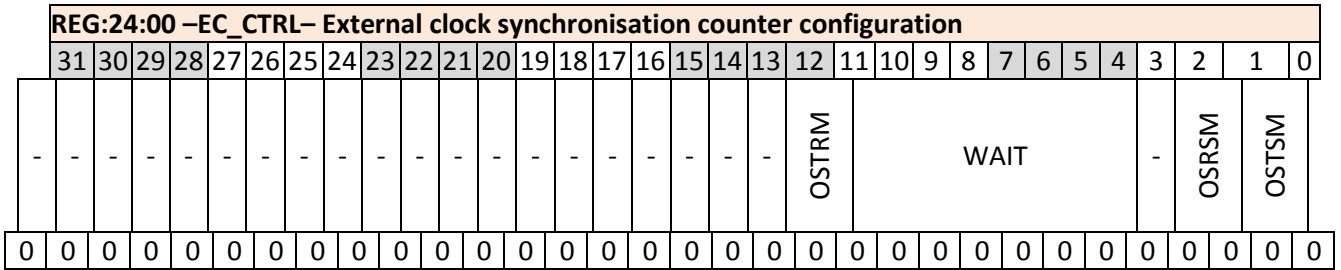

The fields of the EC_CTRL register identified above are individually described below:

Field	Description of fields within Sub-Register 0x24:00 EC_CTRL
OSTSM reg:24:00 bit:0	External transmit synchronisation mode enable. See section 6.1.2 – One Shot Transmit Synchronisation (OSTS) Mode .
OSRSM reg:24:00 bit:1	External receive synchronisation mode enable. See section 6.1.3 – One Shot Receive Synchronisation (OSRS) Mode .
WAIT reg:24:00 bits:10:3	Wait counter used for external transmit synchronisation and external timebase reset. See sections 6.1.2 – One Shot Transmit Synchronisation (OSTS) Mode and 6.1.1 – One Shot Timebase Reset (OSTR) Mode .
OSTRM reg:24:00 bit:11	External timebase reset mode enable. See section 6.1.1 – One Shot Timebase Reset (OSTR) Mode .

7.2.37.2 Sub-Register 0x24:04 EC_RXTC

ID	Length (octets)	Type	Mnemonic	Description
24:04	4	RO	EC_RXTC	External clock synchronisation counter captured on RMARKER.

Register file: 0x24 – External Synchronisation Control, sub-register 0x04 is the External clock synchronisation counter value captured on RMARKER, EC_RXTC. The EC_RXTC register is used to timestamp the received packet with respect to the external clock, see section [6.1.3 – One Shot Receive Synchronisation \(OSRS\) Mode](#) for details of the procedure. The EC_RXTC register contains the following sub-fields:

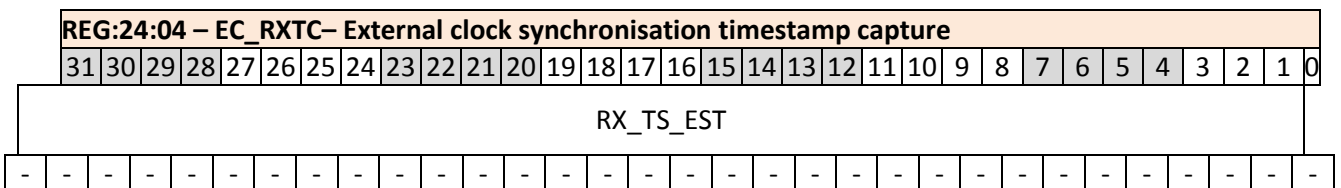

The fields of the EC_RXTC register identified above are individually described below:

Field	Description of fields within Sub-Register 0x24:04 EC_RXTC
RX_TS_EST reg:24:04 bits:31:0	External clock synchronisation counter captured on RMARKER. See section 6.1.3 – One Shot Receive Synchronisation (OSRS) Mode .

7.2.37.3 Sub-Register 0x24:08 EC_GOLP

ID	Length (octets)	Type	Mnemonic	Description
24:08	4	RO	EC_GOLP	External clock offset to first path 1 GHz counter

Register file: 0x24 – External Synchronisation Control, sub-register 0x08 is the External clock offset to first path 1 GHz counter, EC_GOLP. The EC_GOLP register is used to time the offset in 1 GHz intervals between the RMARKER, and the next edge of the external clock. This value can be used to calculate range with respect to the external clock, see section [6.1.3 – One Shot Receive Synchronisation \(OSRS\) Mode](#) for details of the procedure. The EC_GOLP register contains the following sub-fields:

REG:24:08– EC_GOLP– External clock offset to first path 1 GHz counter																															
31	30	29	28	27	26	25	24	23	22	21	20	19	18	17	16	15	14	13	12	11	10	9	8	7	6	5	4	3	2	1	0
-	-	-	-	-	-	-	-	-	-	-	-	-	-	-	-	-	-	-	-	-	-	-	-	-	OFFSET_EXT					-	
0	0	0	0	0	0	0	0	0	0	0	0	0	0	0	0	0	0	0	0	0	0	0	0	0	0	0	0	0	0	0	0

The fields of the EC_CTRL register identified above are individually described below:

Field	Description of fields within Sub-Register 0x24:08 EC_GOLP
OFFSET_EXT reg:24:08 bits: 5:0	This register contains the 1 GHz count from the arrival of the RMARKER and the next edge of the external clock. See section 6.1.3 – One Shot Receive Synchronisation (OSRS) Mode for details of its use.

7.2.38 Register file: 0x25 – Accumulator CIR memory

ID	Length (octets)	Type	Mnemonic	Description
0x25	4064	RO	ACC_MEM	Read access to accumulator data memory

Register map register file 0x25 is a large bank of memory that holds the accumulated channel impulse response (CIR) data. To accurately determine this timestamp the DW1000 incorporates an internal (LDE) algorithm to adjust the RMARKER receive timestamp as reported in Register file: 0x15 – Receive Time Stamp. A main component of the LDE algorithm is a search of the channel impulse response in the ACC_MEM to find the “leading edge” defining the first arriving ray.

The host system does not need to access the ACC_MEM in normal operation, however it may be of interest to the system design engineers to visualise the radio channel for diagnostic purposes.

The accumulator contains complex values, a 16-bit real integer and a 16-bit imaginary integer, for each tap of the accumulator, each of which represents a 1ns sample interval (or more precisely half a period of the 499.2 MHz fundamental frequency). The span of the accumulator is one symbol time. This is 992 samples for the nominal 16 MHz mean PRF, or, 1016 samples for the nominal 64 MHz mean PRF. These numbers are calculated from the Table 56 given that there are two samples per chip time.

NB: Because of an internal memory access delay when reading the accumulator the first octet output is a dummy octet that should be discarded. This is true no matter what sub-index the read begins at.

Sub-Index	Field	Description of fields within Register file: 0x25 – Accumulator CIR memory
0 reg:25:000	CIR[0].real.lo8	Low 8 bits of real part of accumulator sample 0
1 reg:25:001	CIR[0].real.hi8	High 8 bits of real part of accumulator sample 0
2 reg:25:002	CIR[0].imag.lo8	Low 8 bits of imaginary part of accumulator sample 0
3 reg:25:003	CIR[0].imag.hi8	High 8 bits of imaginary part of accumulator sample 0
4 reg:25:004	CIR[1].real.lo8	Low 8 bits of real part of accumulator sample 1
5 reg:25:005	CIR[1].real.hi8	High 8 bits of real part of accumulator sample 1
6 reg:25:006	CIR[1].imag.lo8	Low 8 bits of imaginary part of accumulator sample 1
7 reg:25:007	CIR[1].imag.hi8	High 8 bits of imaginary part of accumulator sample 1
:	:	:
:	:	:
4060 reg:25:FDC	CIR[1015].real.lo8	Low 8 bits of real part of accumulator sample 1015 (1016 th and last sample of CIR for the nominal 64 MHz mean PRF)
4061 reg:25:FDD	CIR[1015].real.hi8	High 8 bits of real part of accumulator sample 1015 (1016 th and last sample of CIR for the nominal 64 MHz mean PRF)
4062 reg:25:FDE	CIR[1015].imag.lo8	Low 8 bits of imaginary part of accumulator sample 1015 (1016 th and last sample of CIR for the nominal 64 MHz mean PRF)
4063 reg:25:FDf	CIR[1015].imag.hi8	High 8 bits of imaginary part of accumulator sample 1015 (1016 th and last sample of CIR for the nominal 64 MHz mean PRF)

NB: Because of an internal memory access delay when reading the accumulator the first octet output is a dummy octet that should be discarded. This is true no matter what sub-index the read begins at.

7.2.39 Register file: 0x26 – GPIO control and status

ID	Length (octets)	Type	Mnemonic	Description
0x26	44	RW	GPIO_CTRL	Peripheral register bus 1 access - GPIO control

Register map register file 0x26 is concerned with the use of the GPIO. It contains a number of sub-registers. An overview of these is given by Table 25. Each of these sub-registers is separately described in the sub-sections below.

Table 25: Register file: 0x26 – GPIO control and status overview

OFFSET in Register 0x26	Mnemonic	Description
0x00	GPIO_MODE	GPIO Mode Control Register
0x04	-	reserved
0x08	GPIO_DIR	GPIO Direction Control Register
0x0C	GPIO_DOUT	GPIO Data Output register
0x10	GPIO_IRQE	GPIO Interrupt Enable
0x14	GPIO_ISEN	GPIO Interrupt Sense Selection
0x18	GPIO_IMODE	GPIO Interrupt Mode (Level / Edge)
0x1C	GPIO_IBES	GPIO Interrupt “Both Edge” Select
0x20	GPIO_ICLR	GPIO Interrupt Latch Clear
0x24	GPIO_IDBE	GPIO Interrupt De-bounce Enable
0x28	GPIO_RAW	GPIO raw state

7.2.39.1 Sub-Register 0x26:00 – GPIO_MODE

ID	Length (octets)	Type	Mnemonic	Description
26:00	4	RW	GPIO_MODE	GPIO Mode Control Register

Register file: 0x26 – GPIO control and status, sub-register 0x00 is the GPIO Mode Control Register, GPIO_MODE. The GPIO_MODE register is used to select whether the GPIO is operating as a GPIO or has another special function. The GPIO_MODE register contains the following sub-fields:

REG:26:00 – GPIO_MODE – GPIO Mode Control Register																															
31	30	29	28	27	26	25	24	23	22	21	20	19	18	17	16	15	14	13	12	11	10	9	8	7	6	5	4	3	2	1	0
-	-	-	-	-	-	-	-	MSGP8	MSGP7	MSGP6	MSGP5	MSGP4	MSGP3	MSGP2	MSGP1	MSGP0	-	-	-	-	-	-	-	-	-	-	-	-	-	-	-
0	0	0	0	0	0	0	0	0	0	0	0	0	0	0	0	0	0	0	0	0	0	0	0	0	0	0	0	0	0	0	0

The fields of the GPIO_MODE register identified above are individually described below:

Field	Description of fields within Sub-Register 0x26:00 – GPIO_MODE
-	Bits marked ‘-’ are reserved and should be written as zero.

Field	Description of fields within Sub-Register 0x26:00 – GPIO_MODE
MSGP0 reg:26:00 bits:7,6	<p>Mode Selection for GPIO0/RXOKLED.</p> <p>00: The pin operates as GPIO0 – This is the default (reset) state.</p> <p>01: The pin operates as the RXOKLED output.</p> <p>10: Reserved. Do not select this value.</p> <p>11: Reserved. Do not select this value.</p> <p>When operating as the RXOKLED driver, the output is asserted briefly when the receiver completes the reception of a frame with a good FCS/CRC. The on time for the RXOKLED depends on the blink time set in Sub-Register 0x36:28 – PMSC_LEDC.</p> <p>Note: Lighting LEDs will drain power in battery-powered applications.</p>
MSGP1 reg:26:00 bits:9,8	<p>Mode Selection for GPIO1/SFDLED.</p> <p>00: The pin operates as GPIO1– This is the default (reset) state.</p> <p>01: The pin operates as the SFDLED output.</p> <p>10: Reserved. Do not select this value.</p> <p>11: Reserved. Do not select this value.</p> <p>When operating as the driver, the output is asserted briefly when the receiver detects the SFD sequence in the RX frame. The on time is determined by the blink time configuration set in Sub-Register 0x36:28 – PMSC_LEDC</p> <p>Note: Lighting LEDs will drain power in battery-powered applications.</p>
MSGP2 reg:26:00 bits:11,10	<p>Mode Selection for GPIO2/RXLED. Allowed values are:</p> <p>00: The pin operates as the GPIO2 output – This is the default (reset) state.</p> <p>01: The pin operates as the RXLED output.</p> <p>10: Reserved. Do not select this value.</p> <p>11: Reserved. Do not select this value.</p> <p>When operating as the RXLED driver, the output is asserted when the receiver is on, and stays on for a brief period after the receiver is turned off. The minimum on time is determined by the blink time configurable in Sub-Register 0x36:28 – PMSC_LEDC.</p> <p>Note: Lighting LEDs will drain power in battery-powered applications.</p>
MSGP3 reg:26:00 bits:13,12	<p>Mode Selection for GPIO3/TXLED. Allowed values are:</p> <p>00: The pin operates as GPIO3– This is the default (reset) state.</p> <p>01: The pin operates as the TXLED output.</p> <p>10: Reserved. Do not select this value.</p> <p>11: Reserved. Do not select this value.</p> <p>When operating as the TXLED driver, the output is asserted briefly when the transmitter completes sending a frame. The blink time is configurable via Sub-Register 0x36:28 – PMSC_LEDC.</p> <p>Note: Lighting LEDs will drain power in battery-powered applications.</p>
MSGP4 reg:26:00 bits:15,14	<p>Mode Selection for GPIO4/EXTPA. Allowed values are:</p> <p>00: The pin operates as GPIO4– This is the default (reset) state.</p> <p>01: The pin operates as the EXTPA output.</p> <p>10: Reserved. Do not select this value.</p> <p>11: Reserved. Do not select this value.</p> <p>Refer to section 6.2 – External Power Amplification for further information on the use of EXTPA.</p>

Field	Description of fields within Sub-Register 0x26:00 – GPIO_MODE
MSGP5 reg:26:00 bits:17,16	Mode Selection for GPIO5/EXTTXE. Allowed values are: 00: The pin operates as GPIO5 – This is the default (reset) state. 01: The pin operates as the EXTTXE output. 10: Reserved. Do not select this value. 11: Reserved. Do not select this value. Refer to section 6.2 – External Power Amplification for further information on the use of EXTTXE.
MSGP6 reg:26:00 bits:19,18	Mode Selection forGPIO6/EXTRXE. Allowed values of MSGP6are: 00: The pin operates as GPIO6– This is the default (reset) state. 01: The pin operates as the EXTRXE output. 10: Reserved. Do not select this value. 11: Reserved. Do not select this value. Refer to section 6.2 – External Power Amplification for further information on the use of EXTRXE.
MSGP7 reg:26:00 bits:21,20	Mode Selection for SYNC/GPIO7.Allowed values are: 00: The pin operates as the SYNC input– This is the default (reset) state. 01: The pin operates as GPIO7. 10: Reserved. Do not select this value. 11: Reserved. Do not select this value. Please refer to section 6.1 - External Synchronisation for information on the use of the SYNC pin.
MSGP8 reg:26:00 bits:23,22	Mode Selection for IRQ/GPIO8. Allowed values are: 00: The pin operates as the IRQ output – This is the default (reset) state. 01: The pin operates as GPIO8. 10: Reserved. Do not select this value. 11: Reserved. Do not select this value.

7.2.39.2 Sub-Register 0x26:04 – Reserved

ID	Length (octets)	Type	Mnemonic	Description
26:04	4	-	-	Reserved

Register file: [0x26 – GPIO control and status](#), sub-register 0x04 is reserved.

7.2.39.3 Sub-Register 0x26:08 – GPIO_DIR

ID	Length (octets)	Type	Mnemonic	Description
26:08	4	RW	GPIO_DIR	GPIO Direction control register

Register file: [0x26 – GPIO control and status](#), sub-register 0x08 is the GPIO Direction Control Register, GPIO_DIR. The GPIO_DIR register applies to the GPIO pins when they are selected to operate as GPIOs via the GPIO_MODE register. It contains a bit for each GPIO to individually configure that GPIO as an input or an output. The register is designed to allow software to change the direction of a single pin without knowing the settings needed for other pins. This is achieved by having for each direction selection bit (GDP)

an associated mask bit (GDM) used to qualify the write to the GDP direction bit. This allows an individual direction to be changed in the register without affecting other direction bits. When reading from this register mask bits are always read as 0, direction bits will read to show the direction setting for the GPIO pins. A GDP direction bit value of 1 means the pin is an input. A GDP bit value of 0 means the pin is an output. The GDP bits and their corresponding GDM mask bits are arranged with four GPIO per octet to allow a single octet write to change direction of an individual GPIO.

The GPIO_DIR register contains the following sub-fields:

REG:26:08 – GPIO_DIR – GPIO Direction control register																															
31	30	29	28	27	26	25	24	23	22	21	20	19	18	17	16	15	14	13	12	11	10	9	8	7	6	5	4	3	2	1	0
-	-	-	-	-	-	-	-	-	-	-	GDM8	-	-	-	GDP8	GDM7	GDM6	GDM5	GDM4	GDP7	GDP6	GDP5	GDP4	GDM3	GDM2	GDM1	GDM0	GDP3	GDP2	GDP1	GDP0
0	0	0	0	0	0	0	0	0	0	0	0	0	0	0	1	0	0	0	0	1	1	1	1	0	0	0	0	1	1	1	1

The fields of the GPIO_DIR register identified above are individually described below:

Field	Description of fields within Sub-Register 0x26:08 – GPIO_DIR
-	Bits marked '-' in are reserved and should be written as zero.
GDP0 reg:26:08 bit:0	Direction Selection for GPIO0. Reading this bit shows the direction setting for GPIO0. Values 1 = input, 0 = output. When writing (either 1 or 0) this GDP0 value is only changed if the GDM0 mask bit has a value of 1 for the write operation.
GDP1 bit:1	Direction Selection for GPIO1. (See GDP0).
GDP2 bit:2	Direction Selection for GPIO2. (See GDP0).
GDP3 bit:3	Direction Selection for GPIO3. (See GDP0).
GDM0 reg:26:08 bit:4	Mask for setting the direction of GPIO0. When writing to GDP0 so select the I/O direction of GPIO0, the value of GDP0 is only changed if this GDM0 mask bit has a value of 1 for the write operation. GDM0 will always read as 0.
GDM1 bit:5	Mask for setting the direction of GPIO1. (See GDM0).
GDM2 bit:6	Mask for setting the direction of GPIO2. (See GDM0).
GDM3 bit:7	Mask for setting the direction of GPIO3. (See GDM0).
GDP4 bit:8	Direction Selection for GPIO4. (See GDP0).
GDP5 bit:9	Direction Selection for GPIO5. (See GDP0).
GDP6 bit:10	Direction Selection for the GPIO6. (See GDP0).
GDP7 bit:11	Direction Selection for the GPIO7. (See GDP0).
GDM4 bit:12	Mask for setting the direction of GPIO4. (See GDM0).
GDM5 bit:13	Mask for setting the direction of GPIO5. (See GDM0).

Field	Description of fields within Sub-Register 0x26:08 – GPIO_DIR
GDM6 bit:15	Mask for setting the direction of GPIO6. (See GDM0).
GDM7 reg:26:08 bit:15	Mask for setting the direction of GPIO7. (See GDM0).
GDP8 reg:26:08 bit:16	Direction Selection for GPIO8. (See GDP0).
GDM8 reg:26:08 bit:20	Mask for setting the direction of GPIO8. (See GDM0).

7.2.39.4 Sub-Register 0x26:0C – GPIO_DOUT

ID	Length (octets)	Type	Mnemonic	Description
26:0C	4	RW	GPIO_DOUT	GPIO Data Output register

Register file: 0x26 – GPIO control and status, sub-register 0x0C is the GPIO data output register. The GPIO_DOUT register applies to the GPIO pins when they are selected to operate as GPIO outputs via the GPIO_MODE and GPIO_DIR registers. It contains a bit for each GPIO pin to individually select the data to output on the GPIO output pin. The GPIO_DOUT register is designed to allow software to change the output state of a single pin without knowing the settings of other output pins. This is achieved by having for each output value selection bit (GOP) an associated mask bit (GOM) used to qualify the write to the GOP bit. When reading from the GPIO_DOUT register the mask bits are always read as 0, output value bits will read to show the current output setting for the GPIO pins. Note, this does not mean this is being output since that depends also on the appropriate selection of the GPIO_MODE and GPIO_DIR registers. The output value bits and their corresponding mask bits arranged with four GPIO per octet to allow a single octet write to change the state of an individual GPIO output.

The GPIO_DOUT register contains the following sub-fields:

REG:26:0C – GPIO_DOUT – GPIO Data Output register																															
31	30	29	28	27	26	25	24	23	22	21	20	19	18	17	16	15	14	13	12	11	10	9	8	7	6	5	4	3	2	1	0
-	-	-	-	-	-	-	-	-	-	-	GOM8	-	-	-	GOP8	GOM7	GOM6	GOM5	GOM4	GOP7	GOP6	GOP5	GOP4	GOM3	GOM2	GOM1	GOM0	GOP3	GOP2	GOP1	GOP0
0	0	0	0	0	0	0	0	0	0	0	0	0	0	0	0	0	0	0	0	0	0	0	0	0	0	0	0	0	0	0	0

The fields of the GPIO_DOUT register identified above are individually described below:

Field	Description of fields within Sub-Register 0x26:0C – GPIO_DOUT
-	Bits marked '-' are reserved and should be written as zero.

Field	Description of fields within Sub-Register 0x26:0C – GPIO_DOUT
GOP0 reg:26:0C bit:0	Output state setting for the GPIO0 output. Reading this bit shows the current setting for GPIO0. Value 1 = logic 1 voltage high output and, value 0 = logic 1 voltage low output. When writing (either 1 or 0) to this GOP0bit, its value is only changed if the GOM0mask bit has a value of 1 in that write operation.
GOP1 bit:1	Output state setting for GPIO1. (See GOP0).
GOP2 bit:2	Output state setting for GPIO1. (See GOP0).
GOP3 bit:3	Output state setting for GPIO2. (See GOP0).
GOM0 reg:26:0C bit:4	Mask for setting GPIO0 output state. When writing to GOP0so select state of the GPIO0 output, the value of GOP0is only changed if this GOM0mask bit has a value of 1 for the write operation. GOM0will always read as 0.
GOM1 bit:5	Mask for setting GPIO1 output state. (See GOM0).
GOM2 bit:6	Mask for setting GPIO2 output state. (See GOM0).
GOM3 bit:7	Mask for setting GPIO3 output state. (See GOM0).
GOP4 bit:8	Output state setting for GPIO4. (See GOP0).
GOP5 bit:9	Output state setting for GPIO5. (See GOP0).
GOP6 bit:10	Output state setting for GPIO6. (See GOP0).
GOP7 bit:11	Output state setting for GPIO7. (See GOP0).
GOM4 bit:12	Mask for setting the GPIO4 output state. (See GOM0).
GOM5 bit:13	Mask for setting the GPIO5 output state. (See GOM0).
GOM6 bit:15	Mask for setting the GPIO6 output state. (See GOM0).
GOM7 reg:26:0C bit:15	Mask for setting the GPIO7 output state. (See GOM0).
GOP8 reg:26:0C bit:16	Output state setting for GPIO8. (See GOP0).
GOM8 reg:26:0C bit:20	Mask for setting the GPIO8 output state. (See GOM0).

7.2.39.5 Sub-Register 0x26:10 – GPIO_IRQE

ID	Length (octets)	Type	Mnemonic	Description
26:10	4	RW	GPIO_IRQE	GPIO Interrupt Enable

Register file: [0x26 – GPIO control and status](#), sub-register 0x10 is the GPIO interrupt enable register. The GPIO_IRQE register allows a GPIO input pin to be selected as an interrupt source into the DW1000.

Additional configuration registers GPIO_IMODE, GPIO_ISEN, GPIO_IBES and GPIO_IDBE allow the interrupt to be set as level sensitive with control of whether it is the low or high state that generates the interrupt, or as edge sensitive with control of the edge(s) that generates the interrupt, and includes a configurable de-bounce circuit that can be used to ignore transients on the input. The GPIO_IRQE register contains a bit for each GPIO pin to allow each to be individually selected as interrupt source. Setting the appropriate bit to 1 enables the corresponding GPIO input as an interrupt source, a value of 0 disables that interrupt. When a GPIO interrupt is triggered it is signalled to the host via the GPIOIRQ event status bit in [Register file: 0x0F – System Event Status Register](#). The bits of the GPIO_IRQE register are as following:

REG:26:10 – GPIO_IRQE – GPIO Interrupt Enable register																																
31	30	29	28	27	26	25	24	23	22	21	20	19	18	17	16	15	14	13	12	11	10	9	8	7	6	5	4	3	2	1	0	
-	-	-	-	-	-	-	-	-	-	-	-	-	-	-	-	-	-	-	-	-	-	-	-	GIRQE8	GIRQE7	GIRQE6	GIRQE5	GIRQE4	GIRQE3	GIRQE2	GIRQE1	GIRQE0
0	0	0	0	0	0	0	0	0	0	0	0	0	0	0	0	0	0	0	0	0	0	0	0	0	0	0	0	0	0	0	0	0

The bits identified above are individually described below:

Field	Description of fields within Sub-Register 0x26:10 – GPIO_IRQE
GIRQE0 reg:26:10 bit:0	GPIO IRQ Enable for GPIO0 input. Value 1 = enable GPIO input GPIO0 as an interrupt source. Value 0 = GPIO0 is not an interrupt source.
GIRQE1 bit:1	GPIO IRQ Enable for GPIO1 input. Value 1 = enable, 0 = disable.
GIRQE2 bit:2	GPIO IRQ Enable for GPIO2 input. Value 1 = enable, 0 = disable.
GIRQE3 bit:3	GPIO IRQ Enable for GPIO3 input. Value 1 = enable, 0 = disable.
GIRQE4 bit:4	GPIO IRQ Enable for GPIO4 input. Value 1 = enable, 0 = disable.
GIRQE5 bit:5	GPIO IRQ Enable for GPIO5 input. Value 1 = enable, 0 = disable.
GIRQE6 bit:6	GPIO IRQ Enable for GPIO6 input. Value 1 = enable, 0 = disable.
GIRQE7 bit:7	GPIO IRQ Enable for GPIO7 input. Value 1 = enable, 0 = disable.
GIRQE8 reg:26:10 bit:8	GPIO IRQ Enable for GPIO8 input. Value 1 = enable, 0 = disable.
- reg:26:10 bits:31–9	Bits marked '-' are reserved and should be written as zero.

7.2.39.6 Sub-Register 0x26:14 – GPIO_ISEN

ID	Length (octets)	Type	Mnemonic	Description
26:14	4	RW	GPIO_ISEN	GPIO Interrupt Sense Selection

Register file: 0x26 – GPIO control and status, sub-register 0x14 is the GPIO interrupt sense selection register. The GPIO_ISEN register acts to set the state/event that gives rise to a GPI interrupt. Assuming that the GPIO is an input and that it is enabled as an interrupt via the GPIO_IRQE register, then the GPIO_IMODE register selects whether the interrupt is level or edge sensitive, and this register GPIO_ISEN selects which level or edge is the state/event that causes the interrupt. The GPIO_ISEN register contains a bit for each GPIO pin to allow each to be individually configured. The bits are as follows:

REG:26:14 – GPIO_ISEN – GPIO Interrupt Sense Selection register																															
31	30	29	28	27	26	25	24	23	22	21	20	19	18	17	16	15	14	13	12	11	10	9	8	7	6	5	4	3	2	1	0
-	-	-	-	-	-	-	-	-	-	-	-	-	-	-	-	-	-	-	-	-	-	-	GISEN8	GISEN7	GISEN6	GISEN5	GISEN4	GISEN3	GISEN2	GISEN1	GISEN0
0	0	0	0	0	0	0	0	0	0	0	0	0	0	0	0	0	0	0	0	0	0	0	0	0	0	0	0	0	0	0	0

The bits of the GPIO_ISEN register identified above are individually described below:

Field	Description of fields within Sub-Register 0x26:14 – GPIO_ISEN
GISEN0 reg:26:14 bit:0	GPIO IRQ Sense selection GPIO0 input. Value 0 = Active high level sensitive interrupt or rising-edge triggered interrupt. Value 1 = Active low level sensitive interrupt or falling-edge triggered interrupt.
GISEN1 bit:1	GPIO IRQ sense for GPIO1 input. Value 0 = High or Rising-Edge, 1 = Low or falling-edge.
GISEN2 bit:2	GPIO IRQ sense for GPIO2 input. Value 0 = High or Rising-Edge, 1 = Low or falling-edge.
GISEN3 bit:3	GPIO IRQ sense for GPIO3 input. Value 0 = High or Rising-Edge, 1 = Low or falling-edge.
GISEN4 bit:4	GPIO IRQ sense for GPIO4 input. Value 0 = High or Rising-Edge, 1 = Low or falling-edge.
GISEN5 bit:5	GPIO IRQ sense for GPIO5 input. Value 0 = High or Rising-Edge, 1 = Low or falling-edge.
GISEN6 bit:6	GPIO IRQ sense for GPIO6 input. Value 0 = High or Rising-Edge, 1 = Low or falling-edge.
GISEN7 bit:7	GPIO IRQ sense for GPIO7 input. Value 0 = High or Rising-Edge, 1 = Low or falling-edge.
GISEN8 reg:26:14 bit:8	GPIO IRQ sense for GPIO8 input. Value 0 = High or Rising-Edge, 1 = Low or falling-edge.
- reg:26:14 bits:31–9	Bits marked '-' are reserved and should be written as zero.

7.2.39.7 Sub-Register 0x26:18 – GPIO_IMODE

ID	Length (octets)	Type	Mnemonic	Description
26:18	4	RW	GPIO_IMODE	GPIO Interrupt Mode (Level/Edge)

Register file: [0x26 – GPIO control and status](#), sub-register 0x18 is the GPIO interrupt mode selection register. Assuming that the GPIO is an input and enabled as an interrupt via the GPIO_IRQE register, then this GPIO_IMODE register acts to select whether the interrupt is level sensitive or edge triggered. The GPIO_IMODE register contains a bit for each GPIO pin to allow each to be individually configured. The bits are as follows:

REG:26:18 – GPIO_IMODE – GPIO Interrupt Mode selection register																															
31	30	29	28	27	26	25	24	23	22	21	20	19	18	17	16	15	14	13	12	11	10	9	8	7	6	5	4	3	2	1	0
-	-	-	-	-	-	-	-	-	-	-	-	-	-	-	-	-	-	-	-	-	-	-	GIMOD8	GIMOD7	GIMOD6	GIMOD5	GIMOD4	GIMOD3	GIMOD2	GIMOD1	GIMOD0
0	0	0	0	0	0	0	0	0	0	0	0	0	0	0	0	0	0	0	0	0	0	0	0	0	0	0	0	0	0	0	0

The bits of the GPIO_IMODE register identified above are individually described below:

Field	Description of fields within Sub-Register 0x26:18 – GPIO_IMODE
GIMOD0 reg:26:18 bit:0	GPIO IRQ Mode selection for GPIO0 input. Value 0 = Level sensitive interrupt. Value 1 = Edge triggered interrupt.
GIMOD1 bit:1	GPIO IRQ Mode selection for GPIO1 input. Value 0 = Level, 1 = Edge.
GIMOD2 bit:2	GPIO IRQ Mode selection for GPIO2 input. Value 0 = Level, 1 = Edge.
GIMOD3 bit:3	GPIO IRQ Mode selection for GPIO3 input. Value 0 = Level, 1 = Edge.
GIMOD4 bit:4	GPIO IRQ Mode selection for GPIO4 input. Value 0 = Level, 1 = Edge.
GIMOD5 bit:5	GPIO IRQ Mode selection for GPIO5 input. Value 0 = Level, 1 = Edge.
GIMOD6 bit:6	GPIO IRQ Mode selection for GPIO6 input. Value 0 = Level, 1 = Edge.
GIMOD7 bit:7	GPIO IRQ Mode selection for GPIO7 input. Value 0 = Level, 1 = Edge.
GIMOD8 reg:26:18 bit:8	GPIO IRQ Mode selection for GPIO8 input. Value 0 = Level, 1 = Edge.
- reg:26:18 bits:31–9	Bits marked '-' are reserved and should be written as zero.

7.2.39.8 Sub-Register 0x26:1C – GPIO_IBES

ID	Length (octets)	Type	Mnemonic	Description
26:1C	4	RW	GPIO_IBES	GPIO Interrupt “Both Edge” Select

Register file: [0x26 – GPIO control and status](#), sub-register 0x1C is the GPIO interrupt “Both Edge” selection register. This only applies when edge sensitive interrupts are enabled in the GPIO_IMODE register. In this

case the GPIO_ISEN register normally acts to select which edge triggers the interrupt. This GPIO_IBES register overrides the GPIO_ISEN register to select both edges as which edge triggers the interrupt. The GPIO_IBES register contains a bit for each GPIO pin to allow each to be individually configured. The bits are as follows:

REG:26:1C – GPIO_IBES – GPIO Interrupt “Both Edge” selection register																																
31	30	29	28	27	26	25	24	23	22	21	20	19	18	17	16	15	14	13	12	11	10	9	8	7	6	5	4	3	2	1	0	
-	-	-	-	-	-	-	-	-	-	-	-	-	-	-	-	-	-	-	-	-	-	-	-	GIBES8	GIBES7	GIBES6	GIBES5	GIBES4	GIBES3	GIBES2	GIBES1	GIBES0
0	0	0	0	0	0	0	0	0	0	0	0	0	0	0	0	0	0	0	0	0	0	0	0	0	0	0	0	0	0	0	0	0

The bits of the GPIO_IBES register identified above are individually described below:

Field	Description of fields within Sub-Register 0x26:1C – GPIO_IBES
GIBES0 reg:26:1C bit:0	GPIO IRQ “Both Edge” selection for GPIO0 input. Value 0 = GPIO_IMODE register selects the edge. Value 1 = Both edges trigger the interrupt.
GIBES1 bit:1	GPIO IRQ “Both Edge” selection for GPIO1 input. Value 0 = use GPIO_IMODE, 1 = Both Edges.
GIBES2 bit:2	GPIO IRQ “Both Edge” selection for GPIO2 input. Value 0 = use GPIO_IMODE, 1 = Both Edges.
GIBES3 bit:3	GPIO IRQ “Both Edge” selection for GPIO3 input. Value 0 = use GPIO_IMODE, 1 = Both Edges.
GIBES4 bit:4	GPIO IRQ “Both Edge” selection for GPIO4 input. Value 0 = use GPIO_IMODE, 1 = Both Edges.
GIBES5 bit:5	GPIO IRQ “Both Edge” selection for GPIO5 input. Value 0 = use GPIO_IMODE, 1 = Both Edges.
GIBES6 bit:6	GPIO IRQ “Both Edge” selection for GPIO6 input. Value 0 = use GPIO_IMODE, 1 = Both Edges.
GIBES7 bit:7	GPIO IRQ “Both Edge” selection for GPIO7 input. Value 0 = use GPIO_IMODE, 1 = Both Edges.
GIBES8 reg:26:1C bit:8	GPIO IRQ “Both Edge” selection for GPIO8 input. Value 0 = use GPIO_IMODE, 1 = Both Edges.
- reg:26:1C bits:31–9	Bits marked ‘-’ are reserved and should be written as zero.

7.2.39.9 Sub-Register 0x26:20 – GPIO_ICLR

ID	Length (octets)	Type	Mnemonic	Description
26:20	4	RW	GPIO_ICLR	GPIO Interrupt Latch Clear

[Register file: 0x26 – GPIO control and status](#), sub-register 0x20 is the GPIO interrupt clear register. When a GPIO interrupt occurs that meets the configured criteria (edge/level etc.) that event is latched in an internal interrupt latch. To clear the interrupt the host needs to write a 1 to the appropriate bit of this GPIO_ICLR register. There is no way to read the interrupt latch, which means that only one GPIO can be enabled to

interrupt at a time, unless the host has some other external way to distinguish events. Although level sensitive interrupts are latched, if the active level persists, then clearing the latch will be ineffective, since the interrupt will occur again immediately. The GPIO_ICLR register contains a bit for each GPIO pin as follows:

REG:26:20 – GPIO_ICLR – GPIO Interrupt latch clear																																
31	30	29	28	27	26	25	24	23	22	21	20	19	18	17	16	15	14	13	12	11	10	9	8	7	6	5	4	3	2	1	0	
-	-	-	-	-	-	-	-	-	-	-	-	-	-	-	-	-	-	-	-	-	-	-	-	GICLR8	GICLR7	GICLR6	GICLR5	GICLR4	GICLR3	GICLR2	GICLR1	GICLR0
-	-	-	-	-	-	-	-	-	-	-	-	-	-	-	-	0	0	0	0	0	0	0	0	0	0	0	0	0	0	0	0	0

The bits of the GPIO_ICLR register identified above are individually described below:

Field	Description of fields within Sub-Register 0x26:20 – GPIO_ICLR
GICLR0 reg:26:20 bit:0	GPIO IRQ latch clear for GPIO0 input. Write 1 to clear the GPIO0 interrupt latch. Writing 0 has no effect. Reading returns zero.
GICLR1 bit:1	GPIO IRQ latch clear for GPIO1 input. Write 1 to clear the interrupt latch.
GICLR2 bit:2	GPIO IRQ latch clear for GPIO2 input. Write 1 to clear the interrupt latch.
GICLR3 bit:3	GPIO IRQ latch clear for GPIO3 input. Write 1 to clear the interrupt latch.
GICLR4 bit:4	GPIO IRQ latch clear for GPIO4 input. Write 1 to clear the interrupt latch.
GICLR5 bit:5	GPIO IRQ latch clear for GPIO5 input. Write 1 to clear the interrupt latch.
GICLR6 bit:6	GPIO IRQ latch clear for GPIO6 input. Write 1 to clear the interrupt latch.
GICLR7 bit:7	GPIO IRQ latch clear for GPIO7 input. Write 1 to clear the interrupt latch.
GICLR8 reg:26:20 bit:8	GPIO IRQ latch clear for GPIO8 input. Write 1 to clear the interrupt latch..
- reg:26:20 bits:31-9	Bits marked '-' are reserved and should be written as zero.

7.2.39.10 Sub-Register 0x26:24 – GPIO_IDBE

ID	Length (octets)	Type	Mnemonic	Description
26:24	4	RW	GPIO_IDBE	GPIO Interrupt De-bounce Enable

Register file: 0x26 – GPIO control and status, sub-register 0x24 is the GPIO interrupt de-bounce enable register. The GPIO_IDBE controls a filtering function that operates on the GPIO inputs prior to their presentation into the GPIO interrupt logic. This de-bounce filter circuit removes short transients by using the kilohertz clock (as enabled by the KHZCLKEN bit in *Sub-Register 0x36:00 – PMSC_CTRL0*) to sample the input

signal. See KHZCLKDIV in [Sub-Register 0x36:04 – PMSC_CTRL1](#) for a description of the kilohertz clock. The de-bounce filter is active when a state change of the GPIO input needs to persist for two cycles of this clock before it will be seen by the interrupt handling logic. The GPIO_IDBE register contains a bit for each GPIO pin as follows:

REG:26:24 – GPIO_IDBE – GPIO Interrupt De-Bounce Enable																																
31	30	29	28	27	26	25	24	23	22	21	20	19	18	17	16	15	14	13	12	11	10	9	8	7	6	5	4	3	2	1	0	
-	-	-	-	-	-	-	-	-	-	-	-	-	-	-	-	-	-	-	-	-	-	-	-	GIDBE8	GIDBE7	GIDBE6	GIDBE5	GIDBE4	GIDBE3	GIDBE2	GIDBE1	GIDBE0
-	-	-	-	-	-	-	-	-	-	-	-	-	-	-	-	0	0	0	0	0	0	0	0	0	0	0	0	0	0	0	0	0

The bits of the GPIO_IDBE register identified above are individually described below:

Field	Description of fields within Sub-Register 0x26:24 – GPIO_IDBE
GIDBE0 reg:26:24 bit:0	GPIO IRQ de-bounce enable for GPIO0. Value 1 = de-bounce enabled. Value 0 = de-bounce disabled.
GIDBE1 bit:1	GPIO1 IRQ de-bounce configuration. Value 1 = de-bounce enabled, 0 = de-bounce disabled.
GIDBE2 bit:2	GPIO2 IRQ de-bounce configuration. Value 1 = de-bounce enabled, 0 = de-bounce disabled.
GIDBE3 bit:3	GPIO3 IRQ de-bounce configuration. Value 1 = de-bounce enabled, 0 = de-bounce disabled.
GIDBE4 bit:4	GPIO4 IRQ de-bounce configuration. Value 1 = de-bounce enabled, 0 = de-bounce disabled.
GIDBE5 bit:5	GPIO5 IRQ de-bounce configuration. Value 1 = de-bounce enabled, 0 = de-bounce disabled.
GIDBE6 bit:6	GPIO6 IRQ de-bounce configuration. Value 1 = de-bounce enabled, 0 = de-bounce disabled.
GIDBE7 bit:7	GPIO7 IRQ de-bounce configuration. Value 1 = de-bounce enabled, 0 = de-bounce disabled.
GIDBE8 reg:26:24 bit:8	GPIO8 IRQ de-bounce configuration. Value 1 = de-bounce enabled, 0 = de-bounce disabled.
- reg:26:24 bits:31-9	Bits marked '-' are reserved and should be written as zero.

7.2.39.11 Sub-Register 0x26:28 – GPIO_RAW

ID	Length (octets)	Type	Mnemonic	Description
26:28	4	RO	GPIO_RAW	GPIO raw state

Register file: [0x26 – GPIO control and status](#), sub-register 0x28 allows the raw state of the GPIO pin to be read. The GPIO_RAW register contains a bit for each GPIO pin as follows:

REG:26:28 – GPIO_RAW – GPIO raw state																																
31	30	29	28	27	26	25	24	23	22	21	20	19	18	17	16	15	14	13	12	11	10	9	8	7	6	5	4	3	2	1	0	
-	-	-	-	-	-	-	-	-	-	-	-	-	-	-	-	-	-	-	-	-	-	-	GRAWP8	GRAWP7	GRAWP6	GRAWP5	GRAWP4	GRAWP3	GRAWP2	GRAWP1	GRAWP0	
-	-	-	-	-	-	-	-	-	-	-	-	-	-	-	-	-	-	-	-	-	-	-	0	0	0	0	0	0	0	0	0	0

The bits of the GPIO_IDBE register identified above are individually described below:

Field	Description of fields within Sub-Register 0x26:28 – GPIO_RAW
GRAWP0 reg:26:28 bit:0	This bit reflects the raw state of GPIO0.
GRAWP1 bit:1	GPIO1 port raw state.
GRAWP2 bit:2	GPIO2 port raw state.
GRAWP3 bit:3	GPIO3 port raw state.
GRAWP4 bit:4	GPIO4 port raw state.
GRAWP5 bit:5	GPIO5 port raw state.
GRAWP6 bit:6	GPIO6 port raw state.
GRAWP7 bit:7	GPIO7 port raw state.
GRAWP8 reg:26:28 bit:8	GPIO8 port raw state.
- reg:26:28 bits:31–9	Bits marked '-' are reserved and should be written as zero.

7.2.40 Register file: 0x27 – Digital receiver configuration

ID	Length (octets)	Type	Mnemonic	Description
0x27	-	-	DRX_CONF	Digital Receiver Configuration

[Register map](#) register file 0x27 is concerned with the low-level digital receiver configuration. It contains a number of sub-registers. An overview of these is given by Table 26. Each of these sub-registers is separately described in the sub-sections below.

Table 26: Register file: 0x27 – Digital receiver configuration overview

OFFSET in Register 0x27	Mnemonic	Description
0x02	DRX_TUNE0b	Digital Tuning Register 0b

OFFSET in Register 0x27	Mnemonic	Description
0x04	DRX_TUNE1a	Digital Tuning Register 1a
0x06	DRX_TUNE1b	Digital Tuning Register 1b
0x08	DRX_TUNE2	Digital Tuning Register 2
0x20	DRX_SFDTOC	SFD timeout
0x24	DRX_PRETOC	Preamble detection timeout
0x26	DRX_TUNE4H	Digital Tuning Register 4H

7.2.40.1 Sub-Register 0x27:00 – DRX_RES1

ID	Length (octets)	Type	Mnemonic	Description
27:00	2	-	-	Reserved

Register file: [0x27 – Digital receiver configuration](#), sub-register 0x00 is a reserved area. Please take care not to write to this register as doing so may cause the DW1000 to malfunction.

7.2.40.2 Sub-Register 0x27:02 – DRX_TUNE0b

ID	Length (octets)	Type	Mnemonic	Description
27:02	2	RW	DRX_TUNE0b	Digital Tuning Register 0b

Register file: [0x27 – Digital receiver configuration](#), sub-register 0x02 is a 16-bit tuning register. For optimal performance the value here needs to change depending on the data rate and depending on whether the SFD sequence is configured to be the IEEE 802.15.4 UWB standard compliant SFD sequence, or the higher performing non-standard SFD configuration. The values needed are given in Table 27 below. Please take care not to write other values to this register as doing so may cause the DW1000 to malfunction.

Table 27: Sub-Register 0x27:02 – DRX_TUNE0b values

Data Rate	SFD configuration	Value to program to Sub-Register 0x27:02 – DRX_TUNE0b
110 kbps	Standard SFD	0x000A
	Non-Standard SFD	0x0016
850 kbps	Standard SFD	0x0001
	Non-Standard SFD	0x0006
6.8 Mbps	Standard SFD	0x0001
	Non-Standard SFD	0x0002

Note: Please refer to [Table 19: Recommended SFD sequence configurations for best performance](#) for details of the optimum selection of SFD sequence.

7.2.40.3 Sub-Register 0x27:04 – DRX_TUNE1a

ID	Length (octets)	Type	Mnemonic	Description
27:04	2	RW	DRX_TUNE1a	Digital Tuning Register 1a

Register file: [0x27 – Digital receiver configuration](#), sub-register 0x04 is a 16-bit tuning register. The value here needs to change depending on the RXPRF configuration. The values needed are given in Table 28 below. Please take care not to write other values to this register as doing so may cause the DW1000 to malfunction.

Table 28: Sub-Register 0x27:04 – DRX_TUNE1a values

RXPRF configuration	Value to program to Sub-Register 0x27:04 – DRX_TUNE1a
(1) = 16 MHz PRF	0x0087
(2) = 64 MHz PRF	0x008D

7.2.40.4 Sub-Register 0x27:06 – DRX_TUNE1b

ID	Length (octets)	Type	Mnemonic	Description
27:06	2	RW	DRX_TUNE1b	Digital Tuning Register 1b

Register file: [0x27 – Digital receiver configuration](#), sub-register 0x06 is a 16-bit tuning register. The value here needs to change depending on use case. The values needed are given in Table 29 below. Please take care not to write other values to this register as doing so may cause the DW1000 to malfunction.

Table 29: Sub-Register 0x27:06 – DRX_TUNE1b values

Use case	Value to program to Sub-Register 0x27:06 – DRX_TUNE1b
Preamble lengths > 1024 symbols, for 110 kbps operation	0x0064
Preamble lengths 128 to 1024 symbols, for 850 kbps and 6.8 Mbps operation	0x0020
Preamble length = 64 symbols, for 6.8 Mbps operation	0x0010

7.2.40.5 Sub-Register 0x27:08 – DRX_TUNE2

ID	Length (octets)	Type	Mnemonic	Description
27:08	4	RW	DRX_TUNE2	Digital Tuning Register 2

Register file: [0x27 – Digital receiver configuration](#), sub-register 0x08 is a tuning register. The value here needs to change depending on a number of parameters. The values needed are given in Table 30 below. Please take care not to write other values to this register as doing so may cause the DW1000 to malfunction.

Table 30: Sub-Register 0x27:08 – DRX_TUNE2 values

PAC size (selected here)	RXPRF configuration	Value to program to Sub-Register 0x27:08 – DRX_TUNE2
8	16 MHz PRF	0x311A002D
	64 MHz PRF	0x313B006B
16	16 MHz PRF	0x331A0052
	64 MHz PRF	0x333B00BE
32	16 MHz PRF	0x351A009A
	64 MHz PRF	0x353B015E
64	16 MHz PRF	0x371A011D
	64 MHz PRF	0x373B0296

Note: This is selecting the PAC size, (via bits 26 & 25 of the values in Table 30).

The PAC size should be selected depending on the expected preamble length in the receiver. For details of PAC size and its role please refer to section [4.1.1 – Preamble Detection](#) where Table 5 gives the recommend PAC size configuration for each preamble length.

7.2.40.6 Sub-Register 0x27:0C – DRX_RES2

ID	Length (octets)	Type	Mnemonic	Description
27:0C	20	-	-	Reserved

Register file: [0x27 – Digital receiver configuration](#), from offset 0x0C to offset 0x1F inclusive is a reserved area. Please take care not to write to this area as doing so may cause the DW1000 to malfunction.

7.2.40.7 Sub-Register 0x27:20 – DRX_SFDT0C

ID	Length	Type	Mnemonic	Description
----	--------	------	----------	-------------

	(octets)			
27:20	2	RW	DRX_SFDTOC	SFD detection timeout count

Register file: [0x27 – Digital receiver configuration](#), sub-register 0x20 is used to set the 16-bit SFD detection timeout counter period, in units of preamble symbols. The SFD detection timeout starts running as soon as preamble is detected. If the SFD sequence is not detected before the timeout period expires then the timeout will act to abort the reception currently in progress, and set RXSFDT0 event status bit in Register file: [0x0F – System Event Status Register](#). SFD timeout events are also counted in [Sub-Register 0x2F:10 – SFD Timeout Error Counter](#), assuming that counting is enabled by the EVC_EN bit in [Sub-Register 0x2F:00 – Event Counter Control](#).

The purpose of the SFD detection timeout is to recover from the occasional false preamble detection events that occur. By default this value is 4096+64+1 symbols, which is just longer the longest possible preamble and SFD sequence. This is the maximum value that is sensible. When it is known that a shorter preamble is being used then the DRX_SFDTOC value can be reduced appropriately.

WARNING: Please do NOT set DRX_SFDTOC to zero (disabling SFD detection timeout) since this risks IC malfunction due to prolonged receiver activity in the event of false preamble detection.

7.2.40.8 Sub-Register 0x27:22 – DRX_RES3

ID	Length (octets)	Type	Mnemonic	Description
27:22	2	-	-	Reserved

Register file: [0x27 – Digital receiver configuration](#), sub-register 0x22 is a reserved area. Please take care not to write to this register as doing so may cause the DW1000 to malfunction.

7.2.40.9 Sub-Register 0x27:24 – DRX_PRETOC

ID	Length (octets)	Type	Mnemonic	Description
27:24	2	RW	DRX_PRETOC	Preamble detection timeout count

Register file: [0x27 – Digital receiver configuration](#), sub-register 0x24 is used to set the 16-bit preamble detection timeout period, in units of PAC size symbols. The default/reset value is zero which disables the preamble detection timeout. The preamble detection timeout starts running as soon as the receiver is enabled to hunt for preamble. In the case of delayed receive (as commanded using the RXDLYE control in [Register file: 0x0D – System Control Register](#)) the preamble detection timeout starts after the delay when the receiver actually turns on to hunt for preamble. If a preamble sequence is not detected before the timeout period expires then the timeout will act to abort the reception currently in progress, and set the RXPTO event status bit in [Register file: 0x0F – System Event Status Register](#).

In cases where a response is expected at a particular time, this timeout can be used to flag that the expected response is not starting on time and hence to turn off the receiver earlier than would otherwise be the case,

(i.e. if just employing the frame wait timeout). This can give a good power saving, in situations of sending a message and awaiting a response that often does not come.

The DRX_PRETOC is programmed in units of PAC size, which can be 8, 16, 32 or 64 symbols. Table 56 gives the preamble symbol lengths. The PAC size is set in *Sub-Register 0x27:08 – DRX_TUNE2*. As this is a 16-bit counter the maximum preamble detection timeout possible is $65535 \times (PAC\ size)$, a period of over 500 ms for the smallest PAC size. A value of zero disables the preamble detection timeout.

Example: Supposing our preamble length is 1024 symbols and the PAC size is set to 32 (in line with Table 5) and, we send a message and know that the response (if present) will come after exactly 30 ms (because the responder is using delayed send to begin the response exactly 30 ms after receiving our message). We can command a 30 ms delayed receive (timed from our message transmission time) and have DRX_PRETOC programmed to a value of 32, which is the preamble length (1024) divided by the PAC size (32).

7.2.40.10 Sub-Register 0x27:26 – DRX_TUNE4H

ID	Length (octets)	Type	Mnemonic	Description
27:26	2	RW	DRX_TUNE4H	Digital Tuning Register

Register file: *0x27 – Digital receiver configuration*, sub-register 0x26 is a 16-bit tuning register. The value here needs to change depending on the preamble length expected by the receiver. The values required are given in Table 31. Please take care not to write other values to this register as doing so may cause the DW1000 to malfunction.

Table 31: Register 0x27:26 DRX_TUNE4H values

Expected Receive Preamble Length in Symbols	Value to program to Sub-Register 0x27:26 – DRX_TUNE4H
64	0x0010
128 or greater	0x0028

7.2.41 Register file: 0x28 – Analog RF configuration block

ID	Length (octets)	Type	Mnemonic	Description
0x28	-	-	RF_CONF	Analog RF Configuration

Register map register file 0x28 is concerned with the low-level configuration of the IC analog blocks. It contains a number of sub-registers. An overview of these is given by Table 32. Each of these sub-registers is separately described in the sub-sections below.

Table 32: Register file: 0x28 – Analog RF configuration block overview

OFFSET in Register 0x28	Mnemonic	Description
0x00	RF_CONF	RF Configuration Register
0x04	RF_RES1	Reserved area 1
0x0B	RF_RXCTRLH	Analog RX Control Register
0x0C	RF_TXCTRL	Analog TX Control Register
0x10	RF_RES2	Reserved area 2
0x2C	RF_STATUS	RF Status Register
0x30	RF_RES3	Reserved area 3

7.2.41.1 Sub-Register 0x28:00 – RF_CONF

ID	Length (octets)	Type	Mnemonic	Description
28:00	4	RW	RF_CONF	RF Configuration Register

Register file: 0x28 – Analog RF configuration block, sub-register 0x00 is a 32-bit configuration register for the transceiver. Please take care not to write other values to the reserved area of this register as doing so may cause the DW1000 to malfunction.

REG:28:00 – RF_CONF – RF Configuration Register																																
31	30	29	28	27	26	25	24	23	22	21	20	19	18	17	16	15	14	13	12	11	10	9	8	7	6	5	4	3	2	1	0	
-										TXRXSW	LDOFEN						PLL	FEN	-													
0	0	0	0	0	0	0	0	0	0	0	0	0	0	0	0	0	0	0	0	0	0	0	0	0	0	0	0	0	0	0	0	0

Definition of the bit fields within Sub-Register 0x28:00 – RF_CONF

Field	Description of fields within Sub-Register 0x28:00 – RF_CONF
Reserved reg:28:00 bits:31:23,7:0	These fields are reserved, and should not be set to 1 (may be overwritten with 0).
TXFEN reg:28:00 bits:12:8	Transmit block force enable. Write 0x0f to force all TX blocks on. Enabling this field will be used for certain test and calibration modes where we want to force the transmitter on when there are not packets being TX'd (i.e. Continuous Wave mode).
PLLFEN reg:28:00 bits:15:13	PLL block force enables. Write 0xA to enable the CLK_PLL or 0xE to enable both the CLK_PLL and RF PLL. Enabling this field will be used for certain test and calibration modes where we want to force the PLLs on when there are not packets being TX'd (i.e. Continuous Wave mode).

Field	Description of fields within Sub-Register 0x28:00 – RF_CONF
LDOFEN reg:28:00 bits:20:16	Write 0x1F to force the enable to all LDO's. Enabling this field will be used for certain test and calibration modes where we want to force the LDOs on when there are not packets being TX'd (i.e. Continuous Wave mode).
TXRXSW reg:28:00 bits:22:21	Force the TX/RX switch. To configure for TX the value written should be set to 0x2, and to configure for RX the value should be set to 0x1.

7.2.41.2 Sub-Register 0x28:04 – RF_RES1

ID	Length (octets)	Type	Mnemonic	Description
28:04	7	RW	RF_RES1	Reserved area 1

Register file: [0x28 – Analog RF configuration block](#), sub-register 0x04 is a reserved register. Please take care not to write to this register as doing so may cause the DW1000 to malfunction.

Note that calibration programming steps may require writes to this register.

7.2.41.3 Sub-Register 0x28:0B– RF_RXCTRLH

ID	Length (octets)	Type	Mnemonic	Description
28:0B	1	RW	RF_RXCTRLH	Analog RX Control Register

Register file: [0x28 – Analog RF configuration block](#), sub-register 0x0B is an 8-bit control register for the receiver. The value here needs to be set depending on the RX channel selected by the RX_CHAN configuration in [Register file: 0x1F – Channel Control](#). The values required are given in Table 33. Please take care not to write other values to this register as doing so may cause the DW1000 to malfunction.

Table 33: Sub-Register 0x28:0B– RF_RXCTRLH values

RX Channel	8-bit value to program to Sub-Register 0x28:0B– RF_RXCTRLH
1, 2, 3, or 5	0xD8
4 or 7	0xBC

7.2.41.4 Sub-Register 0x28:0C– RF_TXCTRL

ID	Length (octets)	Type	Mnemonic	Description
28:0C	4	RW	RF_TXCTRL	Analog TX Control Register

Register file: [0x28 – Analog RF configuration block](#), sub-register 0x0C is a 32-bit control register for the transmitter. The value here needs to be set depending on the TX channel selected by the TX_CHAN configuration in [Register file: 0x1F – Channel Control](#). The values required are given in Table 34. Please take care not to write other values to this register as doing so may cause the DW1000 to malfunction.

Table 34: Sub-Register 0x28:0C– RF_TXCTRL values

TX Channel	32-bit value to program to Sub-Register 0x28:0C– RF_TXCTRL
1	0x00005C40
2	0x00045CA0
3	0x00086CC0
4	0x00045C80
5	0x001E3FE0
7	0x001E7DE0

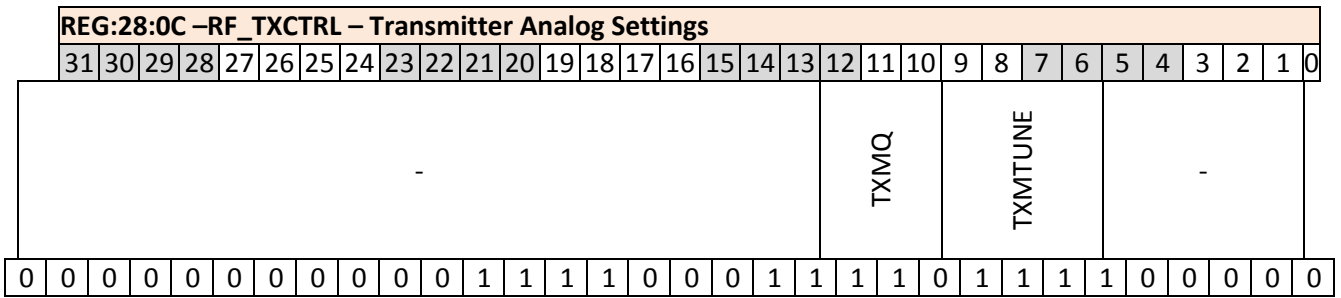

Definition of the bit fields within Sub-Register 0x28:0C– RF_TXCTRL:

Field	Description of fields within Sub-Register 0x28:0C– RF_TXCTRL
Reserved reg:28:0C bits:31:12,4:0	These fields are reserved. Program only as directed in Table 34.
TXMTUNE reg:28:0C bits:8:5	Transmit mixer tuning register. This register should be set as directed in Table 34. It is possible to tune to optimise performance for individual part as described in section 8.2.2 – Other TX adjustments to consider .
TXMQ reg:28:0C bits:11:9	Transmit mixer Q-factor tuning register. This register should be set as directed in Table 34. It is possible to tune to optimise performance for individual part as described in section 8.2.2 – Other TX adjustments to consider .

7.2.41.5 Sub-Register 0x28:10 – RF_RES2

ID	Length (octets)	Type	Mnemonic	Description
28:10	16	RW	RF_RES2	Reserved area 2

Register file: [0x28 – Analog RF configuration block](#), sub-register 0x10 is a reserved register. Please take care not to write to this register as doing so may cause the DW1000 to malfunction.

7.2.41.6 Sub-Register 0x28:2C – RF_STATUS

ID	Length (octets)	Type	Mnemonic	Description
28:2C	4	RO	RF_STATUS	RF Status Register

Register file: [0x28 – Analog RF configuration block](#), sub-register 0x2C is the PLL lock status register. Generally it is not necessary to monitor this register. However it may be useful as a diagnostic in the event of problems. The RF_STATUS register contains the following status bits identified and described below:

REG:28:2C – RF_STATUS – RF Status Register																																
31	30	29	28	27	26	25	24	23	22	21	20	19	18	17	16	15	14	13	12	11	10	9	8	7	6	5	4	3	2	1	0	
																									-	-	-	-	RFPLLLOCK	CPLLHIGH	CPLLLOW	CPLLLOCK
																									0	0	0	0	0	0	0	0

The bits of the RF_STATUS register identified above are individually described below:

Field	Description of fields within Sub-Register 0x28:2C – RF_STATUS
CPLLLOCK reg:28:2C bit:0	Clock PLL Lock status. This is a READ ONLY status flag. CPLLLOCK indicates that the digital clock PLL is locked. Note that this lock detect flag may not be reliable and is only used for debug purposes.
CPLLLOW reg:28:2C bit:1	Clock PLL Low flag status bit. This indicates PLL is running a little lower than its target frequency, which may be an early indication of lock issues.
CPLLHIGH reg:28:2C bit:2	Clock PLL High flag status bit. This indicates PLL is running a little higher than its target frequency, which may be an early indication of lock issues.
RFPLLLOCK reg:28:2C bit:3	RF PLL Lock status. This is a READ ONLY status flag. CPLLLOCK indicates that the RF PLL is locked. Note that this lock detect flag may not be reliable and is only used for debug purposes.
- reg:28:2C bits:31-4	Reserved. The remainder of this register is reserved.

7.2.41.7 Sub-Register 0x28:30 – RF_RES3

ID	Length (octets)	Type	Mnemonic	Description
28:30	4	RW	RF_RES3	Reserved area 3

Register file: [0x28 – Analog RF configuration block](#), sub-register 0x30 is a reserved register. Please take care not to write to this register as doing so may cause the DW1000 to malfunction.

7.2.42 Register file: 0x29 – Reserved

ID	Length (octets)	Type	Mnemonic	Description
0x29	-	-	-	Reserved – this register file is reserved

Register file: [0x29 – Reserved](#) is reserved. Please take care not to write to this register as doing so may cause the DW1000 to malfunction.

7.2.43 Register file: 0x2A – Transmitter Calibration block

ID	Length (octets)	Type	Mnemonic	Description
0x2A	-	-	TX_CAL	Transmitter calibration block

Register map register file 0x2A is the transmit calibration block concerned with ensuring the optimum configuration of the transmit signal. It contains a number of sub-registers. An overview of these is given by Table 35. Each of these sub-registers is separately described in the sub-sections below.

Table 35: Register file: 0x2A – Transmitter Calibration block overview

OFFSET in Register 0x2A	Mnemonic	Description
0x00	TC_SARC	Transmitter Calibration – SAR control
0x03	TC_SARL	Transmitter Calibration – Latest SAR readings
0x06	TC_SARW	Transmitter Calibration – SAR readings at last Wake-Up
0x08	TC_RES2	Transmitter Calibration – Reserved area 2
0x0B	TC_PGDELAY	Transmitter Calibration – Pulse Generator Delay
0x0C	TC_PGTEST	Transmitter Calibration – Pulse Generator Test

7.2.43.1 Sub-Register 0x2A:00 – TC_SARC

ID	Length (octets)	Type	Mnemonic	Description
2A:00	2	RW	TC_SARC	Transmitter Calibration - SAR control

Register file: [0x2A – Transmitter Calibration block](#), sub-register 0x00, contains the following bitmapped sub-fields:

REG:2A:00 – TC_SARC – Transmitter Calibration SAR control																																														
31	30	29	28	27	26	25	24	23	22	21	20	19	18	17	16	15	14	13	12	11	10	9	8	7	6	5	4	3	2	1	0															
																-	-	-	-	-	-	-	-	-	-	-	-	-	-	-	-	-	-	-	-	-	-	-	-	-	-	-	-	-	-	-
																0	0	0	0	0	0	0	0	0	0	0	0	0	0	0	0	0	0	0	0	0	0	0	0	0	0	0	0	0	0	0

Definition of the bit fields within Sub-Register 0x2A:00 – TC_SARC:

Field	Description of fields within Sub-Register 0x2A:00 – TC_SARC
SAR_CTRL reg:2A:00 bit:0	Writing 1 sets SAR enable and writing 0 clears the enable. The enable should set for a minimum of 2.5 μ s to allow the SAR time to complete its reading.
- reg:2A:00 bits:15–1	Bits marked '-' in register 0x2A:00 are reserved and should always be written as zero to avoid any malfunction of the DW1000.

7.2.43.2 Sub-Register 0x2A:03 – TC_SARL

ID	Length (octets)	Type	Mnemonic	Description
2A:03	3	RO	TC_SARL	Transmitter Calibration –Latest SAR readings

Register file: [0x2A – Transmitter Calibration block](#), sub-register 0x03, contains the following bitmapped sub-fields:

REG:2A:03 – TC_SARL – Transmitter Calibration Latest SAR readings																																				
31	30	29	28	27	26	25	24	23	22	21	20	19	18	17	16	15	14	13	12	11	10	9	8	7	6	5	4	3	2	1	0					
								-	-	-	-	-	-	-	-	SAR_LTEMP								SAR_LVBAT												
								0	0	0	0	0	0	0	0	0	0	0	0	0	0	0	0	0	0	0	0	0	0	0	0	0	0	0	0	0

Definition of the bit fields within Sub-Register 0x2A:03 – TC_SARL:

Field	Description of fields within Sub-Register 0x2A:03 – TC_SARL
SAR_LVBAT reg:2A:03 bits:7–0	<p>Latest SAR reading for Voltage level. The 8-bit value reported here is the voltage reading, from the last time the SAR A/D was used to sample the battery voltage monitor output. The LSB is approximately 6 mV. The value can be converted to an actual voltage by employing the formula:</p> $\text{Voltage (volts)} = (\text{SAR_LVBAT} - (\text{OTP_READ}(V_{\text{meas}} @ 3.3 \text{ V})) / 173) + 3.3$ <p>This uses the stored 3.3 V reading in the OTP that was recorded during production test. The effective range of measurement is 2.25 V to 3.76 V. For more details please refer to For more details please refer to section 6.4 – Measuring IC temperature and voltage.</p>
SAR_LTEMP reg:2A:03 bits:15–8	<p>Latest SAR reading for Temperature level. The 8-bit value reported here is the temperature reading from the SAR A/D sampling of the DW1000 internal temperature sensor. The LSB is approximately 0.8 °C. The value can be converted to an actual voltage by employing the formula:</p> $\text{Temperature (°C)} = (\text{SAR_LTEMP} - (\text{OTP_READ}(V_{\text{temp}} @ 23^\circ\text{C})) \times 1.14) + 23$ <p>This uses the stored 23°C reading in the OTP that was recorded during production test. For additional details please refer to section 6.4 – Measuring IC temperature and voltage.</p>
- reg:2A:03 bits:23–16	<p>Bits marked '-' in register 0x2A:03 are reserved and should always be written as zero to avoid any malfunction of the DW1000.</p>

7.2.43.3 Sub-Register 0x2A:06 – TC_SARW

ID	Length (octets)	Type	Mnemonic	Description
2A:06	2	RO	TC_SARW	Transmitter Calibration – SAR readings at last Wake-Up

Register file: [0x2A – Transmitter Calibration block](#), sub-register 0x06, is a 16-bit status register that contains the following bitmapped sub-fields:

REG:2A:06 – TC_SARW – Transmitter Calibration SAR readings at last Wake-Up																															
31	30	29	28	27	26	25	24	23	22	21	20	19	18	17	16	15	14	13	12	11	10	9	8	7	6	5	4	3	2	1	0
														SAR_WTEMP				SAR_WVBAT													
														0	0	0	0	0	0	0	0	0	0	0	0	0	0	0	0	0	

Definition of the bit fields within Sub-Register 0x2A:06 – TC_SARW:

Field	Description of fields within Sub-Register 0x2A:06 – TC_SARW
SAR_WBAT reg:2A:06 bits:7–0	<p>SAR reading of Voltage level taken at last wakeup event. The 8-bit value reported here is the voltage reading from the SAR A/D sampling of the battery voltage monitor output during wakeup. For this to be valid the DW1000 has to have been reset or woken from sleeping with the ONW_RADC bit enabled in the (saved) Sub-Register 0x2C:00 – AON_WCFG.</p>

Field	Description of fields within Sub-Register 0x2A:06 – TC_SARW
SAR_WTEMP reg:2A:06 bits:15– 8	SAR reading of temperature level taken at last wakeup event. The 8-bit value reported here is the temperature reading from the SAR A/D sampling of the DW1000 internal temperature sensor during wakeup. For this to be valid the DW1000 has to have been reset or woken from sleep with the ONW_RADC bit enabled in the (saved) Sub-Register 0x2C:00 – AON_WCFG .

7.2.43.4 Sub-Register 0x2A:0B – TC_PGDELAY

ID	Length (octets)	Type	Mnemonic	Description
2A:0B	1	RW	TC_PGDELAY	Transmitter Calibration –Pulse Generator Delay

Register file: [0x2A – Transmitter Calibration block](#), sub-register 0x0B is an 8-bit configuration register for setting the Pulse Generator Delay value. This effectively sets the width of transmitted pulses effectively setting the output bandwidth. The value used here depends on the TX channel selected by the TX_CHAN configuration in Register file: [0x1F – Channel Control](#). Recommended values are given in Table 36 below; note however that these values may need to be tuned for spectral regulation compliance depending on external circuitry.

Table 36: Sub-Register 0x2A:0B – TC_PGDELAY recommended values

TX Channel	8-bit value to program to Sub-Register 0x2A:0B – TC_PGDELAY
1	0xC9
2	0xC2
3	0xC5
4	0x95
5	0xC0
7	0x93

7.2.43.5 Sub-Register 0x2A:0C – TC_PGTEST

ID	Length (octets)	Type	Mnemonic	Description
2A:0C	1	RW	TC_PGTEST	Transmitter Calibration –Pulse Generator Test

Register file: [0x2A – Transmitter Calibration block](#), sub-register 0x0B is an 8-bit configuration register for use in setting the transmitter into continuous wave (CW) mode. This CW mode is employed during the crystal trimming operation which may be done at module manufacturing stage as part of calibrating the crystal oscillator’s operating frequency. At all other times, for normal operation, the value in this register should be left in its default power on value of 0x00.

Table 37: Sub-Register 0x2A:0C – TC_PGTEST values

MODE	8-bit value to program to Sub-Register 0x2A:0C – TC_PGTEST
Normal operation	0x00
Continuous Wave (CW) Test Mode	0x13

For more details of crystal trimming please refer to section [8.1 – IC Calibration – Crystal Oscillator Trim](#).

7.2.44 Register file: 0x2B – Frequency synthesiser control block

ID	Length (octets)	Type	Mnemonic	Description
0x2B	-	-	FS_CTRL	Frequency synthesiser control block

[Register map](#) register file 0x2B is the frequency synthesiser control block. Its main functionality is the generation of the carrier frequency necessary for the operating channel. It contains a number of sub-registers. An overview of these is given by Table 38. Each of these sub-registers is separately described in the sub-sections below.

Table 38: Register file: 0x2B – Frequency synthesiser control block overview

OFFSET in Register 0x2B	Mnemonic	Description
0x00	FS_RES1	Frequency synthesiser – Reserved area 1
0x07	FS_PLLCFG	Frequency synthesiser – PLL configuration
0x0B	FS_PLLTUNE	Frequency synthesiser – PLL Tuning
0x0C	FS_RES2	Frequency synthesiser – Reserved area 2
0x0E	FS_XTALT	Frequency synthesiser – Crystal trim
0x0F	FS_RES3	Frequency synthesiser – Reserved area 3

7.2.44.1 Sub-Register 0x2B:00 – FS_RES1

ID	Length (octets)	Type	Mnemonic	Description
2B:00	7	RW	FS_RES1	Frequency synthesiser – Reserved area 1

[Register file: 0x2B – Frequency synthesiser control block](#), sub-register 0x00 is a reserved register. Please take care not to write to this area as doing so may cause the DW1000 to malfunction.

7.2.44.2 Sub-Register 0x2B:07 – FS_PLLCFG

ID	Length (octets)	Type	Mnemonic	Description
2B:07	4	RW	FS_PLLCFG	Frequency synthesiser – PLL configuration

Register file: [0x2B – Frequency synthesiser control block](#), sub-register 0x07 is the PLL configuration register. The value here needs to be set depending on the channel being used, (i.e. depending on the RX_CHAN and TX_CHAN configuration in [Register file: 0x1F – Channel Control](#)). The values required are given in Table 39. Please take care not to write other values to this register as doing so may cause the DW1000 to malfunction.

Table 39: Sub-Register 0x2B:07 – FS_PLLCFG values

Operating Channel	32-bit value to program to Sub-Register 0x2B:07 – FS_PLLCFG
1	0x09000407
2,4	0x08400508
3	0x08401009
5, 7	0x0800041D

7.2.44.3 Sub-Register 0x2B:0B – FS_PLLTUNE

ID	Length (octets)	Type	Mnemonic	Description
2B:0B	1	RW	FS_PLLTUNE	Frequency synthesiser – PLL Tuning

Register file: [0x2B – Frequency synthesiser control block](#), sub-register 0x0B is a PLL tuning register. The value here needs to be set depending on the channel being used, (i.e. depending on the RX_CHAN and TX_CHAN configuration in [Register file: 0x1F – Channel Control](#)). The values required are given in Table 40. Please take care not to write other values to this register as doing so may cause the DW1000 to malfunction.

Table 40: Sub-Register 0x2B:0B – FS_PLLTUNE values

Operating Channel	8-bit value to program to Sub-Register 0x2B:0B – FS_PLLTUNE
1	0x1E
2,4	0x26
3	0x5E
5,7	0xA6

7.2.44.4 Sub-Register 0x2B:0C – FS_RES2

ID	Length (octets)	Type	Mnemonic	Description
2B:0C	2	RW	FS_RES2	Frequency synthesiser – Reserved area 2

Register file: [0x2B – Frequency synthesiser control block](#), sub-register 0x0C is a reserved area. Please take care not to write to this area as doing so may cause the DW1000 to malfunction.

7.2.44.5 Sub-Register 0x2B:0E – FS_XTALT

ID	Length (octets)	Type	Mnemonic	Description
2B:0E	1	RW	FS_XTALT	Frequency synthesiser – Crystal trim

Register file: [0x2B – Frequency synthesiser control block](#), sub-register 0x0E is the crystal trim register. This allows a fine control over the crystal oscillator to tune the DW1000 operating frequencies quite precisely. For details of the use of this register please refer to section [8.1 – IC Calibration – Crystal Oscillator Trim](#).

N.B.: Bits 7:5 must always be set to binary “011”. Failure to maintain this value will result in DW1000 malfunction.

REG:2B:0E – FS_XTALT – Crystal Trim Setting							
7	6	5	4	3	2	1	0
Reserved			XTALT				
0	1	1	0	0	0	0	0

The bits of the FS_XTALT register identified above are individually described below:

Field	Description of fields within Sub-Register 0x2B:0E – FS_XTALT
RESERVED reg:2B:0E bit:7:5	This field is reserved. N.B.: Any change in the value of this field will cause the DW1000 to malfunction.
XTALT reg:28:2C bit:1	Crystal Trim. Crystals may be trimmed using this register setting to tune out errors, see 8.1 – IC Calibration – Crystal Oscillator Trim .

7.2.44.6 Sub-Register 0x2B:0F – FS_RES3

ID	Length (octets)	Type	Mnemonic	Description
2B:0F	6	RW	FS_RES3	Frequency synthesiser – Reserved area 3

Register file: [0x2B – Frequency synthesiser control block](#), sub-register 0x0F is a reserved area. Please take care not to write to this area as doing so may cause the DW1000 to malfunction.

7.2.45 Register file: 0x2C – Always-on system control interface

ID	Length (octets)	Type	Mnemonic	Description
0x2C	-	-	AON	Always on system control interface block

[Register map](#) register file 0x2C is the Always-On system control block, (AON).

The AON block contains a low-power configuration array that remains powered-up as long as power (from the battery, for example) is supplied to the DW1000 via the VDDAON pin. User configurations, from SPI accessible host interface registers, can be automatically saved in the AON memory when the DW1000 enters **SLEEP** or **DEEPSLEEP** states and automatically restored from the AON memory when the DW1000 wakes from sleeping. Additional discussion of these modes may be found in section [2.4.1 – SLEEP and DEEPSLEEP](#).

This [Register file: 0x2C – Always-on system control interface](#) controls the functions that remain on when the IC enters its low-power **SLEEP** or **DEEPSLEEP** states, and configures the activities the DW1000 should take as the IC wakes from these sleep states. It contains a number of sub-registers. An overview of these is given by Table 41. Each of these sub-registers is separately described in the sub-sections below.

Table 41: Register file: 0x2C – Always-on system control overview

OFFSET in Register 0x2C	Mnemonic	Description
0x00	AON_WCFG	AON Wakeup Configuration Register
0x02	AON_CTRL	AON Control Register
0x03	AON_RDAT	AON Direct Access Read Data Result
0x04	AON_ADDR	AON Direct Access Address
0x05	-	reserved
0x06	AON_CFG0	AON Configuration Register 0
0x0A	AON_CFG1	AON Configuration Register 1

7.2.45.1 Sub-Register 0x2C:00 – AON_WCFG

ID	Length (octets)	Type	Mnemonic	Description
2C:00	2	RW	AON_WCFG	AON Wakeup Configuration Register

[Register file: 0x2C – Always-on system control](#), sub-register 0x00 is a 16-bit configuration register that is used to control what the DW1000 IC does as it wakes up from low-power **SLEEP** or **DEEPSLEEP** states. The AON_WCFG register contains the following bitmapped sub-fields:

REG:2C:00 – AON_WCFG – AON Wake-up Configuration register																																
31	30	29	28	27	26	25	24	23	22	21	20	19	18	17	16	15	14	13	12	11	10	9	8	7	6	5	4	3	2	1	0	
																			ONW_LLDE				PRES_SLEEP	ONW_L64P	ONW_LDC			ONW_LEUI			ONW_RX	ONW_RADC

Definition of the bit fields within *Sub-Register 0x2C:00 – AON_WCFG*:

Field	Description of fields within Sub-Register 0x2C:00 – AON_WCFG
ONW_RADC reg:2C:00 bit:0	On Wake-up Run the (temperature and voltage) Analog-to-Digital Convertors. The DW1000 is equipped with 8-bit A/D convertors to sample the IC temperature and its input battery voltage. Setting this bit will cause the automatic initiation of temperature and input battery voltage measurements when the DW1000 wakes from SLEEP or DEEPSLEEP states. As a result the temperature is measured before the IC heats up (and so may be a good measure of the ambient temperature around the IC), and, the battery voltage is measured before any significant current drain occurs (which may be useful in checking battery health). The resultant temperature and voltage values are available in <i>Sub-Register 0x2A:06 – TC_SARW</i> . For more details of this functionality, please refer to section <i>6.4 – Measuring IC temperature and voltage</i> .
ONW_RX reg:2C:00 bit:1	On Wake-up turn on the Receiver. With this bit it is possible to make the IC transition into RX automatically as part of IC wake up. One of the uses for this is to implement a scheme we call <i>Low-Power Listening</i> . See section <i>4.4 – Low-Power Listening</i> for more details.
- reg:2C:00 bits:[various]	Bits marked '-' in register 0x2C:00 are reserved and should always be written as zero to avoid any malfunction of the DW1000.
ONW_LEUI reg:2C:00 bit:3	On Wake-up load the EUI from OTP memory into <i>Register file: 0x01 –Extended Unique Identifier</i> . When this bit is set to 1 the EUI value programmed into OTP memory will be loaded into the <i>Register file: 0x01 –Extended Unique Identifier</i> when the DW1000 wakes-up from SLEEP or DEEPSLEEP .
ONW_LDC reg:2C:00 bit:6	On Wake-up load configurations from the AON memory into the host interface register set. When the ONW_LDC bit is set to 1 the values of user configuration registers are restored to their pre-sleep configuration values. When the ONW_LDC bit is 0 the values of user configuration registers revert to their power-on-reset value when the DW1000 wakes-up from SLEEP or DEEPSLEEP .
ONW_L64P reg:2C:00 bit:7	On Wake-up load the <i>Length64</i> receiver operating parameter set. When the ONW_L64Pbit is set to 1 the <i>Length64</i> receiver operating parameter set is selected when the DW1000 wakes from SLEEP or DEEPSLEEP or is reset. When the ONW_L64Pbit is 0 the receiver operating parameter set reverts to its power-on-reset value (the default operating parameter set) when the DW1000 wakes from SLEEP or DEEPSLEEP or is reset. For details of receiver operating parameter set see section <i>7.2.46.8 – Receiver operating parameter sets</i> . NB: This bit needs to be clear for reset to select the default operating parameter set.

Field	Description of fields within Sub-Register 0x2C:00 – AON_WCFG
PRES_SLEEP reg:2C:00 bit:8	Preserve Sleep. This bit determines what the DW1000 does with respect to the ARXSLP and ATXSLP sleep controls in Sub-Register 0x36:04 – PMSC_CTRL1 after a wake-up event. When the PRES_SLEEP bit is set to 1 these sleep controls are not cleared upon wakeup, so that the DW1000 can return to sleep after a failed reception (say). This needs to be set for correct operation of call <i>Low-Power Listening</i> . See section 4.4 – Low-Power Listening for more details of the required configurations.
ONW_LLDE reg:2C:00 bit:11	On Wake-up load the LDE microcode. The LDE algorithm is implemented in a microcode that is stored in a special ROM area on the DW1000 but run from a RAM area. Before the LDE is run the DW1000 has to copy it from ROM to RAM. The LDE algorithm is responsible for generating an accurate RX timestamp and calculating some signal quality statistics related to the received packet. See Register file: 0x2E – Leading Edge Detection Interface for more details about the LDE functionality. If the DW1000 is waking up to receive a frame and it is important to timestamp this received frame then the ONW_LLDE bit should be set to 1 to cause the LDE to be loaded into RAM. If time-stamping is not required then ONW_LLDE bit may be left set to 0 to save this loading and save some energy in the process.

7.2.45.2 Sub-Register 0x2C:02 – AON_CTRL

ID	Length (octets)	Type	Mnemonic	Description
2C:02	1	RW	AON_CTRL	AON Control Register

[Register file: 0x2C – Always-on system control](#), sub-register 0x02 is an 8-bit control register. The bits in this register in general cause direct activity within the AON block with respect to the stored AON memory. The bits then act like commands that are processed by the DW1000 and the bits are automatically cleared as the activity is taken.

The AON_CTRL register contains the following control bits:

REG:2C:02 – AON_CTRL – AON Control Register																																
31	30	29	28	27	26	25	24	23	22	21	20	19	18	17	16	15	14	13	12	11	10	9	8	7	6	5	4	3	2	1	0	
																									DCA_ENAB	-	-	-	DCA_READ	UPL_CFG	SAVE	RESTORE
																									0	0	0	0	0	0	0	0

Definition of the bit fields within Sub-Register 0x2C:02 – AON_CTRL:

Field	Description of fields within Sub-Register 0x2C:02 – AON_CTRL
RESTORE reg:2C:02 bit:0	When this bit is set the DW1000 will copy the user configurations from the AON memory to the host interface register set. The RESTORE bit will auto clear when this command is executed.

Field	Description of fields within Sub-Register 0x2C:02 – AON_CTRL
SAVE reg:2C:02 bit:1	When this bit is set the DW1000 will copy the user configurations from the host interface register set into the AON memory. It will then proceed to upload the AON block configurations. The SAVE bit will auto clear when this command is executed.
UPL_CFG reg:2C:02 bit:2	Upload the AON block configurations to the AON. This control will copy the AON configurations of the two registers: <i>Sub-Register 0x2C:06 – AON_CFG0</i> and <i>Sub-Register 0x2C:0A – AON_CFG1</i> into the AON configuration registers. This may be done for instance to enter SLEEP mode after correctly configuring it in those two registers, although SLEEP may be automatically entered under certain conditions by appropriate configurations within <i>Register file: 0x36 – Power Management and System Control</i> . If the UPL_CFG is being set for a purpose other than going to sleep then needs to be explicitly cleared immediately after use as it is not self-clearing.
DCA_READ reg:2C:02 bit:3	Direct AON memory access read. When this bit is set, (and direct access is enabled via the DCA_ENAB bit below), it commands a direct read of the low-power configuration array store memory. The address to read from is specified in <i>Sub-Register 0x2C:04 – AON_ADDR</i> and the resultant read data is presented in <i>Sub-Register 0x2C:03 – AON_RDAT</i> . This access is needed to retrieve the result of a calibration measurement on the low-power oscillator, see LPOSC_CAL bit in <i>Sub-Register 0x2C:0A – AON_CFG1</i> .
– reg:2C:02 bits:6–4	Bits marked ‘-’ in register 0x2C:02 are reserved and should always be written as zero to avoid any malfunction of the DW1000.
DCA_ENAB reg:2C:02 bit:7	Direct AON memory access enable bit. This bit needs to be set to 1 to enable the DCA_READ above to operate. Note: DCA_ENAB must to be reset to 0 to allow the automatic saving/restoring of user configurations to/from the AON memory, as needed for correct operation during entry and exit from SLEEP and DEEPSLEEP modes.

Table 42: Configurations maintained in the AON Memory Array

Configuration Register	Configuration Register
<i>Register file: 0x03 – PAN Identifier and Short Address</i>	<i>Sub-Register 0x28:0B– RF_RXCTRLH</i>
<i>Register file: 0x04 – System Configuration</i>	<i>Sub-Register 0x28:0C– RF_TXCTRL</i>
<i>Register file: 0x08 – Transmit Frame Control²</i>	<i>Sub-Register 2A:0B – TC_PGDELAY</i>
<i>Register file: 0x0E – System Event Mask Register</i>	<i>Sub-Register 0x2B:07 – FS_PLLCFG</i>
<i>Register file: 0x1D – SNIFF Mode³</i>	<i>Sub-Register 0x2B:0E – FS_XTALT</i>
<i>Register file: 0x1E – Transmit Power Control</i>	<i>Sub-Register 0x2C:00 – AON_WCFG</i>
<i>Register file: 0x1F – Channel Control</i>	<i>Sub-Register 0x2C:06 – AON_CFG0</i>
<i>Register file: 0x21 – User defined SFD sequence⁴</i>	<i>Sub-Register 0x2C:0A – AON_CFG1</i>
<i>Sub-Register 0x23:04 – AGC_TUNE1</i>	<i>Sub-Register 0x2E:1804 – LDE_RXANTD⁵</i>
<i>Sub-Register 0x23:04 – AGC_TUNE1</i>	<i>Sub-Register 0x2E:1806– LDE_CFG2</i>
<i>Sub-Register 0x23:12 – AGC_TUNE3</i>	<i>Sub-Register 0x2E:2804 – LDE_REPC</i>
<i>Sub-Register 0x26:00 – GPIO_MODE</i>	<i>Sub-Register 0x36:00 – PMSC_CTRL0⁶</i>
<i>Register file: 0x27 – Digital receiver configuration</i>	<i>Sub-Register 0x36:04 – PMSC_CTRL1⁷</i>
	<i>Sub-Register 0x36:0C – PMSC_SNOZT</i>
	<i>Sub-Register 0x36:28 – PMSC_LEDC⁸</i>

² Only the Low 32-bits are maintained.

³ All bits are maintained except for bit 0. Bit zero it is lost and restored as 0.

⁴ Only the SFD_LENGTH field in the first octet is maintained.

⁵ The TX antenna delay in *Register file: 0x18 – Transmitter Antenna Delay* is not preserved, but instead ends up corrupted by part of the preserved RX antenna delay. After a wake-up then for correct TX time stamping The TX antenna delay will need reprogramming.

⁶ Bits preserved are: 23, 15, 12, 11 and 6. The remainder revert to their reset value during wake-up init.

⁷ All preserved except for the KHZCLKDIV field which revert to its reset value during wake-up init.

⁸ Just the BLNKEN bit is preserved, the BLINK_TIM field reverts to its reset value during wake-up init.

7.2.45.3 Sub-Register 0x2C:03 – AON_RDAT

ID	Length (octets)	Type	Mnemonic	Description
2C:03	1	RW	AON_RDAT	AON Direct Access Read Data Result

Register file: [0x2C – Always-on system control](#), sub-register 0x03 is an 8-bit register used to return the result of a direct access read of a location in the AON memory array. The location to read from is specified by [Sub-Register 0x2C:04 – AON_ADDR](#) and the read is initiated using the DCA_READ control bit in [Sub-Register 0x2C:02 – AON_CTRL](#).

7.2.45.4 Reading from a specified address within AON memory

Figure 27 shows the procedural flow for reading from specified address in AON memory:

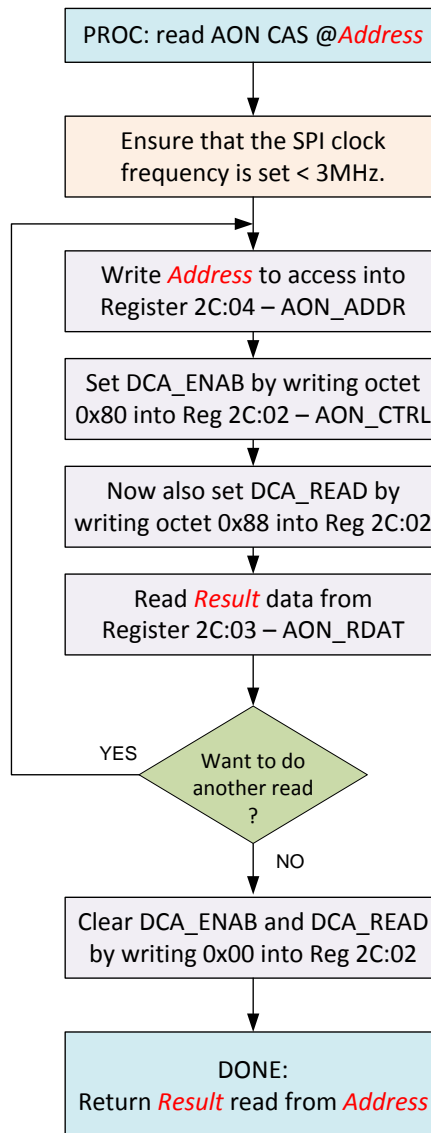

Figure 27: Flow chart for direct read of AON address

7.2.45.5 Sub-Register 0x2C:04 – AON_ADDR

ID	Length (octets)	Type	Mnemonic	Description
2C:04	1	RW	AON_ADDR	AON Direct Access Address

Register file: [0x2C – Always-on system control](#), sub-register 0x04 is an 8-bit register used to specify the address for a direct access read of the AON memory array. The read is initiated using the DCA_READ control bit in [Sub-Register 0x2C:02 – AON_CTRL](#) and the read result is returned in [Sub-Register 0x2C:03 – AON_RDAT](#).

7.2.45.6 Sub-Register 0x2C:05 – AON_RES1

ID	Length (octets)	Type	Mnemonic	Description
2C:05	1	RW	AON_RES1	AON Reserved area 1

Register file: [0x2C – Always-on system control](#), sub-register 0x05 is reserved.

7.2.45.7 Sub-Register 0x2C:06 – AON_CFG0

ID	Length (octets)	Type	Mnemonic	Description
2C:06	4	RW	AON_CFG0	AON Configuration Register 0

Register file: [0x2C – Always-on system control](#), sub-register 0x06 is a 32-bit configuration register for the always on block. The fields of this register are interpreted inside the AON block, which can only happen after these are loaded into the AON block via the UPL_CFG command in [Sub-Register 0x2C:02 – AON_CTRL](#). The AON_CFG0 register contains the following fields:

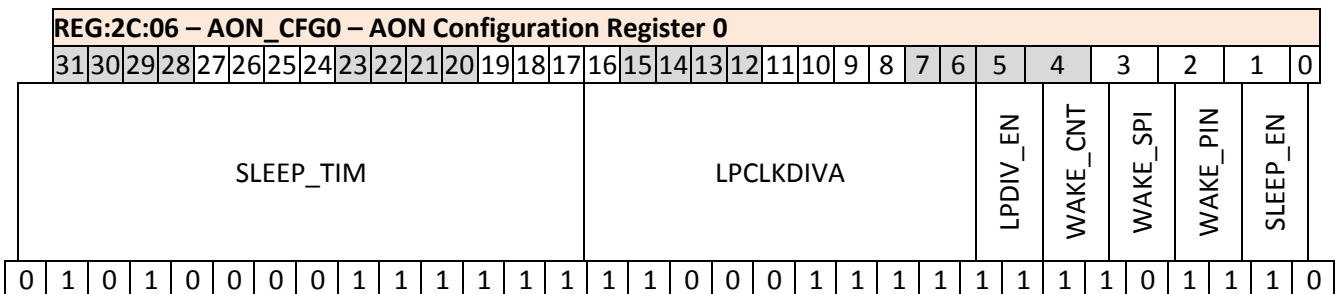

The fields of the AON_CFG0 register identified above are individually described below:

Field	Description of fields within Sub-Register 0x2C:06 – AON_CFG0
SLEEP_EN reg:2C:06 bit:0	This is the sleep enable configuration bit. In order to put the DW1000 into the SLEEP state this bit needs to be set and then the configuration needs to be uploaded to the AON using the UPL_CFG bit in <i>Sub-Register 0x2C:02 – AON_CTRL</i> . The SLEEP state can also be entered via the ATXSLP or ARXSLP controls in <i>Sub-Register 0x36:04 – PMSC_CTRL1</i> , which will automatically do the configuration upload to the AON and set this SLEEP_EN control.
WAKE_PIN reg:2C:06 bit:1	Wake using WAKEUP pin. This configuration bit enables the WAKEUP line to bring the DW1000 out of SLEEP or DEEPSLEEP states into operational mode. By default the WAKE_PIN configuration is 1 enabling the WAKEUP line as a wake-up signal. Setting the WAKE_PIN configuration bit to 0 will mean that the WAKEUP line cannot wake the DW1000 from SLEEP or DEEPSLEEP . See NOTE below on wakeup events.
WAKE_SPI reg:2C:06 bit:2	Wake using SPI access. This configuration bit enables SPICSn to bring the DW1000 out of SLEEP or DEEPSLEEP into operational mode. By default the WAKE_SPI configuration is 1 enabling the SPICSn input as a wake-up signal. Setting the WAKE_SPI configuration bit to 0 will mean that SPICSn cannot wake the DW1000 from SLEEP or DEEPSLEEP . See NOTE below on wakeup events.
WAKE_CNT reg:2C:06 bit:3	Wake when sleep counter elapses. This configuration bit enables the sleep counter to bring the DW1000 out of SLEEP into operational mode. By default the WAKE_CNT configuration is 1 enabling the sleep counter as a wake-up signal. Setting the WAKE_CNT configuration bit to 0 will mean that the sleep counter cannot wake the DW1000 from SLEEP . See NOTE below on wakeup events.
LPDIV_EN reg:2C:06 bit:4	Low power divider enable configuration. This bit enables a low power clock divider, that allows an alternative source of clock for the sleep time counter. When LPDIV_EN is 0 the sleep time counter counts cycles of the low powered ring oscillator. When LPDIV_EN is 1 the sleep time counter counts cycles of the LP Clock. See LPCLKDIVA below for details of this. NOTE: While the LP Clock is more accurate than the low powered ring oscillator, it is thousands of times more power hungry and, for this reason there are few applications that will use this.
LPCLKDIVA reg:2C:06 bits:15–5	This field specifies a divider count for dividing the raw DW1000 XTAL oscillator frequency to set an LP clock frequency. This LP clock and LPCLKDIVA functionality is only enabled when the LPDIV_EN configuration bit is set to 1. The raw 38.4 MHz XTAL oscillator frequency input to the LP clock divider is pre-divided by 2 to give a 19.2 MHz internal clock called XTI. The LPCLKDIVA field is 11-bits allowing divisors up to 2047 or LP clock frequencies down to 9.4 kHz. An LPCLKDIVA value of 0 or 1 gives an LP clock frequency being the raw XTI frequency of 19.2 MHz.
SLEEP_TIM reg:2C:06 bits:31–16	Sleep time. This field configures the sleep time count elapse value. The units of SLEEP_TIM depend on which timer is running. When the low powered oscillator is running the units are dependent on the oscillating frequency of the IC's internal RING oscillator, which is between approximately 7,000 and 13,000 Hz depending on process variations within the IC. This frequency can be measured using the LPOSC_CAL (low-power oscillator calibration) control bit in <i>Sub-Register 0x2C:0A – AON_CFG1</i> so that sleep times can be more accurately set. If the LPDIV_EN is set to 1 then the sleep time counter counts cycles of the LP Clock as set by the LPCLKDIVA above. Note while this is a more accurate clock it is not recommended for general sleeping as this has a much higher power consumption than the ring oscillator based sleep. The SLEEP_TIM field is 16 bits wide, but represents the upper 16 bits of a 28-bit counter, i.e. the low order bit is equal to 4096 counts. So, for example, if the ring oscillator frequency is 9500 Hz then programming the SLEEP_TIM with a value of 24 would yield a sleep time of $24 \times 4096 \div 9500$, which is approximately 10.35 seconds.

NOTE: There are three mechanisms to wake the DW1000: using the **WAKEUP** line when the WAKE_PIN configuration is 1, using SPICSn when the WAKE_SPI configuration is 1, and using the sleep timer when the WAKE_CNT configuration is 1 and the sleep counter is enabled via the SLEEP_CEN bit in [Sub-Register 0x2C:0A – AON_CFG1](#). If none of these wakeup mechanisms are enabled and the DW1000 is put into **DEEPSLEEP** mode then there will be no way to take the IC out of sleep except by removing power at the VDDAON pin, (and short it to 0 volts to hasten the power down of the IC).

7.2.45.8 Sub-Register 0x2C:0A – AON_CFG1

ID	Length (octets)	Type	Mnemonic	Description
2C:0A	2	RW	AON_CFG1	AON Configuration Register 1

Register file: [0x2C – Always-on system control](#), sub-register 0x0A is a 16-bit configuration register for parameters within the always-on (AON) block. The fields of this register are interpreted inside the AON block, and this can only happen after the register is loaded into the AON block via the UPL_CFG command in [Sub-Register 0x2C:02 – AON_CTRL](#). The AON_CFG1 register contains the following fields:

REG:2C:0A – AON_CFG1 – AON Configuration Register 1																																
31	30	29	28	27	26	25	24	23	22	21	20	19	18	17	16	15	14	13	12	11	10	9	8	7	6	5	4	3	2	1	0	
																-	-	-	-	-	-	-	-	-	-	-	-	-	-	LPOSC_CAL	SMXX	SLEEP_CEN
																0	0	0	0	0	0	0	0	0	0	0	0	0	0	1	1	1

The fields of the AON_CFG1 register identified above are individually described below:

Field	Description of fields within Sub-Register 0x2C:0A – AON_CFG1
SLEEP_CEN reg:2C:0A bit:0	This bit enables the sleep counter. For correct operation of the sleep counter (down counter) when loading a new value into the SLEEP_TIM field of Sub-Register 0x2C:06 – AON_CFG0 it is recommended to set SLEEP_CEN to 0 before updating SLEEP_TIM. The recommended operating procedure is then as follows: <ul style="list-style-type: none"> (a) Set SLEEP_CEN (in AON_CFG1) to 0. (b) Set UPL_CFG (in AON_CTRL) to 1, to apply this to the AON block. (c) Program the new value of SLEEP_TIM (in AON_CFG0). (d) Set SLEEP_CEN to 1. (e) Set UPL_CFG to 1, to apply the new sleep time and enable the counter in the AON.
SMXX reg:2C:0A bit:1	This bit needs to be set to 0 for correct operation in the SLEEP state within the DW1000. By default this bit is set to 1. The host system should set this bit to zero as part of initialisation or controlling the entry of the DW1000 into the SLEEP state to ensure correct operation of the SLEEP mode.
LPOSC_CAL reg:2C:0A bit:2	This bit enables the calibration function that measures the period of the IC’s internal low powered oscillator. The operating frequency of this oscillator depends on process variations within the IC and also on the operating voltage and temperature. It should lie somewhere between approximately 7,000 and 13,000 Hz. Using this LPOSC_CAL bit then it is possible

Field	Description of fields within Sub-Register 0x2C:0A – AON_CFG1
	<p>measure the period of the oscillation in counts of the IC’s internal XTAL_DIV2 clock, which runs at a frequency of 19.2 MHz. Using this information it is then possible to more accurately determine the value to set into the SLEEP_TIM field (of Sub-Register 0x2C:06 – AON_CFG0) for a particular desired sleep period.</p> <p>The recommended operating procedure for this is then using this is then is to:</p> <ul style="list-style-type: none"> (a) Ensure that the SPI operating frequency is set < 3MHz. (During procedure the system uses the 19.2 MHz XTI clock which will not support higher SPI data rates). (b) Set this LPOSC_CAL bit to 1, and upload it into the AON block by toggling the UPL_CFG bit (in AON_CTRL) to 1 and back to 0. (c) Clear the LPOSC_CAL bit to 0, and upload it into the AON block by toggling UPL_CFG (in AON_CTRL) to 1 and back to 0. (d) Force the system clock to be the 19.2 MHz XTI clock, by setting SYSCCLKS (in Sub-Register 0x36:00 – PMSC_CTRL0) to 01 (binary). (e) Wait for 400 µs to ensure a calibration count value is available. This is a 16-bit value counting how many clock periods of the 19.2 MHz XTI clock it took to complete one complete period of the low power ring oscillator. (f) The ring oscillator period counter’s 8 MSBs are accessed at AON memory address 118 decimal (0x76) and its 8 LSBs are accessed at AON memory address 117 decimal (0x75). Please refer to in section 7.2.45.4 - Reading from a specified address within AON memory for details of the procedure defined for reading AON memory. (g) After reading the period counter, restore the system clock automatic mode by setting the SYSCCLKS configuration back to 0. <p>The operating frequency of the ring oscillator is given by 19.2 MHz divided by the period counter value.</p>
– reg:2C:0A bits:15–3	Reserved bits

7.2.46 Register file: 0x2D – OTP Memory Interface

ID	Length (octets)	Type	Mnemonic	Description
0x2D	-	-	OTP_IF	One Time Programmable Memory Interface

[Register map](#) register file 0x2D is the OTP memory interface. This allows read access to parameters stored in the OTP memory, and it is also the interface via which parameters are programmed into the OTP memory. The OTP memory interface contains a number of sub-registers. An overview of these sub-registers is given by Table 43, and each is then separately described in the sub-sections below.

NOTE: Programming OTP memory is a one-time only activity, any values programmed in error cannot be corrected. Also, please take care when programming OTP memory to only write to the designated areas – programming elsewhere may permanently damage the DW1000’s ability to function normally.

For more details of the OTP memory please refer to section [6.3 – Using the on-chip OTP memory](#).

Table 43: Register file: 0x2D – OTP Memory Interface overview

OFFSET in Register 0x2D	Mnemonic	Description
0x00	OTP_WDAT	OTP Write Data
0x04	OTP_ADDR	OTP Address
0x06	OTP_CTRL	OTP Control
0x08	OTP_STAT	OTP Status
0x0A	OTP_RDAT	OTP Read Data
0x0E	OTP_SRDAT	OTP SR Read Data
0x12	OTP_SF	OTP Special Function

7.2.46.1 Sub-Register 0x2D:00 – OTP_WDAT

ID	Length (octets)	Type	Mnemonic	Description
2D:00	4	RW	OTP_WDAT	OTP Write Data

Register file: [0x2D – OTP Memory Interface](#), sub-register 0x00 is a 32-bit register. The data value to be programmed into an OTP location should be written here before invoking the programming function. Writing to OTP memory is an involved procedure. For details of this please refer to section [6.3.2 – Programming a value into OTP memory](#).

7.2.46.2 Sub-Register 0x2D:04 – OTP_ADDR

ID	Length (octets)	Type	Mnemonic	Description
2D:04	2	RW	OTP_ADDR	OTP Address

Register file: [0x2D – OTP Memory Interface](#), sub-register 0x04 is a 16-bit register used to select the address within the OTP memory block that is being accessed (for read or write) this OTP memory interface. The OTP_ADDR register contains the following fields:

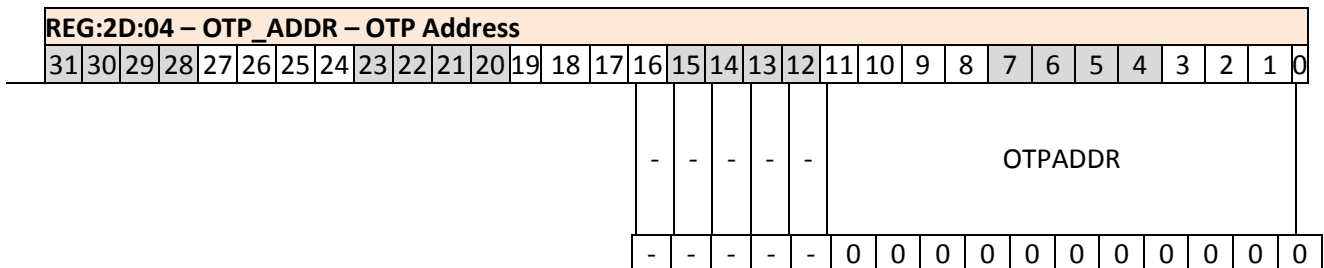

The fields of the OTP_ADDR register are described below:

Field	Description of fields within Sub-Register 0x2D:04 – OTP_ADDR
OTPADDR reg:2D:04 bits:10 –0	This 11-bit field specifies the address within OTP memory that will be accessed read or written. For details of the OTP memory map and the procedures to read and write OTP memory, please refer to section 6.3 – Using the on-chip OTP memory .
- reg:2D:04 bits:15 –11	Reserved. The remainder of this register is reserved.

7.2.46.3 Sub-Register 0x2D:06 – OTP_CTRL

ID	Length (octets)	Type	Mnemonic	Description
2D:06	2	RW	OTP_CTRL	OTP Control

Register file: [0x2D – OTP Memory Interface](#), sub-register 0x06 is a 16-bit register used to control the operation of the OTP memory through the process of reading and writing. The OTP_CTRL register contains the following fields:

REG:2D:06 – OTP_CTRL – OTP Control																																
31	30	29	28	27	26	25	24	23	22	21	20	19	18	17	16	15	14	13	12	11	10	9	8	7	6	5	4	3	2	1	0	
															LDELOAD	R	R	R	R													

The fields of the OTP_CTRL register are described below:

Field	Description of fields within Sub-Register 0x2D:06 – OTP_CTRL
R reg:2D:06 bit:various	Reserved bits. May be overwritten with their default value.
OTPRDEN reg:2D:06 bit:0	This bit forces the OTP into manual read mode. This bit must be set if using the OTPREAD bit to issue a read command.
OTPREAD reg:2D:06 bit:1	This bit commands a read operation from the address specified in the OTP_ADDR register, the value read will then be available in the OTP_RDAT register. This bit will automatically clear when the read operation is done. For details of the OTP memory map and the procedures to read and write OTP memory, please refer to section 6.3 – Using the on-chip OTP memory .

Field	Description of fields within Sub-Register 0x2D:06 – OTP_CTRL
OTPMRWR reg:2D:06 bit:3	OTP mode register write. This bit should be set to 1 then cleared when applying a new mode to the OTP. This bit is used to configure the initial circuits of the OTP block. They used during the programming of the OTP. For a description on how to drive these bits see the sample code in 6.3.2 Programming a value into OTP memory
OTPPROG reg:2D:06 bit:6	Setting this bit will cause the contents of OTP_WDAT to be written to OTP_ADDR. This bit should be cleared once the programming has completed as indicated by Sub-Register 0x2D:08 – OTP_STAT. For a description on how to drive these bits see the sample code in 6.3.2 Programming a value into OTP memory
OTPMR reg:2D:06 bit:10:7	OTP Mode register. These bits are used to configure the internal circuits of the OTP block. They are used during the programming of the OTP. For a description on how to drive these bits see the sample code in 6.3.2 Programming a value into OTP memory
LDELOAD reg:2D:06 bit:15	<p>This bit forces a load of LDE microcode. The LDE algorithm is responsible for generating an accurate RX timestamp and calculating some signal quality statistics related to the received packet. See Register file: 0x2E – Leading Edge Detection Interface for more details about the LDE functionality. The LDE algorithm is implemented in a microcode that is stored in a special ROM area on the DW1000 but run from a RAM area. After powering up the DW1000 (or after exiting SLEEP or DEEPSLEEP states) the LDE RAM is empty. Before the LDE is run the code has to be copied from ROM to RAM. This should be done before receiver is enabled if it is important to timestamp this received frame. Set LDELOAD to 1 to initiate the loading, it will automatically clear when the load is done. If the LDE code is not being loaded before the receiver is enabled then the LDERUNE (LDE run enable) control in Sub-Register 0x36:04 – PMSC_CTRL1 must be turned off (set to zero).</p> <p>When waking up from SLEEP or DEEPSLEEP to receive a frame, if the ONW_LLDE bit (in Sub-Register 0x2C:00 – AON_WCFG), has been configured to 1, then the LDE load will be done automatically as part of exiting the sleep state.</p>

7.2.46.4 Sub-Register 0x2D:08 – OTP_STAT

ID	Length (octets)	Type	Mnemonic	Description
2D:08	2	RW	OTP_STAT	OTP Status

[Register file: 0x2D – OTP Memory Interface](#), sub-register 0x08 is a 16-bit register used to give status information about the progress of the OTP programming activity. The OTP_STAT register contains the following fields:

REG:2D:08 – OTP_STAT – OTP Status																																	
31	30	29	28	27	26	25	24	23	22	21	20	19	18	17	16	15	14	13	12	11	10	9	8	7	6	5	4	3	2	1	0		
																															OTPVPK	OTPPRGD	
																-	-	-	-	-	-	-	-	-	-	-	-	-	-	-	-	0	0

The fields of the OTP_STAT register are described below:

Field	Description of fields within Sub-Register 0x2D:08 – OTP_STAT
OTPPRGD reg:2D:04 bit:0	OTP Programming Done. This status bit indicates that the programming of the 32-bit word from OTP_WDAT to the address specified by OTP_ADDR has completed. Writing to OTP memory is an involved procedure. For details of this please refer to section 6.3.2 – Programming a value into OTP memory .
OTPVPOK reg:2D:04 bit:1	OTP Programming Voltage OK. This status bit indicates that the VPP level is sufficient for programming the OTP memory. For details of OTP programming please refer to section 6.3 – Using the on-chip OTP memory .
- reg:2D:00 bits:various	Reserved. Bits marked '-' are reserved.

7.2.46.5 Sub-Register 0x2D:0A – OTP_RDAT

ID	Length (octets)	Type	Mnemonic	Description
2D:0A	4	R	OTP_RDAT	OTP Read Data

Register file: [0x2D – OTP Memory Interface](#), sub-register 0x0A is a 32-bit register. The data value read from an OTP location will appear here after invoking the OTP read function. For details of the OTP memory map and the procedures to read OTP memory, please refer to section [6.3 – Using the on-chip OTP memory](#).

7.2.46.6 Sub-Register 0x2D:0E – OTP_SRDAT

ID	Length (octets)	Type	Mnemonic	Description
2D:0E	4	RW	OTP_SRDAT	OTP Special Register Read Data

Register file: [0x2D – OTP Memory Interface](#), sub-register 0x0E is a 32-bit register. The data value stored in the OTP SR (0x400) location will appear here after power up. For details of the OTP memory map and the procedures to read OTP memory, please refer to section [6.3 – Using the on-chip OTP memory](#).

7.2.46.7 Sub-Register 0x2D:12 – OTP_SF

ID	Length (octets)	Type	Mnemonic	Description
2D:12	1	RW	OTP_SF	OTP Special Function

Register file: [0x2D – OTP Memory Interface](#), sub-register 0x12 is an 8-bit special function register used to select and load special receiver operational parameter sets. See [7.2.46.8 – Receiver operating parameter sets](#) for details. The OTP_SF register contains the following fields:

REG:2D:12 – OTP_SF – OTP Special Function																																
31	30	29	28	27	26	25	24	23	22	21	20	19	18	17	16	15	14	13	12	11	10	9	8	7	6	5	4	3	2	1	0	
																								-	OPS_SEL		-	-	-	-	OPS_KICK	
																								0	0	0	0	0	0	0	0	0

The fields of the OTP_SF register are described below:

Field	Description of fields within Sub-Register 0x2D:08 – OTP_STAT
OPS_KICK reg:2D:12 bit:0	This bit when set initiates a load of the operating parameter set selected by the OPS_SEL configuration below. (This control is in the OTP block because the parameter sets are in OTP memory during their development, only moving to ROM for the production IC).
OPS_SEL reg:2D:12 bits:6,5	Operating parameter set selection. This selects the operating parameter set to load when the OPS_KICK is invoked. Allowed values are: 00: Select parameter set 0 – <i>Length64</i> . 01: Select parameter set 1 – <i>Tight</i> . 10: Reserved. Do not select this value. 11: Reserved. Do not select this value. See section 7.2.46.8 – Receiver operating parameter sets below for details of use of these operating parameter sets.
- reg:2D:00 Other bits	Reserved. Bits marked '-' are reserved.

7.2.46.8 Receiver operating parameter sets

The DW1000 receiver has the capability of operating with specific parameter sets that relate to how it acquires the preamble signal and decodes the data. Three distinct operating parameter sets are defined within the IC for selection by the host system designer depending on system characteristics. Table 44 below lists and defines these operating parameter sets indicating their recommended usages.

Table 44: Receiver operating parameter sets

Set	Description
-----	-------------

Set	Description
Default	<p>This is the default operating parameter set. This parameter set is designed to work at all data rates and can tolerate crystal offsets of the order of ± 40ppm (e.g. 20ppm XTAL in transmitter and receiver) between the transmitter and receiver. It is however not optimum for the very short preamble.</p> <p>The default operating parameter set is selected upon device reset or exit of sleep modes, in both cases only when the ONW_L64Pbit (saved in 7.2.45.1 – Sub-Register 0x2C:00 – AON_WCFG) is 0, meaning do not loading an alternative parameter set.</p>
0 – Length64	<p>This operating parameter set is designed to give good performance for very short preambles, i.e. the length 64 preamble. However this performance optimization comes at a cost, which is that it cannot tolerate large crystal offsets. In order to use this operating parameter set the total clock offset from transmitter to receiver needs to be kept below ± 15ppm.</p> <p>This <i>length64</i> parameter set may be automatically loaded upon device reset or exit of sleep modes, when the ONW_L64P bit (saved in 7.2.45.1 – Sub-Register 0x2C:00 – AON_WCFG) is 1, and it may also be loaded under direct host control using the OPS_KICK and OPS_SEL controls in Sub-Register 0x2D:08 – OTP_STAT.</p>
1 – Tight	<p>This operating parameter set maximises the operating range of the system. However this performance optimization again comes at a cost, which is that the total crystal offset must be kept very tight, at or below about ± 1ppm. This might be done for example by using very high quality 0.5ppm TCXO in both the transmitter and the receiver. The <i>Tight</i> operating parameter can only be selected via direct host load control using the OPS_KICK and OPS_SEL controls in Sub-Register 0x2D:08 – OTP_STAT.</p>

For most applications the default operating parameter set is the best choice. The use of the other operating parameter sets may improve performance in particular use cases, but requires tighter control of clock frequencies across the network of devices that have to interwork.

7.2.47 Register file: 0x2E – Leading Edge Detection Interface

ID	Length (octets)	Type	Mnemonic	Description
0x2E	-	-	LDE_IF	Leading Edge Detection Interface

[Register map](#) register file 0x2E is the LDE control/status interface. The Leading Edge detection function is responsible for analysing the accumulator data,(available in [Register file: 0x25 – Accumulator CIR memory](#)), to find the first path and calculate the RX timestamp written to [Register file: 0x15 – Receive Time Stamp](#) and the diagnostic information written into [Register file: 0x12 – Rx Frame Quality Information](#). The LDE interface contains a number of sub-registers. An overview of these sub-registers is given by Table 45 and each is then separately described in the sub-sections below.

Table 45: Register file: 0x2E – Leading Edge Detection Interface overview

OFFSET in Register 0x2E	Mnemonic	Description
0x0000	LDE_THRESH	LDE Threshold report
0x0806	LDE_CFG1	LDE Configuration Register 1
0x1000	LDE_PPINDX	LDE Peak Path Index

OFFSET in Register 0x2E	Mnemonic	Description
0x1002	LDE_PPAMPL	LDE Peak Path Amplitude
0x1804	LDE_RXANTD	LDE Receive Antenna Delay configuration
0x1806	LDE_CFG2	LDE Configuration Register 2
0x2804	LDE_REPC	LDE Replica Coefficient configuration

PLEASE NOTE: Other areas within the address space of *Register file: 0x2E – Leading Edge Detection Interface* are reserved. To ensure proper operation of the LDE algorithm (i.e. to avoid loss of performance or a malfunction), care must be taken not to write to any byte locations other than those defined in the sub-sections below.

7.2.47.1 Sub-Register 0x2E:0000 – LDE_THRESH

ID	Length (octets)	Type	Mnemonic	Description
2E:0000	2	RO	LDE_THRESH	LDE Threshold report

Register file: *0x2E – Leading Edge Detection Interface*, sub-register 0x0000 is a 16-bit status register reporting the threshold that was used to find the first path. This threshold is calculated based on an estimate of the noise made during the LDE algorithm’s analysis of the accumulator data. This threshold report may be of diagnostic interest in certain circumstances.

7.2.47.2 Sub-Register 0x2E:0806 – LDE_CFG1

ID	Length (octets)	Type	Mnemonic	Description
2E:0806	1	RW	LDE_CFG1	LDE Configuration Register 1

Register file: *0x2E – Leading Edge Detection Interface*, sub-register 0x0806 is an 8-bit configuration register containing the following fields:

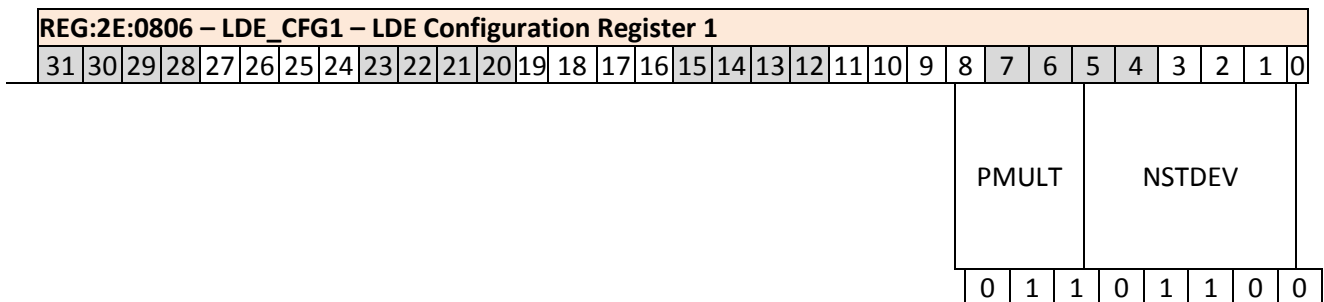

The fields of the LDE_CFG1 register are described below:

Field	Description of fields within Sub-Register 0x2E:0806 – LDE_CFG1
NSTDEV reg:2E:0806 bits:4–0	Number of Standard Deviations. This configures a number of standard deviations of estimated noise at which to set the threshold for the LDE algorithm’s first path search. By default NSTDEV is 12. This value was found to work well and give a reasonable compromise performance level between falsely triggering on noise peaks and missing real attenuated (non-line-of-sight) first paths. More recently an NSTDEV value of 13 has been used in our device driver software to give more accuracy in close-up LOS conditions. Where NLOS performance is more important to the application the default NSTDEV value of 12 might be a better choice.
PMULT reg:2E:0806 bits:7–5	Peak Multiplier. This sets a factor by which the peak value of estimated noise is increased in order to set the threshold for first path searching. By default this value is 3, giving a factor of 1.5, which has been found to work well.

NB: To avoid any malfunction please ensure to only write one octet into the LDE_CFG1 register.

7.2.47.3 Sub-Register 0x2E:1000 – LDE_PPINDX

ID	Length (octets)	Type	Mnemonic	Description
2E:1000	2	RO	LDE_PPINDX	LDE Peak Path Index

Register file: [0x2E – Leading Edge Detection Interface](#), sub-register 0x1000, is the LDE Peak Path Index (LDE_PPINDX) register. This is a 16-bit status register reporting the position within the accumulator that the LDE algorithm has determined to contain the maximum magnitude path. This value is set during the LDE algorithm’s analysis of the accumulator data. This value may be of diagnostic interest in certain circumstances. The magnitude of the value at this index is reported in [Sub-Register 0x2E:1002 – LDE_PPAMPL](#).

7.2.47.4 Sub-Register 0x2E:1002 – LDE_PPAMPL

ID	Length (octets)	Type	Mnemonic	Description
2E:1002	2	RO	LDE_PPAMPL	LDE Peak Path Amplitude

Register file: [0x2E – Leading Edge Detection Interface](#), sub-register 0x1002, is the LDE Peak Path Amplitude (LDE_PPAMPL) register. This is a 16-bit status register reporting the magnitude of the peak signal seen in the accumulator data memory during the LDE algorithm’s analysis, (the index at which this occurs is reported in [Sub-Register 0x2E:1000 – LDE_PPINDX](#)). This value may be of diagnostic interest in certain circumstances.

7.2.47.5 Sub-Register 0x2E:1804 – LDE_RXANTD

ID	Length (octets)	Type	Mnemonic	Description
2E:1804	2	RW	LDE_RXANTD	LDE Receive Antenna Delay configuration

[Register file: 0x2E – Leading Edge Detection Interface](#), sub-register 0x1804 is a 16-bit configuration register for setting the receive antenna delay. The receiver antenna delay is used to account for the delay between the arrival of the RMARKER (the start of the PHR) at the antenna and the time the RMARKER is detected and timestamped by the internal digital RX circuitry. The units here are the same as those used for system time and time stamps, i.e. $499.2 \text{ MHz} \times 128$, so the least significant bit about 15.65 picoseconds.

The value programmed in this LDE_RXANTD register value is subtracted (by the LDE algorithm) from the raw timestamp [RX_RAWST](#) to by the LDE algorithm which performs a number of other updates and adjustments(including detecting and accounting for the first path position in the accumulator) in order to generate the fully adjusted [RX_STAMP](#) value also in [Register file: 0x15 – Receive Time Stamp](#).

Please refer to section [8.3 – IC Calibration – Antenna Delay](#) for details of calibration of antenna delay.

7.2.47.6 Sub-Register 0x2E:1806– LDE_CFG2

ID	Length (octets)	Type	Mnemonic	Description
2E:1806	2	RW	LDE_CFG2	LDE Configuration Register 2

[Register file: 0x2E – Leading Edge Detection Interface](#), sub-register 0x1806 is a 16-bit LDE configuration tuning register. The value here needs to change depending on the RXPRF configuration. The values needed are given in Table 46 below. Please take care not to write other values to this register as doing so may cause the DW1000 to malfunction or function sub-optimally.

Table 46: Sub-Register 0x2E:1806– LDE_CFG2values

RXPRF configuration	Value to program to Sub-Register 0x2E:1806– LDE_CFG2
(1) = 16 MHz PRF	0x1607
(2) = 64 MHz PRF	0x0607

7.2.47.7 Sub-Register 0x2E:2804 – LDE_REPC

ID	Length (octets)	Type	Mnemonic	Description
2E:2804	2	RW	LDE_REPC	LDE Replica Coefficient configuration

[Register file: 0x2E – Leading Edge Detection Interface](#), sub-register 0x2804 is a 16-bit configuration register for setting the replica avoidance coefficient. The accumulator operates on the preamble sequence to give the channel impulse response. This works because of the perfect periodic auto-correlation property of the IEEE 802.15.4 UWB preamble sequences. Unfortunately the auto-correlation is so not perfect where there is a significant clock offset between the remote transmitter and the local receiver. In these circumstances small amplitude replicas of the channel impulse response appear repeatedly throughout the accumulator span. The magnitude of this effect is dependent on the clock offset and on the preamble code being employed. To avoid the LDE erroneously seeing one of these replica signals as the leading edge the

threshold used for detecting the first path is artificially raised by a factor depending on the measured clock offset. For optimum performance this factor also needs to be dependent on the preamble code selected in the receiver. To achieve this, the LDE_REPC configuration needs to be set depending on the receiver preamble code configuration. The values required are given in Table 47. These values apply to 850 kbps and 6.8 Mbps data rates only.

Table 47: Sub-Register 0x2E:2804 – LDE_REPC configurations for (850 kbps & 6.8 Mbps)

RX_PCODE ⁹ configuration	LDE_REPC value to set	RX_PCODE configuration	LDE_REPC value to set
1	0x5998	13	0x3AE0
2	0x5998	14	0x35C2
3	0x51EA	15	0x2B84
4	0x428E	16	0x35C2
5	0x451E	17	0x3332
6	0x2E14	18	0x35C2
7	0x8000	19	0x35C2
8	0x51EA	20	0x47AE
9	0x28F4	21	0x3AE0
10	0x3332	22	0x3850
11	0x3AE0	23	0x30A2
12	0x3D70	24	0x3850

NB: When operating at 110 kbps the unsigned values in Table 47 have to be divided by 8, (right shifted 3, shifting zeros into the high order bits), before programming into *Sub-Register 0x2E:2804 – LDE_REPC*.

7.2.48 Register file: 0x2F – Digital Diagnostics Interface

ID	Length (octets)	Type	Mnemonic	Description
0x2F	41	-	DIG_DIAG	Digital Diagnostics Interface

[Register map](#) register file 0x2F is the Digital Diagnostics interface. It contains a number of sub-registers that give diagnostics information. An overview of these is given by Table 48. Each of these sub-registers is separately described in the sub-sections below.

⁹RX_PCODE configuration is set Register file: 0x1F – Channel Control

Table 48: Register file: 0x2F – Digital Diagnostics Interface overview

OFFSET in Register 0x2F	Mnemonic	Description
0x00	EVC_CTRL	Event Counter Control
0x04	EVC_PHE	PHR Error Counter
0x06	EVC_RSE	RSD Error Counter
0x08	EVC_FCG	Frame Check Sequence Good Counter
0x0A	EVC_FCE	Frame Check Sequence Error Counter
0x0C	EVC_FFR	Frame Filter Rejection Counter
0x0E	EVC_OVR	RX Overrun Error Counter
0x10	EVC_STO	SFD Timeout Counter
0x12	EVC_PTO	Preamble Timeout Counter
0x14	EVC_FWTO	RX Frame Wait Timeout Counter
0x16	EVC_TXFS	TX Frame Sent Counter
0x18	EVC_HPW	Half Period Warning Counter
0x1A	EVC_TPW	Transmitter Power-Up Warning Counter
0x1C	EVC_RES1	Digital Diagnostics Reserved Area 1
0x24	DIAG_TMC	Test Mode Control Register

7.2.48.1 Sub-Register 0x2F:00 – Event Counter Control

ID	Length (octets)	Type	Mnemonic	Description
2F:00	4	RW	EVC_CTRL	Event Counter Control

Register file: 0x2F – Digital Diagnostics Interface, sub-register 0x00 is the event counter control register.

REG:2F:00 – EVC_CTRL – Event Counter Control																																	
31	30	29	28	27	26	25	24	23	22	21	20	19	18	17	16	15	14	13	12	11	10	9	8	7	6	5	4	3	2	1	0		
-	-	-	-	-	-	-	-	-	-	-	-	-	-	-	-	-	-	-	-	-	-	-	-	-	-	-	-	-	-	-	-	EVC_CLR	EVC_EN
-	-	-	-	-	-	-	-	-	-	-	-	-	-	-	-	-	-	-	-	-	-	-	-	-	-	-	-	-	-	-	0	0	

The bits of the EVC_CTRL register identified above are individually described below:

Field	Description of fields within Sub-Register 0x2F:00 – Event Counter Control
EVC_EN reg:2F:00 bit:0	Event Counters Enable. The EVC_EN bit acts to enable the event counters. When EVC_EN bit is zero none of the event counters will update. When EVC_EN bit is set to 1 it enables event counting. A number of sub-registers of Register file: 0x2F – Digital Diagnostics Interface, contain counters of various system events – see below for the detailed description of the parameters counted. If the host system has no interest in these event counters then a small amount of power is saved by not enabling event counting.

Field	Description of fields within Sub-Register 0x2F:00 – Event Counter Control
EVC_CLR reg:2F:00 bit:1	Event Counters Clear. The EVC_CLR bit acts to clear event counters to zero. This cannot be done while EVC_EN bit is set. The correct procedure to clear the event counters is to write 0x02 to <i>Sub-Register 0x2F:00 – Event Counter Control</i> to disable counting and clear the counter values to zero, and then to write 0x01 to <i>Sub-Register 0x2F:00 – Event Counter Control</i> to re-enable counting if required.
- reg:2F:00 bits:31–2	The remaining bits of <i>Sub-Register 0x2F:00 – Event Counter Control</i> are reserved and should always be set to zero to avoid any malfunction of the device.

7.2.48.2 Sub-Register 0x2F:04 – PHR Error Counter

ID	Length (octets)	Type	Mnemonic	Description
2F:04	2	RO	EVC_PHE	PHR Error Event Counter

Register file: [0x2F – Digital Diagnostics Interface](#), sub-register 0x04 is the PHY Header Error event counter.

REG:2F:04 – EVC_PHE – PHR Error Counter																															
31	30	29	28	27	26	25	24	23	22	21	20	19	18	17	16	15	14	13	12	11	10	9	8	7	6	5	4	3	2	1	0
												-	-	-	-	EVC_PHE															
												-	-	-	-	0															

The fields of the EVC_PHE register are described below:

Field	Description of fields within Sub-Register 0x2F:04 – PHR Error Counter
EVC_PHE reg:2F:04 bits:11–0	PHR Error Event Counter. The EVC_PHE field is a 12-bit counter of PHY Header Errors. This counts the reporting of RXPHE error events in <i>Register file: 0x0F – System Event Status Register</i> . NB: For this counter to be active, counting needs to be enabled by the setting the EVC_EN bit in <i>Sub-Register 0x2F:00 – Event Counter Control</i> .
- bits:15–12	The remaining bits of this register are reserved.

7.2.48.3 Sub-Register 0x2F:06 – RSD Error Counter

ID	Length (octets)	Type	Mnemonic	Description
2F:06	2	RO	EVC_RSE	RSD Error Event Counter

Register file: [0x2F – Digital Diagnostics Interface](#), sub-register 0x06 is the PHY Header Error event counter.

REG:2F:06 – EVC_RSE – RSD Error Counter																															
31	30	29	28	27	26	25	24	23	22	21	20	19	18	17	16	15	14	13	12	11	10	9	8	7	6	5	4	3	2	1	0
												-	-	-	-	EVC_RSE															
												-	-	-	-	0															

The fields of the EVC_RSE register are described below:

Field	Description of fields within Sub-Register 0x2F:06 – RSD Error Counter
EVC_RSE reg:2F:06 bits:11–0	Reed Solomon decoder (Frame Sync Loss) Error Event Counter. The EVC_RSE field is a 12-bit counter of the non-correctable error events that can occur during Reed Solomon decoding. This counts the reporting of RXRFSL error events in Register file: 0x0F – System Event Status Register . NB: For this counter to be active, counting needs to be enabled by the setting the EVC_EN bit in Sub-Register 0x2F:00 – Event Counter Control .
- bits:15–12	The remaining bits of this register are reserved.

7.2.48.4 Sub-Register 0x2F:08 – FCS Good Counter

ID	Length (octets)	Type	Mnemonic	Description
2F:08	2	RO	EVC_FCG	Frame Check Sequence Good Event Counter

Register file: [0x2F – Digital Diagnostics Interface](#), sub-register 0x08 is the FCS good event counter.

REG:2F:08 – EVC_FCG – Frame Check Sequence Good Event Counter																															
31	30	29	28	27	26	25	24	23	22	21	20	19	18	17	16	15	14	13	12	11	10	9	8	7	6	5	4	3	2	1	0
												-	-	-	-	EVC_FCG															
												-	-	-	-	0															

The bits of the EVC_FCG register are described below:

Field	Description of fields within Sub-Register 0x2F:08 – FCS Good Counter
EVC_FCG reg:2F:08 bits:11–0	Frame Check Sequence Good Event Counter. The EVC_FCG field is a 12-bit counter of the frames received with good CRC/FCS sequence. This counts the reporting of RXFCG events in Register file: 0x0F – System Event Status Register . NB: For this counter to be active, counting needs to be enabled by the setting the EVC_EN bit in Sub-Register 0x2F:00 – Event Counter Control .
- bits:15–12	The remaining bits of this register are reserved.

7.2.48.5 Sub-Register 0x2F:0A – FCS Error Counter

ID	Length (octets)	Type	Mnemonic	Description
2F:0A	2	RO	EVC_FCE	Frame Check Sequence Error Counter

Register file: [0x2F – Digital Diagnostics Interface](#), sub-register 0x0A is the FCS Error event counter.

REG:2F:0A – EVC_FCE – FCS Error Counter																															
31	30	29	28	27	26	25	24	23	22	21	20	19	18	17	16	15	14	13	12	11	10	9	8	7	6	5	4	3	2	1	0
												-	-	-	-	EVC_FCE															
												-	-	-	-	0															

The bits of the EVC_FCE register are described below:

Field	Description of fields within Sub-Register 0x2F:0A – FCS Error Counter
EVC_FCE reg:2F:0A bits:11–0	Frame Check Sequence Error Event Counter. The EVC_FCE field is a 12-bit counter of the frames received with bad CRC/FCS sequence. This counts the reporting of RXFCE events in Register file: 0x0F – System Event Status Register . NB: For this counter to be active, counting needs to be enabled by the setting the EVC_EN bit in Sub-Register 0x2F:00 – Event Counter Control .
- bits:15–12	The remaining bits of this register are reserved.

7.2.48.6 Sub-Register 0x2F:0C – Frame Filter Rejection Counter

ID	Length (octets)	Type	Mnemonic	Description
2F:0C	2	RO	EVC_FFR	Frame Filter Rejection Counter

Register file: [0x2F – Digital Diagnostics Interface](#), sub-register 0x0C is the Frame Filter Rejection counter.

REG:2F:0C – EVC_FFR – Frame Filter Rejection Counter																															
31	30	29	28	27	26	25	24	23	22	21	20	19	18	17	16	15	14	13	12	11	10	9	8	7	6	5	4	3	2	1	0
												EVC_FFR																			
												0																			

The bits of the EVC_FFR register are described below:

Field	Description of fields within Sub-Register 0x2F:0C – Frame Filter Rejection Counter
EVC_FFR reg:2F:0C bits:11–0	Frame Filter Rejection Event Counter. The EVC_FFR field is a 12-bit counter of the frames rejected by the receive frame filtering function. This is essentially a count of the reporting of AFFREJ events (in Register file: 0x0F – System Event Status Register). NB: For this counter to be active, counting needs to be enabled by the setting the EVC_EN bit in Sub-Register 0x2F:00 – Event Counter Control .
- bits:15–12	The remaining bits of this register are reserved.

7.2.48.7 Sub-Register 0x2F:0E – RX Overrun Error Counter

ID	Length (octets)	Type	Mnemonic	Description
2F:0E	2	RO	EVC_OVR	RX Overrun Error Counter

Register file: [0x2F – Digital Diagnostics Interface](#), sub-register 0x0E is the RX Overrun Error counter.

REG:2F:0E – EVC_OVR – RX Overrun Error Counter																															
31	30	29	28	27	26	25	24	23	22	21	20	19	18	17	16	15	14	13	12	11	10	9	8	7	6	5	4	3	2	1	0
												EVC_OVR																			
												0																			

The bits of the EVC_OVR register are described below:

Field	Description of fields within Sub-Register 0x2F:0C – Frame Filter Rejection Counter
EVC_OVR reg:2F:0E bits:11–0	RX Overrun Error Event Counter. The EVC_OVR field is a 12-bit counter of receive overrun events. This is essentially a count of the reporting of RXOVR events in Register file: 0x0F – System Event Status Register . The EVC_OVR will be incremented once for each RX frame discard that happens while an overrun condition persists. NB: For this counter to be active, counting needs to be enabled by the setting the EVC_EN bit in Sub-Register 0x2F:00 – Event Counter Control .
- bits:15–12	The remaining bits of this register are reserved.

7.2.48.8 Sub-Register 0x2F:10 – SFD Timeout Error Counter

ID	Length (octets)	Type	Mnemonic	Description
2F:10	2	RO	EVC_STO	SFD Timeout Error Counter

[Register file: 0x2F – Digital Diagnostics Interface](#), sub-register 0x10 is the SFD Timeout Error counter.

REG:2F:10 – EVC_STO – SFD Timeout Error Counter																															
31	30	29	28	27	26	25	24	23	22	21	20	19	18	17	16	15	14	13	12	11	10	9	8	7	6	5	4	3	2	1	0
												-	-	-	-	EVC_STO															
												-	-	-	-	0															

The bits of the EVC_STO register are described below:

Field	Description of fields within Sub-Register 0x2F:10 – SFD Timeout Error Counter
EVC_STO reg:2F:10 bits:11–0	SFD timeout errors Event Counter. The EVC_STO field is a 12-bit counter of SFD Timeout Error events. This is essentially a count of the reporting of RXSFDTO events in Register file: 0x0F – System Event Status Register . NB: For this counter to be active, counting needs to be enabled by the setting the EVC_EN bit in Sub-Register 0x2F:00 – Event Counter Control .
- bits:15–12	The remaining bits of this register are reserved.

7.2.48.9 Sub-Register 0x2F:12 – Preamble Detection Timeout Event Counter

ID	Length (octets)	Type	Mnemonic	Description
2F:12	2	RO	EVC_PTO	Preamble Detection Timeout Event Counter

[Register file: 0x2F – Digital Diagnostics Interface](#), sub-register 0x12 is the Preamble Timeout Event Counter.

REG:2F:12 – EVC_PTO – Preamble Detection Timeout Event Counter																															
31	30	29	28	27	26	25	24	23	22	21	20	19	18	17	16	15	14	13	12	11	10	9	8	7	6	5	4	3	2	1	0
												-	-	-	-	EVC_PTO															
												-	-	-	-	0															

The bits of the EVC_PTO register are described below:

Field	Description of fields within Sub-Register 0x2F:12 – Preamble Detection Timeout Event Counter
EVC_PTO reg:2F:12 bits:11–0	Preamble Detection Timeout Event Counter. The EVC_PTO field is a 12-bit counter of Preamble detection Timeout events. This is essentially a count of the reporting of RXPTO events, in Register file: 0x0F – System Event Status Register . NB: For this counter to be active, counting needs to be enabled by the setting the EVC_EN bit in Sub-Register 0x2F:00 – Event Counter Control .
- bits:15–12	The remaining bits of this register are reserved.

7.2.48.10 Sub-Register 0x2F:14 – RX Frame Wait Timeout Event Counter

ID	Length (octets)	Type	Mnemonic	Description
2F:14	2	RO	EVC_FWTO	RX Frame Wait Timeout Counter

[Register file: 0x2F – Digital Diagnostics Interface](#), sub-register 0x14 is the RX Frame Wait Timeout Event Counter.

REG:2F:14 – EVC_FWTO – RX Frame Wait Timeout Event Counter																															
31	30	29	28	27	26	25	24	23	22	21	20	19	18	17	16	15	14	13	12	11	10	9	8	7	6	5	4	3	2	1	0
																-	-	-	-	EVC_FWTO											
																-	-	-	-	0											

The bits of the EVC_FWTO register are described below:

Field	Description of fields within Sub-Register 0x2F:14 – RX Frame Wait Timeout Event Counter
EVC_FWTO reg:2F:14 bits:11–0	RX Frame Wait Timeout Event Counter. The EVC_FWTO field is a 12-bit counter of receive frame wait timeout events. This is essentially a count of the reporting of the RXRFTO events in Register file: 0x0F – System Event Status Register . NB: For this counter to be active, counting needs to be enabled by the setting the EVC_EN bit in Sub-Register 0x2F:00 – Event Counter Control .
- bits:15–12	The remaining bits of this register are reserved.

7.2.48.11 Sub-Register 0x2F:16 – TX Frame Sent Counter

ID	Length (octets)	Type	Mnemonic	Description
2F:16	2	RO	EVC_TXFS	TX Frame Sent Counter

[Register file: 0x2F – Digital Diagnostics Interface](#), sub-register 0x16 is the TX Frame Sent Counter.

REG:2F:16 – EVC_TXFS – TX Frame Sent Counter
--

31	30	29	28	27	26	25	24	23	22	21	20	19	18	17	16	15	14	13	12	11	10	9	8	7	6	5	4	3	2	1	0
																-	-	-	-	EVC_TXFS											
																-	-	-	-	0											

The bits of the EVC_TXFS register are described below:

Field	Description of fields within Sub-Register 0x2F:16 – TX Frame Sent Counter
EVC_TXFS reg:2F:16 bits:11–0	TX Frame Sent Event Counter. The EVC_TXFS field is a 12-bit counter of transmit frames sent. This is incremented every time a frame is sent. It is essentially a count of the reporting of the TXFRS events in Register file: 0x0F – System Event Status Register . NB: For this counter to be active, counting needs to be enabled by the setting the EVC_EN bit in Sub-Register 0x2F:00 – Event Counter Control .
- bits:15–12	The remaining bits of this register are reserved.

7.2.48.12 Sub-Register 0x2F:18 – Half Period Warning Counter

ID	Length (octets)	Type	Mnemonic	Description
2F:18	2	RO	EVC_HPW	Half Period Warning Counter

Register file: [0x2F – Digital Diagnostics Interface](#), sub-register 0x18 is the Half Period Warning Counter.

REG:2F:18 – EVC_HPW – Half Period Warning Counter																															
31	30	29	28	27	26	25	24	23	22	21	20	19	18	17	16	15	14	13	12	11	10	9	8	7	6	5	4	3	2	1	0
																-	-	-	-	EVC_HPW											
																-	-	-	-	0											

The bits of the EVC_HPW register are described below:

Field	Description of fields within Sub-Register 0x2F:18 – Half Period Warning Counter
EVC_HPW reg:2F:18 bits:11–0	Half Period Warning Event Counter. The EVC_HPW field is a 12-bit counter of “Half Period Warnings”. This is a count of the reporting of the HPDWARN events in Register file: 0x0F – System Event Status Register . These relate to late invocation of delayed transmission or reception functionality. Please refer to the description of the HPDWARN bit for more details of this event and its meaning. NB: For this counter to be active, counting needs to be enabled by the setting the EVC_EN bit in Sub-Register 0x2F:00 – Event Counter Control .
- bits:15–12	The remaining bits of this register are reserved.

7.2.48.13 Sub-Register 0x2F:1A – Transmitter Power-Up Warning Counter

ID	Length (octets)	Type	Mnemonic	Description
2F:1A	2	RO	EVC_TPW	Transmitter Power-Up Warning Counter

Register file: [0x2F – Digital Diagnostics Interface](#), sub-register 0x1A is the TX Power-Up Warning Counter.

REG:2F:1A – EVC_TPW – Transmitter Power-Up Warning Counter																															
31	30	29	28	27	26	25	24	23	22	21	20	19	18	17	16	15	14	13	12	11	10	9	8	7	6	5	4	3	2	1	0
																-	-	-	-	EVC_TPW											
																-	-	-	-	0											

The bits of the EVC_TPW register are described below:

Field	Description of fields within Sub-Register 0x2F:1A – Transmitter Power-Up Warning Counter
EVC_TPW reg:2F:1A bits:11–0	TX Power-Up Warning Event Counter. The EVC_TPW field is a 12-bit counter of “Transmitter Power-Up Warnings”. This is a count of the reporting of the TXPUTE events in Register file: 0x0F – System Event Status Register . These relate to a delayed sent time that is too short to allow proper power up of the TX blocks before the delayed transmission is due to start. Please refer to the description of the TXPUTE bit for more details of this event. NB: For this counter to be active, counting needs to be enabled by the setting the EVC_EN bit in Sub-Register 0x2F:00 – Event Counter Control .
- bits:15–12	The remaining bits of this register are reserved.

7.2.48.14 Sub-Register 0x2F:1C – EVC_RES1

ID	Length (octets)	Type	Mnemonic	Description
2F:1C	8	RW	EVC_RES1	Digital Diagnostics Reserved Area 1

Register file: [0x2F – Digital Diagnostics Interface](#), sub-register 0x1C is a reserved register. Please take care not to write to this register as doing so may cause the DW1000 to malfunction.

7.2.48.15 Sub-Register 0x2F:24 – Digital Diagnostics Test Mode Control

ID	Length (octets)	Type	Mnemonic	Description
2F:24	2	RW	DIAG_TMC	Test Mode Control Register

Register file: [0x2F – Digital Diagnostics Interface](#), sub-register 0x24 is the Test Mode control register.

REG:2F:24 – DIAG_TMC – Digital Diagnostics Test Mode Control																																													
31	30	29	28	27	26	25	24	23	22	21	20	19	18	17	16	15	14	13	12	11	10	9	8	7	6	5	4	3	2	1	0														
																-	-	-	-	-	-	-	-	-	-	-	-	-	-	-	-	-	-	-	-	-	-	-	-	-	-	-	-	-	-
																0	0	0	0	0	0	0	0	0	0	0	0	0	0	0	0	0	0	0	0	0	0	0	0	0	0	0	0	0	0

The bits of the DIAG_TMC register identified above are individually described below:

Field	Description of fields within Sub-Register 0x2F:24 – Digital Diagnostics Test Mode Control
- reg:2F:24 bit:VARIOUS	These bits of the DIAG_TMC register are reserved and should always be set to zero to avoid any malfunction of the device.
TX_PSTM reg:2F:24 bit:4	<p>Transmit Power Spectrum Test Mode. This test mode is provided to help support regulatory approvals spectral testing. When the TX_PSTM bit is set it enables a repeating transmission of the data from the TX_BUFFER. To use this test mode, the operating channel, preamble code, data length, offset, etc. should all be set-up as if for a normal transmission.</p> <p>The start-to-start delay between frames is programmed in the DX_TIME register. This is a special use of that register, where bits 31 to 0 are used, and the value is programmed in units of one quarter of the 499.2 MHz fundamental frequency, (~ 8 ns). To send one frame per millisecond, a value of 124800 or 0x0001E780 should be programmed to the DX_TIME register. A value <4 will not work properly, and a time value less than the frame duration will cause the frames to be sent back-to-back without any pause.</p> <p>When the mode and delay and TX buffer have been configured and the TX_PSTM bit is set, the repeated TX mode is initiated by setting TXSTRT bit in Register file: 0x0D – System Control Register.</p> <p>To exit the Transmit Power Spectrum test mode reset the TX_PSTM bit to zero.</p>

7.2.49 Register files: 0x30 to 0x35 – Reserved

ID	Length (octets)	Type	Mnemonic	Description
0x30 to 0x35	-	-	-	Reserved – these register files are reserved

[Register map](#) register files 0x30 through 0x35 are reserved for future use. Please take care not to write to these registers as doing so may cause the DW1000 to malfunction.

7.2.50 Register file: 0x36 – Power Management and System Control

ID	Length (octets)	Type	Mnemonic	Description
0x36	-	-	PMSC	Power Management System Control Block

[Register map](#) register file 0x36 is a control block for DW1000 power management and system control.

An overview of these is given by Table 49. Each of these sub-registers is separately described in the sub-sections below.

Table 49: Register file: 0x36 – Power Management and System Control overview

OFFSET in Register 0x36	Mnemonic	Description
----------------------------	----------	-------------

OFFSET in Register 0x36	Mnemonic	Description
0x00	PMSC_CTRL0	PMSC Control Register 0
0x04	PMSC_CTRL1	PMSC Control Register 1
0x08	PMSC_RES1	PMSC reserved area 1
0x0C	PMSC_SNOZT	PMSC Snooze Time Register
0x10	PMSC_RES2	PMSC reserved area 2
0x26	PMSC_TXFSEQ	PMSC fine grain TX sequencing control
0x28	PMSC_LEDC	PMSC LED Control Register

7.2.50.1 Sub-Register 0x36:00 – PMSC_CTRL0

ID	Length (octets)	Type	Mnemonic	Description
36:00	4	RW	PMSC_CTRL0	PMSC Control Register 0

Register file: [0x36 – Power Management and System Control](#), sub-register 0x00 is a 32-bit control register relating to enabling clocking to various digital blocks within the DW1000. This register also has a field allowing a software applied reset to be applied to the IC. The PMSC_CTRL0 register contains the following sub-fields:

REG:36:00 – PMSC_CTRL0 – PMSC Control Register 0																																
		31	30	29	28	27	26	25	24	23	22	21	20	19	18	17	16	15	14	13	12	11	10	9	8	7	6	5	4	3	2	1
SOFTRESET					-	-	-	-	KHZCLKEN					GPDNRN	GPDCE	GPRN	GPCE	AMCE					ADCCE					FACE	TXCLKS	RXCLKS	SYCLKS	
		1	1	1	0	0	0	0	0	0	0	1	1	0	0	0	0	0	0	0	0	0	0	0	1	0	0	0	0	0	0	0

The fields of the PMSC_CTRL0 register identified above are individually described below:

Field	Description of fields within Sub-Register 0x36:00 – PMSC_CTRL0
-	Bits marked '-' are reserved and should be preserved at their reset value.

Field	Description of fields within Sub-Register 0x36:00 – PMSC_CTRL0
SYCLKS reg:36:00 bits:1,0	<p>System Clock Selection. This selects the source of clock for DW1000 system clock. Allowed values are:</p> <p>00: Auto – The system clock will run off the 19.2 MHz XTI clock until the PLL is calibrated and locked, then it will switch over the 125 MHz PLL clock.</p> <p>01: Force system clock to be the 19.2 MHz XTI clock.</p> <p>10: Force system clock to the 125 MHz PLL clock. (If this clock is not present the DW1000 will essentially lock up with further SPI communications impossible. In this case an external reset will be needed to recover).</p> <p>11: Reserved.</p> <p>This control is used for certain procedures, e.g. to set system clock to be the 19.2 MHz XTI clock for manual access to OTP Memory.</p>
RXCLKS reg:36:00 bits:3,2	<p>Receiver Clock Selection. This selects the source of clock for the DW1000 receiver. Allowed values are:</p> <p>00: Auto – The RX clock will be disabled until it is required for an RX operation, at which time it will be enabled to use the 125 MHz PLL clock.</p> <p>01: Force RX clock enable and sourced clock from the 19.2 MHz XTI clock</p> <p>10: Force RX clock enable and sourced from the 125 MHz PLL clock. (NB: ensure PLL clock is present).</p> <p>11: Force RX clock off.</p> <p>This control is used for certain procedures, e.g. after a receive operation, if the host system wants to read the Channel Impulse Response Estimate (CIRE) for diagnostic purposes then, the receive clock needs to be present to access the accumulator memory.</p>
TXCLKS reg:36:00 bits:5,4	<p>Transmitter Clock Selection. This selects the source of clock for the DW1000 transmitter. Allowed values are:</p> <p>00: Auto – The TX clock will be disabled until it is required for a TX operation, at which time it will be enabled to use the 125 MHz PLL clock.</p> <p>01: Force TX clock enable and sourced clock from the 19.2 MHz XTI clock</p> <p>10: Force TX clock enable and sourced from the 125 MHz PLL clock. (NB: ensure PLL clock is present).</p> <p>11: Force TX clock off.</p> <p>This control is used for certain procedures, e.g. when setting up the continuous transmission mode that is used during power output calibration and regulatory testing.</p>
FACE reg:36:00 bit:6	<p>Force Accumulator Clock Enable. In normal operation this bit should be set to 0 to allow the PMSC to control the accumulator clock as necessary for normal receiver operation. If the host system wants to read the accumulator data, both this FACE bit and the AMCE bit (below) need to be set to 1 to allow the accumulator reading to operate correctly.</p>
ADCCE reg:36:00 bit:10	<p>(temperature and voltage) Analog-to-Digital Convertor Clock Enable. The DW1000 is equipped with 8-bit A/D convertors to sample the IC temperature and its input battery voltage. The IC can automatically sample the temperature and voltage as it wakes up from SLEEP or DEEPSLEEP. This is controlled by the ONW_RADC bit in <i>Sub-Register 0x2C:00 – AON_WCFG</i>. If the host system wants to initiate temperature and/or voltage measurements at other times then the clock to the Analog-to-Digital Convertor needs to be enabled via this ADCCE bit. For more details of this functionality, please refer to section 6.4 – Measuring IC temperature and voltage.</p>

Field	Description of fields within Sub-Register 0x36:00 – PMSC_CTRL0
AMCE reg:36:00 bit:15	Accumulator Memory Clock Enable. In normal operation this bit should be set to 0 to allow the PMSC to control the accumulator memory clock as necessary for normal receiver operation. If the host system wants to read the accumulator data, both this AMCE bit and FACE bit (above) need to be set to 1 to allow the accumulator reading to operate correctly.
GPCE reg:36:00 bit:16	GPIO clock Enable. In order to use the GPIO port lines the GPCE enable must be set to 1 to enable the clock into the GPIO block. The GPRN bit (below) must also be set to 1 to take the GPIO port out of its reset state.
GPRN reg:36:00 bit:17	GPIO reset (NOT), active low. In order to use the GPIO port lines GPRN bit must be set to 1 to take the GPIO port out of its reset state. The GPCE enable bit (above) must also be set to 1 to enable the clock into the GPIO block.
GPDCE reg:36:00 bit:18	<p>GPIO De-bounce Clock Enable. The DW1000 GPIO port includes a de-bounce functionality that may be applied to input lines being used as an interrupt source. The de-bounce filter circuit clocks the GPIO inputs into the DW1000 and removes short transients by requiring that the input persists for two cycles of this clock before it will be seen by the interrupt handling logic. (See Sub-Register 0x26:24 – GPIO_IDBE for more details). In order to use the GPIO port de-bounce functionality this GPDCE bit must be set to 1 to enable the clock into the GPIO block. The GPDRN bit (below) must also be set to 1 to take the GPIO port de-bounce filter circuit out of its reset state.</p> <p>This GPDCE bit also serves to enable the clock that controls the LED blink functionality and so must be enabled in order for the LEDs to function correctly. See Sub-Register 0x26:00 – GPIO_MODE for details of enabling LED functionality on GPIO lines.</p> <p>Note: As this clock employs the kilohertz clock, the appropriate dividers and enables need to be configured according to the desired functionality. See KHZCLKEN below and KHZCLKDIV in Sub-Register 0x36:04 – PMSC_CTRL1.</p>
GPDRN reg:36:00 bit:19	GPIO de-bounce reset (NOT), active low. In order to use the GPIO port de-bounce filter circuit the GPDRN bit must be set to 1 to take the de-bounce filter circuit out of its reset state. The GPDCE enable bit (above) must also be set to 1 to enable the clock into the GPIO de-bounce circuit.
KHZCLKEN reg:36:00 bit:23	Kilohertz clock Enable. When this bit is set to 1 it enables the divider. The divider value is set by KHZCLKDIV in Sub-Register 0x36:04 – PMSC_CTRL1 .
SOFTRESET reg:36:00 bits:31–28	<p>These four bits reset the IC TX, RX, Host Interface and the PMSC itself, essentially allowing a reset of the IC under software control. These bits should be cleared to zero to force a reset and then returned to one for normal operation. The correct procedure to achieve this reset is to:</p> <ul style="list-style-type: none"> (a) Set SYSCLKS to 01 (b) Clear SOFTRESET to all zeros (c) Set SOFTRESET to all ones <p>The AON block is not reset by this activity and so may take action following the reset depending on the configuration within Sub-Register 0x2C:00 – AON_WCFG.</p> <p>To apply a receiver-only soft reset, clear and set bit 28 only.</p>

7.2.50.2 Sub-Register 0x36:04 – PMSC_CTRL1

ID	Length (octets)	Type	Mnemonic	Description
36:04	4	RW	PMSC_CTRL1	PMSC Control Register 1

Register file: [0x36 – Power Management and System Control](#), sub-register 0x04 is a 32-bit control register. The PMSC_CTRL1 register contains the following sub-fields:

REG:36:04 – PMSC_CTRL1 – PMSC Control Register 1																															
31	30	29	28	27	26	25	24	23	22	21	20	19	18	17	16	15	14	13	12	11	10	9	8	7	6	5	4	3	2	1	0
KHZCLKDIV				-	-	-	-	-	-	-	-	-	LDERUNE	-	PLLSYN	SNOZR	SNOZE	ARXSLP	ATXSLP	PKTSEQ							-	ARX2INIT	-		
1	0	0	0	0	0	0	0	1	0	0	0	0	0	0	1	0	0	0	0	0	1	1	1	0	0	1	1	1	0	0	0

The fields of the PMSC_CTRL1 register identified above are individually described below:

Field	Description of fields within Sub-Register 0x36:04 – PMSC_CTRL1
-	Bits marked ‘-’ are reserved and should be preserved at their reset value.
ARX2INIT reg:36:04 bit:1	Automatic transition from receive mode into the INIT state. If the ARX2INITbit is set then the DW1000 will automatically transition into the INIT state after a receive attempt so long as there are no unmasked interrupts pending. This control is used to enableLow duty-cycle SNIFF mode. Please refer to section 4.5.2 – Low duty-cycle SNIFF mode for more details of this functionality.
PKTSEQ reg:36:04 bits:10-3	Writing 0 to PKTSEQ disables PMSC control of analog RF subsystems. To enable PMSC control of these blocks a value of 0xE7 should be written.
ATXSLP reg:36:04 bit:11	After TX automatically Sleep. If this bit is set then the DW1000 will automatically transition into SLEEP or DEEPSLEEP mode after transmission of a frame has completed so long as there are no unmasked interrupts pending. This bit is cleared when the DW1000 wakes from sleep, unless the as the PRES_SLEEP bit is set in Sub-Register 0x2C:00 – AON_WCFG . Before using this ATXSLP feature the AON configurations in Register file: 0x2C – Always-on system control interface should be set to allow for the appropriate DW1000 wakeup functionality. One of the uses for this would be in a device that periodically transmits a message (e.g. TDOA RTLS Tag) to return the DW1000 to its lowest power state immediately after the transmission, saving power.
ARXSLP reg:36:04 bit:12	After RX automatically Sleep. If this bit is set then the DW1000 will automatically transition into SLEEP mode after a receive attempt so long as there are no unmasked interrupts pending. Before using ARXSLP the AON configurations in Register file: 0x2C – Always-on system control interfaces should be set to allow for the appropriate DW1000 wakeup functionality. This bit is cleared when the DW1000 wakes from sleep, unless the as the PRES_SLEEP bit is set in Sub-Register 0x2C:00 – AON_WCFG .One of the uses for this is to implement a scheme calledLow-Power Listening. See section 4.4 – Low-Power Listening for more details.

Field	Description of fields within Sub-Register 0x36:04 – PMSC_CTRL1
SNOZE reg:36:04 bit:13	Snooze Enable. A SNOOZE is like a SLEEP except the snooze uses the 19.2 MHz XTI clock and the snooze time period is specified by the SNOZ_TIM field of Sub-Register 0x36:0C – PMSC_SNOZT . Snoozing is more precisely timed than sleeping but has a higher power drain than sleeping. This is used to implement the Low-Power Listenscheme, see section 4.4 – Low-Power Listening for more details.
SNOZR reg:36:04 bit:14	Snooze Repeat. The SNOZR bit is set to allow the snooze timer to repeat twice. SNOOZE-> RX-> SNOOZE-> RX. One of the uses for this is to implement a scheme call Low-Power Listening. See section 4.4 – Low-Power Listening for more details.
PLLSYN reg:36:04 bit:15	This enables a special 1 GHz clock used for some external SYNC modes. If this is not required then to save power the PLLSYN configuration should be left set to 0. See Register file: 0x24 – External Synchronisation Control for more details.
LDERUNE reg:36:04 bit:17	LDE run enable. This bit enables the running of the LDE algorithm. LDERUNE is 1 by default which means that the LDE algorithm will be run as soon as the SFD is detected in the receiver. When LDERUNE is set to zero the LDE algorithm will not be run and the RX_STAMP in Register file: 0x15 – Receive Time Stamp will not be updated. For this the LDE code needs to be loaded from ROM into its runtime RAM, which is achieved using the LDELOAD control in Sub-Register 0x2D:06 – OTP_CTRL , an can also be done automatically when waking from SLEEP or DEEPSLEEP via the ONW_LLDE control in Sub-Register 0x2C:00 – AON_WCFG . If the LDE code is not loaded then the LDERUNE control must be disabled before turning on the receiver.
KHZCLKDIV reg:36:04 bits:31–26	Kilohertz clock divisor. This field specifies a clock divider designed to give a kilohertz range clock that is used in the DW1000 for the LED blink functionality and also for the GPIO de-bounce functionality. The input to the kHz divider is the 19.2 MHz XTI clock (which is the raw 38.4 MHz XTAL ÷ 2). The KHZCLKDIV field specifies the top 6 bits of a 10-bit counter allowing divisors up to 2016 or clock frequencies from 9.5 kHz up to 600 kHz. The resultant clock is used directly in the GPIO de-bounce circuit (see Sub-Register 0x26:24 – GPIO_IDBE). A further divider is applied for the LED blink functionality, see Sub-Register 0x36:28 – PMSC_LEDC .

7.2.50.3 Sub-Register 0x36:08 – PMSC_RES1

ID	Length (octets)	Type	Mnemonic	Description
36:08	4	RW	PMSC_RES1	PMSC reserved area 1

[Register file: 0x36 – Power Management and System Control](#), sub-register 0x08 is a reserved register. Please take care not to write to this register as doing so may cause the DW1000 to malfunction.

7.2.50.4 Sub-Register 0x36:0C – PMSC_SNOZT

ID	Length (octets)	Type	Mnemonic	Description
36:0C	1	RW	PMSC_SNOZT	PMSC Snooze Time Register

Register file: [0x36 – Power Management and System Control](#), sub-register 0x0C is an 8-bit register for specifying the snooze time period. The PMSC_SNOZT register contains the following sub-fields:

REG:36:0C – PMSC_SNOZT – PMSC Snooze Time Register																															
31	30	29	28	27	26	25	24	23	22	21	20	19	18	17	16	15	14	13	12	11	10	9	8	7	6	5	4	3	2	1	0
																SNOZ_TIM															
																0	1	0	0	0	0	0	0	0							

The fields of the PMSC_CTRL1 register identified above are individually described below:

Field	Description of fields within Sub-Register 0x36:0C – PMSC_SNOZT
SNOZ_TIM <small>reg:36:0C bits:7-0</small>	Snooze Time Period. These bits are the upper 8-bits of a 12-bit timer that defines the snooze period in units of the 19.2 MHz XTI internal clock. The default value 0x40 (or decimal 64), gives a period of $64 \times 16 / 19e6$ seconds, or 53.3 μ s. Snoozing is enabled via the SNOZE bit in Sub-Register 0x36:04 – PMSC_CTRL1 , and is used during low power listening. See section 4.4 – Low-Power Listening for more details.

7.2.50.5 Sub-Register 0x36:10 – PMSC_RES2

ID	Length (octets)	Type	Mnemonic	Description
36:10	22	RW	PMSC_RES2	PMSC reserved area 2

Register file: [0x36 – Power Management and System Control](#), sub-register 0x10 is a reserved register. Please take care not to write to this register as doing so may cause the DW1000 to malfunction.

7.2.50.6 Sub-Register 0x36:26 – PMSC_TXFSEQ

ID	Length (octets)	Type	Mnemonic	Description
36:26	2	RW	PMSC_TXFSEQ	PMSC fine grain TX sequencing control

Register file: [0x36 – Power Management and System Control](#), sub-register 0x26 is used to control TX fine grain power sequencing function. The PMSC_TXFSEQ register contains the following sub-fields:

REG:36:26 – PMSC_TXFSEQ – PMSC fine grain TX sequencing Control Register															
15	14	13	12	11	10	9	8	7	6	5	4	3	2	1	0
TXFINESEQ															
0	0	0	0	1	0	1	1	0	0	1	1	1	1	0	0

The fields of the PMSC_TXFSEQ register identified above are described below:

Field	Description of fields within Sub-Register 0x36:26 – PMSC_TXFSEQ
TXFINESEQ reg:36:26 bits:15-0	Writing 0 to this field will disable TX fine grain power sequencing, this is required for certain test and calibration modes (Continuous Wave transmission). To enable fine grain power sequencing the default value of 0x0B74 should be written back to this register.

7.2.50.7 Sub-Register 0x36:28 – PMSC_LEDC

ID	Length (octets)	Type	Mnemonic	Description
36:28	4	RW	PMSC_LEDC	PMSC LED Control Register

Register file: [0x36 – Power Management and System Control](#), sub-register 0x28 is a 32-bit LED control register. The PMSC_LEDC register contains the following sub-fields:

REG:36:28 – PMSC_LEDC – PMSC LED Control Register																																	
31	30	29	28	27	26	25	24	23	22	21	20	19	18	17	16	15	14	13	12	11	10	9	8	7	6	5	4	3	2	1	0		
-	-	-	-	-	-	-	-	-	-	-	-	BLNKNOW				-	-	-	-	-	-	-	BLNKEN	BLINK_TIM									
0	0	0	0	0	0	0	0	0	0	0	0	0	0	0	0	0	0	0	0	0	0	0	0	0	0	0	0	1	0	0	0	0	0

The fields of the PMSC_LEDC register identified above are individually described below:

Field	Description of fields within Sub-Register 0x36:28 – PMSC_LEDC
-	Bits marked '-' are reserved and should be preserved at their reset value.
BLINK_TIM reg:36:28 bits:7-0	Blink time count value. This field determines how long the LEDs remain lit after an event that causes them to be set on. This time is specified in units of 14 ms so the default value of 0x20 will give an on blink of 400 ms followed by an off blink of 400 ms. The BLNKEN bit (below) must be set to enable this blink functionality.
BLNKEN reg:36:28 bit:8	Blink Enable. When this bit is set to 1 the LED blink feature is enabled.
BLNKNOW reg:36:28 bits:19:16	Manually triggers an LED blink. There is one trigger bit per LED IO.

7.2.51 Register files: 0x37 to 0x3F – Reserved

ID	Length (octets)	Type	Mnemonic	Description
0x37 to 0x3F	-	-	-	Reserved – these register files are reserved

[Register map](#) register files 0x36 through 0x3F are reserved for future use. Please take care not to write to these registers as doing so may cause the DW1000 to malfunction.

8 DW1000 Calibration

The operating characteristics and performance of the DW1000 is dependent on the IC itself and on its external circuitry and on its operating environment. To give optimum performance it is necessary to calibrate the IC to account for factors which affect its operation.

Some calibration parameters are dependent solely on natural variations that occur within the silicon of the IC during its manufacture. These are typically measured during IC production test and the required calibration parameters are written to the OTP memory of the DW1000. The host system software can then use these values during DW1000 configuration to optimise the DW1000 performance.

Some calibration parameters are dependent on circuit elements external to the IC. These can only be determined during the manufacture of the product module into which the DW1000 is soldered. These parameters are typically measured during module production test and the required calibration parameters are stored somewhere in the module. An area of the DW1000's OTP memory has been set for module test calibration parameters. The host system software will use this calibration data during DW1000 configuration to optimise the DW1000 performance.

Some calibration parameters may vary according to the operational environment of the DW1000. For example some parameters may need to be changed if there are large variations in the ambient temperature (e.g. moving from a warm area into a cold store) or if there are significant changes in battery voltage supply. In such circumstances in order to optimise the DW1000 performance the host system software can monitor the voltage and temperature using DW1000 and adjust configuration accordingly.

Elements of the DW1000 that may be subject to calibration are:

- Crystal trimming – the DW1000 contains trimming capacitors that can fine tune the operating frequency of its crystal oscillator
- Transmitter output power and spectrum – the DW1000 output spectrum is tuneable to meet regional spectral regulations and maximise the output power to achieve the greatest operating range.
- Antenna delay – the DW1000 antenna delay may be fine-tuned to give best possible ranging or location accuracy.

The sub-sections below detail the calibration of these DW1000 parameters.

8.1 IC Calibration – Crystal Oscillator Trim

DW1000 is specified to operate with clock offsets between the transmitting and receiving nodes of up to ± 20 ppm. The receiver sensitivity of DW1000 can be improved by reducing the relative offset in clocks between the transmitting and receiving nodes. One way to reduce the offset is to use temperature compensated crystal oscillators (TCXO) in both transmitting and receiving nodes or just in one side of the link. Using TCXOs increases system cost and current consumption so generally they are only used in fixed anchor scenarios. Where crystals are used as the clock reference, DW1000 provides a facility to trim the oscillator frequency by switching in internal capacitor banks in parallel with the external loading capacitors associated with the

chosen crystal. This trimming can be used to reduce the crystal initial frequency error and to compensate for temperature and aging drift, if required.

The amount of trimming is programmable through [Sub-Register 0x2B:0E – FS_XTALT](#).

8.1.1 Calibration Method

The 38.4 MHz crystal's frequency of oscillation cannot be directly observed because it is not possible to probe the XTAL1 and XTAL2 input pins without disturbing the oscillation. The method used is to infer the crystal oscillation frequency by observing the output of the transmitter using a spectrum analyzer or frequency counter.

The DW1000 is configured to transmit a continuous wave (CW) signal at a particular channel frequency. It is suggested that channel 5 is used because the higher the frequency the easier it is to observe step changes in the output. While accurately measuring the centre frequency of the transmission, the trim value is adjusted until the output frequency is as close as possible to the desired frequency (e.g. 6489.6 MHz for channel 5).

In order to allow the internal trimming circuits as large a range of programming as possible, the external loading capacitors should be chosen during the board design phase such that on average (tested on a number of boards) the crystal trim register setting is set close to mid-range which is a 5-bit decimal value of 15 or 0x0F.

Test Setup:

Reset the device so that it is in a known state before initiating the test procedure.

Configure the transmitter as described in the following steps and then monitor the RF output on a spectrum analyser or frequency counter.

Transmitter Configuration Procedure:

1. Write 0x0009A000 to [Sub-Register 0x28:00 – RF_CONF](#)
2. Write 0x00000000 to [Sub-Register 0x36:04 – PMSC_CTRL1](#)
3. Write the correct value for the selected channel to [Sub-Register 0x28:0C – RF_TXCTRL](#), see Table 34, e.g. 0x1E3FE0 for channel 5.
4. Write an appropriate value to [Register file: 0x1E – Transmit Power Control](#), such as that for the selected channel, see [Table 18: Reference values Register file: 0x1E – Transmit Power Control](#).
5. Write the value for the selected channel to [Sub-Register 0x2B:07 – FS_PLLCFG](#), e.g. 0x0800041D for channel 5, see [Table 39: Sub-Register 0x2B:07 – FS_PLLCFG values](#).
6. Write the correct value for the selected channel to [Sub-Register 0x2B:0B – FS_PLLTUNE](#), e.g. 0x46 for channel 5.
7. Write 0x22 to PMSC_CTRL0 to enable the appropriate clocks, see [Sub-Register 0x36:00 – PMSC_CTRL0](#).
8. Write 0x0000CD81 to reserved register [Sub-Register 0x36:26 – PMSC_TXFSEQ](#).
9. Write 0x005FFF00 to [Sub-Register 0x28:00 – RF_CONF](#)

Enable CW mode:

Set [Sub-Register 0x2A:0C – TC_PGTEST](#) to 0x13 to enable Continuous Wave (CW) Test Mode.

Set trim register to mid-range setting, e.g. 0x0F, whilst maintaining the required reserved values in the most significant bits of the register, see reserved field notes for [Sub-Register 0x2B:0E – FS_XTALT](#):

Set [Sub-Register 0x2B:0E – FS_XTALT](#) to 0x6F.

While monitoring the CW frequency, adjust the trim register (5 bits) until the desired frequency is obtained. Figure 29 shows that the trimming is typically linear and usually the final value is reached with just one or two adjustments.

The crystal trim value should then be stored on the OTP memory, see section [6.3.2 – Programming a value into OTP memory](#) for details of how to program OTP memory and recommended memory locations.

In DW1000 applications using crystal trimming, the calibrated crystal trim value should be read by the application from OTP memory as part of setup and programmed into the [Sub-Register 0x2B:0E – FS_XTALT](#). This register is preserved in the AON memory as long as the IC is powered. This facilitates the use of the trim value when the IC wakes up from **SLEEP** or **DEEPSLEEP** modes.

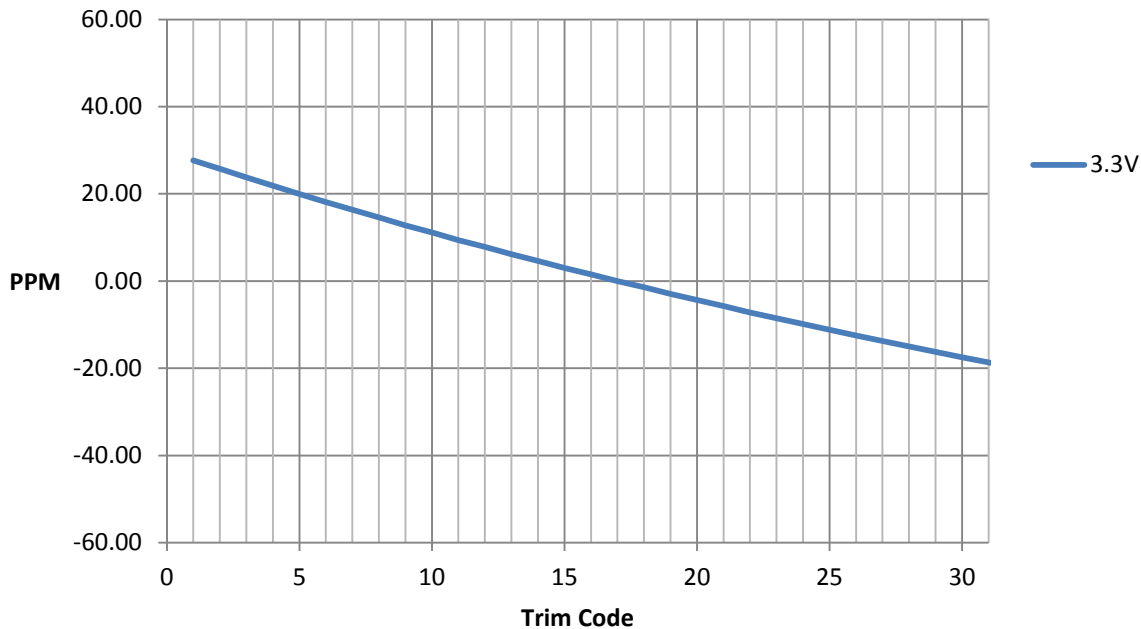

Figure 28: PPM vs Crystal Trim Setting, V_{BATT} = 3.3 V

8.2 IC Calibration – Transmit power and spectrum

In order to maximise range, DW1000 transmit power spectral density (PSD) should be set to the maximum allowable for the geographic region of deployment. For most regions this is -41.3 dBm / MHz. DW1000 is designed such that if the transmit power is within mean power spectral density limits then it will automatically be within peak power limits although this should be checked during product design verification.

As this is an analog circuit, there will be some variation in output power levels from IC to IC and hence DW1000 should be calibrated and the calibrated power setting stored in the OTPmemory. DW1000 provides the facility to adjust the transmit power in coarse and fine steps; 3 dB and 0.5 dB nominally. It also provides the ability to adjust the spectral bandwidth. These adjustments can be used to maximise transmit power whilst meeting regulatory spectral mask limits.

8.2.1 Calibration Method

This calibration can be performed using either a radiated or conducted measurement procedure. The calibration method is slightly different depending on whether Manual Transmit Power Control (see [7.2.31.2 – Manual Transmit Power Control](#)) or Smart Transmit Power Control (see [7.2.31.1 – Smart Transmit Power Control](#)) is configured.

8.2.1.1 Calibration – Manual TX Power Control

Test Setup:

Reset the device so that it is in a known state before initiating the test procedure.

Configure the transmitter as described in the following steps (Table 50) and monitor the RF output on a spectrum analyser.

Table 50: Register accesses required for transmitter configuration procedure

Step Number	Instruction	Register Address	Data Length (Bytes)	Data (Write/Read)
C-1	Write Sub-Register	0x36:00 (PMSC_CTRL0)	1	0x1 (set SYSCLKS bit)
C-2	Write Sub-Register	0x36:04 (PMSC_CTRL1)	2	0x0 (clear PKTSEQ bits)
C-3	Write Sub-Register	0x28:0C (RF_TXCTRL)	3	e.g. 0x45CA0 *
C-4	Write Sub-Register	0x1E:00 (TX_POWER)	4	e.g. 0x75757575 *
C-5	Write Sub-Register	0x2B:07 (FS_PLLCFG)	4	e.g. 0x08400508 *
C-6	Write Sub-Register	0x2B:0B (FS_PLLTUNE)	1	e.g. 0x26 *
C-7	Write Sub-Register	0x2A:0B (TC_PGDELAY)	1	e.g. 0xC2 *
C-8	Write Sub-Register	0x28:00 (RF_RES1)	4	0x1FE000
C-9	Write Sub-Register	0x28:00 (RF_RES1)	4	0x5FFF00
C-10	Write Sub-Register	0x36:00 (PMSC_CTRL0)	1	0x22
C-11	Write Sub-Register	0x04:00 (SYS_CFG)	4	set DIS_STXP bit
C-12	Write Sub-Register	0x1F:00 (CHAN_CTRL)	4	0x18C40022 *
C-13	Write Sub-Register	0x09:00 (TX_BUFFER)	16	test data *
C-14	Write Sub-Register	0x08:00 (TX_FCTRL)	4	0x25A010 *
C-15	Write Sub-Register	0x0A:00 (DX_TIME)	5	0x04
C-16	Write Sub-Register	0x2F:24 (DIAG_TMC)	2	set TX_PSTM bit

1. Write the correct value for the selected channel to [Sub-Register 0x28:0C– RF_TXCTRL](#), e.g. 0x045CA0 for channel 2.

2. Write an appropriate value for TX_POWER to *Register file: 0x1E – Transmit Power Control*, e.g. for channel 2 at 16 MHz PRF, write 0x75757575. See Table 18.
3. Write the value for the selected channel to *Sub-Register 0x2B:07 – FS_PLLCFG*, e.g. 0x08400508 for channel 2, see *Table 39: Sub-Register 0x2B:07 – FS_PLLCFG values*.
4. Write the correct value for the selected channel to *Sub-Register 0x2B:0B – FS_PLLTUNE*, e.g. 0x26 for channel 2.
5. Write the correct value for the selected channel to TC_PGDELAY, see *Sub-Register 0x2A:0B – TC_PGDELAY*, e.g. 0xC2 for channel 2.
6. Write 0x05FFF00 to *Sub-Register 0x28:00 – RF_CONF*
7. Write appropriate values to *Register file: 0x1F – Channel Control*, e.g. for channel 2, PRF 16 MHz and preamble code 3, write 0x18C40022.
8. Write transmit data to the transmit buffer, see *Register file: 0x09 – Transmit Data Buffer*, e.g. 0x000000000000000000000000C2DEC1DE.
9. Write appropriate values to *Register file: 0x08 – Transmit Frame Control*, e.g. for frame length 16 bytes, 850 kbps data rate, 16 MHz PRF and 256 symbol preamble, write 0x25A010.

The spectrum analyser should be set up as follows:

- Resolution Bandwidth = 1 MHz
- Video Bandwidth = 1 MHz
- Span = 2 GHz
- Sweep time = 2 seconds
- Detector = rms
- Average time per point (on spectrum analyser scan) ≤ 1 ms

In order to easily view the transmit spectrum the device is set into Transmit Power Spectrum Test Mode by setting the TX_PSTM field of *Sub-Register 0x2F:24 – Digital Diagnostics Test Mode Control*. A suitable value for the repeat frame interval must be set in DX_TIME register, the minimum value is 4. For a repeat interval of 1 ms, a value of 0x0001E780 may be written to DX_TIME, see *Sub-Register 0x2F:24 – Digital Diagnostics Test Mode Control* TX_PSTM field description for details. For Manual Transmit Power Control testing this setting should be configured to send frames continuously and so a value of 4 or greater but less than the frame duration must be set in DX_TIME. A value of 4 is recommended for Manual Transmit Power Control calibration.

When the test configuration has been completed, the transmitter may be initiated by setting the TXSTRT field in the SYS_CTRL register, see *Register file: 0x0D – System Control Register*.

TX_POWER should be set for the selected channel as a starting point, see *Register file: 0x1E – Transmit Power Control*. The TX_POWER setting should then be adjusted until the transmit level is just below the required spectral density limit (usually -41.3dBm/MHz). This register value should then be stored in the OTPmemory, see section *6.3.2 – Programming a value into OTP memory* for details of how to program OTPmemory and recommended memory locations.

In DW1000 applications using transmit power calibration, the calibrated TX_POWER value should be read by the application from OTP memory as part of setup and programmed into *Register file: 0x1E – Transmit*

Power Control. This register is preserved in the AON memory as long as the IC is powered. This facilitates the use of this value when the IC wakes up from **SLEEP** or **DEEPSLEEP** modes.

8.2.1.2 Calibration – Smart TX Power Control

With Smart TX Power Control enabled the calibration is similar to the method used for Manual TX Power Control except that we do not transmit repeated back to back frames. For this calibration, we configure the transmitter to transmit 1 frame per millisecond. To do this, configure the Transmit Power Spectrum Test Mode, see the TX_PSTM field description of *Sub-Register 0x2F:24 – Digital Diagnostics Test Mode Control*. The repeat frame interval must be set in DX_TIME register, for a repeat interval of 1 ms, a value of 0x0001E780 should be written to DX_TIME, as described in the TX_PSTM field description.

Depending on the length of the frames to be used, see *7.2.31.1 – Smart Transmit Power Control*, the TX_POWER setting should be adjusted until the transmit level is just below the required spectral density limit (usually -41.3dBm/MHz). This register value should then be stored in the OTP memory, see section *6.3.2 – Programming a value into OTP memory* for details of how to program OTP memory and recommended memory locations.

In DW1000 applications using transmit power calibration, the calibrated TX_POWER value should be read by the application from OTP memory as part of setup and programmed into *Register file: 0x1E – Transmit Power Control*. This register is preserved in the AON memory as long as the IC is powered. This facilitates the use of this value when the IC wakes up from **SLEEP** or **DEEPSLEEP** modes.

8.2.2 Other TX adjustments to consider

DW1000 recommended transmitter analog/RF settings will not need adjustment for most designs/applications, however the following registers can be adjusted to tune the transmit spectrum bandwidth or passband flatness:

- TXMTUNE field of *Sub-Register 0x28:0C – RF_TXCTRL*, used to tune the transmit mixer.
- TXMQ field of *Sub-Register 0x28:0C – RF_TXCTRL*, used to tune the transmit mixer Q-factor.
- *Sub-Register 0x2A:0B – TC_PGDELAY*, used to tune the width of pulses and hence the spectrum bandwidth.

To tune any of these values, start with the default value (as given in the register descriptions *Sub-Register 0x28:0C – RF_TXCTRL* and *Sub-Register 0x2A:0B – TC_PGDELAY*), and adjust the value iteratively observing the effect on a spectrum analyser until the PSD occupies as much of the applicable spectral mask as possible.

8.3 IC Calibration – Antenna Delay

In order to measure range accurately, precise calculation of timestamps is required. To do this, a delay called the antenna delay must be known. The DW1000 allows this delay to be calibrated and provides the facility to compensate for delays introduced by PCB, external components, antenna and internal DW1000 delays.

To calibrate the antenna delay, range is measured at a known distance using 2 DW1000 systems. Antenna delay is adjusted until the known distance and reported range agree. The antenna delay can be stored in OTP memory.

There is a Transmitter Antenna Delay and a Receiver Antenna Delay. The Transmitter Antenna Delay is used to account for the delay between the internal digital timestamp of the RMARKER (at the start of the PHR, see 3.2) inside the DW1000 and the time the RMARKER is transmitted from the antenna. The Receiver Antenna Delay is used to account for the delay between the time of arrival of the RMARKER at the antenna and the internal digital timestamp of the RMARKER (at the start of the PHR, see 4.1.6 – RX Message timestamp) inside the DW1000.

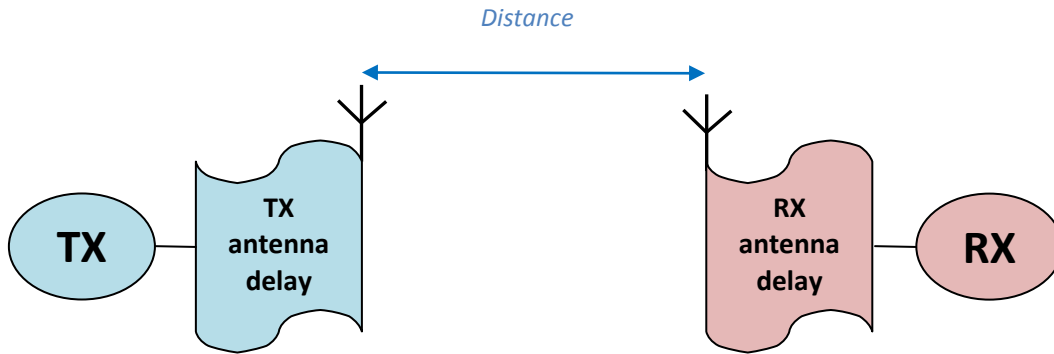

Figure 29: Transmit and Receive Antenna Delay

8.3.1 Calibration Method

To achieve the highest accuracy during calibration, it is recommended that antenna delay is calibrated with the receiver power input at the following levels:

Table 51: Recommended RX power level for antenna calibration

Power at receiver input(dBm/MHz)	PRF(MHz)	Channel
-108	16	1, 2, 3, 5
-104	64	1, 2, 3, 5
-102	16	4, 7
-102	64	4, 7

If the transmitter is set to -41.3dBm/MHz and 0 dBi antennas are used, then the receiver input powers above equate to the following separations between transmit and receive antenna:

Table 52: Recommended TX-RX separation for antenna calibration

Channel	PRF (MHz)	Calibration Separation (m)
1	16	14.75
1	64	9.3
2	16	12.9
2	64	8.14
3	16	11.47
3	64	7.24

Channel	PRF (MHz)	Calibration Separation (m)
4	16/64	8.68
5	16	7.94
5	64	5.01
7	16/64	5.34

The combined transmitter and receiver antenna delay is calibrated by choosing a distance (or receive power) for calibration and modifying the receiver antenna delay until the range reading given by the device is correct.

A method to calibrate combined receiver and transmitter antenna delay is as follows:

1. Place the transmitter and receiver at the recommended distance apart as per Table 52 or at a shorter distance but ensuring that the receiver power level is as per Table 51
2. Using a two way ranging scheme (e.g. “DecaRanging” available from DecaWave), perform 1000 ranges.
3. Adjust antenna delay until the average measured range matches the distance chosen in step 1 as closely as possible.

Record the antenna delay value. This value is then divided by 2 and the new value is stored in the OTP memory in the locations for both TX Antenna Delay and RX Antenna Delay (see section [6.3.2 – Programming a value into OTP memory](#) for details of how to program OTP memory and recommended memory locations).

Note: In many systems, where all devices have the same transmitter and receiver antenna delays, it is unnecessary to calibrate the transmitter antenna delay. The transmitter antenna delay may be set to zero and a combined receiver and transmitter delay value may be used for the receiver antenna delay without impairing the ranging performance of the system.

The DW1000 ranging algorithm will calculate the time of reception of a packet in order to estimate the range to the transmitter. The receiver antenna delay is a constant value representing the propagation time of the received signal from the antenna to the receiver point of timestamp calculation.

This antenna delay value can then be subtracted from the receive timestamp in order to calculate the time of flight.

For enhanced ranging accuracy the ranging software can adjust the antenna delay to compensate for changes in temperature. Typically the reported range will vary by 2.15 mm / °C and by 5.35 cm / V_{BATT}.

9 Operational design choices when employing the DW1000

This chapter discusses some of the operational considerations to using the DW1000 in general RF transceiver applications, with some additional focus on its use in real-time location systems, (RTLs).

9.1 Operating range

The operational range of the DW1000 depends on the frame data rate and the preamble length. In free-space, line-of-sight (LOS), this may vary from 60m at the 6.8 Mbps data rate to up to 250 m at the 110 kbps data rate. In a typical indoor environment the LOS range is generally larger than the quoted free-space LOS figure because multipath reflections give extra usable receive signal, e.g. the range at 850 kbps could be 40% longer (and more) than that quoted for free-space LOS. In non-LOS conditions (NLOS), where there are obstructions in the LOS path, the range will be reduced due to receive signal attenuation. The operating range also varies depending on the channel centre frequency and channel bandwidth selected – a lower centre frequency gets more range than a higher one, while the wider bandwidth channels channel 4 and channel 6 have more range than the standard 500 MHz bandwidth channels as the wider channel allows more energy to be sent at a given dBm / MHz regulatory limit.

9.2 Channel and Bandwidth selection

The choice of channel's centre frequency is often dictated by regional regulations, e.g. USA and EUROPE have different rules, albeit with some overlap, so channel choice in a product may depend on the target market for that product. The choice of bandwidth may also depend on whether the resultant spectrum is within the regional regulations. The IEEE 802.15.4 standard UWB PHY defines a number of channels, from 0 to 10 GHz, some with same centre frequency and different bandwidths, (e.g. channel 2 and channel 4 both have 3993.6 MHz centre frequency, but have bandwidths of 499.2 and 1331.2 MHz respectively). Table 57 in section [10.5 – UWB channels and preamble codes](#) lists the channels supported by the DW1000.

Operating at a wider bandwidth increases range but also increases power consumption. The DW1000 has fine control of the TX pulse width allowing optimum control of transmitted spectrum bandwidth.

9.3 Choice of data rate, preamble length and PRF

For a given operating centre frequency and bandwidth the choice of data rate generally determines the operating range. However, the length of the preamble sequence also has a bearing on range.

The preamble is a repeated sequence of pulses following a pattern defined in the IEEE 802.15.4 standard. See section [10.3 – Synchronisation header modulation scheme](#) for details. On each numbered channel the 802.15.4 standard defines two preamble codes for the nominal 16 MHz PRF (pulse repetition frequency) and four preamble codes for the nominal 64 MHz PRF. Table 57 in section [10.5 – UWB channels and preamble codes](#) lists the preamble codes allowed on each channel as defined in the IEEE 802.15.4 standard. These codes are semi-orthogonal allowing devices on the same channel but using different preamble codes to essentially operate simultaneously as if on separate channels. The preamble sequences property of perfect periodic auto-correlation allows the receiver to accumulate the repeated preamble and ascertain an accurate model of the channel impulse response between the remote transmitter and itself. This is what

gives the DW1000 its good long-range performance and allows its accurate determination of the first path arrival time for the RX timestamp.

The preamble sequence used at all data rates is the same, i.e. it does not depend on the chosen data rate. The preamble sequence length, (i.e. the number of symbol intervals for which it is repeated), has a significant effect on the operational range and the accuracy of timestamps. Table 53 gives some recommended preamble sequence lengths to use depending on the data rate. In general, a longer preamble gives improved range performance and better first path time of arrival information while a shorter preamble gives a shorter air time and saves power. When operating a low data rate for long range, then a long preamble is needed to achieve that range. At a high data rate the operating range is naturally short so there is no point in sending a very long preamble as it wastes time and power for no added range advantage.

Table 53: Recommended preamble lengths

Data Rate	Recommended preamble sequence length
6.8 Mbps	64 or 128 or 256
850 kbps	256 or 512 or 1024
110kbps	2048 or 4096

There are two choices of mean pulse repetition frequency (PRF) within the DW1000. These are 16 MHz PRF or 64 MHz PRF. The 16 and 64 are “nominal” since the actual frequencies are related to the 499.2 MHz basic time unit used and differ slightly between preamble and payload parts of the frame. The higher PRF gives more accuracy on the first path timestamp and perhaps slightly improved operating range, however this comes at the price of additional power consumption.

9.4 Power consumption

As described above, frames with lower data rate have the largest operating range. Such messages by their nature also take longer to send and, as this means that the DW1000’s transmitter needs to be on for a longer period, the result is that more power is consumed than for faster messages. The quantity of data being transferred also has a bearing on this, i.e. higher data rates give more benefit when frame data sizes are larger.

9.5 Node density and air utilisation

The ALOHA mechanism is the favoured channel access method in the IEEE 802.15.4 UWB PHY standard and this is the channel access method employed by the DW1000. Essentially this involves assuming the air is idle and transmitting whenever you want to. For ALOHA to work successfully total air utilisation has to be <18% across all nodes in range of each other. With air utilisation above 18% collision probability is high and system performance degrades quickly. Below the 18% value 97% of transmissions are likely to succeed without collisions.

This 18% air utilisation comes into play when deploying a population of RTLS tags periodically blinking. Table 54 gives some indications of the blink transmission rates corresponding to some typical data rate / preamble length combinations and with a minimum 12-byte blink frame sending the Tag ID. The number of transmissions that can be made within the 18% air-utilisation is highest for the shortest duration frame (64-symbol preamble and 6.8 Mbps data rate) and lowest at the long range 110 kbps data rate with its long preamble.

Table 54: Transmissions per second using ALOHA

Data rate	preamble length	payload	Transmission Time	TX per second at 18% air-utilisation
110 kbps	2048 symbols	12 bytes	3.042 ms	59.2
850 kbps	256 symbols	12 bytes	380.3 μ s	473.4
6.8 Mbps	64 symbols	12 bytes	103.3 μ s	1742

Note: These figures relate to an RTLS tag blink across a population of tags, so for instance at 6.8Mbps 1742 tags could blink once a second, or 17k tags could blink once every 10 s.

When deploying an RTLS system with blinking tags there is a trade-off between the blink rate(location update rate) across the population of tags and the operating range (and of course power consumption). A long range system with sparsely spaced anchor nodes cannot have a large population of tags with frequently updated locations, (i.e. it needs to stay below 60 tags transmitting once per second, or 600 tags transmitting once every 10 seconds), also as the packet is physically long the blinks in such a long range system consume more power.

For a high update rate or a high density of tags the highest data rate and shortest preamble length is best. This means range is lower so more infrastructure anchor nodes are needed, but the shorter blink packet duration means lower power consumption for transmissions, so for the same update frequency the battery life will be longer.

A larger percentage of air time can be used in cases where a system includes mechanisms to control when nodes transmit. For example TDMA where a coordinating node transmits a periodic beacon defining a “super-frame” that is subdivided into slots, and individual slave nodes synchronise with the beacon and transmit only in their assigned slots. Employing an accelerometer and reducing the tag blink rate when it is not moving is another technique that would allow a larger population of tag.

9.6 Low duty cycle - air time

In some geographic areas certain UWB channels are only allowed by regulations when the transmissions are following what are termed low duty cycle (LDC) rules. These LDC rules set limits on the maximum time of an individual period of transmission, a minimum time between transmissions, a percentage of TX activity allowed in any one second, and a percentage of activity allowed in any hour.

Depending on the application the LDC rules may or may not be a problem. Where LDC rules are impinging on system operation there may be an option to use a different frequency band where the LDC rules do not apply. Also, as the LDC rules relate to transmission time, using higher data rates and short preambles allows more messages be sent within the time limits.

9.7 Location schemes

This part of the discussion on operational design choices relates to RTLS location schemes. Some of the ideas and points discussed may be more generally applicable.

In general to locate a mobile node measurements are needed to be referenced to a number of fixed known location “anchor” nodes. Typically a minimum of three anchor nodes are needed to locate a mobile node in two dimensions, while a minimum four non-coplanar anchors are needed to locate a mobile node in three dimensions. The spacing of anchor nodes in an installation has to be such that four anchors are always in communication range of the mobile tag no matter where it is within the operating space. The communication range is dependent on data rate and preamble length, the choice of which is influenced by the node density requirements and perhaps also power consumption.

There are two general methods of doing location. These are time difference of arrival (TDOA) based location and time of flight (TOF) based location, the main operational points of each are outlined below. In either case the calculation of location, combining measurements from multiple anchors, is typically done by a software functionality called the *central location engine*.

Time of flight location requires two-way communication from the mobile node (tag) to each of the anchor nodes in its vicinity. Periodic message exchanges are used to measure the round trip delay and hence calculate the one way flight time between tag and anchor. The TOF times multiplied by the speed of light (and radio waves) gives the distance between the tag and the anchor. Each distance estimate defines a spherical surface, centred on the anchor, on which the tag must lie. The tag’s 3D location is yielded by the intersection of the spheres resulting from TOF measurements to the four anchors.

In time difference of arrival (TDOA) location the mobile tag blinks periodically and the blink message is received by the anchor nodes in its vicinity. When the anchor nodes have synchronised clocks so that the arrival time of the blink message at all nodes can be compared, then for each pair of anchors the time difference in the arrival of the blink message defines a hyperbolic surface on which the sending tag must lie. The tag’s 3D location is yielded by the intersection of the hyperbolic surfaces defined by the TDOA of the blink at four pairs of anchors.

For low power RTLS deployments the TDOA scheme has benefits in that the tag needs to only send a single message in order for it to be located. In contrast in the TOF scheme the tag has to send and receive multiple messages with multiple anchors, and it needs to know what anchors are in the vicinity so it can address each of them in turn correctly. TOF does not need synchronised anchors, and may suit the case where a hand held device calculates its own location as part of a navigation system. The TDOA is a lower power solution as there are fewer messages involved, and this also suits higher density deployments. The TDOA anchor clock synchronisation may be achieved via a wired clock distribution. Alternatively there are wireless techniques for clock synchronisation. Wired synchronisation may suit higher tag densities as it allows anchors to listen all the time so no tag blinks are missed or collide with the wireless clock sync messages (potentially disrupting synchronisation). Anchors should be wired for power and also with Ethernet to communicate the arrival times to the central location engine.

Two-way ranging (TOF) is good for proximity detection and separation alarms, especially when both parties in the exchange are mobile nodes.

In an RTLS the accuracy of the DW1000’s RX timestamps can give sub 10 cm resolution. Note, however that the geometry of anchors with respect to the tag can smear the accuracy of the calculated location when individual measurements are combined. Having additional anchors in range of the tag can offset this if it allows the system to select anchors with best geometry and best receive signal quality with respect to the tag being located.

9.8 General considerations

This chapter discussed the operational design choices with respect to selecting data rate, preamble length, and PRF, and the trade-offs involved in selecting for high node density versus long operating range. The discussion also indicated how these choices affect the power consumption.

In general infrequent transmission of short packets is best for a long battery life. When a large quantity of data needs sending it is best to employ the longest frame length so that the overhead of the preamble and other parts of the frame header represent a smaller proportion of the overall frame. Listening for and receiving messages is relatively the most power expensive operation within the DW1000. It is recommended that devices needing to listen all the time are connected to a mains derived power source. This would include anchor nodes in an RTLS system, and those nodes of a wireless sensor network (WSN) that are hubs nodes responsible for routing messages.

For mains powered nodes, the power consumption in the receiver is not an issue, but for battery powered nodes where it is important to ensure a reasonable battery life, it will be necessary to include schemes to reduce the time spent listening. Table 55 lists and briefly describes some techniques that can save power in receiving.

Table 55: Techniques to save power in receiving

Name	Description
<i>Low-Power Listening</i>	<p>This is a technique based on the DW1000 preamble sampling function. The IC can “sniff” the air for a short period looking for preamble, and if it does not see it return to low power sleep mode. The transmit device has to send its message with long preamble and repeat it for a period to guarantee that the preamble overlaps with the period of RX sniffing. If the IC sees preamble it stays activated until it receives the message after which it can interrupt the host microprocessor to process it. With address filtering enabled the IC can return to sleep as soon as an address mismatch is seen.</p> <p>This technique really only suits cases where traffic volume is low so the predominant activity of all nodes is occasionally sniffing the air for preamble. As every message will wake up every node in range, at least until the address mismatch, the power drain to all nodes can be quite high if there are frequent transmissions.</p>
<i>Poll for message</i>	<p>This is a technique where a battery powered node periodically sends a poll message and listens thereafter for a response from the mains powered infrastructure. The response is only sent if the infrastructure has a message for the polling node. The node sending the poll can delay turning on the receiver to allow for the response time of the infrastructure, and thereafter can use preamble detect timeout to turn of the receiver if a response is not starting. The predominant activity is then periodically sending the poll and listening for a short time for a response that does not come.</p>

Name	Description
<i>Slotted listening</i>	In this technique all devices listen for a periodic beacon from which slots are timed and then listen in their assigned slot for a message. The amount of slots and the amount of listening is dependent on the network size and required response times. The frequency of listening for beacons depends on the super-frame size and the clock drift. The listening for beacons and slot messages needs to begin early enough to allow for any clock drift. Listening in a slot needs only continue for as long as necessary to confirm that no message is being sent this time. The beacon period and resulting frequency of listening is a trade-off between power consumption and system responsiveness.
<i>Sniff mode</i>	This technique involves searching for preamble with a duty cycle of listening less than 100% of the time, e.g. 50% of the time or 25% of the time, this reduces power somewhat but it is still a relatively power hungry technique. When preamble is detected the receiver switches to full powered RX mode to receive the frame. To talk to a device employing sniff mode the transmitter needs to send a longer preamble than would otherwise be the case to give the receiver a chance to detect it and receive the frame.

10 APPENDIX 1: The IEEE 802.15.4 UWB physical layer

This appendix gives an introduction to the modulation scheme and frame structure of the UWB physical layer as specified in the IEEE 802.15.4 – 2011 standard and as implemented by the DW1000 transceiver IC. This is useful in understanding the operation of the DW1000 transceiver and its configuration options.

10.1 Frame structure overview

The UWB communications are based around the transmission and reception of frames. Figure 30 shows the general structure of the UWB frame. It begins with a synchronisation header consisting of the preamble and the SFD (start of frame delimiter), after which the PHY header (PHR) defines the length (and data rate) of the data payload part of the frame.

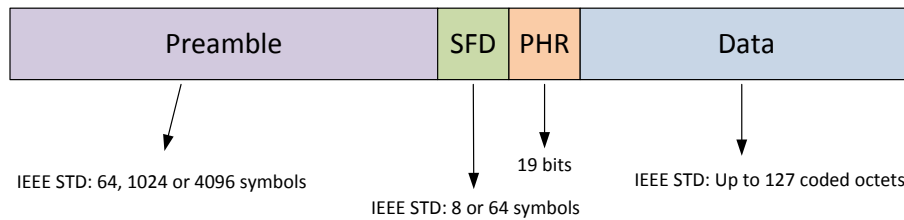

Figure 30: UWB PHY Frame structure

10.2 Data modulation scheme

The UWB used in 802.15.4 is sometimes called impulse radio UWB because it is based on high speed pulses of RF energy. During the PHR and Data parts of the frame, information bits are signalled by the position of the burst, in a modulation scheme termed burst position modulation (BPM).

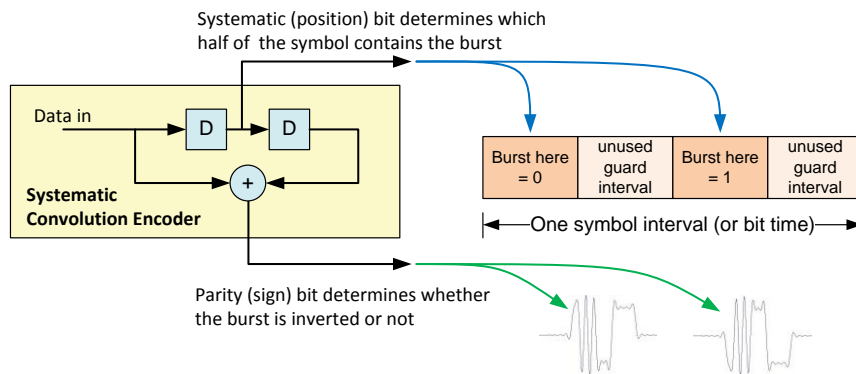

Figure 31:- BPM/BPSK data and PHR modulation

Each data bit passes through a convolution encoder to generate a “parity” bit used to set the phase of the burst as either positive or negative, this component of the modulation is termed binary phase-shift keying (BPSK). Figure 31 shows how the convolutional encoder contributes to this BPM/BPSK modulation. A coherent receiver (i.e. one tracking carrier timing and phase) such as the one in the DW1000 can determine this burst phase and use it in a Viterbi decoder to get an additional 3 dB of coding gain, thereby extending the operational range of the modulation

In addition the quarter symbol interval is sub-divided into 2, 4, or 8 sub-intervals and a pseudo random sequence used to determine both the burst shape and which of the sub-intervals are actually used for the burst transmission. This gives more immunity to interference and whitens the output spectrum allowing a higher signal power to be used in the transmitter.

Forward error correction (FEC) is also included in the PHR and Data parts of the frame. The 19-bit PHR includes a 6-bit single-error-correct double-error-detect (SECDED) code and the data part of the frame has a Reed Solomon (RS) code applied. The RS code does not reduce the data rate, as rate quoted includes allowance for the RS code already. Both SECDED and RS codes are systematic meaning that the data can be recovered without using the codes (and of course not benefitting from them in that case).

The data part of the frame may be at data rate of 110 kbps, 850 kbps, 6.8 Mbps, or 27 Mbps nominally, (these figures include a 0.87 factor of reduction on the actual symbol rate to account for the overhead of the Reed Solomon code).

For the 850 kbps, 6.8 Mbps, and 27 Mbps data rates, the 19-bit PHR part of the frame is transmitted as per the 850 kbps encoding, but without the Reed Solomon code, so their bit rate is just less than 980 kbps. For the 110 kbps data rate the PHR is transmitted as per the 110 kbps data coding, again without the Reed Solomon code, giving them a bit rate is just over 120 kbps.

The DW1000 supports 110 kbps, 850 kbps, and 6.8 Mbps data rates but does not support the 27 Mbps data rate.

10.3 Synchronisation header modulation scheme

The Synchronisation Header (SHR) consists of the preamble sequence and the SFD (start of frame delimiter). In contrast to the BPM/BPSK modulation used for the PHR and data, the synchronisation header is made up of single pulses. The symbol is divided into approximately 500 “chip” time intervals, (496/508 depending on 16/64 MHz PRF¹⁰), in which either a negative or a positive pulse may be sent, or no pulse. The “chip” interval is 499.2 MHz, a fundamental frequency within the UWB PHY, and so the resultant symbol times are thus $^{496}/_{499.2} \mu\text{s}$ for 16 MHz PRF, and $^{508}/_{499.2} \mu\text{s}$ for 64 MHz PRF, (see Table 56 below).

The sequence of pulses actually sent during the symbol interval is determined by preamble code. The standard defines 8 different length-31 preamble codes for use at 16 MHz PRF and 16 different length-127 preamble codes for use at 64 MHz PRF. The standard nominates particular codes for particular channels so that at 16 MHz PRF there are just two to choose from per channel, while at 64 MHz PRF there is a choice of four codes per channel. The length-31 codes are spread by inserting 15 zeros for each code point to give the 496 chip times per symbol while the length-127 codes are spread by inserting 3 zeros for each code point to give the 508 chip times per symbol. The preamble length is defined by how many times (i.e. for how many symbols) the sequence is repeated. This is determined by the configuration of preamble symbol repetitions (PSR).

¹⁰The DW1000 supports average pulse repetition frequencies of 16 MHz and 64 MHz

Table 56: Preamble parameters

Mean PRF (MHz)	#Chips Per Symbol	Preamble Symbol Duration (ns)
16 nominal	496	993.59
64 nominal	508	1017.63

The standard defines PSR settings of 16, 64, 1024 and 4096. The DW1000 supports these (although it will not receive frames with preamble length below 64 symbols) and in addition supports PSR settings of 128, 256, 512, 1536 and 2048.

The preamble sequence has a property of perfect periodic autocorrelation¹¹ which in essence allows a coherent receiver to determine the exact impulse response of the RF channel between transmitter and receiver. This brings two important benefits. Firstly, it allows the receiver make use of the received energy from multiple paths, turning multipath from an interference source into a positive affect extending operating range. Secondly, it lets the receiver resolve the channel in detail and determine the arrival time of the first (most direct) path, even when attenuated, which brings precision advantages for RTLS applications.

The SFD marks the end of the preamble and the precise start of the switch into the BPM/BPSK modulation of the PHR. The time-stamping of this event is very deterministic in terms of symbol times and it is this in conjunction with determining the first arriving ray within that symbol time that allows the accurate time-stamping needed for precision RTLS applications.

The standard specifies the SFD, which consists of the preamble symbols either not sent, or sent as normal or sent inverted (i.e. positive and negative pulses reversed) in a defined pattern 8 symbol times long for data rates other than 110 kbps, and 64 symbols long for the 110 kbps mode.

The length-8 SFD sequence is: 0, +1, 0, -1, +1, 0, 0, -1

The length-64 SFD sequence is: 0, +1, 0, -1, +1, 0, 0, -1, 0, +1, 0, -1, +1, 0, 0, -1, -1, 0, 0, +1, 0, -1, 0, +1, 0, +1, 0, 0, -1, 0, -1, 0, -1, 0, 0, +1, 0, -1, -1, 0, -1, +1, 0, 0, 0, 0, +1, +1, 0, 0, -1, -1, -1, +1, -1, +1, +1, 0, 0, 0, 0, +1, +1

The DW1000 has the capability for user programmability of SFD sequence, and thus has the possibility to improve upon the SFD sequence in the standard, if a non-standard SFD sequence is programmed it will be impossible to interwork with a device expecting the standard SFD sequence.

10.4 PHY header

The PHY header (PHR) is modulated using the BPM/BPSK modulation scheme defined in section 10.2 above, but it does not employ the Reed Solomon code used for data, instead is employs a 6-bit SECDED (Single error correct, Double error Detect) parity check sequence as part of its 19-bit length.

¹¹V. P. Ipatov, "Ternary sequences with ideal autocorrelation properties," Radio Eng. Electron. Phys., vol. 24, pp. 75–79, 1979

Bit 0	1	2	3	4	5	6	7	8	9	10	11	12	13	14	15	16	17	18
R1	R0	L6	L5	L4	L3	L2	L1	L0	RNG	EXT	P1	P0	C5	C4	C3	C2	C1	C0
Data Rate	Frame Length								Ranging Packet	Header Extension	Preamble Duration		SECDED Check Bits					

Figure 32: PHR bit assignment

Figure 32 above shows the bits of the PHR these are transmitted bit-0 first in time. The DW1000 fills in the Data Rate, Frame Length, Ranging Packet, and Preamble Duration fields of the PHR based on the user configuration of the appropriate parameters in [Register file: 0x08 – Transmit Frame Control](#) and generates the SECDED sequence accordingly. The Header Extension bit of the PHR is always zero and is reserved by IEEE for future extensions.

10.5 UWB channels and preamble codes

The IEEE 802.15.4 UWB PHY has 16 defined channel/bands. The DW1000 supports the subset of these listed in Table 57 below. Depending on the channel and the pulse repetition frequency (PRF) the IEEE 802.15.4 UWB PHY standard defines a choice of two or four preamble codes. The standard defined preamble code options are also listed in Table 57. The combination of channel number and preamble code gives what the standard terms a *complex channel*.

The DW1000 does not physically impose the channel code selection, so it is up to the software to select the appropriate preamble code for the selected operating channel. The standard notes that wideband channels may also employ the codes allocated to the narrower 499.2 MHz bandwidth channels if inter-channel communication is desired.

Table 57: DW1000 supported UWB channels and recommended preamble codes

Channel number	Centre frequency (MHz)	Bandwidth (MHz)	Preamble Codes (16 MHz PRF)	Preamble Codes (64 MHz PRF)
1	3494.4	499.2	1, 2	9, 10, 11, 12
2	3993.6	499.2	3, 4	9, 10, 11, 12
3	4492.8	499.2	5, 6	9, 10, 11, 12
4	3993.6	1331.2*	7, 8	17, 18, 19, 20
5	6489.6	499.2	3, 4	9, 10, 11, 12
7	6489.6	1081.6*	7, 8	17, 18, 19, 20
N.B. For correct operation of the DW1000 the software must take care to only allow selection of those preamble codes appropriate for the configured PRF.				

* The DW1000 has a maximum receive bandwidth of 900 MHz

The preamble codes specified by the standard for use on a particular channel were chosen to have a low cross correlation factor with each other with the intention that the complex channels could to operate independently from each other as separate networks. In practice, as there is still a small amount of cross correlation, there will be some break-through between different codes especially in conditions of close proximity with long preambles. This may mean that it is not possible to achieve the separation envisioned by the standard’s authors.

The IEEE 802.15.4 UWB PHY standard includes a feature called dynamic preamble select (DPS) intended for use as a security mechanism for two-way ranging, where devices switch to using one of the DPS specific preamble codes for the ranging exchange, and perhaps a different one for each direction of communication. The idea is to make it more difficult to eavesdrop or spoof, by randomly changing the DPS preamble codes in a mutually agreed sequence only known to the valid participants. This is supported by the DW1000 where at 64 MHz PRF the preamble codes additionally available for DPS are: 13, 14, 15, 16, 21, 22, 23 and 24.

10.6 Additional details on the standard

For additional details on the standard including precise details of the IEEE 802.15.4 UWB modulation, the reader is referred to the standard itself [1].

11 APPENDIX 2: The IEEE 802.15.4 MAC layer

This appendix gives an introduction to some aspects of the MAC layer defined in the IEEE 802.15.4 – 2011 standard. The DW1000 transceiver does not implement the MAC layer. The MAC layer implementation is the responsibility of the host microprocessor system controlling the DW1000. However the DW1000 includes some features to help with the MAC layer implementation. These are:

- CRC generation and checking, (see section [5.1 – Cyclic redundancy check](#)).
- Frame filtering, (see section [5.2 – Frame filtering](#)).
- Automatic acknowledgement, (see section [5.3 – Automatic Acknowledgement](#)).
- Automatic turn-around to receive acknowledgement and other responses, (see section [5.4 – Transmit and automatically wait for response](#))

An introduction to the MAC frame format is given by the sub-sections below. For more details the reader is referred to the standard itself [1].

11.1 General MAC message format

The MAC message occupies the Data portion of the UWB Frame as described in section [10.1 – Frame structure overview](#) and shown in Figure 30. This may be up to 127 octets in length according to the standard, and up to 1023 octets when employing the DW1000’s non-standard long frame mode, see section [3.4 – Extended Length Data Frames](#). The general structure of a MAC message consists of a header that identifies the frame, followed by a variable length (possibly zero) payload typically from the upper layers but sometimes (as in the case of MAC command frames) generated within the MAC itself, and finally ended by the MAC footer which is the FCS (Frame Checking Sequence) CRC used to detect transmission errors. Figure 33 shows the components of the MAC message frame in more detail, indicating the number of octets in each component.

MAC Header (MHR)							MAC Payload	MAC Footer (MFR)
Frame Control	Sequence Number	Destination PAN Identifier	Destination Address	Source PAN Identifier	Source Address	Aux Security Header	Frame Payload	FCS
2 octets	1 octet	0 or 2 octets	0, 2 or 8 octets	0 or 2 octets	0, 2 or 8 octets	0, 5, 6 10 or 14 octets	Variable number of octets	2 octets

Figure 33: General MAC message format

The MAC header is parsed by the DW1000 as part of the frame filtering function to determine if its destination address matches the IC’s address information programmed in [Register file: 0x01 –Extended Unique Identifier](#) and [Register file: 0x03 – PAN Identifier and Short Address](#) (or if the frame is a broadcast message). This parsing of receive frame is based on the contents of the Frame Control field (at the start of the MAC header) described in section 11.2 below.

11.2 The frame control field in the MAC header

The frame control field is a two-octet (16-bit) field that begins every IEEE 802.15.4 MAC frame. Its role is to identify the frame type and indicate what components are incorporated in the remainder of the MAC header. Figure 34 shows the frame control this and identifies the sub-fields within it. These are described below.

Bits 0 to 2	Bit 3	Bit 4	Bit 5	Bit 6	Bits 7 to 9	Bits 10 & 11	Bits 12 & 13	Bits 14 & 15
Frame Type	Security Enabled	Frame Pending	ACK Request	PAN ID Compress	Reserved	Dest. Address Mode	Frame Version	Source Address Mode

Figure 34: MAC message frame control field

11.2.1 Frame type field

This frame type field is a 3-bit field that indicates the type of frame. Table 58 below lists the eight possible frame types and their assignment in IEEE 802.15.4-2011.

Table 58: Frame type field values

Frame Type Field (FC bits 2 to 0)	Frame
0, 0, 0	Beacon
0, 0, 1	Data
0, 1, 0	Acknowledgement
0, 1, 1	MAC command
1, 0, 0	Reserved
1, 0, 1	Reserved
1, 1, 0	Reserved
1, 1, 1	Reserved

While only four of the eight frame types are assigned by IEEE 802.15.4-2011, some of the reserved types have since been allocated within the IEEE 802.15 Working Group for special applications. The DW1000 provides only minimal support for the new frame types by allowing their acceptance to be enabled within the frame filtering function. Please refer to section [5.2 – Frame filtering](#) for details. If these new frames are enabled then the host system will need to parse the received frames to validate each of them including checking that the destination address is correct and the host system will need to initiate the transmission of any acknowledgement response required.

11.2.2 Security enabled Field

This bit when set indicates the presence of the Auxiliary Security Header field within the MAC header and indicates that the MAC may be employing security processing of the frame payload for authentication and/or encryption. The DW1000 does not incorporate any facilities for security, so if the frame is

being secured this processing must be done by the host system. For more detail on the IEEE 802.15.4 MAC security process please refer to the standard [1].

11.2.3 Frame pending field

This bit indicates that the sending device has more data for the recipient. The reader is referred to the standard [1] for the details of this MAC protocol. The DW1000 receiver does not use the frame pending field in the receiver so it is up to the host software to handle it appropriately. The host software is also responsible for forming the TX frame and setting the frame pending bit appropriately. In the case of the DW1000's automatic acknowledgement the setting of the frame pending bit may be controlled using the AACKPEND configuration in [Register file: 0x04 – System Configuration](#). Please also see section [5.3 – Automatic Acknowledgement](#) for additional details for the auto-ACK functionality.

11.2.4 Acknowledgement request field

The acknowledgement request bit specifies whether an acknowledgment is required from the receiving device. This field should only be used in data frames or MAC command frames. If this bit is set to one, the recipient device should send an acknowledgment frame, assuming it passes the appropriate frame filtering rules. If this bit is set to zero, an acknowledgment frame should not be sent. Please refer to section [5.2 – Frame filtering](#) and section [5.3 – Automatic Acknowledgement](#) for additional details of the DW1000 support for this field. The host software is responsible for forming the TX frame and setting the acknowledgement request field appropriately. If the DW1000's Automatic Acknowledgement feature is not being employed then the host software should respond appropriately to the receipt of frames with the acknowledgement request bit set.

11.2.5 PAN ID compression field

The PAN ID compression bit specifies whether the MAC frame contains only one of the PAN identifier fields when both source and destination addresses are present. If the PAN ID compression bit is set to one and both the source and destination addresses are present, the frame shall contain only the Destination PAN Identifier field, and the Source PAN Identifier field shall be assumed equal to that of the destination. If the PAN ID compression bit is set to zero, then the PAN Identifier field shall be present if and only if the corresponding address is present. The host software is responsible for forming the TX frame and setting the PAN ID compression bit appropriately for the frame being transmitted. The host software is also responsible for correctly parsing the RX frame in the receiver including this bit. The DW1000 understands the PAN ID compression bit and parses the RX frame correctly to identify destination address and destination PAN ID during RX frame filtering (if enabled). Please refer to section [5.2 – Frame filtering](#) for additional details.

11.2.6 Destination addressing mode field

The destination addressing mode field (2-bits) specifies whether the frame contains a destination address and if so the size of the address field. Table 59 below summarises the options for destination addressing mode. For additional information on the addressing modes please refer to the standard [1].

Table 59: Destination addressing mode field values

Destination addressing mode (FC bits 11 & 10)	Meaning
0, 0	No destination address or destination PAN ID is present in the frame
0, 1	Reserved
1, 0	The destination address field is a short (16-bit) address.
1, 1	The destination address field is an extended (64-bit) address.

11.2.7 Frame version field

The frame version field (2-bits) specifies the version number of the frame. The rules for handling this are defined in [1], which says the frame version field shall be set to 0x00 to indicate a frame compatible with IEEE 802.15.4-2003 and 0x01 to indicate an IEEE 802.15.4 frame. The DW1000 understands this frame version field rules and will reject receive frames that do not have the correct frame version. Please refer to section [5.2 – Frame filtering](#) for additional details.

11.2.8 Source addressing mode field

The source addressing mode field (2-bits) specifies whether the frame contains a source address and if so the size of the address field. Table 60 below summarises the options for source addressing mode. For additional information on the addressing modes please refer to the standard [1].

Table 60: Source addressing mode field values

Source addressing mode (FC bits 15 & 14)	Meaning
0, 0	No source address or source PAN ID is present in the frame
0, 1	Reserved
1, 0	The source address field is a short (16-bit) address.
1, 1	The source address field is an extended (64-bit) address.

11.3 The Sequence Number field

The Sequence Number field, in the 802.15.4 MAC layer transmitter there should be two sequence numbers maintained, one for beacon frames transmitted and one for Data frames and MAC command frames. When auto-acknowledgement is enabled the DW1000 will copy the Sequence Number field into the acknowledgement frame for any MAC command frame or data frames it is acknowledging. The MAC layer (software) awaiting the ACK should validate the ACK’s sequence number against that of the

transmitted frame. As each new frame is transmitted (not a re-transmission of an unacknowledged frame) the sequence number should be incremented by 1 (modulo-256) after it is used in the transmitted frame.

11.4 MAC level processing in the DW1000

The DW1000 transmits data from the TX_BUFFER in a frame with data length as specified in the TFLEN and TFLE fields of the [Register file: 0x08 – Transmit Frame Control](#), inserting the 2-octet FCS as the last two octets of the data payload. The DW1000 will not do any other MAC level transmit processing. So, it is up to the host system software to prepare the correctly formatted frame conforming to the IEEE 802.15.4 standard MAC if this is required.

On the receive side, the DW1000 will validate the FCS of the received frame, and can parse frames complying with IEEE 802.15.4-2011 to validate and accept only those with destination address that is the broadcast address or matches the IC address information configured in [Register file: 0x01 – Extended Unique Identifier](#) and [Register file: 0x03 – PAN Identifier and Short Address](#). The DW1000 can also optionally respond to the acknowledgement request bit set in the frame control field, of correctly addressed Data Frames or MAC Command frames, by sending an IEEE 802.15.4-2011 compliant acknowledgement frame.

The DW1000 will deliver the received data frame in the RX_BUFFER with its data length reported by the RXFLEN and RXFLE fields of the [Register file: 0x10 – RX Frame Information Register](#), and other than the RX activities mentioned in the paragraph above the DW1000 will not do any additional MAC level receive processing. So, it is up to the host system software to correctly parse the received frame according to the IEEE 802.15.4 standard MAC definition and take whatever additional action is proscribed by the standard, if this is required.

12 APPENDIX 3: Two-Way Ranging

This appendix is for information only. It describes the two-way ranging algorithm (as used in DecaWave's ranging demo application *DecaRanging*).

NB: This algorithm is implemented by the host system software and is not a feature of the DW1000.

The DW1000 just provides the facilities for message time-stamping and precise control of message transmission times that enable this algorithm. See section [4.1.6 – RX Message timestamp](#), [3.2 – Transmission timestamp](#) and [3.3 – Delayed Transmission](#) for details of this.

In this algorithm one end acts as *Initiator*, initiating a range measurement, while the other end acts as a *Responder* listening and responding to the initiator, and calculating the range.

- The *Initiator* sends a *Poll* message addressed to the *Responder* and notes the send time, T_{SP} . The *Initiator* listens for the *Response* message.
- The *Responder* listens for a *Poll* message addressed to it. When the *Responder* receives a poll it notes the receive time T_{RP} , and sends a *Response* message back to the *Initiator*, noting its send time T_{SR} .
- When the *Initiator* receives the *Response* message it notes the receive time T_{RR} and sets the future send time of the *Final* response message T_{SF} , (a feature of DW1000), it embeds this time in the message before initiating the delayed sending of the *Final* message to the anchor.
- The *Responder* receiving this *Final* response message now has enough information to work out the range.

Figure 35 shows the ranging exchange and explains the range calculation for this two-way ranging algorithm.

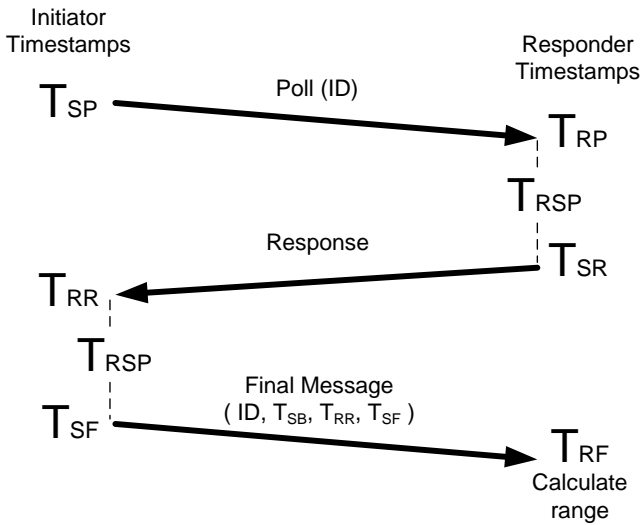

The Initiator sees Round Trip Delay time T_{TRT} of $(T_{RR} - T_{SP})$
 The Responder sees Round Trip Delay time T_{ART} of $(T_{RF} - T_{SR})$

After receiving the Final message, the Responder knows all the timestamps, so it can:
 (a) remove its response time: $(T_{SR} - T_{RP})$ from the Initiator's T_{TRT} , and
 (b) remove the Initiator's response time: $(T_{SF} - T_{RR})$ from the Responder's T_{ART} , to give antenna to antenna round trip times

The Responder then averages these two resultant round trip times to remove the effects of each ends' clock frequency differences, (a technique which works best when the RX-to-TX response T_{RSP} is the same at both ends), and divides by 2 to get a one-way trip time, or time of flight.

Putting all this into one equation gives a Time of Flight:
 $((T_{RR} - T_{SP}) - (T_{SR} - T_{RP}) + (T_{RF} - T_{SR}) - (T_{SF} - T_{RR})) / 4$

or $TOF = (2T_{RR} - T_{SP} - 2T_{SR} + T_{RP} + T_{RF} - T_{SF}) / 4.$

Multiplying the TOF by c , the speed of light (and radio waves), gives the distance (or range) between the two devices.

Figure 35: Ranging algorithm and range calculation

Note: Minimising T_{RSP} reduces the ranging error and also saves power, assuming that the *Initiator* returns to a low power state soon after sending the final message.

13 APPENDIX 4: Abbreviations and acronyms

Abbreviation	Full Title	Explanation
AGC	automatic gain control	A scheme that automatically adjusts the gain of the DW1000 receiver depending on the power in the received signal
ACK	acknowledgement (frame)	A frame sent by the DW1000 in response to a received frame indicating successful reception. DW1000 allows the automatic generation of such frames when appropriately configured.
AON	always-on block (forsaving configuration)	A section of memory in DW1000 whose contents are retained provided VDDAON is maintained above the minimum limit specified in the DW1000 data sheet. Intended for saving device configuration during the SLEEP and DEEPSLEEP states and restoring it thereafter.
BPM	burst position modulation	A modulation scheme in which information is conveyed by the position of a burst of pulses in one of a number of possible positions in a symbol
BPSK	binary phase-shift keying	A modulation scheme in which information is conveyed by whether pulses are positive or negative
CRC	cyclic redundancy check (an FCS)	Error detecting code appended to the frame in the transmitter to allow detection of errors at the receiver.
CIR	channel impulse response	The impulse response of the communications channel between transmitter and receiver as detected by DW1000 for the most recently received frame
DPS	dynamic preamble select	Anti-spoofing mechanism to allow IEEE 802.15.4 devices to move their long preamble codes to codes that are different from those in normal use, see 214[1].
ESD	electrostatic discharge	A sudden flow of electrical current between two electrically charged objects caused by contact, an electrical short circuit or dielectric breakdown. Can cause failure of semiconductor devices. DW1000 is resistant to ESD up to the limits specified in the data sheet.
EUI	extended unique identifier	64-bit IEEE device address. Refer to <i>Register file: 0x01 –Extended Unique Identifier</i> .
FCS	frame check sequence (the CRC)	A CRC appended to the frame in the transmitter to allow detection of errors at the receiver.
IF	intermediate frequency	A frequency to which a carrier frequency is shifted as an intermediate step in transmission or reception.
LDC	low duty-cycle	Certain regulatory jurisdictions define rules that limit the duration of UWB transmissions per unit time in certain channels. These rules are generally referred to as low duty cycle rules
LDO	low drop-out voltage regulator	Linear voltage regulator that requires only a small differential between its input source voltage and its output regulated voltage below which it can

Abbreviation	Full Title	Explanation
		no longer regulate correctly. DW1000 uses a number of such regulators.
LDE	leading edge (or the process to find and adjust the RX message timestamp)	Process to find and adjust the RX message timestamp
LNA	low noise amplifier	Circuit normally found at the front-end of a radio receiver designed to amplify very low level signals while keeping any added noise to as low a level as possible
LOS	line of sight	Physical radio channel configuration in which there is a direct line of sight between the transmitter and the receiver
NLOS	non line of sight	Physical radio channel configuration in which there is no direct line of sight between the transmitter and the receiver
OTP	one-time programmable (memory)	Internal memory in DW1000 that can be programmed once to store various identification and calibration values
PAC	preamble acquisition chunk	A group of preamble symbols which are correlated together in the preamble detection process in the receiver. The size of the PAC is configurable –see Sub-Register 0x27:08 – DRX_TUNE2 . The selection of the most appropriate PAC size is discussed in section 4.1.1
PHR	PHY header	A 19-bit section of the IEEE802.15.4-2011 UWB frame that comes directly after the SFD and before the message payload and defines various characteristics of that payload required by the receiver for successful reception.
PHY	physical layer	Defined in the context of the OSI 7-layer model for communications systems in general and the IEEE802.15.4-2011 UWB standard in particular, the PHY layer is the lowest layer in the 7-layer model and defines the physical interface to the communications medium
PLL	phase locked loop	Phase locked loop used to generate stable frequency clocks. These are used in DW1000 to generate carrier frequencies and system clocks.
PRF	pulse repetition frequency	Defined in the context of the IEEE802.15.4-2011 [1] standard. This is the frequency at which pulses are repeated in the preamble and data portions of a frame depending on the chosen configuration.
PSR	preamble symbol repetitions	Used to define the overall preamble length. A larger number of preamble symbol repetitions give a longer preamble.
RF	radio frequency	Generally used to refer to signals in the range of 3 kHz to 300 GHz. In the context of a radio receiver, the term is generally used to refer to circuits in a receiver before down-conversion takes place and in a transmitter after up-conversion takes place
RMARKER	ranging marker (start of PHR at antenna)	Defined in the context of the IEEE802.15.4-2011 [1] standard. Defines the start of the PHR at the antenna in either transmit or receive

Abbreviation	Full Title	Explanation
RTLS	real time location systems	System intended to provide information on the location of various items in real-time.
RX	receive or receiver	Term used to refer to the receiver section of a transceiver or the operation of receiving signals
SAR	Successive Approximation Register ADC	A type of Analog to Digital converter that used a digital binary search to converge on the correct digital representation of the analog input level.
SECDED	single error correct, double error detect (a parity check sequence in the PHR)	<p>A coding scheme that allows the: -</p> <ul style="list-style-type: none"> • detection and correction of a single bit error in a group of bits or • the detection but not the correction of a double bit error in a group of bits <p>The IEEE802.15.4-2011 UWB standard defines the use of such a scheme as a parity check in the PHR portion of the frame.</p>
SFD	start of frame delimiter	Defined in the context of the IEEE802.15.4-2011 [1] standard. Indicates the completion of the preamble section of the frame and the commencement of the payload section.
SHR	synchronisation header (consists of preamble and SFD)	Defined in the context of the IEEE802.15.4-2011 [1] standard. The first portion of an IEEE802.15.4-2011 UWB frame containing the preamble and SFD
SPI	serial peripheral interface	An industry accepted method for interfacing between IC's using a synchronous serial scheme first introduced by Motorola
TDOA	time difference of arrival	Method of deriving information on the location of a transmitter. The time of arrival of a transmission at two physically different locations whose clocks are synchronized is noted and the difference in the arrival times provides information on the location of the transmitter. A number of such TDOA measurements at different locations can be used to uniquely determine the position of the transmitter. Refer to DecaWave's website for further information.
TOF	time of flight	The time taken for a radio signal to travel between the transmitting antenna and the receiving antenna
TX	transmit or transmitter	Term used to refer to the transmitter section of a transceiver or the operation of transmitting signals
UWB	ultra wide band	A radio scheme employing channel bandwidths of, or in excess of, 500MHz
WSN	wireless sensor networks	A network of wireless nodes intended to enable the monitoring and control of the physical environment
XTI	internal 19.2 MHz clock (is the raw 38.4 MHz XTAL oscillator input ÷ 2)	The 38.4 MHz XTAL oscillator clock divided by 2.

14 APPENDIX 5: References

- [1] IEEE 802.15.4-2011 or “IEEE Std 802.15.4™-2011” (Revision of IEEE Std 802.15.4-2006). IEEE Standard for Local and metropolitan area networks - Part 15.4: Low-Rate Wireless Personal Area Networks (LR-WPANs). IEEE Computer Society Sponsored by the LAN/MAN Standards Committee. Available from <http://standards.ieee.org/>.

Document History

Table 61: Document History

Revision	Date	Description
1.00	15 th November 2013	First release
2.01	31 st March 2014	Scheduled update
2.02	31 st July 2014	Scheduled update

About DecaWave

DecaWave is a pioneering fabless semiconductor company whose flagship product, the DW1000, is a complete, single chip CMOS Ultra-Wideband IC based on the IEEE 802.15.4 standard UWB PHY. This device is the first in a family of parts.

The resulting silicon has a wide range of standards-based applications for both Real Time Location Systems (RTLS) and Ultra Low Power Wireless Transceivers in areas as diverse as manufacturing, healthcare, lighting, security, transport, and inventory and supply-chain management.

For further information on this or any other DecaWave product contact a sales representative as follows: -

DecaWave Ltd,
Adelaide Chambers,
Peter Street,
Dublin 8,
Ireland.

<mailto:sales@decawave.com>

<http://www.decawave.com/>