

---

# FCC Test Report

---

Report No.: AGC00901130703FE04

**FCC ID** : 2AAQHD70A1

**APPLICATION PURPOSE** : Original Equipment

**PRODUCT DESIGNATION** : Tablet PC

**BRAND NAME** : AOC

**MODEL NAME** : D70A14-2S, D70A15-2N,D70A15-2M,D70A15-1N,  
D70A15-1S,D70A15-1M,D70A15-3N,D70A15-3M,  
D70A15-3S,MID709D70A14-2N,D70A14-2R,  
D70A14-2B,D70A14-2P

**CLIENT** : AAPPAA TECHNOLOGY(HK) LIMITED

**DATE OF ISSUE** : Aug.13,2013

**STANDARD(S)** : FCC Part 15 Rules

**REPORT VERSION** : V1.0

Attestation of Global Compliance (Shenzhen) Co., Ltd



**CAUTION:**

This report shall not be reproduced except in full without the written permission of the test laboratory and shall not be quoted out of context.

### Report Revise Record

Report Version	Revise Time	Issued Date	Valid Version	Notes
V1.0	/	Aug.13,2013	Valid	Original Report

## TABLE OF CONTENTS

<b>1. VERIFICATION OF CONFORMITY .....</b>	<b>5</b>
<b>2. GENERAL INFORMATION .....</b>	<b>6</b>
2.1. PRODUCT DESCRIPTION .....	6
2.2. TABLE OF CARRIER FREQUENCYS .....	6
2.3. IEEE 802.11N MODULATION SCHEME .....	7
2.4. RELATED SUBMITTAL(S) / GRANT (S) .....	7
2.5. TEST METHODOLOGY .....	7
2.6. SPECIAL ACCESSORIES .....	7
2.7. EQUIPMENT MODIFICATIONS .....	7
<b>3. MEASUREMENT UNCERTAINTY .....</b>	<b>8</b>
<b>4. DESCRIPTION OF TEST MODES .....</b>	<b>8</b>
<b>5. SYSTEM TEST CONFIGURATION .....</b>	<b>9</b>
5.1. CONFIGURATION OF EUT SYSTEM .....	9
5.2. EQUIPMENT USED IN EUT SYSTEM .....	9
5.3. SUMMARY OF TEST RESULTS .....	9
<b>6. TEST FACILITY .....</b>	<b>10</b>
<b>7. PEAK OUTPUT POWER .....</b>	<b>11</b>
7.1. MEASUREMENT PROCEDURE .....	11
7.2. TEST SET-UP (BLOCK DIAGRAM OF CONFIGURATION) .....	11
7.3. LIMITS AND MEASUREMENT RESULT .....	12
<b>8. 6DB BANDWIDTH .....</b>	<b>14</b>
8.1. MEASUREMENT PROCEDURE .....	14
8.2. TEST SET-UP (BLOCK DIAGRAM OF CONFIGURATION) .....	14
8.3. LIMITS AND MEASUREMENT RESULTS .....	15
<b>9. CONDUCTED SPURIOUS EMISSION .....</b>	<b>25</b>
9.1. MEASUREMENT PROCEDURE .....	25
9.2. TEST SET-UP (BLOCK DIAGRAM OF CONFIGURATION) .....	25
9.3. MEASUREMENT EQUIPMENT USED .....	25
9.4. LIMITS AND MEASUREMENT RESULT .....	25
<b>10. MAXIMUM CONDUCTED OUTPUT POWER SPECTRAL DENSITY .....</b>	<b>28</b>
10.1 MEASUREMENT PROCEDURE .....	28
10.2 TEST SET-UP (BLOCK DIAGRAM OF CONFIGURATION) .....	28
10.3 MEASUREMENT EQUIPMENT USED .....	28
10.4 LIMITS AND MEASUREMENT RESULT .....	28

<b>11. RADIATED EMISSION .....</b>	<b>38</b>
11.1. MEASUREMENT PROCEDURE .....	38
11.2. TEST SETUP .....	39
11.3. LIMITS AND MEASUREMENT RESULT .....	40
11.4. TEST RESULT .....	40
<b>12. BAND EDGE EMISSION .....</b>	<b>49</b>
12.1. MEASUREMENT PROCEDURE .....	49
12.2. TEST SET-UP .....	49
12.3. TEST RESULT .....	50
<b>13. FCC LINE CONDUCTED EMISSION TEST .....</b>	<b>58</b>
13.1. LIMITS OF LINE CONDUCTED EMISSION TEST .....	58
13.2. BLOCK DIAGRAM OF LINE CONDUCTED EMISSION TEST .....	58
13.3. PRELIMINARY PROCEDURE OF LINE CONDUCTED EMISSION TEST .....	59
13.4. FINAL PROCEDURE OF LINE CONDUCTED EMISSION TEST .....	59
13.5. TEST RESULT OF LINE CONDUCTED EMISSION TEST .....	60
<b>APPENDIX A: PHOTOGRAPHS OF TEST SETUP .....</b>	<b>62</b>
<b>APPENDIX B: PHOTOGRAPHS OF EUT .....</b>	<b>64</b>

### 1. VERIFICATION OF CONFORMITY

<b>Applicant</b>	AAPPAA TECHNOLOGY(HK) LIMITED
<b>Address</b>	4F, BUILDING 5 SANWEIHUAFENG 1ST TECH PARK, XIXIANG, BAO'AN, SHENZHEN
<b>Manufacturer</b>	AAPPAA TECHNOLOGY(HK) LIMITED
<b>Address</b>	4F, BUILDING 5 SANWEIHUAFENG 1ST TECH PARK, XIXIANG, BAO'AN, SHENZHEN
<b>Product Designation</b>	Tablet PC
<b>Brand Name</b>	AOC
<b>Test Model</b>	D70A14-2S
<b>Series Model</b>	D70A15-2N, D70A15-2M, D70A15-1N, D70A15-1S, D70A15-1M, D70A15-3N, D70A15-3M, D70A15-3S, MID709, D70A14-2N, D70A14-2R, D70A14-2B, D70A14-2P
<b>Difference description</b>	All the same except for the model name.
<b>Date of test</b>	Aug.06~ Aug.12,2013
<b>Deviation</b>	None
<b>Condition of Test Sample</b>	Normal
<b>Report Template</b>	AGCRT-US-BGN/RF (2013-03-01)

We hereby certify that:

The above equipment was tested by Attestation of Global Compliance (Shenzhen) Co., Ltd. The test data, data evaluation, test procedures, and equipment configurations shown in this report were made in accordance with the procedures given in ANSI C63.4 (2003) and the energy emitted by the sample EUT tested as described in this report is in compliance with requirement of FCC Part 15 Rules requirement.

Prepared By

*Wall Huang*

Wall Huang Aug.13,2013

Checked By

*Forrest Lei*

Forrest Lei Aug.13,2013

Authorized By

*Solger Zhang*

Solger Zhang Aug.13,2013

## 2. GENERAL INFORMATION

### 2.1. PRODUCT DESCRIPTION

The EUT is designed as “Tablet PC”. It is designed by way of utilizing the DSSS and OFDM technology to achieve the system operation.

A major technical description of EUT is described as following

<b>Operation Frequency</b>	2.412 GHz~2.462GHz
<b>Output Power</b>	IEEE 802.11b:11.57dBm; IEEE 802.11g:10.61dBm; IEEE 802.11n(20):9.68dBm; IEEE 802.11n(40):7.59dBm
<b>Modulation</b>	DSSS(BPSK/QPSK/CCK);OFDM(16-QAM/64-QAM)
<b>Number of channels</b>	11
<b>Hardware Version</b>	N/A
<b>Software Version</b>	N/A
<b>Antenna Designation</b>	Integrated Antenna
<b>Antenna Gain</b>	1.0dBi
<b>Power Supply</b>	DC3.7V by Built-in Li-ion Battery

### 2.2. TABLE OF CARRIER FREQUENCIES

Frequency Band	Channel Number	Frequency
2400~2483.5MHZ	1	2412 MHZ
	2	2417 MHZ
	3	2422 MHZ
	4	2427 MHZ
	5	2432 MHZ
	6	2437 MHZ
	7	2442 MHZ
	8	2447 MHZ
	9	2452 MHZ
	10	2457 MHZ
	11	2462 MHZ

Note: For 20MHZ bandwidth system use Channel 1 to Channel 11

For 40MHZ bandwidth system use Channel 3 to Channel 9

### 2.3. IEEE 802.11N MODULATION SCHEME

MCS Index	Nss	Modulation	R	NBPSK	Data rate(Mbps)		
					800nsGI		
					20MHz	20MHz	20MHz
0	1	BPSK	1/2	1	52	26	6.5
1	1	QPSK	1/2	2	104	52	13.0
2	1	QPSK	3/4	2	104	78	19.5
3	1	16-QAM	1/2	4	208	104	26.0
4	1	16-QAM	3/4	4	208	156	39.0
5	1	64-QAM	2/3	6	312	208	52.0
6	1	64-QAM	3/4	6	312	234	58.5
7	1	64-QAM	5/6	6	312	260	65.0

Symbol	Explanation
NSS	Number of spatial streams
R	Code rate
NBPSK	Number of coded bits per single carrier
NCBPS	Number of coded bits per symbol
NDBPS	Number of data bits per symbol
GI	Guard interval

### 2.4. RELATED SUBMITTAL(S) / GRANT (S)

This submittal(s) (test report) is intended for **FCC ID: 2AAQHD70A1** filing to comply with the FCC Part 15 requirements.

### 2.5. TEST METHODOLOGY

Both conducted and radiated testing was performed according to the procedures in ANSI C63.4 (2003). Radiated testing was performed at an antenna to EUT distance 3 meters. Others testing (listed at item 5.3) was performed according to the procedures in FCC Part 15.247 rules.

### 2.6. SPECIAL ACCESSORIES

Refer to section 5.2.

### 2.7. EQUIPMENT MODIFICATIONS

Not available for this EUT intended for grant.

### 3. MEASUREMENT UNCERTAINTY

Conducted measurement: +/- 2.75dB

Radiated measurement: +/- 3.2dB

### 4. DESCRIPTION OF TEST MODES

NO.	TEST MODE DESCRIPTION
1	Low channel TX
2	Middle channel TX
3	High channel TX
4	Normal operating

Note:

1. V means worst mode for Conducted Emission.
2. Transmit by 802.11b with Data rate (1/2/5.5/11)  
Transmit by 802.11g with Data rate (6/9/12/18/24/36/48/54)  
Transmit by 802.11n (20MHz) with Data rate (6.5/13/19.5/26/39/52/58.5/65)  
Transmit by 802.11n (40MHz) with Data rate (13.5/27/40.5/54/81/108/121.5/135)

**Note:**

1. The EUT has been set to operate continuously on the lowest, middle and highest operation frequency individually.
2. All modes under which configure applicable have been tested and the worst mode test data recording in the test report, if no other mode data.
3. For Radiated Emission, 3axis were chosen for testing for each applicable mode.



## 5. SYSTEM TEST CONFIGURATION

### 5.1. CONFIGURATION OF EUT SYSTEM

Configure:



### 5.2. EQUIPMENT USED IN EUT SYSTEM

Item	Equipment	Mfr/Brand	Model/Type No.	Remark
1	Tablet PC	AOC	D70A14-2S	EUT
2	Battery	N/A	N/A	Accessory
3	Adapter	N/A	N/A	Accessory
4	Laptop	Dell	INSPIRON	A.E

Note: All the accessories have been used during the test in conduction emission test.

### 5.3. SUMMARY OF TEST RESULTS

FCC RULES	DESCRIPTION OF TEST	RESULT
§15.247	Peak Output Power	Compliant
§15.247	6 dB Bandwidth	Compliant
§15.247	Conducted Spurious Emission	Compliant
§15.247	Maximum Conducted Output Power SPECTRAL Density	Compliant
§15.209	Radiated Emission	Compliant
§15.247	Band Edges	Compliant
§15.207	Line Conduction Emission	Compliant

**Note:** The EUT received power from DC3.7V lithium battery.

## 6. TEST FACILITY

<b>Site</b>	Attestation of Global Compliance (Shenzhen) Co., Ltd
<b>Location</b>	2/F., Building 2, No.1-No.4, Chaxi Sanwei Technical Industrial Park, Gushu, Xixiang, Bao'an District, Shenzhen, Guangdong, China
<b>Description</b>	The test site is constructed and calibrated to meet the FCC requirements in documents ANSI C63.4:2003.

### ALL TEST EQUIPMENT LIST

Description	Manufacturer	Model	S/N	Cal. Date	Cal. Due
Power Probe	R&S	NRP-Z23	100323	07/17/2013	07/16/2014
RF attenuator	N/A	RFA20db	68	N/A	N/A
Spectrum Analyzer	Agilent	E4440A	US41421290	07/17/2013	07/16/2014
Amplifier	EM	EM30180	0607030	07/17/2013	07/16/2014
Horn Antenna	EM	EM-AH-10180	67	04/21/2013	04/20/2014
Horn Antenna	A.H. Systems Inc.	SAS-574	--	07/17/2013	07/16/2014
EMI Test Receiver	Rohde & Schwarz	ESCI	100694	07/17/2013	07/16/2014
Biological Antenna	A.H. Systems Inc.	SAS-521-4	26	06/07/2013	06/06/2014
Loop Antenna	A.H.	SAS-526B	264	07/14/2013	07/13/2014
LISN	R&S	ESH3-Z5	--	07/17/2013	07/16/2014

## 7. PEAK OUTPUT POWER

### 7.1. MEASUREMENT PROCEDURE

For peak power test:

1. The EUT was placed on a turn table which is 0.8m above ground plane.
2. Connect EUT RF output port to the Spectrum Analyzer through an RF attenuator
3. Set the EUT Work on the top, middle and the bottom operation frequency individually.
4. Set the RBW  $\geq$  DTS bandwidth, VBW  $\geq$  3 x RBW, span  $\geq$  3 x RBW, Sweep time = auto couple, Detector = peak, Trace mode = max hold, Allow trace to fully stabilize.
5. Use peak marker function to determine the peak amplitude level.

For average power test:

1. The EUT was placed on a table which is 0.8m above ground plane.
2. Connect EUT RF output port to power probe through an RF attenuator.
3. Connect the power probe to the PC.
4. Set the EUT Work on the top, the middle and the bottom operation frequency individually.
5. Record the maximum power from the software.
6. The maximum peak power shall be less 1 Watt (30dBm).

**Note :** The EUT was tested according to KDB 558074 for compliance to FCC 47CFR 15.247 requirements.

### 7.2. TEST SET-UP (BLOCK DIAGRAM OF CONFIGURATION)

#### PEAK POWER TEST SETUP

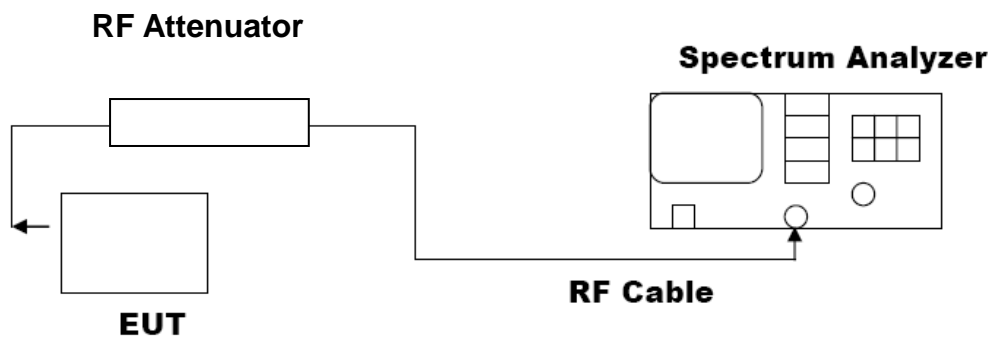

#### AVERAGE POWER SETUP

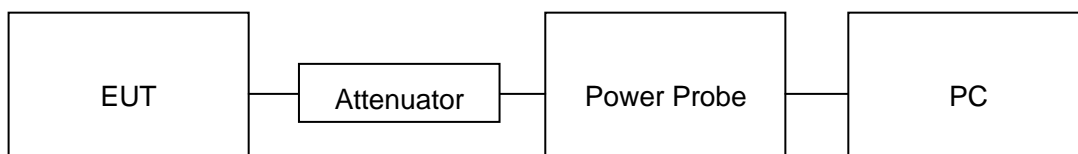

**7.3. LIMITS AND MEASUREMENT RESULT**

<b>TEST ITEM</b>	PEAK POWER
<b>TEST MODE</b>	802.11b with data rate 1

<b>LIMITS AND MEASUREMENT RESULT</b>				
<b>Frequency (GHz)</b>	<b>Average Power (dBm)</b>	<b>Peak Power (dBm)</b>	<b>Applicable Limits (dBm)</b>	<b>Pass or Fail</b>
2.412	9.64	11.57	30	Pass
2.437	9.55	11.48	30	Pass
2.462	9.41	11.35	30	Pass

<b>TEST ITEM</b>	PEAK POWER
<b>TEST MODE</b>	802.11g with data rate 6

<b>LIMITS AND MEASUREMENT RESULT</b>				
<b>Frequency (GHz)</b>	<b>Average Power (dBm)</b>	<b>Peak Power (dBm)</b>	<b>Applicable Limits (dBm)</b>	<b>Pass or Fail</b>
2.412	8.62	10.61	30	Pass
2.437	8.58	10.53	30	Pass
2.462	8.53	10.48	30	Pass

<b>TEST ITEM</b>	PEAK POWER
<b>TEST MODE</b>	802.11n 20 with data rate 6.5

<b>LIMITS AND MEASUREMENT RESULT</b>				
<b>Frequency (GHz)</b>	<b>Average Power (dBm)</b>	<b>Peak Power (dBm)</b>	<b>Applicable Limits (dBm)</b>	<b>Pass or Fail</b>
2.412	7.72	9.68	30	Pass
2.437	7.63	9.59	30	Pass
2.462	7.58	9.52	30	Pass

<b>TEST ITEM</b>	PEAK POWER
<b>TEST MODE</b>	802.11n 40 with data rate 13.5

<b>LIMITS AND MEASUREMENT RESULT</b>				
<b>Frequency (GHz)</b>	<b>Average Power (dBm)</b>	<b>Peak Power (dBm)</b>	<b>Applicable Limits (dBm)</b>	<b>Pass or Fail</b>
2.422	5.65	7.59	30	Pass
2.437	5.51	7.45	30	Pass
2.452	5.47	7.42	30	Pass

## 8. 6DB BANDWIDTH

### 8.1. MEASUREMENT PROCEDURE

1. The EUT was placed on a table which is 0.8m above ground plane.
2. Connect EUT RF output port to the Spectrum Analyzer through an RF attenuator
3. Set the EUT Work on the top, the middle and the bottom operation frequency individually.
4. Set SPA Centre Frequency = Operation Frequency, RBW= 100 KHz, VBW  $\geq$  RBW.
5. Set SPA Trace 1 Max hold, then View.

**Note:** The EUT was tested according to KDB 558074 for compliance to FCC 47CFR 15.247 requirements.

### 8.2. TEST SET-UP (BLOCK DIAGRAM OF CONFIGURATION)

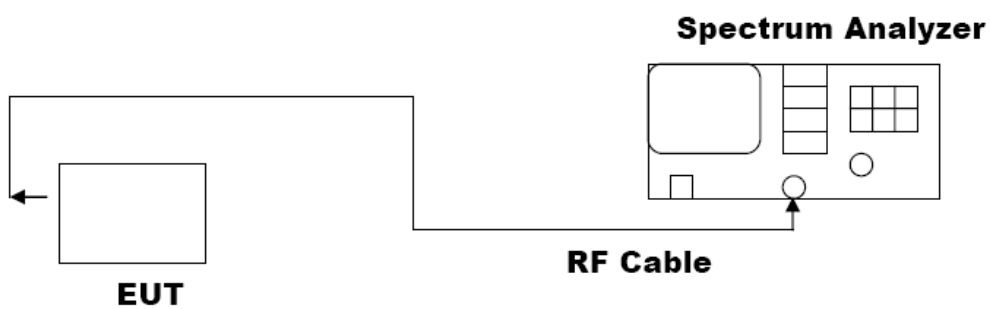

**8.3. LIMITS AND MEASUREMENT RESULTS**

<b>TEST ITEM</b>	6DB BANDWIDTH
<b>TEST MODE</b>	802.11b with data rate 11

<b>LIMITS AND MEASUREMENT RESULT</b>			
<b>Applicable Limits</b>	<b>Applicable Limits</b>		
	<b>Test Data (MHz)</b>		<b>Criteria</b>
>500KHZ	Low Channel	10.120	PASS
	Middle Channel	10.098	PASS
	High Channel	10.086	PASS

<b>TEST ITEM</b>	6DB BANDWIDTH
<b>TEST MODE</b>	802.11g with data rate 54

<b>LIMITS AND MEASUREMENT RESULT</b>			
<b>Applicable Limits</b>	<b>Applicable Limits</b>		
	<b>Test Data (MHz)</b>		<b>Criteria</b>
>500KHZ	Low Channel	15.674	PASS
	Middle Channel	16.349	PASS
	High Channel	16.311	PASS

<b>TEST ITEM</b>	6DB BANDWIDTH
<b>TEST MODE</b>	802.11n 20 with data rate 65

<b>LIMITS AND MEASUREMENT RESULT</b>			
<b>Applicable Limits</b>	<b>Applicable Limits</b>		
	<b>Test Data (MHz)</b>		<b>Criteria</b>
>500KHZ	Low Channel	16.079	PASS
	Middle Channel	17.497	PASS
	High Channel	16.284	PASS

<b>TEST ITEM</b>	6DB BANDWIDTH
<b>TEST MODE</b>	802.11n 40 with data rate 135

<b>LIMITS AND MEASUREMENT RESULT</b>			
<b>Applicable Limits</b>	<b>Applicable Limits</b>		
	<b>Test Data (MHz)</b>		<b>Criteria</b>
>500KHZ	Low Channel	35.366	PASS
	Middle Channel	35.210	PASS
	High Channel	35.179	PASS



**802.11b TEST RESULT**  
**TEST PLOT OF BANDWIDTH FOR LOW CHANNEL**

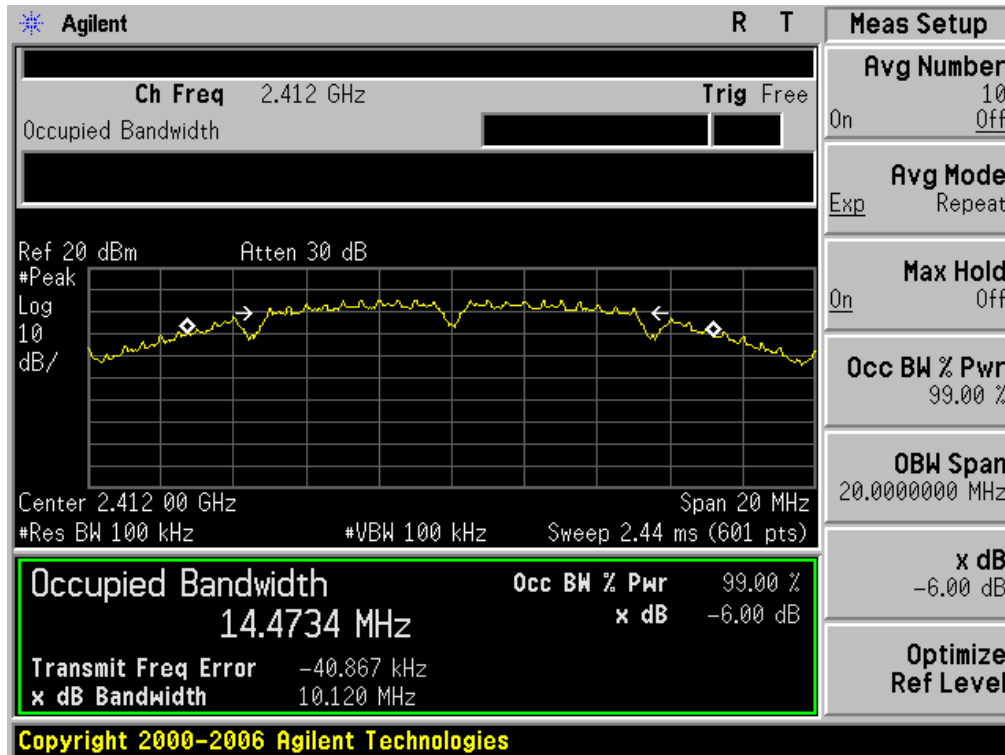

**TEST PLOT OF BANDWIDTH FOR MIDDLE CHANNEL**

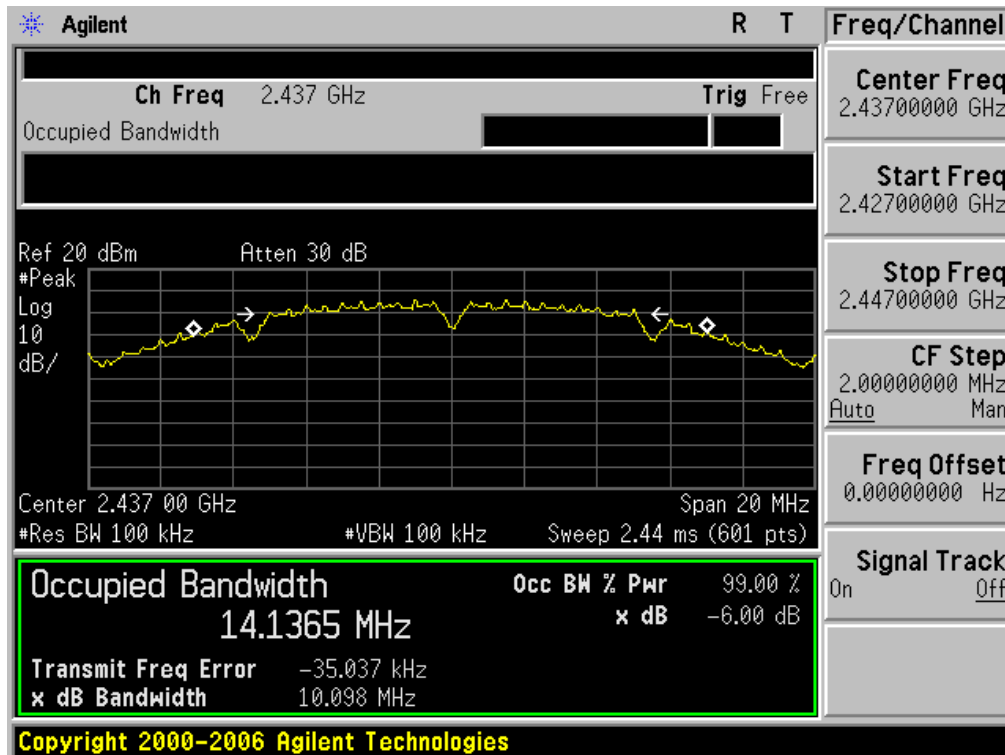

TEST PLOT OF BANDWIDTH FOR HIGH CHANNEL

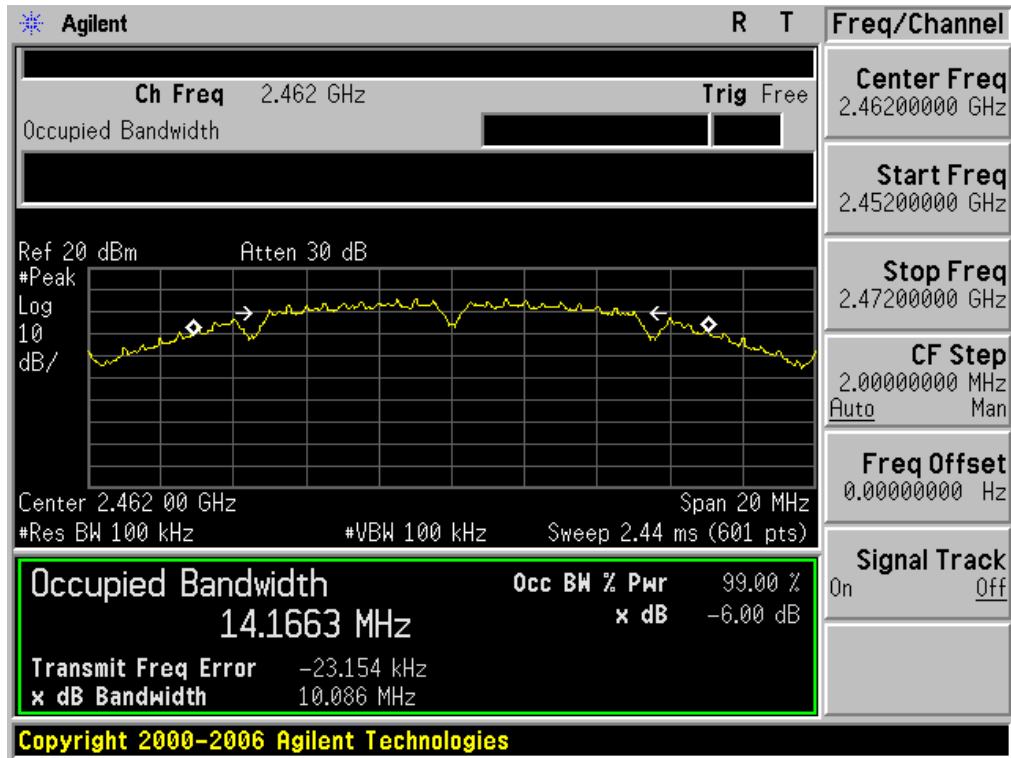

**802.11g TEST RESULT**  
**TEST PLOT OF BANDWIDTH FOR LOW CHANNEL**

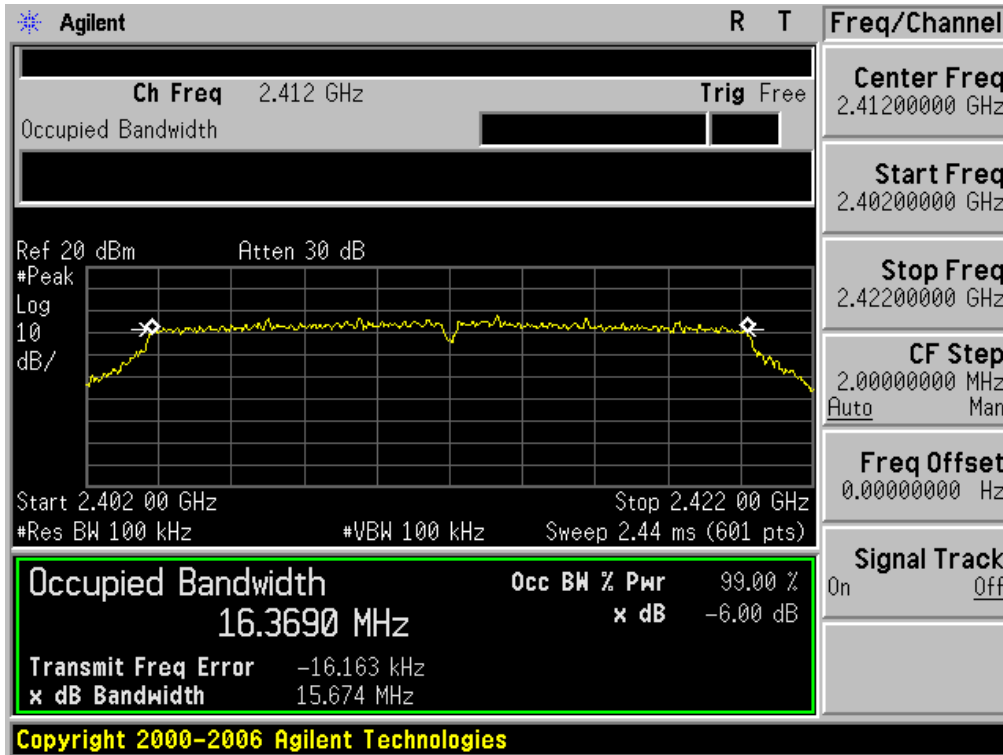

**TEST PLOT OF BANDWIDTH FOR MIDDLE CHANNEL**

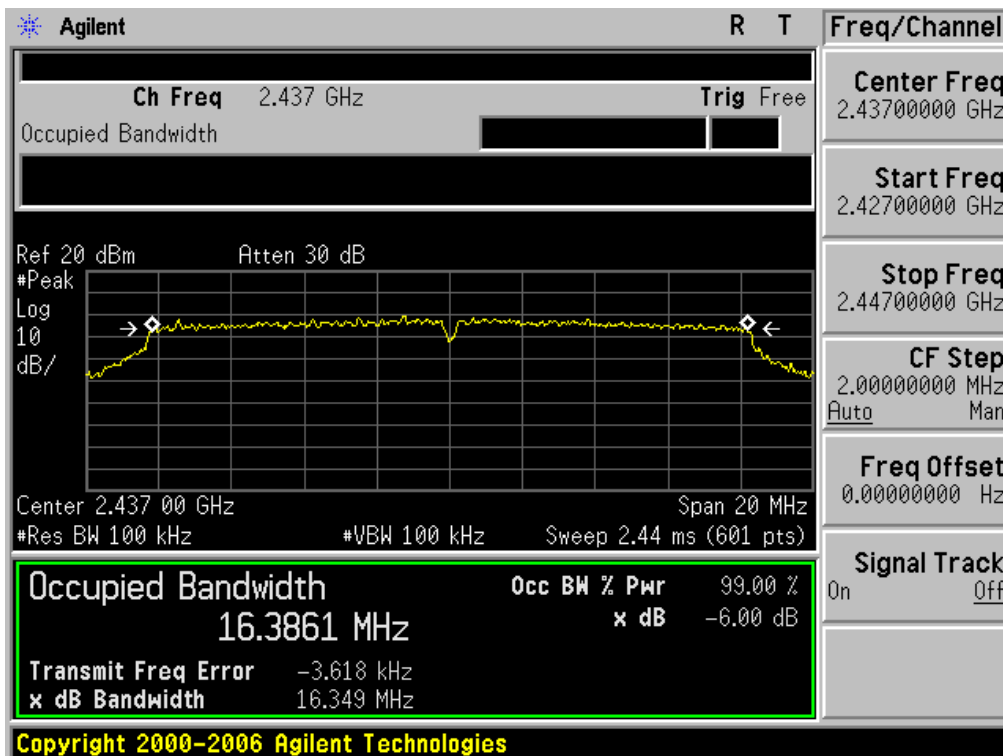

TEST PLOT OF BANDWIDTH FOR HIGH CHANNEL

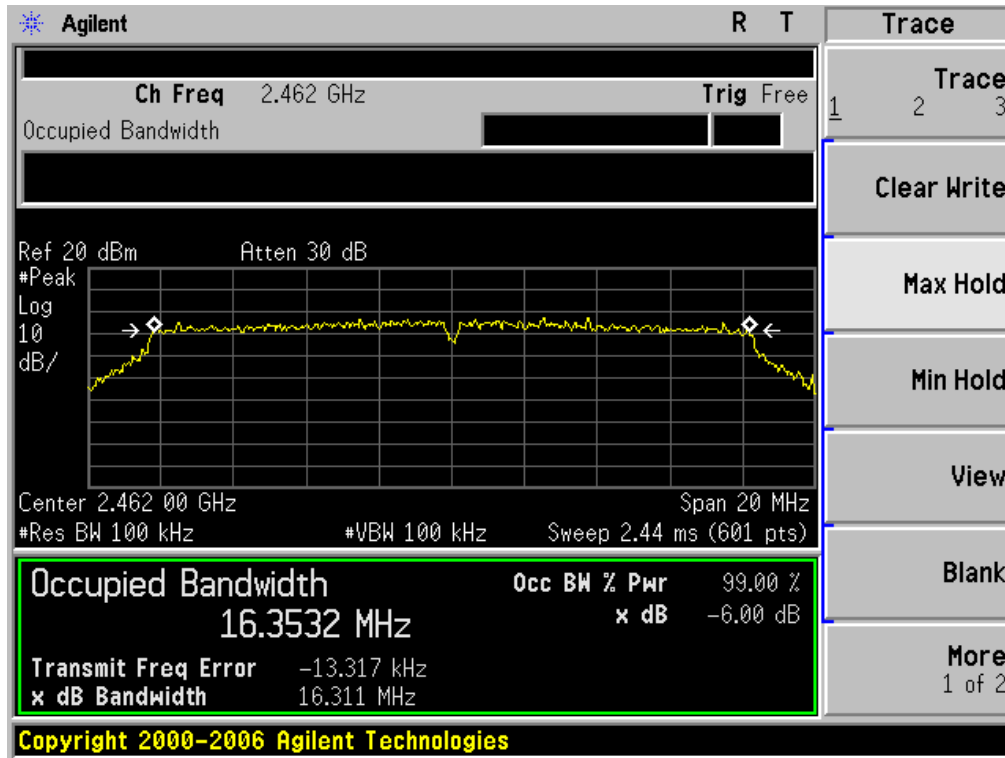

### 802.11n(20) TEST RESULT

#### TEST PLOT OF BANDWIDTH FOR LOW CHANNEL

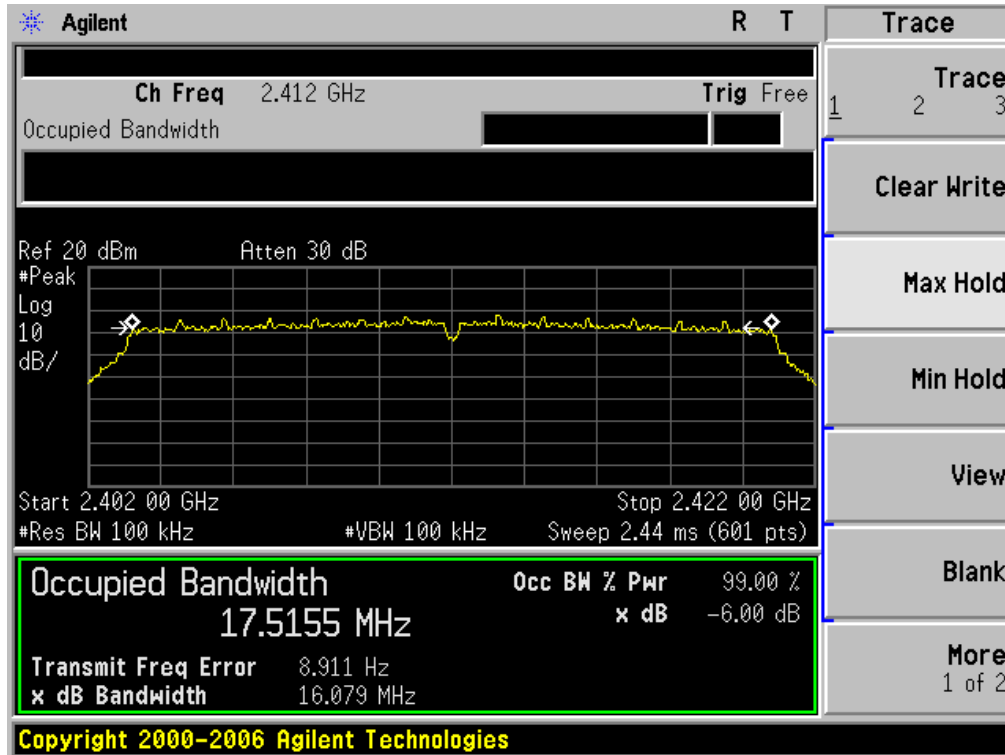

#### TEST PLOT OF BANDWIDTH FOR MIDDLE CHANNEL

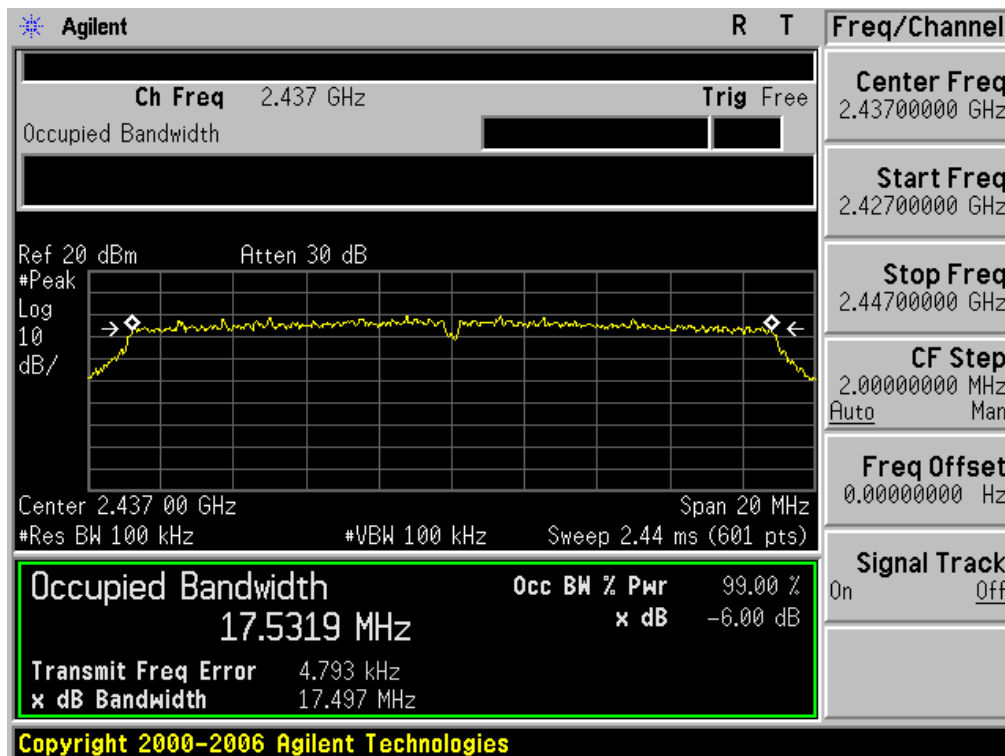

TEST PLOT OF BANDWIDTH FOR HIGH CHANNEL

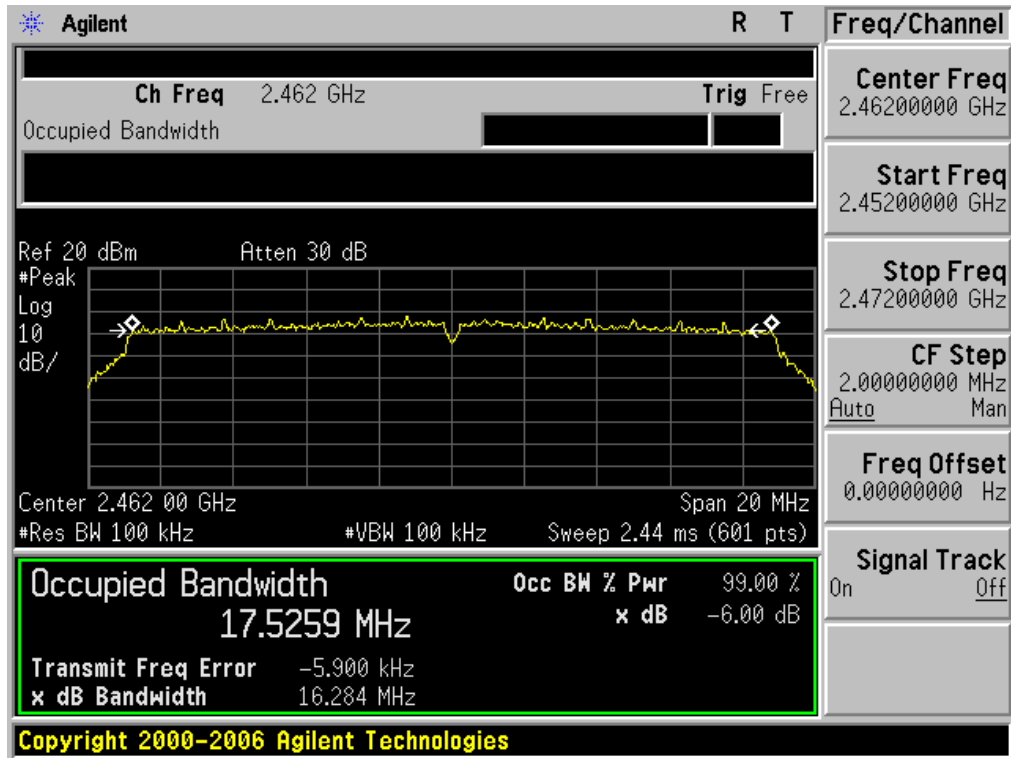

### 802.11n(40) TEST RESULT

#### TEST PLOT OF BANDWIDTH FOR LOW CHANNEL

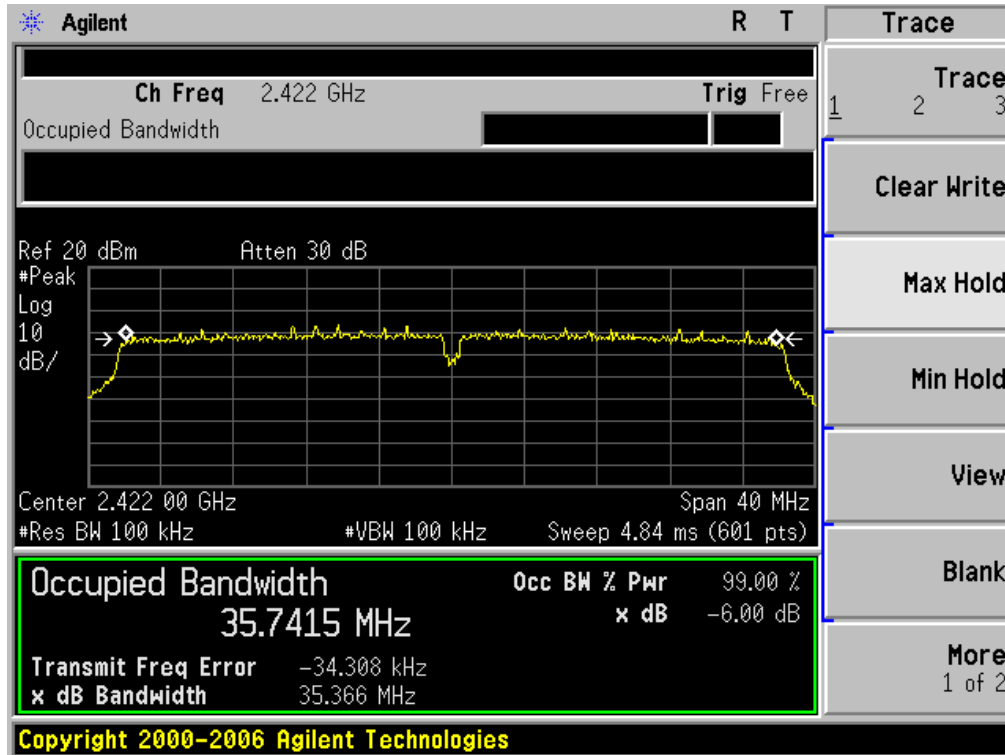

#### TEST PLOT OF BANDWIDTH FOR MIDDLE CHANNEL

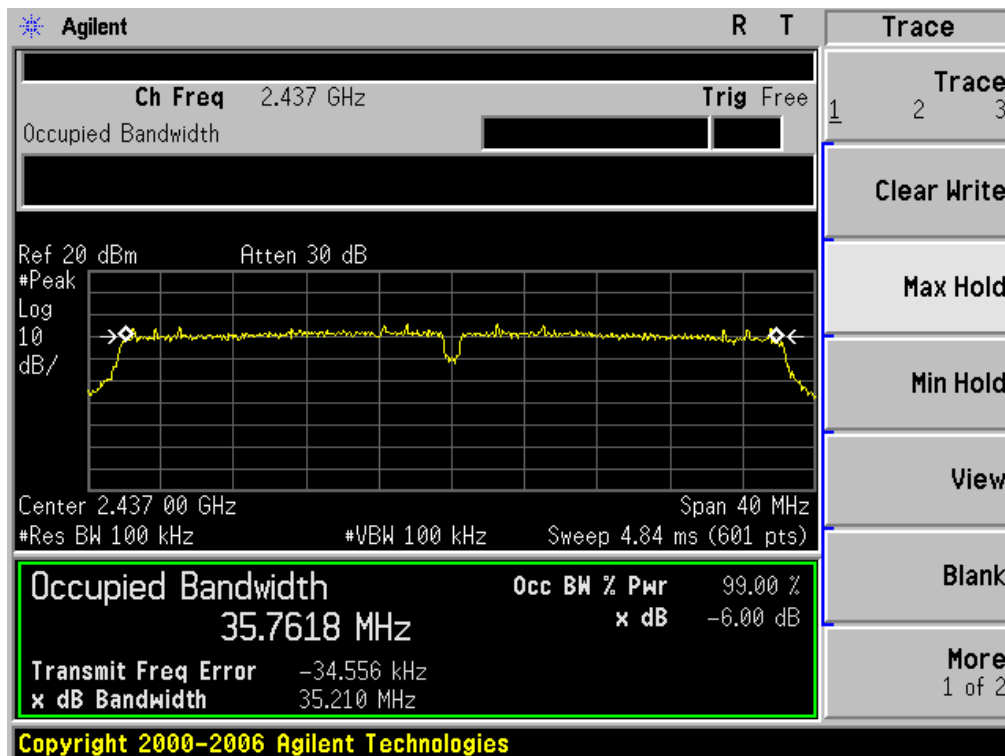

TEST PLOT OF BANDWIDTH FOR HIGH CHANNEL

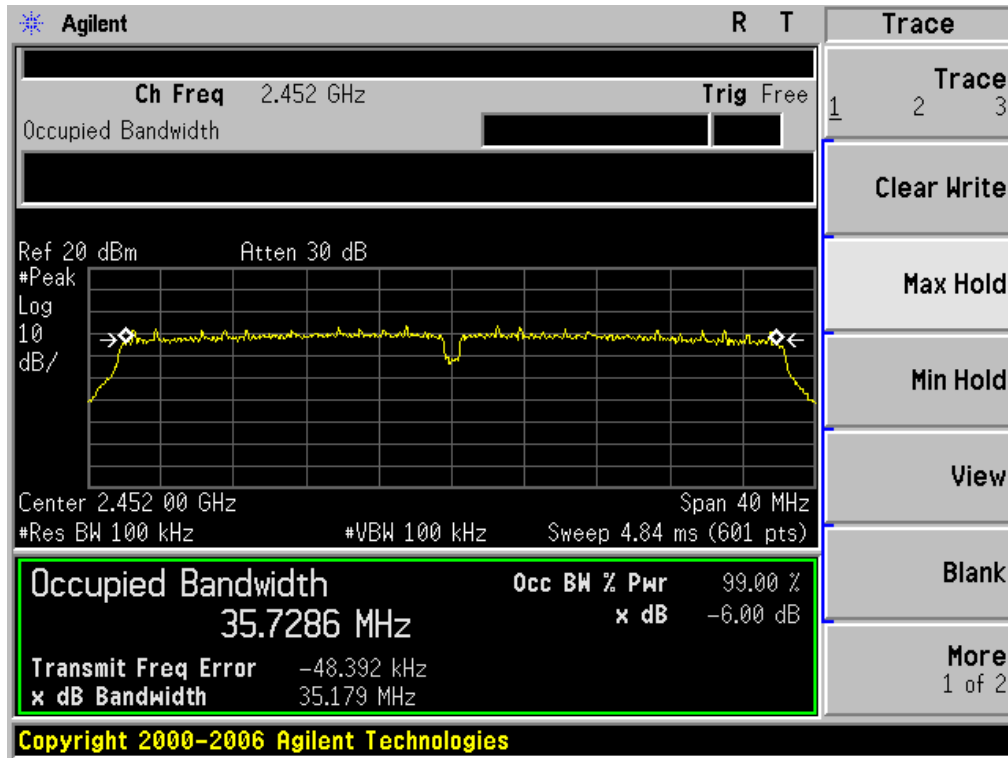



## 9. CONDUCTED SPURIOUS EMISSION

### 9.1. MEASUREMENT PROCEDURE

1. The EUT was placed on a turn table which is 0.8m above ground plane.
2. Connect EUT RF output port to the Spectrum Analyzer through an RF attenuator
- 3, Set the EUT Work on the top, the middle and the bottom operation frequency individually.
4. Set SPA Trace 1 Max hold, then View.

**Note:** The EUT was tested according to KDB 558074 for compliance to FCC 47CFR 15.247 requirements.  
Set RBW = 100 kHz, Set VBW > RBW, scan up through 10th harmonic.

### 9.2. TEST SET-UP (BLOCK DIAGRAM OF CONFIGURATION)

The same as described in section 8.2.

### 9.3. MEASUREMENT EQUIPMENT USED

The same as described in section 6.

### 9.4. LIMITS AND MEASUREMENT RESULT

LIMITS AND MEASUREMENT RESULT		
Applicable Limits	Measurement Result	
	Test Data	Criteria
In any 100 KHz Bandwidth Outside the frequency band in which the spread spectrum intentional radiator is operating, the radio frequency power that is produce by the intentional radiator shall be at least 20 dB below that in 100KHz bandwidth within the band that contains the highest level of the desired power. In addition, radiation emissions which fall in the restricted bands, as defined in §15.205(a), must also comply with the radiated emission limits specified in§15.209(a)	At least -20dBc than the limit Specified on the BOTTOM Channel	PASS
	At least -20dBc than the limit Specified on the TOP Channel	PASS

TEST PLOT OF OUT OF BAND EMISSIONS WITH THE WORST CASE  
 OF 802.11b FOR MODULATION IN LOW CHANNEL

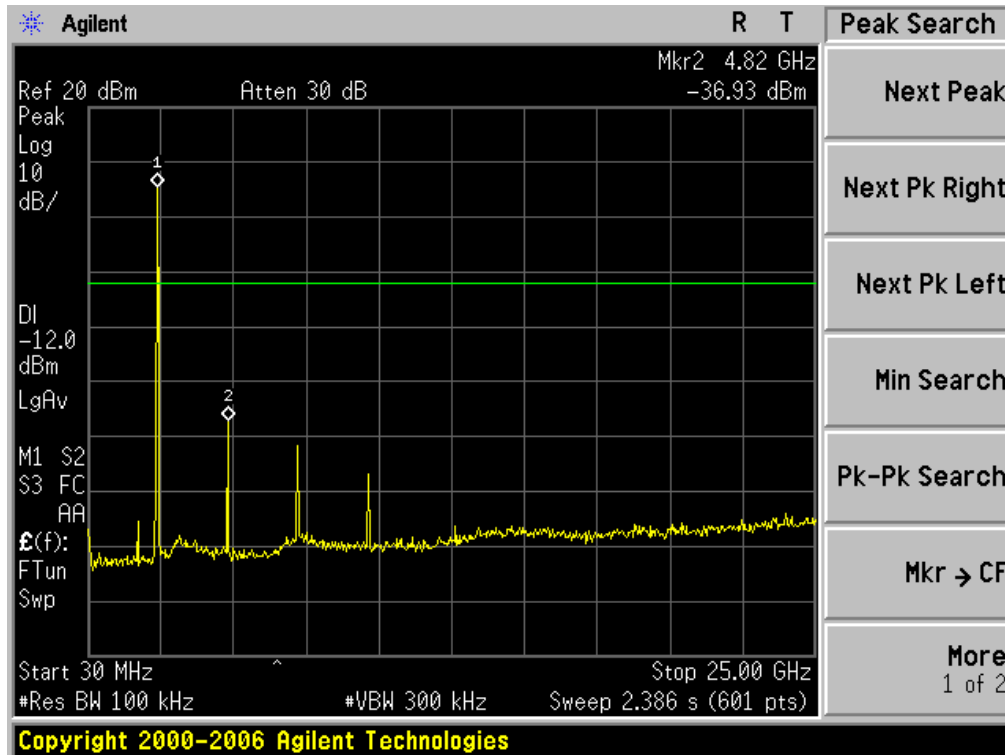

TEST PLOT OF OUT OF BAND EMISSIONS  
 OF 802.11b FOR MODULATION IN MIDDLE CHANNEL

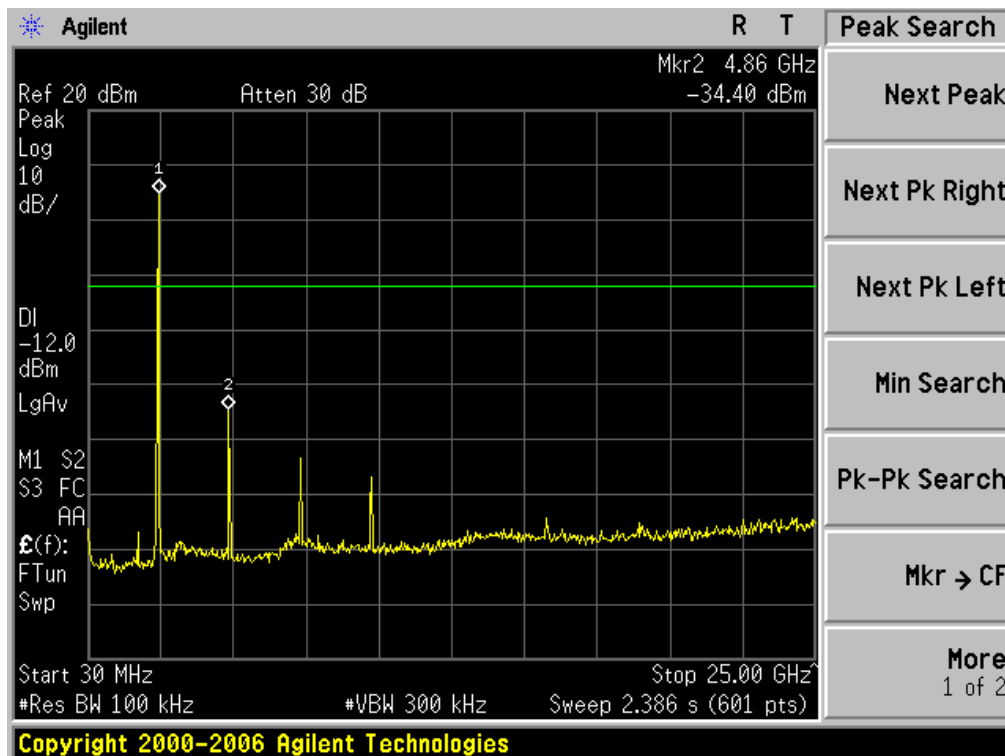

TEST PLOT OF OUT OF BAND EMISSIONS  
OF 802.11b FOR MODULATION IN HIGH CHANNEL

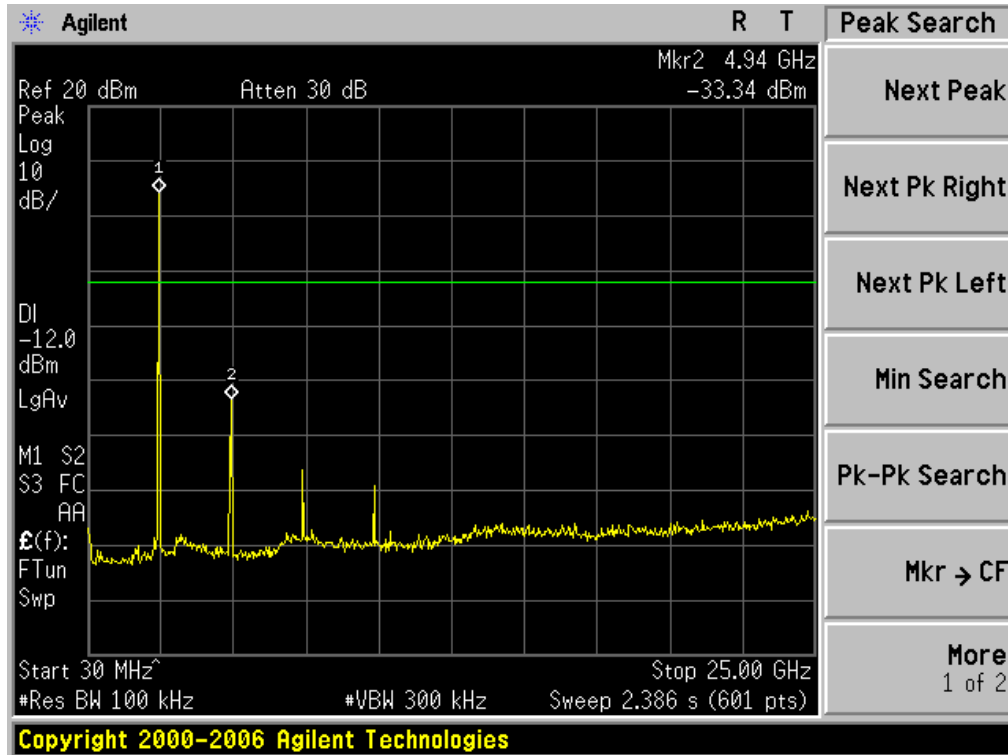

**10. MAXIMUM CONDUCTED OUTPUT POWER SPECTRAL DENSITY**

**10.1 MEASUREMENT PROCEDURE**

- (1). The EUT was placed on a turn table which is 0.8m above ground plane.
- (2). Connect EUT RF output port to the Spectrum Analyzer through an RF attenuator
- (3). Set the EUT Work on the top, the middle and the bottom operation frequency individually.
- (4). Set SPA Trace 1 Max hold, then View.

Note: The method of PKPSD in the KDB 558074 item 10.2 was used in this testing.

**10.2 TEST SET-UP (BLOCK DIAGRAM OF CONFIGURATION)**

Refer To Section 8.2.

**10.3 MEASUREMENT EQUIPMENT USED**

Refer To Section 6.

**10.4 LIMITS AND MEASUREMENT RESULT**

<b>TEST ITEM</b>	POWER PECTRAL DENSITY
<b>TEST MODE</b>	802.11b with data rate 1

Channel No.	PSD (dBm)	Limit (dBm)	Result
Low Channel	-7.83	8	Pass
Middle Channel	-7.94	8	Pass
High Channel	-8.73	8	Pass

<b>TEST ITEM</b>	POWER PECTRAL DENSITY
<b>TEST MODE</b>	802.11g with data rate 6

Channel No.	PSD (dBm)	Limit (dBm)	Result
Low Channel	-15.34	8	Pass
Middle Channel	-12.82	8	Pass
High Channel	-15.63	8	Pass

<b>TEST ITEM</b>	POWER PECTRAL DENSITY
------------------	-----------------------

<b>TEST MODE</b>	802.11n 20 with data rate 6.5
------------------	-------------------------------

Channel No.	PSD (dBm)	Limit (dBm)	Result
Low Channel	-15.95	8	Pass
Middle Channel	-13.36	8	Pass
High Channel	-14.95	8	Pass

<b>TEST ITEM</b>	POWER PECTRAL DENSITY
<b>TEST MODE</b>	802.11n 40 with data rate 13.5

Channel No.	PSD (dBm)	Limit (dBm)	Result
Low Channel	-21.55	8	Pass
Middle Channel	-15.7	8	Pass
High Channel	-20.18	8	Pass

**802.11b TEST RESULT**  
 TEST PLOT OF SPECTRAL DENSITY FOR LOW CHANNEL

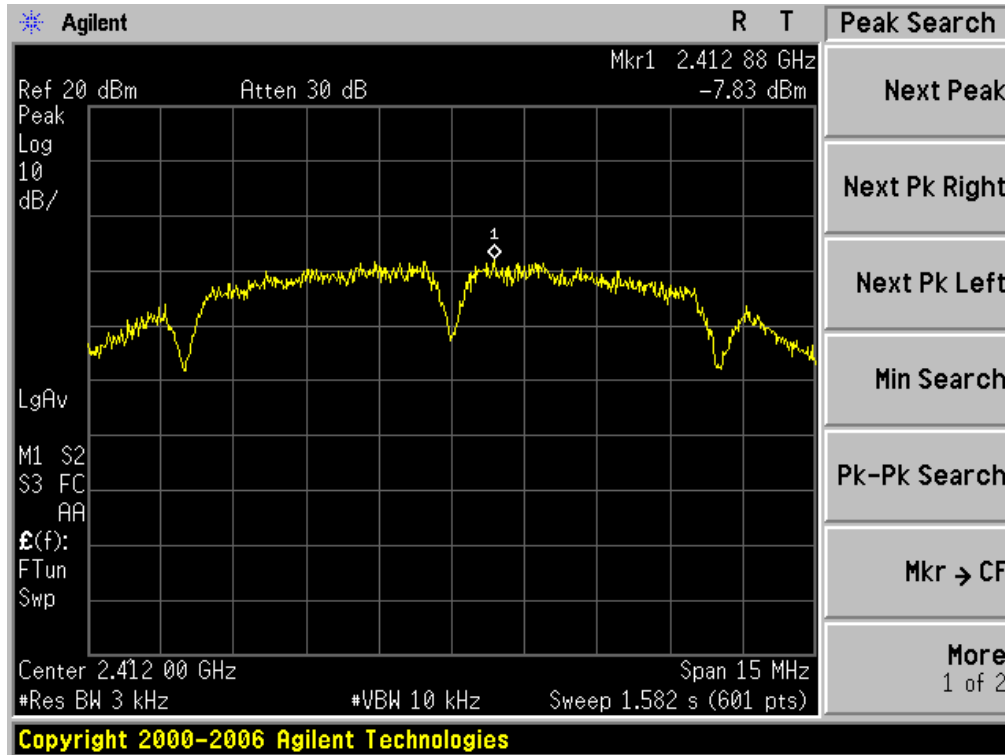

TEST PLOT OF SPECTRAL DENSITY FOR MIDDLE CHANNEL

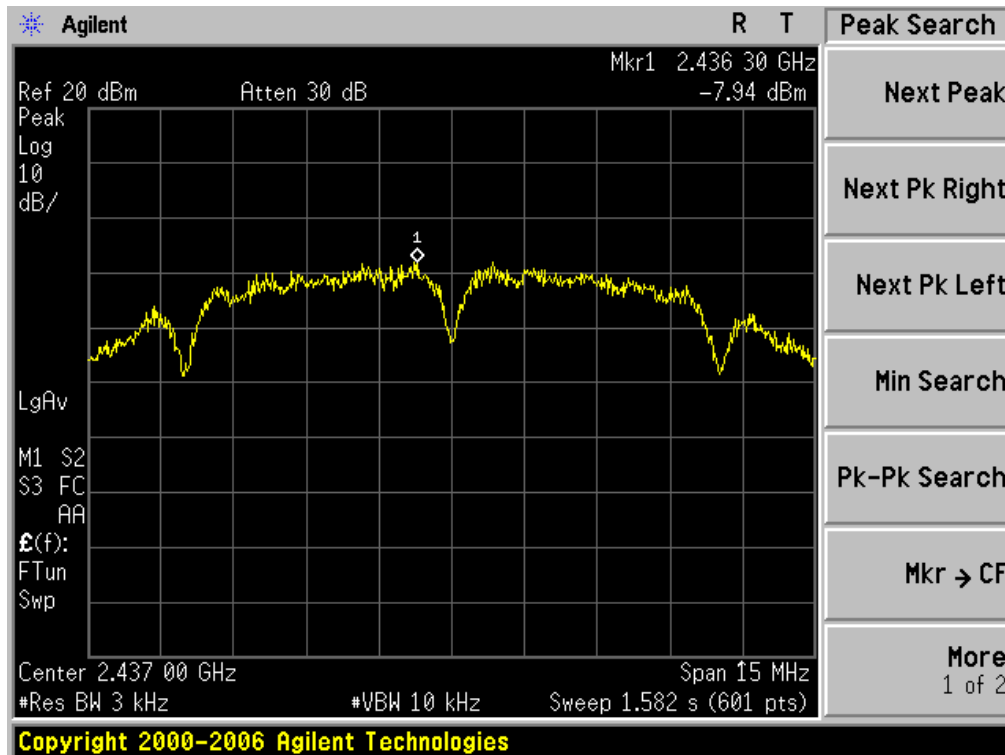

TEST PLOT OF SPECTRAL DENSITY FOR HIGH CHANNEL

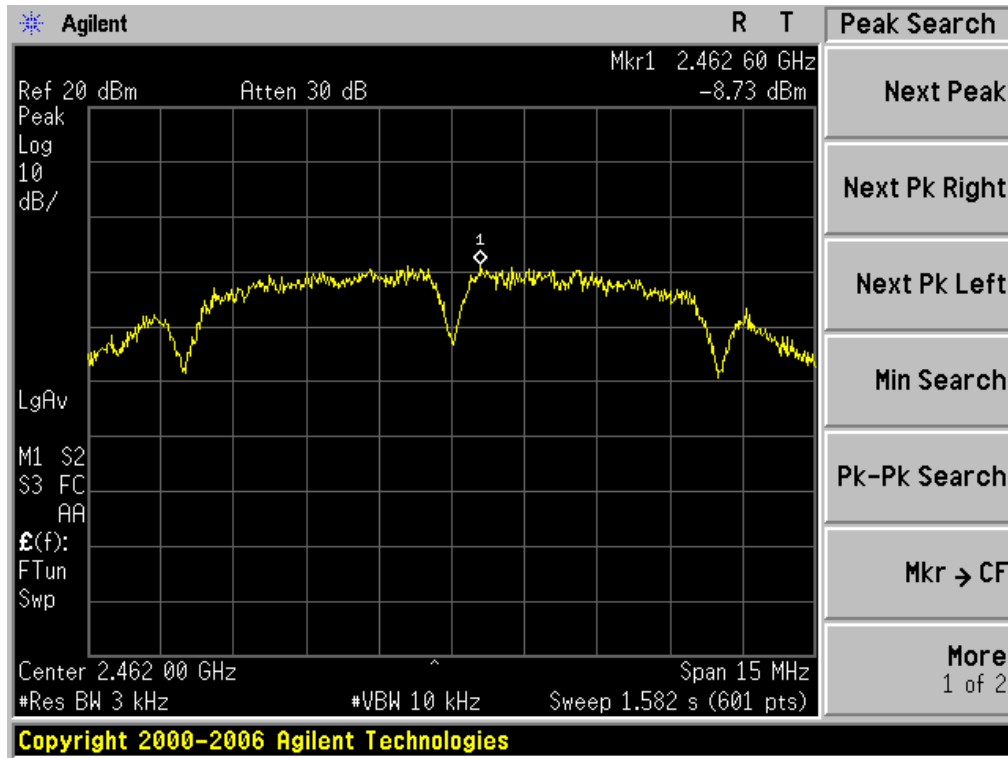

**802.11g TEST RESULT**  
**TEST PLOT OF SPECTRAL DENSITY FOR LOW CHANNEL**

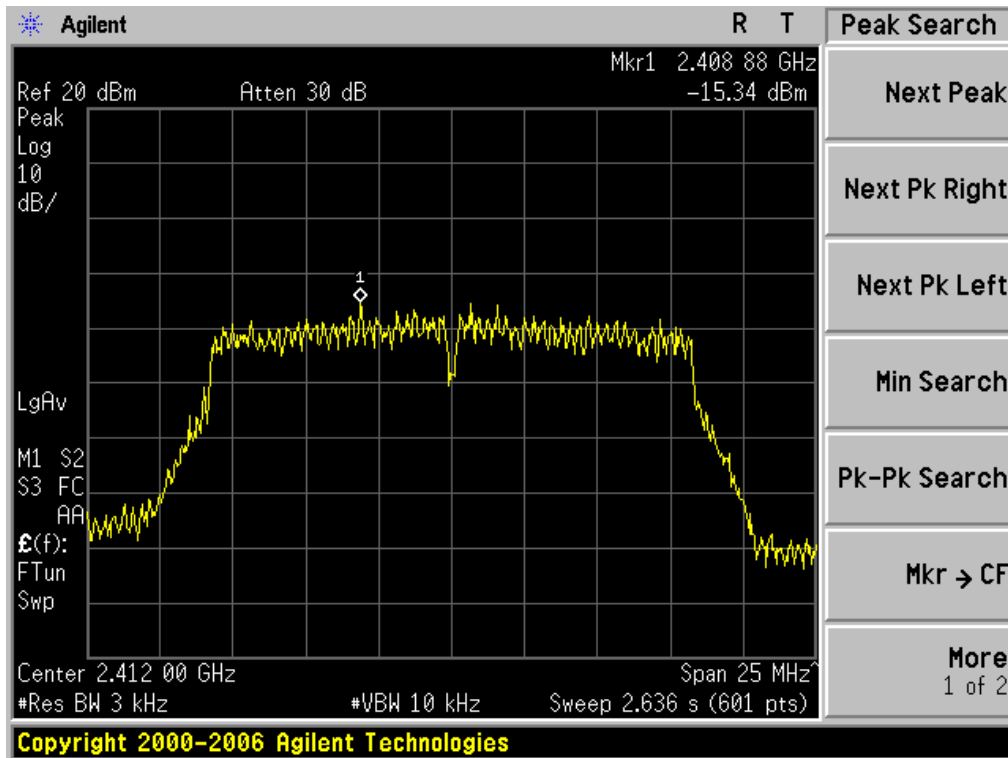

**TEST PLOT OF SPECTRAL DENSITY FOR MIDDLE CHANNEL**

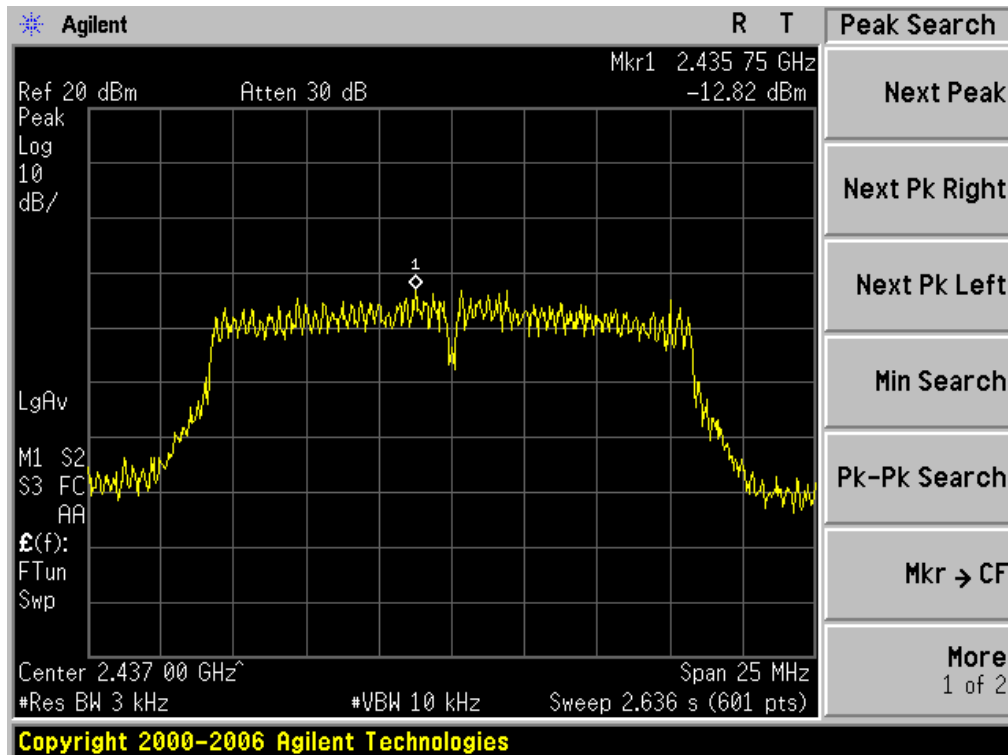



TEST PLOT OF SPECTRAL DENSITY FOR HIGH CHANNEL

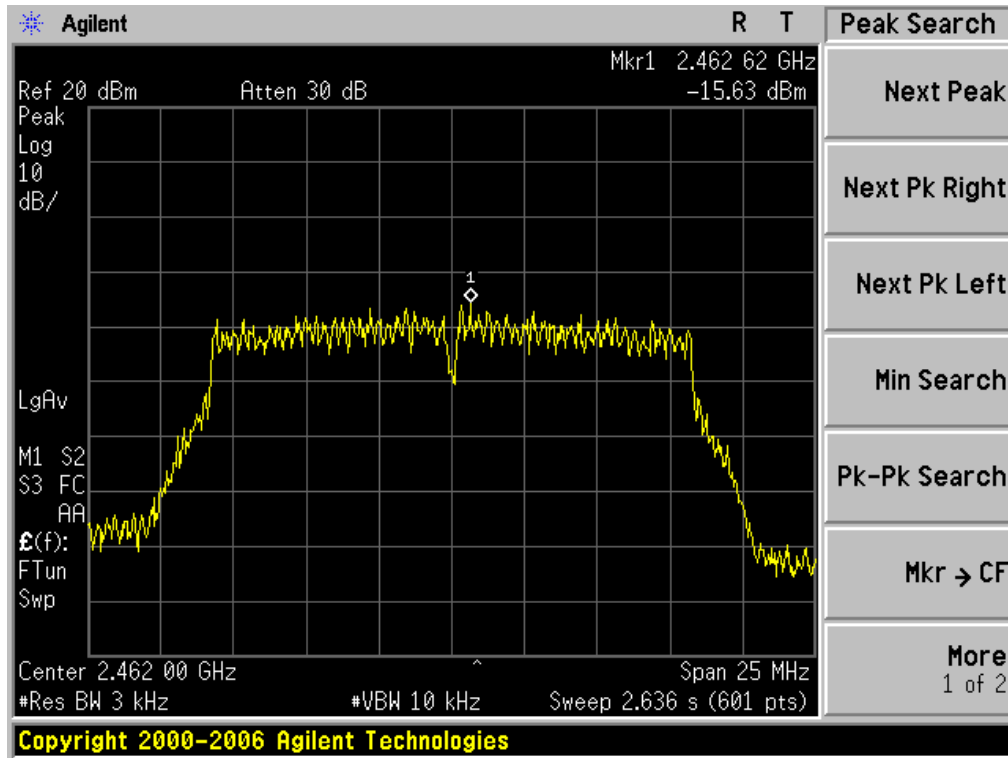

**802.11n 20 TEST RESULT**  
 TEST PLOT OF SPECTRAL DENSITY FOR LOW CHANNEL

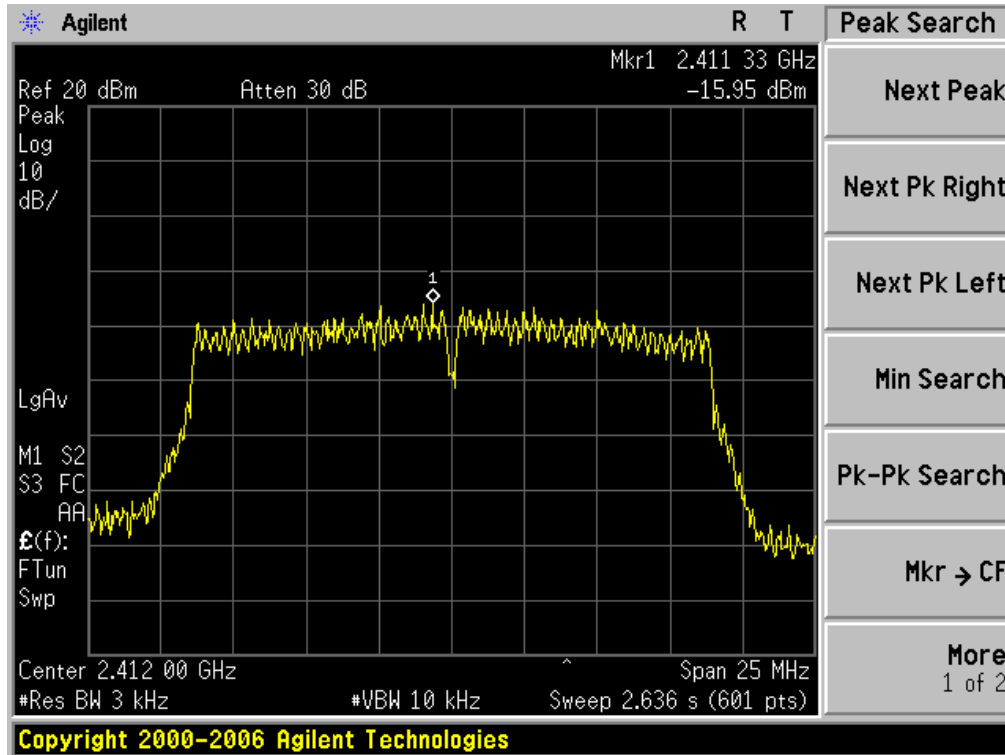

**TEST PLOT OF SPECTRAL DENSITY FOR MIDDLE CHANNEL**

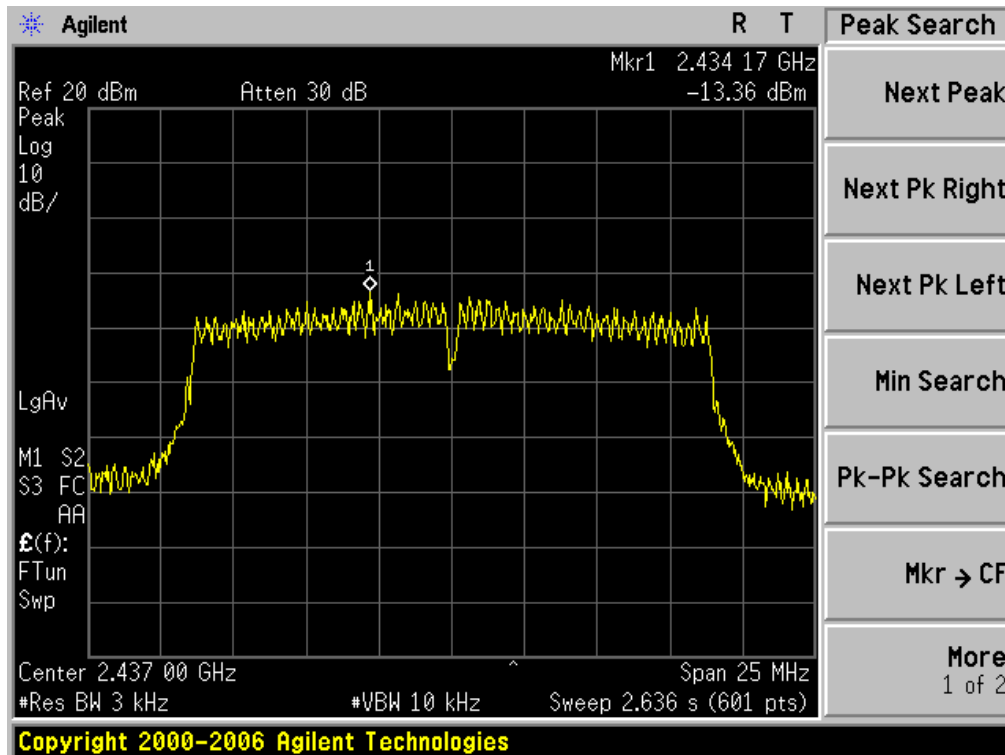

TEST PLOT OF SPECTRAL DENSITY FOR HIGH CHANNEL

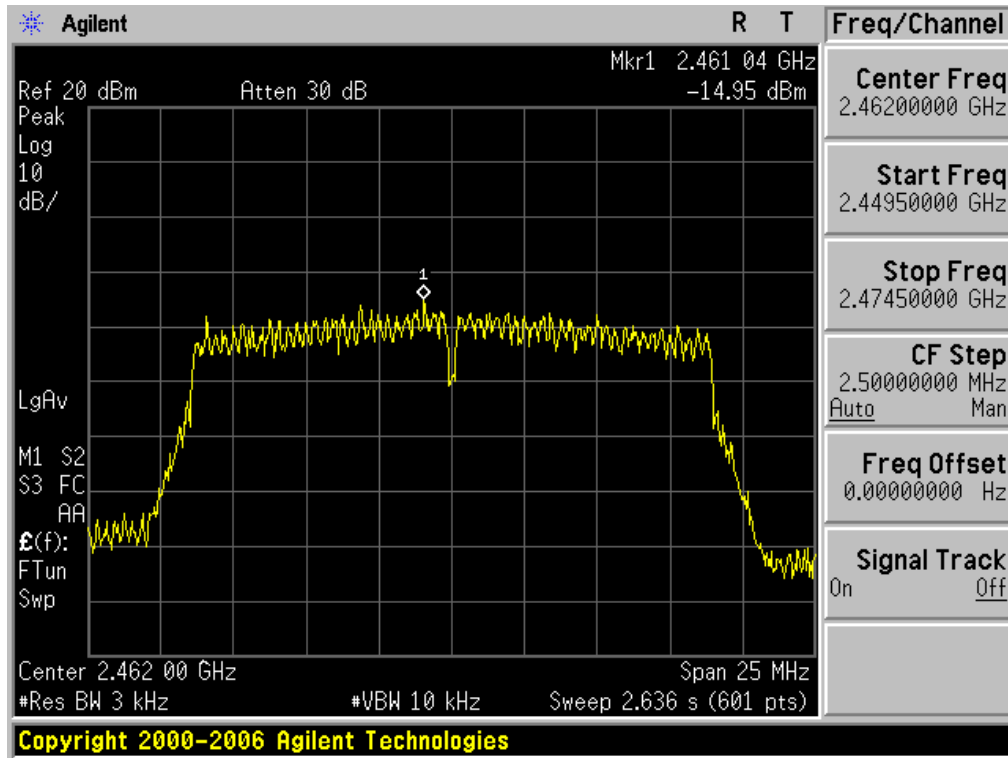

**802.11n 40 TEST RESULT**  
**TEST PLOT OF SPECTRAL DENSITY FOR LOW CHANNEL**

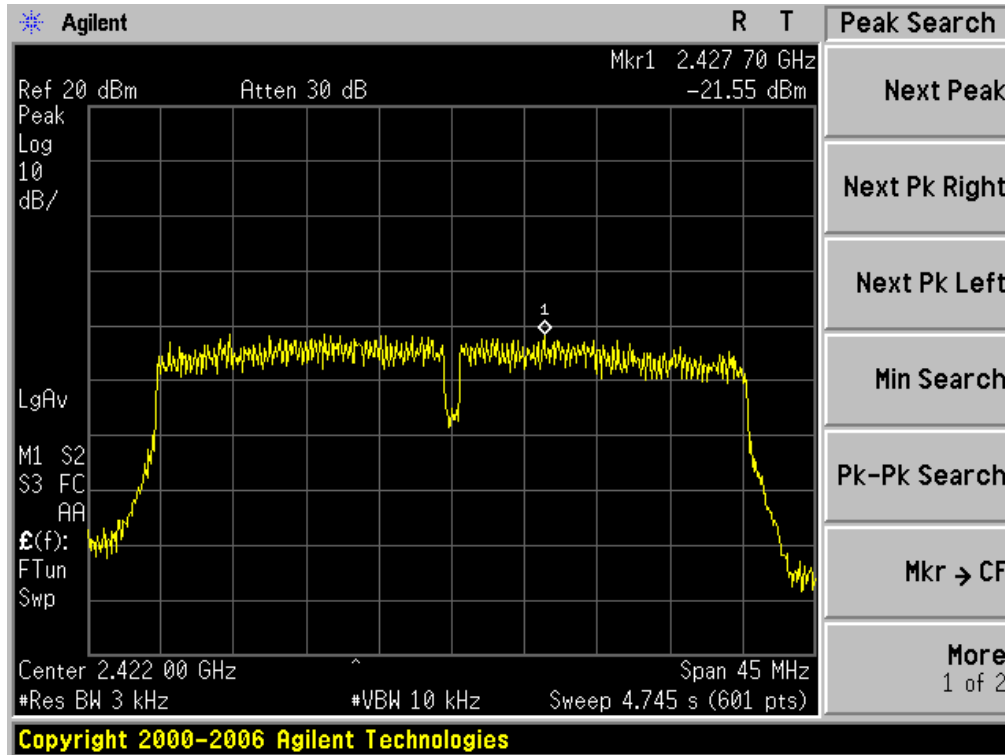

**TEST PLOT OF SPECTRAL DENSITY FOR MIDDLE CHANNEL**

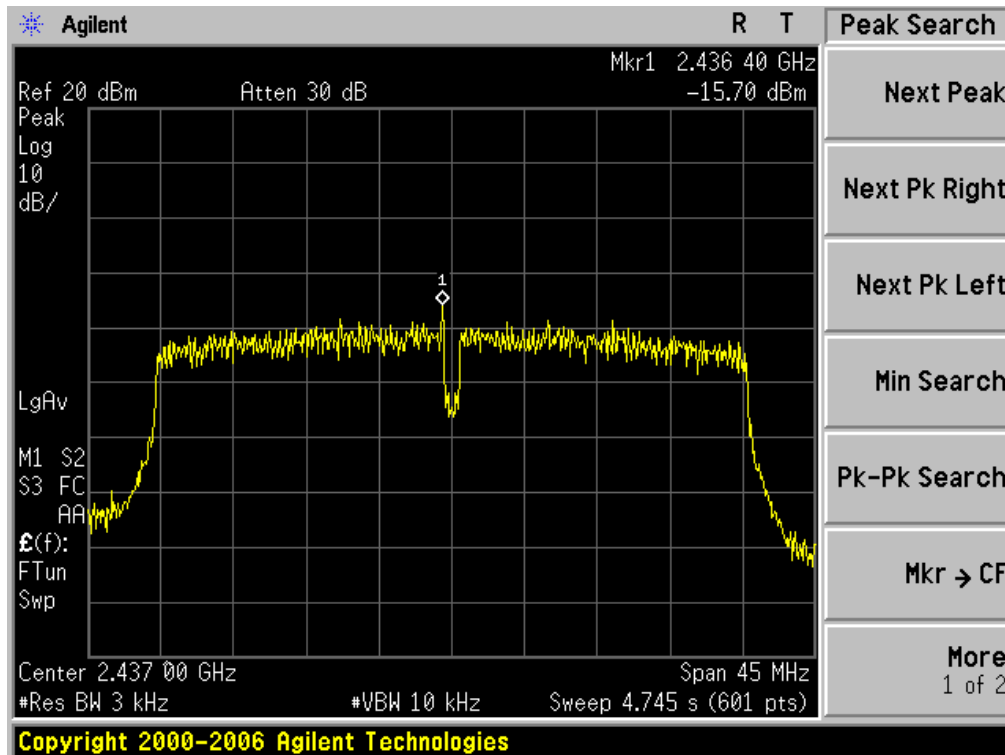

TEST PLOT OF SPECTRAL DENSITY FOR HIGH CHANNEL

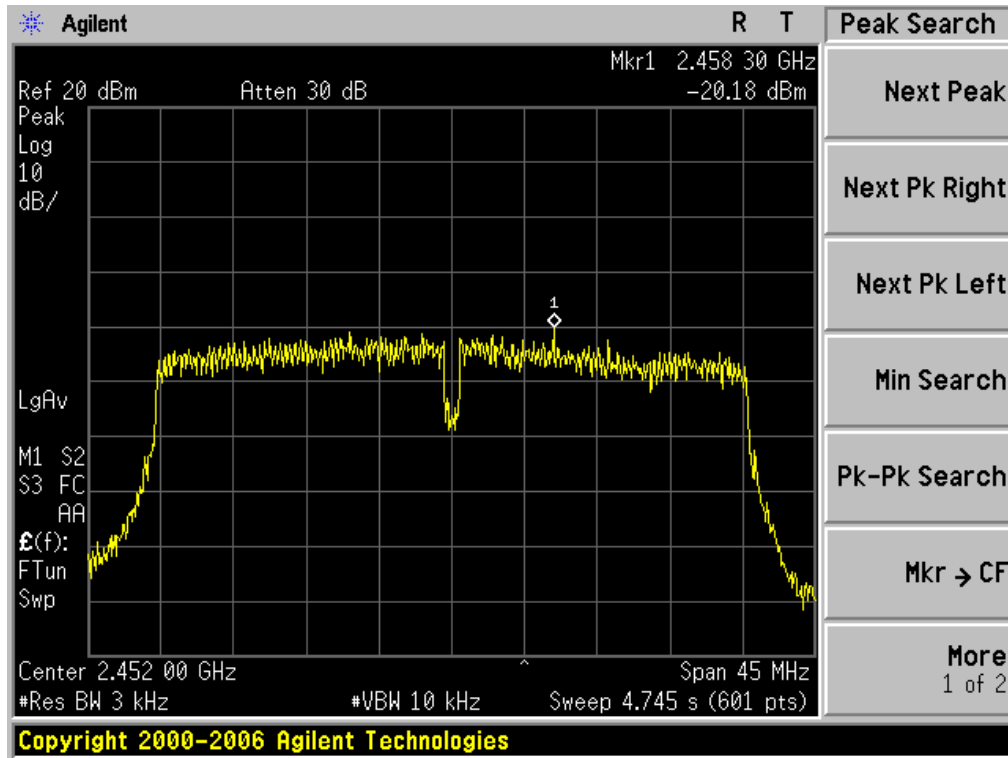

## 11. RADIATED EMISSION

### 11.1. MEASUREMENT PROCEDURE

1. Configure the EUT according to ANSI C63.4. The EUT was placed on the top of the turntable 0.8 meter above ground. The phase center of the receiving antenna mounted on the top of a height-variable antenna tower was placed 3 meters far away from the turntable.
2. Power on the EUT and all the supporting units. The turntable was rotated by 360 degrees to determine the position of the highest radiation.
3. The height of the broadband receiving antenna was varied between one meter and four meters above ground to find the maximum emissions field strength of both horizontal and vertical polarization.
4. For each suspected emissions, the antenna tower was scan (from 1 M to 4 M) and then the turntable was rotated (from 0 degree to 360 degrees) to find the maximum reading.
5. Set the test-receiver system to Peak or CISPR quasi-peak Detect Function with specified bandwidth under Maximum Hold Mode.
6. For emissions above 1GHz, use 1MHz VBW and RBW for peak reading. Then 1MHz RBW and 10Hz VBW for average reading in spectrum analyzer.
7. When the radiated emissions limits are expressed in terms of the average value of the emissions, and pulsed operation is employed, the measurement field strength shall be determined by averaging over one complete pulse train, including blanking intervals, as long as the pulse train does not exceed 0.1 seconds. As an alternative (provided the transmitter operates for longer than 0.1 seconds) or in cases where the pulse train exceeds 0.1 seconds, the measured field strength shall be determined from the average absolute voltage during a 0.1 second interval during which the field strength is at its maximum values.
8. If the emissions level of the EUT in peak mode was 3 dB lower than the average limit specified, then testing will be stopped and peak values of EUT will be reported, otherwise, the emissions which do not have 3 dB margin will be repeated one by one using the quasi-peak method for below 1GHz.
9. For testing above 1GHz, the emissions level of the EUT in peak mode was lower than average limit (that means the emissions level in peak mode also complies with the limit in average mode), then testing will be stopped and peak values of EUT will be reported, otherwise, the emissions will be measured in average mode again and reported.
10. In case the emission is lower than 30MHz, loop antenna has to be used for measurement and the recorded data should be QP measured by receiver. High - Low scan is not required in this case.

## 11.2. TEST SETUP

### RADIATED EMISSION TEST SETUP BELOW 30MHz

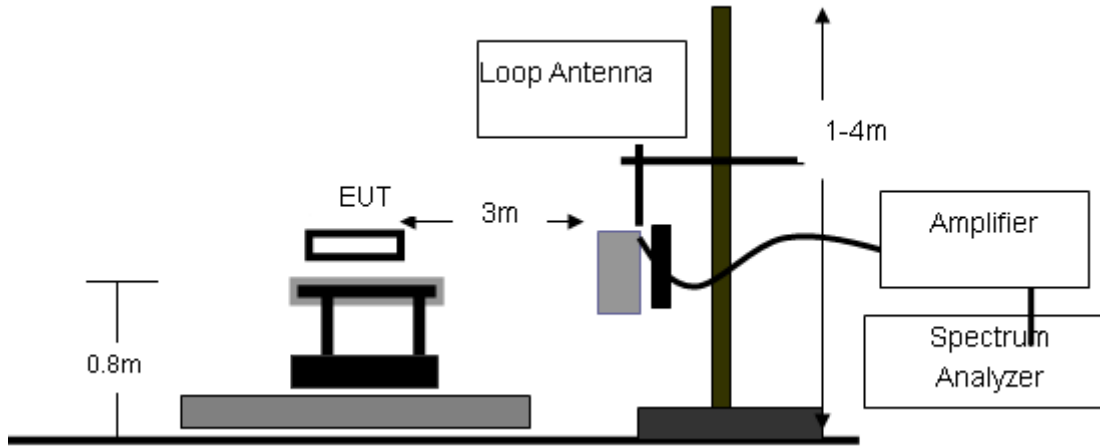

### RADIATED EMISSION TEST SETUP 30MHz-1000MHz

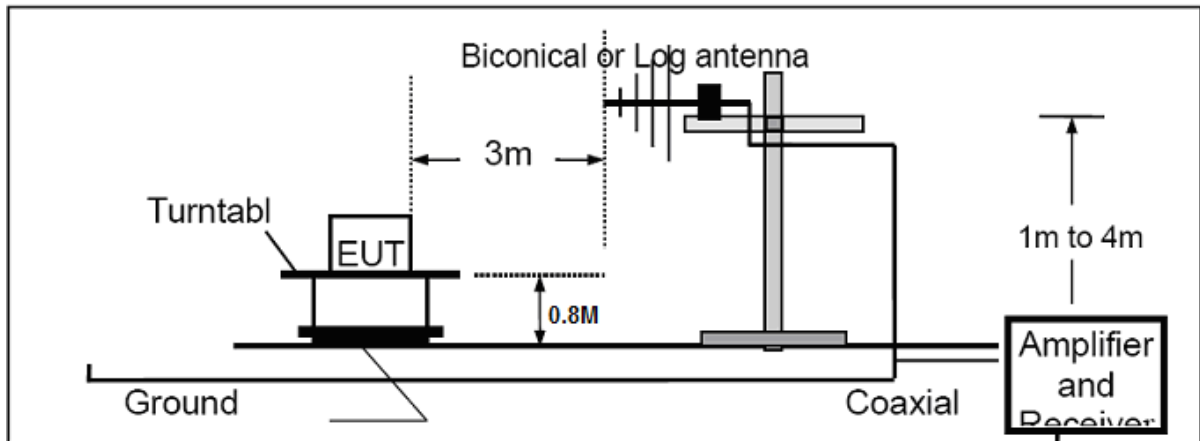

### RADIATED EMISSION TEST SETUP ABOVE 1000MHz

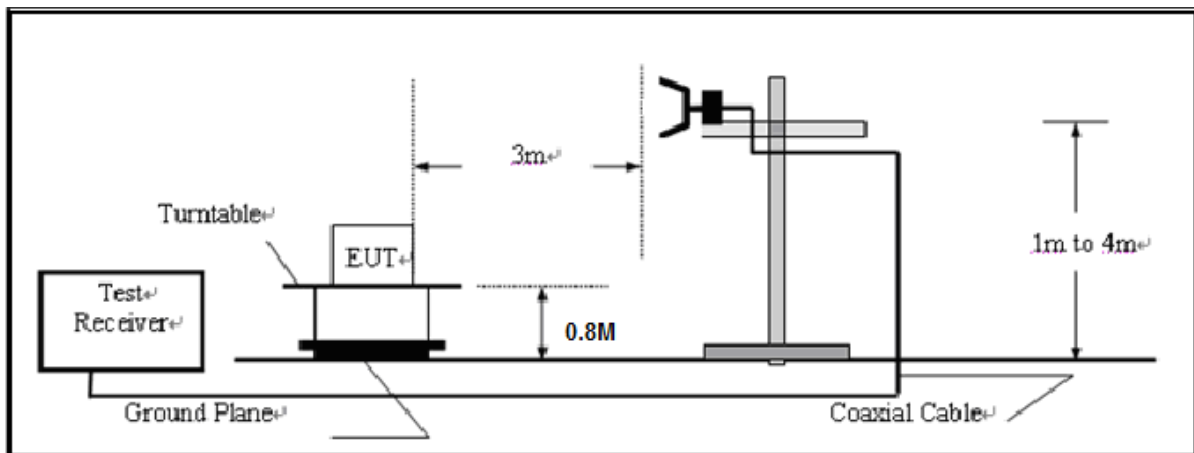

### 11.3. LIMITS AND MEASUREMENT RESULT

15.209(a) Limit in the below table has to be followed

<b>Frequencies (MHz)</b>	<b>Field Strength (micorvolts/meter)</b>	<b>Measurement Distance (meters)</b>
0.009~0.490	2400/F(KHz)	300
0.490~1.705	24000/F(KHz)	30
1.705~30.0	30	30
30~88	100	3
88~216	150	3
216~960	200	3
Above 960	500	3

Note: All modes were tested For restricted band radiated emission,  
the test records reported below are the worst result compared to other modes.

### 11.4. TEST RESULT

#### **RADIATED EMISSION BELOW 30MHZ**

No emission found between lowest internal used/generated frequencies to 30MHz.



**RADIATED EMISSION BELOW 1GHZ**

<b>EUT</b>	Tablet PC	<b>Model Name</b>	D70A14-2S
<b>Temperature</b>	25°C	<b>Relative Humidity</b>	55.4%
<b>Pressure</b>	960hPa	<b>Test Voltage</b>	Normal Voltage
<b>Test Mode</b>	802.11b with data rate 1 2412MHZ	<b>Antenna</b>	Horizontal

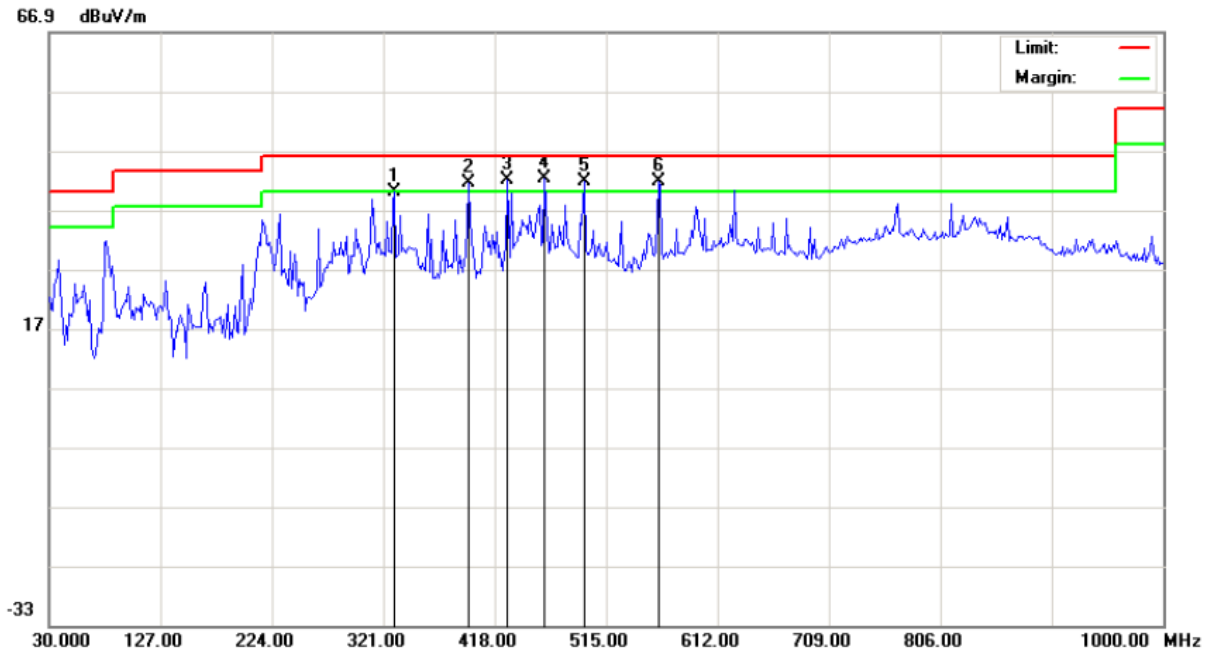

Site: site #1  
 Limit: FCC Class B 3M Radiation  
 EUT: Tablet PC  
 M/N: D70A14-2S  
 Mode: Low Channel TX  
 Note:

Polarization: *Horizontal*  
 Power:  
 Distance: 3m

Temperature: 26  
 Humidity: 60 %

No.	Mk	Freq.	Reading	Factor	Measurement	Limit	Over	Detector	Antenna Height	Table Degree	Comment
		MHz	dBuV	dB/m	dBuV/m	dBuV/m	dB		cm	degree	
1		330.6999	20.20	19.78	39.98	46.00	-6.02	peak			
2	!	395.3666	24.68	16.87	41.55	46.00	-4.45	peak			
3	!	429.3167	21.15	20.81	41.96	46.00	-4.04	peak			
4	*	461.6499	20.71	21.62	42.33	46.00	-3.67	peak			
5	!	495.6000	19.49	22.36	41.85	46.00	-4.15	peak			
6	!	560.2667	18.03	23.82	41.85	46.00	-4.15	peak			

**RESULT: PASS**

EUT	Tablet PC	Model Name	D70A14-2S
Temperature	25°C	Relative Humidity	55.4%
Pressure	960hPa	Test Voltage	Normal Voltage
Test Mode	802.11b with data rate 1 2412MHZ	Antenna	Vertical

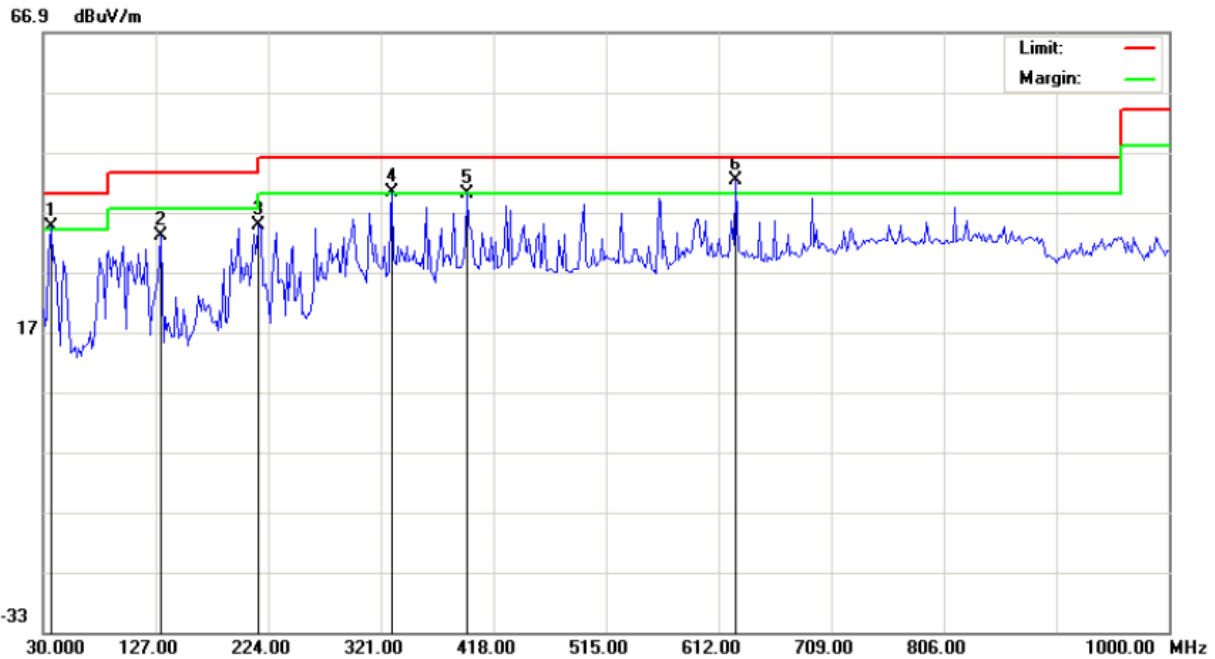

Site: site #1  
 Limit: FCC Class B 3M Radiation  
 EUT: Tablet PC  
 M/N: D70A14-2S  
 Mode: Low Channel TX  
 Note:

Polarization: **Vertical**  
 Power:  
 Distance: 3m

Temperature: 26  
 Humidity: 60 %

No.	Mk	Freq.	Reading	Factor	Measurement	Limit	Over	Detector	Antenna Height	Table Degree	Comment
		MHz	dBuV	dB/m	dBuV/m	dBuV/m	dB		cm	degree	
1	!	36.4667	28.60	6.03	34.63	40.00	-5.37	peak			
2		131.8497	31.32	1.61	32.93	43.50	-10.57	peak			
3		215.9165	27.10	7.58	34.68	43.50	-8.82	peak			
4	!	330.6999	20.38	19.78	40.16	46.00	-5.84	peak			
5	!	395.3666	20.92	19.17	40.09	46.00	-5.91	peak			
6	*	626.5498	16.63	25.76	42.39	46.00	-3.61	peak			

**RESULT: PASS**

<b>EUT</b>	Tablet PC	<b>Model Name</b>	D70A14-2S
<b>Temperature</b>	25°C	<b>Relative Humidity</b>	55.4%
<b>Pressure</b>	960hPa	<b>Test Voltage</b>	Normal Voltage
<b>Test Mode</b>	802.11b with data rate 1 2437MHZ	<b>Antenna</b>	Horizontal

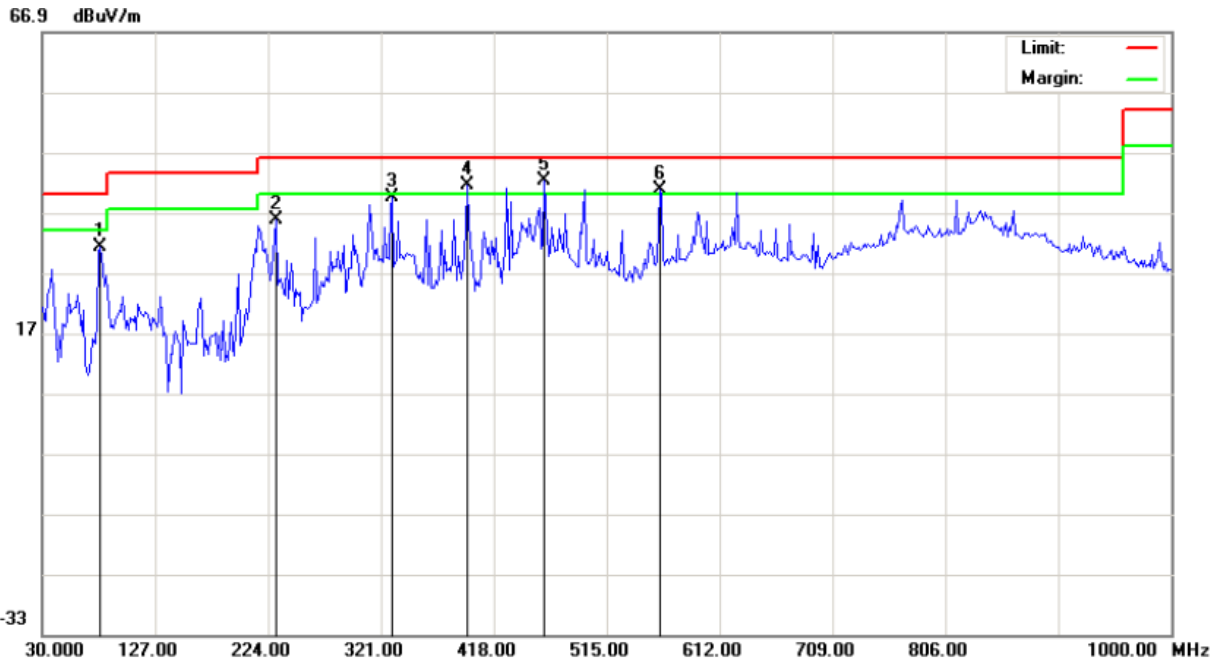

Site: site #1  
Limit: FCC Class B 3M Radiation  
EUT: Tablet PC  
M/N: D70A14-2S  
Mode: Middel Channel TX  
Note:

Polarization: *Horizontal*  
Power:  
Distance: 3m

Temperature: 26  
Humidity: 60 %

No.	Mk	Freq.	Reading	Factor	Measurement	Limit	Over	Detector	Antenna Height	Table Degree	Comment
		MHz	dBuV	dB/m	dBuV/m	dBuV/m	dB		cm	degree	
1		80.1166	19.56	11.68	31.24	40.00	-8.76	peak			
2		230.4667	23.34	12.39	35.73	46.00	-10.27	peak			
3		330.6999	19.70	19.78	39.48	46.00	-6.52	peak			
4	!	395.3666	24.68	16.87	41.55	46.00	-4.45	peak			
5	*	461.6499	20.71	21.62	42.33	46.00	-3.67	peak			
6	!	560.2667	17.03	23.82	40.85	46.00	-5.15	peak			

**RESULT: PASS**

<b>EUT</b>	Tablet PC	<b>Model Name</b>	D70A14-2S
<b>Temperature</b>	25°C	<b>Relative Humidity</b>	55.4%
<b>Pressure</b>	960hPa	<b>Test Voltage</b>	Normal Voltage
<b>Test Mode</b>	802.11b with data rate 1 2437MHZ	<b>Antenna</b>	Vertical

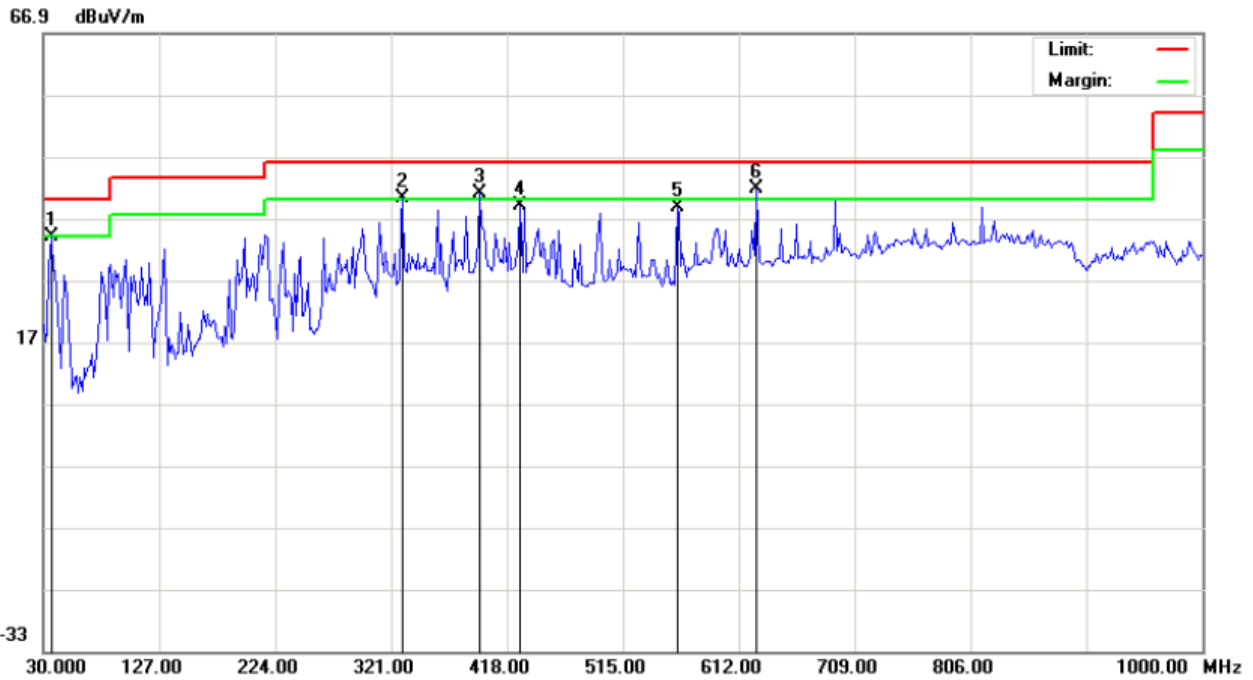

Site: site #1  
 Limit: FCC Class B 3M Radiation  
 EUT: Tablet PC  
 M/N: D70A14-2S  
 Mode: Middel Channel TX  
 Note:

Polarization: *Vertical*  
 Power:  
 Distance: 3m

Temperature: 26  
 Humidity: 60 %

No.	Mk	Freq.	Reading	Factor	Measurement	Limit	Over	Detector	Antenna Height	Table Degree	Comment
		MHz	dBuV	dB/m	dBuV/m	dBuV/m	dB		cm	degree	
1	!	36.4667	28.10	6.03	34.13	40.00	-5.87	peak			
2	!	330.6999	20.38	19.78	40.16	46.00	-5.84	peak			
3	!	395.3666	21.92	19.17	41.09	46.00	-4.91	peak			
4		429.3167	17.71	21.34	39.05	46.00	-6.95	peak			
5		560.2667	14.94	23.82	38.76	46.00	-7.24	peak			
6	*	626.5498	16.13	25.76	41.89	46.00	-4.11	peak			

**RESULT: PASS**

EUT	Tablet PC	Model Name	D70A14-2S
Temperature	25°C	Relative Humidity	55.4%
Pressure	960hPa	Test Voltage	Normal Voltage
Test Mode	802.11b with date rate 1 2462MHZ	Antenna	Horizontal

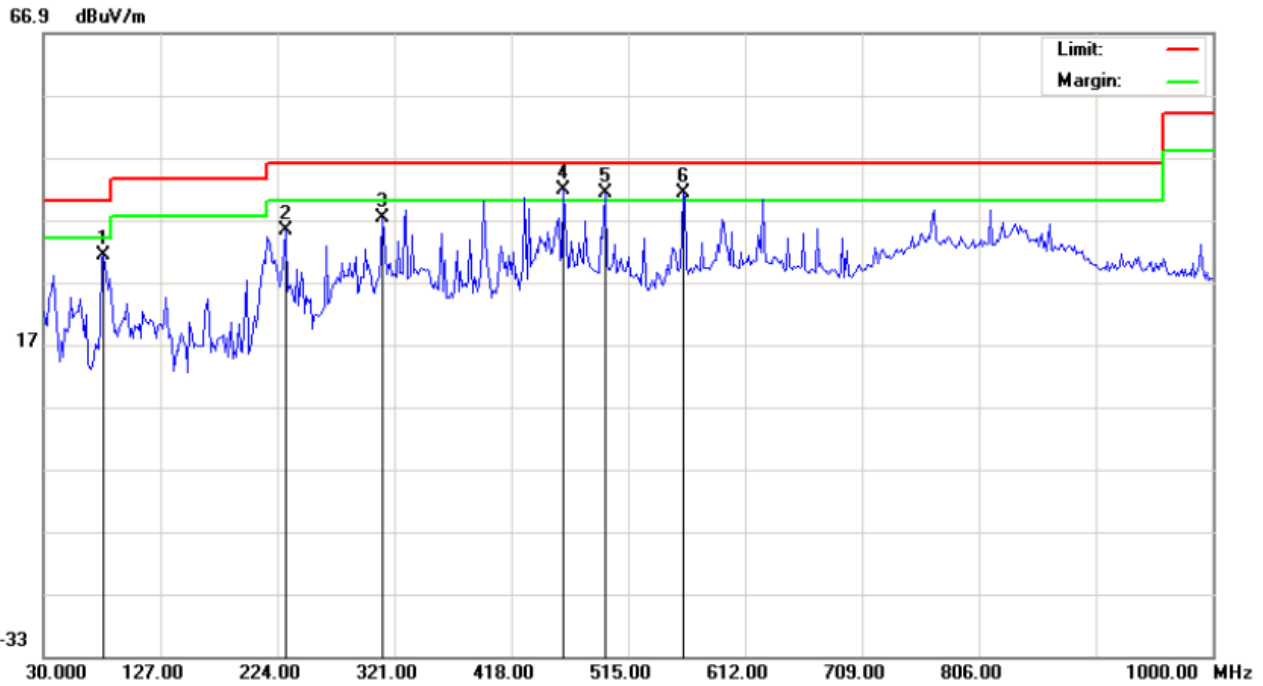

Site: site #1  
Limit: FCC Class B 3M Radiation  
EUT: Tablet PC  
M/N: D70A14-2S  
Mode: High Channel TX  
Note:

Polarization: *Horizontal*  
Power:  
Distance: 3m

Temperature: 26  
Humidity: 60 %

No.	Mk	Freq.	Reading	Factor	Measurement	Limit	Over	Detector	Antenna Height	Table Degree	Comment
		MHz	dBuV	dB/m	dBuV/m	dBuV/m	dB		cm	degree	
1	.	80.1166	19.56	11.68	31.24	40.00	-8.76	peak			
2		230.4667	22.84	12.39	35.23	46.00	-10.77	peak			
3		311.3000	18.74	18.55	37.29	46.00	-8.71	peak			
4	*	461.6499	20.21	21.62	41.83	46.00	-4.17	peak			
5	!	495.6000	18.99	22.36	41.35	46.00	-4.65	peak			
6	!	560.2667	17.53	23.82	41.35	46.00	-4.65	peak			

**RESULT: PASS**

<b>EUT</b>	Tablet PC	<b>Model Name</b>	D70A14-2S
<b>Temperature</b>	25°C	<b>Relative Humidity</b>	55.4%
<b>Pressure</b>	960hPa	<b>Test Voltage</b>	Normal Voltage
<b>Test Mode</b>	802.11b with data rate 1 2462MHZ	<b>Antenna</b>	Vertical

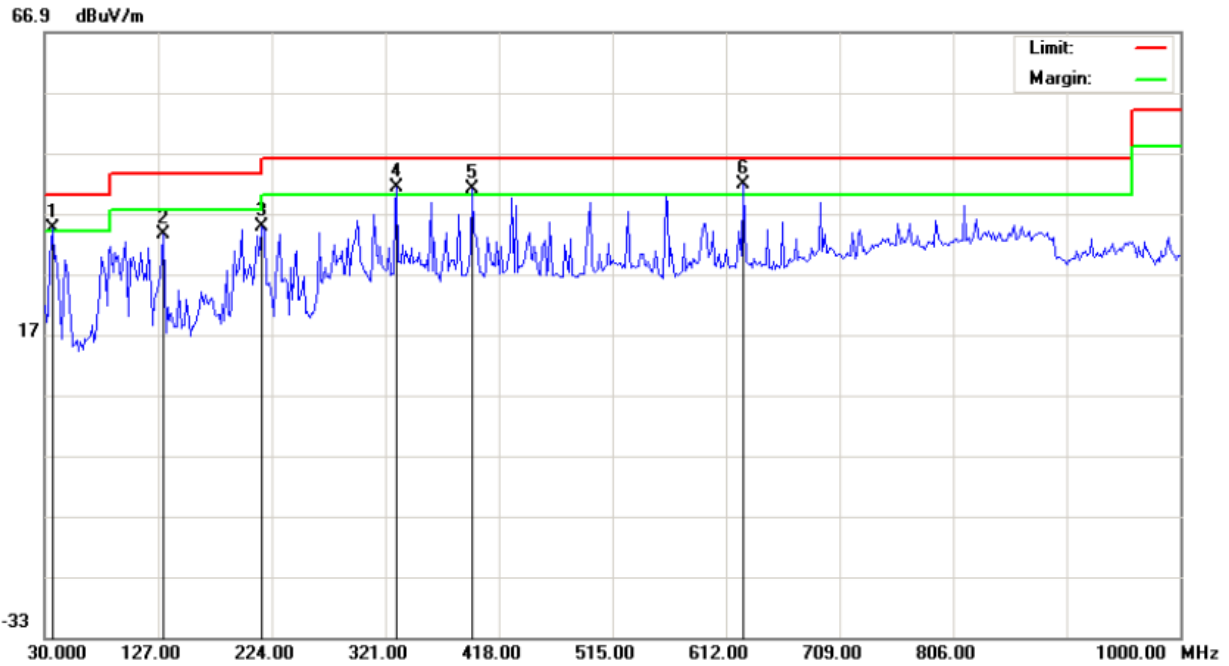

Site: site #1  
 Limit: FCC Class B 3M Radiation  
 EUT: Tablet PC  
 M/N: D70A14-2S  
 Mode: High Channel TX  
 Note:

Polarization: **Vertical**  
 Power:  
 Distance: 3m

Temperature: 26  
 Humidity: 60 %

No.	Mk	Freq.	Reading	Factor	Measurement	Limit	Over	Detector	Antenna Height	Table Degree	Comment
		MHz	dBuV	dB/m	dBuV/m	dBuV/m	dB		cm	degree	
1	!	36.4667	28.60	6.03	34.63	40.00	-5.37	peak			
2		131.8497	31.82	1.61	33.43	43.50	-10.07	peak			
3		215.9165	27.10	7.58	34.68	43.50	-8.82	peak			
4	!	330.6999	21.38	19.78	41.16	46.00	-4.84	peak			
5	!	395.3666	21.92	19.17	41.09	46.00	-4.91	peak			
6	*	626.5498	16.13	25.76	41.89	46.00	-4.11	peak			

**RESULT: PASS**

**Note:** Measurement= Reading + Factor, Over=Measure-Limit.

### RADIATED EMISSION ABOVE 1GHZ

<b>EUT</b>	Tablet PC	<b>Model Name</b>	D70A14-2S
<b>Temperature</b>	25°C	<b>Relative Humidity</b>	55.4%
<b>Pressure</b>	960hPa	<b>Test Voltage</b>	Normal Voltage
<b>Test Mode</b>	802.11b with date rate 1 2412MHZ	<b>Antenna</b>	Horizontal

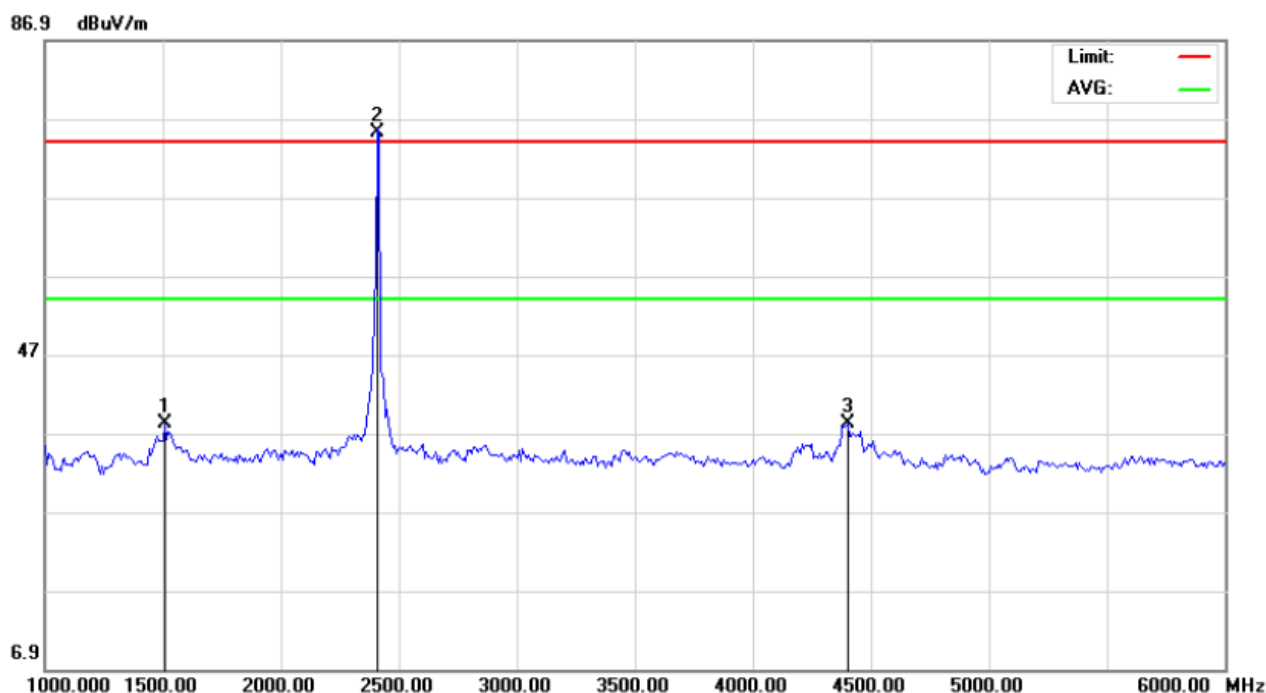

Site: site #1  
 Limit: FCC Class B 3M Radiation above 1GHZ(PK)  
 EUT: Tablet PC  
 M/N: D70A14-2S  
 Mode: Low channel  
 Note:

Polarization: **Horizontal**  
 Power:  
 Distance: 3m

Temperature: 26  
 Humidity: 60 %

No.	Mk	Freq.	Reading	Factor	Measurement	Limit	Over	Detector	Antenna Height	Table Degree	Comment
		MHz	dBuV	dB/m	dBuV/m	dBuV/m	dB		cm	degree	
1		1508.333	38.11	0.00	38.11	74.00	-35.89	peak			
2	*	2412.084	75.16	0.00	75.16	74.00	1.16	peak			
3		4400.000	38.22	0.00	38.22	74.00	-35.78	peak			

\*\*The 2 is the basic frequency.

**RESULT: PASS**

<b>EUT</b>	Tablet PC	<b>Model Name</b>	D70A14-2S
<b>Temperature</b>	25°C	<b>Relative Humidity</b>	55.4%
<b>Pressure</b>	960hPa	<b>Test Voltage</b>	Normal Voltage
<b>Test Mode</b>	802.11b with data rate 1 2412MHZ	<b>Antenna</b>	Vertical

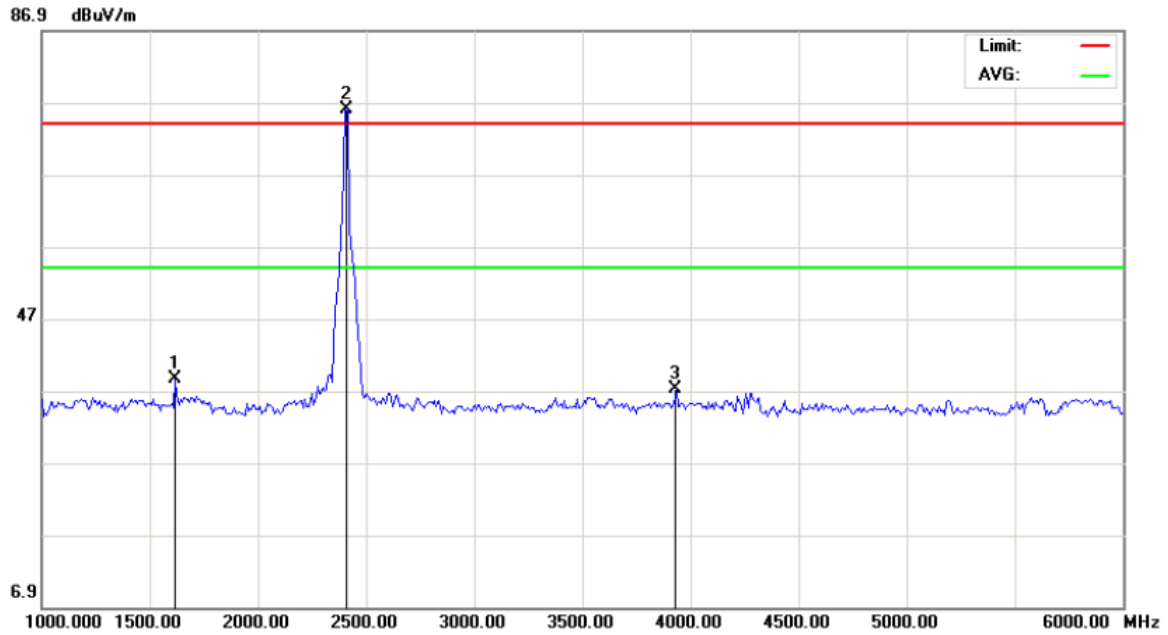

Site: site #1 Polarization: **Vertical** Temperature: 26  
 Limit: FCC Class B 3M Radiation above 1GHZ(PK) Power: Humidity: 60 %  
 EUT: Tablet PC Distance: 3m  
 M/N: D70A14-2S  
 Mode: Low channel  
 Note:

No.	Mk	Freq.	Reading	Factor	Measurement	Limit	Over	Detector	Antenna	Table	Comment
		MHz	dBuV	dB/m	dBuV/m	dBuV/m	dB		Height	Degree	
1		1616.667	38.70	0.00	38.70	74.00	-35.30	peak	cm	degree	
2	*	2412.770	75.92	0.00	75.92	74.00	1.92	peak			
3		3933.333	37.14	0.00	37.14	74.00	-36.86	peak			

\*\*The 1 is the basic frequency.

**RESULT: PASS**

**Note:** The other modes radiation emissions have more than 20dB margin.

Measurement= Reading + Factor, Over=Measure-Limit.

All modes radiation emission from 6GHz to 25GHz at least have 20dB margin.



## **12. BAND EDGE EMISSION**

### **12.1. MEASUREMENT PROCEDURE**

1. Set the EUT Work on the top, the bottom operation frequency individually.
2. Set SPA Start or Stop Frequency = Operation Frequency,  $RBW \geq 1\% \text{span}$ ,  $VBW \geq RBW$
3. The band edges was measured and recorded.

### **12.2. TEST SET-UP**

Radiated same as 11.2

12.3. TEST RESULT

EUT	Tablet PC	Model Name	D70A14-2S
Temperature	25°C	Relative Humidity	55.4%
Pressure	960hPa	Test Voltage	Normal Voltage
Test Mode	802.11b with data rate 1 2412MHZ	Antenna	Horizontal

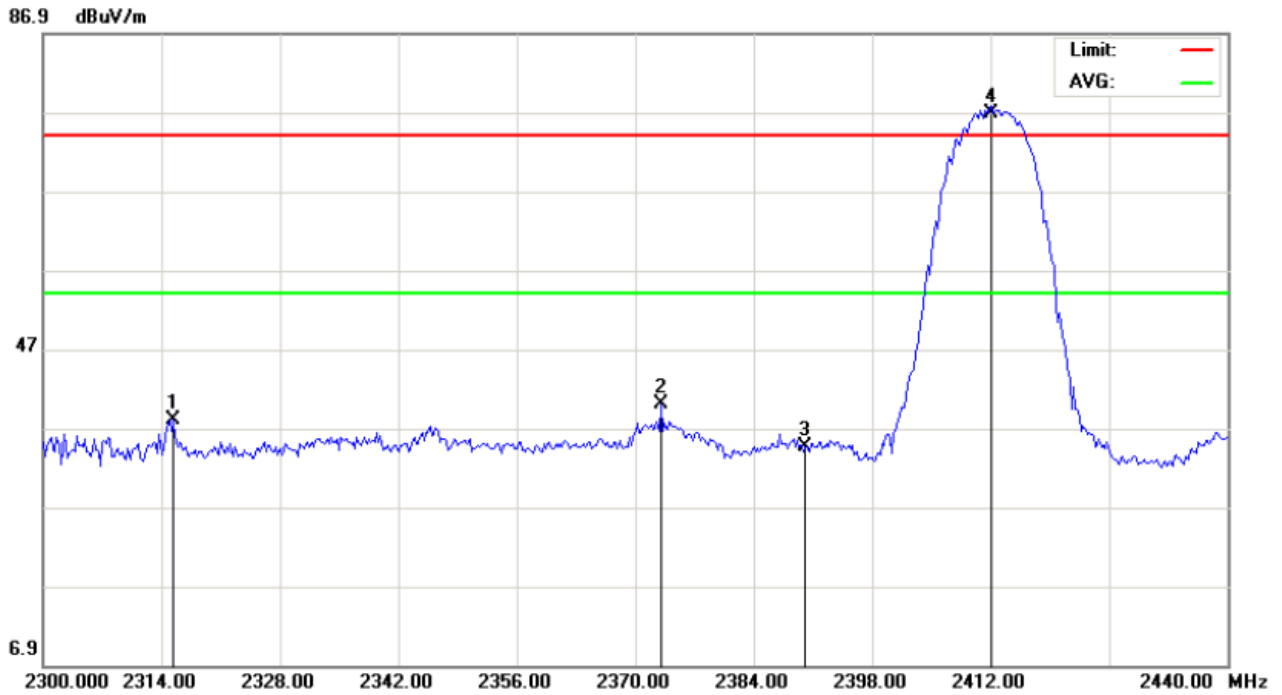

Site: site #1  
 Limit: FCC Class B 3M Radiation above 1GHZ(PK)  
 EUT: Tablet PC  
 M/N: D70A14-2S  
 Mode: 802.11b Low channel TX  
 Note:

Polarization: **Horizontal**  
 Power:  
 Distance: 3m

Temperature: 26  
 Humidity: 60 %

No.	Mk	Freq.	Reading	Factor	Measurement	Limit	Over	Detector	Antenna Height	Table Degree	Comment
		MHz	dBuV	dB/m	dBuV/m	dBuV/m	dB		cm	degree	
1		2315.400	37.97	0.00	37.97	74.00	-36.03	peak			
2		2373.033	39.94	0.00	39.94	74.00	-34.06	peak			
3		2390.000	34.60	0.00	34.60	74.00	-39.40	peak			
4	*	2412.058	76.73	0.00	76.73	74.00	2.73	peak			

RESULT: PASS

<b>EUT</b>	Tablet PC	<b>Model Name</b>	D70A14-2S
<b>Temperature</b>	25°C	<b>Relative Humidity</b>	55.4%
<b>Pressure</b>	960hPa	<b>Test Voltage</b>	Normal Voltage
<b>Test Mode</b>	802.11b with data rate 1 2412MHZ	<b>Antenna</b>	Vertical

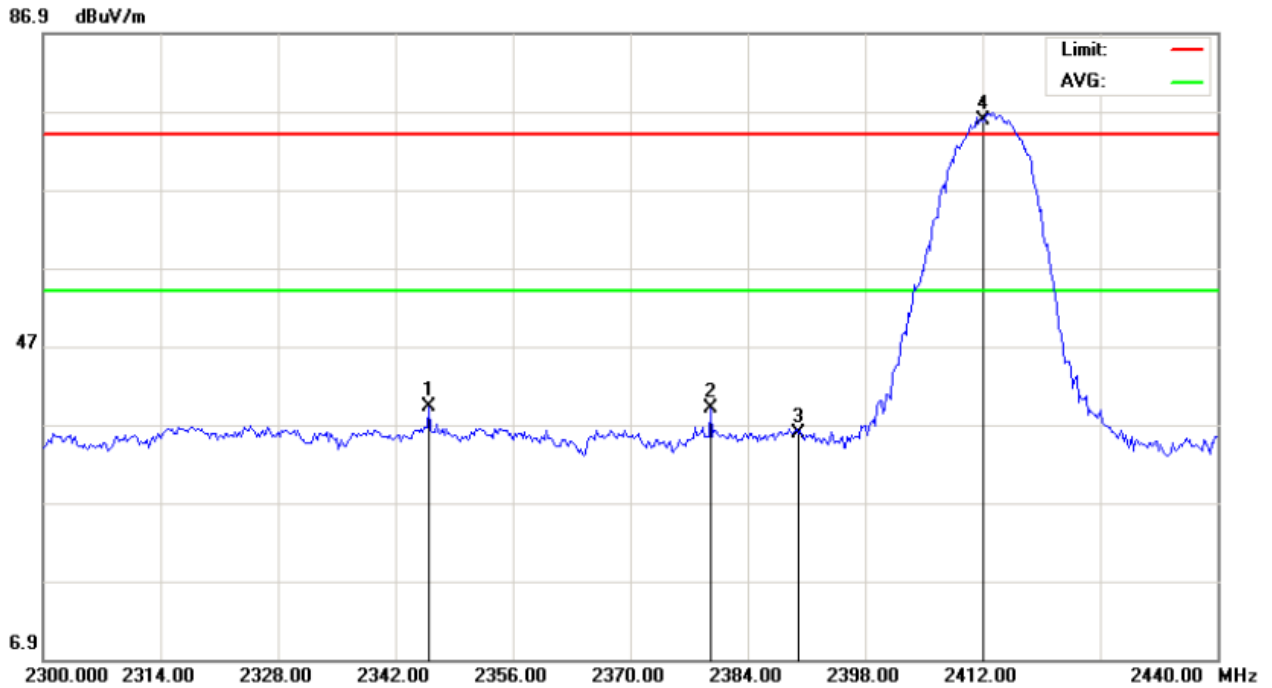

Site: site #1 Polarization: **Vertical** Temperature: 26  
 Limit: FCC Class B 3M Radiation above 1GHZ(PK) Power: Humidity: 60 %  
 EUT: Tablet PC Distance: 3m  
 M/N: D70A14-2S  
 Mode: 802.11b Low channel TX  
 Note:

No.	Mk	Freq.	Reading	Factor	Measurement	Limit	Over	Detector	Antenna Height	Table Degree	Comment
		MHz	dBuV	dB/m	dBuV/m	dBuV/m	dB		cm	degree	
1		2345.967	39.24	0.00	39.24	74.00	-34.76	peak			
2		2379.567	39.07	0.00	39.07	74.00	-34.93	peak			
3		2390.000	35.75	0.00	35.75	74.00	-38.25	peak			
4	*	2412.078	75.86	0.00	75.86	74.00	1.86	peak			

**RESULT: PASS**

<b>EUT</b>	Tablet PC	<b>Model Name</b>	D70A14-2S
<b>Temperature</b>	25°C	<b>Relative Humidity</b>	55.4%
<b>Pressure</b>	960hPa	<b>Test Voltage</b>	Normal Voltage
<b>Test Mode</b>	802.11b with data rate 1 2462MHZ	<b>Antenna</b>	Horizontal

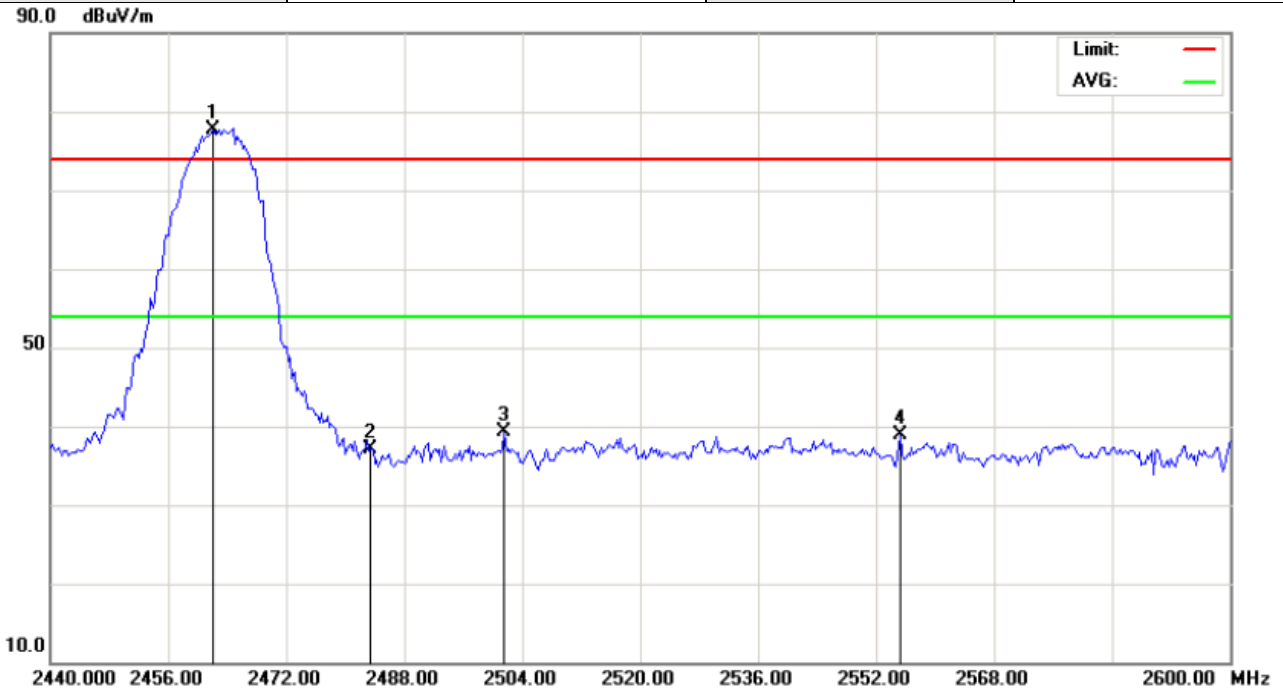

Site: site #1  
 Limit: FCC Class B 3M Radiation above 1GHZ(PK)  
 EUT: Tablet PC  
 M/N: D70A14-2S  
 Mode: 802.11b High channel TX  
 Note:

Polarization: **Horizontal**  
 Power:  
 Distance: 3m

Temperature: 26  
 Humidity: 60 %

No.	Mk	Freq.	Reading	Factor	Measurement	Limit	Over	Detector	Antenna Height	Table Degree	Comment
		MHz	dBuV	dB/m	dBuV/m	dBuV/m	dB		cm	degree	
1	*	2462.082	77.76	0.00	77.76	74.00	3.76	peak			
2		2483.500	37.08	0.00	37.08	74.00	-36.92	peak			
3		2501.600	39.35	0.00	39.35	74.00	-34.65	peak			
4		2555.200	38.96	0.00	38.96	74.00	-35.04	peak			

**RESULT: PASS**

<b>EUT</b>	Tablet PC	<b>Model Name</b>	D70A14-2S
<b>Temperature</b>	25°C	<b>Relative Humidity</b>	55.4%
<b>Pressure</b>	960hPa	<b>Test Voltage</b>	Normal Voltage
<b>Test Mode</b>	802.11b with data rate 1 2462MHZ	<b>Antenna</b>	Vertical

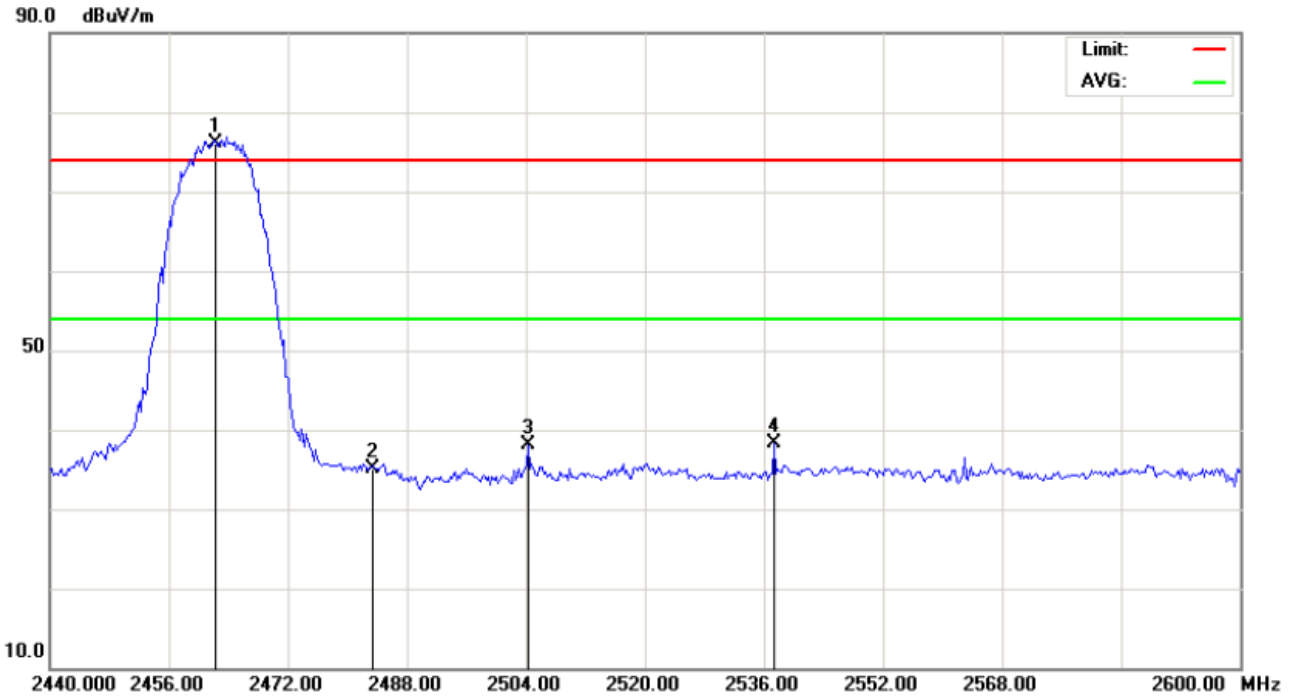

Site: site #1  
 Limit: FCC Class B 3M Radiation above 1GHZ(PK)  
 EUT: Tablet PC  
 M/N: D70A14-2S  
 Mode: 802.11b High channel TX  
 Note:

Polarization: *Vertical*  
 Power:  
 Distance: 3m

Temperature: 26  
 Humidity: 60 %

No.	Mk	Freq.	Reading	Factor	Measurement	Limit	Over	Detector	Antenna Height	Table Degree	Comment
		MHz	dBuV	dB/m	dBuV/m	dBuV/m	dB		cm	degree	
1	*	2462.380	76.06	0.00	76.06	74.00	2.06	peak			
2		2483.500	35.13	0.00	35.13	74.00	-38.87	peak			
3		2504.267	38.17	0.00	38.17	74.00	-35.83	peak			
4		2537.333	38.30	0.00	38.30	74.00	-35.70	peak			

**RESULT: PASS**

<b>EUT</b>	Tablet PC	<b>Model Name</b>	D70A14-2S
<b>Temperature</b>	25°C	<b>Relative Humidity</b>	55.4%
<b>Pressure</b>	960hPa	<b>Test Voltage</b>	Normal Voltage
<b>Test Mode</b>	802.11n 40 with data rate 13.5 2422MHZ	<b>Antenna</b>	Horizontal

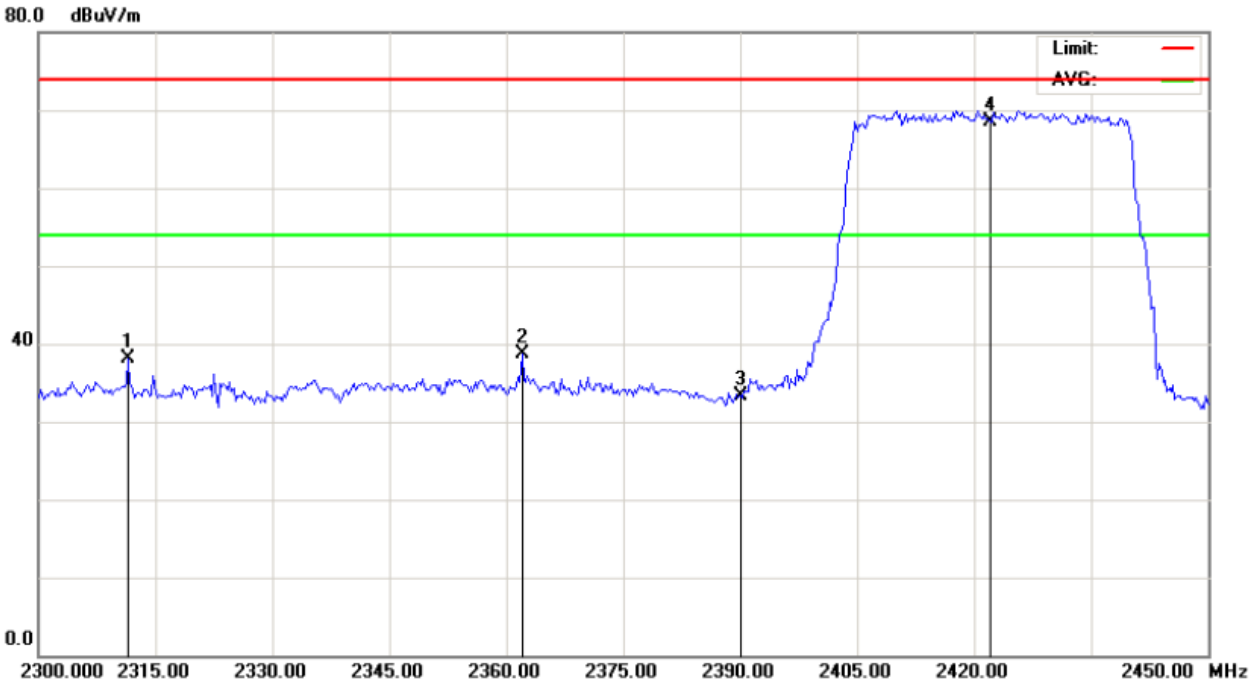

Site: site #1  
 Limit: FCC Class B 3M Radiation above 1GHZ(PK)  
 EUT: Tablet PC  
 M/N: D70A14-2S  
 Mode: 802.11n(40) Low channel TX  
 Note:

Polarization: **Horizontal**  
 Power:  
 Distance: 3m

Temperature: 26  
 Humidity: 60 %

No.	Mk	Freq.	Reading	Factor	Measurement	Limit	Over	Detector	Antenna Height	Table Degree	Comment
		MHz	dBuV	dB/m	dBuV/m	dBuV/m	dB		cm	degree	
1		2311.500	38.02	0.00	38.02	74.00	-35.98	peak			
2		2362.000	38.68	0.00	38.68	74.00	-35.32	peak			
3		2390.000	33.24	0.00	33.24	74.00	-40.76	peak			
4	*	2422.035	68.43	0.00	68.43	74.00	-5.57	peak			

**RESULT: PASS**

<b>EUT</b>	Tablet PC	<b>Model Name</b>	D70A14-2S
<b>Temperature</b>	25°C	<b>Relative Humidity</b>	55.4%
<b>Pressure</b>	960hPa	<b>Test Voltage</b>	Normal Voltage
<b>Test Mode</b>	802.11n 40 with data rate 13.5 2422MHZ	<b>Antenna</b>	Vertical

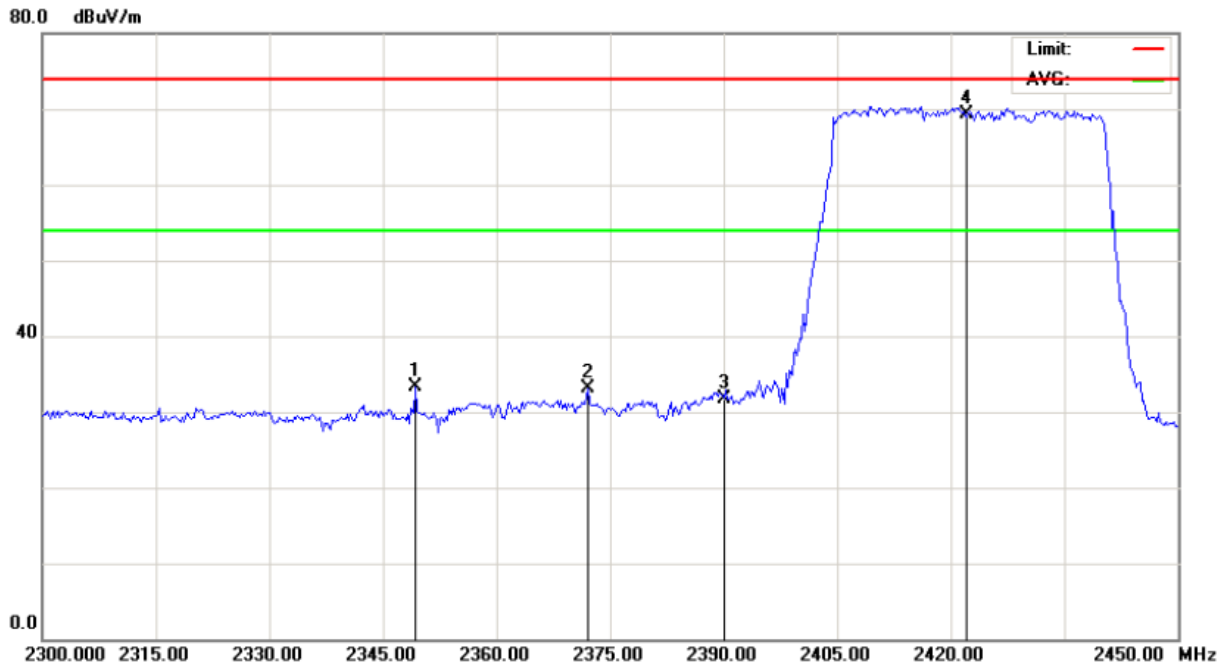

Site: site #1 Polarization: **Vertical** Temperature: 26  
 Limit: FCC Class B 3M Radiation above 1GHZ(PK) Power: Humidity: 60 %  
 EUT: Tablet PC Distance: 3m  
 M/N: D70A14-2S  
 Mode: 802.11n(40) Low channel TX  
 Note:

No.	Mk	Freq.	Reading	Factor	Measurement	Limit	Over	Detector	Antenna	Table	Comment
		MHz	dBuV	dB/m	dBuV/m	dBuV/m	dB		Height	Degree	
1		2349.250	33.32	0.00	33.32	74.00	-40.68	peak	cm	degree	
2		2372.000	33.13	0.00	33.13	74.00	-40.87	peak			
3		2390.000	31.80	0.00	31.80	74.00	-42.20	peak			
4	*	2422.064	69.37	0.00	69.37	74.00	-4.63	peak			

**RESULT: PASS**

<b>EUT</b>	Tablet PC	<b>Model Name</b>	D70A14-2S
<b>Temperature</b>	25°C	<b>Relative Humidity</b>	55.4%
<b>Pressure</b>	960hPa	<b>Test Voltage</b>	Normal Voltage
<b>Test Mode</b>	802.11n 40 with data rate 13.5 2452MHZ	<b>Antenna</b>	Horizontal

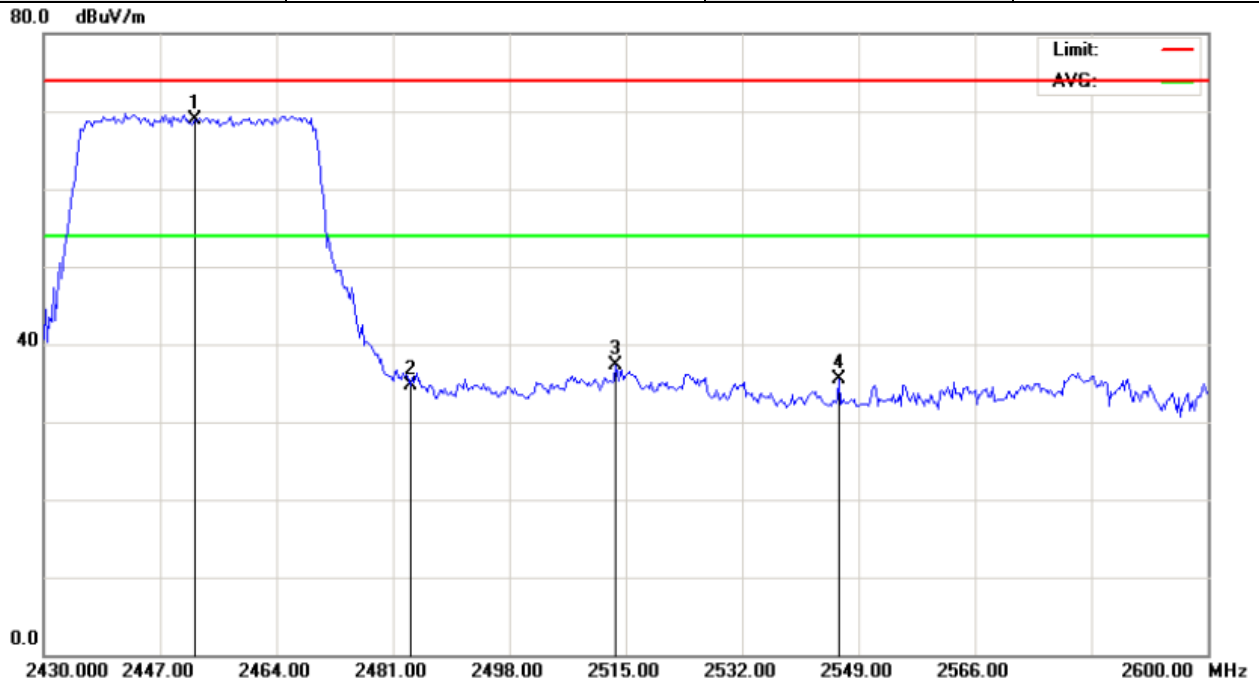

Site: site #1  
 Limit: FCC Class B 3M Radiation above 1GHZ(PK)  
 EUT: Tablet PC  
 M/N: D70A14-2S  
 Mode: 802.11n(40) High channel TX  
 Note:

Polarization: **Horizontal**  
 Power:  
 Distance: 3m

Temperature: 26  
 Humidity: 60 %

No.	Mk	Freq.	Reading	Factor	Measurement	Limit	Over	Detector	Antenna Height	Table Degree	Comment
		MHz	dBuV	dB/m	dBuV/m	dBuV/m	dB		cm	degree	
1	*	2452.094	69.00	0.00	69.00	74.00	-5.00	peak			
2		2483.500	34.73	0.00	34.73	74.00	-39.27	peak			
3		2513.583	37.21	0.00	37.21	74.00	-36.79	peak			
4		2546.167	35.56	0.00	35.56	74.00	-38.44	peak			

**RESULT: PASS**



<b>EUT</b>	Tablet PC	<b>Model Name</b>	D70A14-2S
<b>Temperature</b>	25°C	<b>Relative Humidity</b>	55.4%
<b>Pressure</b>	960hPa	<b>Test Voltage</b>	Normal Voltage
<b>Test Mode</b>	802.11n 40 with data rate 13.5 2452MHZ	<b>Antenna</b>	Vertical

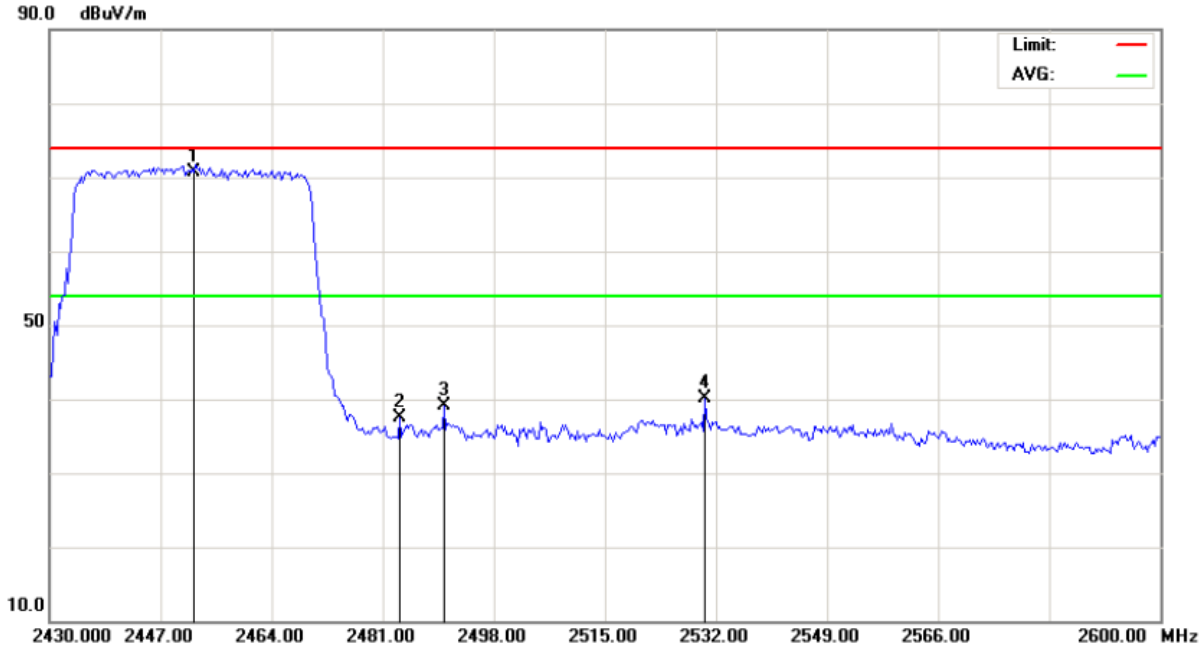

Site: site #1	Polarization: <b>Vertical</b>	Temperature: 26
Limit: FCC Class B 3M Radiation above 1GHZ(PK)	Power:	Humidity: 60 %
EUT: Tablet PC	Distance: 3m	
M/N: D70A14-2S		
Mode: 802.11n(40) High channel TX		
Note:		

No.	Mk	Freq. MHz	Reading dBuV	Factor dB/m	Measurement dBuV/m	Limit dBuV/m	Over dB	Detector	Antenna Height cm	Table Degree degree	Comment
1	*	2452.077	70.70	0.00	70.70	74.00	-3.30	peak			
2		2483.500	37.42	0.00	37.42	74.00	-36.58	peak			
3		2490.350	39.14	0.00	39.14	74.00	-34.86	peak			
4		2530.300	40.14	0.00	40.14	74.00	-33.86	peak			

**RESULT: PASS**

**Note:** the other modes radiation emission have enough 20dB margin.  
Measurement= Reading + Factor, Over=Measure-Limit.

### 13. FCC LINE CONDUCTED EMISSION TEST

#### 13.1. LIMITS OF LINE CONDUCTED EMISSION TEST

Frequency	Maximum RF Line Voltage	
	Q.P.( dBuV)	Average( dBuV)
150kHz~500kHz	66-56	56-46
500kHz~5MHz	56	46
5MHz~30MHz	60	50

Note:

1. The lower limit shall apply at the transition frequency.
2. The limit decreases linearly with the logarithm of the frequency in the range 0.15 MHz to 0.50 MHz.

#### 13.2. BLOCK DIAGRAM OF LINE CONDUCTED EMISSION TEST

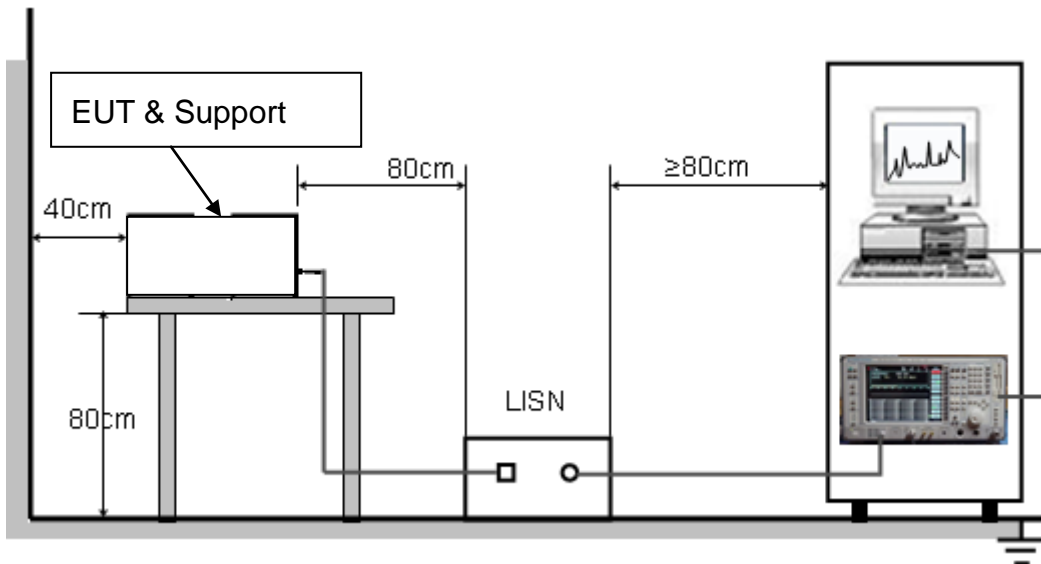

### **13.3. PRELIMINARY PROCEDURE OF LINE CONDUCTED EMISSION TEST**

1. The equipment was set up as per the test configuration to simulate typical actual usage per the user's manual. When the EUT is a tabletop system, a wooden table with a height of 0.8 meters is used and is placed on the ground plane as per ANSI C63.4 (see Test Facility for the dimensions of the ground plane used). When the EUT is a floor-standing equipment, it is placed on the ground plane which has a 3-12 mm non-conductive covering to insulate the EUT from the ground plane.
2. Support equipment, if needed, was placed as per ANSI C63.4.
3. All I/O cables were positioned to simulate typical actual usage as per ANSI C63.4.
4. All support equipments received AC120V/60Hz power from a LISN, if any.
5. The EUT received charging voltage by adapter which received 120V/60Hz power by a LISN..
6. The test program was started. Emissions were measured on each current carrying line of the EUT using a spectrum Analyzer / Receiver connected to the LISN powering the EUT. The LISN has two monitoring points: Line 1 (Hot Side) and Line 2 (Neutral Side). Two scans were taken: one with Line 1 connected to Analyzer / Receiver and Line 2 connected to a 50 ohm load; the second scan had Line 1 connected to a 50 ohm load and Line 2 connected to the Analyzer / Receiver.
7. Analyzer / Receiver scanned from 150 kHz to 30MHz for emissions in each of the test modes.
8. During the above scans, the emissions were maximized by cable manipulation.
9. The test mode(s) were scanned during the preliminary test.

Then, the EUT configuration and cable configuration of the above highest emission level were recorded for reference of final testing.

### **13.4. FINAL PROCEDURE OF LINE CONDUCTED EMISSION TEST**

1. EUT and support equipment was set up on the test bench as per step 2 of the preliminary test.
2. A scan was taken on both power lines, Line 1 and Line 2, recording at least the six highest emissions. Emission frequency and amplitude were recorded into a computer in which correction factors were used to calculate the emission level and compare reading to the applicable limit. If EUT emission level was less -2dB to the A.V. limit in Peak mode, then the emission signal was re-checked using Q.P and Average detector.
3. The test data of the worst case condition(s) was reported on the Summary Data page.

13.5. TEST RESULT OF LINE CONDUCTED EMISSION TEST

LINE CONDUCTED EMISSION TEST LINE 1-L

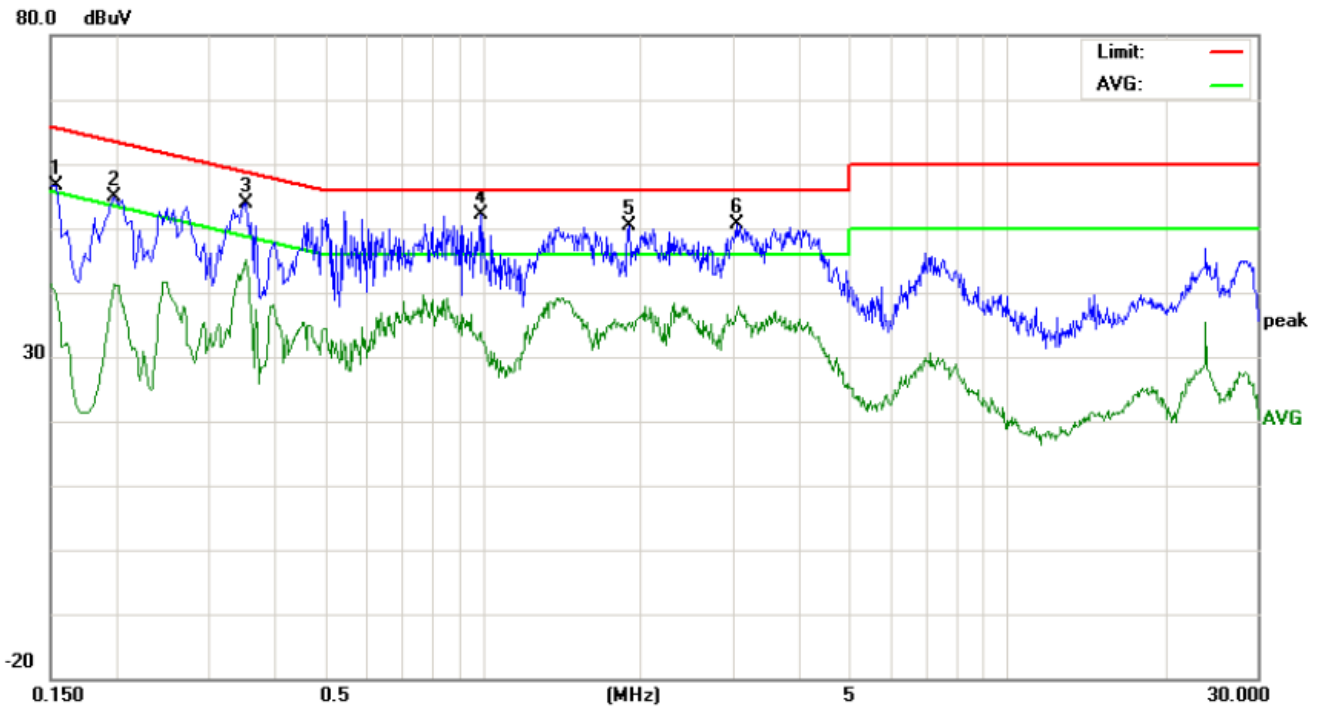

Site: Conduction Phase: **L1** Temperature: 26  
 Limit: FCC Class B Conduction(QP) Power: Humidity: 60 %  
 EUT: Tablet PC  
 M/N: D70A14-2S  
 Mode: Normal Operating(WiFi)  
 Note:

No.	Freq. (MHz)	Reading_Level (dBuV)			Correct Factor	Measurement (dBuV)			Limit (dBuV)		Margin (dB)		P/F	Comment
		Peak	QP	AVG		dB	Peak	QP	AVG	QP	AVG	QP		
1	0.1539	46.54		29.48	10.16	56.70		39.64	65.78	55.78	-9.08	-16.14	P	
2	0.1980	44.72		31.11	10.21	54.93		41.32	63.69	53.69	-8.76	-12.37	P	
3	0.3540	43.55		34.70	10.31	53.86		45.01	58.87	48.87	-5.01	-3.86	P	
4	0.9940	41.85		23.50	10.37	52.22		33.87	56.00	46.00	-3.78	-12.13	P	
5	1.8980	40.11		25.20	10.25	50.36		35.45	56.00	46.00	-5.64	-10.55	P	
6	3.0460	40.05		26.22	10.55	50.60		36.77	56.00	46.00	-5.40	-9.23	P	

Line Conducted Emission Test Line 2-N

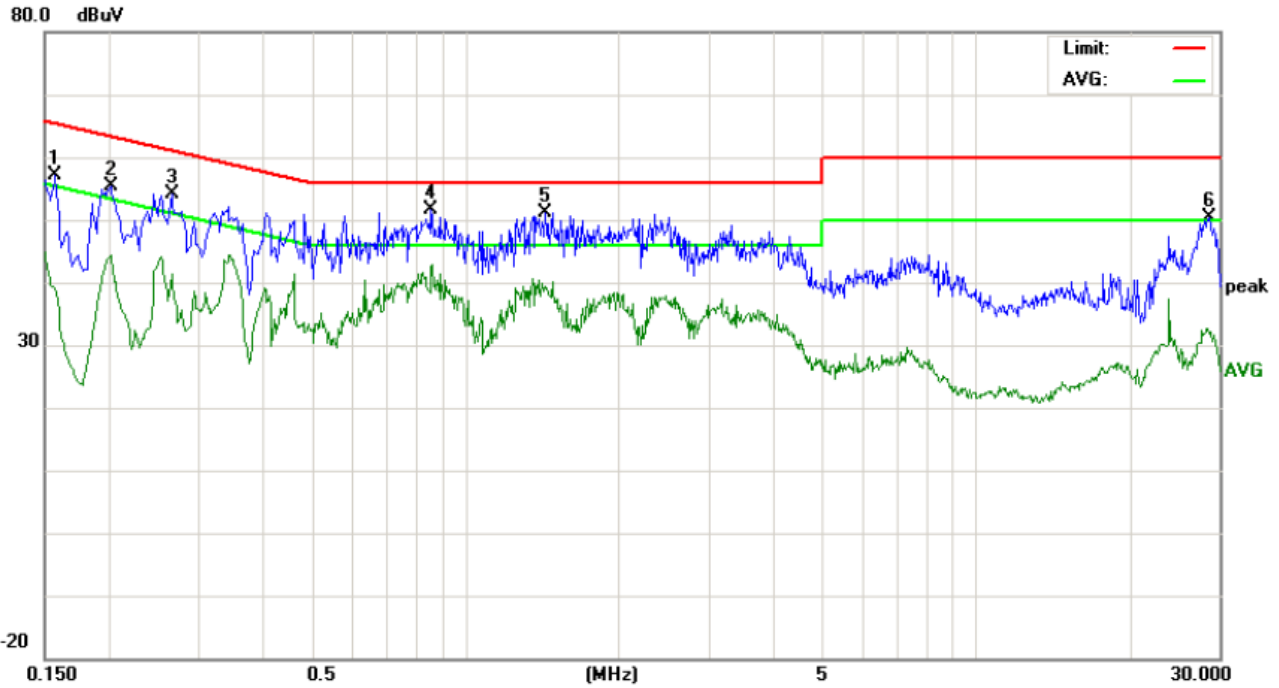

Site: Conduction Phase: **N** Temperature: 26  
 Limit: FCC Class B Conduction(QP) Power: Humidity: 60 %  
 EUT: Tablet PC  
 M/N: D70A14-2S  
 Mode: Normal Operating(WiFi)  
 Note:

No.	Freq. (MHz)	Reading_Level (dBuV)			Correct Factor (dB)	Measurement (dBuV)			Limit (dBuV)		Margin (dB)		P/F	Comment
		Peak	QP	AVG		Peak	QP	AVG	QP	AVG	QP	AVG		
1	0.1580	47.07		28.80	10.17	57.24		38.97	65.56	55.56	-8.32	-16.59	P	
2	0.2020	45.23		34.27	10.22	55.45		44.49	63.52	53.52	-8.07	-9.03	P	
3	0.2660	43.89		31.18	10.28	54.17		41.46	61.24	51.24	-7.07	-9.78	P	
4	0.8579	41.26		31.96	10.36	51.62		42.32	56.00	46.00	-4.38	-3.68	P	
5	1.4379	40.84		29.04	10.38	51.22		39.42	56.00	46.00	-4.78	-6.58	P	
6	28.7540	40.22		21.87	10.12	50.34		31.99	60.00	50.00	-9.66	-18.01	P	

## APPENDIX A: PHOTOGRAPHS OF TEST SETUP

### FCC LINE CONDUCTED EMISSION TEST SETUP



FCC RADIATED EMISSION TEST SETUP

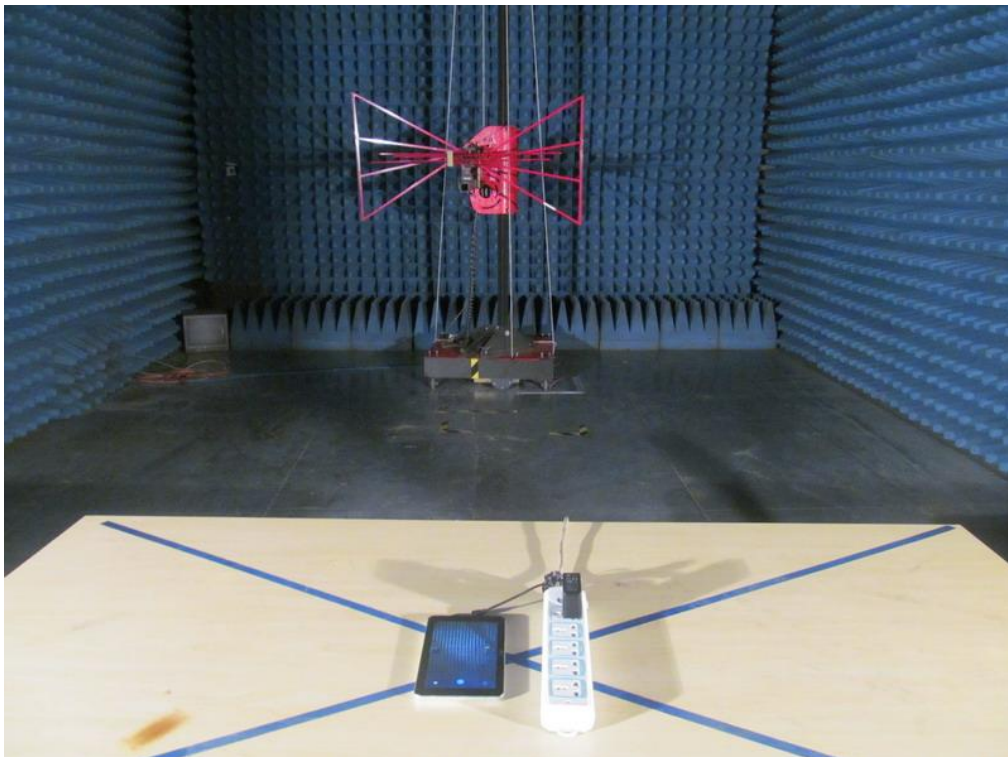

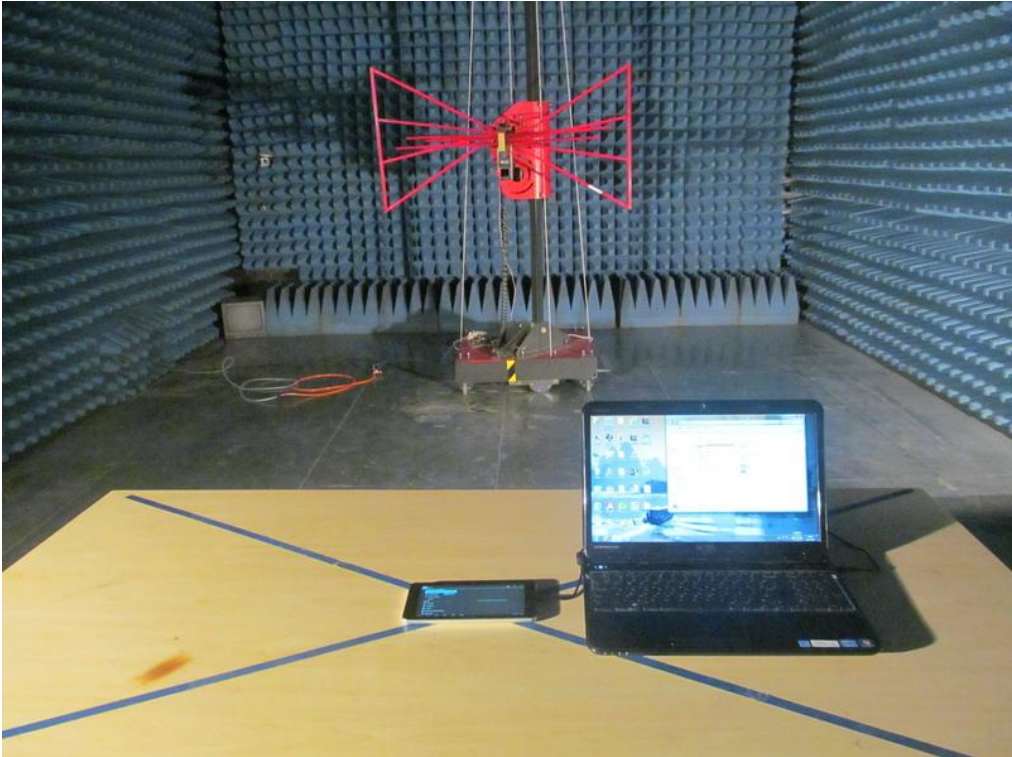

**APPENDIX B: PHOTOGRAPHS OF EUT**  
TOTAL VIEW OF EUT



TOP VIEW OF EUT





BOTTOM VIEW OF EUT



FRONT VIEW OF EUT



BACK VIEW OF EUT



LEFT VIEW OF EUT



RIGHT VIEW OF EUT



OPEN VIEW OF EUT-1



INTERNAL VIEW OF EUT-1

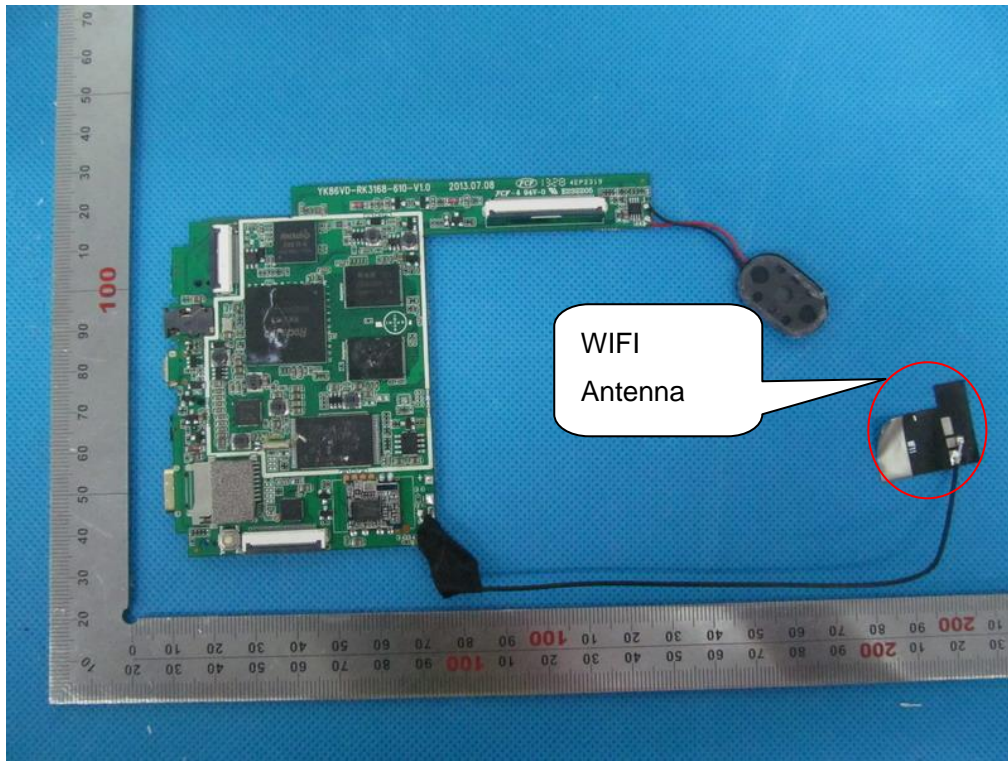

INTERNAL VIEW OF EUT-2



----END OF REPORT--