

FCC 47 CFR PART 15 SUBPART C

CERTIFICATION TEST REPORT

For

Bluetooth Headphone

Model No.: S3

FCC ID: 2AALP-S3

Trademark: XSOUND

REPORT NO.: ES151023046E2

ISSUE DATE: November 15, 2015

Prepared for

Shenzhen XSOUND Innovation Technologies Co.,Ltd.

Building C, Junxing industrial zone B, Haoye Road, Heping, Fuyong ,Baoan,
Shenzhen, 518103, China

Prepared by

EMTEK (Shenzhen) Co., Ltd.

Bldg 69, Majialong Industry Zone, Nanshan District, Shenzhen,
Guangdong, China

TEL: 86-755-26954280

FAX: 86-755-26954282

Table of Contents

1	TEST RESULT CERTIFICATION	3
2	EUT TECHNICAL DESCRIPTION	4
3	SUMMARY OF TEST RESULT	6
4	TEST METHODOLOGY.....	7
4.1	GENERAL DESCRIPTION OF APPLIED STANDARDS	7
4.2	MEASUREMENT EQUIPMENT USED	7
4.3	DESCRIPTION OF TEST MODES	8
5	FACILITIES AND ACCREDITATIONS.....	9
5.1	FACILITIES	9
5.2	LABORATORY ACCREDITATIONS AND LISTINGS.....	9
6	TEST SYSTEM UNCERTAINTY	10
7	SETUP OF EQUIPMENT UNDER TEST	11
7.1	RADIO FREQUENCY TEST SETUP 1	11
7.2	RADIO FREQUENCY TEST SETUP 2	11
7.3	CONDUCTED EMISSION TEST SETUP.....	12
7.4	SUPPORT EQUIPMENT	12
8	TEST REQUIREMENTS.....	13
8.1	DTS (6DB) BANDWIDTH	13
8.2	MAXIMUM PEAK CONDUCTED OUTPUT POWER.....	16
8.3	MAXIMUM POWER SPECTRAL DENSITY	19
8.4	UNWANTED EMISSIONS IN NON-RESTRICTED FREQUENCY BANDS	22
8.5	RADIATED SPURIOUS EMISSION.....	27
8.6	CONDUCTED EMISSIONS TEST	39
8.7	ANTENNA APPLICATION.....	44

1 TEST RESULT CERTIFICATION

Applicant:	Shenzhen XSOUND Innovation Technologies Co.,Ltd. Building C, Junxing industrial zone B, Haoye Road, Heping, Fuyong ,Baoan, Shenzhen, 518103, China
Manufacturer:	Shenzhen XSOUND Innovation Technologies Co.,Ltd. Building C, Junxing industrial zone B, Haoye Road, Heping, Fuyong ,Baoan, Shenzhen, 518103, China
Product Description:	Bluetooth Headphone
Model Number:	S3
File Number:	ES151023046E2
Date of Test:	October 23, 2015 to November 15, 2015

Measurement Procedure Used:

APPLICABLE STANDARDS	
STANDARD	TEST RESULT
FCC 47 CFR Part 2, Subpart J:2014 FCC 47 CFR Part 15, Subpart C:2014	PASS

The above equipment was tested by EMTEK (Shenzhen) Co., Ltd. The test data, data evaluation, test procedures, and equipment configurations shown in this report were made in accordance with the procedures given in ANSI C63.10 (2013) and the energy emitted by the sample EUT tested as described in this report is in compliance with the requirements of FCC Rules Part 2 and Part 15.247

The test results of this report relate only to the tested sample identified in this report

Date of Test : October 23, 2015 to November 15, 2015

Prepared by : 
Andy Wei/Editor

Reviewer : 
Joe Xia/Supervisor

Approve & Authorized Signer : 
Lisa Wang/Manager

2 EUT TECHNICAL DESCRIPTION

Characteristics	Description
Device Type:	Portable device
Data Rate	1Mbps
Modulation:	1Mbps for GFSK modulation
Operating Frequency Range(s):	2402-2480MHz
Number of Channels:	79 channels for DSS 40 channels for DTS
Transmit Power Max:	DSS: 3.777dBm DTS: 4.625dBm
Antenna Type :	Multilayer Chip Antenna
Antenna Gain:	0.5dBi
Power supply:	DC 3.7V internal rechargeable lithium battery or DC 5V from AC Adapter
Temperature Range:	0°C ~ +40°C
RF power setting in TEST SW:	Maximum power

Note: for more details, please refer to the User's manual of the EUT.

Modified Information

Version.	Summary	Date of Rev.	Report No.
Ver.1.0	Original Report	2015-11-15	ES151023046E2

3 SUMMARY OF TEST RESULT

FCC Part Clause	Test Parameter	Verdict	Remark
15.247(a)(2)	DTS (6dB) Bandwidth	PASS	
15.247(b)(3)	Maximum Peak Conducted Output Power	PASS	
15.247(e)	Maximum Power Spectral Density Level	PASS	
15.247(d)	Unwanted Emission Into Non-Restricted Frequency Bands	PASS	
15.247(d) 15.209	Unwanted Emission Into Restricted Frequency Bands (conducted)	PASS	
15.247(d) 15.209	Radiated Spurious Emission	PASS	
15.207	Conducted Emission Test	PASS	
15.247(b)	Antenna Application	PASS	
NOTE1: N/A (Not Applicable)			
NOTE2: According to FCC OET KDB 558074, the report use radiated measurements in the restricted frequency bands. In addition, the radiated test is also performed to ensure the emissions emanating from the device cabinet also comply with the applicable limits.			

RELATED SUBMITTAL(S) / GRANT(S):

This submittal(s) (test report) is intended for FCC ID: 2AALP-S3 filing to comply with Section 15.247 of the FCC Part 15, Subpart C Rules.

4 TEST METHODOLOGY

4.1 GENERAL DESCRIPTION OF APPLIED STANDARDS

According to its specifications, the EUT must comply with the requirements of the following standards:

FCC 47 CFR Part 2, Subpart J

FCC 47 CFR Part 15, Subpart C

FCC KDB 558074 D01 DTS Meas Guidance v03r02

FCC KDB 662911 D01 Multiple Transmitter Output v01

FCC KDB 662911 D02 MIMO With Cross Polarized Antenna V01

4.2 MEASUREMENT EQUIPMENT USED

4.2.1 Conducted Emission Test Equipment

EQUIPMENT TYPE	MFR	MODEL NUMBER	SERIAL NUMBER	LAST CAL.
Test Receiver	Rohde & Schwarz	ESCS30	828985/018	05/16/2015
L.I.S.N.	Schwarzbeck	NNLK8129	8129203	05/16/2015
50Ω Coaxial Switch	Anritsu	MP59B	M20531	N/A
Pulse Limiter	Rohde & Schwarz	ESH3-Z2	100006	05/16/2015
Voltage Probe	Rohde & Schwarz	TK9416	N/A	05/16/2015
I.S.N	Rohde & Schwarz	ENY22	1109.9508.02	05/16/2015

4.2.2 Radiated Emission Test Equipment

EQUIPMENT TYPE	MFR	MODEL NUMBER	SERIAL NUMBER	LAST CAL.
EMI Test Receiver	Rohde & Schwarz	ESU	1302.6005.26	05/16/2015
Pre-Amplifier	HP	8447D	2944A07999	05/16/2015
Bilog Antenna	Schwarzbeck	VULB9163	142	05/16/2015
Loop Antenna	ARA	PLA-1030/B	1029	05/16/2015
Horn Antenna	Schwarzbeck	BBHA 9170	BBHA9170399	05/16/2015
Horn Antenna	Schwarzbeck	BBHA 9120	D143	05/16/2015
Cable	Schwarzbeck	AK9513	ACRX1	05/16/2015
Cable	Rosenberger	N/A	FP2RX2	05/16/2015
Cable	Schwarzbeck	AK9513	CRPX1	05/16/2015
Cable	Schwarzbeck	AK9513	CRRX2	05/16/2015

4.2.3 Radio Frequency Test Equipment

EQUIPMENT TYPE	MFR	MODEL NUMBER	SERIAL NUMBER	LAST CAL.
Spectrum Analyzer	Agilent	E4407B	88156318	05/16/2015
EMI Test Receiver	Rohde & Schwarz	FSV30	103040	05/16/2015
Signal Analyzer	Agilent	N9010A	My53470879	05/16/2015
Power meter	Anritsu	ML2495A	0824006	05/16/2015
Power sensor	Anritsu	MA2411B	0738172	05/16/2015

Remark: Each piece of equipment is scheduled for calibration once a year.

4.3 DESCRIPTION OF TEST MODES

The EUT has been tested under its typical operating condition.

The EUT configuration for testing is installed on RF field strength measurement to meet the Commissions requirement and operating in a manner which intends to maximize its emission characteristics in a continuous normal application.

The Transmitter was operated in the normal operating mode. The TX frequency was fixed which was for the purpose of the measurements.

Test of channel included the lowest and middle and highest frequency to perform the test, then record on this report.

Those data rates (Bluetooth V4.0:1Mbps) were used for all test.

Pre-defined engineering program for regulatory testing used to control the EUT for staying in continuous transmitting and receiving mode is programmed.

All the modulation modes and channels were tested, the data of the worst mode are described in the following pages

The EUT was pretested with 3 orientations placed on the table for the radiated emission measurement –X, Y, and Z-plane. The Y-plane results were found as the worst case and were shown in this report.

Frequency and Channel list for Bluetooth V4.0:

Channel	Frequency (MHz)	Channel	Frequency (MHz)	Channel	Frequency (MHz)
0	2402	19	2440
1	2404	20	2442	37	2476
2	2406	21	2444	38	2478
...	39	2480

Note: $f_c = 2402\text{MHz} + k \times 1\text{MHz}$ $k = 0$ to 39

Test Frequency and channel for Bluetooth V4.0:

Lowest Frequency		Middle Frequency		Highest Frequency	
Channel	Frequency (MHz)	Channel	Frequency (MHz)	Channel	Frequency (MHz)
0	2402	19	2440	39	2480

5 FACILITIES AND ACCREDITATIONS

5.1 FACILITIES

All measurement facilities used to collect the measurement data are located at

Bldg 69, Majialong Industry Zone District, Nanshan District, Shenzhen, China

The sites are constructed in conformance with the requirements of ANSI C63.7, ANSI C63.10 and CISPR Publication 22.

5.2 LABORATORY ACCREDITATIONS AND LISTINGS

Site Description

- EMC Lab.
- : Accredited by CNAS, 2013.10.29
The certificate is valid until 2016.10.28
The Laboratory has been assessed and proved to be in compliance with CNAS-CL01: 2006(identical to ISO/IEC17025: 2005)
The Certificate Registration Number is L2291
 - : Accredited by TUV Rheinland Shenzhen, 2010.5.25
The Laboratory has been assessed according to the requirements ISO/IEC 17025.
 - : Accredited by FCC, October 28, 2010
The Certificate Registration Number is 406365.
 - : Accredited by FCC, February 28, 2013
The Certificate Registration Number is 709623.
 - : Accredited by Industry Canada, May 24, 2008
The Certificate Registration Number is 4480A-2

6 TEST SYSTEM UNCERTAINTY

The following measurement uncertainty levels have been estimated for tests performed on the apparatus:

Parameter	Uncertainty
Radio Frequency	$\pm 1 \times 10^{-5}$
Maximum Peak Output Power Test	$\pm 1.0\text{dB}$
Conducted Emissions Test	$\pm 2.0\text{dB}$
Radiated Emission Test	$\pm 2.0\text{dB}$
Power Density	$\pm 2.0\text{dB}$
Occupied Bandwidth Test	$\pm 1.0\text{dB}$
Band Edge Test	$\pm 3\text{dB}$
All emission, radiated	$\pm 3\text{dB}$
Antenna Port Emission	$\pm 3\text{dB}$
Temperature	$\pm 0.5^\circ\text{C}$
Humidity	$\pm 3\%$

Measurement Uncertainty for a level of Confidence of 95%

7 SETUP OF EQUIPMENT UNDER TEST

7.1 RADIO FREQUENCY TEST SETUP 1

The Bluetooth 4.0 DTS component's antenna ports(s) of the EUT are connected to the measurement instrument per an appropriate attenuator. The EUT is controlled by PC/software to emit the specified signals for the purpose of measurements.

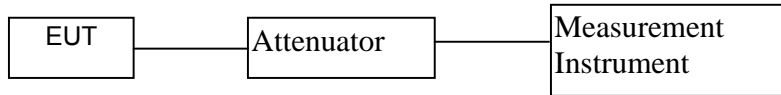

7.2 RADIO FREQUENCY TEST SETUP 2

The test site semi-anechoic chamber has met the requirement of NSA tolerance 4 dB according to the standards: ANSI C63.10. The test distance is 3m. The setup is according to the requirements in Section 13.1.4.1 of ANSI C63.10-2013 and CAN/CSA-CEI/IEC CISPR 22.

The maximal emission value is acquired by adjusting the antenna height, polarisation and turntable azimuth. Normally, the height range of antenna is 1 m to 4 m, the azimuth range of turntable is 0° to 360°, and the receive antenna has two polarizations Vertical (V) and Horizontal (H).

(a) Radiated Emission Test Set-Up, Frequency Below 30MHz

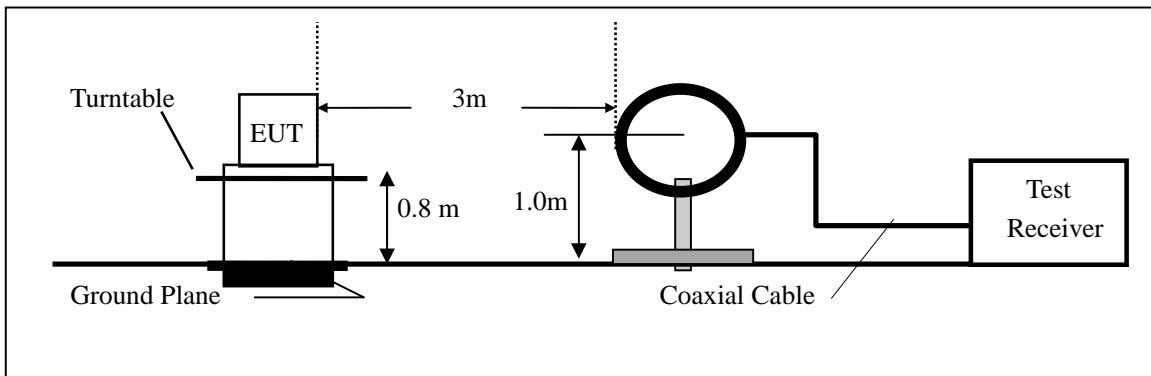

(b) Radiated Emission Test Set-Up, Frequency Below 1000MHz

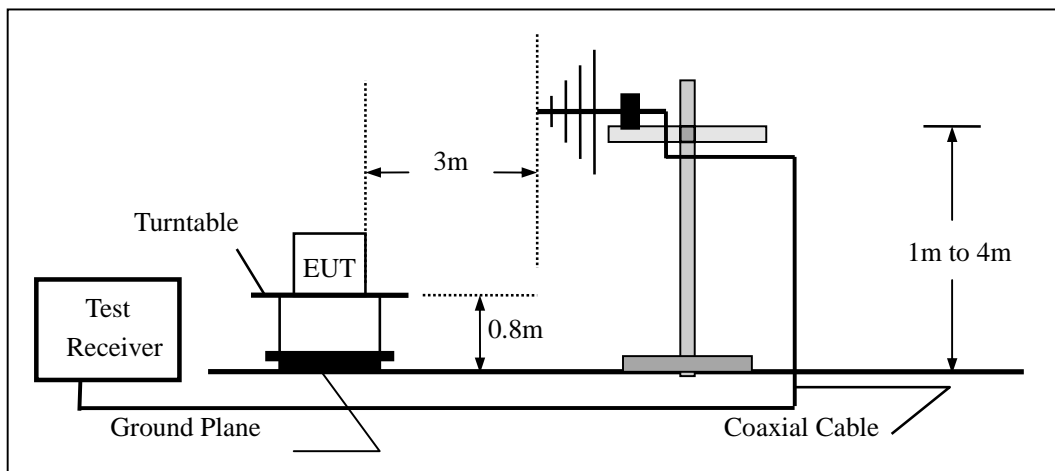

(b) Radiated Emission Test Set-Up, Frequency above 1000MHz

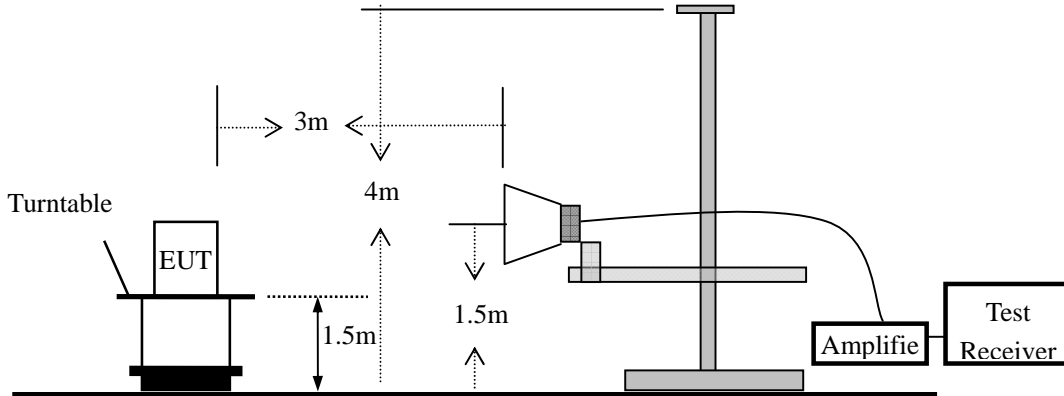

7.3 CONDUCTED EMISSION TEST SETUP

The mains cable of the EUT (Bluetooth Headphone) must be connected to LISN. The LISN shall be placed 0.8 m from the boundary of EUT and bonded to a ground reference plane for LISN mounted on top of the ground reference plane. This distance is between the closest points of the LISN and the EUT. All other units of the EUT and associated equipment shall be at least 0.8m from the LISN.

Ground connections, where required for safety purposes, shall be connected to the reference ground point of the LISN and, where not otherwise provided or specified by the manufacturer, shall be of same length as the mains cable and run parallel to the mains connection at a separation distance of not more than 0.1 m.

According to the requirements in Section 13.1.4.1 of ANSI C63.10-2013 Conducted emissions from the EUT measured in the frequency range between 0.15 MHz and 30 MHz using CISPR Quasi-Peak and average detector mode.

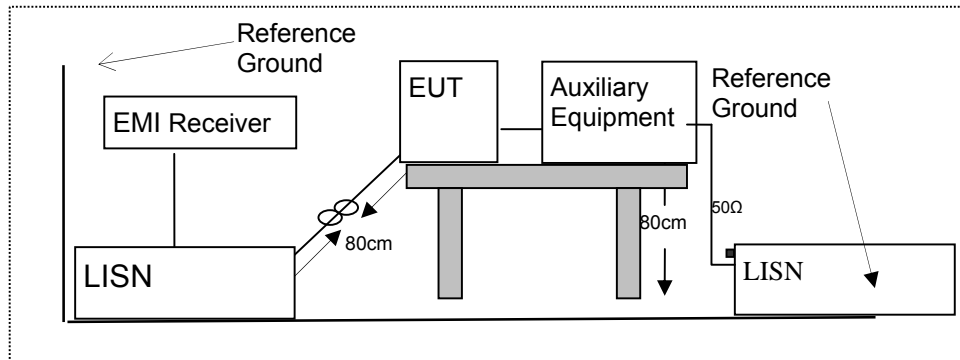

7.4 SUPPORT EQUIPMENT

Item	Equipment	Mfr/Brand	Model/Type No.	Series No.	Note

Notes:

1. All the equipment/cables were placed in the worst-case configuration to maximize the emission during the test.
2. Grounding was established in accordance with the manufacturer's requirements and conditions for the intended use.

8 TEST REQUIREMENTS

8.1 DTS (6DB) BANDWIDTH

8.1.1 Applicable Standard

According to FCC Part 15.247(a)(2) and KDB 558074 DTS 01 Meas. Guidance v03r02

8.1.2 Conformance Limit

The minimum -6 dB bandwidth shall be at least 500 kHz.

8.1.3 Test Configuration

Test according to clause 7.1 radio frequency test setup 1

8.1.4 Test Procedure

The EUT was operating in Bluetooth 4.0 DTS mode and controlled its channel. Printed out the test result from the spectrum by hard copy function.

The RF output of EUT was connected to the spectrum analyzer by RF cable and attenuator. The path loss was compensated to the results for each measurement.

Set to the maximum power setting and enable the EUT transmit continuously

Set RBW = 100 kHz.

Set the video bandwidth (VBW) =300 kHz.

Set Span=2 times OBW

Set Detector = Peak.

Set Trace mode = max hold.

Set Sweep = auto couple.

Allow the trace to stabilize.

Measure the maximum width of the emission that is constrained by the frequencies associated with the two outermost amplitude points (upper and lower frequencies) that are attenuated by 6 dB relative to the maximum level measured in the fundamental emission.

Measure and record the results in the test report.

Test Results

Temperature : 24°C
Humidity : 53 %

Test Date : November 15, 2015
Test By: KING KONG

Operation Mode	Channel Number	Channel Frequency (MHz)	Measurement Bandwidth (kHz)	Limit (kHz)	Verdict
Bluetooth 4.0 DTS	0	2402	588.1	>500	PASS
	19	2440	589.2	>500	PASS
	39	2480	581.0	>500	PASS

Test Model	DTS (6dB) Bandwidth	
	Bluetooth4.0 DTS	
	Channel 0: 2402MHz	GFSK modulation

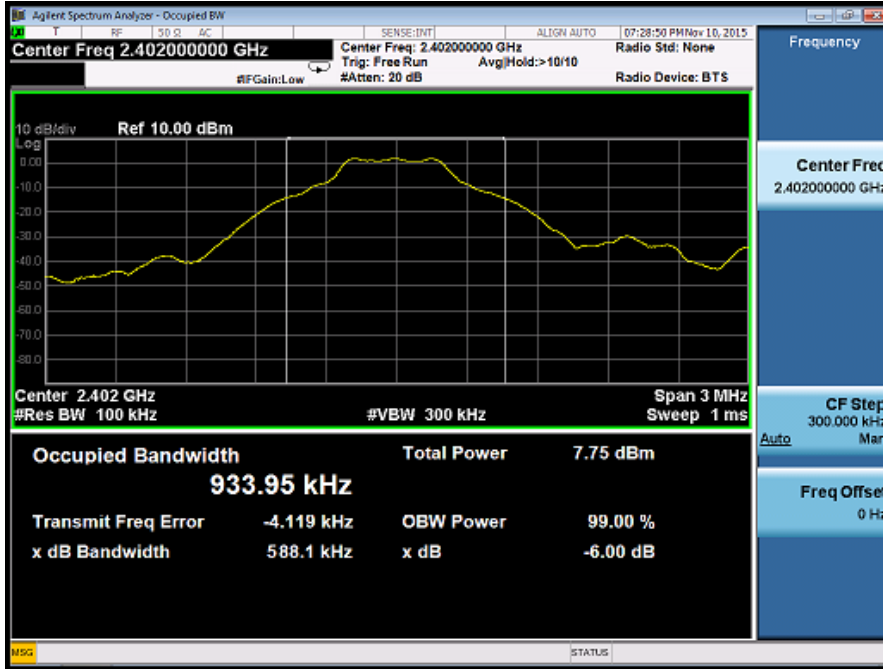

Test Model	DTS (6dB) Bandwidth	
	Bluetooth4.0 DTS	
	Channel 19: 2440MHz	GFSK modulation

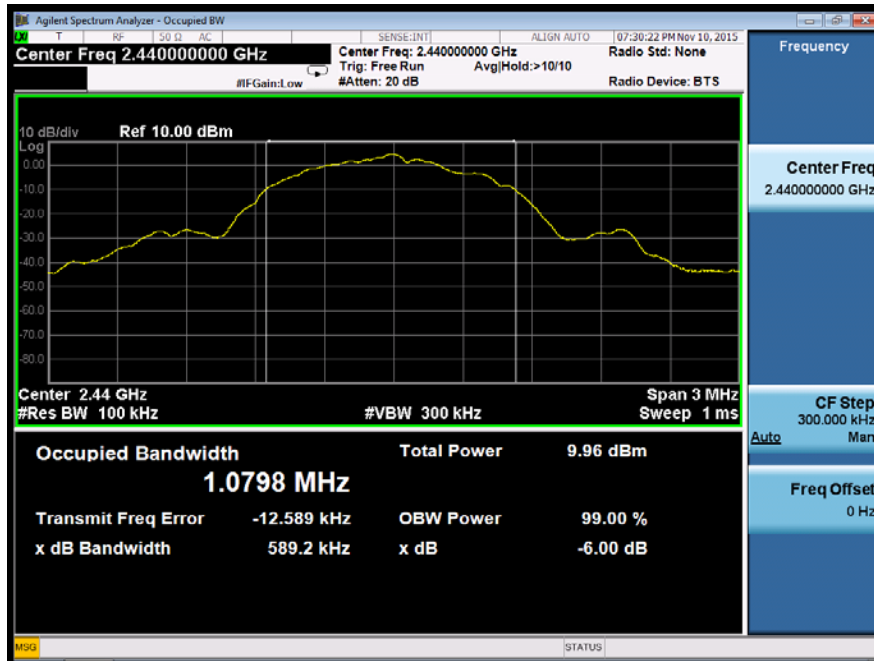

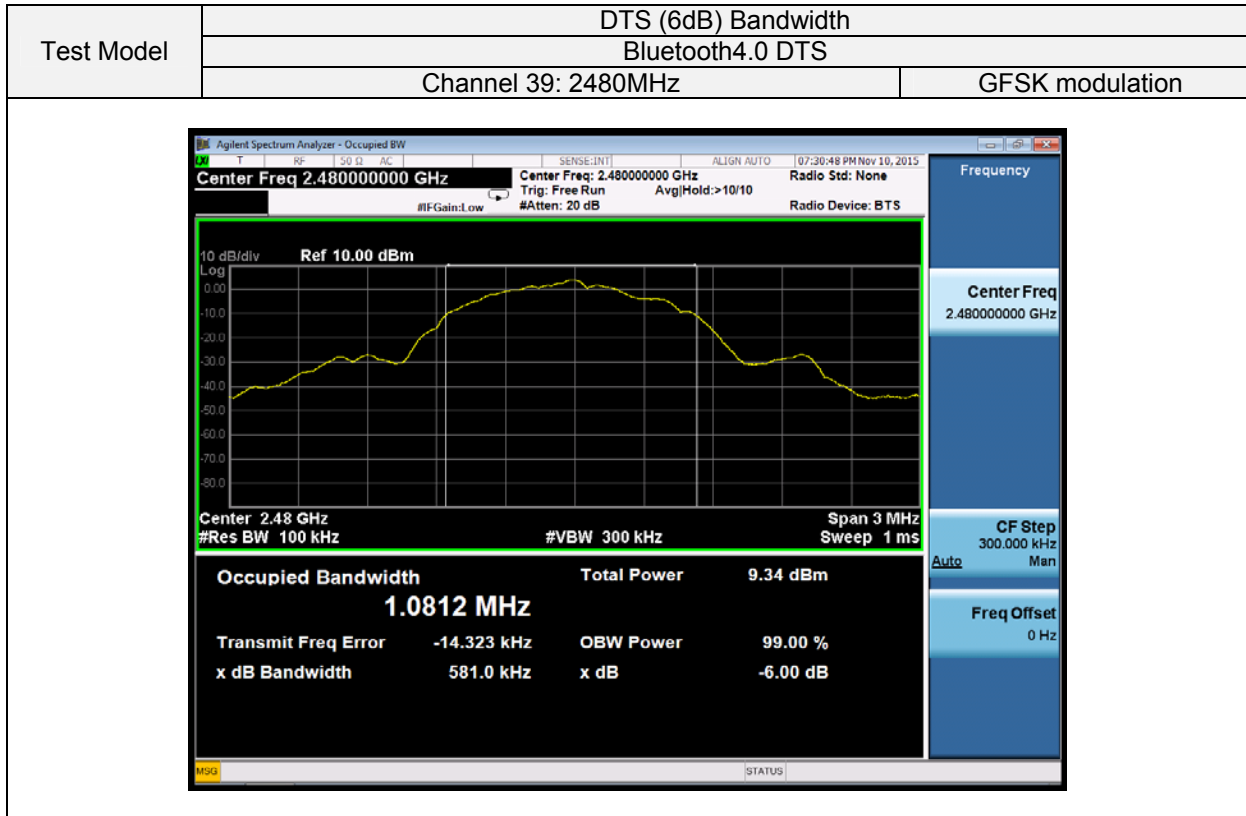

8.2 MAXIMUM PEAK CONDUCTED OUTPUT POWER

8.2.1 Applicable Standard

According to FCC Part 15.247(b)(3) and KDB 558074 DTS 01 Meas. Guidance v03r02

8.2.2 Conformance Limit

The maximum peak conducted output power of the intentional radiator for systems using digital modulation in the 2400 - 2483.5 MHz bands shall not exceed: 1 Watt (30dBm).

8.2.3 Test Configuration

Test according to clause 7.1 radio frequency test setup 1

8.2.4 Test Procedure

■ According to FCC Part 15.247(b)(3)

As an alternative to a peak power measurement, compliance with the one Watt limit can be based on a measurement of the maximum conducted output power. For smart system, Maximum Conducted Output Power is defined as the total transmit power delivered to all antennas and antenna elements averaged across all symbols in the signaling alphabet when the transmitter is operating at its maximum power control level. Power must be summed across all antennas and antenna elements. If multiple modes of operation are possible (e.g., alternative modulation methods), the maximum conducted output power is the highest total transmit power occurring in any mode.

Set the RBW \cong DTS bandwidth (about 1MHz).

Set VBW = 3*RBW (about 3MHz)

Set the span \cong 3*RBW

Set Sweep time = auto couple.

Set Detector = peak.

Set Trace mode = max hold.

Allow trace to fully stabilize. Use peak marker function to determine the peak amplitude level.

■ According to FCC Part 15.247(b)(4):

Conducted output power limit specified in paragraph (b) of this section is based on the use of antennas with directional gains that do not exceed 6 dBi. If transmitting antennas of directional gain greater than 6 dBi are used, the conducted output power from the intentional radiator shall be reduced below the stated values in paragraphs (b)(3) of this section, as appropriate, by the amount in dB that the directional gain of the antenna exceeds 6 dBi.

Test Results

Temperature:	24 °C	Test Date:	November 15, 2015
Humidity:	53 %	Test By:	KING KONG

Operation Mode	Channel Number	Channel Frequency (MHz)	Measurement Level (dBm)	Limit (dBm)	Verdict
Bluetooth 4.0 DTS	0	2402	4.069	30	PASS
	19	2440	4.625	30	PASS
	39	2480	3.618	30	PASS

Test Model	Maximum Conducted Output Power	
	Bluetooth4.0 DTS	
	Channel 0: 2402MHz	GFSK modulation

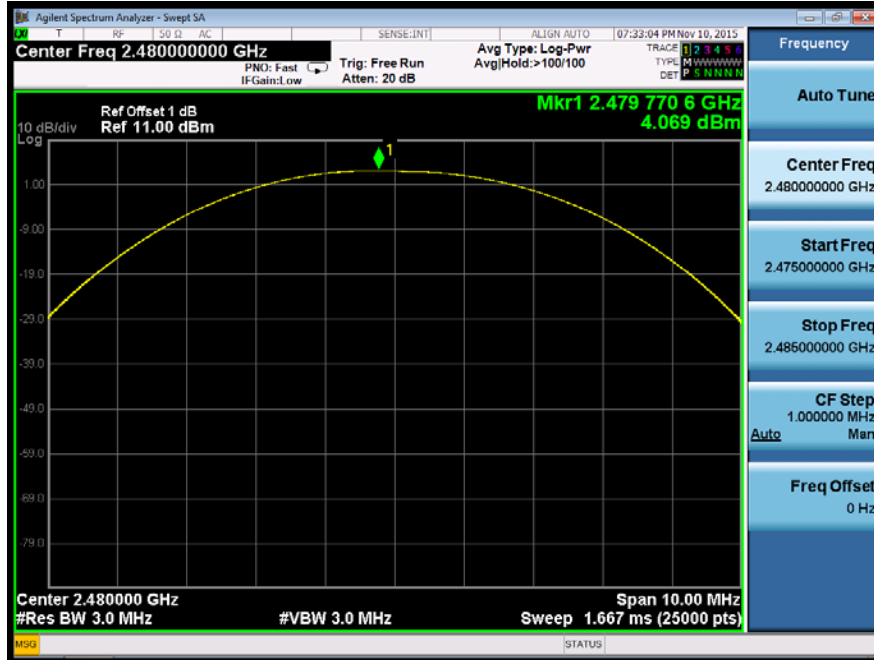

Test Model	Maximum Conducted Output Power	
	Bluetooth4.0DTS	
	Channel 19: 2440MHz	GFSK modulation

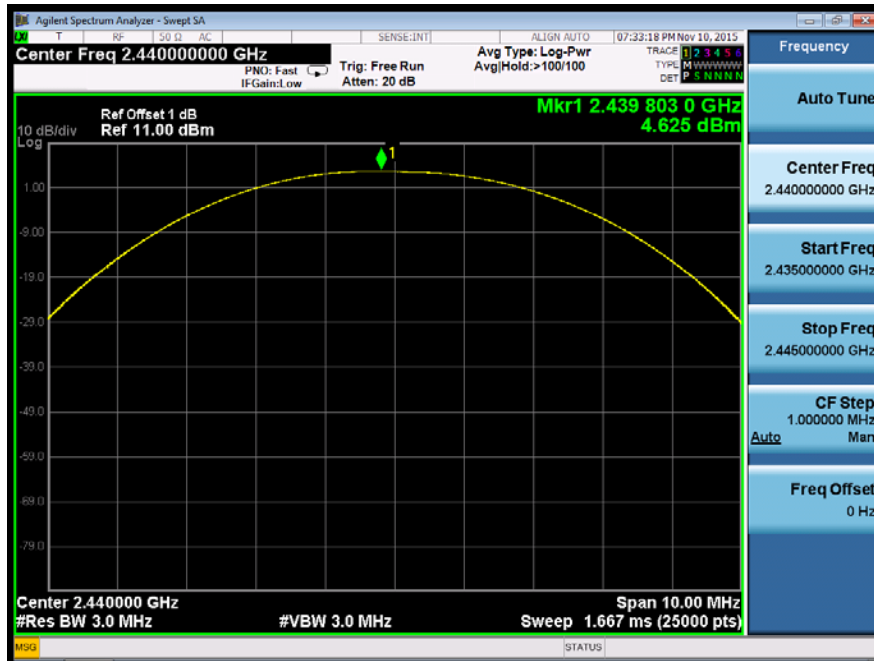

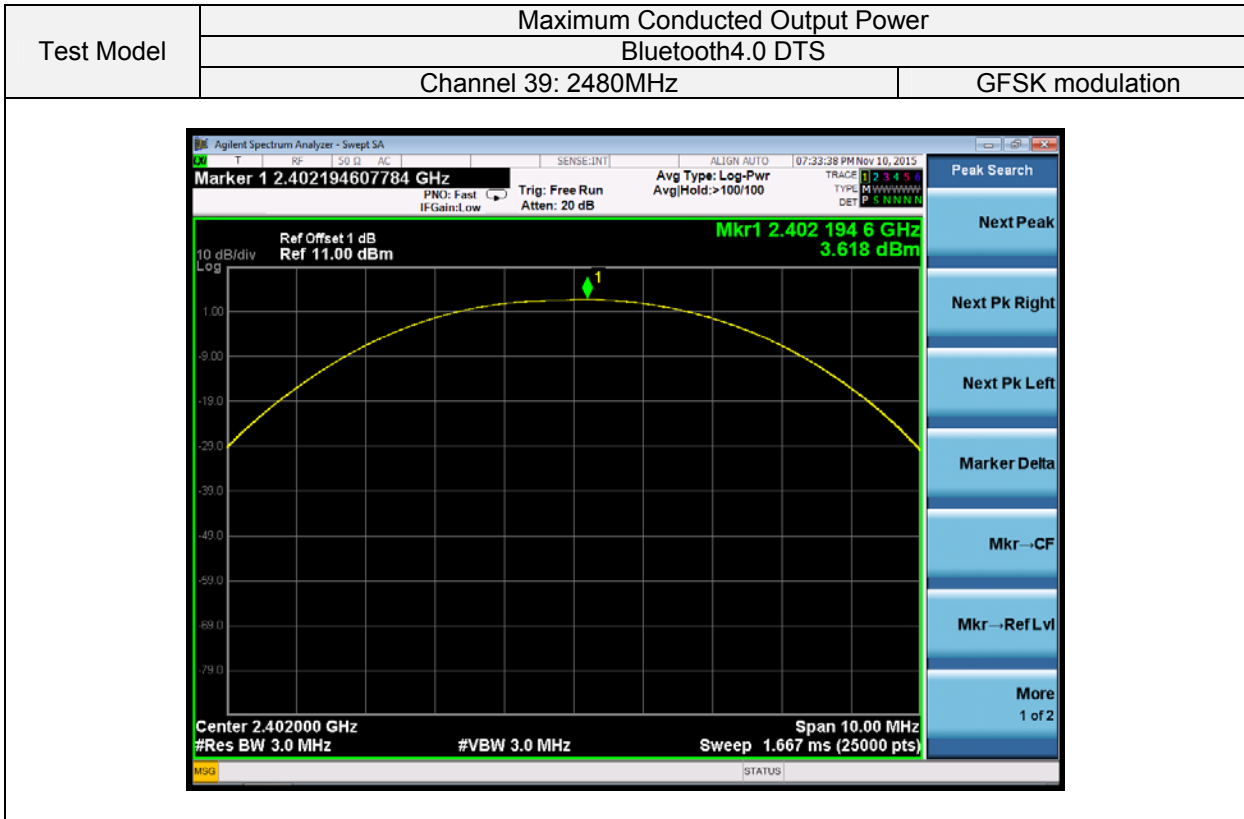

8.3 MAXIMUM POWER SPECTRAL DENSITY

8.3.1 Applicable Standard

According to FCC Part 15.247(e) and KDB 558074 DTS 01 Meas. Guidance v03r02

8.3.2 Conformance Limit

The transmitter power spectral density conducted from the transmitter to the antenna shall not be greater than 8 dBm in any 3 kHz band during any time interval of continuous transmission.

8.3.3 Test Configuration

Test according to clause 7.1 radio frequency test setup 1

8.3.4 Test Procedure

This procedure shall be used if maximum peak conducted output power was used to demonstrate compliance

The transmitter output (antenna port) was connected to the spectrum analyzer

Set analyzer center frequency to DTS channel center frequency.

Set the span to 1.5 times the DTS bandwidth.

Set the RBW to: 3 kHz

Set the VBW to: 10 kHz.

Set Detector = peak.

Set Sweep time = auto couple.

Set Trace mode = max hold.

Allow trace to fully stabilize.

Use the peak marker function to determine the maximum amplitude level within the RBW.

8.3.5 Test Results

Temperature: 24°C

Test Date: November 15, 2015

Humidity: 53 %

Test By: KING KONG

Operation Mode	Channel Number	Channel Frequency (MHz)	Measurement Level (dBm/3kHz)	Limit (dBm/3kHz)	Verdict
Bluetooth 4.0 DTS	0	2402	2.308	8	PASS
	19	2440	3.310	8	PASS
	39	2480	2.736	8	PASS
Note: N/A					

Test Model	Power Spectral Density	
	Bluetooth 4.0 DTS	
	Channel 0: 2402MHz	GFSK modulation



Test Model	Power Spectral Density	
	Bluetooth 4.0 DTS	
	Channel 19: 2440MHz	GFSK modulation



Test Model	Power Spectral Density	
	Bluetooth 4.0 DTS	
	Channel 39: 2480MHz	GFSK modulation



8.4 UNWANTED EMISSIONS IN NON-RESTRICTED FREQUENCY BANDS

8.4.1 Applicable Standard

According to FCC Part 15.247(d) and KDB 558074 DTS 01 Meas. Guidance v03r02

8.4.2 Conformance Limit

According to FCC Part 15.247(d):

In any 100 kHz bandwidth outside the frequency band in which the spread spectrum or digitally modulated intentional radiator is operating, the radio frequency power that is produced by the intentional radiator shall be at least 20 dB below that in the 100 kHz bandwidth within the band that contains the highest level of the desired power, based on either an RF conducted or a radiated measurement, provided the transmitter demonstrates compliance with the peak conducted power limits. If the transmitter complies with the conducted power limits based on the use of RMS averaging over a time interval, as permitted under paragraph (b)(3) of this section, the attenuation required under this paragraph shall be 30 dB instead of 20 dB.

8.4.3 Test Configuration

Test according to clause 7.1 radio frequency test setup 1

8.4.4 Test Procedure

The transmitter output (antenna port) was connected to the spectrum analyzer

■ Reference level measurement

Establish a reference level by using the following procedure:

Set instrument center frequency to DTS channel center frequency.

Set the span to = 1.5 times the DTS bandwidth.

Set the RBW = 100 kHz.

Set the VBW $\geq 3 \times$ RBW.

Set Detector = peak.

Set Sweep time = auto couple.

Set Trace mode = max hold.

Allow trace to fully stabilize.

Use the peak marker function to determine the maximum PSD level.

Note that the channel found to contain the maximum PSD level can be used to establish the reference level.

■ Emission level measurement

Set the center frequency and span to encompass frequency range to be measured.

Set the RBW = 100 kHz.

Set the VBW = 300 kHz.

Set Detector = peak

Sweep time = auto couple.

Trace mode = max hold.

Allow trace to fully stabilize.

Use the peak marker function to determine the maximum amplitude level.

Ensure that the amplitude of all unwanted emissions outside of the authorized frequency band (excluding restricted frequency bands) are attenuated by at least the minimum requirements. Report the three highest emissions relative to the limit.

8.4.5 Test Results

Test Model	PSD(Power Spectral Density) RBW=100kHz	
	Bluetooth 4.0 DTS	
	Channel 0: 2402MHz	GFSK modulation

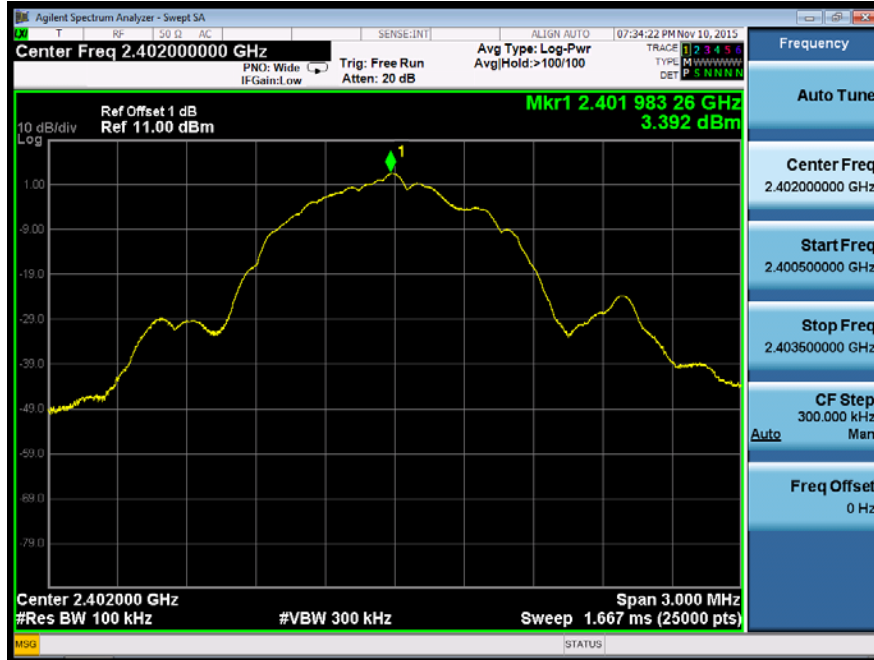

Test Model	Unwanted Emissions in non-restricted frequency bands	
	Bluetooth 4.0 DTS	
	Channel 0: 2402MHz	GFSK modulation



Test Model	PSD(Power Spectral Density) RBW=100kHz	
	Bluetooth 4.0 DTS	
	Channel 19: 2440MHz	GFSK modulation

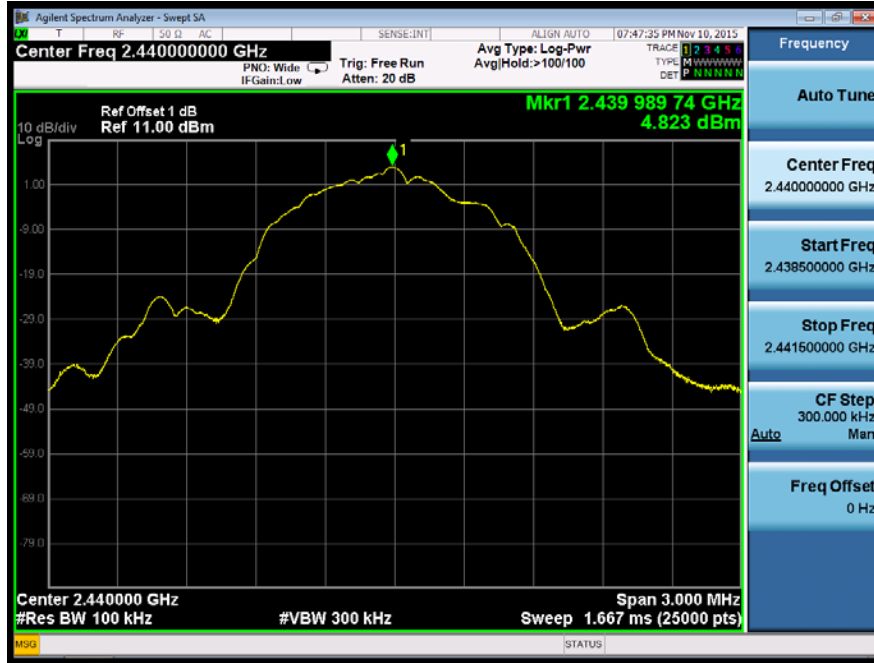

Test Model	Unwanted Emissions in non-restricted frequency bands	
	Bluetooth 4.0 DTS	
	Channel 19: 2440MHz	GFSK modulation



Test Model	PSD(Power Spectral Density) RBW=100kHz	
	Bluetooth 4.0 DTS	
	Channel 39: 2480MHz	GFSK modulation

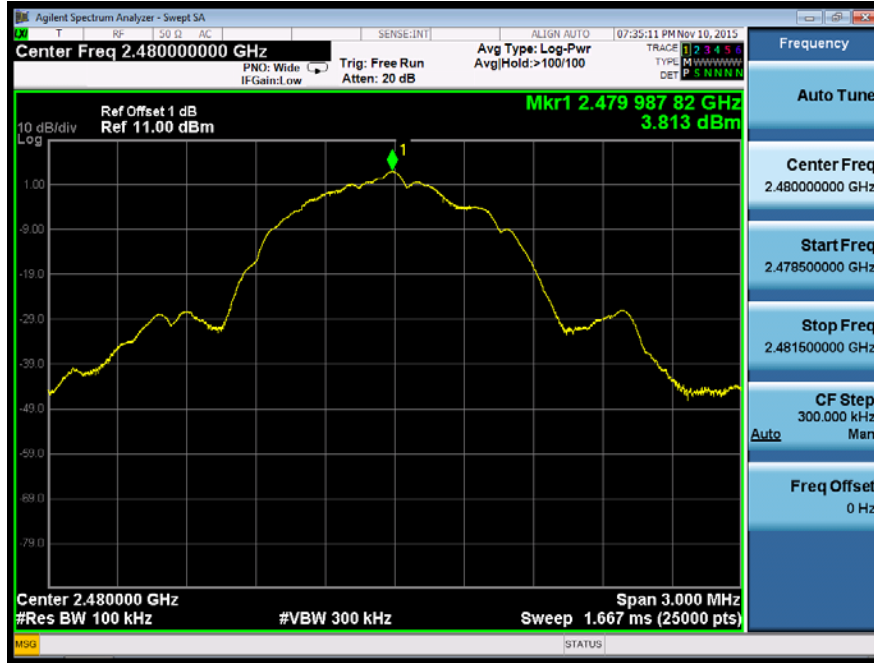

Test Model	Unwanted Emissions in non-restricted frequency bands	
	Bluetooth 4.0 DTS	
	Channel 39: 2480MHz	GFSK modulation



Test Model	Band edge	
	Bluetooth 4.0 DTS	
	Channel 0: 2402MHz	GFSK modulation



Test Model	Band edge	
	Bluetooth 4.0 DTS	
	Channel 39: 2480MHz	GFSK modulation

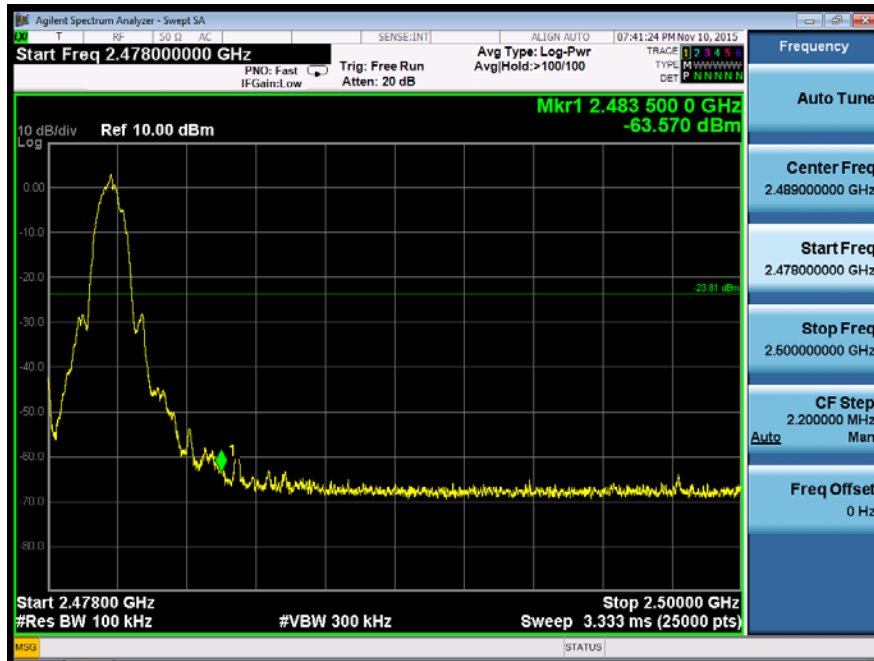

8.5 RADIATED SPURIOUS EMISSION

8.5.1 Applicable Standard

According to FCC Part 15.247(d) and 15.209 and KDB 558074 DTS 01 Meas. Guidance v03r02

8.5.2 Conformance Limit

According to FCC Part 15.247(d): radiated emissions which fall in the restricted bands, as defined in §15.205(a), must also comply with the radiated emission limits specified in §15.209(a) (see §15.205(c)).
According to FCC Part 15.205, Restricted bands

MHz	MHz	MHz	GHz
0.090-0.110	16.42-16.423	399.9-410	4.5-5.15
10.495-0.505	16.69475-16.69525	608-614	5.35-5.46
2.1735-2.1905	16.80425-16.80475	960-1240	7.25-7.75
4.125-4.128	25.5-25.67	1300-1427	8.025-8.5
4.17725-4.17775	37.5-38.25	1435-1626.5	9.0-9.2
4.20725-4.20775	73-74.6	1645.5-1646.5	9.3-9.5
6.215-6.218	74.8-75.2	1660-1710	10.6-12.7
6.26775-6.26825	123-138	2200-2300	14.47-14.5
8.291-8.294	149.9-150.05	2310-2390	15.35-16.2
8.362-8.366	156.52475-156.52525	2483.5-2500	17.7-21.4
8.37625-8.38675	156.7-156.9	2690-2900	22.01-23.12
8.41425-8.41475	162.0125-167.17	3260-3267	23.6-24.0
12.29-12.293	167.72-173.2	3332-3339	31.2-31.8
12.51975-12.52025	240-285	3345.8-3358	36.43-36.5
12.57675-12.57725	322-335.4	3600-4400	(2)
13.36-13.41			

According to FCC Part 15.205, the level of any transmitter spurious emission in Restricted bands shall not exceed the level of the emission specified in the following table

Restricted Frequency(MHz)	Field Strength ($\mu\text{V}/\text{m}$)	Field Strength ($\text{dB}\mu\text{V}/\text{m}$)	Measurement Distance
0.009-0.490	2400/F(KHz)	20 log ($\mu\text{V}/\text{m}$)	300
0.490-1.705	2400/F(KHz)	20 log ($\mu\text{V}/\text{m}$)	30
1.705-30	30	29.5	30
30-88	100	40	3
88-216	150	43.5	3
216-960	200	46	3
Above 960	500	54	3

Remark :1. Emission level in $\text{dB}\mu\text{V}/\text{m}=20 \log (\mu\text{V}/\text{m})$

2. Measurement was performed at an antenna to the closed point of EUT distance of meters.

3. Distance extrapolation factor $=40 \log (\text{Specific distance}/ \text{test distance})(\text{dB})$;

Limit line=Specific limits($\text{dB}\mu\text{V}$) + distance extrapolation factor.

for the frequency ranges below 30 MHz, a narrower RBW is used for these ranges but the measured value should add a RBW correction factor (RBWCF) where $\text{RBWCF} [\text{dB}] =10 \cdot \lg (100 [\text{kHz}]/\text{narrower RBW} [\text{kHz}])$. , the narrower RBW is 1 kHz and RBWCF is 20 dB for the frequency 9 kHz to 150 kHz, and the narrower RBW is 10 kHz and RBWCF is 10 dB for the frequency 150 kHz to 30 MHz.

8.5.3 Test Configuration

Test according to clause 7.2 radio frequency test setup 2

8.5.4 Test Procedure

This test is required for any spurious emission that falls in a Restricted Band, as defined in Section 15.205. It must be performed with the highest gain of each type of antenna proposed for use with the EUT. Use the following spectrum analyzer settings:

For Above 1GHz:

The EUT was placed on a turn table which is 1.5m above ground plane.

Maximum procedure was performed on the highest emissions to ensure EUT compliance.

Span = wide enough to fully capture the emission being measured

RBW = 1 MHz

VBW ≥ RBW for peak measurement

VBW = 10Hz for Average measurement

Sweep = auto

Detector function = peak

Trace = max hold

For Below 1GHz:

The EUT was placed on a turn table which is 0.8m above ground plane.

Maximum procedure was performed on the highest emissions to ensure EUT compliance.

Span = wide enough to fully capture the emission being measured

RBW = 100 kHz

VBW ≥ RBW

Sweep = auto

Detector function = peak

Trace = max hold

Follow the guidelines in ANSI C63.10-2013 with respect to maximizing the emission by rotating the EUT, measuring the emission while the EUT is situated in three orthogonal planes (if appropriate), adjusting the measurement antenna height and polarization, etc. A pre-amp and a high pass filter are required for this test, in order to provide the measuring system with sufficient sensitivity. Allow the trace to stabilize. The peak reading of the emission, after being corrected by the antenna factor, cable loss, pre-amp gain, etc., is the peak field strength, which must comply with the limit specified in Section 15.35(b). Submit this data.

Now set the VBW to 10 Hz, while maintaining all of the other instrument settings. This peak level, once corrected, must comply with the limit specified in Section 15.209. If the dwell time per channel of the hopping signal is less than 100 ms, then the reading obtained with the 10 Hz VBW may be further adjusted by a “duty cycle correction factor”, derived from $20\log(\text{dwell time}/100 \text{ ms})$, in an effort to demonstrate compliance with the 15.209 limit. Submit this data.

Repeat above procedures until all frequency measured was complete.

8.5.5 Test Results

All the modulation modes with all adapters were tested the data of the worst mode are recorded as below.

■ Spurious Emission below 30MHz (9KHz to 30MHz)

Temperature:	24 °C	Test Date:	November 15, 2015
Humidity:	53 %	Test By:	KING KONG
Test mode:	TX Mode		

Freq. (MHz)	Ant.Pol. H/V	Emission Level(dBuV/m)		Limit 3m(dBuV/m)		Over(dB)	
		PK	AV	PK	AV	PK	AV
--	--	--	--	--	--	--	--

Note: the amplitude of spurious emission that is attenuated by more than 20dB below the permissible limit has no need to be reported.

Distance extrapolation factor = $40\log(\text{Specific distance}/ \text{test distance})$ (dB);

Limit line = Specific limits(dBuV) + distance extrapolation factor

■ Spurious Emission below 1GHz (30MHz to 1GHz)
Bluetooth 4.0 DTS mode have been tested, and the worst result was report as below:

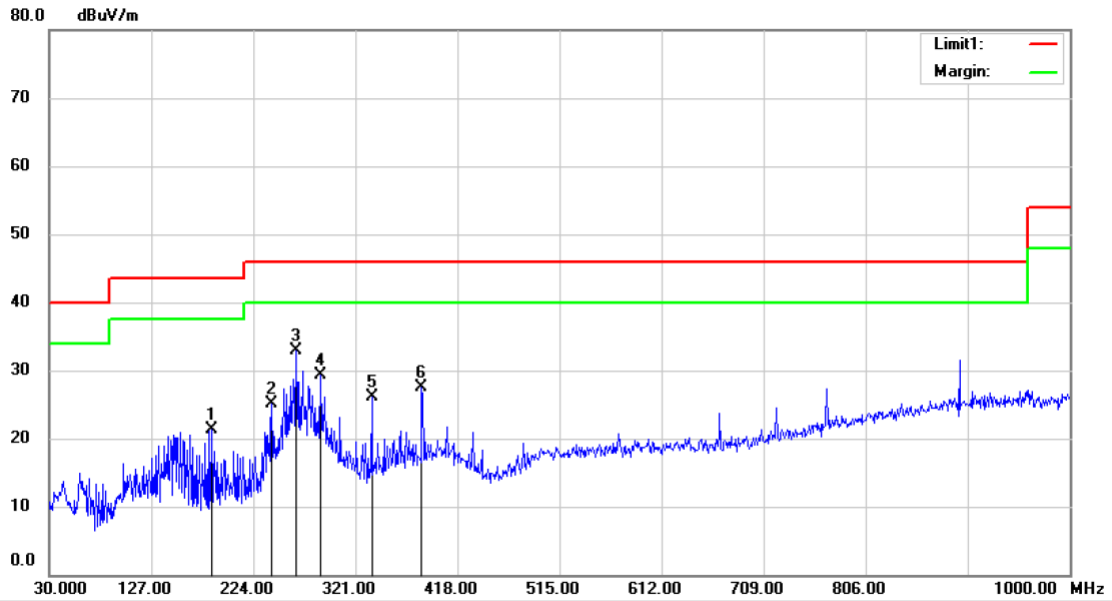

Site 3m Chamber #3 Polarization: *Horizontal* Temperature: 24 C
 Limit: (RE)FCC PART 15.247 Power: AC 120V/60Hz Humidity: 53 %
 Mode:GFSK TX Channel0
 Note:

No.	Mk.	Freq.	Reading Level	Correct Factor	Measure-ment	Limit	Over	Antenna Height	Table Degree	
		MHz	dBuV	dB	dBuV/m	dBuV/m	dB	cm	degree	Comment
1		184.2300	39.59	-18.25	21.34	43.50	-22.16	QP		
2		241.4600	38.89	-13.76	25.13	46.00	-20.87	QP		
3	*	264.7400	45.65	-12.74	32.91	46.00	-13.09	QP		
4		288.0200	42.45	-13.07	29.38	46.00	-16.62	QP		
5		336.5200	38.83	-12.65	26.18	46.00	-19.82	QP		
6		384.0500	37.19	-9.77	27.42	46.00	-18.58	QP		

*:Maximum data x:Over limit !:over margin

Operator:

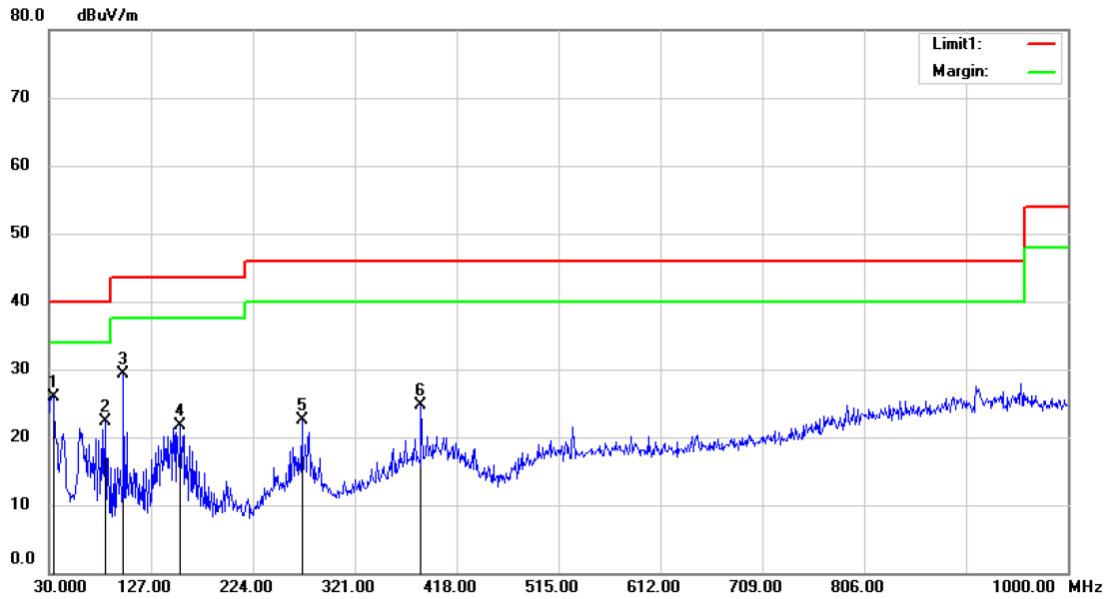

Site 3m Chamber #3 Polarization: *Vertical* Temperature: 24 C
 Limit: (RE)FCC PART 15.247 Power: AC 120V/60Hz Humidity: 53 %
 Mode:GFSK TX Channel0
 Note:

No.	Mk.	Freq.	Reading Level	Correct Factor	Measurement	Limit	Over	Antenna Height	Table Degree	
		MHz	dBuV	dB	dBuV/m	dBuV/m	dB	cm	degree	Comment
1	*	33.8800	41.04	-15.17	25.87	40.00	-14.13	QP		
2		83.3500	41.12	-18.80	22.32	40.00	-17.68	QP		
3		100.8100	43.23	-14.02	29.21	43.50	-14.29	QP		
4		155.1300	40.15	-18.42	21.73	43.50	-21.77	QP		
5		270.5600	35.26	-12.68	22.58	46.00	-23.42	QP		
6		384.0500	34.40	-9.77	24.63	46.00	-21.37	QP		

*:Maximum data x:Over limit !:over margin

Operator:

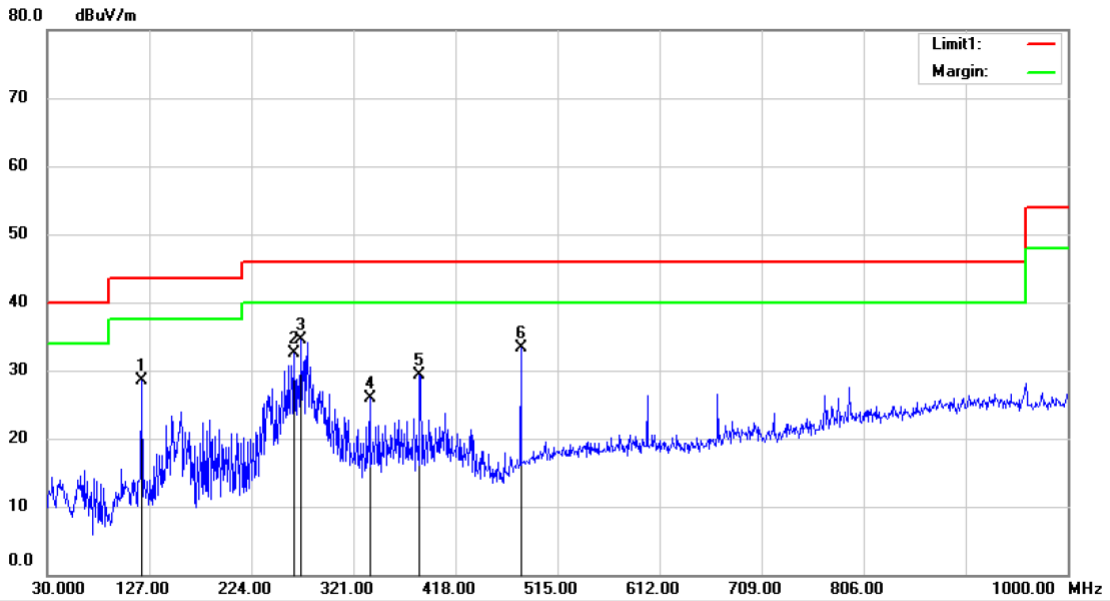

Site 3m Chamber #3 Polarization: *Horizontal* Temperature: 24 C
 Limit: (RE)FCC PART 15.247 Power: AC 120V/60Hz Humidity: 53 %
 Mode:GFSK TX Channel19
 Note:

No.	Mk.	Freq.	Reading Level	Correct Factor	Measure-ment	Limit	Over	Antenna Height	Table Degree	
		MHz	dBuV	dB	dBuV/m	dBuV/m	dB	cm	degree	Comment
1		120.2100	44.91	-16.36	28.55	43.50	-14.95	QP		
2		264.7400	45.33	-12.74	32.59	46.00	-13.41	QP		
3	*	271.5300	47.23	-12.67	34.56	46.00	-11.44	QP		
4		336.5200	38.47	-12.65	25.82	46.00	-20.18	QP		
5		384.0500	39.16	-9.77	29.39	46.00	-16.61	QP		
6		480.0800	42.76	-9.53	33.23	46.00	-12.77	QP		

*:Maximum data x:Over limit !:over margin

Operator:

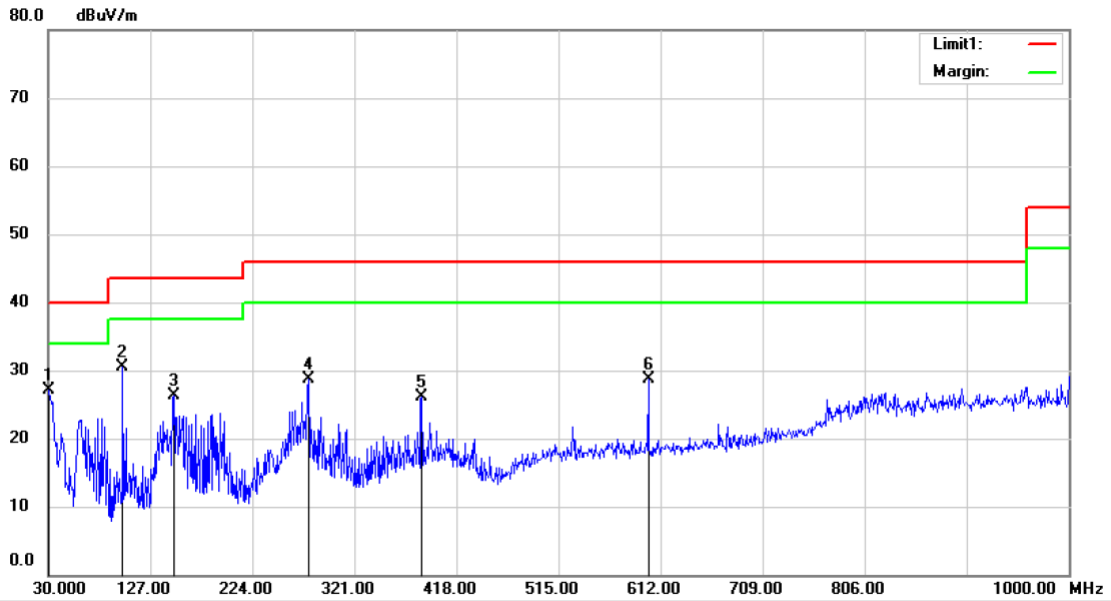

Site 3m Chamber #3
 Limit: (RE)FCC PART 15.247
 Mode:GFSK TX Channel19
 Note:

Polarization: *Vertical*
 Power: AC 120V/60Hz

Temperature: 24 C
 Humidity: 53 %

No.	Mk.	Freq. MHz	Reading Level dBuV	Correct Factor dB	Measure- ment dBuV/m	Limit dBuV/m	Over dB	Antenna Height cm	Table Degree	Detector	Comment
1	*	30.0000	43.62	-16.46	27.16	40.00	-12.84			QP	
2		100.8100	44.51	-14.02	30.49	43.50	-13.01			QP	
3		149.3100	44.33	-18.08	26.25	43.50	-17.25			QP	
4		277.3500	41.31	-12.60	28.71	46.00	-17.29			QP	
5		385.0200	35.76	-9.71	26.05	46.00	-19.95			QP	
6		600.3600	35.67	-6.99	28.68	46.00	-17.32			QP	

*:Maximum data x:Over limit !:over margin

Operator:

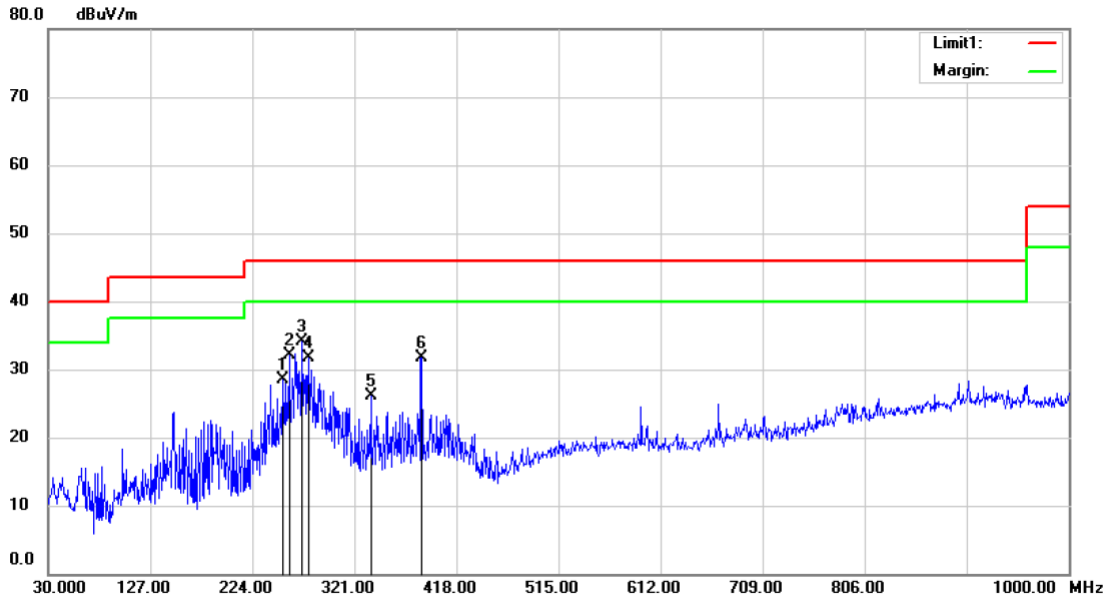

Site 3m Chamber #3 Polarization: *Horizontal* Temperature: 24 C
 Limit: (RE)FCC PART 15.247 Power: AC 120V/60Hz Humidity: 53 %
 Mode:GFSK TX Channel39
 Note:

No.	Mk.	Freq.	Reading Level	Correct Factor	Measurement	Limit	Over	Antenna Height	Table Degree	
		MHz	dBuV	dB	dBuV/m	dBuV/m	dB	cm	degree	Comment
1		253.1000	41.74	-13.16	28.58	46.00	-17.42	QP		
2		258.9200	45.03	-12.85	32.18	46.00	-13.82	QP		
3	*	271.5300	46.79	-12.67	34.12	46.00	-11.88	QP		
4		277.3500	44.37	-12.60	31.77	46.00	-14.23	QP		
5		336.5200	38.79	-12.65	26.14	46.00	-19.86	QP		
6		385.0200	41.43	-9.71	31.72	46.00	-14.28	QP		

*:Maximum data x:Over limit !:over margin

Operator:

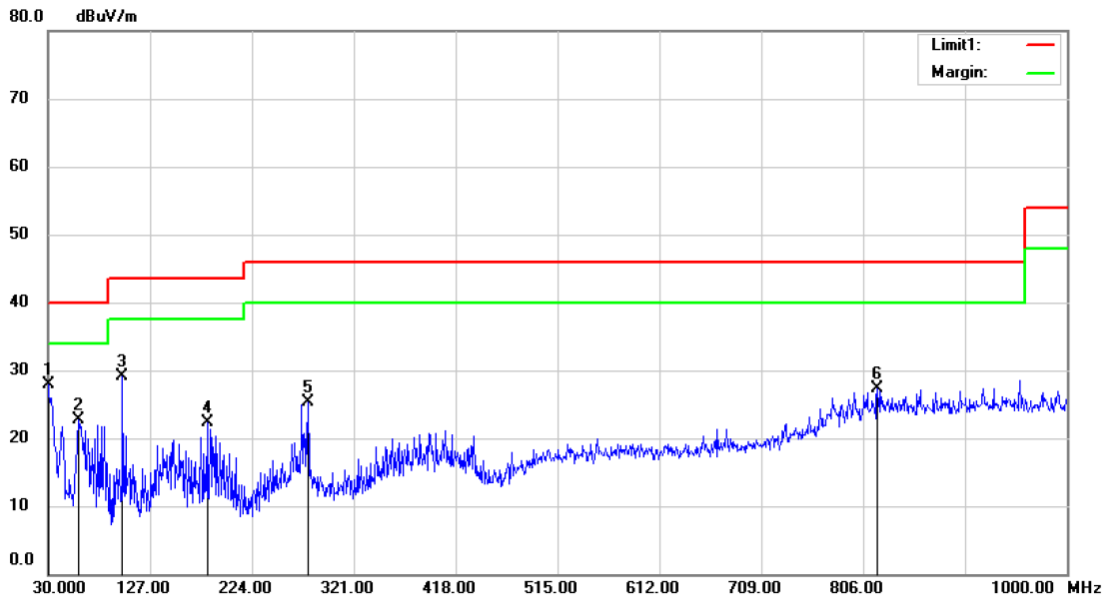

Site 3m Chamber #3 Polarization: *Vertical* Temperature: 24 C
 Limit: (RE)FCC PART 15.247 Power: AC 120V/60Hz Humidity: 53 %
 Mode:GFSK TX Channel39
 Note:

No.	Mk.	Freq.	Reading Level	Correct Factor	Measurement	Limit	Over	Antenna Height	Table Degree	
		MHz	dBuV	dB	dBuV/m	dBuV/m	dB	cm	degree	Comment
1	*	30.0000	44.29	-16.46	27.83	40.00	-12.17	QP		
2		59.1000	38.30	-15.55	22.75	40.00	-17.25	QP		
3		100.8100	43.13	-14.02	29.11	43.50	-14.39	QP		
4		181.3200	41.00	-18.75	22.25	43.50	-21.25	QP		
5		277.3500	37.86	-12.60	25.26	46.00	-20.74	QP		
6		819.5800	29.73	-2.44	27.29	46.00	-18.71	QP		

*:Maximum data x:Over limit !:over margin

Operator:

■ Spurious Emission Above 1GHz (1GHz to 25GHz)

Bluetooth 4.0 DTS mode have been tested, and the worst result was report as below:

Temperature: 24°C Test Date: November 15, 2015
 Humidity: 53 % Test By: KING KONG
 Test mode: Bluetooth 4.0 DTS Frequency: Channel 0: 2402MHz

Freq. (MHz)	Ant.Pol. H/V	Emission Level(dBuV/m)		Limit 3m(dBuV/m)		Over(dB)	
		PK	AV	PK	AV	PK	AV
14755	V	51.11	35.65	74	54	-22.89	-18.35
15860	V	51.86	35.86	74	54	-22.14	-18.14
17645	V	53.07	37.36	74	54	-20.93	-16.64
--	--	--	--	--	--	--	--
--	--	--	--	--	--	--	--
14602	H	51.61	35.94	74	54	-22.39	-18.06
15367	H	54.53	39.32	74	54	-19.47	-14.68
16353	H	53.39	37.6	74	54	-20.61	-16.4

Temperature: 24°C Test Date: November 15, 2015
 Humidity: 53 % Test By: KING KONG
 Test mode: Bluetooth 4.0 DTS Frequency: Channel 19: 2440MHz

Freq. (MHz)	Ant.Pol. H/V	Emission Level(dBuV/m)		Limit 3m(dBuV/m)		Over(dB)	
		PK	AV	PK	AV	PK	AV
14423	V	51.78	35.86	74	54	-22.22	-18.14
15120	V	53.11	37.36	74	54	-20.89	-16.64
16412	V	53.86	38.92	74	54	-20.14	-15.08
--	--	--	--	--	--	--	--
--	--	--	--	--	--	--	--
13981	H	51.71	36.24	74	54	-22.29	-17.76
15392	H	51.89	36.93	74	54	-22.11	-17.07
17347	H	52.43	37.2	74	54	-21.57	-16.8

Temperature: 24°C Test Date: November 15, 2015
 Humidity: 53 % Test By: KING KONG
 Test mode: Bluetooth 4.0 DTS Frequency: Channel 39: 2480MHz

Freq. (MHz)	Ant.Pol. H/V	Emission Level(dBuV/m)		Limit 3m(dBuV/m)		Over(dB)	
		PK	AV	PK	AV	PK	AV
15511	V	52.5	39.03	74	54	-21.5	-14.97
16089	V	53.38	37.54	74	54	-20.62	-16.46
16565	V	52.64	37.67	74	54	-21.36	-16.33
--	--	--	--	--	--	--	--
--	--	--	--	--	--	--	--
14814	H	50.86	35.69	74	54	-23.14	-18.31
15528	H	52.6	36.34	74	54	-21.4	-17.66
15970	H	53.88	38.24	74	54	-20.12	-15.76

- Note: (1) All Readings are Peak Value (VBW=3MHz) and Peak Value (VBW=10Hz).
 (2) Emission Level= Reading Level+Probe Factor +Cable Loss.
 (3) Data of measurement within this frequency range shown "--" in the table above means the reading of emissions are attenuated more than 20dB below the permissible limits or the field strength is too small to be measured.

■ Spurious Emission in Restricted Band 2310-2390MHz and 2483.5-2500MHz

All the modulation modes were tested, the data of the worst mode are described in the following table

Temperature: 24°C Test Date: November 15, 2015
 Humidity: 53 % Test By: KK
 Test mode: GFSK Frequency: Channel 0: 2402MHz

Frequency (MHz)	Polarity H/V	PK(dBuV/m) (VBW=3MHz)	Limit 3m (dBuV/m)	AV(dBuV/m) (VBW=3MHz)	Limit 3m (dBuV/m)
2384.87	H	40.69	74	25.36	54
2385.75	V	41.87	74	25.57	54

Temperature: 24°C Test Date: November 15, 2015
 Humidity: 53 % Test By: KK
 Test mode: GFSK Frequency: Channel 78: 2480MHz

Frequency (MHz)	Polarity H/V	PK(dBuV/m) (VBW=3MHz)	Limit 3m (dBuV/m)	AV(dBuV/m) (VBW=3MHz)	Limit 3m (dBuV/m)
2484.24	H	40.70	74	24.80	54
2484.17	V	41.47	74	25.50	54

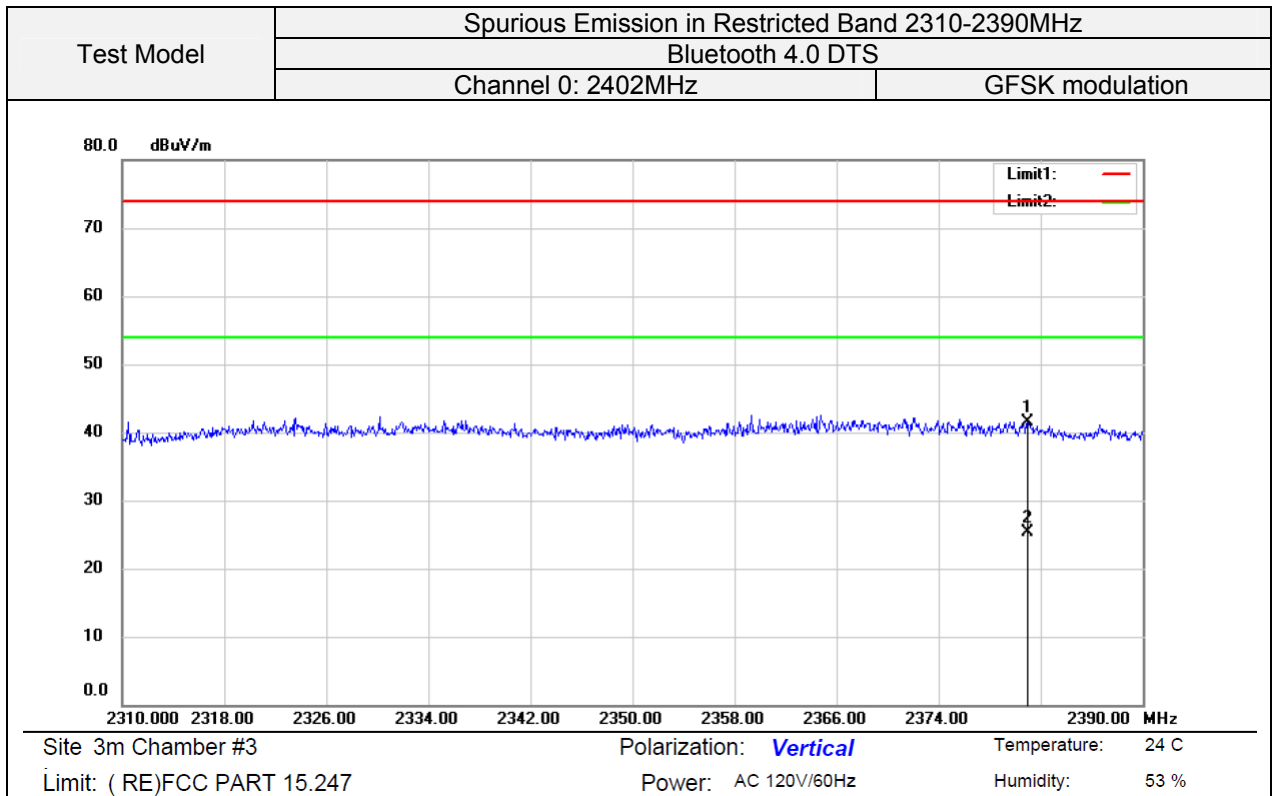
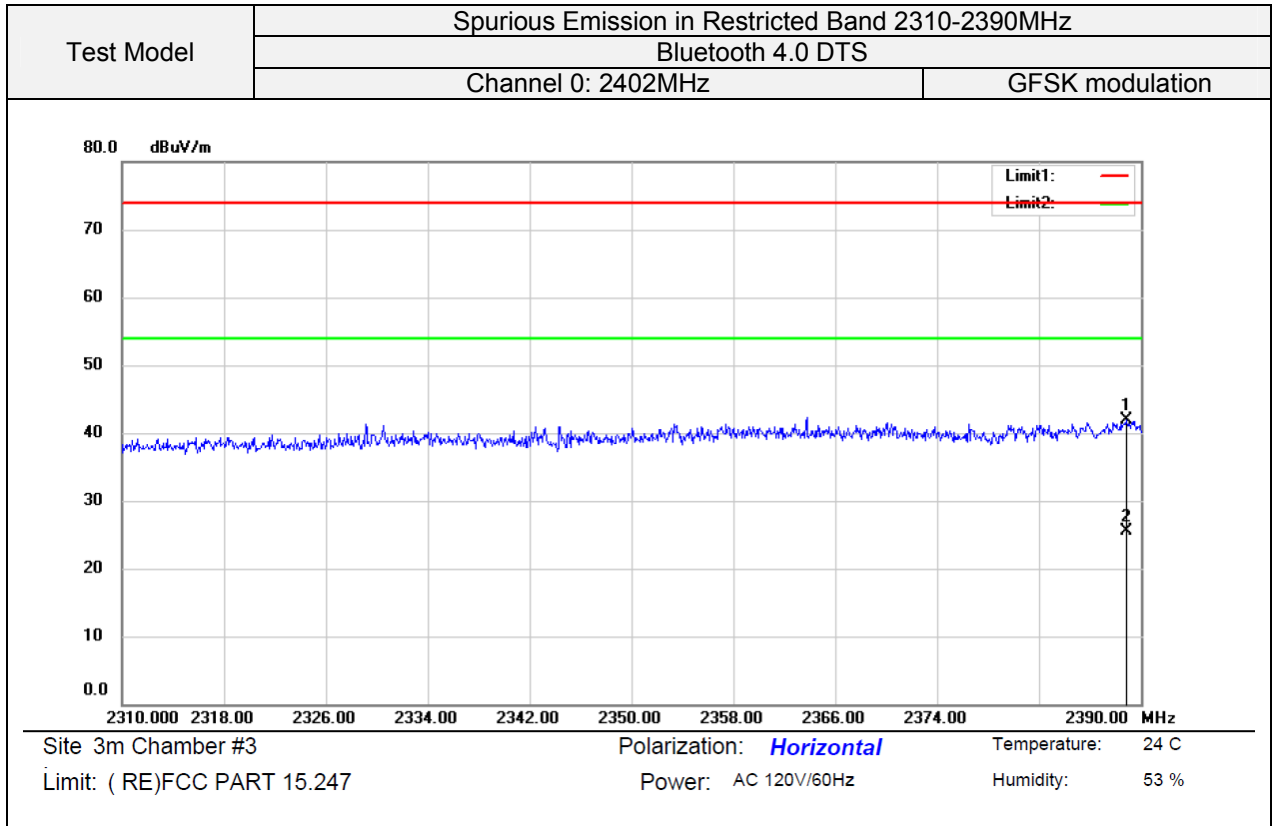

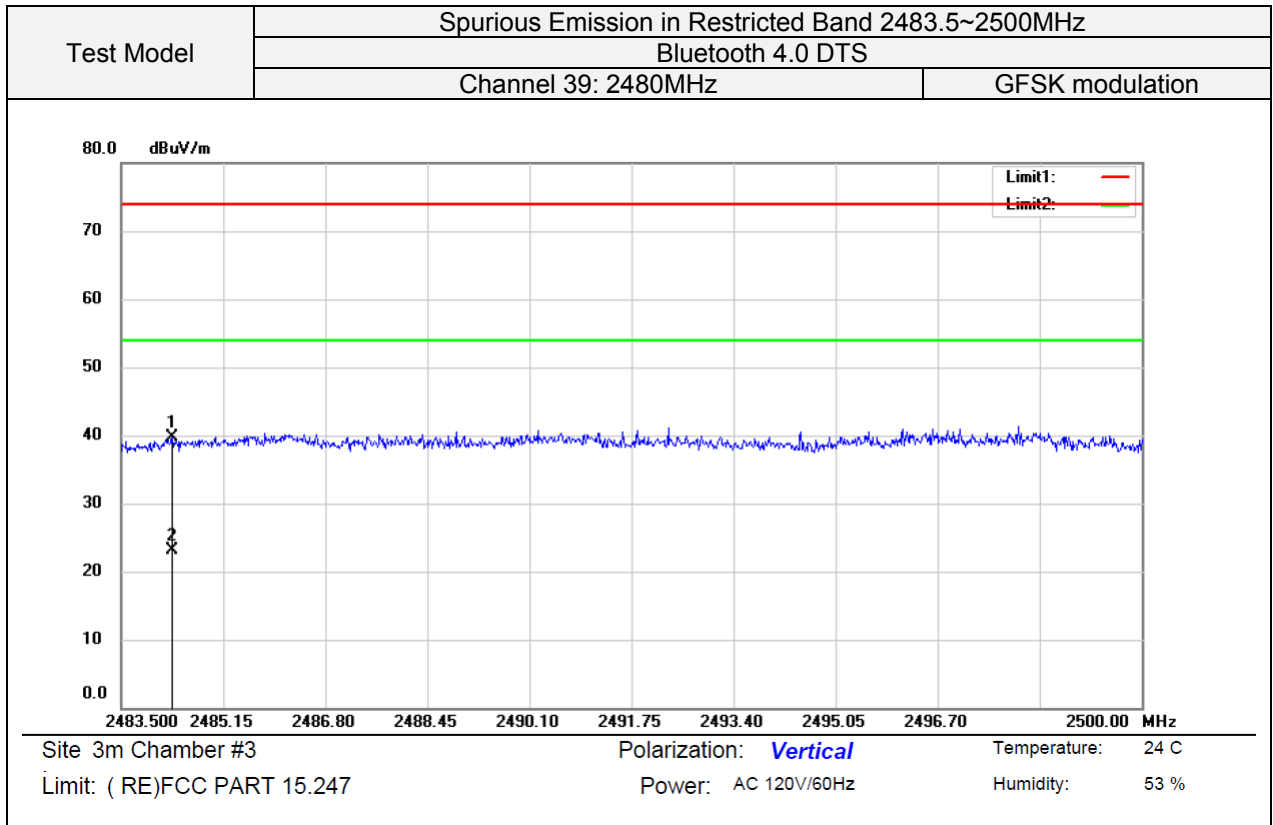
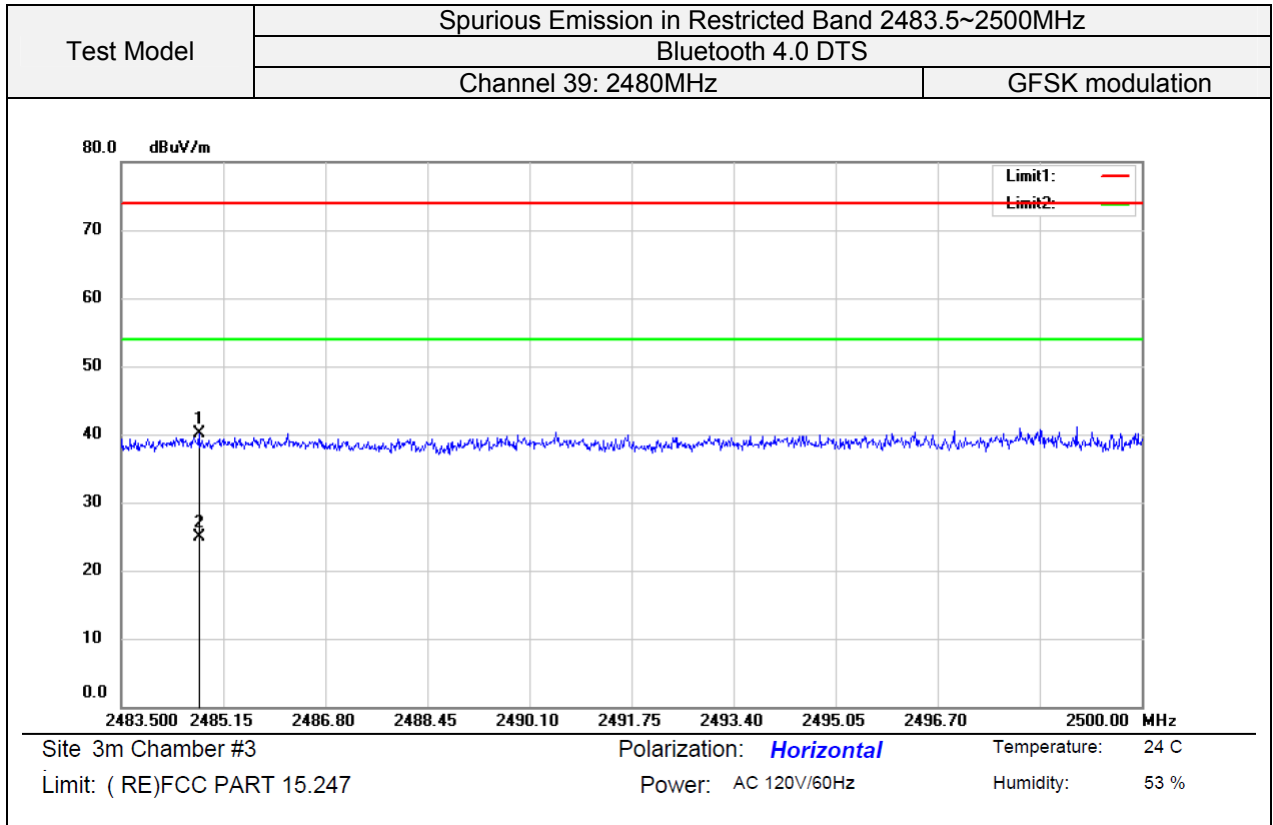

8.6 CONDUCTED EMISSIONS TEST

8.6.1 Applicable Standard

According to FCC Part 15.207(a)

8.6.2 Conformance Limit

Conducted Emission Limit		
Frequency(MHz)	Quasi-peak	Average
0.15-0.5	66-56	56-46
0.5-5.0	56	46
5.0-30.0	60	50

Note: 1. The lower limit shall apply at the transition frequencies
 2. The limit decreases in line with the logarithm of the frequency in the range of 0.15 to 0.50MHz.

8.6.3 Test Configuration

Test according to clause 7.3 conducted emission test setup

8.6.4 Test Procedure

The EUT was placed on a table which is 0.8m above ground plane.
 Maximum procedure was performed on the highest emissions to ensure EUT compliance.
 Repeat above procedures until all frequency measured were complete.

8.6.5 Test Results

PASS.

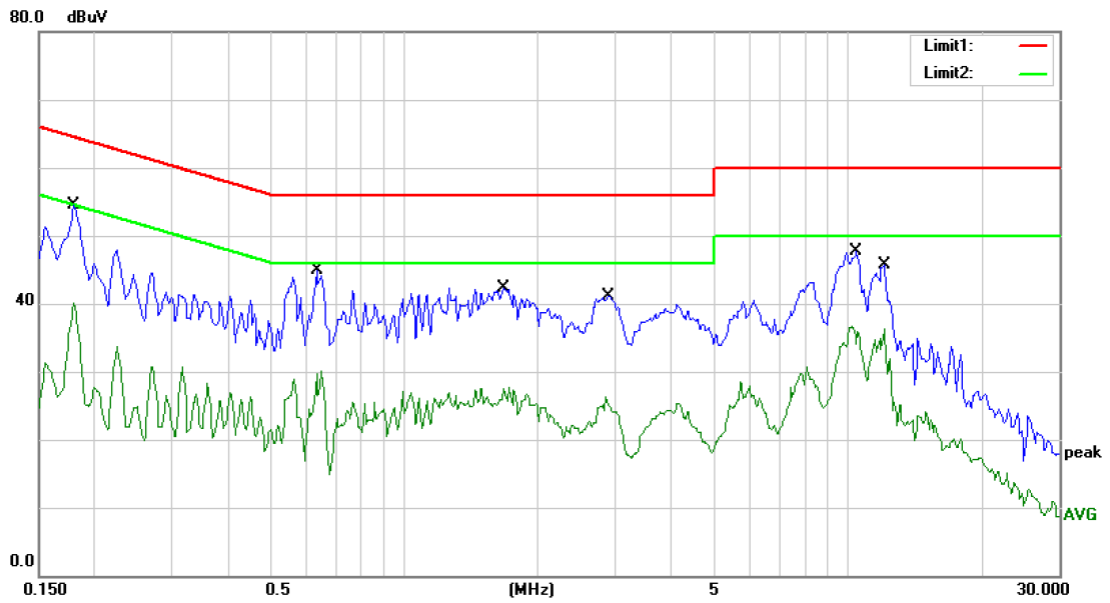

Site Conduction #1 Phase: **L1** Temperature: 22
 Limit: (CE)FCC PART 15 class B_QP Power: AC 120V/60Hz Humidity: 50 %
 Mode: ON
 Note:

No.	Mk.	Freq.	Reading Level	Correct Factor	Measurement	Limit	Over	Detector	Comment
		MHz	dBuV	dB	dBuV	dBuV	dB		
1	*	0.1800	54.53	0.00	54.53	64.49	-9.96	QP	
2		0.1800	40.03	0.00	40.03	54.49	-14.46	AVG	
3		0.6350	44.94	0.00	44.94	56.00	-11.06	QP	
4		0.6350	30.20	0.00	30.20	46.00	-15.80	AVG	
5		1.6750	42.26	0.00	42.26	56.00	-13.74	QP	
6		1.6750	27.77	0.00	27.77	46.00	-18.23	AVG	
7		2.8950	41.19	0.00	41.19	56.00	-14.81	QP	
8		2.8950	26.30	0.00	26.30	46.00	-19.70	AVG	
9		10.5000	47.62	0.00	47.62	60.00	-12.38	QP	
10		10.5000	36.61	0.00	36.61	50.00	-13.39	AVG	
11		12.1000	45.67	0.00	45.67	60.00	-14.33	QP	
12		12.1000	36.22	0.00	36.22	50.00	-13.78	AVG	

*:Maximum data x:Over limit !:over margin Comment: Factor build in receiver. Operator: KK

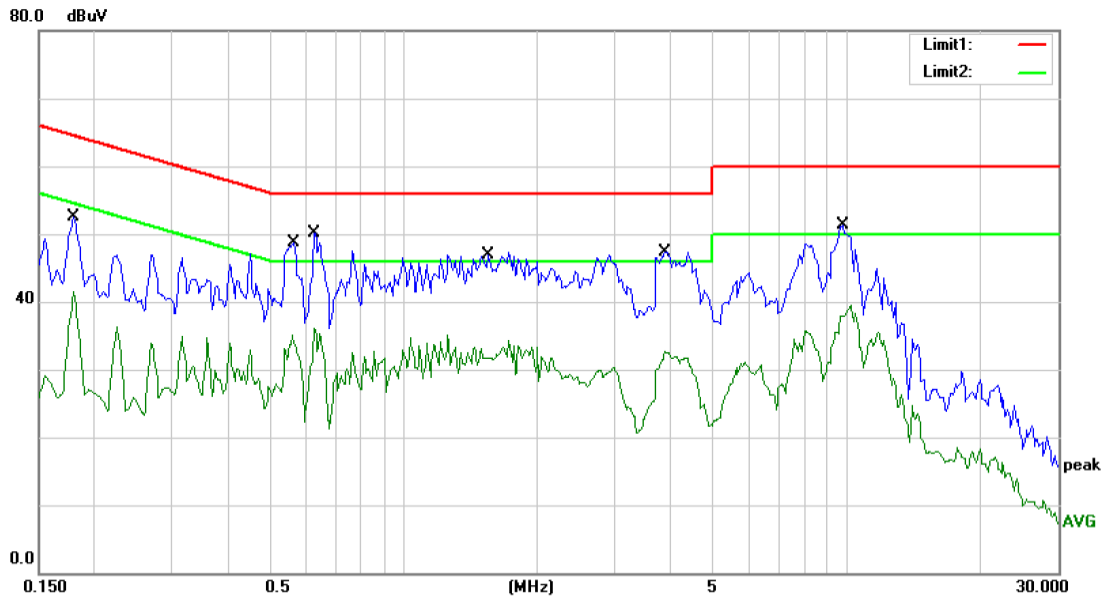

Site Conduction #1 Phase: **N** Temperature: 22
 Limit: (CE)FCC PART 15 class B_QP Power: AC 120V/60Hz Humidity: 50 %
 Mode: ON
 Note:

No. Mk.	Freq.	Reading Level	Correct Factor	Measurement	Limit	Over	Detector	Comment
	MHz	dBuV	dB	dBuV	dBuV	dB		
1	0.1800	52.52	0.00	52.52	64.49	-11.97	QP	
2	0.1800	41.48	0.00	41.48	54.49	-13.01	AVG	
3	0.5650	48.67	0.00	48.67	56.00	-7.33	QP	
4	0.5650	35.01	0.00	35.01	46.00	-10.99	AVG	
5 *	0.6300	50.19	0.00	50.19	56.00	-5.81	QP	
6	0.6300	36.14	0.00	36.14	46.00	-9.86	AVG	
7	1.5500	46.83	0.00	46.83	56.00	-9.17	QP	
8	1.5500	34.23	0.00	34.23	46.00	-11.77	AVG	
9	3.9000	47.35	0.00	47.35	56.00	-8.65	QP	
10	3.9000	32.60	0.00	32.60	46.00	-13.40	AVG	
11	9.7900	51.34	0.00	51.34	60.00	-8.66	QP	
12	9.7900	39.54	0.00	39.54	50.00	-10.46	AVG	

*:Maximum data x:Over limit !:over margin Comment: Factor build in receiver. Operator: KK

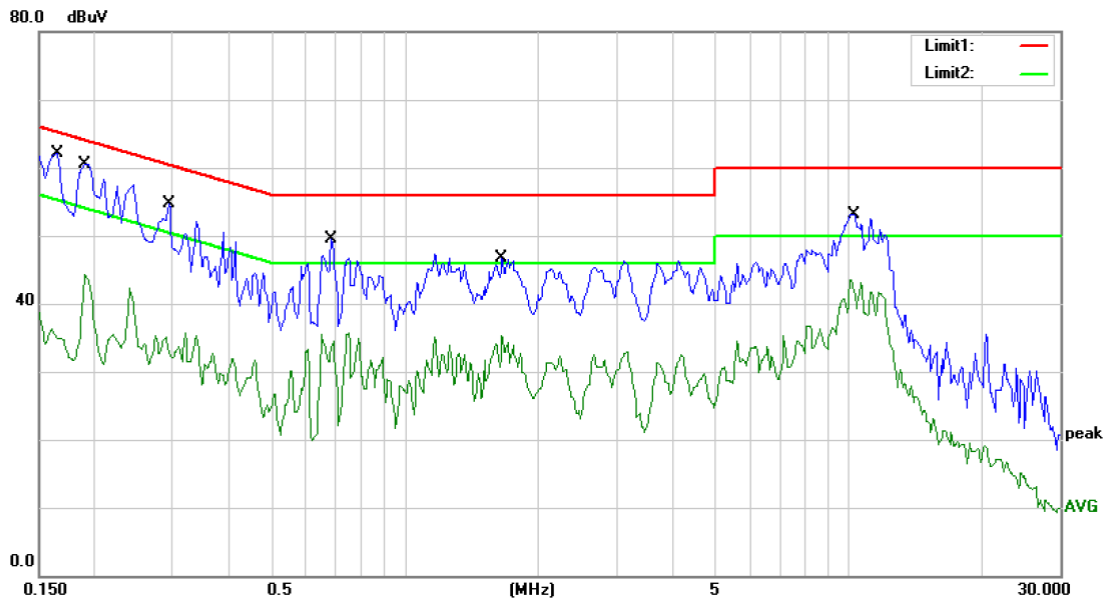

Site Conduction #1 Phase: **L1** Temperature: 22
 Limit: (CE)FCC PART 15 class B_QP Power: AC 240V/50Hz Humidity: 50 %
 Mode: ON
 Note:

No.	Mk.	Freq.	Reading Level	Correct Factor	Measurement	Limit	Over	Detector	Comment
		MHz	dBuV	dB	dBuV	dBuV	dB		
1	*	0.1650	62.19	0.00	62.19	65.21	-3.02	QP	
2		0.1650	38.78	0.00	38.78	55.21	-16.43	AVG	
3		0.1900	60.48	0.00	60.48	64.04	-3.56	QP	
4		0.1900	44.38	0.00	44.38	54.04	-9.66	AVG	
5		0.2950	54.76	0.00	54.76	60.38	-5.62	QP	
6		0.2950	35.69	0.00	35.69	50.38	-14.69	AVG	
7		0.6850	49.44	0.00	49.44	56.00	-6.56	QP	
8		0.6850	35.64	0.00	35.64	46.00	-10.36	AVG	
9		1.6600	46.70	0.00	46.70	56.00	-9.30	QP	
10		1.6600	35.35	0.00	35.35	46.00	-10.65	AVG	
11		10.3250	53.18	0.00	53.18	60.00	-6.82	QP	
12		10.3250	43.53	0.00	43.53	50.00	-6.47	AVG	

*:Maximum data x:Over limit !:over margin Comment: Factor build in receiver. Operator: KK

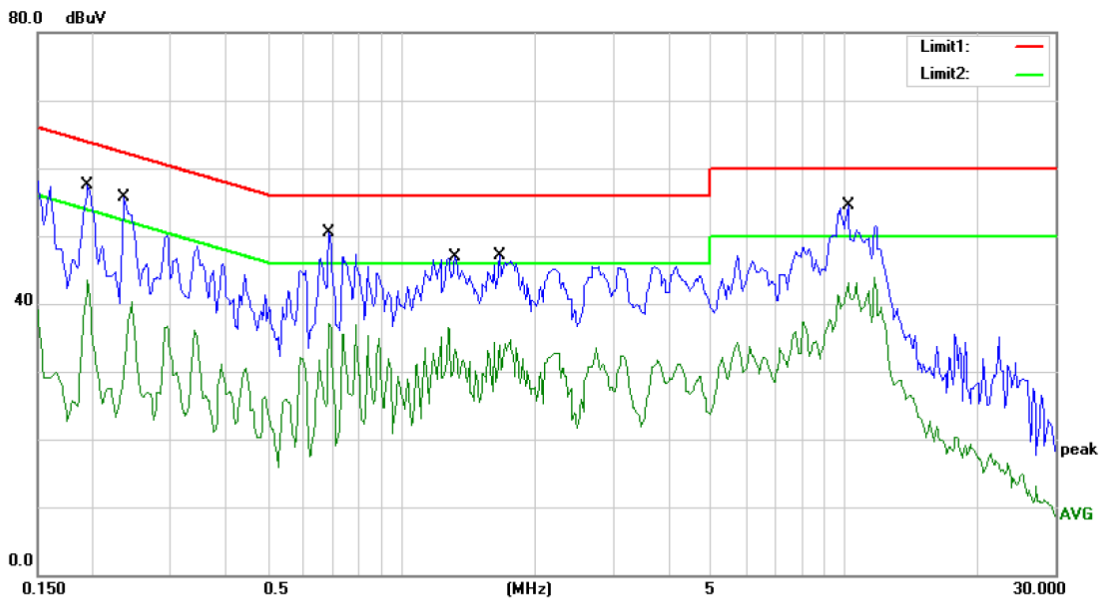

Site Conduction #1 Phase: **N** Temperature: 22
 Limit: (CE)FCC PART 15 class B_QP Power: AC 240V/50Hz Humidity: 50 %
 Mode: ON
 Note:

No. Mk.	Freq. MHz	Reading Level dBuV	Correct Factor dB	Measurement dBuV	Limit dBuV	Over dB	Detector	Comment
1	0.1950	57.50	0.00	57.50	63.82	-6.32	QP	
2	0.1950	43.53	0.00	43.53	53.82	-10.29	AVG	
3	0.2350	55.70	0.00	55.70	62.27	-6.57	QP	
4	0.2350	40.29	0.00	40.29	52.27	-11.98	AVG	
5	0.6850	50.43	0.00	50.43	56.00	-5.57	QP	
6	0.6850	37.06	0.00	37.06	46.00	-8.94	AVG	
7	1.3200	46.85	0.00	46.85	56.00	-9.15	QP	
8	1.3200	36.59	0.00	36.59	46.00	-9.41	AVG	
9	1.6650	47.04	0.00	47.04	56.00	-8.96	QP	
10	1.6650	34.63	0.00	34.63	46.00	-11.37	AVG	
11 *	10.2000	54.44	0.00	54.44	60.00	-5.56	QP	
12	10.2000	43.88	0.00	43.88	50.00	-6.12	AVG	

*:Maximum data x:Over limit !:over margin Comment: Factor build in receiver. Operator: KK

8.7 ANTENNA APPLICATION

8.7.1 Antenna Requirement

Standard	Requirement
FCC CRF Part 15.203	An intentional radiator shall be designed to ensure that no antenna other than that furnished by the responsible party shall be used with the device. The use of a permanently attached antenna or of an antenna that uses a unique coupling to the intentional radiator shall be considered sufficient to comply with the provisions of this section. The manufacturer may design the unit so that a broken antenna can be replaced by the user, but the use of a standard antenna jack or electrical connector is prohibited. This requirement does not apply to carrier current devices or to devices operated under the provisions of §15.211, §15.213, §15.217, §15.219, or §15.221. Further, this requirement does not apply to intentional radiators that must be professionally installed, such as perimeter protection systems and some field disturbance sensors, or to other intentional radiators which, in accordance with §15.31(d), must be measured at the installation site. However, the installer shall be responsible for ensuring that the proper antenna is employed so that the limits in this part are not exceeded.

For intentional device, according to FCC 47 CFR Section 15.203, an intentional radiator shall be designed to ensure that no antenna other than that furnished by the responsible party shall be used with the device. And according to FCC 47 CFR Section 15.247 (b), if transmitting antennas of directional gain greater than 6dBi are used, the power shall be reduced by the amount in dB that the directional gain of the antenna exceeds 6dBi.

8.7.2 Result

The EUT'S antenna is Multilayer Chip Antenna, and the antenna can't be replaced by the user, which in accordance to section 15.203, please refer to the internal photos. The antenna's gain is 0.5dBi and meets the requirement.

END OF REPORT