SAR Test Report

Report No.: AGC09674170301FH01

FCC ID : 2AAE9CAPHG43
APPLICATION PURPOSE : Original Equipment
PRODUCT DESIGNATION : Smartphone-Miracle 6.0 S
BRAND NAME : CellAllure
MODEL NAME : Miracle 6.0 S, CAPHG43
CLIENT : GNJ Manufacturing Inc.
DATE OF ISSUE : Mar. 29,2017
STANDARD(S) : IEEE Std. 1528:2013
FCC 47CFR § 2.1093
IEEE/ANSI C95.1:2005
REPORT VERSION : V1.0

Attestation of Global Compliance(Shenzhen) Co., Ltd.



CAUTION:

This report shall not be reproduced except in full without the written permission of the test laboratory and shall not be quoted out of context.



Report Revise Record

Report Version	Revise Time	Issued Date	Valid Version	Notes
V1.0	/	Mar. 29,2017	Valid	Original Report

Test Report Certification

Applicant Name	GNJ Manufacturing Inc.
Applicant Address	5811 West Hallandale Beach Blvd. West Park , FL 33023
Manufacturer Name	GNJ Manufacturing Inc.
Manufacturer Address	4/F, Blk A, No.48 Industrial Park, ZhongKai HiTech Zone, Huizhou City, GuangDong Province
Product Designation	Smartphone-Miracle 6.0 S
Brand Name	CellAllure
Model Name	Miracle 6.0 S, CAPHG43
Different Description	All the models are the same, only different in model names.The test model is Miracle 6.0S.
EUT Voltage	DC3.7V by battery
Applicable Standard	IEEE Std. 1528:2013 FCC 47CFR § 2.1093 IEEE/ANSI C95.1:2005
Test Date	Mar. 21,2017 to Mar. 24,2017
Performed Location	Attestation of Global Compliance(Shenzhen) Co., Ltd. 2 F, Building 2, No.1-No.4, Chaxi Sanwei Technical Industrial Park, Gushu, Xixiang Street, Bao'an District, Shenzhen, China
Report Template	AGCRT-US-3G3/SAR (2016-01-01)



Tested By _____

Eric Zhou(Zhou Yongkang) Mar. 24,2017



Checked By _____

Angela Li(Li Jiao) Mar. 29,2017



Authorized By _____

Solger Zhang(Zhang Hongyi)
Authorized Officer Mar. 29,2017

TABLE OF CONTENTS

1. SUMMARY OF MAXIMUM SAR VALUE	5
2. GENERAL INFORMATION.....	6
2.1. EUT DESCRIPTION.....	6
3. SAR MEASUREMENT SYSTEM.....	8
3.1. THE SATIMO SYSTEM USED FOR PERFORMING COMPLIANCE TESTS CONSISTS OF FOLLOWING ITEMS	8
3.2. COMOSAR E-FIELD PROBE	9
3.3. ROBOT.....	9
3.4. VIDEO POSITIONING SYSTEM	10
3.5. DEVICE HOLDER	10
3.6. SAM TWIN PHANTOM.....	11
4. SAR MEASUREMENT PROCEDURE.....	12
4.1. SPECIFIC ABSORPTION RATE (SAR).....	12
4.2. SAR MEASUREMENT PROCEDURE	13
4.3. RF EXPOSURE CONDITIONS	15
5. TISSUE SIMULATING LIQUID.....	17
5.1. THE COMPOSITION OF THE TISSUE SIMULATING LIQUID.....	17
5.2. TISSUE DIELECTRIC PARAMETERS FOR HEAD AND BODY PHANTOMS	17
5.3. TISSUE CALIBRATION RESULT	18
6. SAR SYSTEM CHECK PROCEDURE	20
6.1. SAR SYSTEM CHECK PROCEDURES	20
6.2. SAR SYSTEM CHECK.....	21
7. EUT TEST POSITION.....	22
7.1. DEFINE TWO IMAGINARY LINES ON THE HANDSET.....	22
7.2. CHEEK POSITION	23
7.3. TILT POSITION.....	23
7.4. BODY WORN POSITION	24
8. SAR EXPOSURE LIMITS	25
9. TEST EQUIPMENT LIST	26
10. MEASUREMENT UNCERTAINTY	27
11. CONDUCTED POWER MEASUREMENT.....	30
12. TEST RESULTS	38
12.1. SAR TEST RESULTS SUMMARY.....	38
APPENDIX A. SAR SYSTEM CHECK DATA	50
APPENDIX B. SAR MEASUREMENT DATA.....	62
APPENDIX C. TEST SETUP PHOTOGRAPHS.....	102
APPENDIX D. CALIBRATION DATA	108

1. SUMMARY OF MAXIMUM SAR VALUE

The maximum results of Specific Absorption Rate (SAR) found during testing for EUT are as follows:

Frequency Band	Highest Reported 1g-SAR(W/Kg)		SAR Test Limit (W/Kg)
	Head	Body-worn	
GSM 850	0.127	0.738	1.6
PCS 1900	0.074	0.833	
UMTS Band II	0.057	0.769	
UMTS Band V	0.074	1.225	
WIFI 2.4G	0.083	0.260	
Simultaneous Reported SAR	1.485		
SAR Test Result	PASS		

This device is compliance with Specific Absorption Rate (SAR) for general population/uncontrolled exposure limits (1.6W/Kg) specified in IEEE Std. 1528:2013; FCC 47CFR § 2.1093; IEEE/ANSI C95.1:2005 and the following specific FCC Test Procedures:

- KDB 447498 D01 General RF Exposure Guidance v06
- KDB 648474 D04 Handset SAR v01r03
- KDB 865664 D01 SAR Measurement 100MHz to 6GHz v01r04
- KDB 941225 D01 3G SAR Procedures v03r01
- KDB 941225 D06 Hotspot Mode v02r01
- KDB 248227 D01 802 11 Wi-Fi SAR v02r02

2. GENERAL INFORMATION

2.1. EUT Description

General Information	
Product Designation	Smartphone-Miracle 6.0 S
Test Model	Miracle 6.0 S
Hardware Version	T828-W-V1.3
Software Version	T828W_V1_B_LJ_A9P_CELLALLUER60_v2-1_2017_03_23
Device Category	Portable
RF Exposure Environment	Uncontrolled
Antenna Type	Internal
GSM and GPRS	
Support Band	<input checked="" type="checkbox"/> GSM 850 <input checked="" type="checkbox"/> PCS 1900 <input checked="" type="checkbox"/> GSM 900 <input checked="" type="checkbox"/> DCS 1800
GPRS Type	Class B
GPRS Class	Class 12(1Tx+4Rx, 2Tx+3Rx, 3Tx+2Rx, 4Tx+1Rx)
TX Frequency Range	GSM 850 : 820-850MHz;; PCS 1900: 1850-1910MHz;
RX Frequency Range	GSM 850 : 869~894MHz; PCS 1900: 1930~1990MHz
Release Version	R99
Type of modulation	GMSK for GSM/GPRS;
Antenna Gain	1.31dBi
Max. Average Power	GSM850: 32.12dBm ;PCS1900: 28.93dBm
WCDMA	
Support Band	<input checked="" type="checkbox"/> UMTS FDD Band II <input checked="" type="checkbox"/> UMTS FDD Band V <input type="checkbox"/> UMTS FDD Band I <input type="checkbox"/> UMTS FDD Band VIII
HS Type	HSPA(HSUPA/HSDPA)
TX Frequency Range	WCDMA FDD Band II: 1850-1910MHz;WCDMA FDD Band V: 820-850MHz
RX Frequency Range	WCDMA FDD Band II: 1930-1990MHz;WCDMA FDD Band V: 869-894MHz
Release Version	Rel-6
Type of modulation	HSDPA:QPSK/16QAM; HSUPA:BPSK; WCDMA:QPSK
Antenna Gain	1.31dBi
Max. Average Power	Band II: 21.50dBm; Band V: 21.06 dBm

EUT Description(Continue)

Bluetooth	
Bluetooth Version	<input type="checkbox"/> V2.0 <input type="checkbox"/> V2.1 <input type="checkbox"/> V2.1+EDR <input checked="" type="checkbox"/> V3.0 <input type="checkbox"/> V3.0+HS <input checked="" type="checkbox"/> V4.0 <input type="checkbox"/> V4.1
Operation Frequency	2402~2480MHz
Type of modulation	<input checked="" type="checkbox"/> GFSK <input checked="" type="checkbox"/> II/4-DQPSK <input checked="" type="checkbox"/> 8-DPSK
Peak Power	5.875dBm
Antenna Gain	2.13dBi
WIFI	
WIFI Specification	<input type="checkbox"/> 802.11a <input checked="" type="checkbox"/> 802.11b <input checked="" type="checkbox"/> 802.11g <input checked="" type="checkbox"/> 802.11n(20) <input checked="" type="checkbox"/> 802.11n(40)
Operation Frequency	2412~2462MHz
Avg. Burst Power	11b:16.04dBm,11g:14.08dBm,11n(20):13.70dBm,11n(40):14.46dBm
Antenna Gain	2.13dBi
Accessories	
Battery	Brand name: CellAllure Model No. : CASPR43-06 Voltage and Capacitance: 3.7 V & 2500mAh
Adapter	Brand name: CellAllure Model No. : IFoo T55 Input: AC 100-240V, 50/60Hz, 0.15A Output: DC 5V, 1A
Earphone	Brand name: N/A Model No. : N/A

Note:1.CMU200 can measure the average power and Peak power at the same time
2.The sample used for testing is end product.

Product	Type
	<input checked="" type="checkbox"/> Production unit <input type="checkbox"/> Identical Prototype

3. SAR MEASUREMENT SYSTEM

3.1. The SATIMO system used for performing compliance tests consists of following items

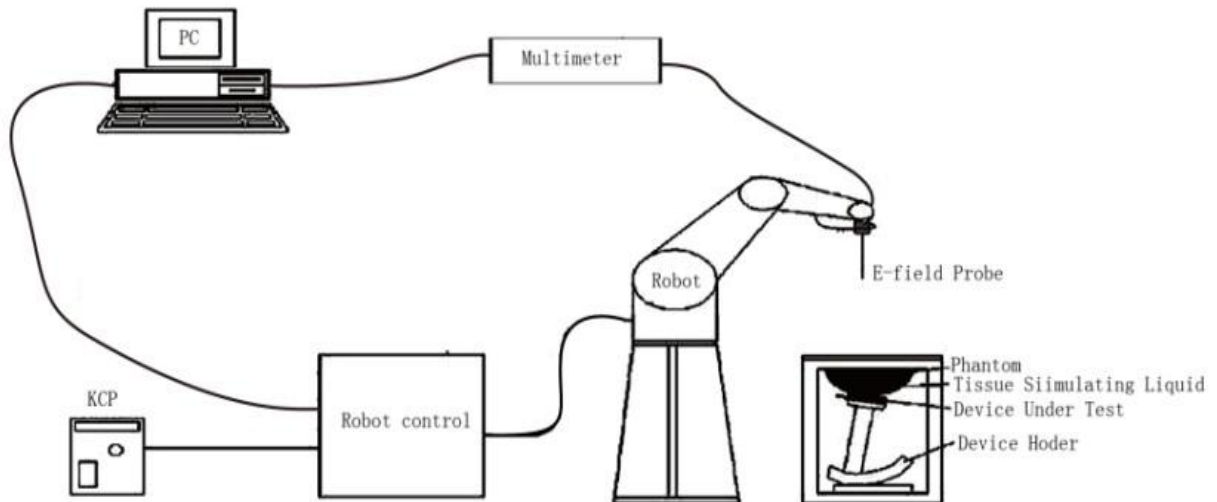

The COMOSAR system for performing compliance tests consists of the following items:

- The PC. It controls most of the bench devices and stores measurement data. A computer running WinXP and the Opensar software.
- The E-Field probe. The probe is a 3-axis system made of 3 distinct dipoles. Each dipole returns a voltage in function of the ambient electric field.
- The Keithley multimeter measures each probe dipole voltages.
- The SAM phantom simulates a human head. The measurement of the electric field is made inside the phantom.
- The liquids simulate the dielectric properties of the human head tissues.
- The network emulator controls the mobile phone under test.
- The validation dipoles are used to measure a reference SAR. They are used to periodically check the bench to make sure that there is no drift of the system characteristics over time.
- The phantom, the device holder and other accessories according to the targeted measurement.

3.2. COMOSAR E-Field Probe

The SAR measurement is conducted with the dosimetric probe manufactured by SATIMO. The probe is specially designed and calibrated for use in liquid with high permittivity. The dosimetric probe has special calibration in liquid at different frequency. SATIMO conducts the probe calibration in compliance with international and national standards (e.g. IEEE 1528 and relevant KDB files.) The calibration data are in Appendix D.

Isotropic E-Field Probe Specification

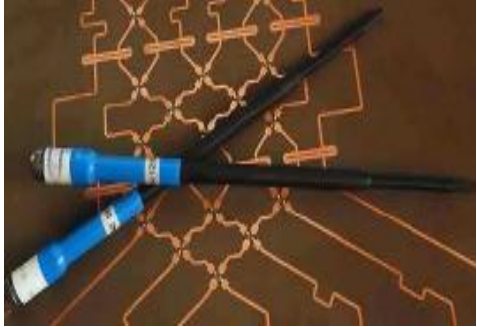
Model	SSE5	
Manufacture	MVG	
Identification No.	SN 14/16 EP308	
Frequency	0.3GHz-3.7GHz Linearity:±0.08dB(300MHz -3.7GHz)	
Dynamic Range	0.01W/Kg-100W/Kg Linearity:±0.08dB	
Dimensions	Overall length:330mm Length of individual dipoles:4.5mm Maximum external diameter:8mm Probe Tip external diameter:5mm Distance between dipoles/ probe extremity:2.7mm	
Application	High precision dosimetric measurements in any exposure scenario (e.g., very strong gradient fields). Only probe which enables compliance testing for frequencies up to 3 GHz with precision of better 30%.	

3.3. Robot

The COMOSAR system uses the KUKA robot from SATIMO SA (France).For the 6-axis controller COMOSAR system, the KUKA robot controller version from SATIMO is used.

The XL robot series have many features that are important for our application:

- High precision (repeatability 0.02 mm)
- High reliability (industrial design)
- Jerk-free straight movements
- Low ELF interference (the closed metallic construction shields against motor control fields)
- 6-axis controller



3.4. Video Positioning System

The video positioning system is used in OpenSAR to check the probe. Which is composed of a camera, LED, mirror and mechanical parts. The camera is piloted by the main computer with firewire link. During the process, the actual position of the probe tip with respect to the robot arm is measured, as well as the probe length and the horizontal probe offset. The software then corrects all movements, such that the robot coordinates are valid for the probe tip. The repeatability of this process is better than 0.1 mm. If a position has been taught with an aligned probe, the same position will be reached with another aligned probe within 0.1 mm, even if the other probe has different dimensions. During probe rotations, the probe tip will keep its actual position.

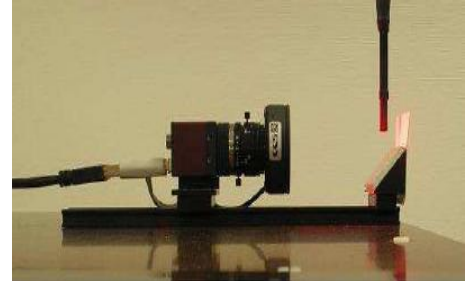

3.5. Device Holder

The COMOSAR device holder is designed to cope with different positions given in the standard. It has two scales for the device rotation (with respect to the body axis) and the device inclination (with respect to the line between the ear reference points). The rotation center for both scales is the ear reference point (EPR). Thus the device needs no repositioning when changing the angles. The COMOSAR device holder has been made out of low-loss POM material having the following dielectric parameters: relative permittivity $\epsilon_r = 3$ and loss tangent $\delta = 0.02$. The amount of dielectric material has been reduced in the closest vicinity of the device, since measurements have suggested that the influence of the clamp on the test results could thus be lowered.

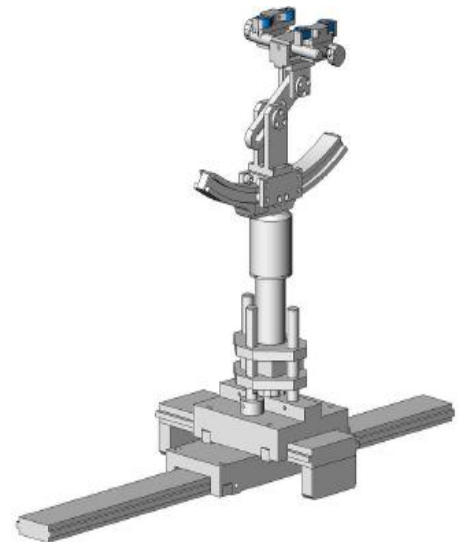

3.6. SAM Twin Phantom

The SAM twin phantom is a fiberglass shell phantom with 2mm shell thickness (except the ear region where shell thickness increases to 6mm). It has three measurement areas:

- Left head
- Right head
- Flat phantom



The bottom plate contains three pair of bolts for locking the device holder. The device holder positions are adjusted to the standard measurement positions in the three sections. A white cover is provided to tap the phantom during off-periods to prevent water evaporation and changes in the liquid parameters. On the phantom top, three reference markers are provided to identify the phantom position with respect to the robot.

4. SAR MEASUREMENT PROCEDURE

4.1. Specific Absorption Rate (SAR)

SAR is related to the rate at which energy is absorbed per unit mass in object exposed to a radio field. The SAR distribution in a biological body is complicated and is usually carried out by experimental techniques or numerical modeling. The standard recommends limits for two tiers of groups, occupational/controlled and occupational/uncontrolled, based on a person's awareness and ability to exercise control over his or her exposure. In general, occupational/controlled exposure limits are higher than the limits for general population/uncontrolled.

The SAR definition is the time derivative (rate) of the incremental energy (dW) absorbed by (dissipated in) an incremental mass (dm) contained in a volume element(dv) of given mass density (ρ). The equation description is as below:

$$SAR = \frac{d}{dt} \left(\frac{dW}{dm} \right) = \frac{d}{dt} \left(\frac{dW}{\rho dV} \right)$$

SAR is expressed in units of Watts per kilogram (W/Kg)

SAR can be obtained using either of the following equations:

$$SAR = \frac{\sigma E^2}{\rho}$$

$$SAR = c_h \left. \frac{dT}{dt} \right|_{t=0}$$

Where

SAR	is the specific absorption rate in watts per kilogram;
E	is the r.m.s. value of the electric field strength in the tissue in volts per meter;
σ	is the conductivity of the tissue in siemens per metre;
ρ	is the density of the tissue in kilograms per cubic metre;
c_h	is the heat capacity of the tissue in joules per kilogram and Kelvin;

$\left. \frac{dT}{dt} \right|_{t=0}$ is the initial time derivative of temperature in the tissue in kelvins per second

4.2. SAR Measurement Procedure

Step 1: Power Reference Measurement

The Power Reference Measurement and Power Drift Measurement are for monitoring the power drift of the device under test in the batch process. The minimum distance of probe sensors to surface is 2.7mm This distance cannot be smaller than the distance os sensor calibration points to probe tip as `defined in the probe properties,

Step 2: Area Scan

The Area Scan is used as a fast scan in two dimensions to find the area of high field values, before doing a fine measurement around the hot spot. The sophisticated interpolation routines implemented in SATIMO software can find the maximum locations even in relatively coarse grids. When an Area Scan has measured all reachable points, it computes the field maximal found in the scanned area, within a range of the global maximum. The range (in db) is specified in the standards for compliance testing. For example, a 2db range is required in IEEE Standard 1528, whereby 3db is a requirement when compliance is assessed in accordance with the ARIB standard (Japan) If one Zoom Scan follows the Area Scan, then only the absolute maximum will be taken as reference. For cases where multiple maximum are detected, the number of Zoom Scan has to be increased accordingly.

Area Scan Parameters extracted from KDB 865664 D01 SAR Measurement 100MHz to 6GHz

	≤ 3 GHz	> 3 GHz
Maximum distance from closest measurement point (geometric center of probe sensors) to phantom surface	5 ± 1 mm	$\frac{1}{2} \cdot \delta \cdot \ln(2) \pm 0.5$ mm
Maximum probe angle from probe axis to phantom surface normal at the measurement location	30° ± 1°	20° ± 1°
Maximum area scan spatial resolution: Δx_{Area} , Δy_{Area}	≤ 2 GHz: ≤ 15 mm 2 – 3 GHz: ≤ 12 mm	3 – 4 GHz: ≤ 12 mm 4 – 6 GHz: ≤ 10 mm
	When the x or y dimension of the test device, in the measurement plane orientation, is smaller than the above, the measurement resolution must be ≤ the corresponding x or y dimension of the test device with at least one measurement point on the test device.	

Step 3: Zoom Scan

Zoom Scan are used to assess the peak spatial SAR value within a cubic average volume containing 1g abd 10g of simulated tissue. The Zoom Scan measures points(refer to table below) within a cube whose base faces are centered on the maxima found in a preceding area scan job within the same procedure. When the measurement is done, the Zoom Scan evaluates the averaged SAR for 1g and 10g and displays these values next to the job's label.

Zoom Scan Parameters extracted from KDB865664 d01 SAR Measurement 100MHz to 6GHz

Maximum zoom scan spatial resolution: Δx_{Zoom} , Δy_{Zoom}		≤ 2 GHz: ≤ 8 mm 2 – 3 GHz: ≤ 5 mm*	3 – 4 GHz: ≤ 5 mm* 4 – 6 GHz: ≤ 4 mm*
Maximum zoom scan spatial resolution, normal to phantom surface	uniform grid: $\Delta z_{Zoom}(n)$	≤ 5 mm	3 – 4 GHz: ≤ 4 mm 4 – 5 GHz: ≤ 3 mm 5 – 6 GHz: ≤ 2 mm
	graded grid	$\Delta z_{Zoom}(1)$: between 1 st two points closest to phantom surface	≤ 4 mm
		$\Delta z_{Zoom}(n>1)$: between subsequent points	$\leq 1.5 \cdot \Delta z_{Zoom}(n-1)$
Minimum zoom scan volume	x, y, z	≥ 30 mm	3 – 4 GHz: ≥ 28 mm 4 – 5 GHz: ≥ 25 mm 5 – 6 GHz: ≥ 22 mm
<p>Note: δ is the penetration depth of a plane-wave at normal incidence to the tissue medium; see draft standard IEEE P1528-2011 for details.</p> <p>* When zoom scan is required and the <i>reported</i> SAR from the <i>area scan based 1-g SAR estimation</i> procedures of KDB 447498 is ≤ 1.4 W/kg, ≤ 8 mm, ≤ 7 mm and ≤ 5 mm zoom scan resolution may be applied, respectively, for 2 GHz to 3 GHz, 3 GHz to 4 GHz and 4 GHz to 6 GHz.</p>			

Step 4: Power Drift Measurement

The Power Drift Measurement measures the field at the same location as the most recent power reference measurement within the same procedure, and with the same settings. The Power Drift Measurement gives the field difference in dB from the reading conducted within the same settings. This allows a user to monitor the power drift of the device under test within a batch process. The measurement procedure is the same as Step 1.

4.3. RF Exposure Conditions

Test Configuration and setting:

The EUT is a model of GSM Portable Mobile Station (MS). It supports GSM/GPRS, WCDMA/HSPA, BT, WIFI, and support hot spot mode.

For WWAN SAR testing, the device was controlled by using a base station emulator. Communication between the device and the emulator were established by air link. The distance between the EUT and the antenna is larger than 50cm, and the output power radiated from the emulator antenna is at least 30db smaller than the output power of EUT.

For WLAN testing, the EUT is configured with the WLAN continuous TX tool through engineering command.

Antenna Location: (the back view)

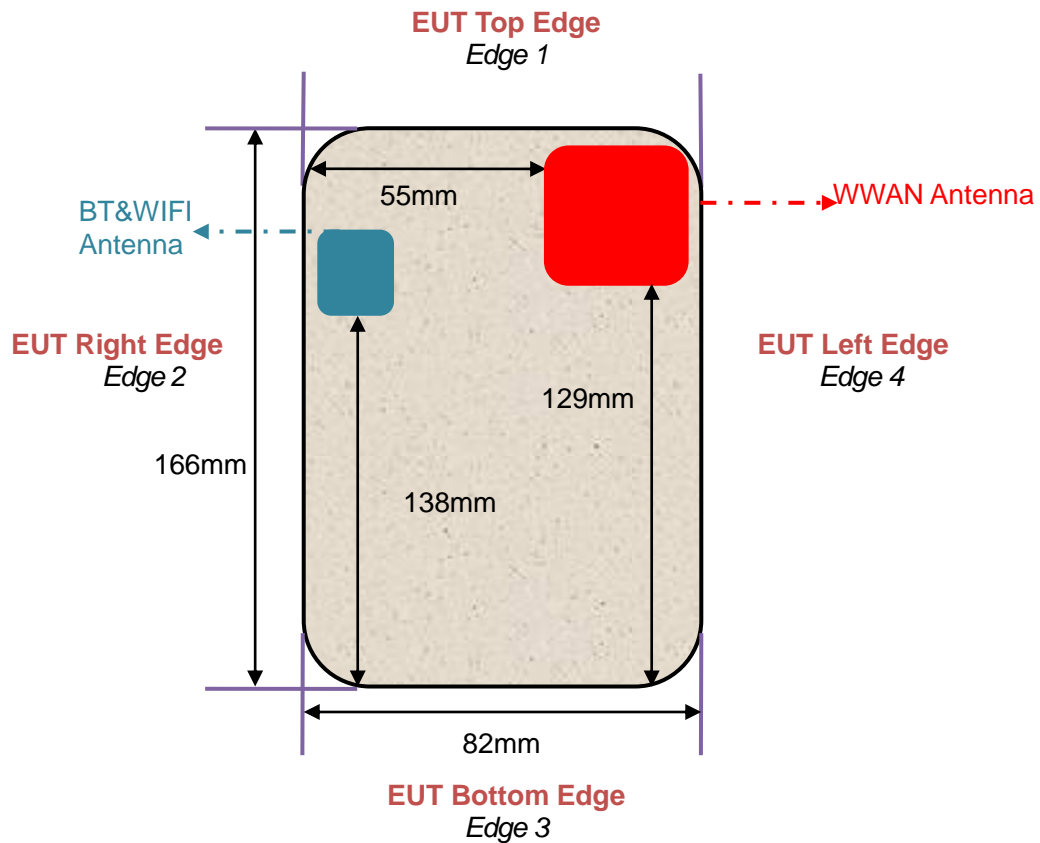

For WWAN mode:

Test Configurations	Antenna to edges/surface	SAR required	Note
Head			
Left Touch		Yes	--
Left Tilt		Yes	--
Right Touch		Yes	--
Right Tilt		Yes	--
Body			
Back	<25mm	Yes	--
Front	<25mm	Yes	--
Hotspot			
Back	<25mm	Yes	--
Front	<25mm	Yes	--
Edge 1 (Top)	3mm	Yes	--
Edge 2 (Right)	55mm	No	SAR is not required for the distance between the antenna and the edge is >25mm as per KDB 941225 D06 Hotspot SAR
Edge 3 (Bottom)	129mm	No	SAR is not required for the distance between the antenna and the edge is >25mm as per KDB 941225 D06 Hotspot SAR
Edge 4 (Left)	3mm	Yes	--

For WLAN mode:

Test Configurations	Antenna to edges/surface	SAR required	Note
Head			
Left Touch		Yes	--
Left Tilt		Yes	--
Right Touch		Yes	--
Right Tilt		Yes	--
Body			
Back	<25mm	Yes	--
Front	<25mm	Yes	--
Hotspot			
Back	<25mm	Yes	--
Front	<25mm	Yes	--
Edge 1 (Top)	23mm	Yes	--
Edge 2 (Right)	3mm	Yes	--
Edge 3 (Bottom)	138mm	No	SAR is not required for the distance between the antenna and the edge is >25mm as per KDB 941225 D06 Hotspot SAR
Edge 4 (Left)	67mm	No	SAR is not required for the distance between the antenna and the edge is >25mm as per KDB 941225 D06 Hotspot SAR

5. TISSUE SIMULATING LIQUID

For SAR measurement of the field distribution inside the phantom, the phantom must be filled with homogeneous tissue simulating liquid to a depth of at least 15cm. For head SAR testing the liquid height from the ear reference point (ERP) of the phantom to the liquid top surface is larger than 15cm For body SAR testing, the liquid height from the center of the flat phantom to the liquid top surface is larger than 15cm. The nominal dielectric values of the tissue simulating liquids in the phantom and the tolerance of 5% are listed in 5.2

5.1. The composition of the tissue simulating liquid

Ingredient (% Weight) Frequency (MHz)	Water	Nacl	Polysorbate 20	DGBE	1,2 Propanediol	Triton X-100
835 Head	50.36	1.25	48.39	0.0	0.0	0.0
835 Body	54.00	1	0.0	15	0.0	30
1900 Head	54.9	0.18	0.0	44.92	0.0	0.0
1900 Body	70	1	0.0	9	0.0	20
2450 Head	71.88	0.16	0.0	7.99	0.0	19.97
2450 Body	70	1	0.0	9	0.0	20

5.2. Tissue Dielectric Parameters for Head and Body Phantoms

The head tissue dielectric parameters recommended by the IEEE 1528 have been incorporated in the following table. These head parameters are derived from planar layer models simulating the highest expected SAR for the dielectric properties and tissue thickness variations in a human head. Other head and body tissue parameters that have not been specified in IEEE 1528 are derived from the tissue dielectric parameters computed from the 4-Cole-Cole equations described in Reference [12] and extrapolated according to the head parameters specified in IEEE 1528.

Target Frequency (MHz)	head		body	
	ϵ_r	σ (S/m)	ϵ_r	σ (S/m)
300	45.3	0.87	58.2	0.92
450	43.5	0.87	56.7	0.94
835	41.5	0.90	55.2	0.97
900	41.5	0.97	55.0	1.05
915	41.5	1.01	55.0	1.06
1450	40.5	1.20	54.0	1.30
1610	40.3	1.29	53.8	1.40
1800 – 2000	40.0	1.40	53.3	1.52
2450	39.2	1.80	52.7	1.95
3000	38.5	2.40	52.0	2.73

(ϵ_r = relative permittivity, σ = conductivity and $\rho = 1000$ kg/m³)

5.3. Tissue Calibration Result

The dielectric parameters of the liquids were verified prior to the SAR evaluation using SATIMO Dielectric Probe Kit and R&S Network Analyzer ZVL6.

Tissue Stimulant Measurement for 835MHz					
	Fr. (MHz)	Dielectric Parameters ($\pm 5\%$)		Tissue Temp [°C]	Test time
		ϵ_r 41.5 (39.425-43.575)	δ [s/m] 0.90(0.855-0.945)		
Head	824.2	42.86	0.87	21.2	Mar. 21,2017
	826.4	42.31	0.88		
	835	41.97	0.89		
	836.6	41.52	0.89		
	846.6	41.09	0.90		
	848.8	40.68	0.91		
	Body	Fr. (MHz)	Dielectric Parameters ($\pm 5\%$)		
		ϵ_r 55.20(52.44-57.96)	δ [s/m]0.97(0.9215-1.0185)		
824.2		56.37	0.93	21.3	Mar. 21,2017
826.4		55.84	0.94		
835		55.41	0.95		
836.6		55.03	0.96		
846.6		54.65	0.97		
848.8		54.13	0.98		

Tissue Stimulant Measurement for 1900MHz					
	Fr. (MHz)	Dielectric Parameters ($\pm 5\%$)		Tissue Temp [°C]	Test time
		ϵ_r 40.00(38.00-42.00)	δ [s/m]1.40(1.33-1.47)		
Head	1850.2	41.48	1.34	20.2	Mar. 22,2017
	1852.4	41.26	1.35		
	1880	40.88	1.38		
	1900	40.42	1.40		
	1907.6	40.01	1.42		
	1909.8	39.52	1.43		
	Body	Fr. (MHz)	Dielectric Parameters ($\pm 5\%$)		
		ϵ_r 53.30(50.635-55.965)	δ [s/m]1.52(1.444-1.596)		
1850.2		54.69	1.45	20.5	Mar. 22,2017
1852.4		54.47	1.46		
1880		53.79	1.49		
1900		53.55	1.51		
1907.6		53.14	1.52		
1909.8	52.88	1.53			

Tissue Stimulant Measurement for 2450MHz					
	Fr. (MHz)	Dielectric Parameters ($\pm 5\%$)		Tissue Temp [$^{\circ}$ C]	Test time
		ϵ_r 39.2(37.24-41.16)	δ [s/m]1.80(1.71-1.89)		
Head	2412	40.89	1.73	21.8	Mar. 24,2017
	2437	40.42	1.75		
	2450	39.98	1.77		
	2462	39.52	1.82		
	Fr. (MHz)	Dielectric Parameters ($\pm 5\%$)		Tissue Temp [$^{\circ}$ C]	Test time
		ϵ_r 52.7(50.065-55.335)	δ [s/m]1.95(1.8525-2.0475)		
Body	2412	54.85	1.88	21.5	Mar. 24,2017
	2437	54.37	1.90		
	2450	53.96	1.93		
	2462	53.42	1.95		

6. SAR SYSTEM CHECK PROCEDURE

6.1. SAR System Check Procedures

SAR system check is required to confirm measurement accuracy, according to the tissue dielectric media, probe calibration points and other system operating parameters required for measuring the SAR of a test device. The system verification must be performed for each frequency band and within the valid range of each probe calibration point required for testing the device. The same SAR probe(s) and tissue-equivalent media combinations used with each specific SAR system for system verification must be used for device testing. When multiple probe calibration points are required to cover substantially large transmission bands, independent system verifications are required for each probe calibration point. A system verification must be performed before each series of SAR measurements using the same probe calibration point and tissue-equivalent medium. Additional system verification should be considered according to the conditions of the tissue-equivalent medium and measured tissue dielectric parameters, typically every three to four days when the liquid parameters are remeasured or sooner when marginal liquid parameters are used at the beginning of a series of measurements.

Each SATIMO system is equipped with one or more system check kits. These units, together with the predefined measurement procedures within the SATIMO software, enable the user to conduct the system check and system validation. System kit includes a dipole, and dipole device holder.

The system check verifies that the system operates within its specifications. It's performed daily or before every SAR measurement. The system check uses normal SAR measurement in the flat section of the phantom with a matched dipole at a specified distance. The system check setup is shown as below.

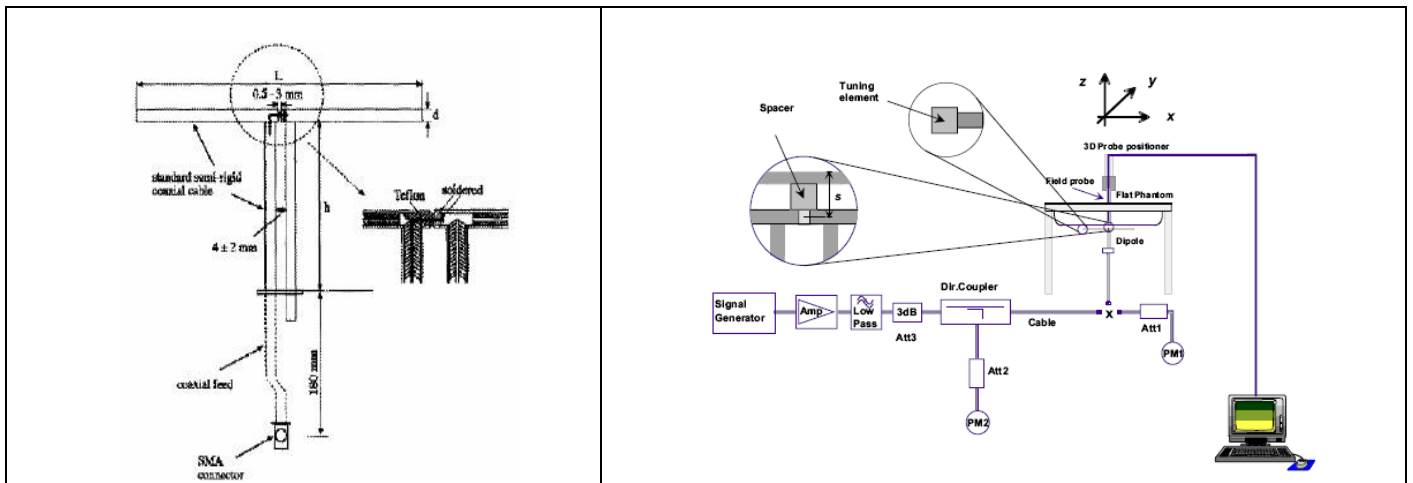

6.2. SAR System Check

6.2.1. Dipoles

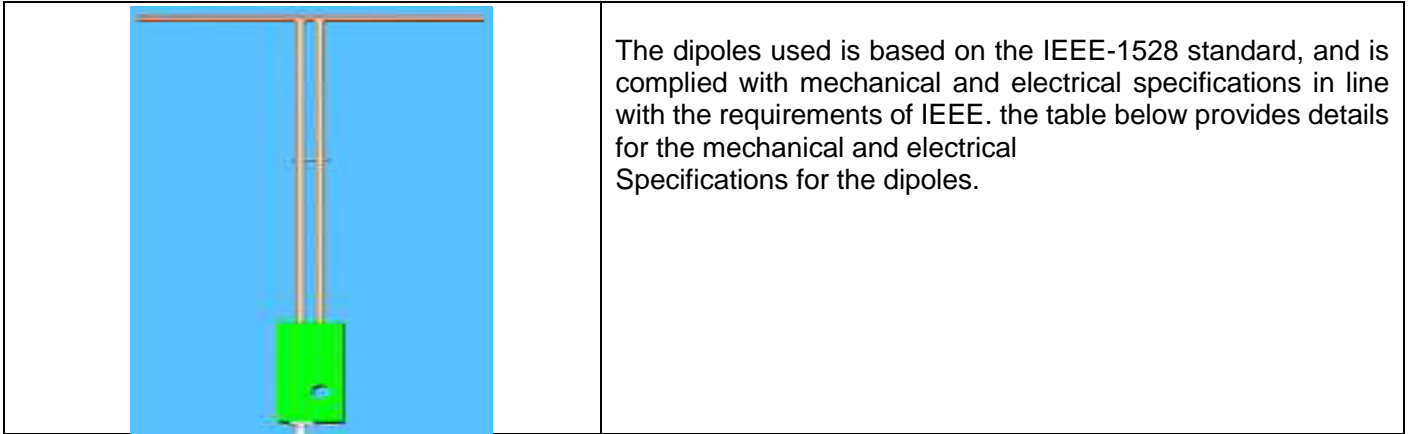

Frequency	L (mm)	h (mm)	d (mm)
835MHz	161.0	89.8	3.6
1900MHz	68	39.5	3.6
2450MHz	51.5	30.4	3.6

6.2.2. System Check Result

System Performance Check at 835MHz&1900MHz &2450MHz for Head									
Validation Kit: SN29/15 DIP 0G835-383&SN 29/15 DIP 1G900-389& SN 29/15DIP 2G450-393									
Frequency [MHz]	Target Value(W/Kg)		Reference Result ($\pm 10\%$)		Tested Value(W/Kg)		Tissue Temp. [°C]	Test time	
	1g	10g	1g	10g	1g	10g			
835	10.04	6.43	9.036-11.044	5.787 -7.073	10.581	6.514	21.2	Mar. 21,2017	
1900	41.44	21.33	37.296-45.584	19.197-23.463	39.047	21.501	20.2	Mar. 22,2017	
2450	54.53	24.30	49.077-59.983	21.87-26.730	50.465	23.647	21.8	Mar. 24,2017	
System Performance Check at 835 MHz &1900MHz & 2450MHz for Body									
Frequency [MHz]	Target Value(W/Kg)		Reference Result ($\pm 10\%$)		Tested Value(W/Kg)		Tissue Temp. [°C]	Test time	
	1g	10g	1g	10g	1g	10g			
835	9.85	6.45	8.865-10.835	5.805-7.095	9.859	6.332	21.3	Mar. 21,2017	
1900	39.38	20.86	35.442-43.318	18.774-22.946	39.168	19.757	20.5	Mar. 22,2017	
2450	49.92	23.16	44.928-54.912	20.844-25.476	49.294	22.657	21.5	Mar. 24,2017	

7. EUT TEST POSITION

This EUT was tested in **Right Cheek, Right Tilted, Left Cheek, Left Tilted, Body back, Body front and 4 edges.**

7.1. Define Two Imaginary Lines on the Handset

- (1) The vertical centerline passes through two points on the front side of the handset: the midpoint of the width w_t of the handset at the level of the acoustic output, and the midpoint of the width w_b of the handset.
- (2) The horizontal line is perpendicular to the vertical centerline and passes through the center of the acoustic output. The horizontal line is also tangential to the face of the handset at point A.
- (3) The two lines intersect at point A. Note that for many handsets, point A coincides with the center of the acoustic output; however, the acoustic output may be located elsewhere on the horizontal line. Also note that the vertical centerline is not necessarily to the front face of the handset, especially for clamshell handsets, handsets with flip covers, and other irregularly shaped handsets.

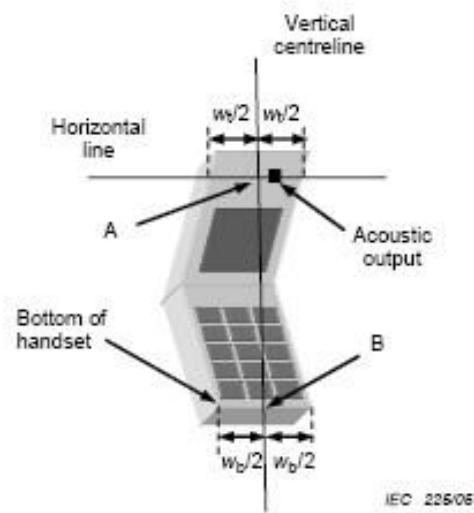
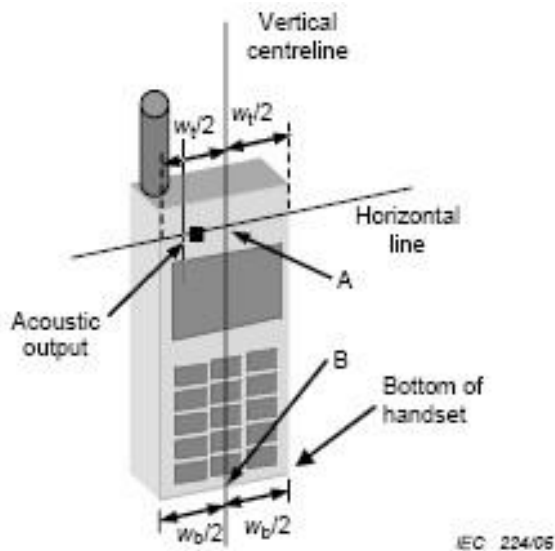

7.2. Cheek Position

- (1) To position the device with the vertical center line of the body of the device and the horizontal line crossing the center piece in a plane parallel to the sagittal plane of the phantom. While maintaining the device in this plane, align the vertical center line with the reference plane containing the ear and mouth reference point (M: Mouth, RE: Right Ear, and LE: Left Ear) and align the center of the ear piece with the line RE-LE.
- (2) To move the device towards the phantom with the ear piece aligned with the the line LE-RE until the phone touched the ear. While maintaining the device in the reference plane and maintaining the phone contact with ear, move the bottom of the phone until any point on the front side is in contact with the cheek of the phantom or until contact with the ear is lost



7.3. Tilt Position

- (1) To position the device in the "cheek" position described above.
- (2) While maintaining the device in the reference plane described above and pivoting against the ear, moves it outward away from the mouth by an angle of 15 degrees or until with the ear is lost.



7.4. Body Worn Position

- (1) To position the EUT parallel to the phantom surface.
- (2) To adjust the EUT parallel to the flat phantom.
- (3) To adjust the distance between the EUT surface and the flat phantom to **5mm**.

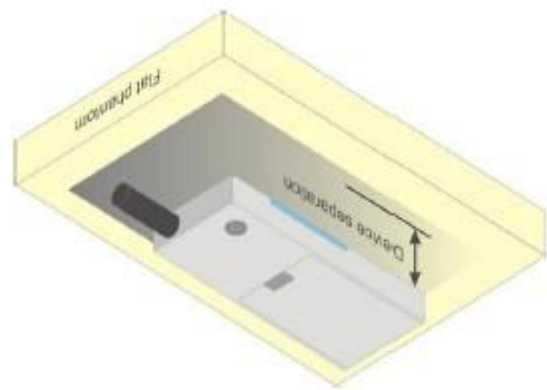
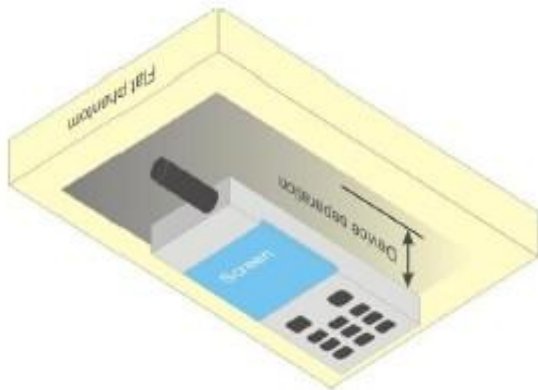

8. SAR EXPOSURE LIMITS

SAR assessments have been made in line with the requirements of IEEE-1528, and comply with ANSI/IEEE C95.1-2005 “Uncontrolled Environments” limits. These limits apply to a location which is deemed as “Uncontrolled Environment” which can be described as a situation where the general public may be exposed to an RF source with no prior knowledge or control over their exposure.

Limits for General Population/Uncontrolled Exposure (W/kg)

Type Exposure	Uncontrolled Environment Limit (W/kg)
Spatial Peak SAR (1g cube tissue for brain or body)	1.60
Spatial Average SAR (Whole body)	0.08
Spatial Peak SAR (Limbs)	4.0

9. TEST EQUIPMENT LIST

Equipment description	Manufacturer/ Model	Identification No.	Current calibration date	Next calibration date
SAR Probe	MVG	SN 14/16 EP308	12/05/2016	12/04/2017
TISSUE Probe	SATIMO	SN 23/16 OCPG 75	07/05/2016	07/04/2017
Phantom	SATIMO	SN_4511_SAM90	Validated. No cal required.	Validated. No cal required.
Liquid	SATIMO	-	Validated. No cal required.	Validated. No cal required.
Comm Tester	Agilent-8960	GB46310822	03/02/2017	03/01/2018
Multimeter	Keithley 2000	1188656	03/02/2017	03/01/2018
Dipole	SATIMO SID835	SN29/15 DIP 0G835-383	07/05/2016	07/04/2019
Dipole	SATIMO SID1900	SN 29/15 DIP 1G900-389	07/05/2016	07/04/2019
Dipole	SATIMO SID2450	SN29/15 DIP 2G450-393	07/05/2016	07/04/2019
Signal Generator	Agilent-E4438C	US41461365	03/02/2017	03/01/2018
Vector Analyzer	Agilent / E4440A	US40420298	07/02/2016	07/01/2017
Network Analyzer	Rhode & Schwarz ZVL6	SN100132	03/02/2017	03/01/2018
Attenuator	Warison /WATT-6SR1211	N/A	N/A	N/A
Attenuator	Mini-circuits / VAT-10+	N/A	N/A	N/A
Amplifier	EM30180	SN060552	03/02/2017	03/01/2018
Directional Couple	Werlatone/ C5571-10	SN99463	07/02/2016	07/01/2017
Directional Couple	Werlatone/ C6026-10	SN99482	07/02/2016	07/01/2017
Power Sensor	NRP-Z21	1137.6000.02	10/10/2016	10/09/2017
Power Sensor	NRP-Z23	US38261498	03/02/2017	03/01/2018
Power Viewer	R&S	V2.3.1.0	N/A	N/A

Note: Per KDB 865664 Dipole SAR Validation, AGC Lab has adopted 3 years calibration intervals. On annual basis, every measurement dipole has been evaluated and is in compliance with the following criteria:

1. There is no physical damage on the dipole;
2. System validation with specific dipole is within 10% of calibrated value;
3. Return-loss is within 20% of calibrated measurement;
4. Impedance is within 5Ω of calibrated measurement.

10. MEASUREMENT UNCERTAINTY

SATIMO Uncertainty-SN 14/16 EP308									
Measurement uncertainty for DUT averaged over 1 gram / 10 gram.(Head)									
Uncertainty Component	Sec.	Tol (+- %)	Prob. Dist.	Div.	Ci (1g)	Ci (10g)	1g Ui (+-%)	10g Ui (+-%)	Vi
Measurement System									
Probe calibration	E.2.1	5.831	N	1	1	1	5.83	5.83	∞
Probe Modulation	E.2.5	3.0	R	$\sqrt{3}$	1	1	1.73	1.73	∞
Axial Isotropy	E.2.2	0.6	R	$\sqrt{3}$	1	1	0.36	0.35	∞
Hemispherical Isotropy	E.2.2	0.9	R	$\sqrt{3}$	1	1	0.52	0.52	∞
Boundary effect	E.2.3	1.0	R	$\sqrt{3}$	1	1	0.58	0.58	∞
Linearity	E.2.4	1.91	R	$\sqrt{3}$	1	1	0.69	0.69	∞
System detection limits	E.2.4	1.0	R	$\sqrt{3}$	1	1	0.58	0.58	∞
Readout Electronics	E.2.6	0.02	N	□ 1	1	1	0.02	0.02	∞
Response Time	E.2.7	3.0	R	$\sqrt{3}$	1	1	1.73	1.73	∞
Integration Time	E.2.8	2.0	R	$\sqrt{3}$	1	1	1.15	1.15	∞
RF Ambient Noise	E.6.1	3.0	R	$\sqrt{3}$	1	1	1.73	1.73	∞
RF Ambient Reflection	E.6.1	3.0	R	$\sqrt{3}$	1	1	1.73	1.73	∞
Probe Positioner	E.6.2	2.0	R	$\sqrt{3}$	1	1	1.15	1.15	∞
Probe Positioning	E.6.3	0.05	R	$\sqrt{3}$	1	1	0.03	0.03	∞
Post-processing	E.5	5.0	R	$\sqrt{3}$	1	1	2.89	2.89	∞
Test sample Related									
Device Positioning	E.4.2	0.03	N	1	1	1	3.60	3.60	∞
Device Holder	E.4.1	5	N	1	1	1	2.90	2.90	∞
Measurement SAR Drift	E.2.9	0.65	R	$\sqrt{3}$	1	1	2.89	2.89	∞
Power Scaling	E.6.5	5	R	$\sqrt{3}$	1	1	0.00	0.00	∞
Phantom and set-up									
Phantom Uncertainty	E.3.1	0.05	R	$\sqrt{3}$	1	1	0.03	0.03	∞
Uncertainty in SAR correction for deviations in permittivity and conductivity	E.3.2	1.9	N	1	1	0.84	1.90	1.60	∞
Liquid Conductivity(Meas.)	E.3.3	5	N	1	0.78	0.71	3.90	3.55	M
Liquid Permittivity(Meas.)	E.3.3	5	N	1	0.23	0.26	1.15	1.30	M
Liquid Conductivity-temperature uncertainty	E.3.4	5	R	$\sqrt{3}$	0.78	0.71	2.25	2.05	∞
Liquid Permittivity-temperature uncertainty	E.3.4	5	R	$\sqrt{3}$	0.23	0.26	0.66	0.75	∞
Combined Standard Uncertainty			RSS				10.39	10.118	∞
Expanded Uncertainty (95% Confidence interval)			k				20.86	20.315	

SATIMO Uncertainty-SN 14/16 EP308									
System validation uncertainty for Dipole averaged over 1 gram / 10 gram.(Head)									
Uncertainty Component	Sec.	Tol (+-%)	Prob. Dist.	Div.	Ci (1g)	Ci (10g)	1g Ui (+-%)	10g Ui (+-%)	Vi
Measurement System									
Probe calibration	E.2.1	5.831	N	1	1	1	5.83	5.83	∞
Probe Modulation	E.2.5	3.0	R	$\sqrt{3}$	1	1	1.73	1.73	∞
Axial Isotropy	E.2.2	0.6	R	$\sqrt{3}$	1	1	1.44	1.44	∞
Hemispherical Isotropy	E.2.2	0.9	R	$\sqrt{3}$	1	1	0.52	0.52	∞
Boundary effect	E.2.3	1.0	R	$\sqrt{3}$	1	1	0.58	0.58	∞
Linearity	E.2.4	1.2	R	$\sqrt{3}$	1	1	0.69	0.69	∞
System detection limits	E.2.4	1.0	R	$\sqrt{3}$	1	1	0.58	0.58	∞
Readout Electronics	E.2.6	0.02	N	1	1	1	0.02	0.02	∞
Response Time	E.2.7	3.0	R	$\sqrt{3}$	1	1	1.73	1.73	∞
Integration Time	E.2.8	2.0	R	$\sqrt{3}$	1	1	1.15	1.15	∞
RF Ambient Noise	E.6.1	3.0	R	$\sqrt{3}$	1	1	1.73	1.73	∞
RF Ambient Reflection	E.6.1	3.0	R	$\sqrt{3}$	1	1	1.73	1.73	∞
Probe Positioner	E.6.1	2.0	R	$\sqrt{3}$	1	1	1.15	1.15	∞
Probe Positioning	E.6.2	0.05	R	$\sqrt{3}$	1	1	0.03	0.03	∞
Post-processing	E.6.3	5.0	R	$\sqrt{3}$	1	1	2.89	2.89	∞
System validation source (dipole)									
Deviation of exp. dipole	E6.4	5	R	1	1	1	5.00	5.00	∞
Dipole Axis to Liquid Dist.	8,E.6.6	5.0	R	$\sqrt{3}$	1	1	2.89	2.89	∞
Input power & SAR drift	8,6.6.4	1	R	$\sqrt{3}$	1	1	0.58	0.58	∞
Phantom and set-up									
Phantom Uncertainty	E.3.1	0.05	R	$\sqrt{3}$	1	1	0.03	0.03	∞
Uncertainty in SAR correction for deviations in permittivity and conductivity	E.3.2	1.9	N	1	1	0.84	1.90	1.60	∞
Liquid Conductivity(Meas.)	E.3.3	5	N	1	0.78	0.71	3.90	3.55	M
Liquid Permittivity(Meas.)	E.3.3	5	N	1	0.23	0.26	1.15	1.30	M
Liquid Conductivity-temperature uncertainty	E.3.4	5	R	$\sqrt{3}$	0.78	0.71	2.25	2.05	∞
Liquid Permittivity-temperature uncertainty	E.3.4	5	R	$\sqrt{3}$	0.23	0.26	0.66	0.75	∞
Combined Standard Uncertainty			RSS				11.17	10.920	∞
Expanded Uncertainty (95% Confidence interval)			k				20.879	20.333	

SATIMO Uncertainty-SN 14/16 EP308									
System Check uncertainty for Dipole averaged over 1 gram / 10 gram.(Head)									
Uncertainty Component	Sec.	Tol (+- %)	Prob. Dist.	Div.	Ci (1g)	Ci (10g)	1g Ui (+-%)	10g Ui (+-%)	Vi
Measurement System									
Modulation response	E.2.5	3.0	R	$\sqrt{3}$	0	0	0.00	0.00	∞
Boundary effect	E.2.3	1.0	R	$\sqrt{3}$	0	0	0.00	0.00	∞
System detection limits	E.2.4	1.0	R	$\sqrt{3}$	0	0	0.00	0.00	∞
Readout Electronics	E.2.6	0.02	N	1	0	0	0.00	0.00	∞
Response Time	E.2.7	3.0	R	$\sqrt{3}$	0	0	0.00	0.00	∞
Integration Time	E.2.8	2.0	R	$\sqrt{3}$	0	0	0.00	0.00	∞
RF Ambient Noise	E.6.1	3.0	R	$\sqrt{3}$	0	0	0.00	0.00	∞
RF Ambient Reflection	E.6.1	3.0	R	$\sqrt{3}$	0	0	0.00	0.00	∞
Probe Positioner	E.6.1	2.0	R	$\sqrt{3}$	1	1	1.15	1.15	∞
Probe Positioning	E.6.2	0.05	R	$\sqrt{3}$	1	1	0.03	0.03	∞
Post-processing	E.6.3	5.0	R	$\sqrt{3}$	0	0	0.00	0.00	∞
Field source									
Deviation of exp. dipole	E6.4	5	R	1	1	1	5.00	5.00	∞
Dipole Axis to Liquid Dist.	8,E.6.6	4.7	R	$\sqrt{3}$	1	1	2.71	2.71	∞
Input power & SAR drift	8,6.6.4	1	R	$\sqrt{3}$	1	1	0.58	0.58	∞
Phantom and set-up									
Phantom Uncertainty	E.3.1	0.05	R	$\sqrt{3}$	1	1	0.03	0.03	∞
Uncertainty in SAR correction for deviations in permittivity and conductivity	E.3.2	1.9	N	1	1	0.84	1.90	1.60	∞
Liquid Conductivity(Meas.)	E.3.3	5	N	1	0.78	0.71	3.90	3.55	M
Liquid Permittivity(Meas.)	E.3.3	5	N	1	0.23	0.26	1.15	1.30	M
Liquid Conductivity-temperature uncertainty	E.3.4	5	R	$\sqrt{3}$	0.78	0.71	2.25	2.05	∞
Liquid Permittivity-temperature uncertainty	E.3.4	5	R	$\sqrt{3}$	0.23	0.26	0.66	0.75	∞
Combined Standard Uncertainty			RSS				7.076	6.667	∞
Expanded Uncertainty (95% Confidence interval)			k				14.152	13.334	

11. CONDUCTED POWER MEASUREMENT

GSM BAND

Mode	Frequency(MHz)	Avg. Burst Power(dBm)	Duty cycle Factor(dBm)	Frame Power(dBm)
Maximum Power <1>				
GSM 850	824.2	31.95	-9	22.95
	836.6	32.12	-9	23.12
	848.8	32.07	-9	23.07
GPRS 850 (1 Slot)	824.2	29.76	-9	20.76
	836.6	31.10	-9	22.10
	848.8	31.13	-9	22.13
GPRS 850 (2 Slot)	824.2	28.74	-6	22.74
	836.6	28.56	-6	22.56
	848.8	29.03	-6	23.03
GPRS 850 (3 Slot)	824.2	26.31	-4.26	22.05
	836.6	27.05	-4.26	22.79
	848.8	26.74	-4.26	22.48
GPRS 850 (4 Slot)	824.2	25.95	-3	22.95
	836.6	25.74	-3	22.74
	848.8	25.74	-3	22.74
Maximum Power <2>				
GSM 850	824.2	31.21	-9	22.21
	836.6	31.54	-9	22.54
	848.8	31.49	-9	22.49
GPRS 850 (1 Slot)	824.2	29.21	-9	20.21
	836.6	31.05	-9	22.05
	848.8	31.07	-9	22.07
GPRS 850 (2 Slot)	824.2	28.23	-6	22.23
	836.6	28.56	-6	22.56
	848.8	28.84	-6	22.84
GPRS 850 (3 Slot)	824.2	26.21	-4.26	21.95
	836.6	26.12	-4.26	21.86
	848.8	26.23	-4.26	21.97
GPRS 850 (4 Slot)	824.2	25.33	-3	22.33
	836.6	25.22	-3	22.22
	848.8	25.26	-3	22.26

GSM BAND CONTINUE

Mode	Frequency(MHz)	Avg. Burst Power(dBm)	Duty cycle Factor(dBm)	Frame Power(dBm)
Maximum Power <1>				
PCS1900	1850.2	28.93	-9	19.93
	1880	28.82	-9	19.82
	1909.8	28.79	-9	19.79
GPRS1900 (1 Slot)	1850.2	27.89	-9	18.89
	1880	27.81	-9	18.81
	1909.8	27.49	-9	18.49
GPRS1900 (2 Slot)	1850.2	25.86	-6	19.86
	1880	25.74	-6	19.74
	1909.8	25.68	-6	19.68
GPRS1900 (3 Slot)	1850.2	24.26	-4.26	20.00
	1880	24.25	-4.26	19.99
	1909.8	24.21	-4.26	19.95
GPRS1900 (4 Slot)	1850.2	22.87	-3	19.87
	1880	22.81	-3	19.81
	1909.8	22.73	-3	19.73
Maximum Power <2>				
PCS1900	1850.2	27.41	-9	18.41
	1880	27.39	-9	18.39
	1909.8	27.35	-9	18.35
GPRS1900 (1 Slot)	1850.2	27.02	-9	18.02
	1880	27.12	-9	18.12
	1909.8	27.06	-9	18.06
GPRS1900 (2 Slot)	1850.2	25.33	-6	19.33
	1880	25.52	-6	19.52
	1909.8	25.41	-6	19.41
GPRS1900 (3 Slot)	1850.2	24.12	-4.26	19.86
	1880	24.23	-4.26	19.97
	1909.8	24.20	-4.26	19.94
GPRS1900 (4 Slot)	1850.2	22.87	-3	19.87
	1880	22.81	-3	19.81
	1909.8	22.73	-3	19.73

Note 1:

The Frame Power (Source-based time-averaged Power) is scaled the maximum burst average power based on time slots. The calculated methods are show as following:

Frame Power = Max burst power (1 Up Slot) – 9 dB

Frame Power = Max burst power (2 Up Slot) – 6 dB

Frame Power = Max burst power (3 Up Slot) – 4.26 dB

Frame Power = Max burst power (4 Up Slot) – 3 dB

Note 2:

SAR is not required for GPRS (1 Slot) Mode because its output power is less than of Voice Mode

UMTS BAND

HSDPA Setup Configuration:

- The EUT was connected to Base Station Agilent E5515C referred to the Setup Configuration.
- The RF path losses were compensated into the measurements.
- A call was established between EUT and Based Station with following setting:
 - (1) Set Gain Factors(β_c and β_d) parameters set according to each
 - (2) Set RMC 12.2Kbps+HSDPA mode.
 - (3) Set Cell Power=-86dBm
 - (4) Set HS-DSCH Configuration Type to FRC (H-set 1, QPSK)
 - (5) Select HSDPA Uplink Parameters
 - (6) Set Delta ACK, Delta NACK and Delta CQI=8
 - (7) Set Ack - Nack Repetition Factor to 3
 - (8) Set CQI Feedback Cycle (k) to 4ms
 - (9) Set CQI Repetition Factor to 2
 - (10) Power Ctrl Mode=All Up bits
- The transmitted maximum output power was recorded.

Table C.10.2.4: β values for transmitter characteristics tests with HS-DPCCH

Sub-test	β_c (Note5)	β_d	β_d (SF)	β_c/β_d	β_{HS} (Note1, Note 2)	CM (dB) (Note 3)	MPR (dB) (Note 3)
1	2/15	15/15	64	2/15	4/15	0.0	0.0
2	12/15(Note 4)	15/15(Note 4)	64	12/15(Note 4)	24/15	1.0	0.0
3	15/15	8/15	64	15/8	30/15	1.5	0.5
4	15/15	4/15	64	15/4	30/15	1.5	0.5

Note 1: $\Delta ACK, \Delta NACK$ and $\Delta CQI = 30/15$ with $\beta_{hs} = 30/15 * \beta_c$.

Note 2: For the HS-DPCCH power mask requirement test in clause 5.2C, 5.7A, and the Error Vector Magnitude (EVM) with HS-DPCCH test in clause 5.13.1A, and HSDPA EVM with phase discontinuity in clause 5.13.1AA, ΔACK and $\Delta NACK = 30/15$ with $\beta_{hs} = 30/15 * \beta_c$, and $\Delta CQI = 24/15$ with $\beta_{hs} = 24/15 * \beta_c$.

Note 3: CM = 1 for $\beta_c/\beta_d = 12/15, \square_{hs}/\square_c = 24/15$. For all other combinations of DPDCH, DPCCH and HS-DPCCH the MPR is based on the relative CM difference. This is applicable for only UEs that support HSDPA in release 6 and later releases.

Note 4: For subtest 2 the \square_c/\square_d ratio of 12/15 for the TFC during the measurement period (TF1, TF0) is achieved by setting the signalled gain factors for the reference TFC (TF1, TF1) to $\square_c = 11/15$ and $\square_d = 15/15$.

HSUPA Setup Configuration:

- The EUT was connected to Base Station Agilent E5515C referred to the Setup Configuration.
- The RF path losses were compensated into the measurements.
- A call was established between EUT and Base Station with following setting * :
 - (1) Call Configs = 5.2B, 5.9B, 5.10B, and 5.13.2B with QPSK
 - (2) Set the Gain Factors (β_c and β_d) and parameters (AG Index) were set according to each specific sub-test in the following table, C11.1.3, quoted from the TS 34.121
 - (3) Set Cell Power = -86 dBm
 - (4) Set Channel Type = 12.2k + HSPA
 - (5) Set UE Target Power
 - (6) Power Ctrl Mode= Alternating bits
 - (7) Set and observe the E-TFCI
 - (8) Confirm that E-TFCI is equal to the target E-TFCI of 75 for sub-test 1, and other subtest's E-TFCI
- The transmitted maximum output power was recorded.

Table C.11.1.3: β values for transmitter characteristics tests with HS-DPCCH and E-DCH

Sub-test	β_c	β_d	β_d (SF)	β_c/β_d	β_{HS} (Note 1)	β_{ec}	β_{ed} (Note 4) (Note 5)	β_{ed} (SF)	β_{ed} (Code s)	CM (dB) (Note 2)	MPR (dB) (Note 2) (Note 6)	AG Index (Note 5)	E-TF CI
1	11/15 (Note 3)	15/15 (Note 3)	64	11/15 (Note 3)	22/15	209/225	1309/225	4	1	1.0	0.0	20	75
2	6/15	15/15	64	6/15	12/15	12/15	94/75	4	1	3.0	2.0	12	67
3	15/15	9/15	64	15/9	30/15	30/15	β_{ed1} : 47/15 β_{ed2} : 47/15	4 4	2	2.0	1.0	15	92
4	2/15	15/15	64	2/15	4/15	2/15	56/75	4	1	3.0	2.0	17	71
5	15/15	0	-	-	5/15	5/15	47/15	4	1	1.0	0.0	12	67

Note 1: For sub-test 1 to 4, ΔACK , $\Delta NACK$ and $\Delta CQI = 30/15$ with $\beta_{hs} = 30/15 * \beta_c$. For sub-test 5, ΔACK , $\Delta NACK$ and $\Delta CQI = 5/15$ with $\beta_{hs} = 5/15 * \beta_c$.

Note 2: CM = 1 for $\beta_c/\beta_d = 12/15$, $\beta_{hs}/\beta_c = 24/15$. For all other combinations of DPDCH, DPCCH, HS DPCCH, E-DPDCH and E-DPCCH the MPR is based on the relative CM difference.

Note 3: For subtest 1 the β_c/β_d ratio of 11/15 for the TFC during the measurement period (TF1, TF0) is achieved by setting the signalled gain factors for the reference TFC (TF1, TF1) to $\beta_c = 10/15$ and $\beta_d = 15/15$.

Note 4: In case of testing by UE using E-DPDCH Physical Layer category 1, Sub-test 3 is omitted according to TS25.306 Table 5.1g.

Note 5: β_{ed} cannot be set directly; it is set by Absolute Grant Value.

Note 6: For subtests 2, 3 and 4, UE may perform E-DPDCH power scaling at max power which could results in slightly smaller MPR values.

UMTS BAND II

Mode	Frequency (MHz)	Avg. Burst Power (dBm)
WCDMA 1900 RMC	1852.4	20.56
	1880	21.04
	1907.6	20.84
WCDMA 1900 AMR	1852.4	20.94
	1880	21.37
	1907.6	21.08
HSDPA Subtest 1	1852.4	20.58
	1880	21.50
	1907.6	20.60
HSDPA Subtest 2	1852.4	20.44
	1880	20.64
	1907.6	20.54
HSDPA Subtest 3	1852.4	20.21
	1880	21.49
	1907.6	20.71
HSDPA Subtest 4	1852.4	19.58
	1880	20.34
	1907.6	20.45
HSUPA Subtest 1	1852.4	20.07
	1880	20.39
	1907.6	20.34
HSUPA Subtest 2	1852.4	20.34
	1880	20.40
	1907.6	20.48
HSUPA Subtest 3	1852.4	20.62
	1880	20.28
	1907.6	20.39
HSUPA Subtest 4	1852.4	20.54
	1880	20.61
	1907.6	20.47
HSUPA Subtest 5	1852.4	20.16
	1880	20.42
	1907.6	20.63

UMTS BAND V

Mode	Frequency (MHz)	Avg. Burst Power (dBm)
WCDMA 850 RMC	826.4	20.48
	836.6	20.44
	846.6	20.29
WCDMA 850 AMR	826.4	20.91
	836.6	20.28
	846.6	20.60
HSDPA Subtest 1	826.4	20.89
	836.6	20.17
	846.6	20.14
HSDPA Subtest 2	826.4	20.69
	836.6	20.93
	846.6	20.28
HSDPA Subtest 3	826.4	20.25
	836.6	20.23
	846.6	20.68
HSDPA Subtest 4	826.4	20.56
	836.6	20.41
	846.6	20.50
HSUPA Subtest 1	826.4	20.86
	836.6	20.93
	846.6	20.35
HSUPA Subtest 2	826.4	20.70
	836.6	20.46
	846.6	20.84
HSUPA Subtest 3	826.4	21.06
	836.6	20.57
	846.6	20.13
HSUPA Subtest 4	826.4	20.46
	836.6	20.75
	846.6	20.26
HSUPA Subtest 5	826.4	20.64
	836.6	20.18
	846.6	20.73

According to 3GPP 25.101 sub-clause 6.2.2 , the maximum output power is allowed to be reduced by following the table.

Table 6.1aA: UE maximum output power with HS-DPCCH and E-DCH

UE Transmit Channel Configuration	CM(db)	MPR(db)
For all combinations of ,DPDCH,DPCCH HS-DPDCH,E-DPDCH and E-DPCCH	$0 \leq CM \leq 3.5$	$MAX(CM-1,0)$
Note: CM=1 for $\beta_d/\beta_d=12/15$, $\beta_{hs}/\beta_c=24/15$.For all other combinations of DPDCH, DPCCH, HS-DPCCH, E-DPDCH and E-DPCCH the MPR is based on the relative CM difference.		

The device supports MPR to solve linearity issues (ACLR or SEM) due to the higher peak-to average ratios (PAR) of the HSUPA signal. This prevents saturating the full range of the TX DAC inside of device and provides a reduced power output to the RF transceiver chip according to the Cubic Metric (a function of the combinations of DPDCH, DPCCH, HS-DPCCH, E-DPDCH and E-DPCCH).

When E-DPDCH channels are present the beta gains on those channels are reduced firsts to try to get the power under the allowed limit. If the beta gains are lowered as far as possible, then a hard limiting is applied at the maximum allowed level.

The SW currently recalculates the cubic metric every time the beta gains on the E-DPDCH are reduced. The cubic metric will likely get lower each time this is done .However, there is no reported reduction of maximum output power in the HSUPA mode since the device also provides a compensation for the power back-off by increasing the gain of TX_AGC in the transceiver (PA) device.

The end effect is that the DUT output power is identical to the case where there is no MPR in the device.

WIFI

Mode	Data Rate (Mbps)	Channel	Frequency(MHz)	Avg. Burst Power(dBm)
802.11b	1	01	2412	16.04
		06	2437	15.43
		11	2462	14.75
802.11g	6	01	2412	11.31
		06	2437	13.63
		11	2462	14.08
802.11n(20)	6.5	01	2412	12.72
		06	2437	13.70
		11	2462	13.63
802.11n(40)	13.5	03	2422	14.46
		06	2437	13.62
		09	2452	13.29

Bluetooth_V3.0

Modulation	Channel	Frequency(MHz)	Peak Power (dBm)
GFSK	0	2402	5.875
	39	2441	5.285
	78	2480	4.111
$\pi/4$ -DQPSK	0	2402	5.443
	39	2441	4.990
	78	2480	4.102
8-DPSK	0	2402	5.113
	39	2441	4.701
	78	2480	3.752

Bluetooth_V4.0

Modulation	Channel	Frequency(MHz)	Peak Power (dBm)
GFSK	0	2402	-2.044
	19	2440	-2.464
	39	2480	-3.663

12. TEST RESULTS

12.1. SAR Test Results Summary

12.1.1. Test position and configuration

Head SAR was performed with the device configured in the positions according to IEEE 1528-2013, Body-worn SAR was performed with the device 5mm from the phantom, and 4 Edges SAR was performed with the device 10mm from the phantom.

12.1.2. Operation Mode

1. Per KDB 447498 D01 v06 ,for each exposure position, if the highest 1-g SAR is ≤ 0.8 W/kg, testing for low and high channel is optional.
2. Per KDB 865664 D01 v01r04,for each frequency band, if the measured SAR is ≥ 0.8 W/Kg, testing for repeated SAR measurement is required , that the highest measured SAR is only to be tested. When the SAR results are near the limit, the following procedures are required for each device to verify these types of SAR measurement related variation concerns by repeating the highest measured SAR configuration in each frequency band.
 - (1) When the original highest measured SAR is ≥ 0.8 W/Kg, repeat that measurement once.
 - (2) Perform a second repeated measurement only if the ratio of largest to smallest SAR for the original and first repeated measurements is >1.20 or when the original or repeated measurement is ≥ 1.45 W/Kg.
 - (3) Perform a third repeated measurement only if the original, first and second repeated measurement is ≥ 1.5 W/Kg and ratio of largest to smallest SAR for the original, first and second measurement is ≥ 1.20 .
3. Body-worn exposure conditions are intended to voice call operations, therefore GSM voice call mode is selected to be test.
4. Per KDB 648474 D04 v01r03,when the reported SAR for a body-worn accessory measured without a headset connected to the handset is ≤ 1.2 W/Kg, SAR testing with a headset connected is not required.
5. Per KDB 248227 D01v02r02,for 2.4GHz 802.11g/n SAR testing is not required when the highest reported SAR for DSSS is adjusted by the ratio of OFDM to DSSS specified maximum output power and the adjusted SAR is ≤ 1.2 W/kg.
6. Per KDB 941225 D06 V02r01, When the same wireless mode transmission configurations for voice and data are required for SAR measurements, the more conservative configuration with a smaller separation distance should be tested for the overlapping SAR configurations.
7. Maximum Scaling SAR in order to calculate the Maximum SAR values to test under the standard Peak Power, Calculation method is as follows:
Maximum Scaling SAR =tested SAR (Max.) \times [maximum turn-up power (mw)/ maximum measurement output power(mw)]
8. Proximity sensor, just for avoiding the wrong operation in the phone screen when call, and has no influence on output power or SAR resu

12.1.3. Test Result

SAR MEASUREMENT									
Depth of Liquid (cm):>15					Relative Humidity (%): 55.5				
Product: Smartphone-Miracle 6.0 S									
Test Mode: GSM850 with GMSK modulation									
Position	Mode	Ch.	Fr. (MHz)	Power Drift (<±5%)	SAR (1g) (W/kg)	Max. Tune-up Power (dBm)	Meas. output Power (dBm)	Scaled SAR (W/Kg)	Limit (W/kg)
SIM 1 Card									
Left Cheek	voice	190	836.6	-0.25	0.062	32.50	32.12	0.068	1.6
Left Tilt	voice	190	836.6	1.22	0.059	32.50	32.12	0.064	1.6
Right Cheek	voice	190	836.6	0.02	0.089	32.50	32.12	0.097	1.6
Right Tilt	voice	190	836.6	0.23	0.090	32.50	32.12	0.098	1.6
Body back	voice	190	836.6	-0.55	0.659	32.50	32.12	0.719	1.6
Body front	voice	190	836.6	-0.63	0.056	32.50	32.12	0.061	1.6
SIM 2 Card									
Left Cheek	GPRS-2 slot	190	836.6	-0.44	0.056	29.03	28.56	0.062	1.6
Left Tilt	GPRS-2 slot	190	836.6	-0.23	0.081	29.03	28.56	0.090	1.6
Right Cheek	GPRS-2 slot	190	836.6	1.55	0.114	29.03	28.56	0.127	1.6
Right Tilt	GPRS-2 slot	190	836.6	0.23	0.096	29.03	28.56	0.107	1.6
Body back	GPRS-2 slot	190	836.6	-0.55	0.662	29.03	28.56	0.738	1.6
Body front	GPRS-2 slot	190	836.6	0.23	0.075	29.03	28.56	0.084	1.6
Edge 1 (Top)	GPRS-2 slot	190	836.6	-1.55	0.078	29.03	28.56	0.087	1.6
Edge 2(Right)	GPRS-2 slot	190	836.6	0.23	0.048	29.03	28.56	0.053	1.6
Edge 3(Bottom)	GPRS-2 slot	190	836.6	-1.23	0.009	29.03	28.56	0.010	1.6
Edge 4(Left)	GPRS-2 slot	190	836.6	0.02	0.097	29.03	28.56	0.108	1.6
SIM 2 Card									
Right Cheek	GPRS-2 slot	190	836.6	-0.44	0.104	29.03	28.56	0.116	1.6
Body back	GPRS-2 slot	190	836.6	0.23	0.661	29.03	28.56	0.737	1.6

Note:

- When the 1-g Reported SAR is ≤ 0.8 W/kg, testing for low and high channel is optional. Refer to KDB 447498.
- The test separation for body back and body front is 5mm of all above table.
- The test separation for 4 Edges is 10mm of all above table.

SAR MEASUREMENT									
Depth of Liquid (cm):>15					Relative Humidity (%): 54.9				
Product: Smartphone-Miracle 6.0 S									
Test Mode: PCS1900 with GMSK modulation									
Position	Mode	Ch.	Fr. (MHz)	Power Drift ($\pm 5\%$)	SAR (1g) (W/kg)	Max. Tune-up Power (dBm)	Meas. output Power (dBm)	Scaled SAR (W/Kg)	Limit (W/kg)
SIM 1 Card									
Left Cheek	voice	661	1880.0	-0.23	0.024	29.00	28.82	0.025	1.6
Left Tilt	voice	661	1880.0	-1.55	0.032	29.00	28.82	0.033	1.6
Right Cheek	voice	661	1880.0	0.23	0.037	29.00	28.82	0.039	1.6
Right Tilt	voice	661	1880.0	-0.02	0.041	29.00	28.82	0.043	1.6
Body back	voice	661	1880.0	-0.66	0.388	29.00	28.82	0.404	1.6
Body front	voice	661	1880.0	0.31	0.031	29.00	28.82	0.032	1.6
Left Cheek	GPRS-3 slot	661	1880.0	-1.55	0.037	24.50	24.25	0.039	1.6
Left Tilt	GPRS-3 slot	661	1880.0	0.23	0.044	24.50	24.25	0.047	1.6
Right Cheek	GPRS-3 slot	661	1880.0	1.55	0.070	24.50	24.25	0.074	1.6
Right Tilt	GPRS-3 slot	661	1880.0	0.02	0.069	24.50	24.25	0.073	1.6
Body back	GPRS-3 slot	512	1850.2	-0.23	0.680	24.50	24.26	0.719	1.6
Body back	GPRS-3 slot	661	1880.0	0.63	0.774	24.50	24.25	0.820	1.6
Body back	GPRS-3 slot	810	1909.8	-0.77	0.779	24.50	24.21	0.833	1.6
Body front	GPRS-3 slot	661	1880.0	0.23	0.034	24.50	24.25	0.036	1.6
Edge 1 (Top)	GPRS-3 slot	661	1880.0	-1.23	0.047	24.50	24.25	0.050	1.6
Edge 2(Right)	GPRS-3 slot	661	1880.0	0.02	0.009	24.50	24.25	0.010	1.6
Edge 3(Bottom)	GPRS-3 slot	661	1880.0	0.23	0.013	24.50	24.25	0.014	1.6
Edge 4(Left)	GPRS-3 slot	661	1880.0	-0.33	0.162	24.50	24.25	0.172	1.6
SIM 2 Card									
Right Cheek	GPRS-3 slot	661	1880.0	-0.15	0.056	24.50	24.23	0.060	1.6
Body back	GPRS-3 slot	810	1909.8	-1.22	0.692	24.50	24.20	0.741	1.6

Note:

- When the 1-g Reported SAR is ≤ 0.8 W/kg, testing for low and high channel is optional. Refer to KDB 447498.
- The test separation for body back and body front is 5mm of all above table.
- The test separation for 4 Edges is 10mm of all above table.

SAR MEASUREMENT									
Depth of Liquid (cm):>15					Relative Humidity (%): 54.9				
Product: Smartphone-Miracle 6.0 S									
Test Mode: WCDMA Band II with QPSK modulation									
Position	Mode	Ch.	Fr. (MHz)	Power Drift ($\pm 5\%$)	SAR (1g) (W/kg)	Max. Tune-up Power (dBm)	Meas. output Power (dBm)	Scaled SAR (W/Kg)	Limit (W/kg)
Left Cheek	HSDPA Subtest 1	9400	1880	-0.55	0.029	22.00	21.50	0.033	1.6
Left Tilt	HSDPA Subtest 1	9400	1880	0.23	0.032	22.00	21.50	0.036	1.6
Right Cheek	HSDPA Subtest 1	9400	1880	0.23	0.040	22.00	21.50	0.045	1.6
Right Tilt	HSDPA Subtest 1	9400	1880	-0.42	0.051	22.00	21.50	0.057	1.6
Body back	HSDPA Subtest 1	9400	1880	0.23	0.685	22.00	21.50	0.769	1.6
Body front	HSDPA Subtest 1	9400	1880	1.55	0.041	22.00	21.50	0.046	1.6
Edge 1 (Top)	HSDPA Subtest 1	9400	1880	-0.32	0.031	22.00	21.50	0.035	1.6
Edge 2(Right)	HSDPA Subtest 1	9400	1880	-1.55	0.007	22.00	21.50	0.008	1.6
Edge 3(Bottom)	HSDPA Subtest 1	9400	1880	0.26	0.009	22.00	21.50	0.010	1.6
Edge 4(Left)	HSDPA Subtest 1	9400	1880	0.32	0.088	22.00	21.50	0.099	1.6

Note:

- When the 1-g Reported SAR is ≤ 0.8 W/kg, testing for low and high channel is optional. Refer to KDB 447498.
- The test separation for body back and body front is 5mm of all above table.
- The test separation for 4 Edges is 10mm of all above table.

SAR MEASUREMENT									
Depth of Liquid (cm):>15					Relative Humidity (%): 55.5				
Product: Smartphone-Miracle 6.0 S									
Test Mode: WCDMA Band V with QPSK modulation									
Position	Mode	Ch.	Fr. (MHz)	Power Drift (<±5%)	SAR (1g) (W/kg)	Max. Tune-up Power (dBm)	Meas. output Power (dBm)	Scaled SAR (W/Kg)	Limit (W/kg)
Left Cheek	HSUPA Subtest 3	4183	836.6	-0.23	0.046	21.06	20.57	0.051	1.6
Left Tilt	HSUPA Subtest 3	4183	836.6	0.33	0.048	21.06	20.57	0.054	1.6
Right Cheek	HSUPA Subtest 3	4183	836.6	0.23	0.059	21.06	20.57	0.066	1.6
Right Tilt	HSUPA Subtest 3	4183	836.6	1.55	0.066	21.06	20.57	0.074	1.6
Body back	HSUPA Subtest 3	4132	826.4	-0.20	1.008	21.06	21.06	1.008	1.6
Body back	HSUPA Subtest 3	4183	836.6	0.23	0.995	21.06	20.57	1.114	1.6
Body back	HSUPA Subtest 3	4233	846.6	1.66	0.989	21.06	20.13	1.225	1.6
Body front	HSUPA Subtest 3	4183	836.6	0.32	0.062	21.06	20.57	0.069	1.6
Edge 1 (Top)	HSUPA Subtest 3	4183	836.6	-0.02	0.033	21.06	20.57	0.037	1.6
Edge 2(Right)	HSUPA Subtest 3	4183	836.6	0.56	0.028	21.06	20.57	0.031	1.6
Edge 3(Bottom)	HSUPA Subtest 3	4183	836.6	0.32	0.005	21.06	20.57	0.006	1.6
Edge 4(Left)	HSUPA Subtest 3	4183	836.6	-1.33	0.045	21.06	20.57	0.050	1.6

Note:

- When the 1-g Reported SAR is ≤ 0.8 W/kg, testing for low and high channel is optional. Refer to KDB 447498.
- The test separation for body back and body front is 5mm of all above table.
- The test separation for 4 Edges is 10mm of all above table.

SAR MEASUREMENT									
Depth of Liquid (cm):>15					Relative Humidity (%): 52.7				
Product: Smartphone-Miracle 6.0 S									
Test Mode:802.11b									
Position	Mode	Ch.	Fr. (MHz)	Power Drift (<±5%)	SAR (1g) (W/kg)	Max. Tune-up Power (dBm)	Meas. output Power (dBm)	Scaled SAR (W/Kg)	Limit (W/kg)
Left Cheek	DTS	01	2412	-0.06	0.080	16.20	16.04	0.083	1.6
Left Tilt	DTS	01	2412	0.23	0.068	16.20	16.04	0.071	1.6
Right Cheek	DTS	01	2412	1.33	0.046	16.20	16.04	0.048	1.6
Right Tilt	DTS	01	2412	-0.02	0.031	16.20	16.04	0.032	1.6
Body back	DTS	01	2412	0.56	0.251	16.20	16.04	0.260	1.6
Body front	DTS	01	2412	0.32	0.030	16.20	16.04	0.031	1.6
Edge 1 (Top)	DTS	01	2412	0.23	0.032	16.20	16.04	0.033	1.6
Edge 2(Right)	DTS	01	2412	-1.22	0.068	16.20	16.04	0.071	1.6
Edge 3(Bottom)	DTS	01	2412	-0.02	0.003	16.20	16.04	0.003	1.6
Edge 4(Left)	DTS	01	2412	0.36	0.003	16.20	16.04	0.003	1.6

Note:

- According to KDB248227, SAR is not required for 802.11n HT20/HT40 channels when the maximum average output power is less than 1/4 dB higher than that measured on the corresponding 802.11a/b channels.
- All of above "DTS" means data transmitters.
- The test separation for body back and body front is 5mm of all above table.
- The test separation for 4 Edges is 10mm of all above table.

Repeated SAR										
Product: Smartphone-Miracle 6.0 S										
Test Mode: PCS1900 & WCDMA Band V										
Position	Mode	Ch.	Fr. (MHz)	Power Drift (<±5%)	Once SAR (1g) (W/kg)	Power Drift (<±5%)	Twice SAR (1g) (W/kg)	Power Drift (<±5%)	Third SAR (1g) (W/kg)	Limit (W/kg)
Body back	GPRS-3 slot	810	1909.8	-0.02	0.777	--	--	--	--	1.6
Body back	HSUPA Subtest 3	4132	826.4	-0.63	1.006	--	--	--	--	1.6

Simultaneous Multi-band Transmission Evaluation:
Application Simultaneous Transmission information:

NO	Simultaneous state	Portable Handset		
		Head	Body-worn	Hotspot
1	GSM(voice)+WLAN 2.4GHz (data)	Yes	Yes	-
2	WCDMA(voice)+WLAN 2.4GHz (data)	Yes	Yes	-
3	GSM(voice)+Bluetooth(data)	-	Yes	-
4	WCDMA(voice)+Bluetooth(data)	-	Yes	-
5	GSM (Data) + Bluetooth(data)	-	Yes	Yes
6	GSM (Data) + WLAN 2.4GHz (data)	Yes	Yes	Yes
7	WCDMA (Data) + Bluetooth(data)	--	Yes	Yes
8	WCDMA (Data) + WLAN 2.4GHz (data)	Yes	Yes	Yes

NOTE:

1. WIFI and BT share the same antenna, and cannot transmit simultaneously.
2. Simultaneous with every transmitter must be the same test position.
3. KDB 447498 D01, BT SAR is excluded as below table.
4. KDB 447498 D01, for handsets the test separation distance is determined by the smallest distance between the outer surface of the device and the user; which is 0mm for head SAR and 5mm for body-worn SAR.
5. According to KDB 447498 D01 4.3.1, Standalone SAR test exclusion is as follow:
For 100 MHz to 6 GHz and test separation distances ≤ 50 mm, the 1-g and 10-g SAR test exclusion thresholds are determined by the following:

$$[(\text{max. power of channel, including tune-up tolerance, mW}) / (\text{min. test separation distance, mm})] \cdot [\sqrt{f(\text{GHz})}] \leq 3.0$$
 for 1-g SAR, and ≤ 7.5 for 10-g extremity SAR³⁰, where
 - f(GHz) is the RF channel transmit frequency in GHz
 - Power and distance are rounded to the nearest mW and mm before calculation³¹
 - The result is rounded to one decimal place for comparison
 - The values 3.0 and 7.5 are referred to as numeric thresholds in step b) below
 The test exclusions are applicable only when the minimum test separation distance is ≤ 50 mm, and for transmission frequencies between 100 MHz and 6 GHz. When the minimum test separation distance is < 5 mm, a distance of 5 mm according to 4.1 f) is applied to determine SAR test exclusion.
6. If the test separation distance is < 5 mm, 5mm is used for excluded SAR calculation.
7. According to KDB 447498 D01 4.3.2, simultaneous transmission SAR test exclusion is as follow:
 - (1) Simultaneous transmission SAR test exclusion is determined for each operating configuration and exposure condition according to the reported standalone SAR of each applicable simultaneous transmitting antenna.
 - (2) Any transmitters and antennas should be considered when calculating simultaneous mode.
 - (3) For mobile phone and PC, it's the sum of all transmitters and antennas at the same mode with same position in each applicable exposure condition
 - (4) When the standalone SAR test exclusion of section 4.3.2 is applied to an antenna that transmits simultaneously with other antennas, the standalone SAR must be estimated according to the following to det

$$(\text{max. power of channel, including tune-up tolerance, mW}) / (\text{min. test separation distance, mm}) \cdot [\sqrt{f(\text{GHz})/x}] \text{ W/kg}$$
 for test separation distances ≤ 50 mm; where $x = 7.5$ for 1-g SAR, and $x = 18.75$ for 10-g SAR.

8. When the sum of SAR is larger than the limit, SAR test exclusion is determined by the SAR to peak location separation ratio. The simultaneous transmitting antennas in each operating mode and exposure condition combination must be considered one pair at a time to determine the SAR to peak location separation ratio to qualify for test exclusion. The ratio is determined by $(SAR1 + SAR2)1.5/R_i$, rounded to two decimal digits, and must be ≤ 0.04 for all antenna pairs in the configuration to qualify for 1-g SAR test exclusion.

Estimated SAR		Max Power including Tune-up Tolerance		Separation Distance (mm)	Estimated SAR (W/kg)
		dBm	mW		
BT	Head	6	3.98	0	0.165
	Body	6	3.98	5	0.165
				10	0.082

Sum of the SAR for GSM 850 &Wi-Fi & BT:

RF Exposure Conditions	Test Position	Simultaneous Transmission Scenario			Σ1-g SAR (W/Kg)	SPLSR (Yes/No)
		GSM 850	Wi-Fi DTS Band	Bluetooth		
Head (voice)	Left Touch	0.068	0.083		0.151	No
	Left Tilt	0.064	0.071		0.135	No
	Right Touch	0.097	0.048		0.145	No
	Right Tilt	0.098	0.032		0.130	No
Body-worn (voice)	Rear	0.719	0.260		0.979	No
		0.719		0.165	0.884	No
	Front	0.061	0.031		0.092	No
		0.061		0.165	0.226	No
Head (Data)	Left Touch	0.062	0.083		0.145	No
	Left Tilt	0.090	0.071		0.161	No
	Right Touch	0.127	0.048		0.175	No
	Right Tilt	0.107	0.032		0.139	No
Body-worn (Data)	Rear	0.738		0.165	0.903	No
		0.738	0.260		0.998	No
	Front	0.084		0.165	0.249	No
		0.084	0.031		0.115	No
Body-worn (Hotspot)	Edge 1	0.087	0.033		0.120	No
	Edge 2	0.053	0.071		0.124	No
	Edge 3	0.010	0.003		0.013	No
	Edge 4	0.108	0.003		0.111	No
	Edge 1	0.087		0.082	0.169	No
	Edge 2	0.053		0.082	0.135	No
	Edge 3	0.010		0.082	0.092	No
	Edge 4	0.108		0.082	0.190	No

Note:

- According to KDB 447498 D01 General RF Exposure Guidance, when the simultaneous transmission SAR is less than 1.6 W/Kg, SPLSR assessment is not required.
- SPLSR mean is “The SAR to Peak Location Separation Ratio “

Sum of the SAR for PCS 1900 & Wi-Fi & BT:

RF Exposure Conditions	Test Position	Simultaneous Transmission Scenario			Σ1-g SAR (W/Kg)	SPLSR (Yes/No)
		PCS 1900	Wi-Fi DTS Band	Bluetooth		
Head (voice)	Left Touch	0.025	0.083		0.108	No
	Left Tilt	0.033	0.071		0.104	No
	Right Touch	0.039	0.048		0.087	No
	Right Tilt	0.043	0.032		0.075	No
Body-worn (voice)	Rear	0.404	0.260		0.664	No
		0.404		0.165	0.569	No
	Front	0.032	0.031		0.063	No
		0.032		0.165	0.197	No
Head (Data)	Left Touch	0.039	0.083		0.122	No
	Left Tilt	0.047	0.071		0.118	No
	Right Touch	0.074	0.048		0.122	No
	Right Tilt	0.073	0.032		0.105	No
Body-worn (Data)	Rear	0.833		0.165	0.998	No
		0.833	0.260		1.093	No
	Front	0.036		0.165	0.201	No
		0.036	0.031		0.067	No
Body-worn (Hotspot)	Edge 1	0.050	0.033		0.083	No
	Edge 2	0.010	0.071		0.081	No
	Edge 3	0.014	0.003		0.017	No
	Edge 4	0.172	0.003		0.175	No
	Edge 1	0.050		0.082	0.132	No
	Edge 2	0.010		0.082	0.092	No
	Edge 3	0.014		0.082	0.096	No
	Edge 4	0.172		0.082	0.254	No

Note:

- According to KDB 447498 D01 General RF Exposure Guidance, when the simultaneous transmission SAR is less than 1.6 W/Kg, SPLSR assessment is not required.
- SPLSR mean is "The SAR to Peak Location Separation Ratio "

Sum of the SAR for WCDMA Band II&Wi-Fi & BT:

RF Exposure Conditions	Test Position	Simultaneous Transmission Scenario			Σ1-g SAR (W/Kg)	SPLSR (Yes/No)
		WCDMA Band II	Wi-Fi DTS Band	Bluetooth		
Head	Left Touch	0.032	0.083		0.115	No
	Left Tilt	0.036	0.071		0.107	No
	Right Touch	0.044	0.048		0.092	No
	Right Tilt	0.057	0.032		0.089	No
Body-worn	Rear	0.769	0.260		1.029	No
	Front	0.046	0.031		0.077	No
	Edge 1	0.035	0.033		0.068	No
	Edge 2	0.008	0.071		0.079	No
	Edge 3	0.010	0.003		0.013	No
	Edge 4	0.099	0.003		0.102	No
	Rear	0.769		0.165	0.934	No
	Front	0.046		0.165	0.211	No
	Edge 1	0.035		0.082	0.117	No
	Edge 2	0.008		0.082	0.090	No
	Edge 3	0.010		0.082	0.092	No
	Edge 4	0.099		0.082	0.181	No

Note:

- According to KDB 447498 D01 General RF Exposure Guidance, when the simultaneous transmission SAR is less than 1.6 W/Kg, SPLSR assessment is not required.
- SPLSR mean is "The SAR to Peak Location Separation Ratio "

Sum of the SAR for WCDMA Band V & Wi-Fi & BT:

RF Exposure Conditions	Test Position	Simultaneous Transmission Scenario			Σ1-g SAR (W/Kg)	SPLSR (Yes/No)
		WCDMA Band V	Wi-Fi DTS Band	Bluetooth		
Head	Left Touch	0.051	0.083		0.134	No
	Left Tilt	0.054	0.071		0.125	No
	Right Touch	0.066	0.048		0.114	No
	Right Tilt	0.074	0.032		0.106	No
Body-worn	Rear	1.225	0.260		1.485	No
	Front	0.069	0.031		0.100	No
	Edge 1	0.037	0.033		0.070	No
	Edge 2	0.031	0.071		0.102	No
	Edge 3	0.006	0.003		0.009	No
	Edge 4	0.050	0.003		0.053	No
	Rear	1.225		0.165	1.390	No
	Front	0.069		0.165	0.234	No
	Edge 1	0.037		0.082	0.119	No
	Edge 2	0.031		0.082	0.113	No
	Edge 3	0.006		0.082	0.088	No
	Edge 4	0.050		0.082	0.132	No

Note:

- According to KDB 447498 D01 General RF Exposure Guidance, when the simultaneous transmission SAR is less than 1.6 W/Kg, SPLSR assessment is not required.
- SPLSR mean is "The SAR to Peak Location Separation Ratio "

APPENDIX A. SAR SYSTEM CHECK DATA

Test Laboratory: AGC Lab

Date: Mar. 21,2017

System Check Head 835 MHz

DUT: Dipole 835 MHz Type: SID 835

Communication System CW; Communication System Band: D835 (835.0 MHz); Duty Cycle: 1:1; Conv.F=5.72

Frequency: 835 MHz; Medium parameters used: $f = 835$ MHz; $\sigma = 0.89$ mho/m; $\epsilon_r = 41.97$; $\rho = 1000$ kg/m³ ;

Phantom section: Flat Section; Input Power=18dBm

Ambient temperature (°C):21.4, Liquid temperature (°C): 21.2

SATIMO Configuration

- Probe: SSE5; Calibrated: 12/05/2016; Serial No.: SN 14/16 EP308
- Sensor-Surface: 4mm (Mechanical Surface Detection)
- Phantom: SAM twin phantom
- Measurement SW: OpenSAR V4_02_32

Configuration/System Check 835MHz Head/Area Scan: Measurement grid: dx=8mm, dy=8mm

Configuration/System Check 835MHz Head/Zoom Scan: Measurement grid: dx=8mm,dy=8mm, dz=5mm

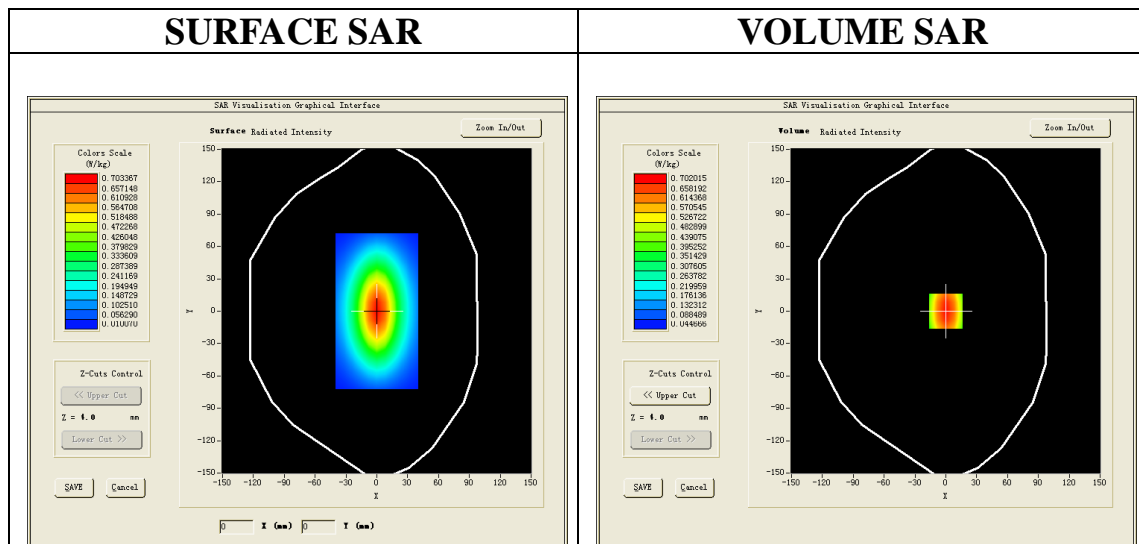

Maximum location: X=1.00, Y=1.00

SAR Peak: 1.05W/kg

SAR 10g (W/Kg)	0.411023
SAR 1g (W/Kg)	0.667591

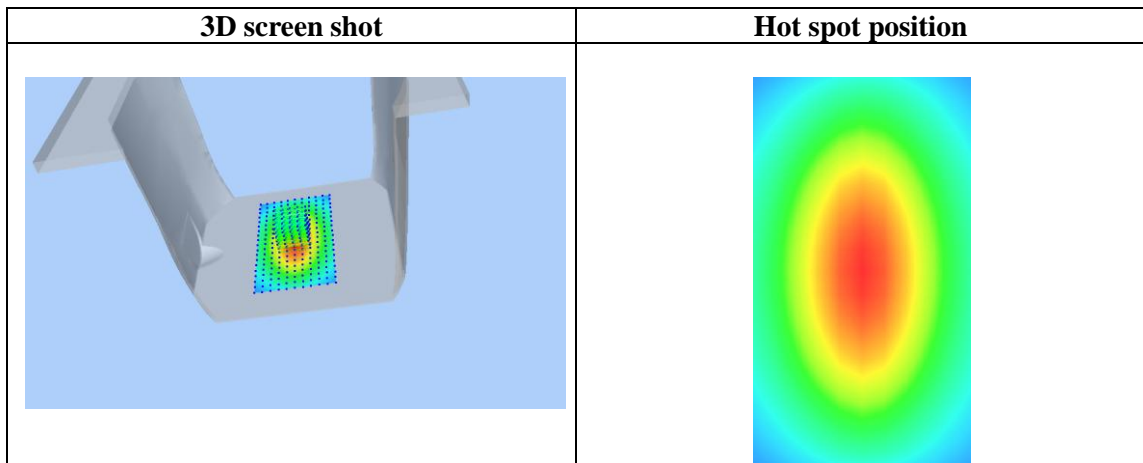
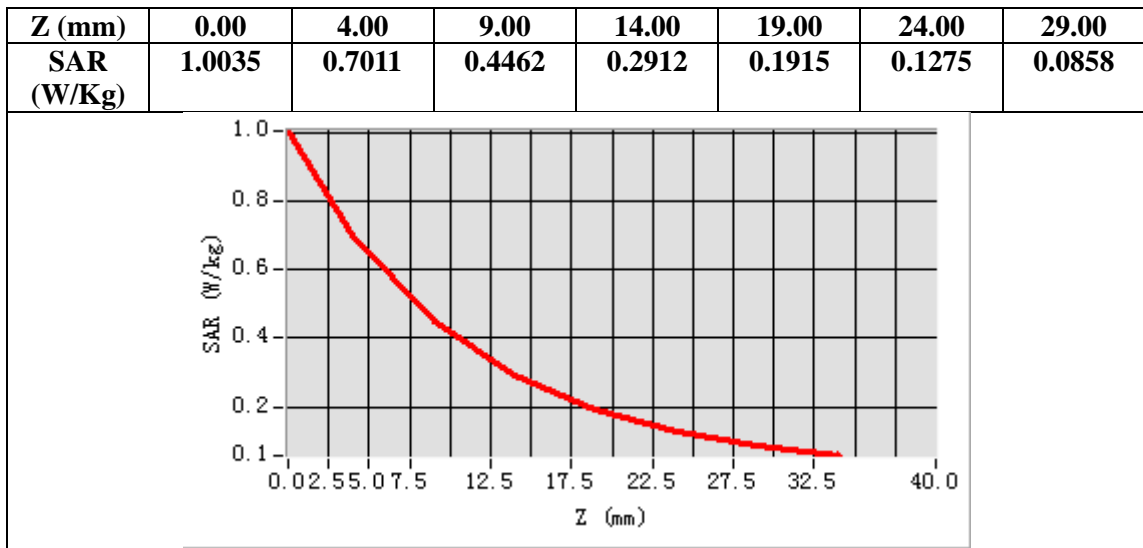

Test Laboratory: AGC Lab
System Check Body 835 MHz

Date: Mar. 21,2017

DUT: Dipole 835 MHz Type: SID 835

Communication System CW; Communication System Band: D835 (835.0 MHz); Duty Cycle: 1:1; Conv.F=5.94
Frequency: 835 MHz; Medium parameters used: $f = 835$ MHz; $\sigma = 0.95$ mho/m; $\epsilon_r = 55.41$; $\rho = 1000$ kg/m³ ;
Phantom section: Flat Section; Input Power=18dBm
Ambient temperature (°C):21.4, Liquid temperature (°C): 21.3

SATIMO Configuration

- Probe: SSE5; Calibrated: 12/05/2016; Serial No.: SN 14/16 EP308
- Sensor-Surface: 4mm (Mechanical Surface Detection)
- Phantom: SAM twin phantom
- Measurement SW: OpenSAR V4_02_32

Configuration/System Check 835MHz Body/Area Scan: Measurement grid: dx=8mm, dy=8mm

Configuration/System Check 835MHz Body/Zoom Scan: Measurement grid: dx=8mm,dy=8mm, dz=5mm

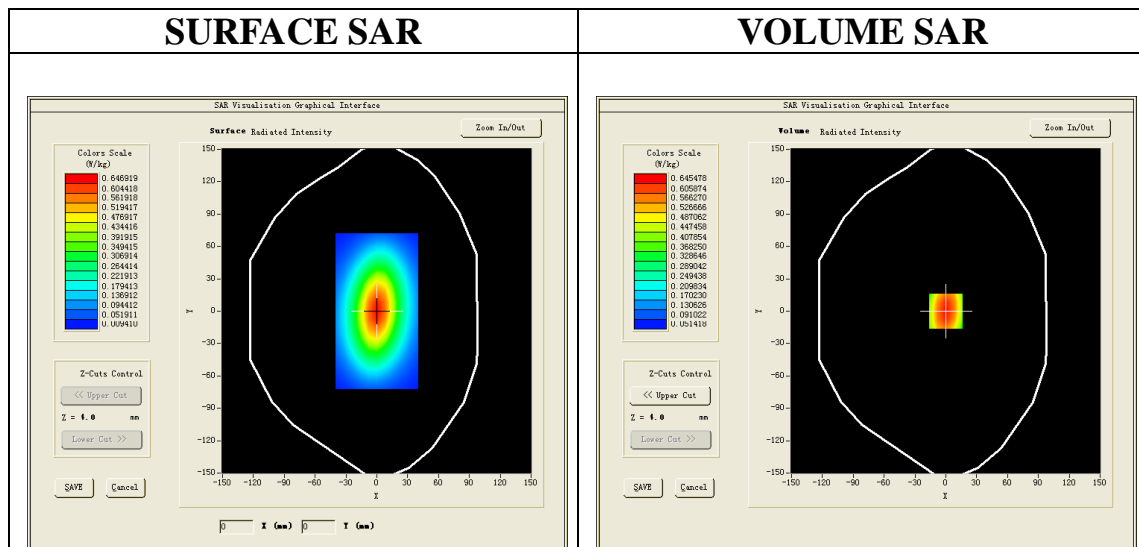

Maximum location: X=1.00, Y=0.00
SAR Peak: 0.91 W/kg

SAR 10g (W/Kg)	0.399523
SAR 1g (W/Kg)	0.622053

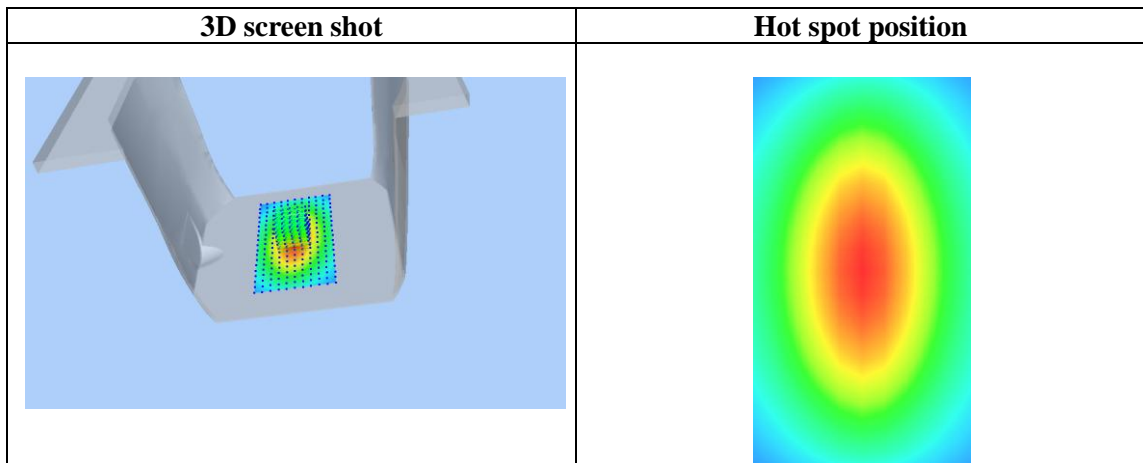
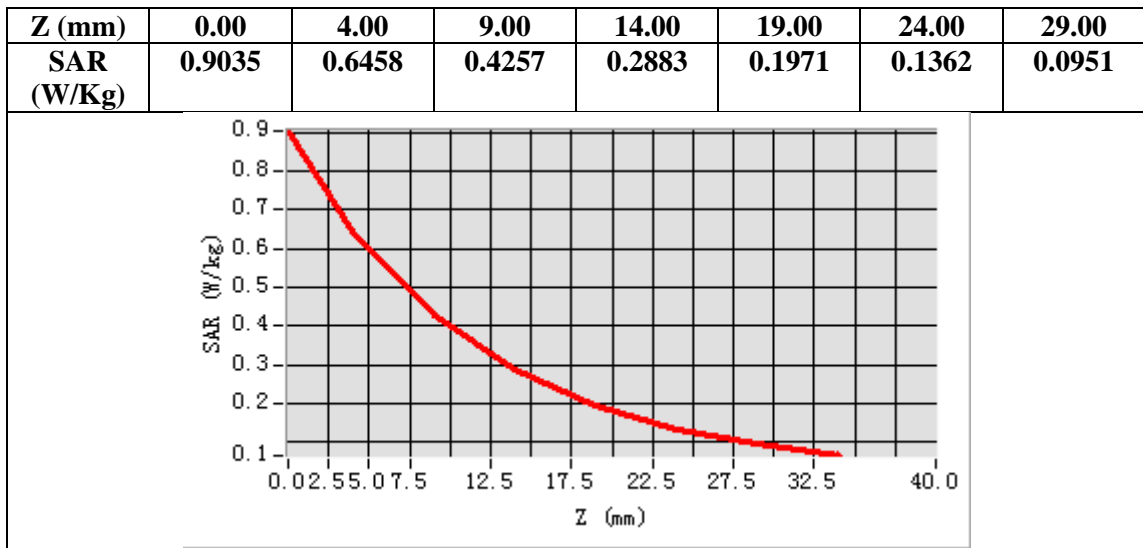

Test Laboratory: AGC Lab
System Check Head 1900MHz

Date: Mar. 22,2017

DUT: Dipole 1900 MHz; Type: SID 1900

Communication System: CW; Communication System Band: D1900 (1900.0 MHz); Duty Cycle:1:1; Conv.F=5.74
Frequency: 1900 MHz; Medium parameters used: $f = 1900$ MHz; $\sigma = 1.40$ mho/m; $\epsilon_r = 40.42$; $\rho = 1000$ kg/m³ ;
Phantom section: Flat Section; Input Power=18dBm
Ambient temperature (°C):21.4, Liquid temperature (°C): 20.2

SATIMO Configuration:

- Probe: SSE5; Calibrated: 12/05/2016; Serial No.: SN 14/16 EP308
- Sensor-Surface: 4mm (Mechanical Surface Detection)
- Phantom: SAM twin phantom
- Measurement SW: OpenSAR V4_02_32

Configuration/System Check 1900MHz Head/Area Scan: Measurement grid: dx=8mm, dy=8mm

Configuration/System Check 1900MHz Head/Zoom Scan: Measurement grid: dx=8mm,dy=8mm, dz=5mm

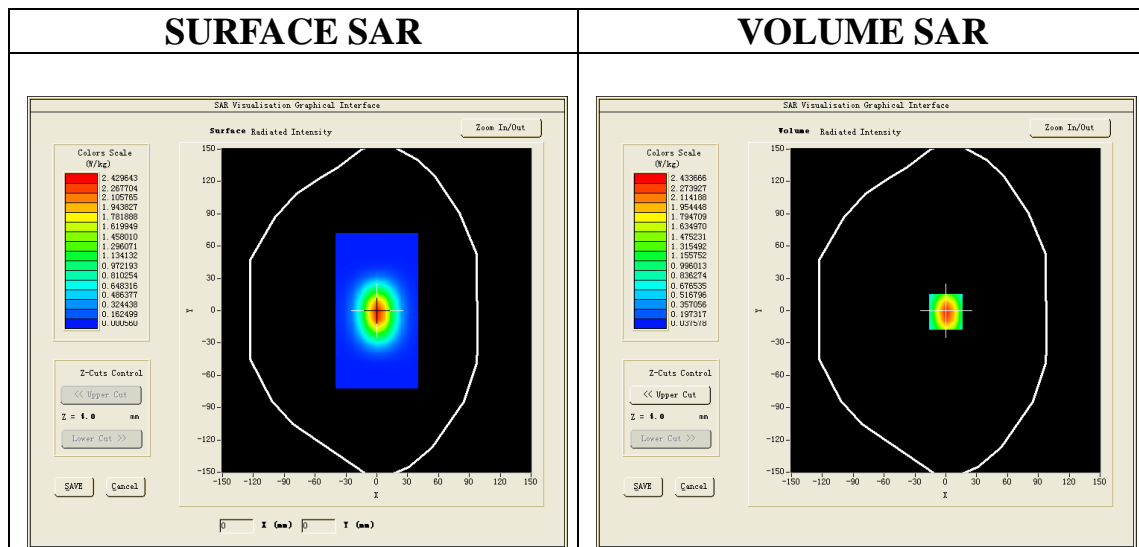

Maximum location: X=0.00, Y=-1.00
SAR Peak: 3.89 W/kg

SAR 10g (W/Kg)	1.356652
SAR 1g (W/Kg)	2.463688

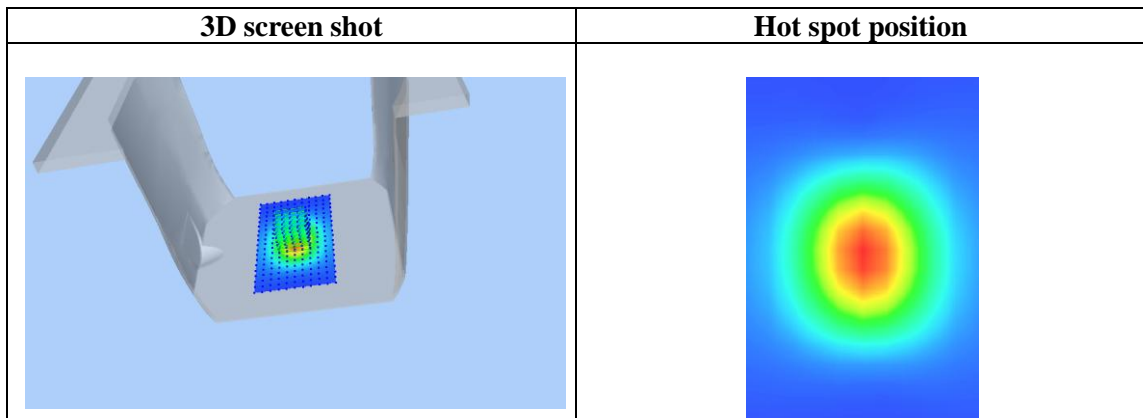
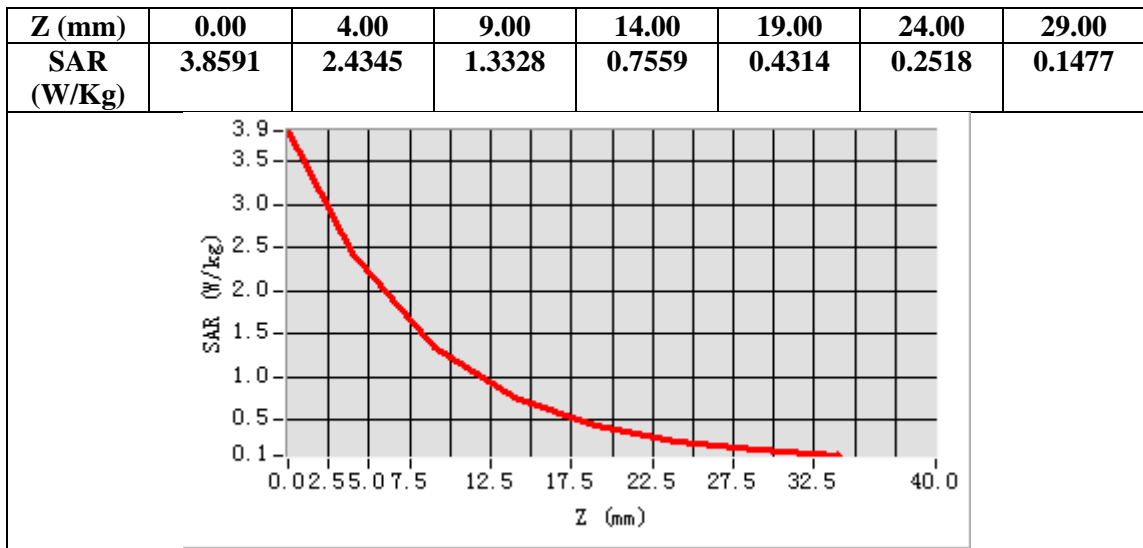

Test Laboratory: AGC Lab
System Check Body 1900MHz
DUT: Dipole 1900 MHz; Type: SID 1900

Date: Mar. 22,2017

Communication System: CW; Communication System Band: D1900 (1900.0 MHz); Duty Cycle:1:1; Conv.F=5.90
Frequency: 1900 MHz; Medium parameters used: $f = 1900$ MHz; $\sigma = 1.51$ mho/m; $\epsilon_r = 53.55$; $\rho = 1000$ kg/m³ ;
Phantom section: Flat Section; Input Power=18dBm
Ambient temperature (°C):21.4, Liquid temperature (°C): 20.5

SATIMO Configuration:

- Probe: SSE5; Calibrated: 12/05/2016; Serial No.: SN 14/16 EP308
- Sensor-Surface: 4mm (Mechanical Surface Detection)
- Phantom: SAM twin phantom
- Measurement SW: OpenSAR V4_02_32

Configuration/System Check 1900MHz Body/Area Scan: Measurement grid: dx=8mm, dy=8mm

Configuration/System Check 1900MHz Body/Zoom Scan: Measurement grid: dx=8mm,dy=8mm, dz=5mm

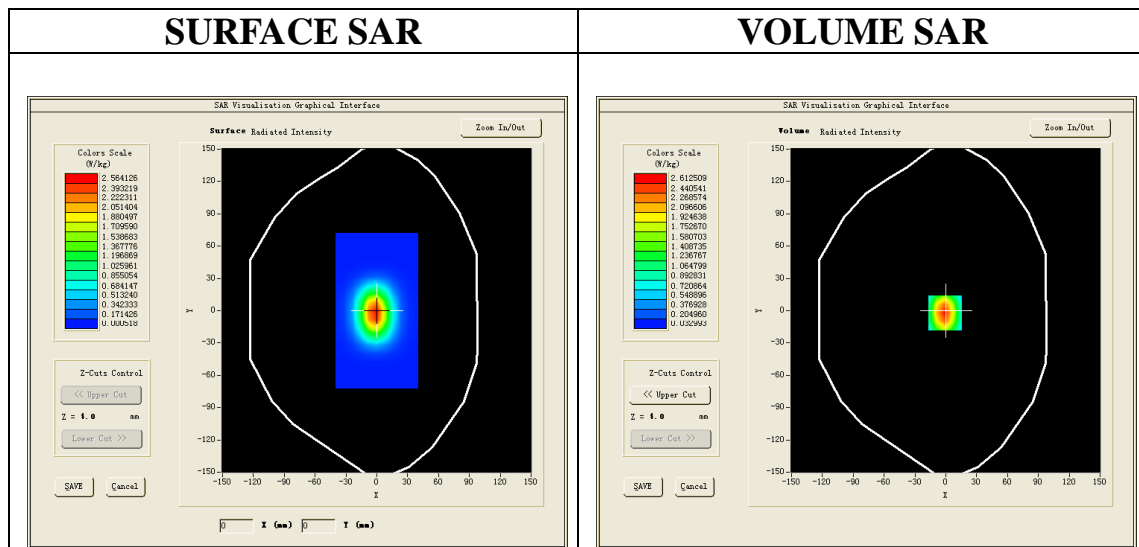

Maximum location: X=-1.00, Y=-2.00
SAR Peak: 4.18 W/kg

SAR 10g (W/Kg)	1.246592
SAR 1g (W/Kg)	2.471364

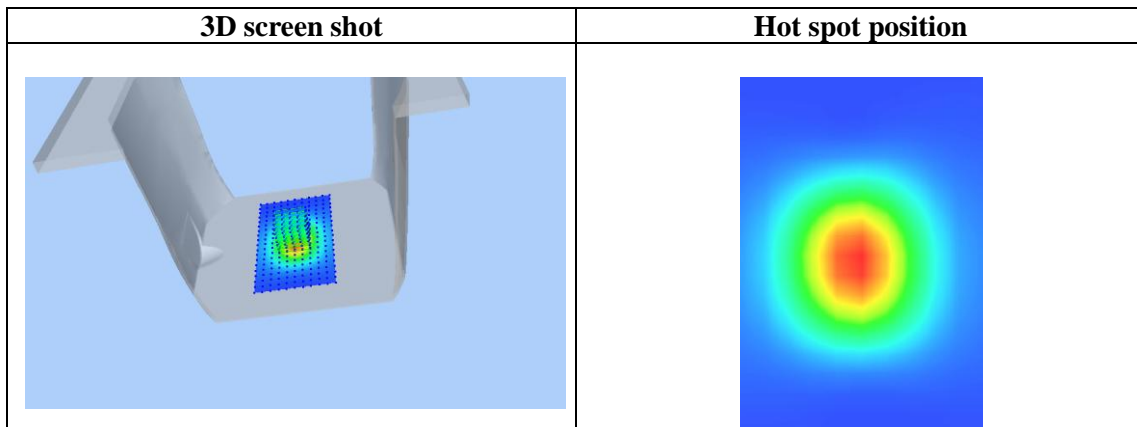
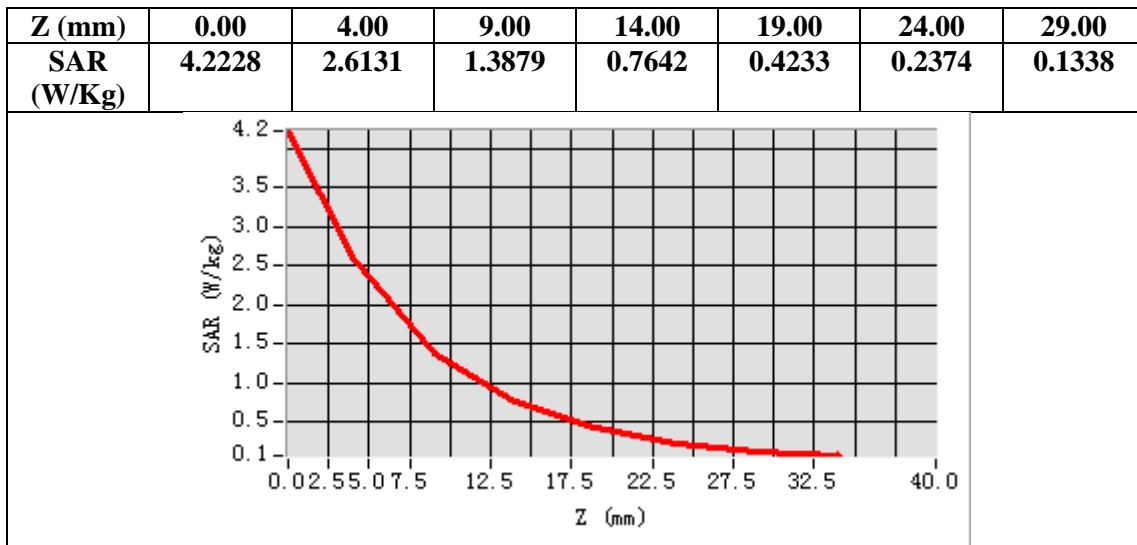

Test Laboratory: AGC Lab
System Check Head 2450 MHz

Date: Mar. 24,2017

DUT: Dipole 2450 MHz Type: SID 2450

Communication System CW; Communication System Band: D2450 (2450.0 MHz); Duty Cycle: 1:1; Conv.F=5.19
Frequency: 2450 MHz; Medium parameters used: $f = 2450$ MHz; $\sigma = 1.77$ mho/m; $\epsilon_r = 39.98$; $\rho = 1000$ kg/m³ ;
Phantom section: Flat Section; Input Power=18dBm
Ambient temperature (°C):22.2, Liquid temperature (°C): 21.8

SATIMO Configuration

- Probe: SSE5; Calibrated: 12/05/2016; Serial No.: SN 14/16 EP308
- Sensor-Surface: 4mm (Mechanical Surface Detection)
- Phantom: SAM twin phantom
- Measurement SW: OpenSAR V4_02_32

Configuration/System Check 2450MHz Head/Area Scan: Measurement grid: dx=8mm, dy=8mm

Configuration/System Check 2450MHz Head/Zoom Scan: Measurement grid: dx=5mm,dy=5mm, dz=5mm

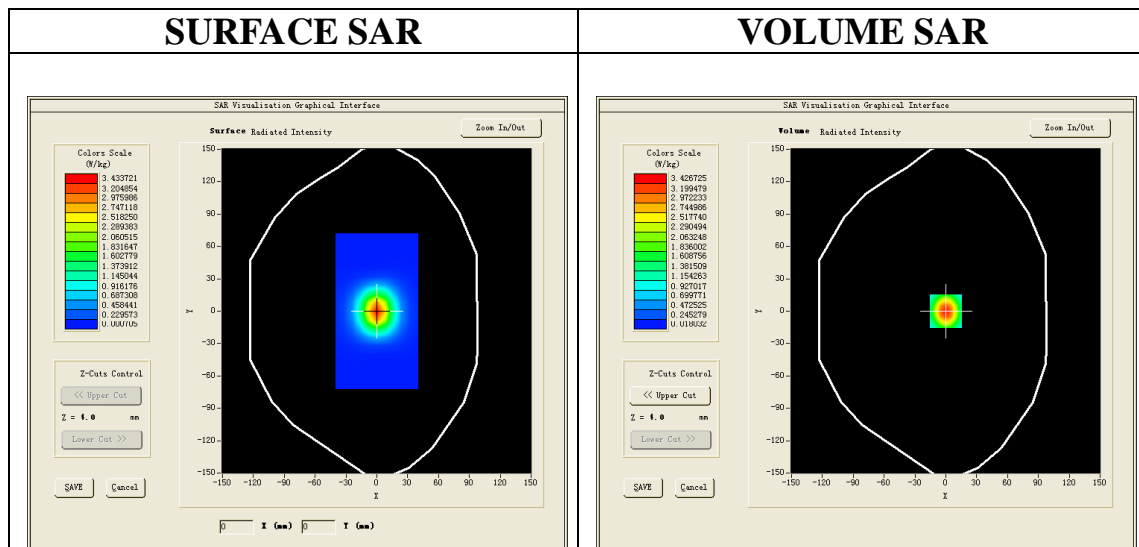

Maximum location: X=0.00, Y=0.00
SAR Peak: 5.91 W/kg

SAR 10g (W/Kg)	1.492013
SAR 1g (W/Kg)	3.184102

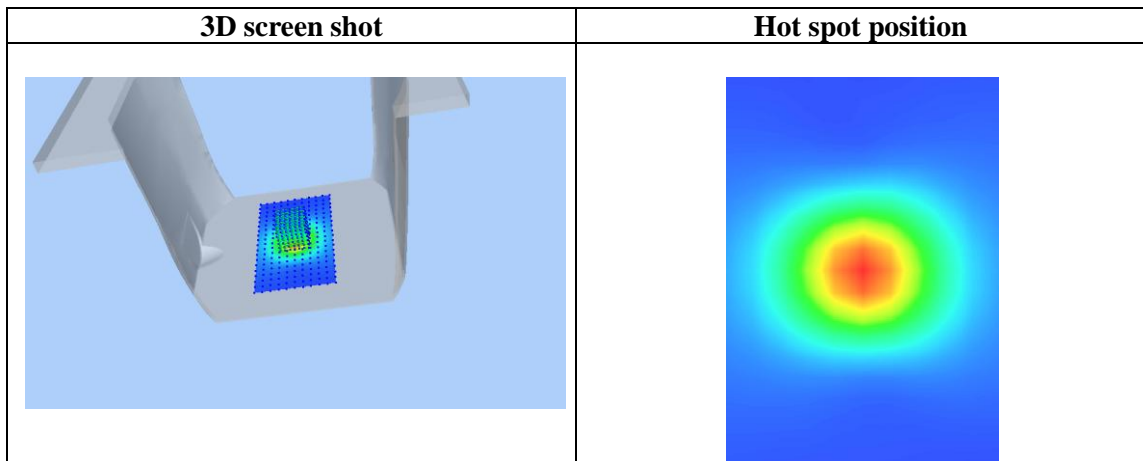
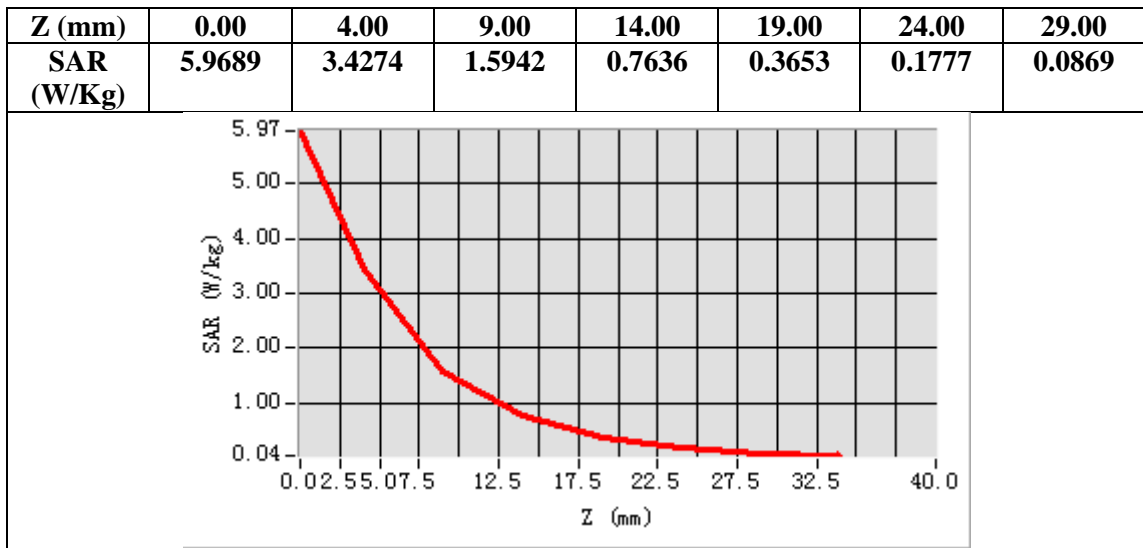

Test Laboratory: AGC Lab
System Check Body 2450 MHz

Date: Mar. 24,2017

DUT: Dipole 2450 MHz Type: SID 2450

Communication System CW; Communication System Band: D2450 (2450.0 MHz); Duty Cycle: 1:1; Conv.F=5.33
Frequency: 2450 MHz; Medium parameters used: $f = 2450$ MHz; $\sigma = 1.93$ mho/m; $\epsilon_r = 53.96$; $\rho = 1000$ kg/m³ ;
Phantom section: Flat Section; Input Power=18dBm
Ambient temperature (°C):22.2, Liquid temperature (°C): 21.5

SATIMO Configuration

- Probe: SSE5; Calibrated: 12/05/2016; Serial No.: SN 14/16 EP308
- Sensor-Surface: 4mm (Mechanical Surface Detection)
- Phantom: SAM twin phantom
- Measurement SW: OpenSAR V4_02_32

Configuration/System Check 2450MHz Body/Area Scan: Measurement grid: dx=8mm, dy=8mm

Configuration/System Check 2450MHz Body/Zoom Scan: Measurement grid: dx=5mm,dy=5mm, dz=5mm

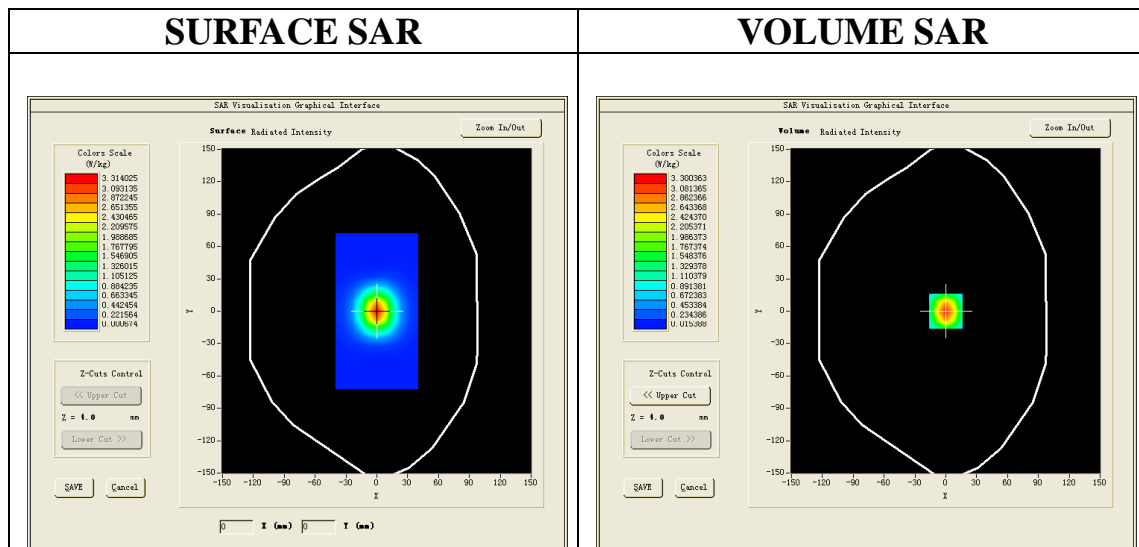

Maximum location: X=0.00, Y=0.00
SAR Peak: 5.71 W/kg

SAR 10g (W/Kg)	1.429536
SAR 1g (W/Kg)	3.110235

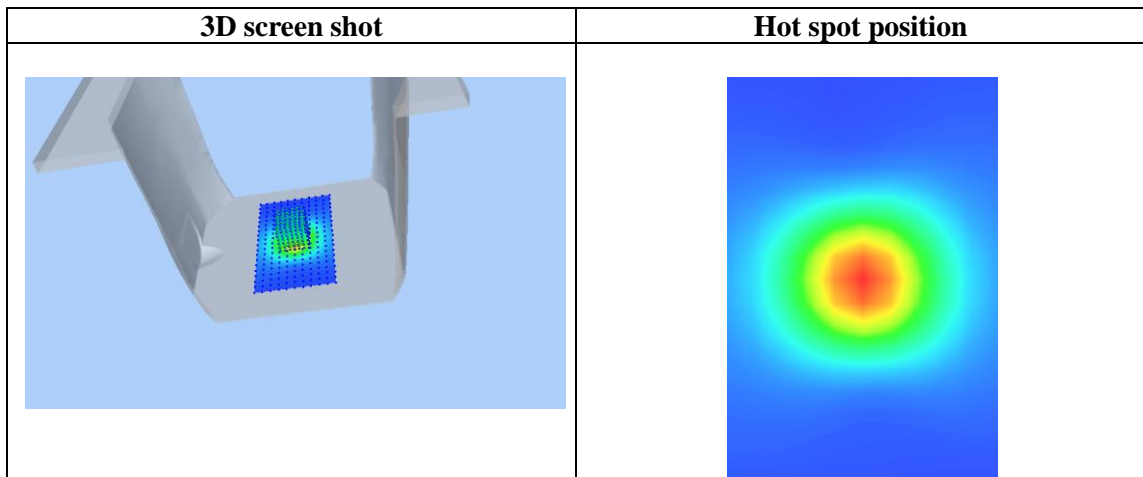
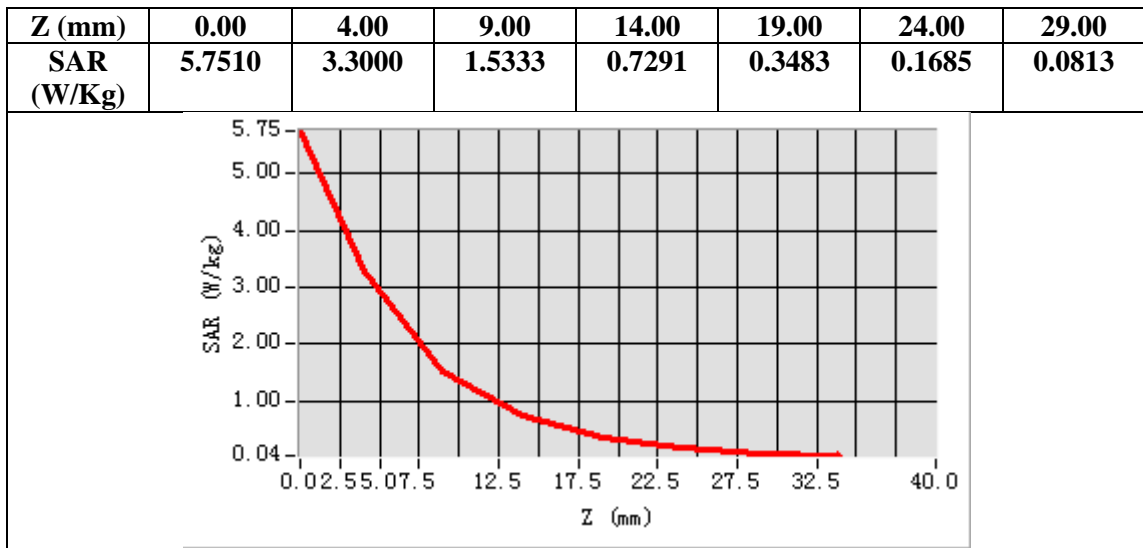

APPENDIX B. SAR MEASUREMENT DATA

Test Laboratory: AGC Lab
GSM 850 Mid- Tilt-Right <SIM 1>
DUT: Smartphone-Miracle 6.0 S; Type: Miracle 6.0 S

Date: Mar. 21,2017

Communication System: Generic GSM; Communication System Band: GSM 850; Duty Cycle: 1:8.3; Conv.F=5.72;
Frequency: 836.6 MHz; Medium parameters used: $f = 835$ MHz; $\sigma = 0.89$ mho/m; $\epsilon_r = 41.52$; $\rho = 1000$ kg/m³ ;
Phantom section: Right Section
Ambient temperature (°C): 21.4, Liquid temperature (°C): 21.2

SATIMO Configuration:

- Probe: SSE5; Calibrated: 12/05/2016; Serial No.: SN 14/16 EP308
- Sensor-Surface: 4mm (Mechanical Surface Detection)
- Phantom: SAM twin phantom
- Measurement SW: OpenSAR V4_02_32

Configuration/GSM 850 Mid-Tilt-Right/Area Scan: Measurement grid: dx=8mm, dy=8mm
Configuration/GSM 850 Mid-Tilt-Right/Zoom Scan: Measurement grid: dx=8mm,dy=8mm, dz=5mm;

Area Scan	sam_direct_droit2_surf8mm.txt
ZoomScan	5x5x7,dx=8mm dy=8mm dz=5mm,Complete
Phantom	Right head
Device Position	Tilt
Band	GSM 850
Channels	Middle
Signal	TDMA (Crest factor: 8.0)

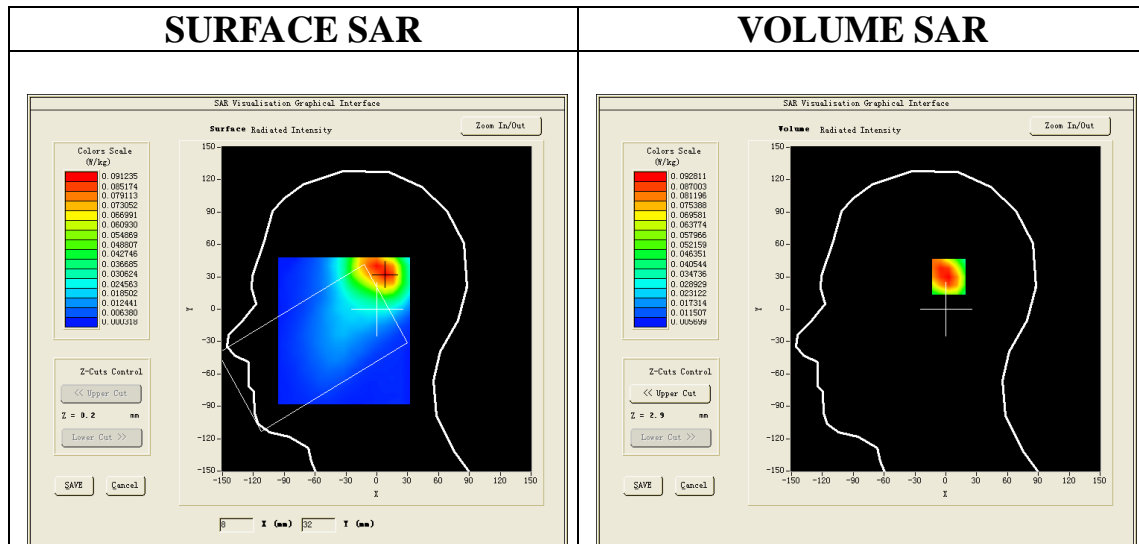

Maximum location: X=8.00, Y=33.00
SAR Peak: 0.14 W/kg

SAR 10g (W/Kg)	0.057192
SAR 1g (W/Kg)	0.089853

Z (mm)	0.00	4.00	9.00	14.00	19.00	24.00	29.00
SAR (W/Kg)	0.1256	0.0928	0.0639	0.0393	0.0297	0.0202	0.0148

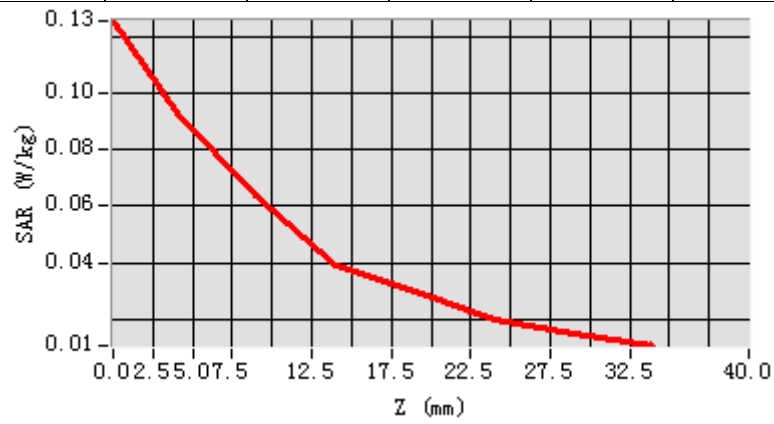

3D screen shot

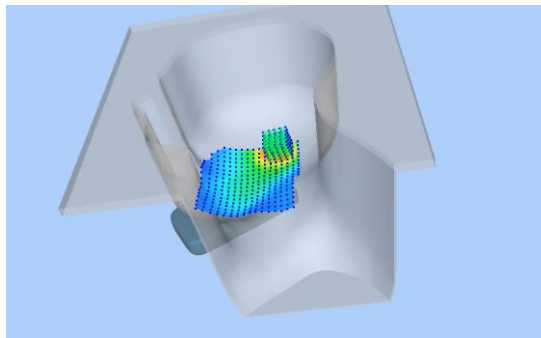

Hot spot position

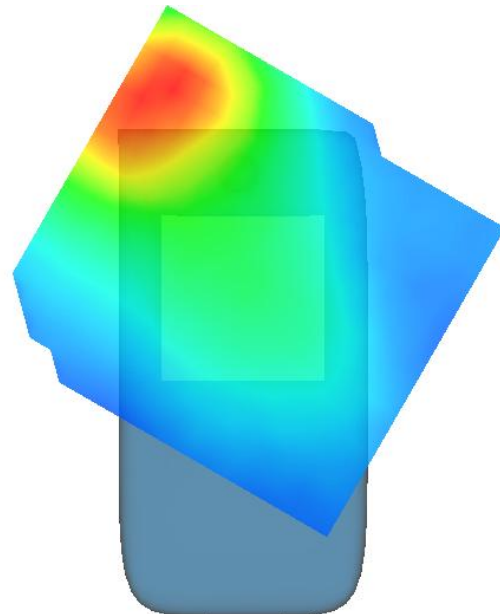

Test Laboratory: AGC Lab
GSM 850 Mid- Body- Back (MS)<SIM 1>
DUT: Smartphone-Miracle 6.0 S; Type: Miracle 6.0 S

Date: Mar. 21,2017

Communication System: Generic GSM; Communication System Band: GSM 850; Duty Cycle: 1:8.3; Conv.F=5.94;
Frequency: 836.6 MHz; Medium parameters used: $f = 835$ MHz; $\sigma = 0.96$ mho/m; $\epsilon_r = 55.03$; $\rho = 1000$ kg/m³ ;
Phantom section: Flat Section
Ambient temperature (°C): 21.4, Liquid temperature (°C): 21.3

SATIMO Configuration:

- Probe: SSE5; Calibrated: 12/05/2016; Serial No.: SN 14/16 EP308
- Sensor-Surface: 4mm (Mechanical Surface Detection)
- Phantom: SAM twin phantom
- Measurement SW: OpenSAR V4_02_32

Configuration/GSM 850 Mid-Body-Back/Area Scan: Measurement grid: dx=8mm, dy=8mm
Configuration/GSM 850 Mid-Body-Back/Zoom Scan: Measurement grid: dx=8mm,dy=8mm, dz=5mm;

Area Scan	sam_direct_droit2_surf8mm.txt
ZoomScan	5x5x7,dx=8mm dy=8mm dz=5mm,Complete
Phantom	Validation plane
Device Position	Body Back
Band	GSM 850
Channels	Middle
Signal	TDMA (Crest factor: 8.0)

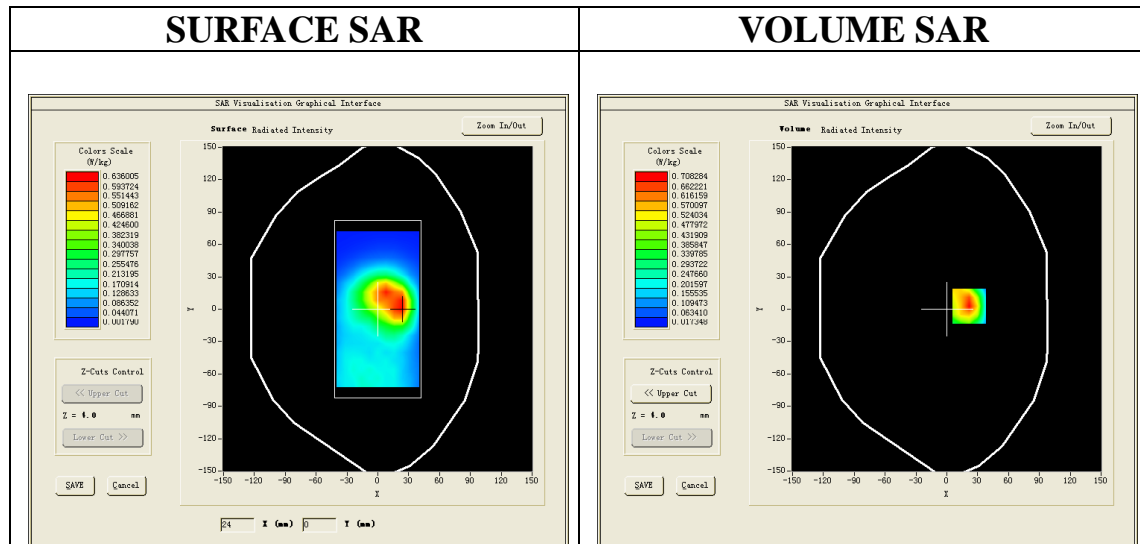

Maximum location: X=22.00, Y=3.00

SAR Peak: 1.11 W/kg

SAR 10g (W/Kg)	0.376895
SAR 1g (W/Kg)	0.659392

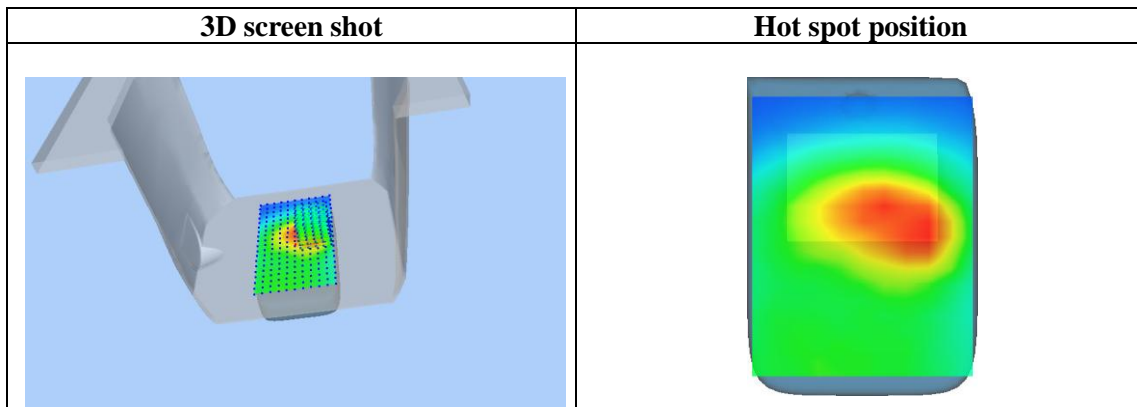
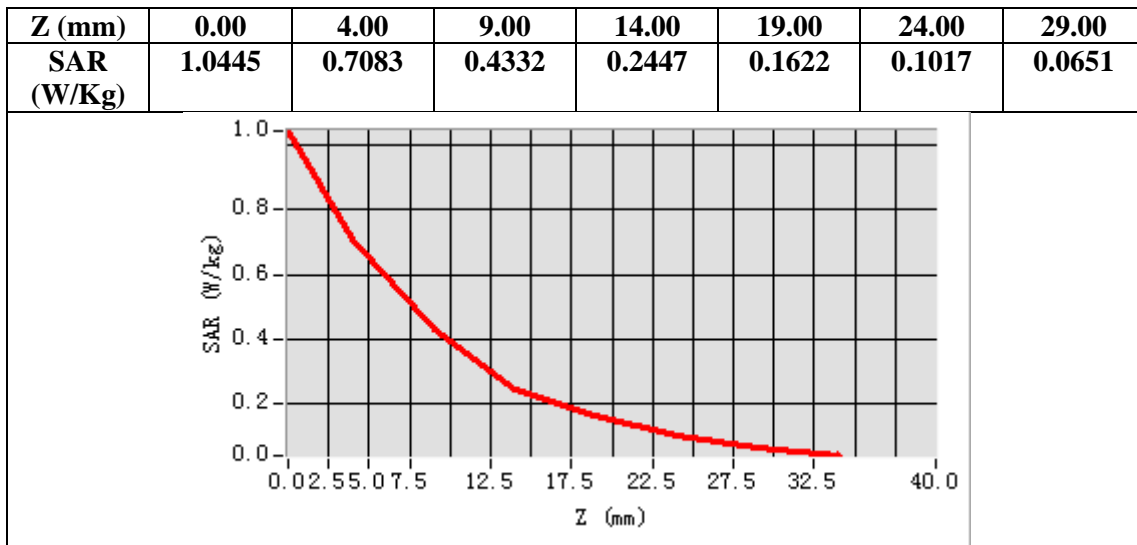

Test Laboratory: AGC Lab
GPRS 850 Mid- Touch-Right (2up) <SIM 1>
DUT: Smartphone-Miracle 6.0 S; Type: Miracle 6.0 S

Date: Mar. 21,2017

Communication System: GPRS-2 Slot; Communication System Band: GSM 850; Duty Cycle: 1:4.2; Conv.F=5.72
Frequency: 836.6 MHz; Medium parameters used: $f = 835$ MHz; $\sigma = 0.89$ mho/m; $\epsilon_r = 41.52$; $\rho = 1000$ kg/m³ ;
Phantom section: Right Section
Ambient temperature (°C): 21.4, Liquid temperature (°C): 21.2

SATIMO Configuration:

- Probe: SSE5; Calibrated: 12/05/2016; Serial No.: SN 14/16 EP308
- Sensor-Surface: 4mm (Mechanical Surface Detection)
- Phantom: SAM twin phantom
- Measurement SW: OpenSAR V4_02_32

Configuration/GPRS 850 Mid-Touch-Right/Area Scan: Measurement grid: dx=8mm, dy=8mm
Configuration/GPRS 850 Mid-Touch-Right/Zoom Scan: Measurement grid: dx=8mm,dy=8mm, dz=5mm;

Area Scan	sam_direct_droit2_surf8mm.txt
Zoom Scan	5x5x7,dx=8mm dy=8mm dz=5mm,Complete
Phantom	Right head
Device Position	Cheek
Band	GSM 850
Channels	Middle
Signal	TDMA (Crest factor: 4.0)

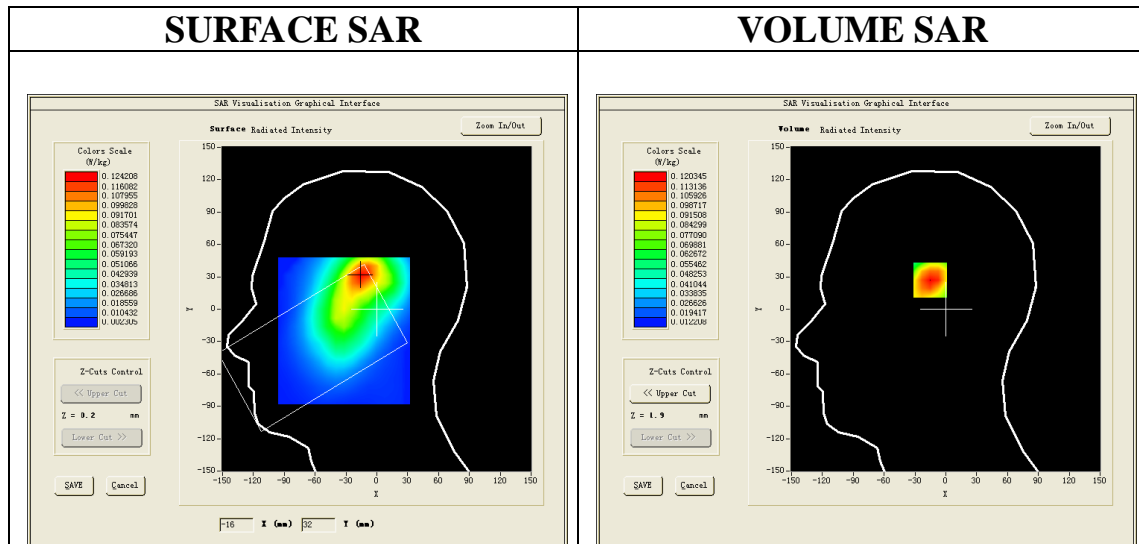

Maximum location: X=-14.00, Y=32.00

SAR Peak: 0.16 W/kg

SAR 10g (W/Kg)	0.077664
SAR 1g (W/Kg)	0.114412

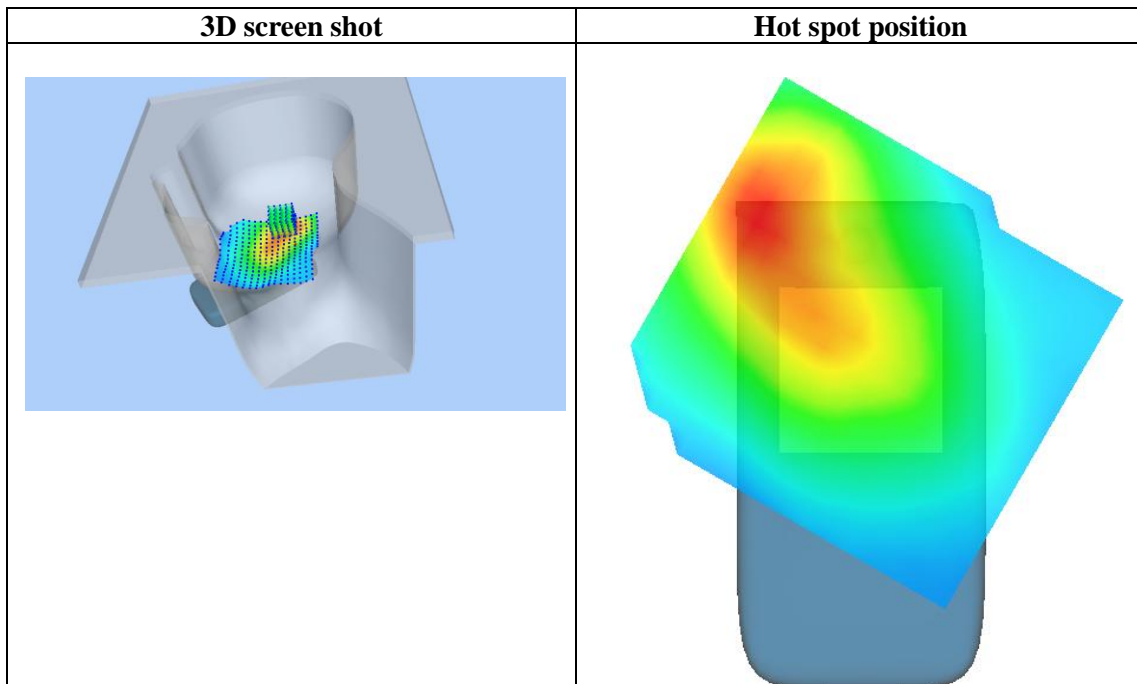
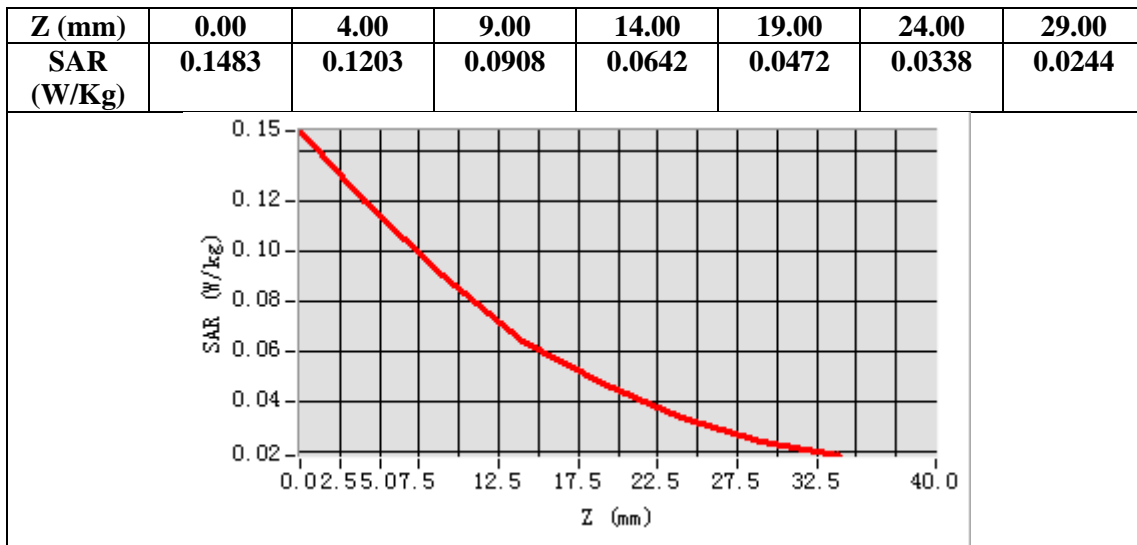

Test Laboratory: AGC Lab
GPRS 850 Mid- Body- Back (2up) <SIM 1>
DUT: Smartphone-Miracle 6.0 S; Type: Miracle 6.0 S

Date: Mar. 21,2017

Communication System: GPRS-2 Slot; Communication System Band: GSM 850; Duty Cycle: 1:4.2; Conv.F=5.94;
Frequency: 836.6 MHz; Medium parameters used: $f = 835$ MHz; $\sigma = 0.96$ mho/m; $\epsilon_r = 55.03$; $\rho = 1000$ kg/m³ ;
Phantom section: Flat Section
Ambient temperature (°C): 21.4, Liquid temperature (°C): 21.3

SATIMO Configuration:

- Probe: SSE5; Calibrated: 12/05/2016; Serial No.: SN 14/16 EP308
- Sensor-Surface: 4mm (Mechanical Surface Detection)
- Phantom: SAM twin phantom
- Measurement SW: OpenSAR V4_02_32

Configuration/GPRS 850 Mid-Body-Back/Area Scan: Measurement grid: dx=8mm, dy=8mm
Configuration/GPRS 850 Mid-Body-Back/Zoom Scan: Measurement grid: dx=8mm,dy=8mm, dz=5mm;

Area Scan	sam_direct_droit2_surf8mm.txt
Zoom Scan	5x5x7,dx=8mm dy=8mm dz=5mm,Complete
Phantom	Validation plane
Device Position	Body Back
Band	GSM 850
Channels	Middle
Signal	TDMA (Crest factor: 4.0)

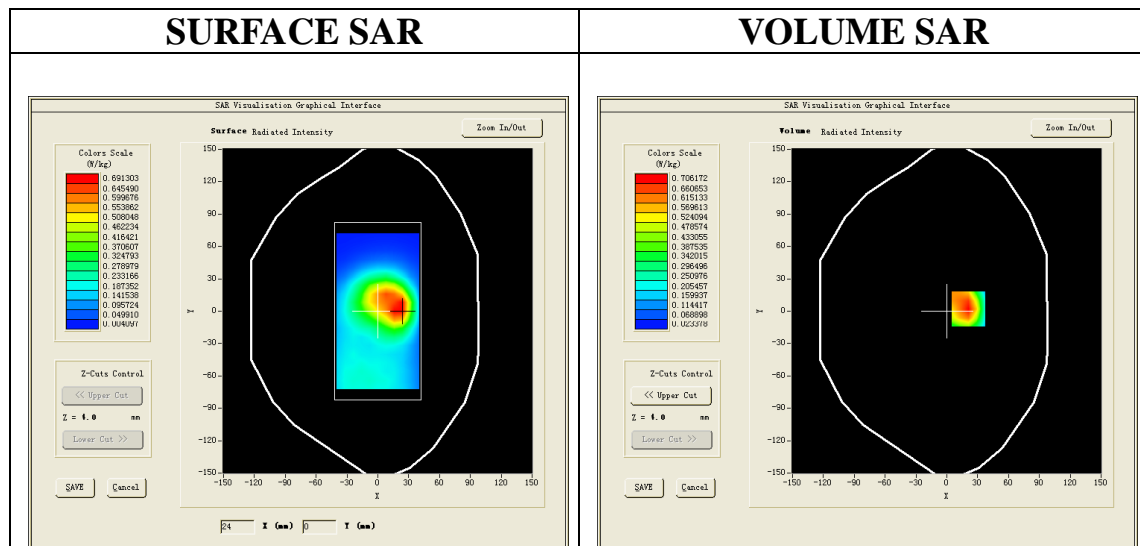

Maximum location: X=21.00, Y=2.00

SAR Peak: 0.99 W/kg

SAR 10g (W/Kg)	0.409957
SAR 1g (W/Kg)	0.662498

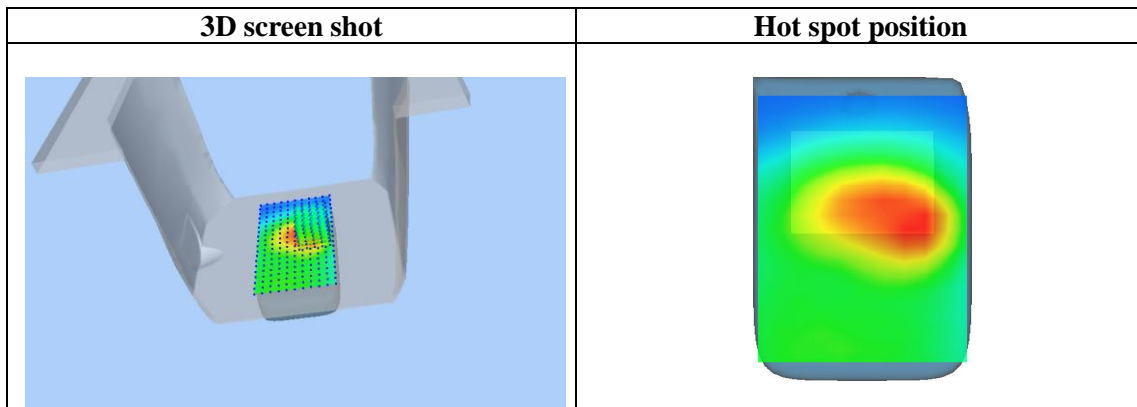
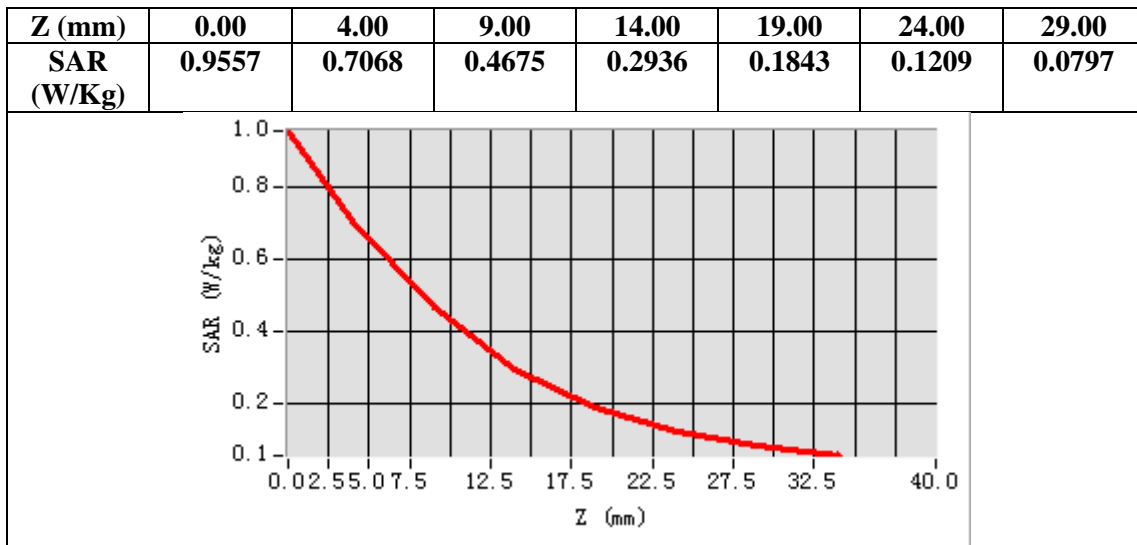

Test Laboratory: AGC Lab
GPRS 850 Mid- Touch-Right (2up) <SIM 2>
DUT: Smartphone-Miracle 6.0 S; Type: Miracle 6.0 S

Date: Mar. 21,2017

Communication System: GPRS-2 Slot; Communication System Band: GSM 850; Duty Cycle: 1:4.2; Conv.F=5.72
Frequency: 836.6 MHz; Medium parameters used: $f = 835$ MHz; $\sigma = 0.89$ mho/m; $\epsilon_r = 41.52$; $\rho = 1000$ kg/m³ ;
Phantom section: Right Section
Ambient temperature (°C): 21.4, Liquid temperature (°C): 21.2

SATIMO Configuration:

- Probe: SSE5; Calibrated: 12/05/2016; Serial No.: SN 14/16 EP308
- Sensor-Surface: 4mm (Mechanical Surface Detection)
- Phantom: SAM twin phantom
- Measurement SW: OpenSAR V4_02_32

Configuration/GPRS 850 Mid-Touch-Right/Area Scan: Measurement grid: dx=8mm, dy=8mm
Configuration/GPRS 850 Mid-Touch-Right/Zoom Scan: Measurement grid: dx=8mm,dy=8mm, dz=5mm;

Area Scan	sam_direct_droit2_surf8mm.txt
Zoom Scan	5x5x7,dx=8mm dy=8mm dz=5mm,Complete
Phantom	Right head
Device Position	Cheek
Band	GSM 850
Channels	Middle
Signal	TDMA (Crest factor: 4.0)

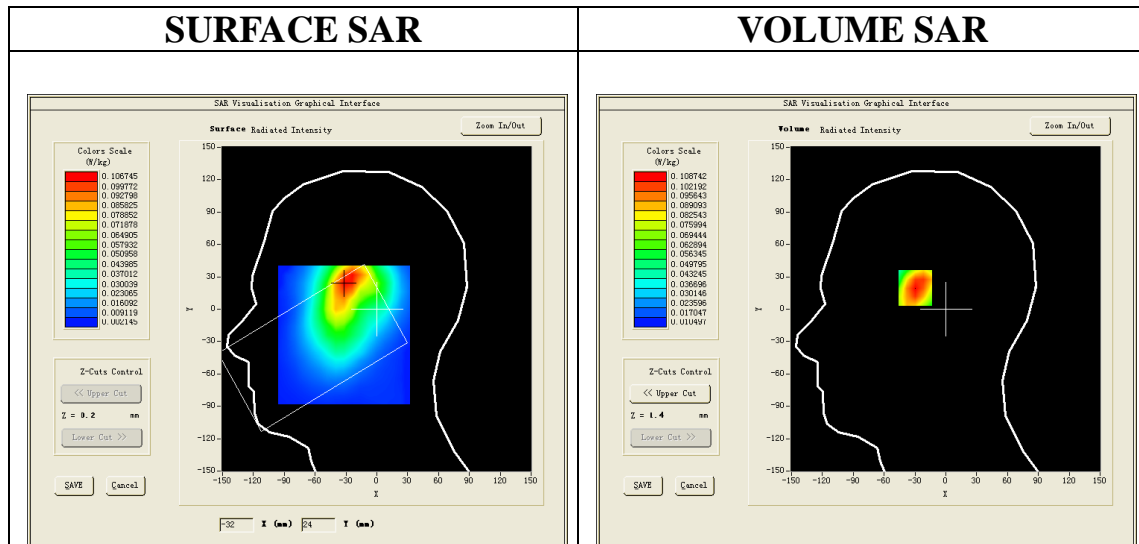

Maximum location: X=-30.00, Y=25.00

SAR Peak: 0.15 W/kg

SAR 10g (W/Kg)	0.069913
SAR 1g (W/Kg)	0.104058

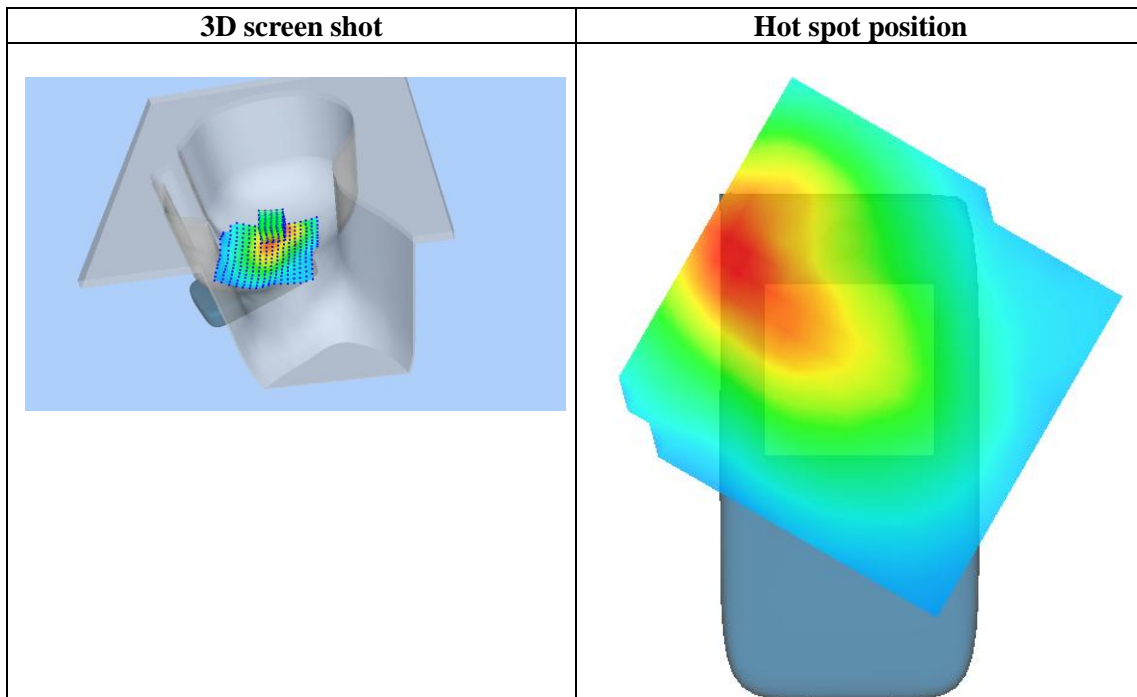
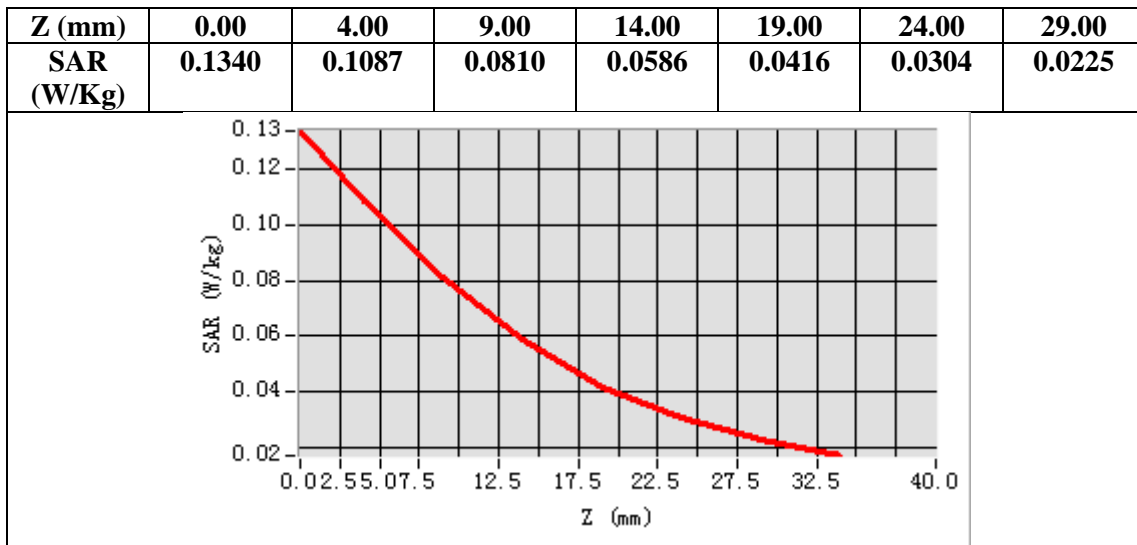

Test Laboratory: AGC Lab
GPRS 850 Mid- Body- Back (2up) <SIM 2>
DUT: Smartphone-Miracle 6.0 S; Type: Miracle 6.0 S

Date: Mar. 21,2017

Communication System: GPRS-2 Slot; Communication System Band: GSM 850; Duty Cycle: 1:4.2; Conv.F=5.94;
Frequency: 836.6 MHz; Medium parameters used: $f = 835$ MHz; $\sigma = 0.96$ mho/m; $\epsilon_r = 55.03$; $\rho = 1000$ kg/m³ ;
Phantom section: Flat Section
Ambient temperature (°C): 21.4, Liquid temperature (°C): 21.3

SATIMO Configuration:

- Probe: SSE5; Calibrated: 12/05/2016; Serial No.: SN 14/16 EP308
- Sensor-Surface: 4mm (Mechanical Surface Detection)
- Phantom: SAM twin phantom
- Measurement SW: OpenSAR V4_02_32

Configuration/GPRS 850 Mid-Body-Back/Area Scan: Measurement grid: dx=8mm, dy=8mm
Configuration/GPRS 850 Mid-Body-Back/Zoom Scan: Measurement grid: dx=8mm,dy=8mm, dz=5mm;

Area Scan	sam_direct_droit2_surf8mm.txt
Zoom Scan	5x5x7,dx=8mm dy=8mm dz=5mm,Complete
Phantom	Validation plane
Device Position	Body Back
Band	GSM 850
Channels	Middle
Signal	TDMA (Crest factor: 4.0)

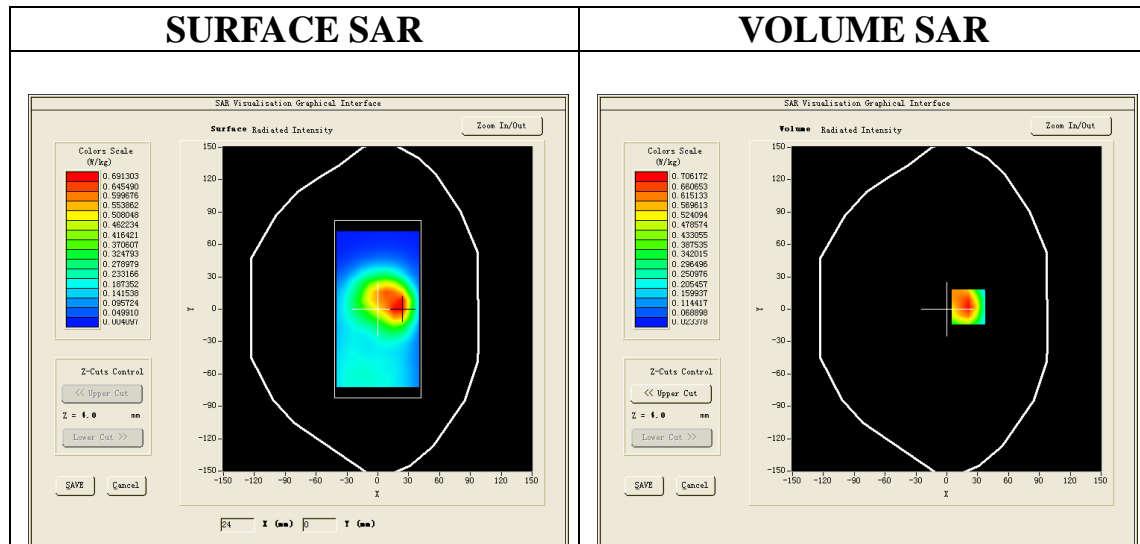

Maximum location: X=21.00, Y=2.00

SAR Peak: 0.99 W/kg

SAR 10g (W/Kg)	0.409688
SAR 1g (W/Kg)	0.660805

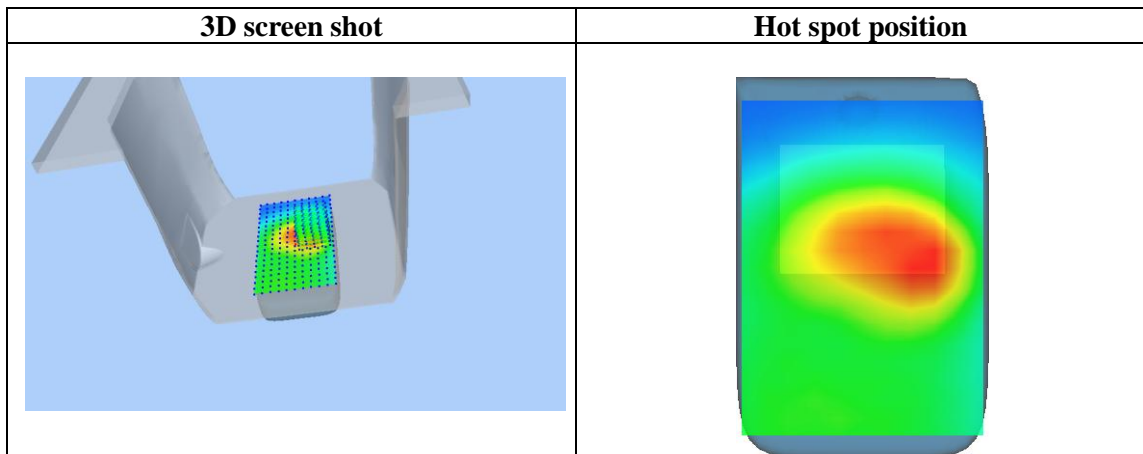
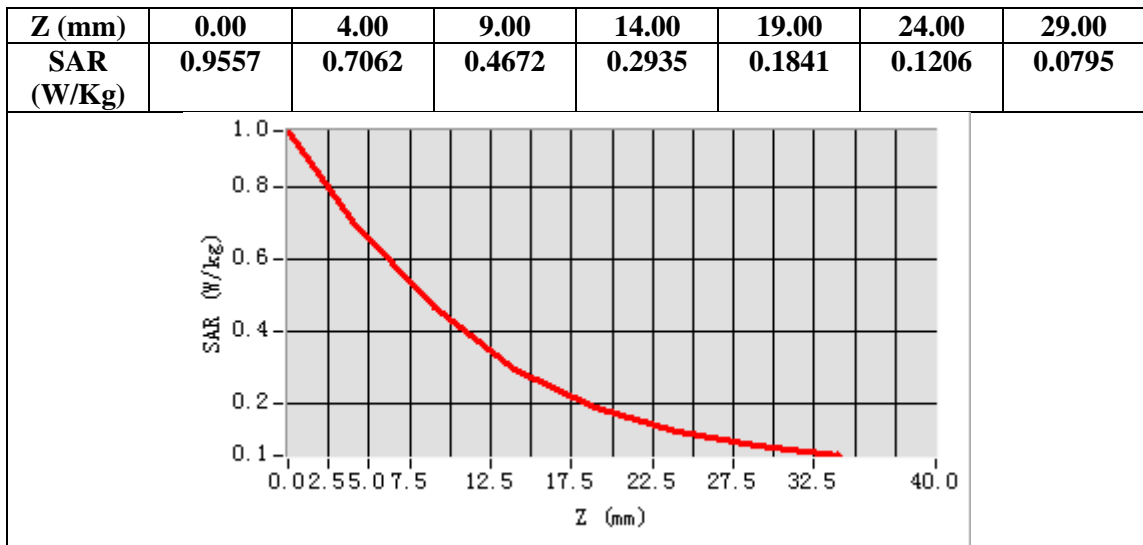

Test Laboratory: AGC Lab
PCS 1900 Mid-Tilt-Right <SIM 1>
DUT: Smartphone-Miracle 6.0 S; **Type:** Miracle 6.0 S

Date: Mar. 22,2017

Communication System: Generic GSM; Communication System Band: PCS 1900; Duty Cycle: 1:8.3; Conv.F=5.74;
Frequency: 1880 MHz; Medium parameters used: $f = 1900$ MHz; $\sigma = 1.38$ mho/m; $\epsilon_r = 40.88$; $\rho = 1000$ kg/m³ ;
Phantom section: Right Section
Ambient temperature (°C): 21.4, Liquid temperature (°C): 20.2

SATIMO Configuration:

- Probe: SSE5; Calibrated: 12/05/2016; Serial No.: SN 14/16 EP308
- Sensor-Surface: 4mm (Mechanical Surface Detection)
- Phantom: SAM twin phantom
- Measurement SW: OpenSAR V4_02_32

Configuration/PCS1900 Mid-Tilt-Right/Area Scan: Measurement grid: dx=8mm, dy=8mm
Configuration/PCS1900 Mid-Tilt-Right/Zoom Scan: Measurement grid: dx=8mm,dy=8mm, dz=5mm;

Area Scan	sam_direct_droit2_surf8mm.txt
ZoomScan	5x5x7,dx=8mm dy=8mm dz=5mm,Complete
Phantom	Right head
Device Position	Tilt
Band	PCS 1900
Channels	Middle
Signal	TDMA (Crest factor: 8.0)

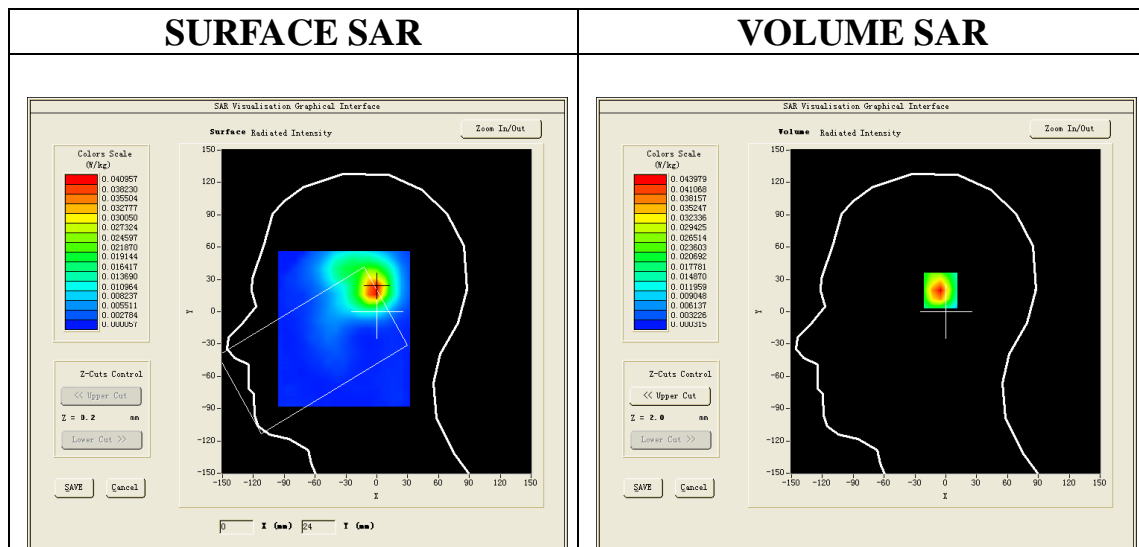

Maximum location: X=-1.00, Y=21.00

SAR Peak: 0.07 W/kg

SAR 10g (W/Kg)	0.019971
SAR 1g (W/Kg)	0.041243

Z (mm)	0.00	4.00	9.00	14.00	19.00	24.00	29.00
SAR (W/Kg)	0.0724	0.0440	0.0225	0.0111	0.0058	0.0030	0.0014

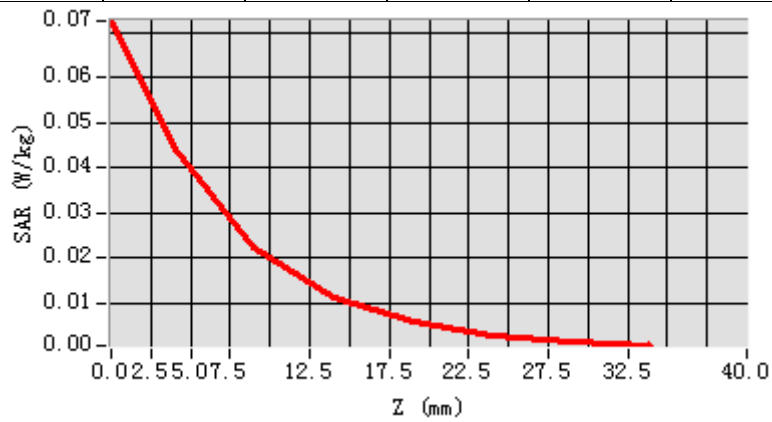

3D screen shot

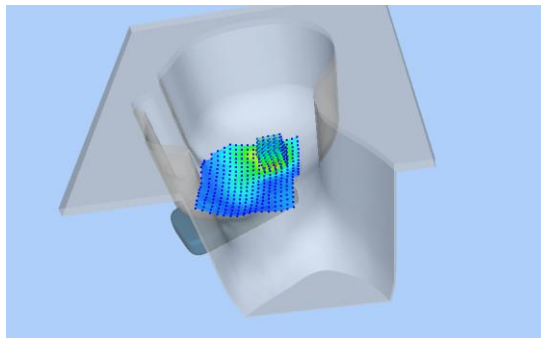

Hot spot position

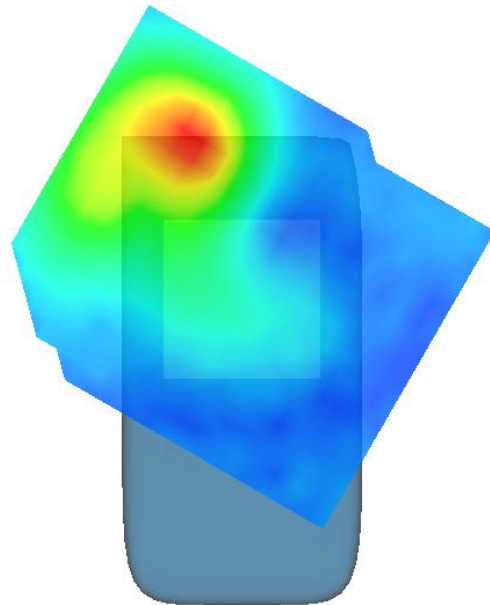

Test Laboratory: AGC Lab
PCS 1900 Mid-Body-Back (MS)<SIM 1>
DUT: Smartphone-Miracle 6.0 S; Type: Miracle 6.0 S

Date: Mar. 22,2017

Communication System: Generic GSM; Communication System Band: PCS 1900; Duty Cycle: 1:8.3; Conv.F=5.90;
Frequency: 1880 MHz; Medium parameters used: $f = 1900$ MHz; $\sigma = 1.49$ mho/m; $\epsilon_r = 53.79$; $\rho = 1000$ kg/m³ ;
Phantom section: Flat Section
Ambient temperature (°C): 21.4, Liquid temperature (°C): 20.5

SATIMO Configuration:

- Probe: SSE5; Calibrated: 12/05/2016; Serial No.: SN 14/16 EP308
- Sensor-Surface: 4mm (Mechanical Surface Detection)
- Phantom: SAM twin phantom
- Measurement SW: OpenSAR V4_02_32

Configuration/PCS1900 Mid-Body-Back/Area Scan: Measurement grid: dx=8mm, dy=8mm
Configuration/PCS1900 Mid-Body-Back/Zoom Scan: Measurement grid: dx=8mm,dy=8mm, dz=5mm;

Area Scan	sam_direct_droit2_surf8mm.txt
ZoomScan	5x5x7,dx=8mm dy=8mm dz=5mm,Complete
Phantom	Validation plane
Device Position	Body Back
Band	PCS 1900
Channels	Middle
Signal	TDMA (Crest factor: 8.0)

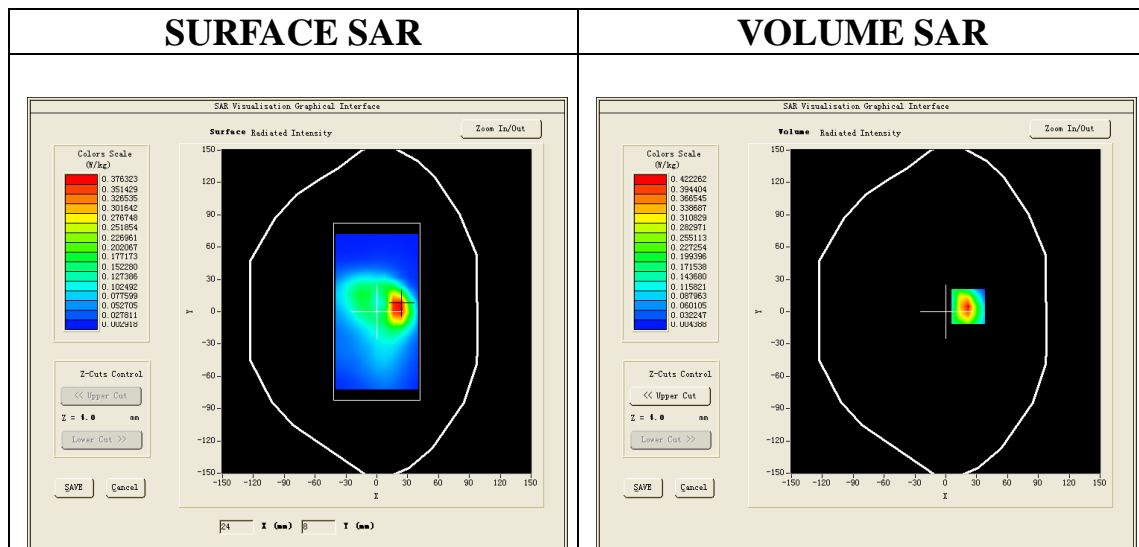

Maximum location: X=22.00, Y=5.00
SAR Peak: 0.66 W/kg

SAR 10g (W/Kg)	0.190183
SAR 1g (W/Kg)	0.388270

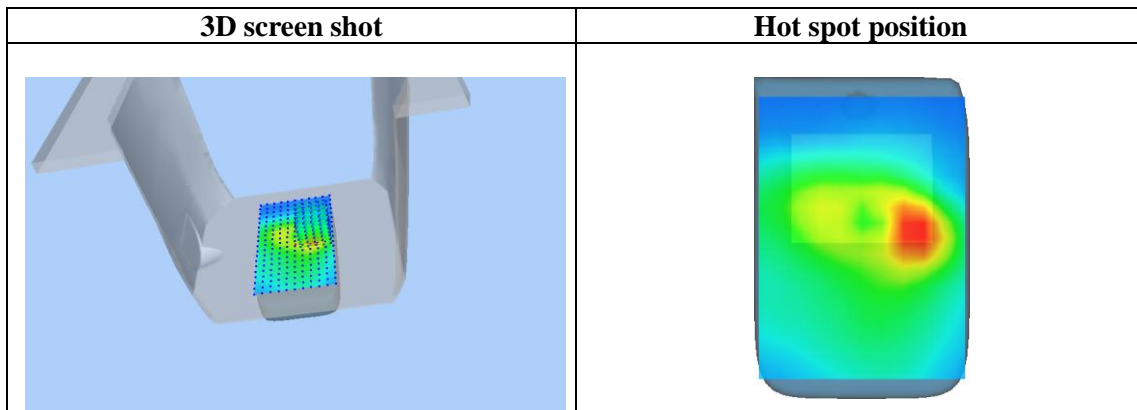
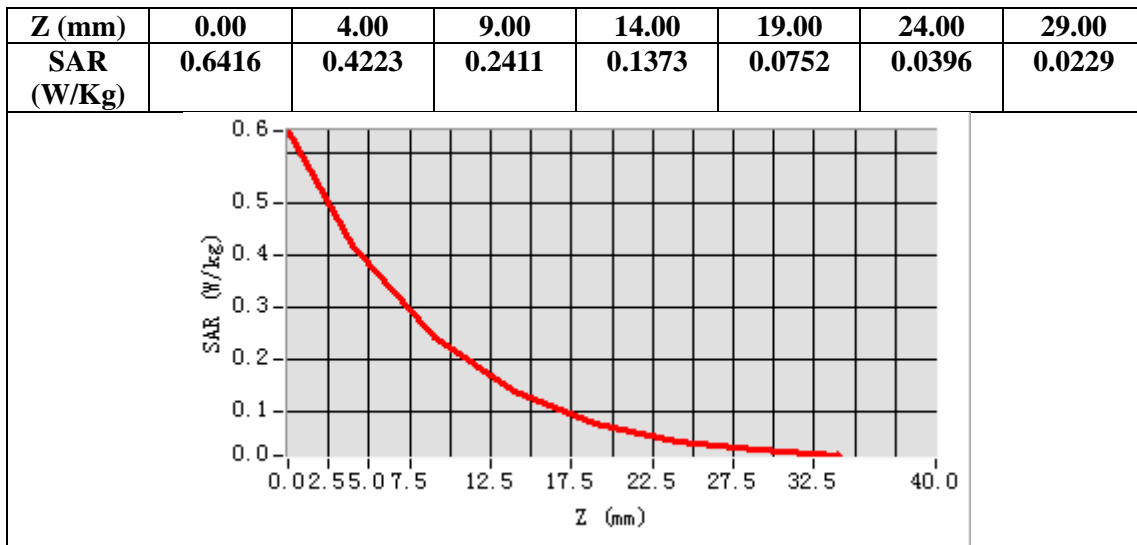

Test Laboratory: AGC Lab
GPRS1900 Mid-Touch-Right (3up) <SIM 1>
DUT: Smartphone-Miracle 6.0 S; Type: Miracle 6.0 S

Date: Mar. 22,2017

Communication System: GPRS-3Slot; Communication System Band: PCS 1900; Duty Cycle: 1:2.7; Conv.F=5.74;
Frequency: 1880 MHz; Medium parameters used: $f = 1900$ MHz; $\sigma = 1.38$ mho/m; $\epsilon_r = 40.88$; $\rho = 1000$ kg/m³ ;
Phantom section: Right Section
Ambient temperature (°C): 21.4, Liquid temperature (°C): 20.2

SATIMO Configuration:

- Probe: SSE5; Calibrated: 12/05/2016; Serial No.: SN 14/16 EP308
- Sensor-Surface: 4mm (Mechanical Surface Detection)
- Phantom: SAM twin phantom
- Measurement SW: OpenSAR V4_02_32

Configuration/GPRS1900 Mid-Touch-Right/Area Scan: Measurement grid: dx=8mm, dy=8mm

Configuration/GPRS1900 Mid-Touch-Right/Zoom Scan: Measurement grid: dx=8mm,dy=8mm, dz=5mm;

Area Scan	sam_direct_droit2_surf8mm.txt
Zoom Scan	5x5x7,dx=8mm dy=8mm dz=5mm,Complete
Phantom	Right head
Device Position	Cheek
Band	PCS 1900
Channels	Middle
Signal	TDMA (Crest factor: 2.7)

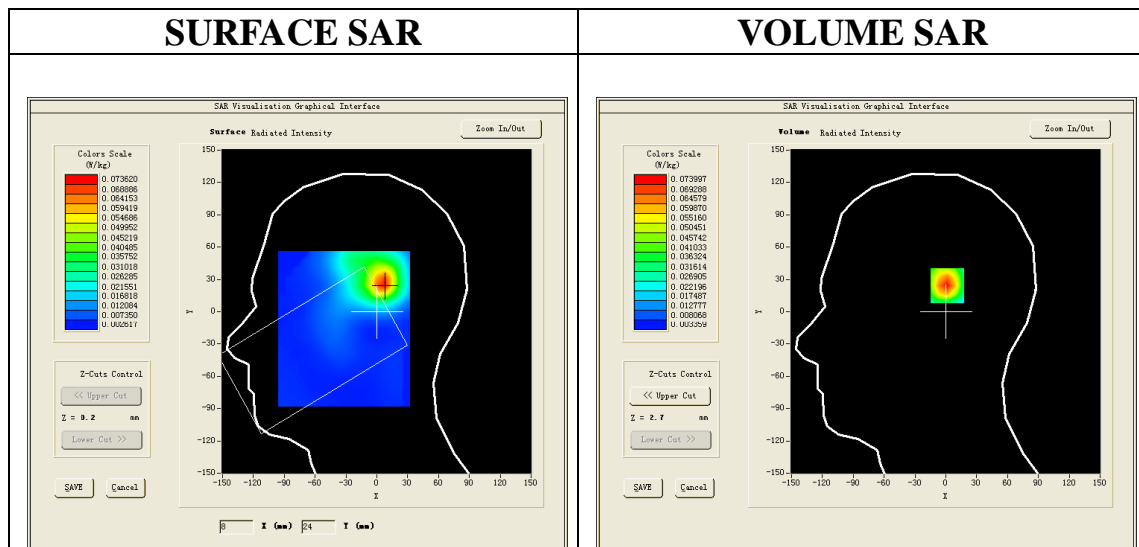

Maximum location: X=7.00, Y=26.00

SAR Peak: 0.12 W/kg

SAR 10g (W/Kg)	0.036742
SAR 1g (W/Kg)	0.070044

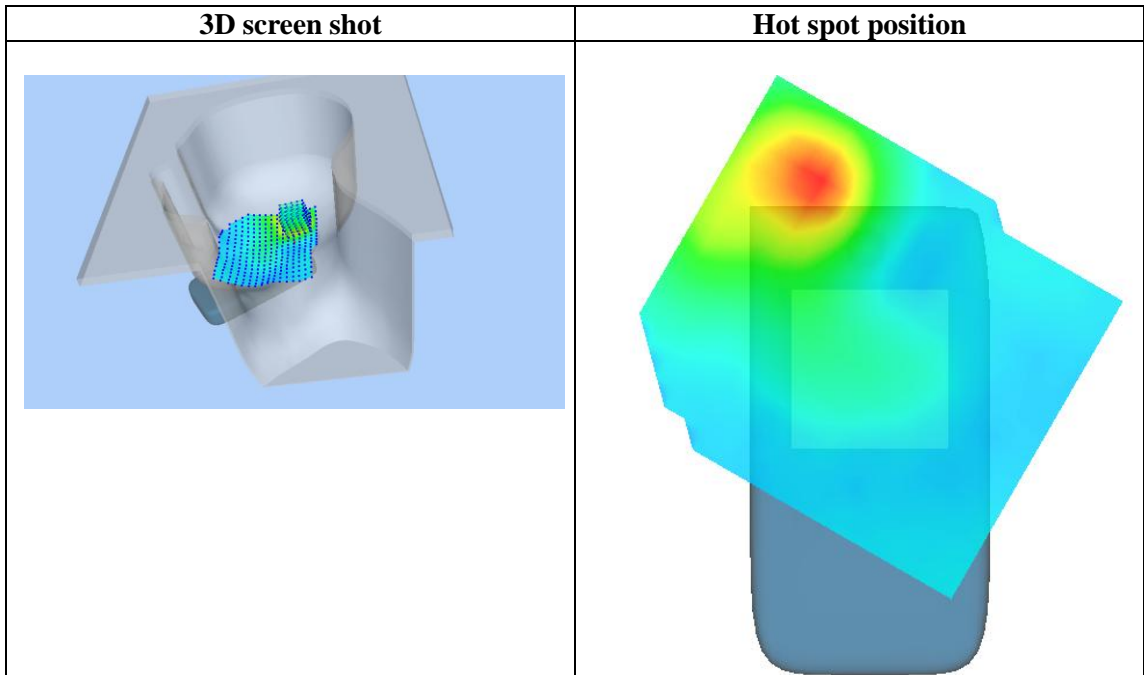
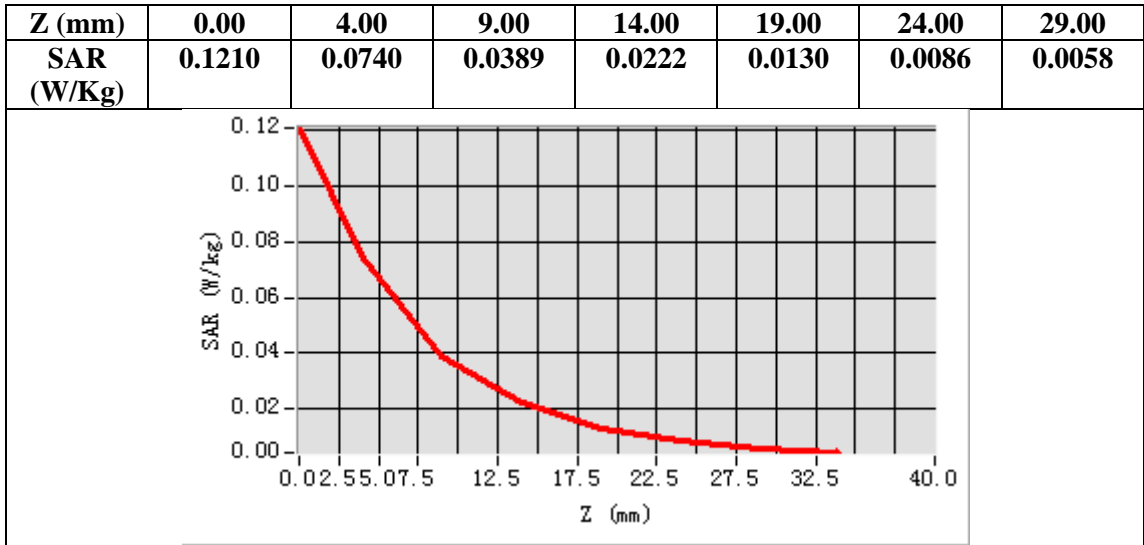

Test Laboratory: AGC Lab
GPRS 1900 High-Body-Back (3up) <SIM 1>
DUT: Smartphone-Miracle 6.0 S; Type: Miracle 6.0 S

Date: Mar. 22,2017

Communication System: GPRS-3Slot; Communication System Band: PCS 1900; Duty Cycle: 1:2.7; Conv.F=5.90;
Frequency: 1909.8 MHz; Medium parameters used: $f = 1900$ MHz; $\sigma = 1.53$ mho/m; $\epsilon_r = 52.88$; $\rho = 1000$ kg/m³ ;
Phantom section: Flat Section
Ambient temperature (°C): 21.4, Liquid temperature (°C): 20.5

SATIMO Configuration:

- Probe: SSE5; Calibrated: 12/05/2016; Serial No.: SN 14/16 EP308
- Sensor-Surface: 4mm (Mechanical Surface Detection)
- Phantom: SAM twin phantom
- Measurement SW: OpenSAR V4_02_32

Configuration/GPRS1900 High -Body-Back/Area Scan: Measurement grid: dx=8mm, dy=8mm

Configuration/GPRS1900 High -Body-Back/Zoom Scan: Measurement grid: dx=8mm,dy=8mm, dz=5mm;

Area Scan	sam_direct_droit2_surf8mm.txt
Zoom Scan	5x5x7,dx=8mm dy=8mm dz=5mm,Complete
Phantom	Validation plane
Device Position	Body Back
Band	PCS 1900
Channels	High
Signal	TDMA (Crest factor: 2.7)

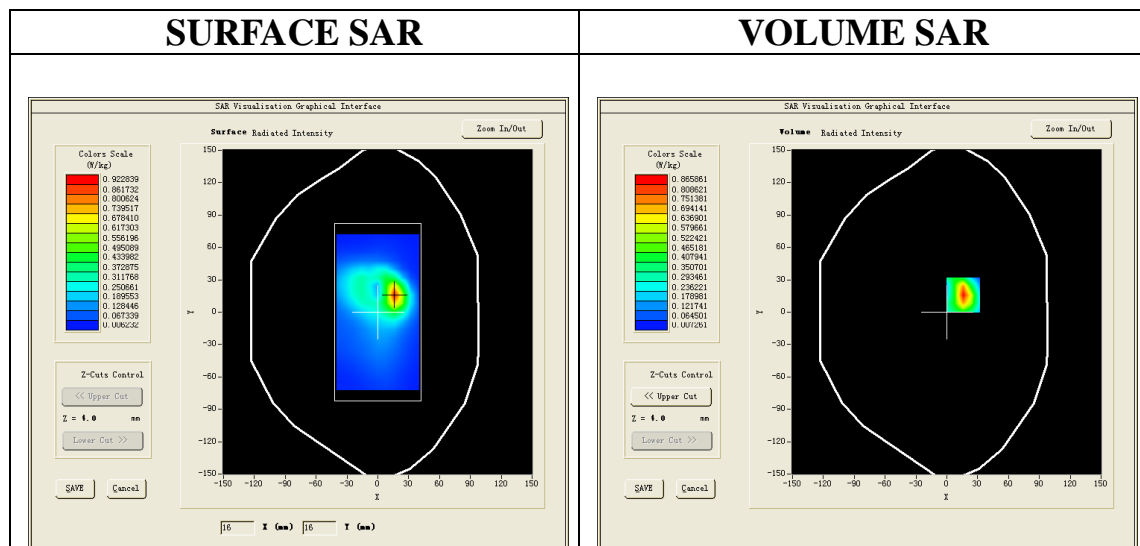

Maximum location: X=16.00, Y=16.00

SAR Peak: 1.37 W/kg

SAR 10g (W/Kg)	0.369036
SAR 1g (W/Kg)	0.778894

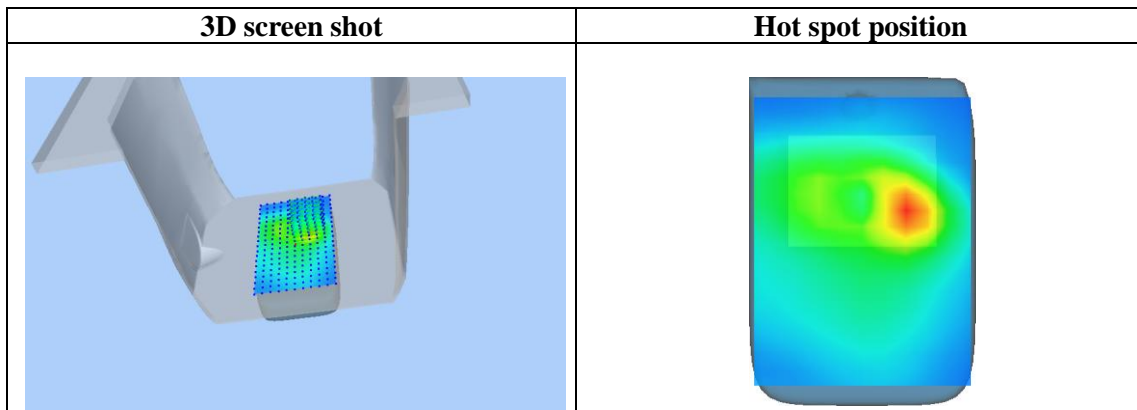
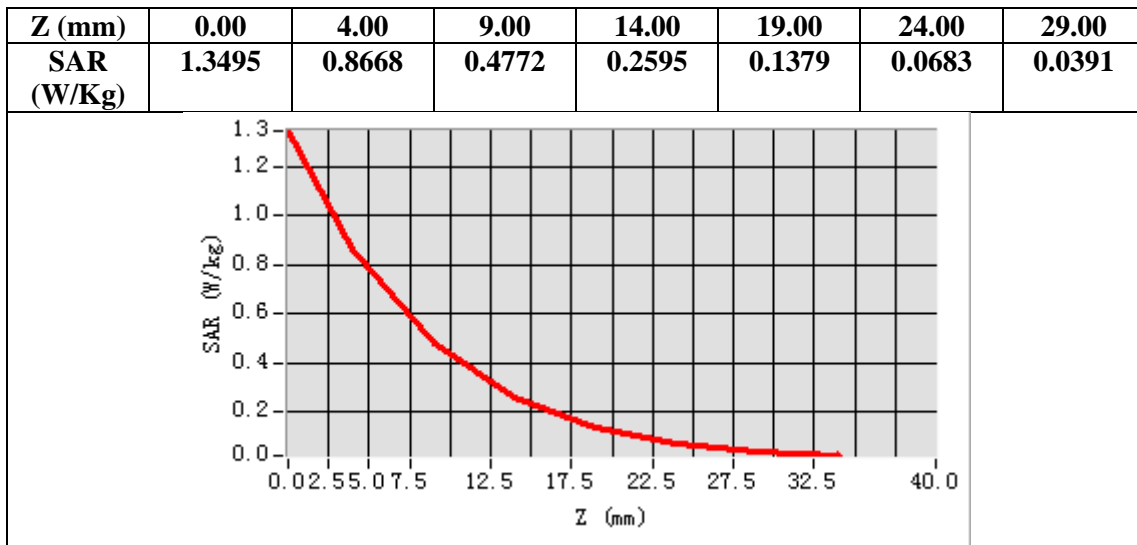

Test Laboratory: AGC Lab
GPRS1900 Mid-Touch-Right (3up) <SIM 2>
DUT: Smartphone-Miracle 6.0 S; Type: Miracle 6.0 S

Date: Mar. 22,2017

Communication System: GPRS-3Slot; Communication System Band: PCS 1900; Duty Cycle: 1:2.7; Conv.F=5.74;
Frequency: 1880 MHz; Medium parameters used: $f = 1900$ MHz; $\sigma = 1.38$ mho/m; $\epsilon_r = 40.88$; $\rho = 1000$ kg/m³ ;
Phantom section: Right Section
Ambient temperature (°C): 21.4, Liquid temperature (°C): 20.2

SATIMO Configuration:

- Probe: SSE5; Calibrated: 12/05/2016; Serial No.: SN 14/16 EP308
- Sensor-Surface: 4mm (Mechanical Surface Detection)
- Phantom: SAM twin phantom
- Measurement SW: OpenSAR V4_02_32

Configuration/GPRS1900 Mid-Touch-Right/Area Scan: Measurement grid: dx=8mm, dy=8mm

Configuration/GPRS1900 Mid-Touch-Right/Zoom Scan: Measurement grid: dx=8mm,dy=8mm, dz=5mm;

Area Scan	sam_direct_droit2_surf8mm.txt
Zoom Scan	5x5x7,dx=8mm dy=8mm dz=5mm,Complete
Phantom	Right head
Device Position	Cheek
Band	PCS 1900
Channels	Middle
Signal	TDMA (Crest factor: 2.7)

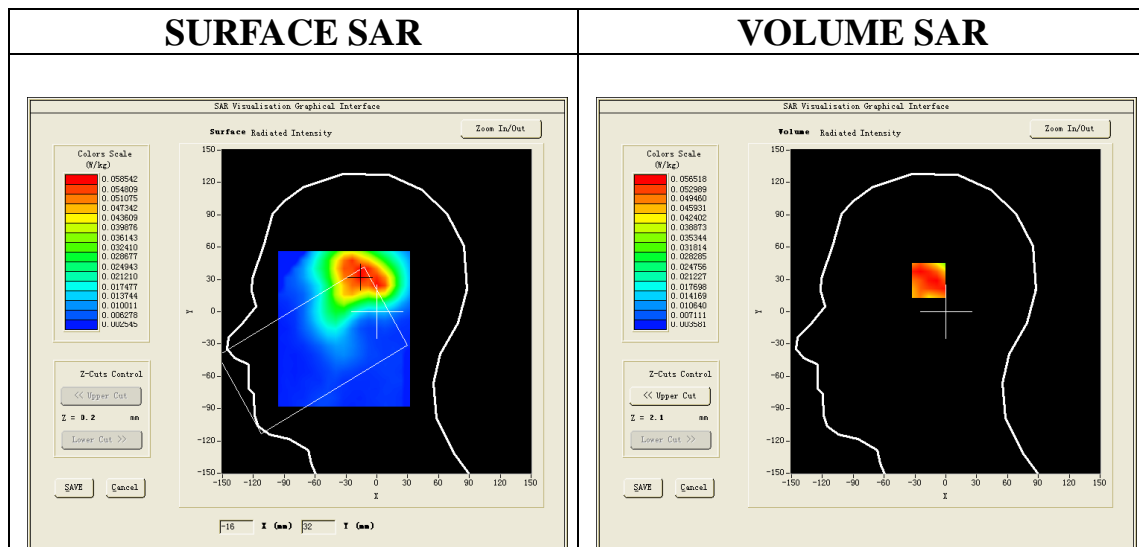

Maximum location: X=-16.00, Y=34.00

SAR Peak: 0.09 W/kg

SAR 10g (W/Kg)	0.033466
SAR 1g (W/Kg)	0.055520

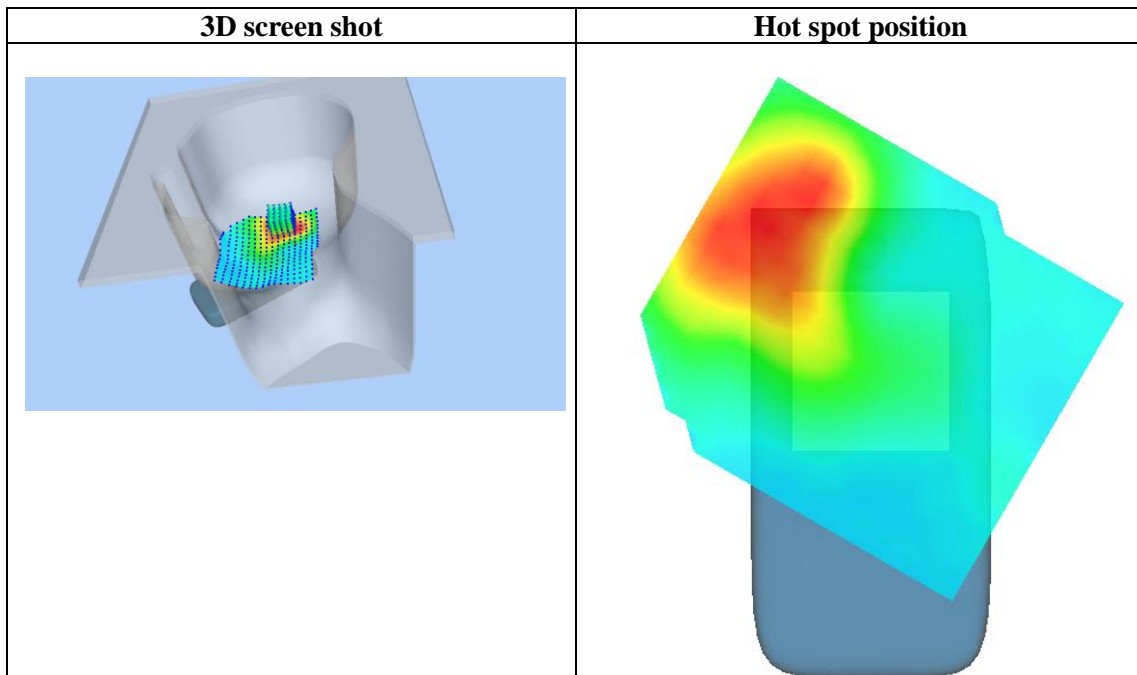
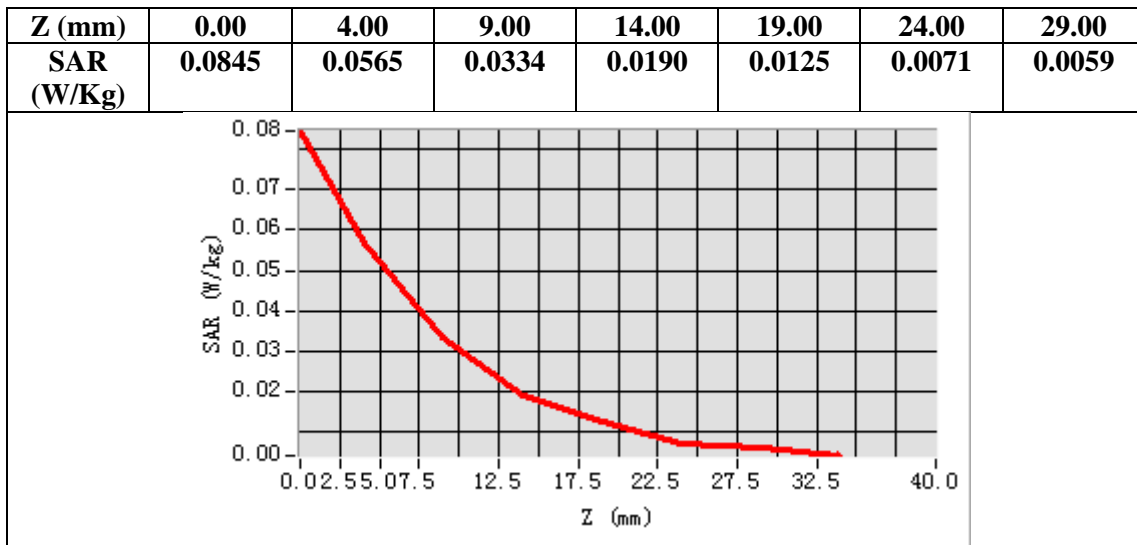

Test Laboratory: AGC Lab
GPRS 1900 High-Body-Back (3up) <SIM 2>
DUT: Smartphone-Miracle 6.0 S; Type: Miracle 6.0 S

Date: Mar. 22,2017

Communication System: GPRS-3Slot; Communication System Band: PCS 1900; Duty Cycle: 1:2.7; Conv.F=5.90;
Frequency: 1909.8 MHz; Medium parameters used: $f = 1900$ MHz; $\sigma = 1.53$ mho/m; $\epsilon_r = 52.88$; $\rho = 1000$ kg/m³ ;
Phantom section: Flat Section
Ambient temperature (°C): 21.4, Liquid temperature (°C): 20.5

SATIMO Configuration:

- Probe: SSE5; Calibrated: 12/05/2016; Serial No.: SN 14/16 EP308
- Sensor-Surface: 4mm (Mechanical Surface Detection)
- Phantom: SAM twin phantom
- Measurement SW: OpenSAR V4_02_32

Configuration/GPRS1900 High -Body-Back/Area Scan: Measurement grid: dx=8mm, dy=8mm

Configuration/GPRS1900 High -Body-Back/Zoom Scan: Measurement grid: dx=8mm,dy=8mm, dz=5mm;

Area Scan	sam_direct_droit2_surf8mm.txt
Zoom Scan	5x5x7,dx=8mm dy=8mm dz=5mm,Complete
Phantom	Validation plane
Device Position	Body Back
Band	PCS 1900
Channels	High
Signal	TDMA (Crest factor: 2.7)

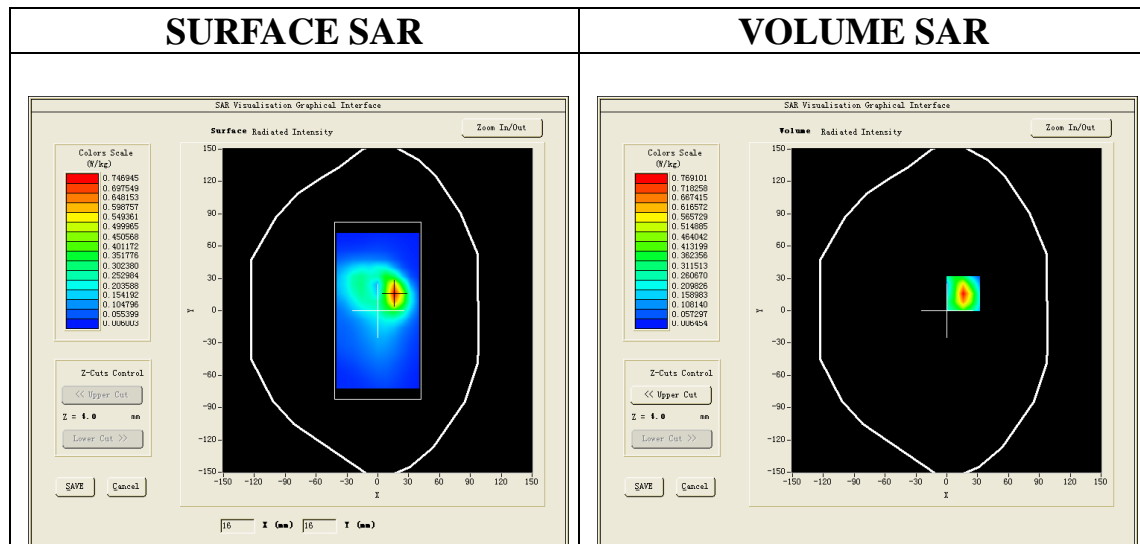

Maximum location: X=16.00, Y=16.00

SAR Peak: 1.28 W/kg

SAR 10g (W/Kg)	0.316962
SAR 1g (W/Kg)	0.692062

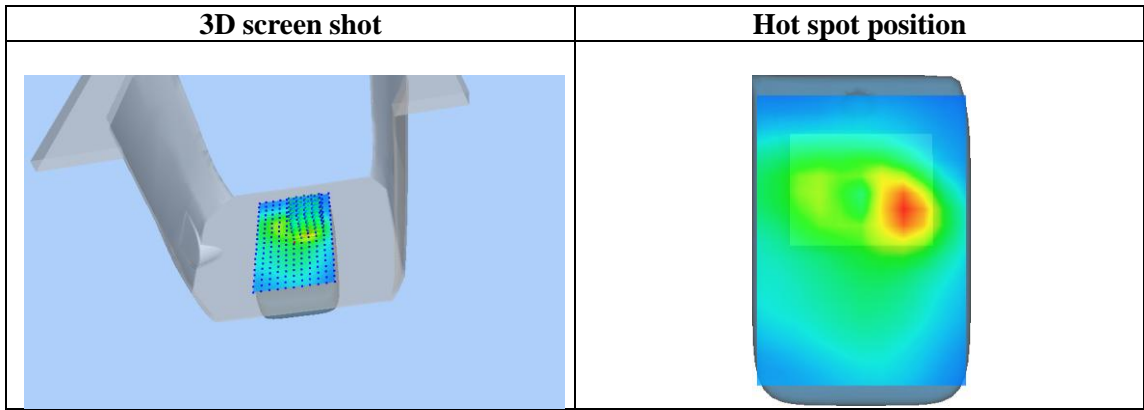
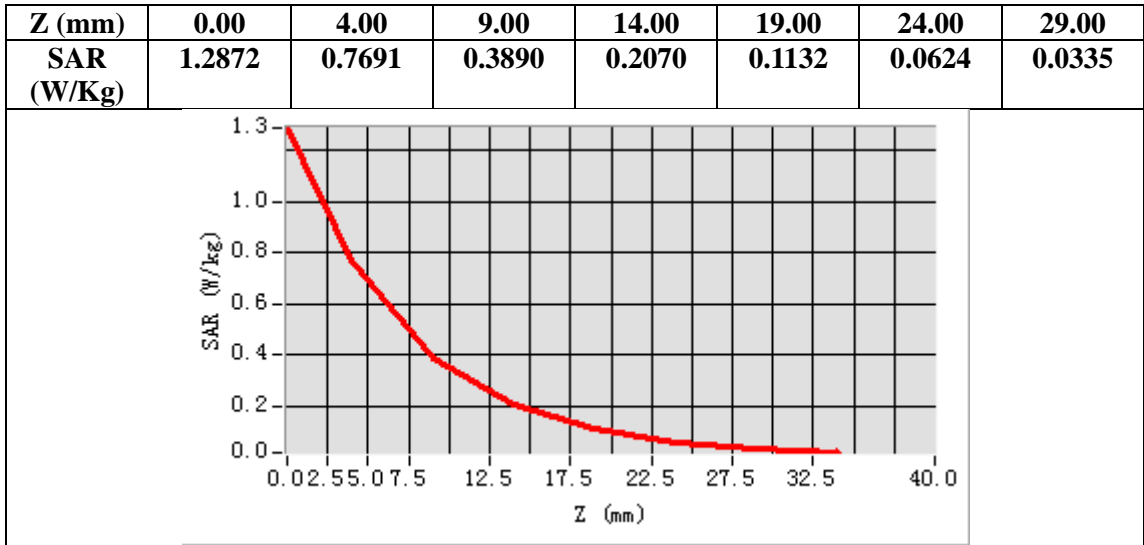

Test Laboratory: AGC Lab
WCDMA Band II Mid-Tilt-Right <HSDPA Subtest 1>
DUT: Smartphone-Miracle 6.0 S; Type: Miracle 6.0 S

Date: Mar. 22,2017

Communication System: UMTS; Communication System Band: Band II UTRA/FDD ;Duty Cycle:1:1; Conv.F=5.74;
Frequency: 1880 MHz; Medium parameters used: $f = 1900$ MHz; $\sigma = 1.38$ mho/m; $\epsilon_r = 40.88$; $\rho = 1000$ kg/m³ ;
Phantom section: Right Section
Ambient temperature (°C): 21.4, Liquid temperature (°C): 20.2

SATIMO Configuration:

- Probe: SSE5; Calibrated: 12/05/2016; Serial No.: SN 14/16 EP308
- Sensor-Surface: 4mm (Mechanical Surface Detection)
- Phantom: SAM twin phantom
- Measurement SW: OpenSAR V4_02_32

Configuration/WCDMA Band II Mid-Tilt-Right/Area Scan: Measurement grid: dx=8mm, dy=8mm
Configuration/WCDMA Band II Mid-Tilt-Right/Zoom Scan: Measurement grid: dx=8mm,dy=8mm, dz=5mm;

Area Scan	sam_direct_droit2_surf8mm.txt
ZoomScan	5x5x7,dx=8mm dy=8mm dz=5mm,Complete
Phantom	Right head
Device Position	Tilt
Band	WCDMA band II
Channels	Middle
Signal	CDMA (Crest factor: 1.0)

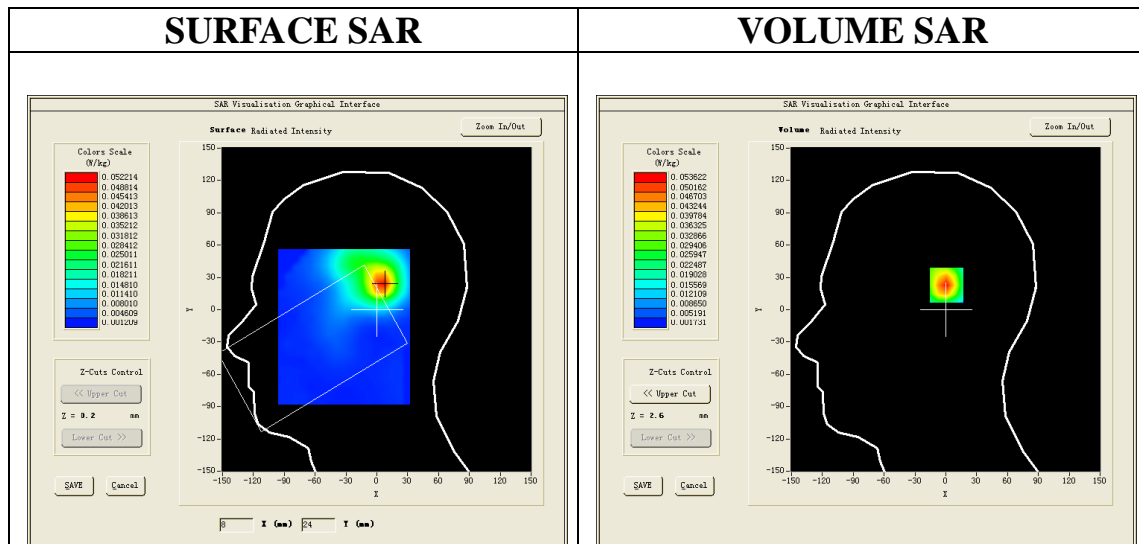

Maximum location: X=6.00, Y=24.00
SAR Peak: 0.09 W/kg

SAR 10g (W/Kg)	0.025646
SAR 1g (W/Kg)	0.050507

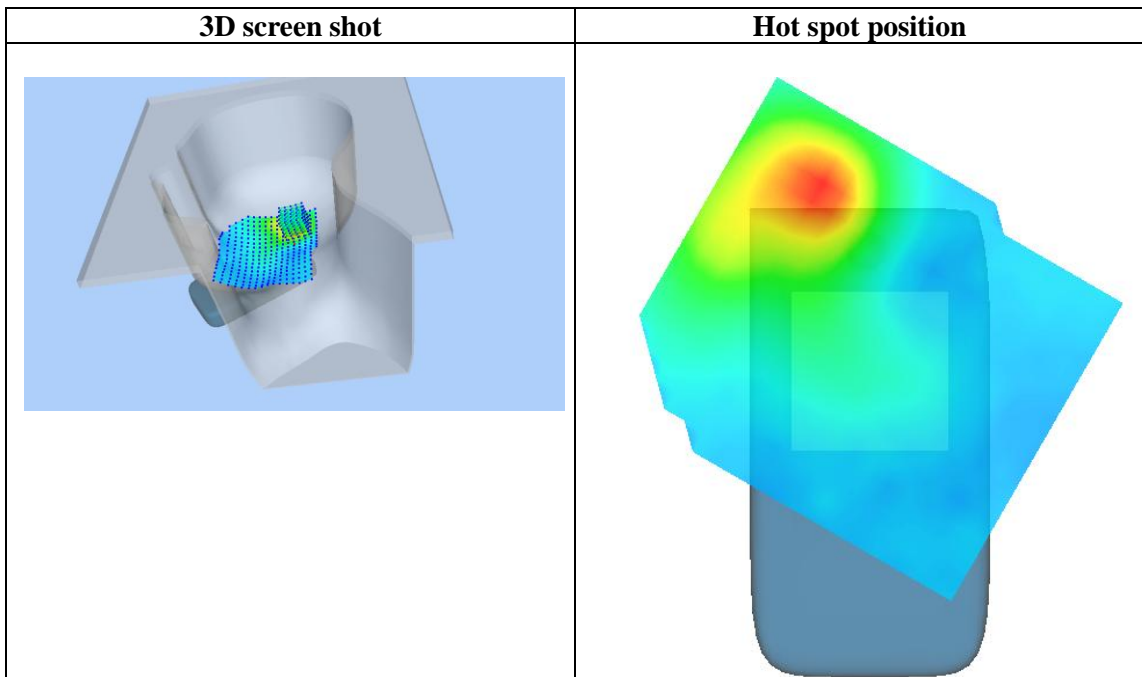
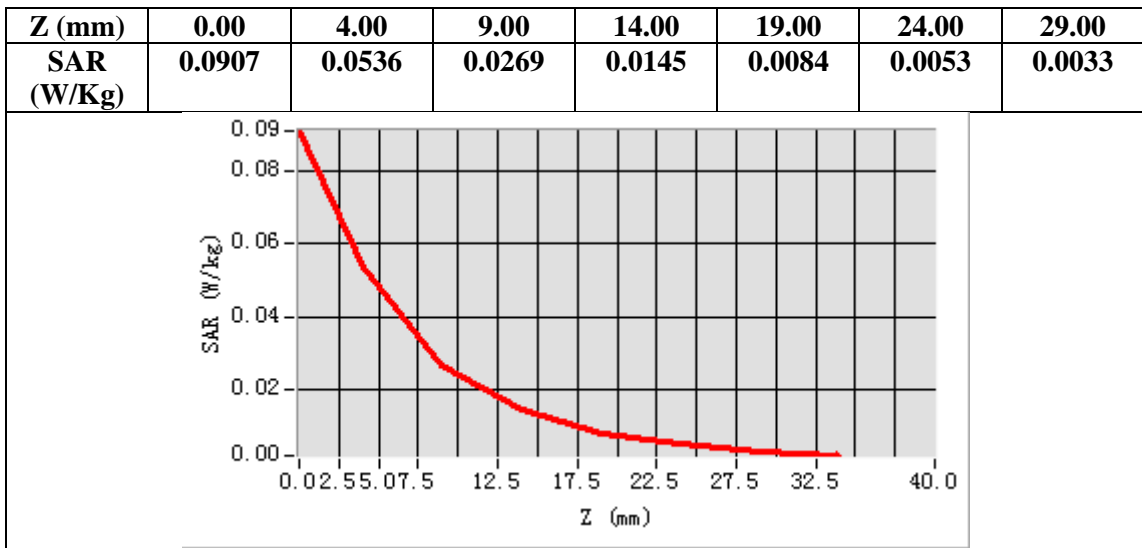

Test Laboratory: AGC Lab

Date: Mar. 22,2017

WCDMA Band II Mid-Body-Towards Grounds (HSDPA Subtest 1)

DUT: Smartphone-Miracle 6.0 S; Type: Miracle 6.0 S

Communication System: UMTS; Communication System Band: Band II UTRA/FDD ;Duty Cycle:1:1; Conv.F=5.90;
Frequency: 1880 MHz; Medium parameters used: $f = 1900$ MHz; $\sigma = 1.49$ mho/m; $\epsilon_r = 53.79$; $\rho = 1000$ kg/m³ ;
Phantom section: Flat Section
Ambient temperature (°C): 21.4, Liquid temperature (°C): 20.5

SATIMO Configuration:

- Probe: SSE5; Calibrated: 12/05/2016; Serial No.: SN 14/16 EP308
- Sensor-Surface: 4mm (Mechanical Surface Detection)
- Phantom: SAM twin phantom
- Measurement SW: OpenSAR V4_02_32

Configuration/ WCDMA band II Mid-Body-back/Area Scan: Measurement grid: dx=8mm, dy=8mm

Configuration/ WCDMA band II Mid-Body-back/Zoom Scan: Measurement grid: dx=8mm,dy=8mm, dz=5mm;

Area Scan	sam_direct_droit2_surf8mm.txt
ZoomScan	5x5x7,dx=8mm dy=8mm dz=5mm,Complete
Phantom	Validation plane
Device Position	Body Back
Band	WCDMA band II
Channels	Middle
Signal	CDMA (Crest factor: 1.0)

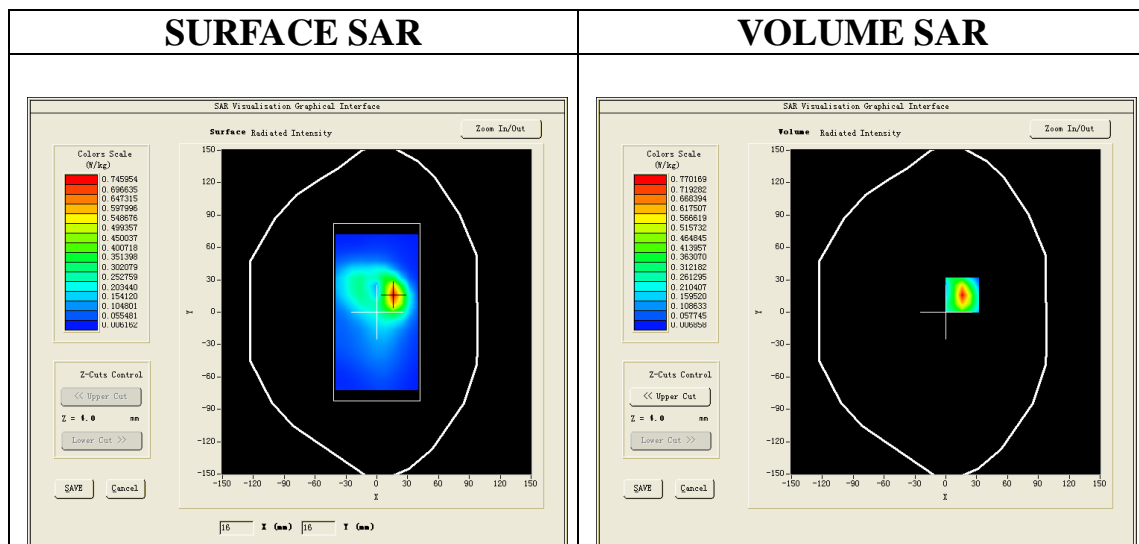

Maximum location: X=16.00, Y=16.00

SAR Peak: 1.21 W/kg

SAR 10g (W/Kg)	0.319039
SAR 1g (W/Kg)	0.685246

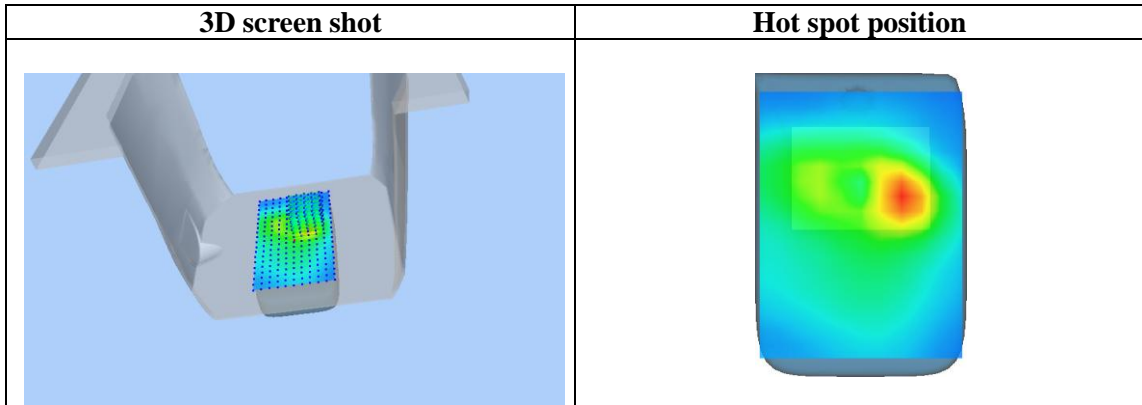
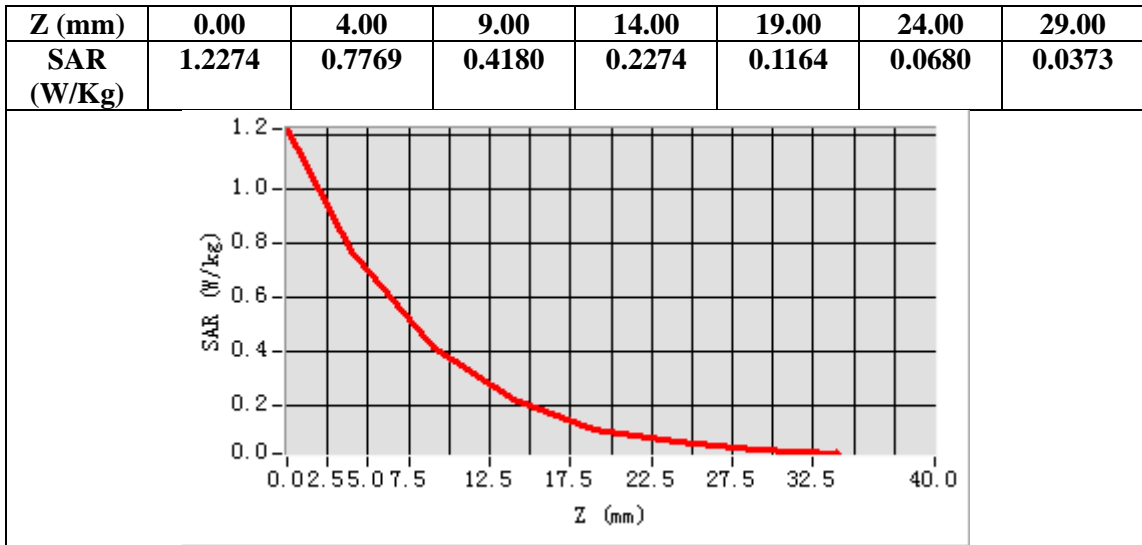

Test Laboratory: AGC Lab

Date: Mar. 21,2017

WCDMA Band V Mid-Tilt-Right (HSUPA Subtest 3)

DUT: Smartphone-Miracle 6.0 S; Type: Miracle 6.0 S

Communication System: UMTS; Communication System Band: BAND V UTRA/FDD ; Duty Cycle:1: 1; Conv.F=5.72;
Frequency: 836.6 MHz; Medium parameters used: $f = 835\text{MHz}$; $\sigma = 0.89 \text{ mho/m}$; $\epsilon_r = 41.52$; $\rho = 1000 \text{ kg/m}^3$;
Phantom section: Right Section
Ambient temperature ($^{\circ}\text{C}$): 21.4, Liquid temperature ($^{\circ}\text{C}$): 21.2

SATIMO Configuration:

- Probe: SSE5; Calibrated: 12/05/2016; Serial No.: SN 14/16 EP308
- Sensor-Surface: 4mm (Mechanical Surface Detection)
- Phantom: SAM twin phantom
- Measurement SW: OpenSAR V4_02_32

Configuration/ WCDMA Band V Mid-Tilt-Right/Area Scan: Measurement grid: $dx=8\text{mm}$, $dy=8\text{mm}$

Configuration/ WCDMA Band V Mid-Tilt-Right/Zoom Scan: Measurement grid: $dx=8\text{mm}$, $dy=8\text{mm}$, $dz=5\text{mm}$;

Area Scan	sam_direct_droit2_surf8mm.txt
Zoom Scan	5x5x7,dx=8mm dy=8mm dz=5mm,Complete
Phantom	Right head
Device Position	Tilt
Band	WCDMA Band V
Channels	Middle
Signal	CDMA (Crest factor: 1.0)

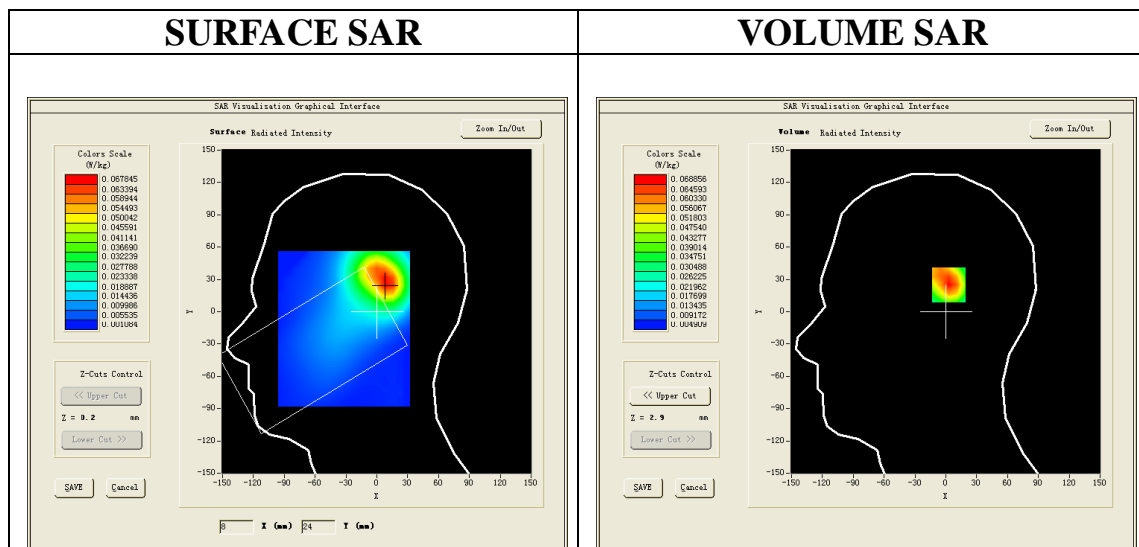

Maximum location: X=9.00, Y=26.00

SAR Peak: 0.10 W/kg

SAR 10g (W/Kg)	0.041642
SAR 1g (W/Kg)	0.065868

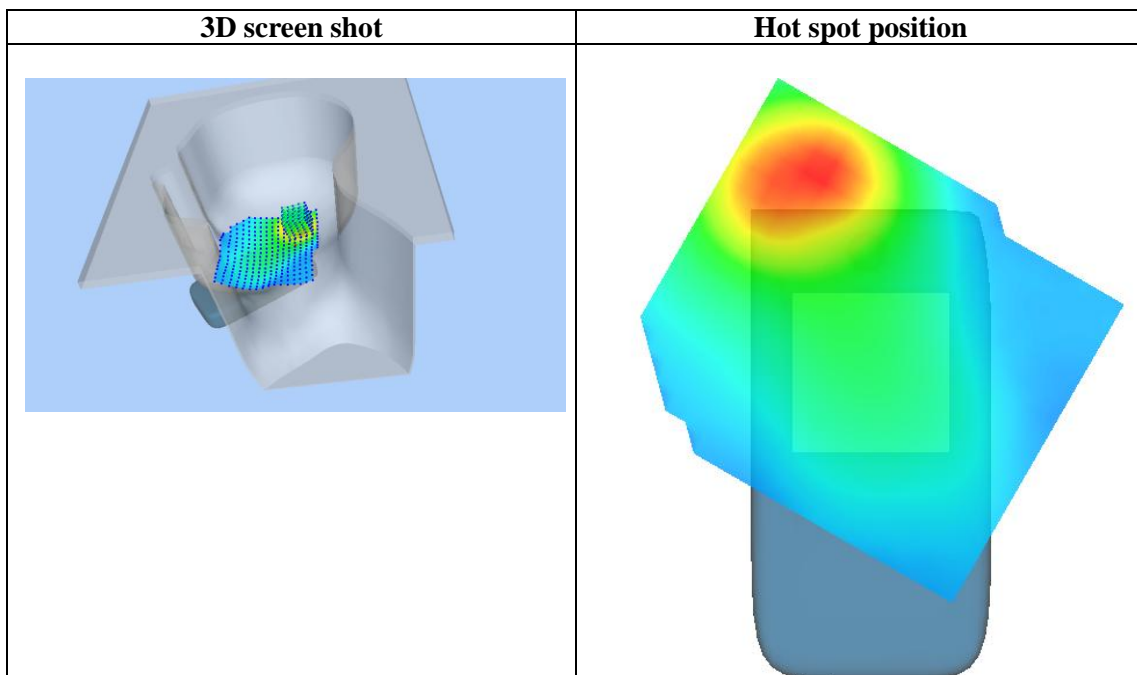
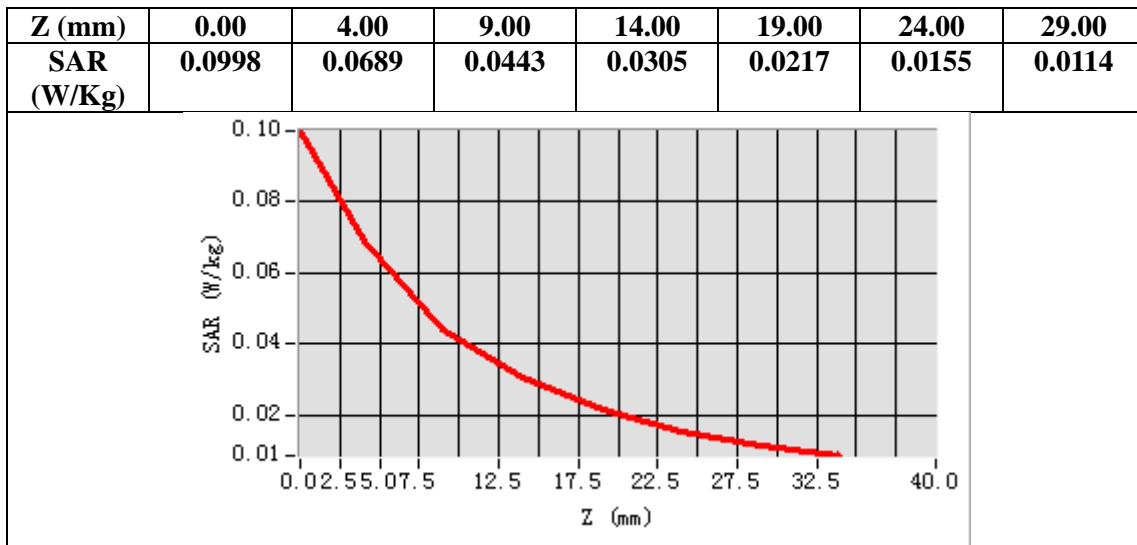

Test Laboratory: AGC Lab

Date: Mar. 21,2017

WCDMA Band V Low-Body-Towards Grounds (HSUPA Subtest 3)

DUT: Smartphone-Miracle 6.0 S; Type: Miracle 6.0 S

Communication System: UMTS; Communication System Band: BAND V UTRA/FDD; Duty Cycle:1: 1; Conv.F=5.94; Frequency: 826.4 MHz; Medium parameters used: $f = 835\text{MHz}$; $\sigma = 0.94 \text{ mho/m}$; $\epsilon_r = 55.84$; $\rho = 1000 \text{ kg/m}^3$; Phantom section: Flat Section
Ambient temperature ($^{\circ}\text{C}$): 21.4, Liquid temperature ($^{\circ}\text{C}$): 21.3

SATIMO Configuration:

- Probe: SSE5; Calibrated: 12/05/2016; Serial No.: SN 14/16 EP308
- Sensor-Surface: 4mm (Mechanical Surface Detection)
- Phantom: SAM twin phantom
- Measurement SW: OpenSAR V4_02_32

Configuration/ WCDMA Band V Low -Body-Back/Area Scan: Measurement grid: dx=8mm, dy=8mm

Configuration/ WCDMA Band V Low -Body-Back/Zoom Scan: Measurement grid: dx=8mm,dy=8mm, dz=5mm;

Area Scan	sam_direct_droit2_surf8mm.txt
ZoomScan	5x5x7,dx=8mm dy=8mm dz=5mm,Complete
Phantom	Validation plane
Device Position	Body Back
Band	WCDMA Band V
Channels	Low
Signal	CDMA (Crest factor: 1.0)

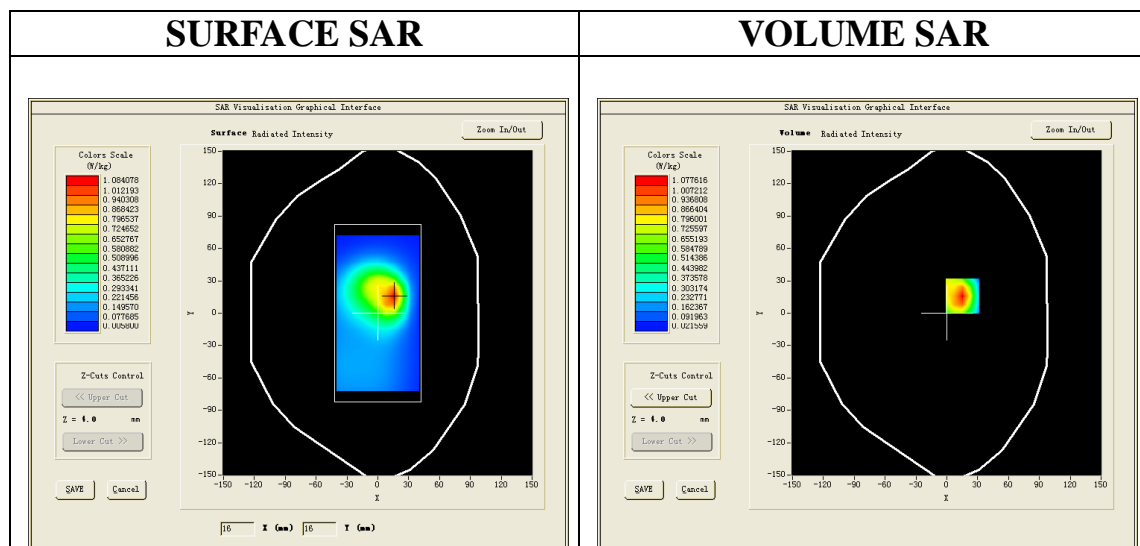

Maximum location: X=15.00, Y=16.00

SAR Peak: 1.71 W/kg

SAR 10g (W/Kg)	0.561691
SAR 1g (W/Kg)	1.008059

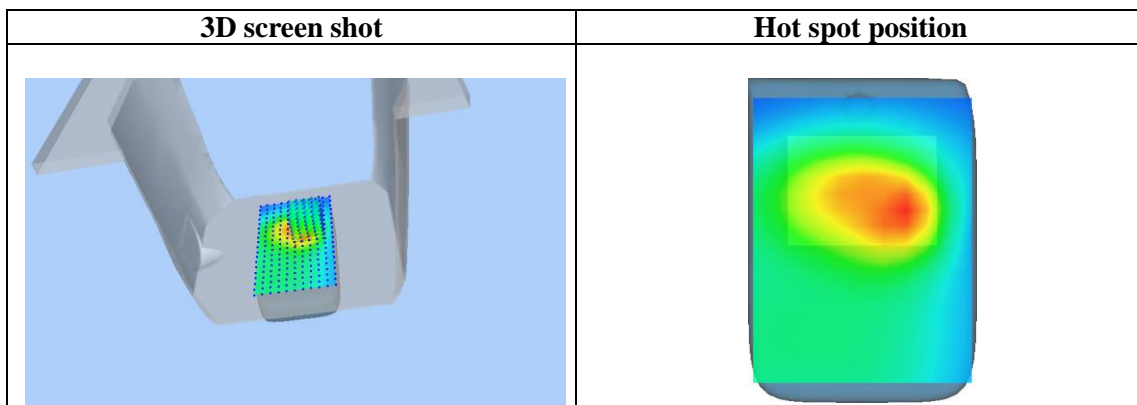
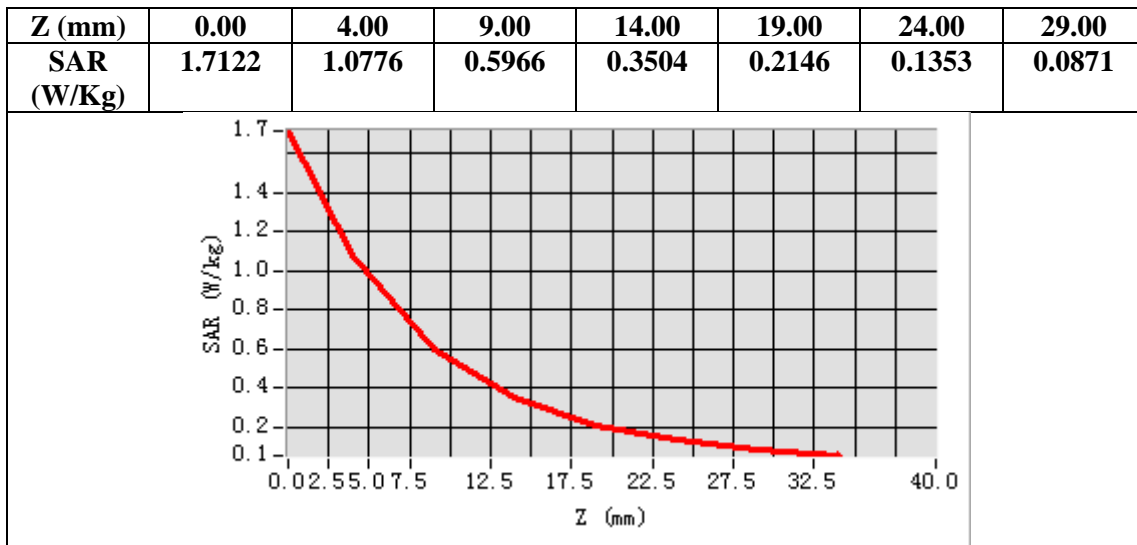

WIFI MODE

Test Laboratory: AGC Lab

Date: Mar. 24,2017

802.11b Low-Touch-Left

DUT: Smartphone-Miracle 6.0 S; Type: Miracle 6.0 S

Communication System: Wi-Fi; Communication System Band: 802.11b; Duty Cycle: 1:1; Conv.F=5.19;
Frequency: 2412 MHz; Medium parameters used: $f = 2450$ MHz; $\sigma = 1.73$ mho/m; $\epsilon_r = 40.89$ $\rho = 1000$ kg/m³ ;
Phantom section: Left Section
Ambient temperature (°C):22.2, Liquid temperature (°C): 21.8

SATIMO Configuration:

- Probe: SSE5; Calibrated: 12/05/2016; Serial No.: SN 14/16 EP308
- Sensor-Surface: 4mm (Mechanical Surface Detection)
- Phantom: SAM twin phantom
- Measurement SW: OpenSAR V4_02_32

Configuration/802.11b Low- Touch-Left/Area Scan: Measurement grid: dx=8mm, dy=8mm

Configuration/802.11b Low- Touch-Left/Zoom Scan: Measurement grid: dx=5mm,dy=5mm, dz=5mm

Area Scan	sam_direct_droit2_surf8mm.txt
ZoomScan	7x7x7,dx=5mm dy=5mm dz=5mm
Phantom	Left head
Device Position	Cheek
Band	2450MHz
Channels	Low
Signal	Crest factor: 1.0

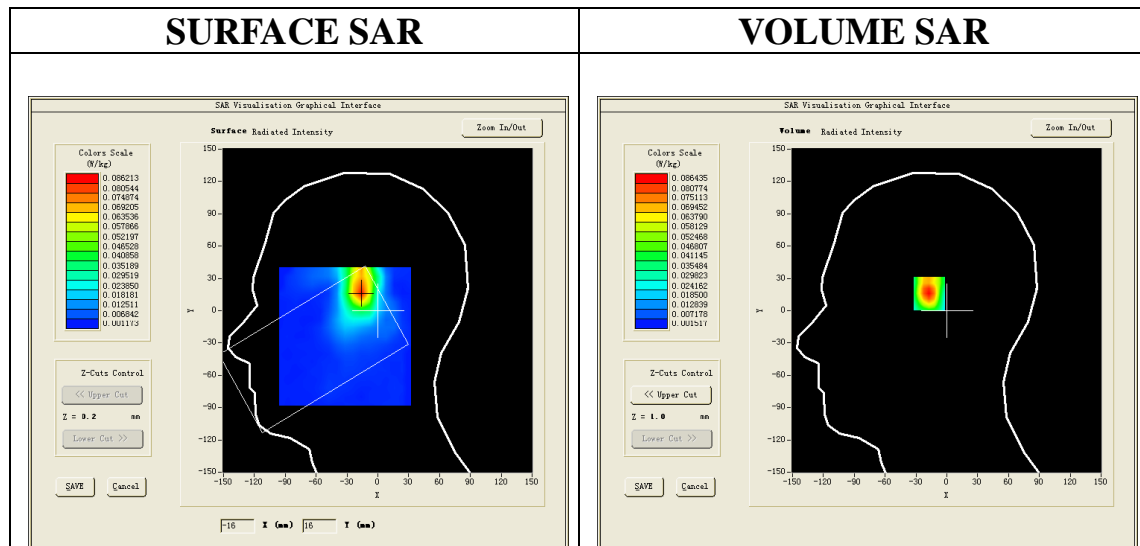

Maximum location: X=-16.00, Y=17.00

SAR Peak: 0.15 W/kg

SAR 10g (W/Kg)	0.039400
SAR 1g (W/Kg)	0.080257

Z (mm)	0.00	4.00	9.00	14.00	19.00	24.00	29.00
SAR (W/Kg)	0.1454	0.0864	0.0424	0.0206	0.0099	0.0061	0.0034

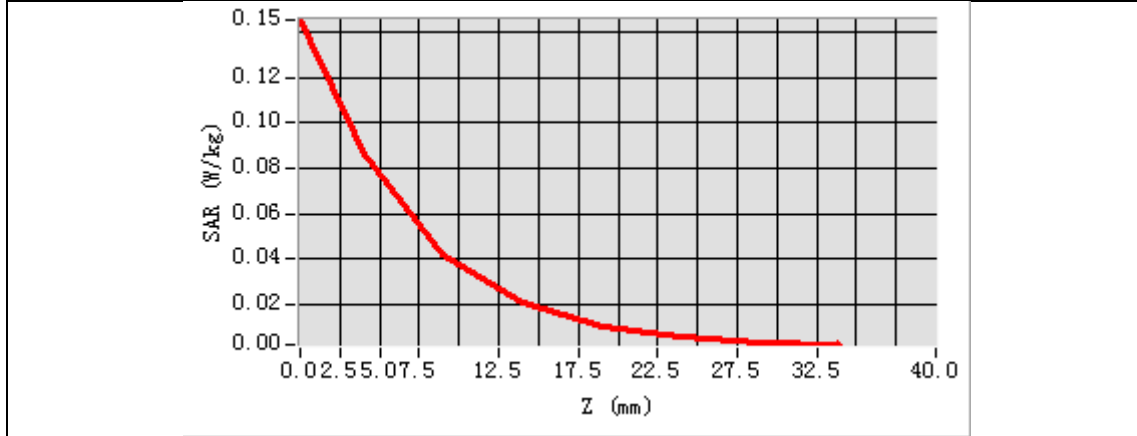

3D screen shot	Hot spot position
<p>A 3D perspective view of a human head model. A grid of small blue and green squares is overlaid on the face, representing the SAR measurement locations.</p>	<p>A 3D perspective view of the same head model. A color-coded heatmap is overlaid on the face, showing a prominent red and orange 'hot spot' in the center of the forehead, indicating the highest SAR value.</p>

Test Laboratory: AGC Lab
802.11b Low-Body-Worn- Back
DUT: Smartphone-Miracle 6.0 S; Type: Miracle 6.0 S

Date: Mar. 24,2017

Communication System: Wi-Fi; Communication System Band: 802.11b; Duty Cycle: 1:1; Conv.F=5.33;
Frequency: 2412 MHz; Medium parameters used: $f = 2450$ MHz; $\sigma = 1.88$ mho/m; $\epsilon_r = 54.85$; $\rho = 1000$ kg/m³ ;
Phantom section: Flat Section
Ambient temperature (°C):22.2, Liquid temperature (°C): 21.5

SATIMO Configuration:

- Probe: SSE5; Calibrated: 12/05/2016; Serial No.: SN 14/16 EP308
- Sensor-Surface: 4mm (Mechanical Surface Detection)
- Phantom: SAM twin phantom
- Measurement SW: OpenSAR V4_02_32

Configuration/802.11b Low- Body- Back /Area Scan: Measurement grid: dx=8mm, dy=8mm
Configuration/802.11b Low- Body- Back /Zoom Scan: Measurement grid: dx=5mm,dy=5mm, dz=5mm;

Area Scan	sam_direct_droit2_surf8mm.txt
ZoomScan	7x7x7,dx=5mm dy=5mm dz=5mm
Phantom	Validation plane
Device Position	Body Back
Band	2450MHz
Channels	Low
Signal	Crest factor: 1.0

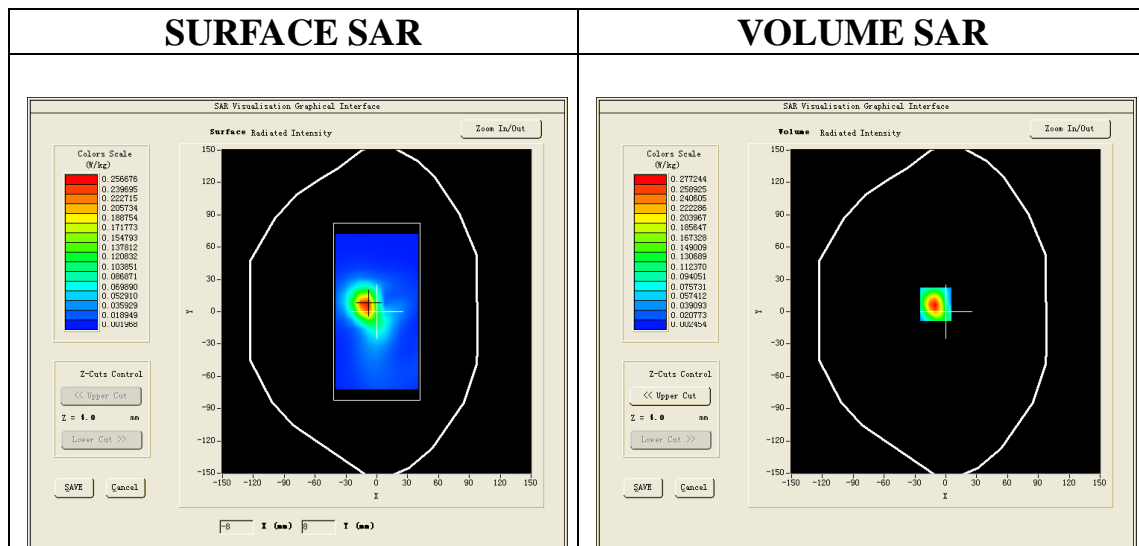

Maximum location: X=-10.00, Y=7.00
SAR Peak: 0.48 W/kg

SAR 10g (W/Kg)	0.109432
SAR 1g (W/Kg)	0.250532

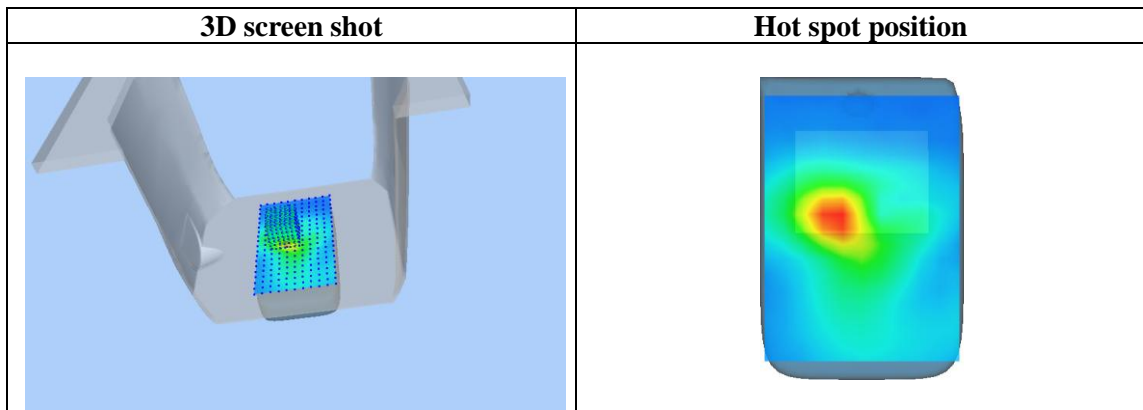
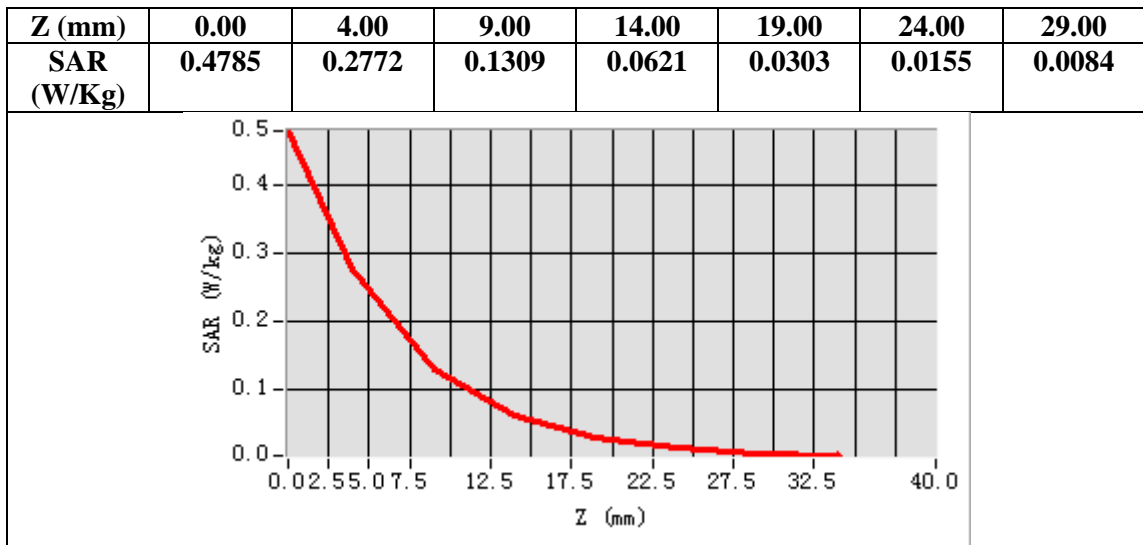

Repeated SAR

Test Laboratory: AGC Lab
GPRS 1900 High-Body-Back (3up) <SIM 1>
DUT: Smartphone-Miracle 6.0 S; Type: Miracle 6.0 S

Date: Mar. 22,2017

Communication System: GPRS-3Slot; Communication System Band: PCS 1900; Duty Cycle: 1:2.7; Conv.F=5.90;
Frequency: 1909.8 MHz; Medium parameters used: $f = 1900$ MHz; $\sigma = 1.53$ mho/m; $\epsilon_r = 52.88$; $\rho = 1000$ kg/m³ ;
Phantom section: Flat Section
Ambient temperature (°C): 21.4, Liquid temperature (°C): 20.5

SATIMO Configuration:

- Probe: SSE5; Calibrated: 12/05/2016; Serial No.: SN 14/16 EP308
- Sensor-Surface: 4mm (Mechanical Surface Detection)
- Phantom: SAM twin phantom
- Measurement SW: OpenSAR V4_02_32

Configuration/GPRS1900 High -Body-Back/Area Scan: Measurement grid: dx=8mm, dy=8mm

Configuration/GPRS1900 High -Body-Back/Zoom Scan: Measurement grid: dx=8mm,dy=8mm, dz=5mm;

Area Scan	sam_direct_droit2_surf8mm.txt
Zoom Scan	5x5x7,dx=8mm dy=8mm dz=5mm,Complete
Phantom	Validation plane
Device Position	Body Back
Band	PCS 1900
Channels	High
Signal	TDMA (Crest factor: 2.7)

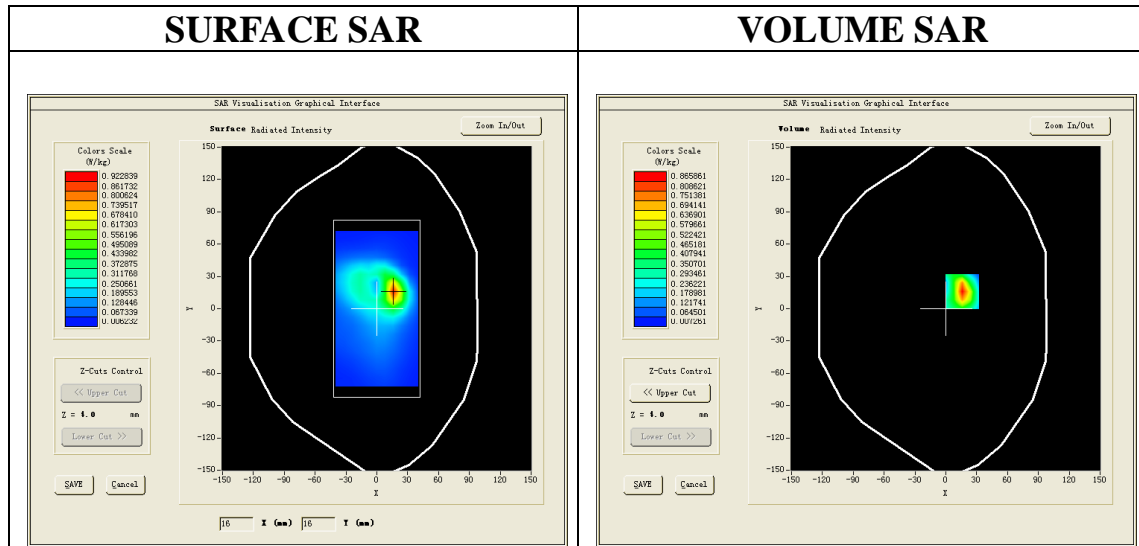

Maximum location: X=16.00, Y=16.00

SAR Peak: 1.37 W/kg

SAR 10g (W/Kg)	0.368306
SAR 1g (W/Kg)	0.777390

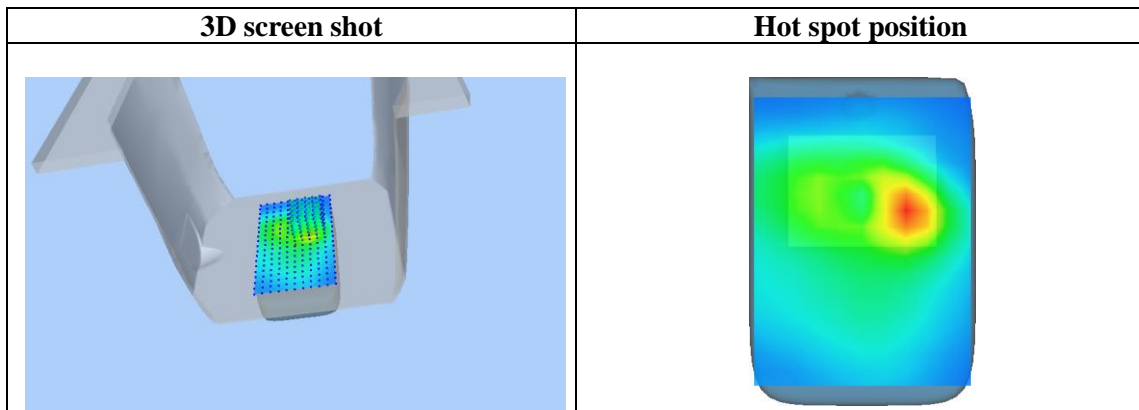
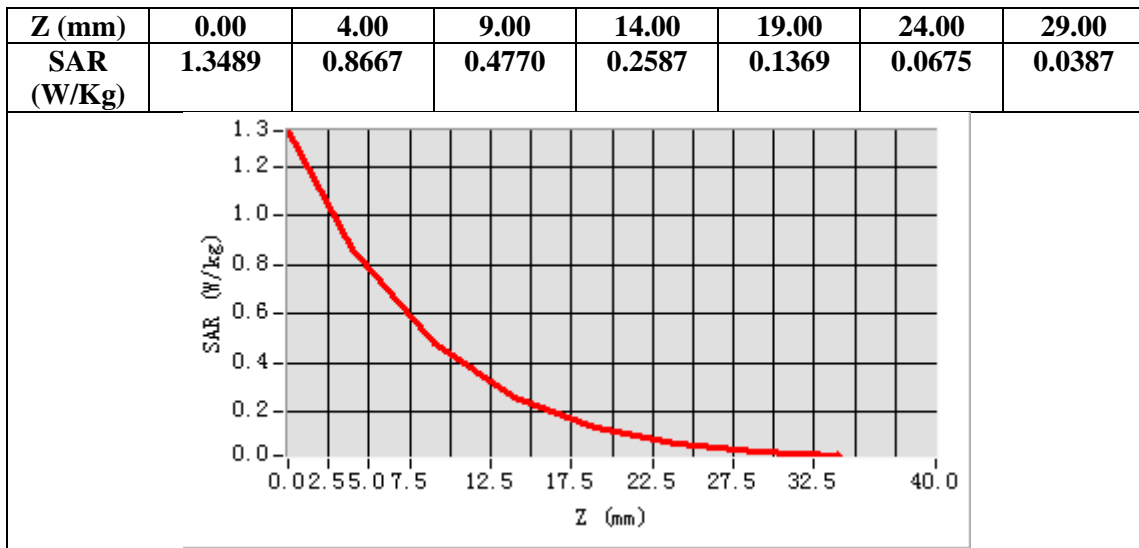

Test Laboratory: AGC Lab

Date: Mar. 21,2017

WCDMA Band V Low-Body-Towards Grounds (HSUPA Subtest 3)

DUT: Smartphone-Miracle 6.0 S; Type: Miracle 6.0 S

Communication System: UMTS; Communication System Band: BAND V UTRA/FDD; Duty Cycle:1: 1; Conv.F=5.94; Frequency: 826.4 MHz; Medium parameters used: $f = 835\text{MHz}$; $\sigma = 0.94 \text{ mho/m}$; $\epsilon_r = 55.84$; $\rho = 1000 \text{ kg/m}^3$; Phantom section: Flat Section
Ambient temperature ($^{\circ}\text{C}$): 21.4, Liquid temperature ($^{\circ}\text{C}$): 21.3

SATIMO Configuration:

- Probe: SSE5; Calibrated: 12/05/2016; Serial No.: SN 14/16 EP308
- Sensor-Surface: 4mm (Mechanical Surface Detection)
- Phantom: SAM twin phantom
- Measurement SW: OpenSAR V4_02_32

Configuration/ WCDMA Band V Low -Body-Back/Area Scan: Measurement grid: dx=8mm, dy=8mm

Configuration/ WCDMA Band V Low -Body-Back/Zoom Scan: Measurement grid: dx=8mm,dy=8mm, dz=5mm;

Area Scan	sam_direct_droit2_surf8mm.txt
ZoomScan	5x5x7,dx=8mm dy=8mm dz=5mm,Complete
Phantom	Validation plane
Device Position	Body Back
Band	WCDMA Band V
Channels	Low
Signal	CDMA (Crest factor: 1.0)

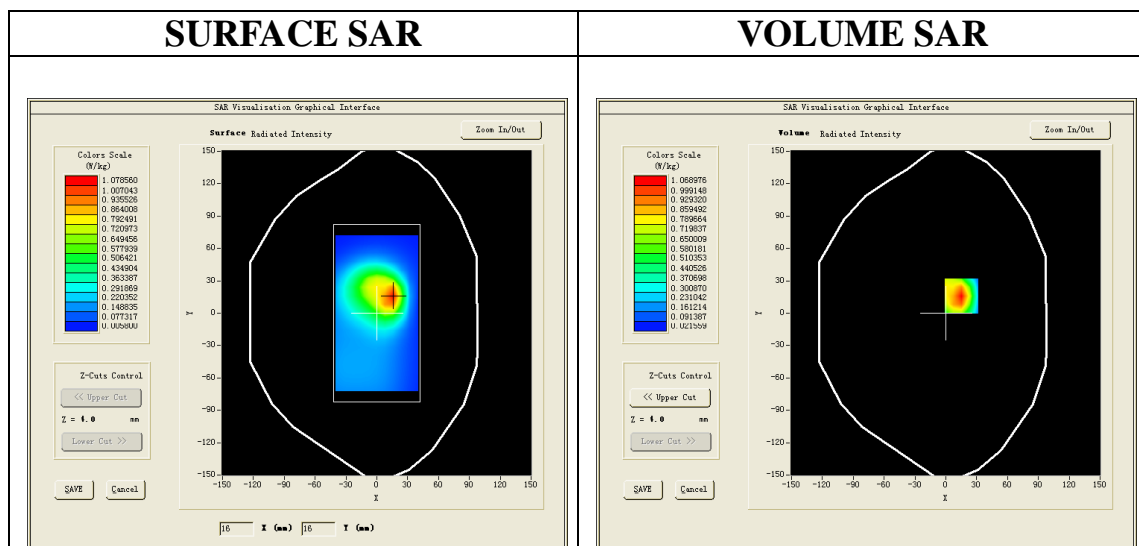

Maximum location: X=15.00, Y=16.00

SAR Peak: 1.69 W/kg

SAR 10g (W/Kg)	0.560226
SAR 1g (W/Kg)	1.006382

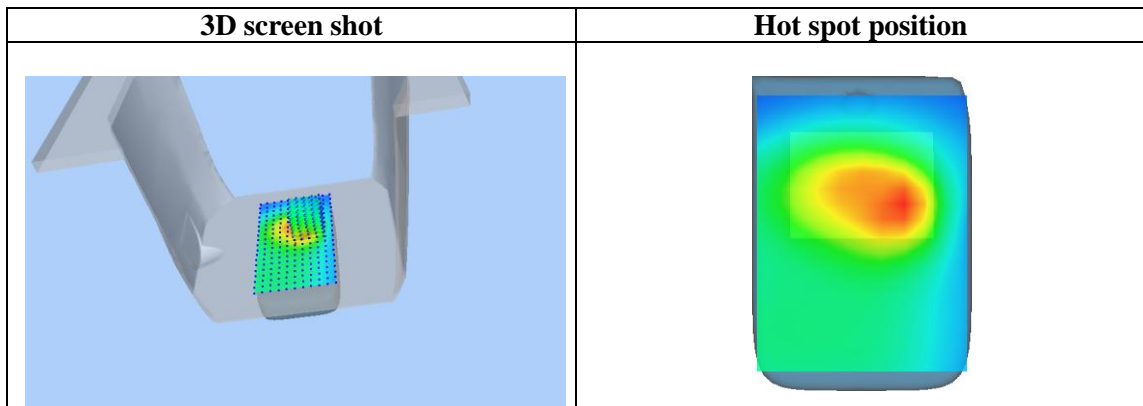
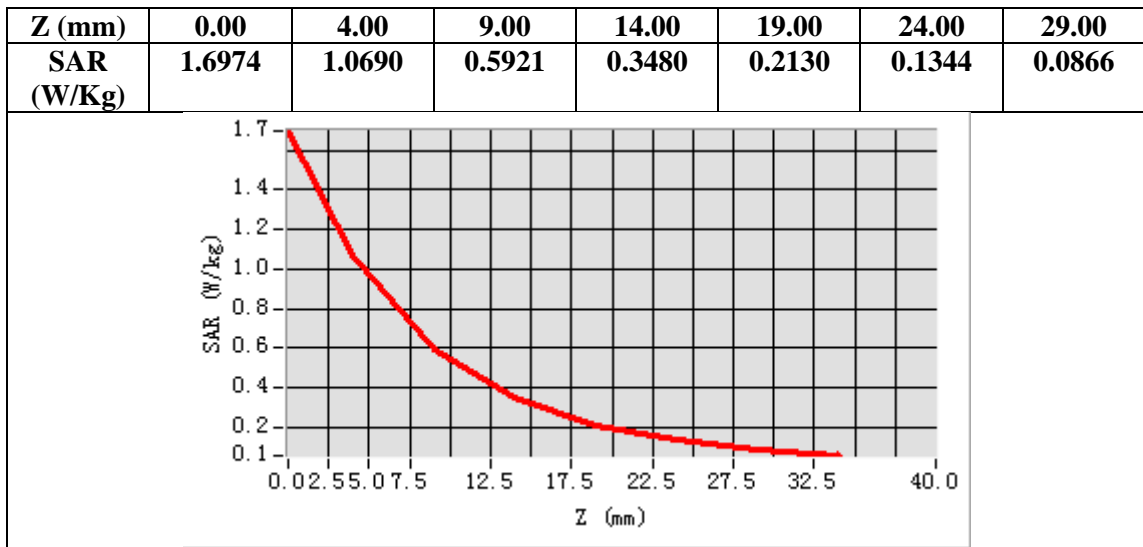

APPENDIX C. TEST SETUP PHOTOGRAPHS

LEFT- CHEEK TOUCH

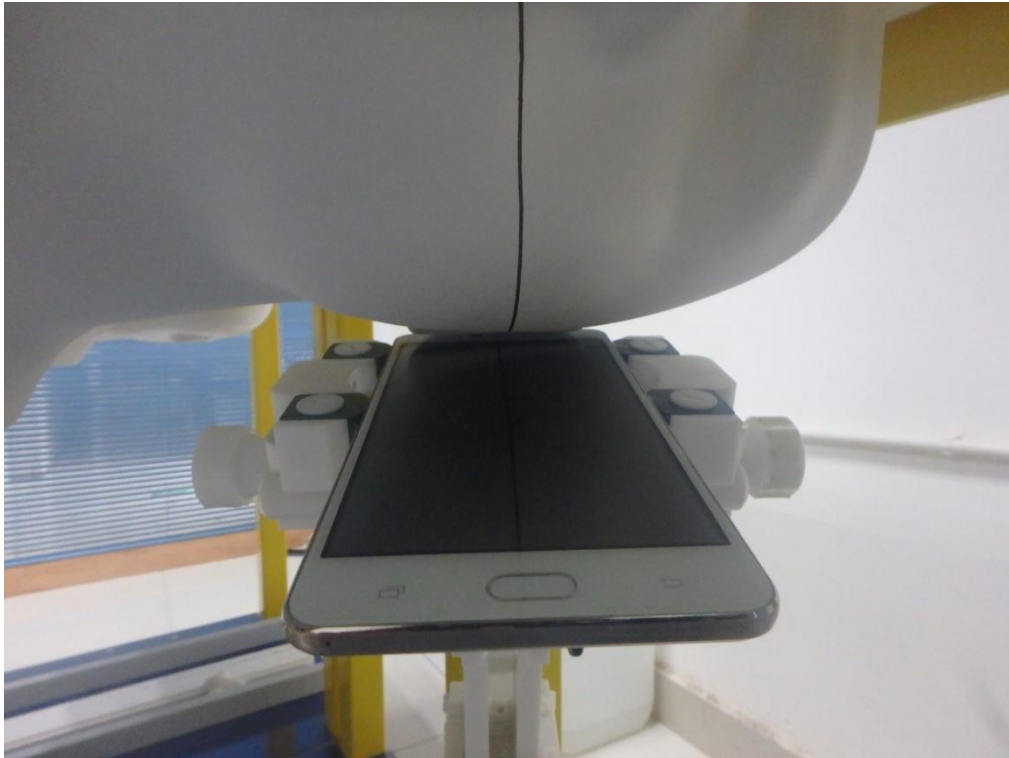

LEFT-TILT 15°

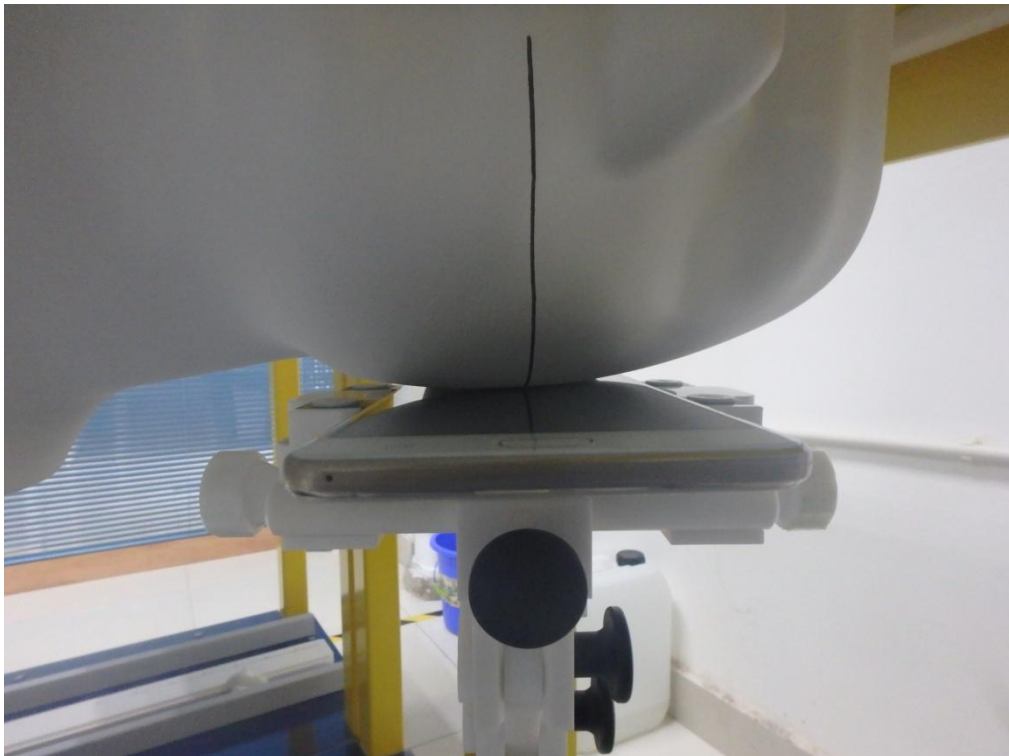

RIGHT- CHEEK TOUCH

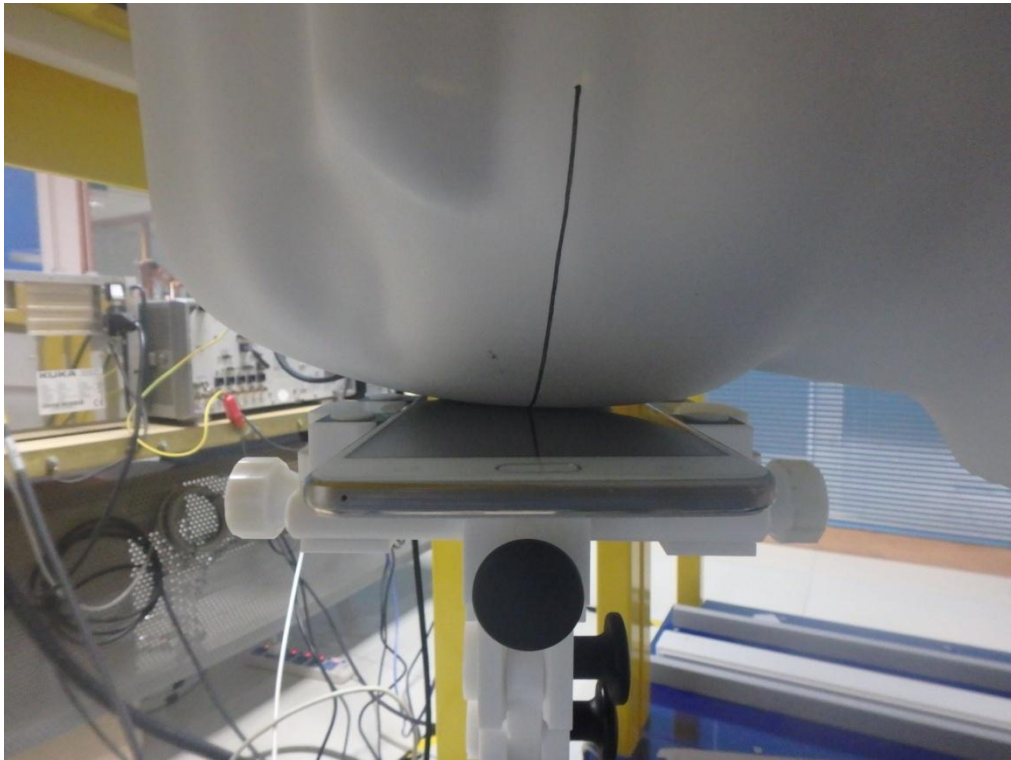

RIGHT-TILT 15°

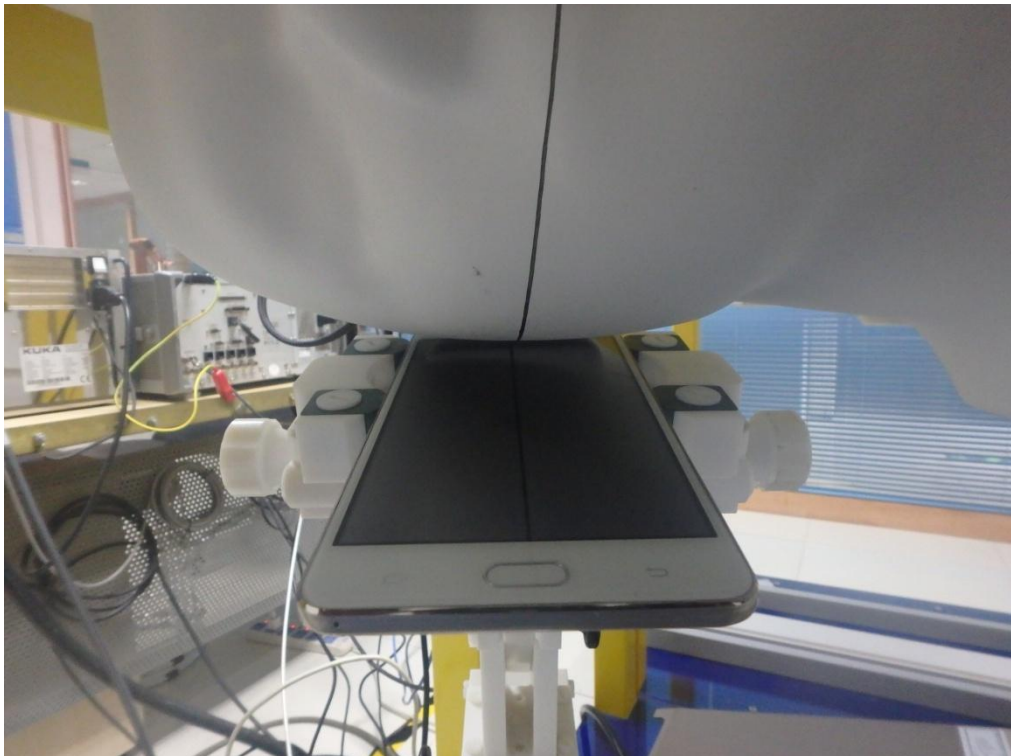

Body Back 5mm

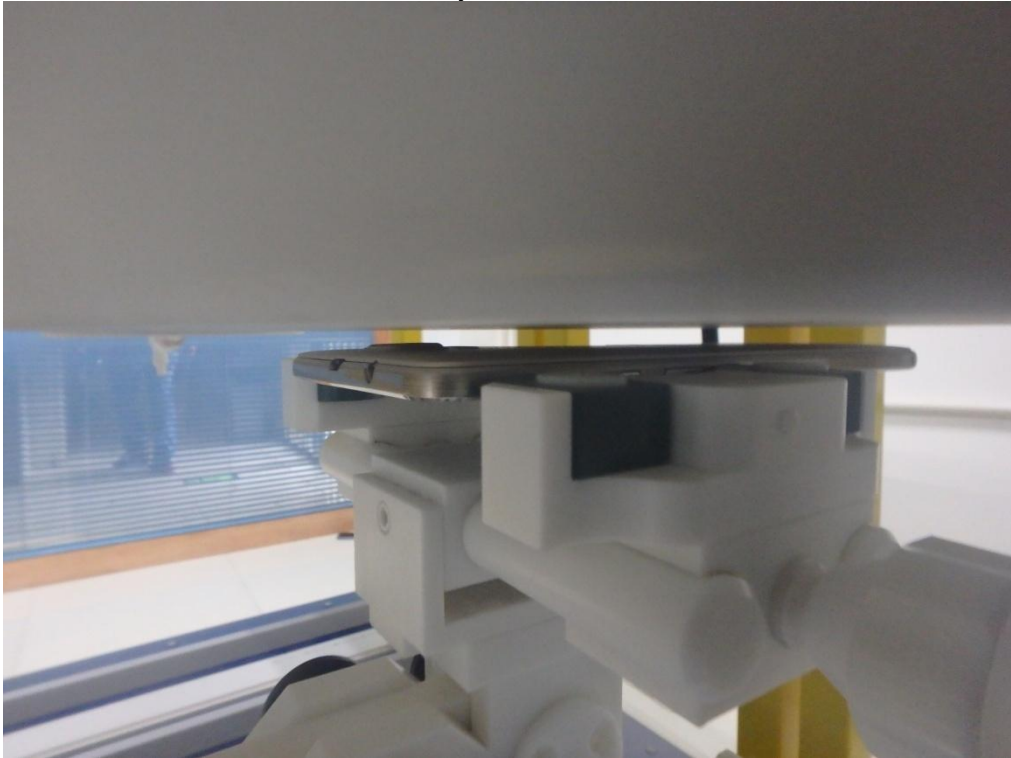

Body Front 5mm

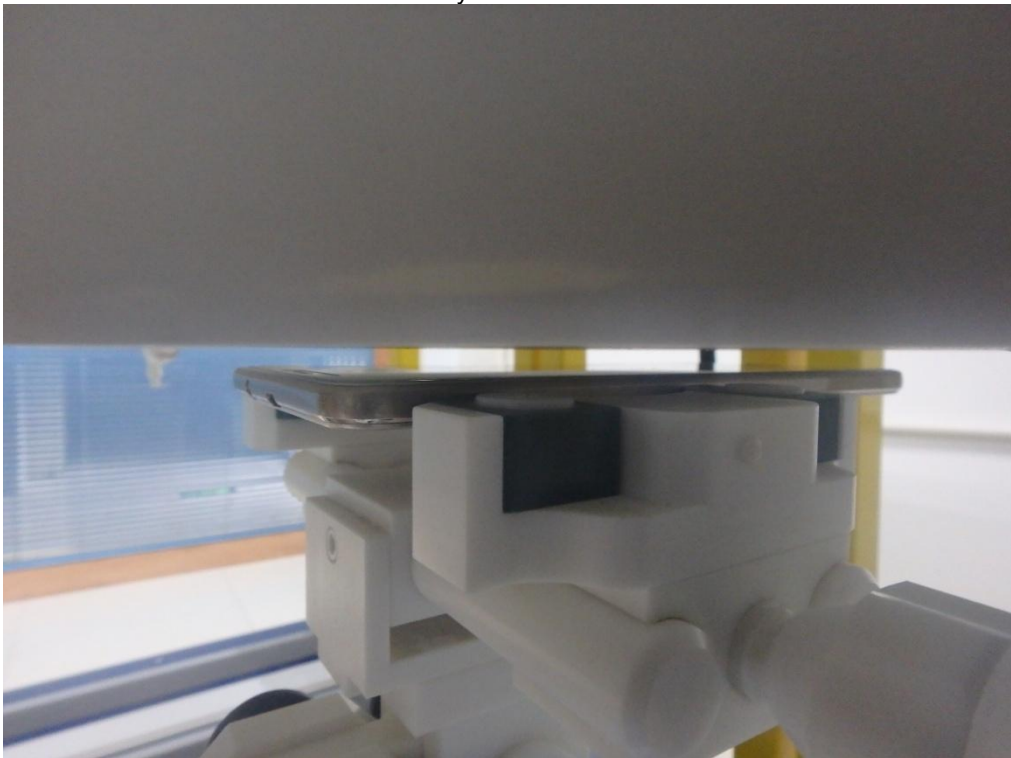

Edge 1(Top) 10mm-Hotspot Mode



Edge 2(Right) 10mm-Hotspot Mode



Edge 3(Bottom) 10mm-Hotspot Mode





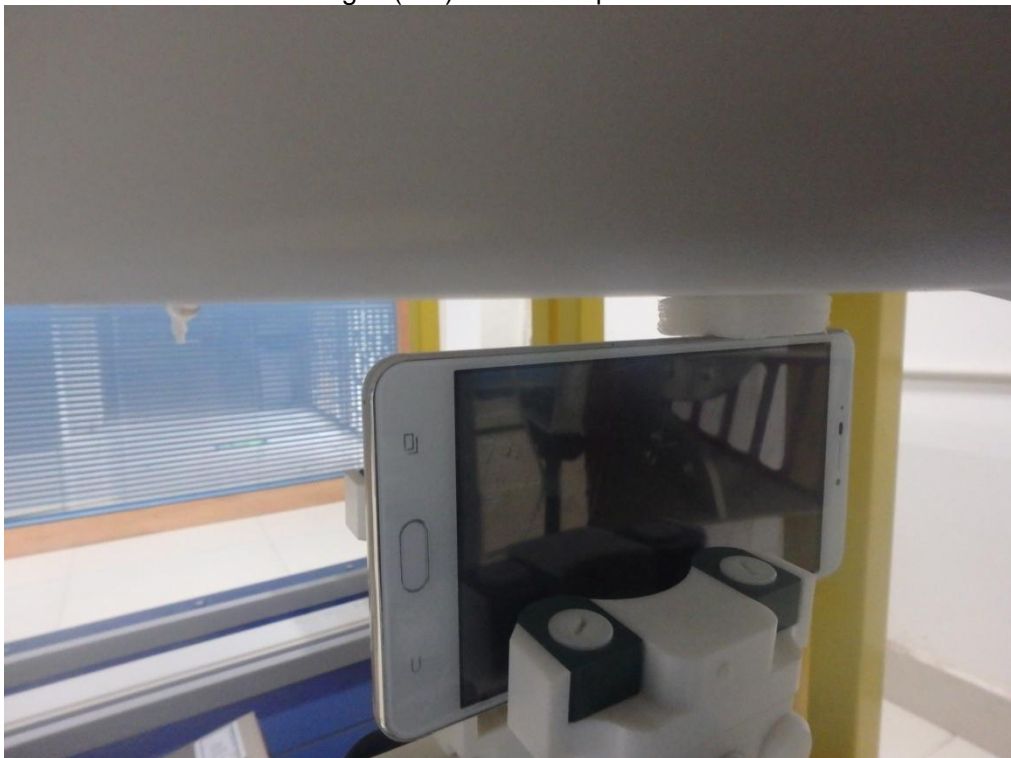



Edge 4(Left) 10mm-Hotspot Mode



DEPTH OF THE LIQUID IN THE PHANTOM—ZOOM IN

Note : The position used in the measurement were according to IEEE 1528-2013

<p>835MHz head</p>  A photograph showing a ruler placed vertically inside the head of a phantom. A white arrow points to the liquid level, which is approximately at the 15.5 cm mark on the ruler.	<p>835MHz body</p>  A photograph showing a ruler placed vertically inside the body of a phantom. A white arrow points to the liquid level, which is approximately at the 17.5 cm mark on the ruler.
<p>1900MHz head</p>  A photograph showing a ruler placed vertically inside the head of a phantom. A white arrow points to the liquid level, which is approximately at the 15.5 cm mark on the ruler.	<p>1900MHz body</p>  A photograph showing a ruler placed vertically inside the body of a phantom. A white arrow points to the liquid level, which is approximately at the 17.5 cm mark on the ruler.
<p>2450MHz head</p>  A photograph showing a ruler placed vertically inside the head of a phantom. A white arrow points to the liquid level, which is approximately at the 15.5 cm mark on the ruler.	<p>2450MHz body</p>  A photograph showing a ruler placed vertically inside the body of a phantom. A white arrow points to the liquid level, which is approximately at the 17.5 cm mark on the ruler.

APPENDIX D. CALIBRATION DATA

Refer to Attached files.