

M7304HRF 7" Wireless Monitor User Guide



CONVOY TECHNOLOGIES



Please read this instruction manual before installation

Precautions

Storage and keeping

- Do not expose the monitor to direct heat or cold. The storage temperature is -30 ~+80°C, and the operating temperature is -10 ~+60°C. The Humidity is Rh90%.
- Never use this device near a bathtub, wash basin, kitchen, damp basement, swimming pool or similar place.
- Never use this device in environments with excessive moisture, dust or smoke.
- Avoid dropping or striking this device.
- Avoid using this device in enclosed spaces, areas with excessive vibration or subject to several impacts.
- Never puncture, scratch or use abrasive cleaning materials on this device.
- Do not place cables where they may be pinched or stepped on.
- Leave at least a 2" space between the monitor and walls, cabinets or other objects to allow adequate air circulation around the unit.
- The monitor is not designed to be waterproof.

Operating Precautions

- The device may be powered by a 12-24 volt automotive battery or vehicle electrical system.
- Make sure all cables are connected properly observe polarity. Improper cable connections may damage the monitor. Remove the power cable connections when you do not intend to use the unit.

FCC declaration of conformity

NOTE: This equipment has been tested and found to comply with the limits for a Class B digital device, pursuant to part 15 of the FCC Rules. These limits are

designed to provide reasonable protection against harmful interference in a residential installation. This equipment generates uses and can radiate radio

frequency energy and, if not installed and used in accordance with the instructions, may cause harmful interference to radio communications. However, there is no guarantee that interference will not occur in a particular installation. If this equipment does cause harmful interference to radio or television reception, which can be determined by turning the equipment off and on, the user is encouraged to try to correct the interference by one or more of the following measures:

- Reorient or relocate the receiving antenna.
- Increase the separation between the equipment and receiver.
- Connect the equipment into an outlet on a circuit different from that to which the receiver is connected.
- Consult the dealer or an experienced radio/TV technician for help

Changes or modifications not expressly approved by the party responsible for compliance could void the user's authority to operate the equipment.

This device complies with Part 15 of the FCC Rules. Operation is subject to the following two conditions:

(1) This device may not cause harmful interference, and (2) this device must accept any interference received, including interference that may cause undesired operation.

RF Exposure Warning Statements:

This equipment complies with FCC radiation exposure limits set forth for an uncontrolled environment. This equipment shall be installed and operated with minimum distance 20cm between the radiator & body.

Accessories

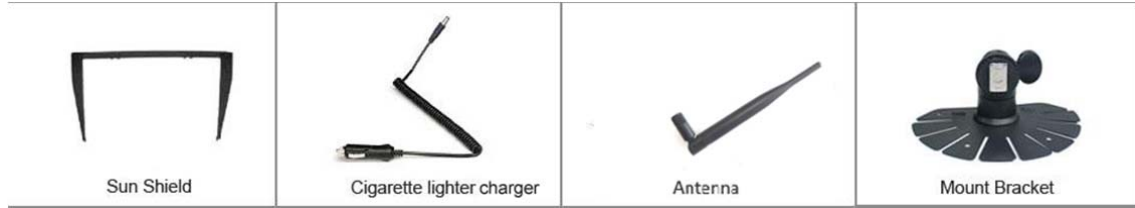

Product Dimension

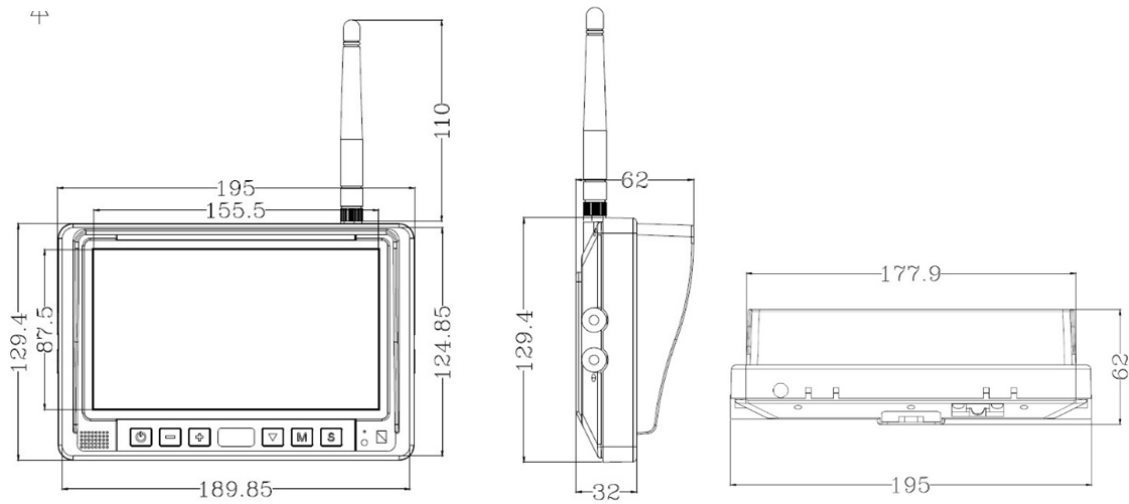

Product Specification

Product Specification	
Audio output	8Ω 1W
Loudspeaker	1 x 2415 speaker
Supply voltage	9~36V
Power supply connection	5.5mm DC Jack (Female)
Power Consumption	0.25A @12VDC input voltage (3W)
Video channel input	4 wireless channels (Quad split-screen display)
Antenna	External 3dBi omnidirectional antenna
Effective RF range	150m (Open area, line-of-sight)
Operating frequency	2.4GHz
Vibration rating	10G
Reverse Grid lines	Yes
Channel image orientation	Mirror / Flip (Individual camera input channel)
Video Recording	Supported 4 Channels (640x480 resolution per channel with audio)
Recorded file format	MPEG4
Storage media	Micro SD card (Supported Max.128GB)
Display Screen Type	7" high brightness IPS panel
Display Screen Resolution	1024*600
Contrast	500:1
Brightness	450cd/m ²
Viewing angle	U:85/D:85, R/L:85
Screen Aspect ratio	16:9
Screen Size	17.6cm (7-inch Diagonal); 15.4cm (width) x 8.6cm (height)
Operation Temperature	-10°C~+60°C,RH90%
Storage Temperature	-20°C~+70°C,RH90%

Connection Diagram

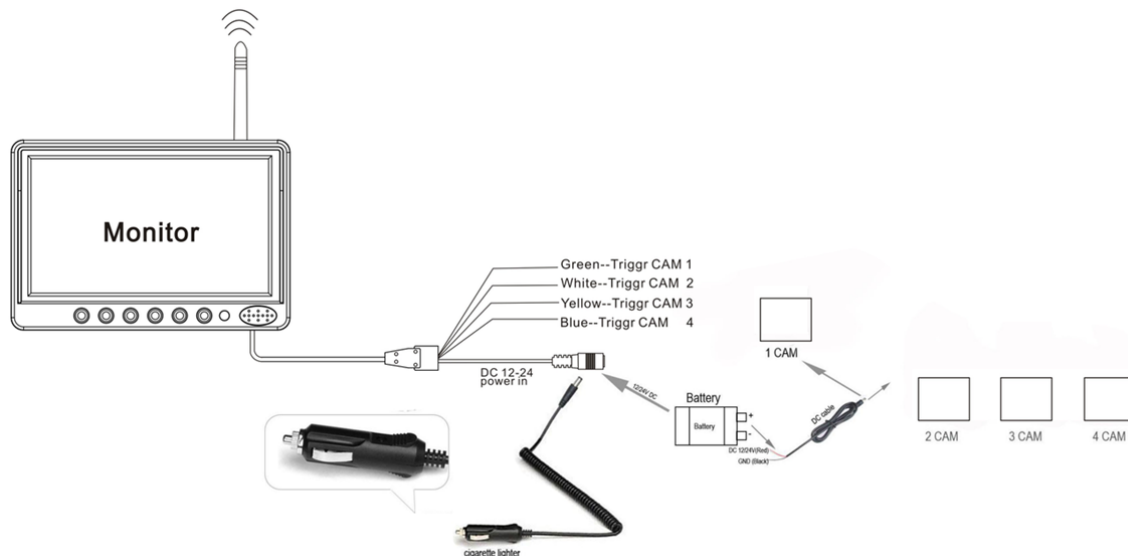

User Interface Operation

Key button definition



(Buttons from left to right order)

- Power: Screen ON/OFF
- Left/ right arrow: In menu mode, scroll up/ down menu items
Increment/ decrement setting value
In live view mode, speaker volume up/ down
- Tick icon/ OK: To confirm selection
- Camera icon: Switch camera channels in live view mode

Main Menu

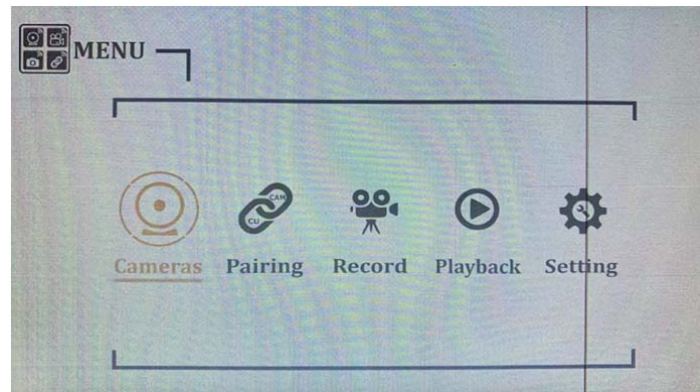

'Cameras' menu

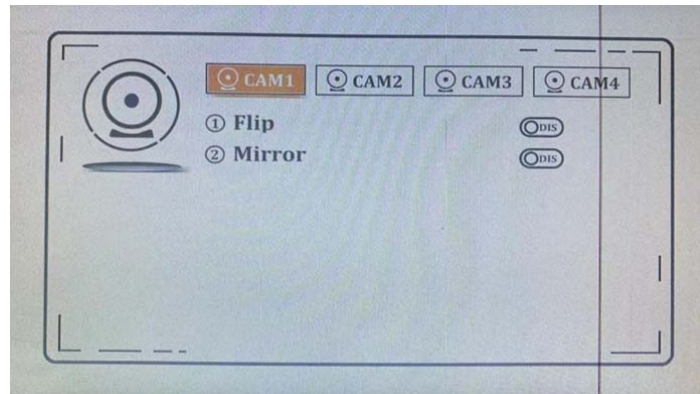

- This menu option is used to adjust the image orientation of the camera as needed. Flip and Mirror settings are permanently stored on the camera side, if the camera is re-paired to the same monitor or to a new monitor, the stored Flip, Mirror settings will **NOT** be reset.

'Pairing' menu

- The wireless camera is pre-paired to the monitor when shipped, there's no need to go through the pairing procedure.

In case additional cameras are to be added to the system (maximum 4 wireless cameras can be added), please follow the below procedure.

1. Enter In the **Pairing menu**, you may select **Pairing Camera** or **Delete Camera**

Select "**Pairing Camera**" and press OK button to enter

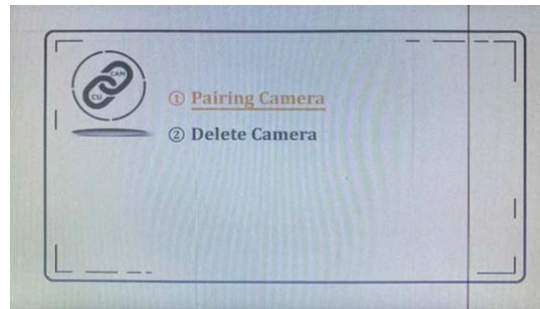

In 'Pairing Camera' sub-menu, Select the camera number 1~4 to be paired and assign the camera image to be displayed on the H-View layout. Press the OK button, the pairing process will start automatically.

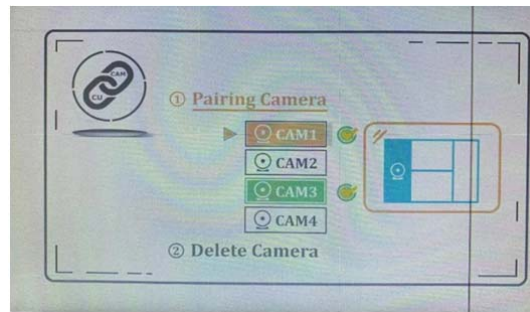

Now power on the camera that you wish to pair, the system will start searching for the active camera nearby. The searching process may take up to 20 sec depending on the radio signal strength and the surrounding interference.

As soon as the radio link is established between the wireless camera and the monitor, a dialog box will pop up on the screen with a default password of "0000", the user has to press the OK button to confirm and the pairing process is complete.

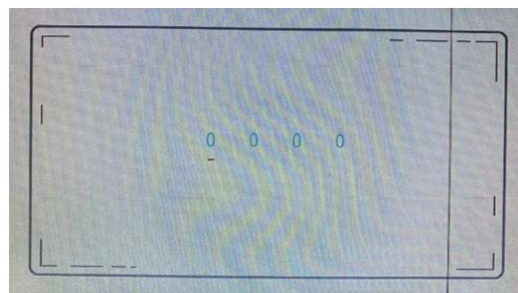

- The default password can ONLY be changed by the system operator (not the driver), this can be done by entering the hidden factory menu by pressing a certain key combination.

'Record' menu

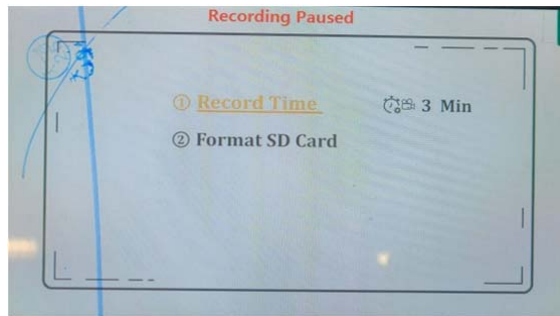

Record Time: Sets the length (recording time) of each recorded video segment / file.
(1,3,5mins)

Format SD Card: Format a SD card

Insert the microSD card to the slot as indicated in the picture below. Recording will start automatically, the system keeps recording and cannot be terminated manually by user, unless the monitor is being powered off / or the SD card is being removed.

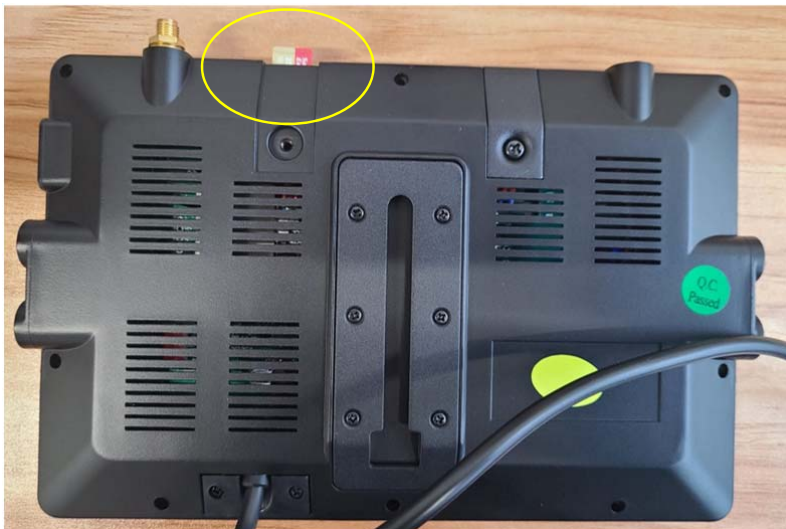

Note: The recording process will be paused temporarily when entering the Menu screen and resumed when leaving the Menu screen.

'Playback' menu

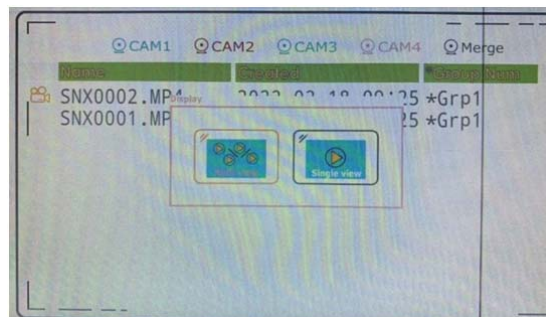

The picture above shows 2-channel recorded files. Each camera channel is recorded as a single file and grouped with a number. Each group can have a maximum of 4 recorded channels. If you choose "Mult-view," it will show all recorded channels in the same group in quad split-screen mode. If you choose "Single View", it will playback only the selected channel.

'Setting' menu

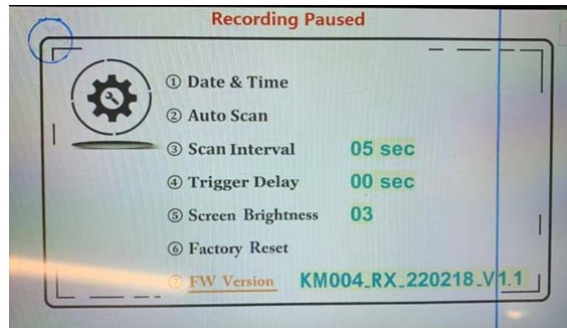

- 1. Date & Time:** Sets the data and time
- 2. Auto Scan:** Enable or disable auto scan, the single camera view will be repeatedly switching over from CAM 1~4 in a loop.
- 3. Scan Interval:** Sets the "Switching time interval" for auto scan mode
- 4. Trigger Delay:** Sets the **Return Time** " after a trigger event. (returning to the previous displayed camera channel)
- 5. Screen Brightness:** Set the Screen Brightness in different steps
- 6. Factory Reset:** Reset the system parameters to factory default
*(All paired camera entries will be erased)
- 7. FW version:** Display the current firmware version of the device