



中认信通
CHINA CERTIFICATION ICT CO., LTD (DONGGUAN)



TEST REPORT

Applicant: Aqua Broadcast Limited

Address: FCC: Unit 7,First Quarter. Blenheim Road, Epsom, KT199QN, United Kingdom
IC: Unit 7,First Quarter, Blenheim Road, Epsom, Surrey KT19 9QN,United Kingdom Of Great Britain And Northern Ireland

FCC ID: 2A9RR-COBALT10

IC: 30007-COBALT10

HVIN: COBALT10

Product Name: Cobalt FM Transmitter

**Standard(s): FCC Part 73
ISED BETS-6 Issue 2 August 2005
ANSI C63.26-2015**

The above equipment has been tested and found compliance with the requirement of the relative standards by China Certification ICT Co., Ltd (Dongguan)

Report Number: CR230205791-00AM2

Date Of Issue: 2023/8/18

Reviewed By: Sun Zhong

Sun Zhong

Title: Manager

Test Laboratory: China Certification ICT Co., Ltd (Dongguan)

No. 113, Pingkang Road, Dalang Town, Dongguan,
Guangdong, China
Tel: +86-769-82016888

Test Facility

The Test site used by China Certification ICT Co., Ltd (Dongguan) to collect test data is located on the No. 113, Pingkang Road, Dalang Town, Dongguan, Guangdong, China.

The lab has been recognized as the FCC accredited lab under the KDB 974614 D01 and is listed in the FCC Public Access Link (PAL) database, FCC Registration No. : 442868, the FCC Designation No. : CN1314.

The lab has been recognized by Innovation, Science and Economic Development Canada to test to Canadian radio equipment requirements, the CAB identifier: CN0123.

Declarations

China Certification ICT Co., Ltd (Dongguan) is not responsible for the authenticity of any test data provided by the applicant. Data included from the applicant that may affect test results are marked with a triangle symbol “▲”. Customer model name, addresses, names, trademarks etc. are not considered data.

Unless otherwise stated the results shown in this test report refer only to the sample(s) tested.

This report cannot be reproduced except in full, without prior written approval of the Company.

This report is valid only with a valid digital signature. The digital signature may be available only under the Adobe software above version 7.0.

This report may contain data that are not covered by the accreditation scope and shall be marked with an asterisk “★”.

CONTENTS

TEST FACILITY	2
DECLARATIONS.....	2
DOCUMENT REVISION HISTORY	5
1. GENERAL INFORMATION.....	6
1.1 PRODUCT DESCRIPTION FOR EQUIPMENT UNDER TEST (EUT)	6
1.2 DESCRIPTION OF TEST CONFIGURATION.....	7
1.2.2 Support Equipment List and Details	7
1.2.3 Support Cable List and Details	7
1.2.4 Block Diagram of Test Setup.....	8
1.3 MEASUREMENT UNCERTAINTY	9
2. SUMMARY OF TEST RESULTS	10
3. REQUIREMENTS AND TEST PROCEDURES	11
3.1 TRANSMITTER FREQUENCY STABILITY	11
3.1.1 Applicable Standard.....	11
3.1.2 Test Procedure	11
3.1.3 EUT Setup Block Diagram	11
3.2 TRANSMITTER OUTPUT POWER	12
3.2.1 Applicable Standard.....	12
3.2.2 Test Procedure	13
3.3 OCCUPIED BANDWIDTH & EMISSION MASK.....	13
3.3.1 Applicable Standard.....	13
3.5.2 Test Procedure	14
3.4 SPURIOUS EMISSION AT ANTENNA TERMINAL	15
3.4.1 Applicable Standard.....	15
3.4.2 Test Procedure	15
3.5 SPURIOUS RADIATED EMISSIONS.....	16
3.5.1 Applicable Standard.....	16
3.5.2 Test Procedure	16
3.6 MODULATION CHARACTERISTICS.	17
3.6.1 Applicable Standard.....	17
3.6.2 Test Procedure	17
3.6.2.1.1 Modulation limiting	17
3.6.2.1.2 EUT Setup Block Diagram	18
3.6.2.2.1 Audio frequency response.....	18
3.6.2.2.2 EUT Setup Block Diagram	18
4. Test DATA AND RESULTS.....	19
4.1 TRANSMITTER FREQUENCY STABILITY	19
4.2 TRANSMITTER OUTPUT POWER	22
4.3 OCCUPIED BANDWIDTH & EMISSION MASK.....	25

4.4 SPURIOUS EMISSION AT ANTENNA TERMINAL30

4.5 SPURIOUS RADIATED EMISSIONS.....32

4.6 MODULATION CHARACTERISTIC.....35

5 MAXIMUM PERMISSIBLE EXPOSURE (MPE) 39

5.1 APPLICABLE STANDARD.....39

DOCUMENT REVISION HISTORY

Revision Number	Report Number	Description of Revision	Date of Revision
1.0	CR230205791-00A	Original Report	2023/5/16
2.0	CR230205791-00AM1	Update Section 4.2 and 4.3	2023/7/4
3.0	CR230205791-00AM2	Update Section 4.1	2023/8/18

1. GENERAL INFORMATION

1.1 Product Description for Equipment under Test (EUT)

EUT Name:	Cobalt FM Transmitter
Trade Name:	Aqua Broadcast
EUT Model:	COBALT10
Operation Frequency:	88-108 MHz
Modulation Type:	FM
Rated Input Voltage:	120Vac
Serial Number:	1TPA-1
EUT Received Date:	2022/12/9
EUT Received Status:	Good

1.1.1 Test Frequency Detail:

Per C63.26-2015, section 5.1, the below frequency was performed the test:

Test Channel	Frequency (MHz)
Low	88.1
Middle	98.1
High	107.9

1.2 Description of Test Configuration

1.2.1 EUT Operation Condition:

EUT Operation Mode:	The system was configured for testing in Engineering Mode, which was provided by the manufacturer▲.
Equipment Modifications:	No
EUT Exercise Software:	No

1.2.2 Support Equipment List and Details

Manufacturer	Description	Model	Serial Number
Kingston	USB Disk	2GB	CH 031308
SanDisk	USB Disk	16 GB	BL201026210Z
ZHAOXIN	DC Power Supply	RXN-6010D	21R6010D0912386
Lenovo	Laptop	T460S	60PDTEK8
Sennheiser	Earphone	HD 203	/
Tenda	router	AX2 Pro	2205D5810100000041
Lini-T	Signal source	UTG2025A	/
Zctek	Audio signal generator	ZC1212-BL	/
Rohde&Schwarz	Signal source	UPV	103447
BEW	Load	TF300-6-B	/

1.2.3 Support Cable List and Details

Cable Description	Shielding Type	Ferrite Core	Length (m)	From Port	To
Power cable	No	Yes	1.5	EUT	DC Power Supply
RJ45 Cable	No	No	5	Laptop	EUT
RJ45 Cable	No	No	5	Router	EUT
USB Cable	No	No	5	ZC1212-BL	EUT
BNC cable*2	No	No	5	UTG2025A	EUT
BNC cable*4	No	No	5	EUT	ZC1212-BL
BNC cable*2	No	No	5	EUT	UPV
DB25 Cable	No	No	5	Laptop	EUT
Coaxial Cable	Yes	No	0.8	EUT	Load

1.2.4 Block Diagram of Test Setup

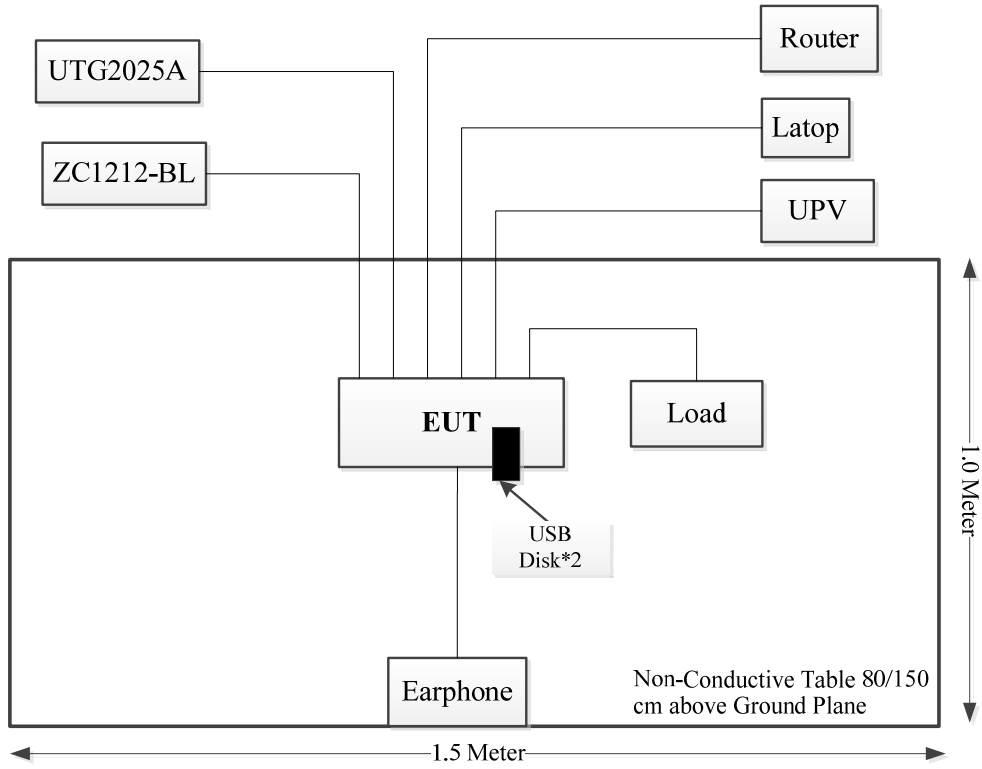

1.3 Measurement Uncertainty

Otherwise required by the applicant or Product Regulations, Decision Rule in this report did not consider the uncertainty. The extended uncertainty given in this report is obtained by combining the standard uncertainty times the coverage factor K with the 95% confidence interval.

Parameter	Measurement Uncertainty
Occupied Channel Bandwidth	±5 %
RF output power, conducted	±0.61dB
Power Spectral Density, conducted	±0.61 dB
Unwanted Emissions, radiated	30M~200MHz: 4.15 dB,200M~1GHz: 5.61 dB,1G~6GHz: 5.14 dB, 6G~18GHz: 5.93 dB,18G~26.5G:5.47 dB,26.5G~40G:5.63 dB
Unwanted Emissions, conducted	±1.26 dB
Temperature	±1 °C
Humidity	±5%
DC and low frequency voltages	±0.4%
Duty Cycle	1%

2. SUMMARY OF TEST RESULTS

Standard/Rule(s)	Description Of Test	Result
FCC §2.1055, §73.1545 BETS-6 Clause 6.2.3	Frequency Stability	Compliance
FCC §2.1046, §73.267, §73.811(a), §73.812(a), §73.840, BETS-6 Clause 6.1.3	RF Output Power	Compliance
FCC §2.1049, §73.317, BETS-6 Clause 6.3.3	Occupied Bandwidth & Emission Mask	Compliance
FCC §2.1051, §73.317 BETS-6 Clause 6.3.3	Spurious Emission at Antenna Terminal	Compliance
FCC §2.1053, §73.317 BETS-6 Clause 6.3.3	Spurious Radiated Emissions	Compliance
FCC §2.1047, BETS-6 Clause 4.2	Modulation Characteristics	Compliance
FCC §1.1310 & §2.1091 RSS-102 Clause 4	Maximum Permissible Exposure (MPE)	Compliance

3. REQUIREMENTS AND TEST PROCEDURES

3.1 Transmitter Frequency Stability

3.1.1 Applicable Standard

FCC §73.1545

(b) FM stations.

(1) The departure of the carrier or center frequency of an FM station with an authorized transmitter output power more than 10 watts may not exceed ± 2000 Hz from the assigned frequency.

(2) The departure of the carrier or center frequency of an FM station with an authorized transmitter output power of 10 watts or less may not exceed ± 3000 Hz from the assigned frequency.

BETS-6 Clause 6.2.3

The frequency of the carrier shall remain within ± 1 kHz of the mean test frequency.

3.1.2 Test Procedure

Frequency Stability vs. Temperature: The equipment under test was connected to an external power supply and the RF output was connected to a frequency counter via feed-through attenuators. The EUT was placed inside the temperature chamber. The DC or AC leads and RF output cable exited the chamber through an opening made for the purpose.

After the temperature stabilized for approximately 20 minutes, the frequency output was recorded from the counter.

3.1.3 EUT Setup Block Diagram

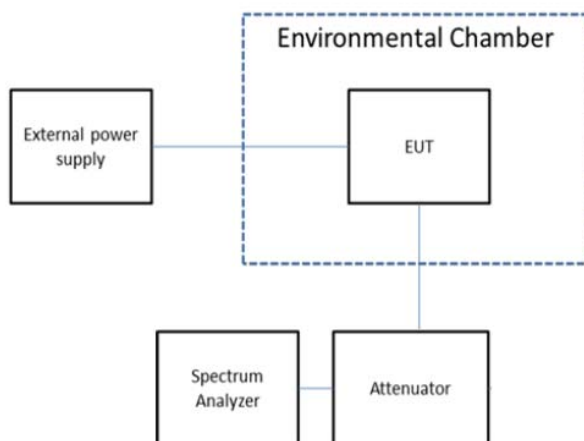

3.2 Transmitter Output Power

3.2.1 Applicable Standard

FCC §73.267

(b) Direct method. The direct method of power determination for an FM station uses the indications of a calibrated transmission line meter (responsive to relative voltage, current, or power) located at the RF output terminals of the transmitter. This meter must be calibrated whenever there is any indication that the calibration is inaccurate or whenever any component of the metering circuit is repaired or replaced. The calibration must cover, as a minimum, the range from 90% to 105% of authorized power. The meter calibration may be checked by measuring the power at the transmitter terminals while either:

(1) Operating the transmitter into the transmitting antenna, and determining actual operating power by the indirect method described in § 73.267(c); or

(2) Operating the transmitter into a load (of substantially zero reactance and a resistance equal to the transmission line characteristic impedance) and using an electrical device (within $\pm 5\%$ accuracy) or temperature and coolant flow indicator (within $\pm 4\%$ accuracy) to determine the power.

(3) The calibration must cover, as a minimum, the range from 90% to 105% of authorized power and the meter must provide clear indications which will permit maintaining the operating power within the prescribed tolerance or the meter shall be calibrated to read directly in power units.

FCC §73.811(a)

(a) Maximum facilities. LPFM stations will be authorized to operate with maximum facilities of 100 watts ERP at 30 meters HAAT. An LPFM station with a HAAT that exceeds 30 meters will not be permitted to operate with an ERP greater than that which would result in a 60 dBu contour of 5.6 kilometers. In no event will an ERP less than one watt be authorized. No facility will be authorized in excess of one watt ERP at 450 meters HAAT.

FCC §73.812(a)

(a) Effective radiated power (ERP) will be rounded to the nearest watt on LPFM authorizations.

FCC §73.840

The transmitter power output (TPO) of an LPFM station must be determined by the procedures set forth in § 73.267 of this part. The operating TPO of an LPFM station with an authorized TPO of more than ten watts must be maintained as near as practicable to its authorized TPO and may not be less than 90% of the minimum TPO nor greater than 105% of the maximum authorized TPO. An LPFM station with an authorized TPO of ten watts or less may operate with less than the authorized power, but not more than 105% of the authorized power.

BETS-6 Clause 6.1.3

The standard rating of power output for the transmitting equipment shall be as specified by the individual manufacturer. The transmitting equipment shall be capable of being adjusted to deliver the rated power output when the AC input voltage varies by 5% from the rated value.

The test report shall state the power output limits over which the transmitting equipment complies

with this specification.

Adjustment of the power output of the transmitting equipment shall permit operation over a range of at least from 50% to rated power output.

3.2.2 Test Procedure

Before performing this measurement, the power of the EUT shall be set or controlled to the maximum rating of the range for which equipment certification or verification is sought.

Except where otherwise specified, tests shall be performed at the ambient temperature, at the manufacturer's rated supply voltage, and with the transmitter modulating signal representative (i.e. typical) of those encountered in a real system operation.

The spectrum analyzer shall be configured with a resolution bandwidth that encompasses the entire occupied bandwidth (see section 6.7) of the EUT. If the spectrum analyzer's largest available resolution bandwidth is smaller than the occupied bandwidth of the EUT, it is permitted to use a narrower resolution bandwidth plus numerical integration, in linear power terms, over the occupied bandwidth of the transmitter in order to measure its output power, except when the emission is a wideband noise-like signal and being measured for peak power. For transmitters with constant envelope modulation, RF output power and field strength measurements performed on the fundamental frequency can be carried out with an unmodulated carrier. The method used shall be described in the test report.

3.3 Occupied Bandwidth & Emission Mask

3.3.1 Applicable Standard

FCC §73.317

(b) Any emission appearing on a frequency removed from the carrier by between 120 kHz and 240 kHz inclusive must be attenuated at least 25 dB below the level of the unmodulated carrier. Compliance with this requirement will be deemed to show the occupied bandwidth to be 240 kHz or less.

(c) Any emission appearing on a frequency removed from the carrier by more than 240 kHz and up to and including 600 kHz must be attenuated at least 35 dB below the level of the unmodulated carrier.

BETS-6 Clause 6.3.3

Spurious emissions of the transmitting equipment shall not exceed the values given below:

Spurious Emission	Maximum Value
Between 120 kHz and 240 kHz from the carrier frequency	-25 dB*
More than 240 kHz and up to and including 600 kHz from the carrier frequency	-35 dB*
More than 600 kHz from the carrier frequency, whichever is the stronger	-(43 + 10 log P)* or -80 dB* P = power in watts

* Referred to the power level of the unmodulated carrier.

3.5.2 Test Procedure

The occupied bandwidth or the “99% emission bandwidth” is defined as the frequency range between two points, one above and the other below the carrier frequency, within which 99% of the total transmitted power of the fundamental transmitted emission is contained. The occupied bandwidth shall be reported for all equipment in addition to the specified bandwidth required in the applicable RSSs.

In some cases, the “x dB bandwidth” is required, which is defined as the frequency range between two points, one at the lowest frequency below and one at the highest frequency above the carrier frequency, at which the maximum power level of the transmitted emission is attenuated x dB below the maximum in-band power level of the modulated signal, where the two points are on the outskirts of the in-band emission.

The following conditions shall be observed for measuring the occupied bandwidth and x dB bandwidth:

- The transmitter shall be operated at its maximum carrier power measured under normal test conditions.
- The span of the spectrum analyzer shall be set large enough to capture all products of the modulation process, including the emission skirts, around the carrier frequency, but small enough to avoid having other emissions (e.g. on adjacent channels) within the span.
- The detector of the spectrum analyzer shall be set to “Sample”. However, a peak, or peak hold, may be used in place of the sampling detector since this usually produces a wider bandwidth than the actual bandwidth (worst-case measurement). Use of a peak hold (or “Max Hold”) may be necessary to determine the occupied / x dB bandwidth if the device is not transmitting continuously.
- The resolution bandwidth (RBW) shall be in the range of 1% to 5% of the actual occupied / x dB bandwidth and the video bandwidth (VBW) shall not be smaller than three times the RBW value. Video averaging is not permitted.

Note: It may be necessary to repeat the measurement a few times until the RBW and VBW are in compliance with the above requirement.

For the 99% emission bandwidth, the trace data points are recovered and directly summed in linear power level terms. The recovered amplitude data points, beginning at the lowest frequency, are placed in a running sum until 0.5% of the total is reached, and that frequency recorded. The process is

repeated for the highest frequency data points (starting at the highest frequency, at the right side of the span, and going down in frequency). This frequency is then recorded. The difference between the two recorded frequencies is the occupied bandwidth (or the 99% emission bandwidth).

3.4 Spurious Emission at Antenna Terminal

3.4.1 Applicable Standard

FCC §73.317

(d) Any emission appearing on a frequency removed from the carrier by more than 600 kHz must be attenuated at least $43 + 10 \log_{10}(\text{Power, in watts})$ dB below the level of the unmodulated carrier, or 80 dB, whichever is the lesser attenuation.

BETS-6 Clause 6.3.3

Spurious emissions of the transmitting equipment shall not exceed the values given below:

Spurious Emission	Maximum Value
Between 120 kHz and 240 kHz from the carrier frequency	-25 dB*
More than 240 kHz and up to and including 600 kHz from the carrier frequency	-35 dB*
More than 600 kHz from the carrier frequency, whichever is the stronger	$-(43 + 10 \log P)^*$ or -80 dB* P = power in watts

* Referred to the power level of the unmodulated carrier.

3.4.2 Test Procedure

For emissions beyond 600 kHz from the edge of the authorized bandwidth, the resolution bandwidth shall be 100 kHz for frequencies at or below 1 GHz, and 1 MHz for frequencies above 1 GHz. However

In measuring unwanted emissions, the spectrum shall be investigated from 30 MHz or the lowest radio frequency signal generated or used in the equipment, whichever is lower, without going below 9 kHz, up to at least the applicable frequency given below:

(a) If the equipment operates below 10 GHz: to the tenth harmonic of the highest fundamental frequency or to 40 GHz, whichever is lower.

(b) If the equipment operates at or above 10 GHz and below 30 GHz: to the fifth harmonic of the highest fundamental frequency or to 100 GHz, whichever is lower.

(c) If the equipment operates at or above 30 GHz: to the fifth harmonic of the highest fundamental frequency or to 200 GHz, whichever is lower.

3.5 Spurious Radiated Emissions

3.5.1 Applicable Standard

FCC §73.317

(d) Any emission appearing on a frequency removed from the carrier by more than 600 kHz must be attenuated at least $43 + 10 \text{ Log}_{10}$ (Power, in watts) dB below the level of the unmodulated carrier, or 80 dB, whichever is the lesser attenuation.

BETS Clause 6.3.3

Spurious emissions of the transmitting equipment shall not exceed the values given below:

Spurious Emission	Maximum Value
Between 120 kHz and 240 kHz from the carrier frequency	-25 dB*
More than 240 kHz and up to and including 600 kHz from the carrier frequency	-35 dB*
More than 600 kHz from the carrier frequency, whichever is the stronger	$-(43 + 10 \log P)^*$ or -80 dB* P = power in watts

* Referred to the power level of the unmodulated carrier.

3.5.2 Test Procedure

In measuring unwanted emissions, the spectrum shall be investigated from 30 MHz or the lowest radio frequency signal generated or used in the equipment, whichever is lower, without going below 9 kHz, up to at least the applicable frequency given below:

(a) If the equipment operates below 10 GHz: to the tenth harmonic of the highest fundamental frequency or to 40 GHz, whichever is lower.

(b) If the equipment operates at or above 10 GHz and below 30 GHz: to the fifth harmonic of the highest fundamental frequency or to 100 GHz, whichever is lower.

(c) If the equipment operates at or above 30 GHz: to the fifth harmonic of the highest fundamental frequency or to 200 GHz, whichever is lower.

3.6 Modulation characteristics.

3.6.1 Applicable Standard

FCC §2.1047

- (a) Voice modulated communication equipment. A curve or equivalent data showing the frequency response of the audio modulating circuit over a range of 100 to 5000 Hz shall be submitted. For equipment required to have an audio low-pass filter, a curve showing the frequency response of the filter, or of all circuitry installed between the modulation limiter and the modulated stage shall be submitted.
- (b) Equipment which employs modulation limiting. A curve or family of curves showing the percentage of modulation versus the modulation input voltage shall be supplied. The information submitted shall be sufficient to show modulation limiting capability throughout the range of modulating frequencies and input modulating signal levels employed.
- (c) Single sideband and independent sideband radiotelephone transmitters which employ a device or circuit to limit peak envelope power. A curve showing the peak envelope power output versus the modulation input voltage shall be supplied. The modulating signals shall be the same in frequency as specified in paragraph (c) of §2.1049 for the occupied bandwidth tests.
- (d) Other types of equipment. A curve or equivalent data which shows that the equipment will meet the modulation requirements of the rules under which the equipment is to be licensed.

BETS-6 Clause 4.2

The designation of modulation and emission refers to the manner in which the carrier is modulated and transmitted. The transmitting equipment shall produce F3EGN emission for monophonic operation and F8EHF emission for stereophonic operation. The transmitting equipment shall be capable of operating with a frequency deviation of ± 75 kHz, which is equivalent to 100% modulation.

3.6.2 Test Procedure

3.6.2.1.1 Modulation limiting

C63.26-2015, Clause 5.3.2 Modulation limiting test methodology

Modulation limiting is the ability of a transmitter circuit to limit the transmitter from producing deviations in excess of a rated system deviation.

- a) Connect the equipment as illustrated in Figure 1.
- b) Adjust the transmitter per the manufacturer's procedure for full rated system deviation.
- c) Set the test RF Communications Test Set to measure peak positive deviation. Set the audio bandwidth for ≤ 0.25 Hz to ≥ 15000 Hz. Turn the de-emphasis function off.
- d) Apply a 1000 Hz modulating signal to the transmitter from the RF Communications Test Set, and adjust the level to obtain 60% of full rated system deviation. This is the 0 dB reference level.
- e) Increase the level from the audio generator by 20 dB in 5 dB increments recording the deviation as measured from the RF Communications Test Set in each step. Verify that the audio level used to make the OBW measurement is included in the sweep.
- f) Repeat for step e) at 300 Hz, 2500 Hz and 3000 Hz at a minimum using the 0 dB reference level obtained in step d).
- g) Set the RF Communications Test Set to measure peak negative deviation and repeat step d) through step f).
- h) The values recorded in step f) and step g) are the modulation limiting.
- i) Plot the data set as a percentage of deviation relative to the 0 dB reference point versus input voltage.

3.6.2.1.2 EUT Setup Block Diagram

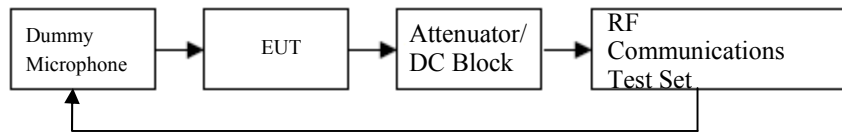

3.6.2.2.1 Audio frequency response

C63.26-2015, Clause 5.3.3.2 Audio frequency response test methodology—Constant Input

- a) Connect the equipment as illustrated in Figure 3.
- b) Set the RF Communications Test Set to measure peak positive deviation. Set the audio bandwidth for ≤ 50 Hz to $\geq 15\ 000$ Hz. Turn the de-emphasis function off.
- c) Adjust the transmitter per the manufacturer's procedure for full rated system deviation.
- d) Apply a 1000 Hz tone and adjust the RF Communications Test Set to produce 20% of the rated system deviation.
- e) Set the RF Communications Test Set to measure rms deviation and record the deviation reading as DEVREF.
- f) Set the RF Communications Test Set to the desired test frequency between 300 Hz and 3000 Hz.

3.6.2.2.2 EUT Setup Block Diagram

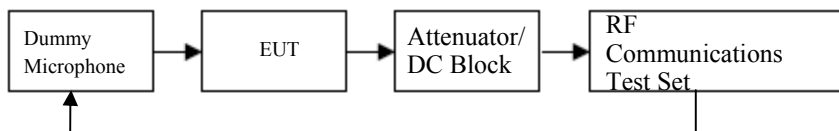

4. Test DATA AND RESULTS

4.1 Transmitter Frequency Stability

Serial Number:	1TPA-1	Test Date:	2023/5/9~2023/8/17
Test Site:	RF	Test Mode:	Transmitting
Tester:	Arthur Su	Test Result:	Pass

Environmental Conditions:

Temperature: (°C)	23.8~25.6	Relative Humidity: (%)	57~61	ATM Pressure: (kPa)	100~100.7
----------------------	-----------	------------------------------	-------	------------------------	-----------

Test Equipment List and Details:

Manufacturer	Description	Model	Serial Number	Calibration Date	Calibration Due Date
R&S	Spectrum Analyzer	FSU26	200445	2023/3/31	2024/3/30
Weinschel	Coaxial Attenuator	300-WA-FFN-30	1171672	Each time	N/A
YINSAIGE	Coaxial Cable	LMR300	NJ0100001	Each time	N/A
YINSAIGE	Coaxial Cable	LMR300	NJ0100002	Each time	N/A
BACL	TEMP&HUMI Test Chamber	BTH-150-40	30174	2023/3/31	2024/3/30
UNI-T	Multimeter	UT39A+	C210582554	2022/9/29	2023/9/28

* Statement of Traceability: China Certification ICT Co., Ltd (Dongguan) attests that all calibrations have been performed, traceable to National Primary Standards and International System of Units (SI).

Test Data:

$f_c = 88.1$ MHz				
Temperature	Voltage	Measured	Frequency Error	Part 73 Limit
°C	V _{AC}	MHz	Hz	Hz
0	120	88.1000643	64	±2000
10		88.1000641	64	
20		88.1000641	64	
30		88.1000642	64	
40		88.1000643	64	
50		88.1000643	64	
20		102	88.1000645	
20	138	88.1000645	65	

$f_c = 98.1$ MHz				
Temperature	Voltage	Measured	Frequency Error	Part 73 Limit
°C	V _{AC}	MHz	Hz	Hz
0	120	98.1000643	64	±2000
10		98.1000642	64	
20		98.1000641	64	
30		98.1000642	64	
40		98.1000643	64	
50		98.1000644	64	
20		102	98.1000643	
20	138	98.1000644	64	

$f_c = 107.9$ MHz				
Temperature	Voltage	Measured	Frequency Error	Part 73 Limit
°C	V _{AC}	MHz	KHz	Hz
0	120	107.9000642	64	±2000
10		107.9000642	64	
20		107.9000641	64	
30		107.9000645	65	
40		107.9000642	64	
50		107.9000644	64	
20		102	107.9000642	
20	138	107.9000643	64	

$f_c = 88.1$ MHz				
Temperature	Voltage	Measured	Frequency Error	BETS-6 Limit
°C	V_{AC}	MHz	Hz	Hz
20(reference)	120	88.1000640	0	±1000
5	120	88.1000645	1	
5	102	88.1000641	0	
5	138	88.1000642	0	
45	120	88.1000645	1	
45	102	88.1000646	1	
45	138	88.1000645	1	

$f_c = 98.1$ MHz				
Temperature	Voltage	Measured	Frequency Error	BETS-6 Limit
°C	V_{AC}	MHz	Hz	Hz
20(reference)	120	98.1000640	0	±1000
5	120	98.1000643	0	
5	102	98.1000641	0	
5	138	98.1000642	0	
45	120	98.1000641	0	
45	102	98.1000644	0	
45	138	98.1000645	1	

$f_c = 107.9$ MHz				
Temperature	Voltage	Measured	Frequency Error	BETS-6 Limit
°C	V_{AC}	MHz	Hz	Hz
20(reference)	120	107.9000640	0	±1000
5	120	107.9000647	1	
5	102	107.9000645	1	
5	138	107.9000645	1	
45	120	107.9000644	0	
45	102	107.9000648	1	
45	138	107.9000645	1	

4.2 Transmitter Output Power

Serial Number:	1TPA-1	Test Date:	2023/6/26~2023/7/4
Test Site:	RF	Test Mode:	Transmitting
Tester:	Arthur Su	Test Result:	Pass

Environmental Conditions:

Temperature: (°C)	22.1~25.5	Relative Humidity: (%)	45~52	ATM Pressure: (kPa)	99.9~100.5
----------------------	-----------	------------------------------	-------	------------------------	------------

Test Equipment List and Details:

Manufacturer	Description	Model	Serial Number	Calibration Date	Calibration Due Date
R&S	Spectrum Analyzer	FSU26	200445	2023/03/31	2024/03/30
Weinschel	Coaxial Attenuator	300-WA-FFN-30	1171672	Each time	N/A
YINSAIGE	Coaxial Cable	LMR300	NJ0100001	Each time	N/A
YINSAIGE	Coaxial Cable	LMR300	NJ0100002	Each time	N/A

* Statement of Traceability: China Certification ICT Co., Ltd (Dongguan) attests that all calibrations have been performed, traceable to National Primary Standards and International System of Units (SI).

Test Data:

Power Level	Frequency (MHz)	Output Power		Limit (Watts)
		dBm	Watts	
Maximum	88.1	39.86	9.7	<10.5
	98.1	39.85	9.7	<10.5
	107.9	39.94	9.9	<10.5
Minimum	88.1	29.88	0.97	>0.9
	98.1	29.87	0.97	>0.9
	107.9	29.95	0.99	>0.9

Note: The maximum rated power is 10 Watts and minimum rated power is 1 Watts.

Maximum rated power:

Low Channel

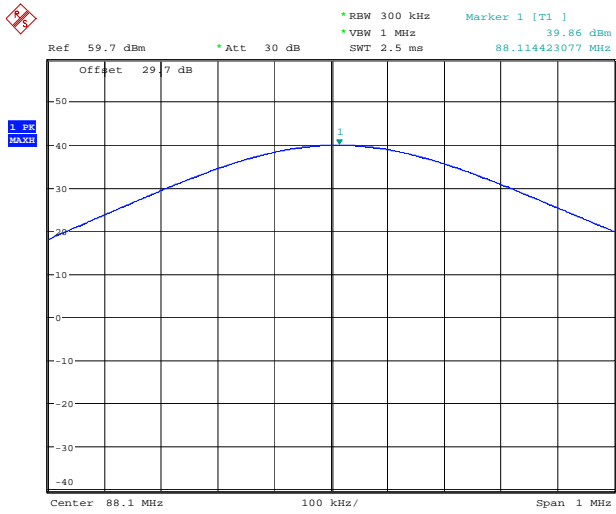

Middle Channel

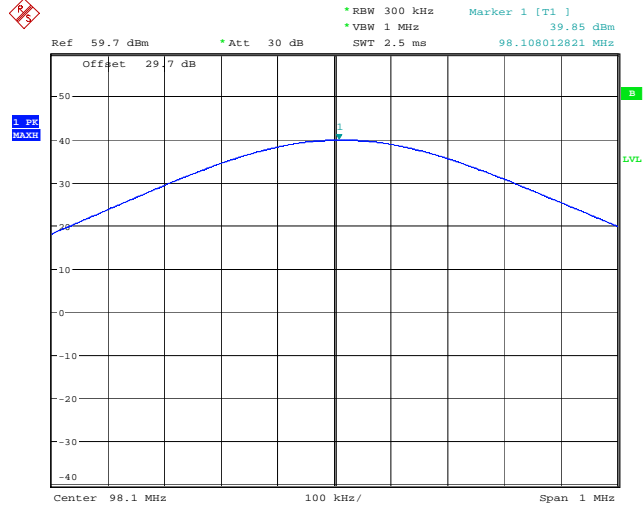

Date: 26.JUN.2023 20:33:05

Date: 26.JUN.2023 20:35:30

High Channel

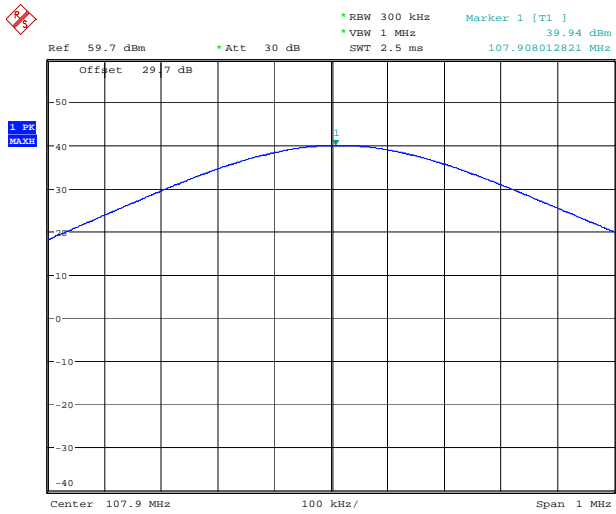

Date: 26.JUN.2023 20:36:28

Minimum rated power:

Low Channel

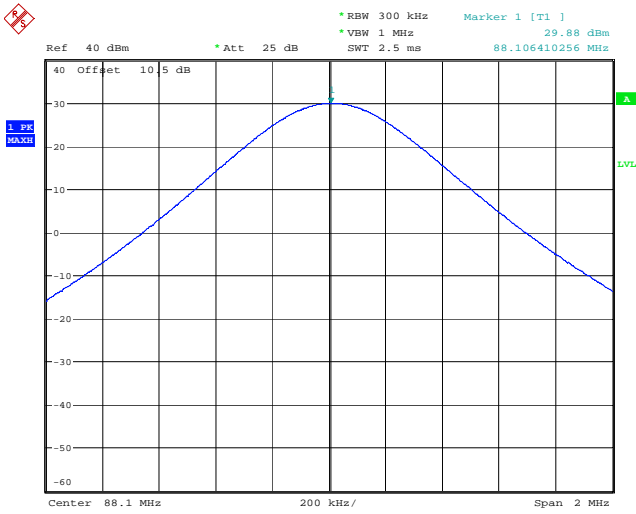

Middle Channel

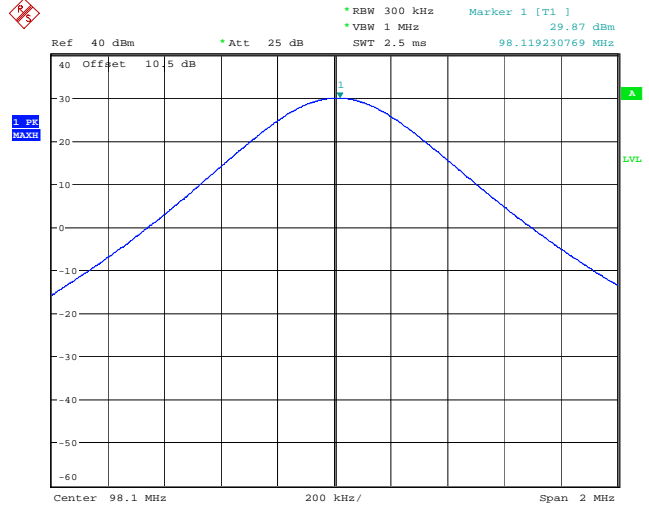

Date: 4.JUL.2023 18:54:09

Date: 4.JUL.2023 18:41:09

High Channel

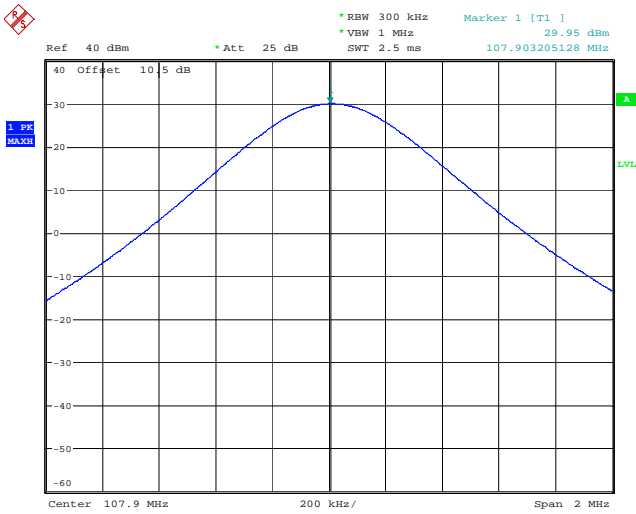

Date: 4.JUL.2023 18:38:56

4.3 Occupied Bandwidth & Emission Mask

Serial Number:	1TPA-1	Test Date:	2023/6/26
Test Site:	RF	Test Mode:	Transmitting
Tester:	Arthur Su	Test Result:	Pass

Environmental Conditions:

Temperature: (°C)	24.6	Relative Humidity: (%)	41	ATM Pressure: (kPa)	100.6
----------------------	------	---------------------------	----	------------------------	-------

Test Equipment List and Details:

Manufacturer	Description	Model	Serial Number	Calibration Date	Calibration Due Date
R&S	Spectrum Analyzer	FSU26	200445	2023/3/31	2024/3/30
Weinschel	Coaxial Attenuator	300-WA-FFN-30	1171672	Each time	N/A
YINSAIGE	Coaxial Cable	LMR300	NJ0100001	Each time	N/A
YINSAIGE	Coaxial Cable	LMR300	NJ0100002	Each time	N/A

* Statement of Traceability: China Certification ICT Co., Ltd (Dongguan) attests that all calibrations have been performed, traceable to National Primary Standards and International System of Units (SI).

Test Data:

Mode	Test Frequency (MHz)	99% Occupied Bandwidth (kHz)	20 dB Bandwidth (kHz)
Mono	88.1	167.733	177.243
	98.1	167.733	177.243
	107.9	167.733	177.243
Stereo	88.1	164.274	172.920
	98.1	164.274	172.920
	107.9	164.274	172.920

Emission Mask please refer to the plots.

Note: Emission bandwidth was based on calculation method instead of measurement.

$$BW = 2M + 2DK$$

Where M = Baud Rate, D = Deviation and K = Constant

Calculation:

$$M = 15 \text{ kHz}$$

Peak Deviation of Carrier (D) = 75 kHz

$$K = 1$$

$$BW = 2 * 15 \text{ kHz} + 2 * 75 \text{ kHz} * 1 = 180 \text{ kHz}$$

Emission Designator: 180KF3E

Mono:

99% Occupied Bandwidth Low Channel

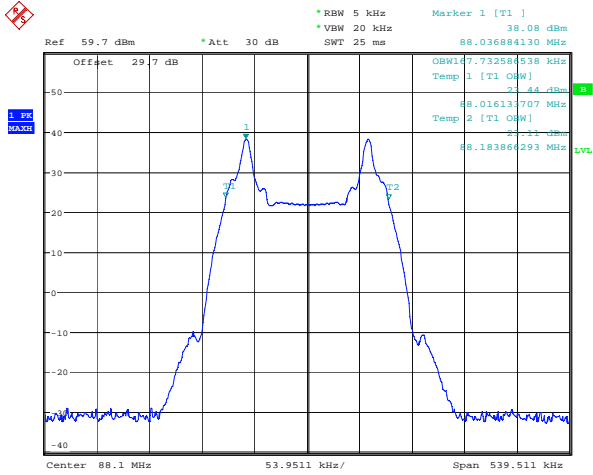

Date: 26 JUN. 2023 21:03:12

99% Occupied Bandwidth Middle Channel

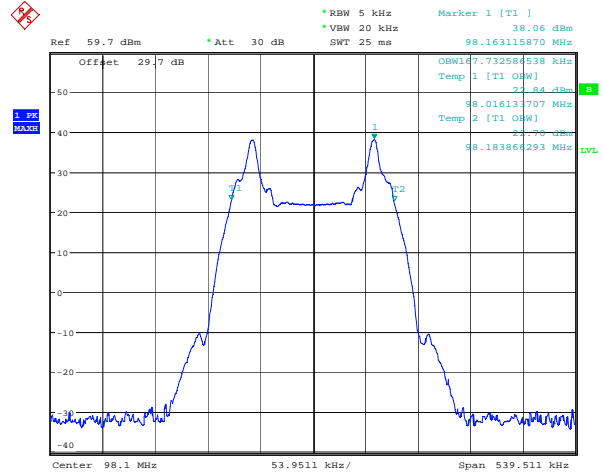

Date: 26 JUN. 2023 21:05:13

99% Occupied Bandwidth High Channel

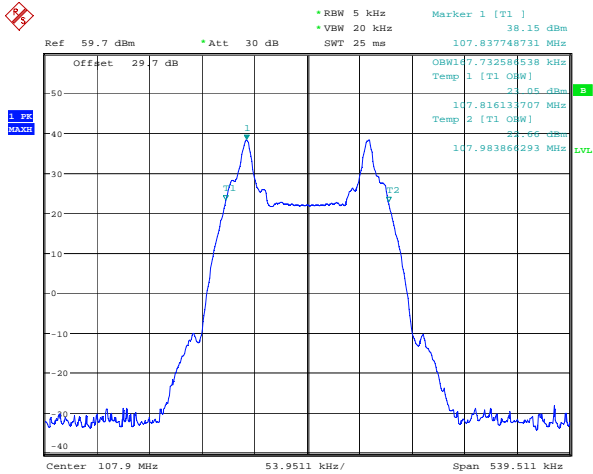

Date: 26 JUN. 2023 21:10:01

20 dB Bandwidth Low Channel

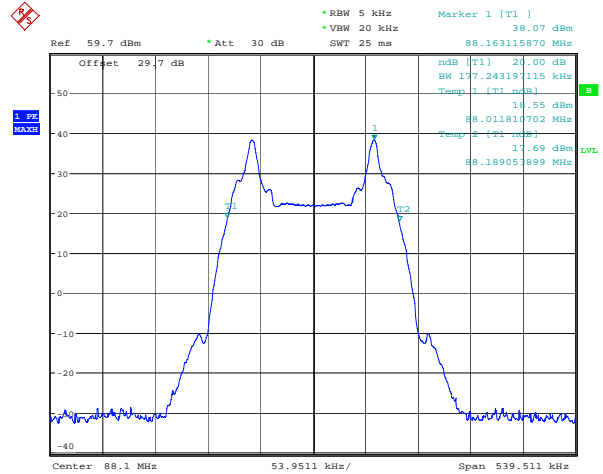

Date: 26 JUN. 2023 21:02:12

20 dB Bandwidth Middle Channel

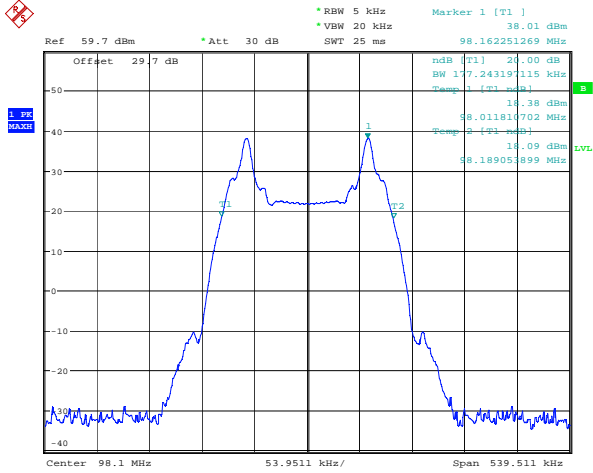

Date: 26 JUN. 2023 21:05:36

20 dB Bandwidth High Channel

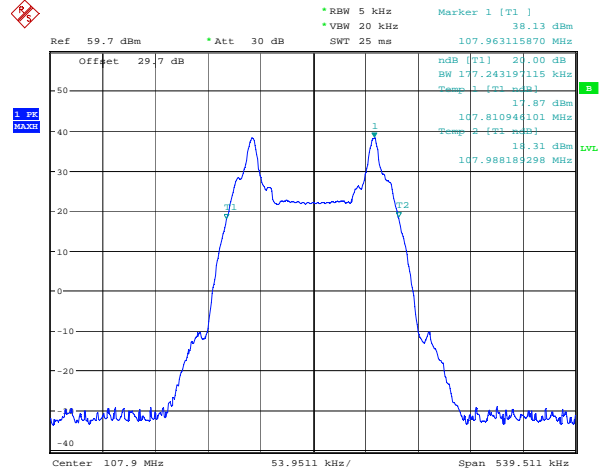

Date: 26 JUN. 2023 21:09:41

Emission Mask Low Channel

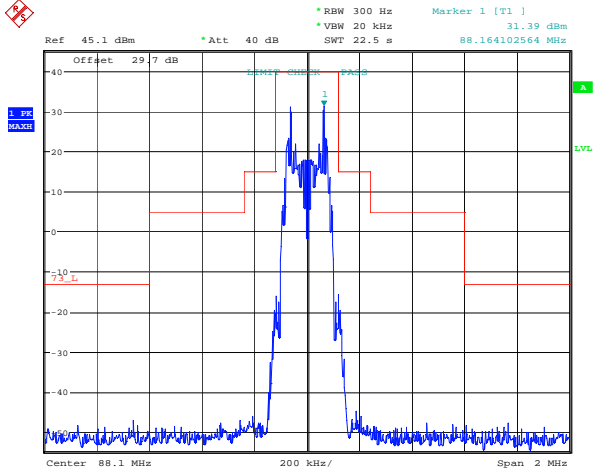

Date: 26.JUN.2023 21:00:59

Emission Mask Middle Channel

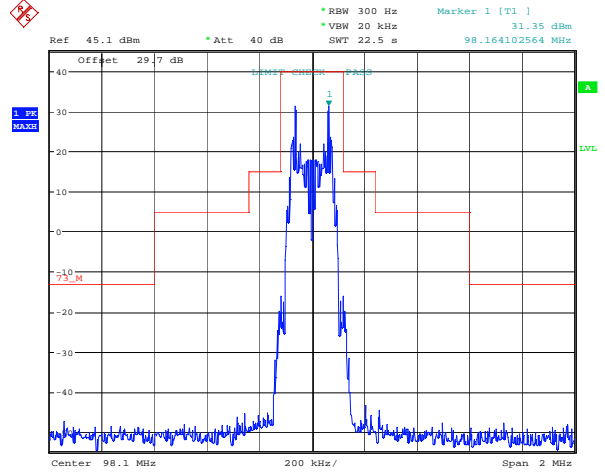

Date: 26.JUN.2023 21:07:04

Emission Mask High Channel

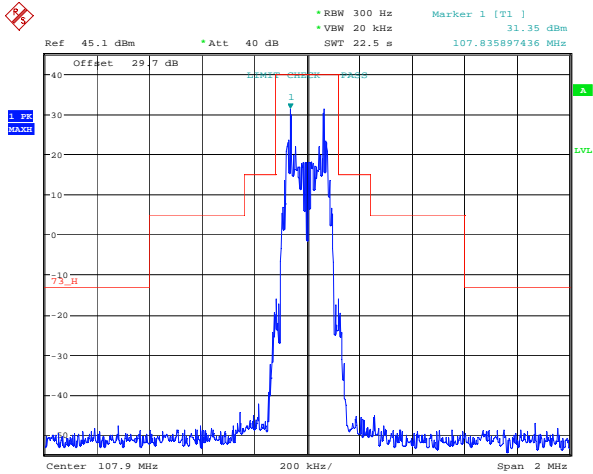

Date: 26.JUN.2023 21:09:05

Stereo: 99% Occupied Bandwidth Low Channel

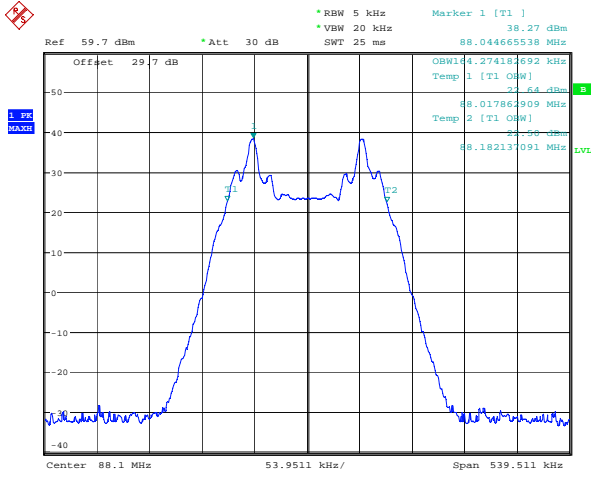

99% Occupied Bandwidth Middle Channel

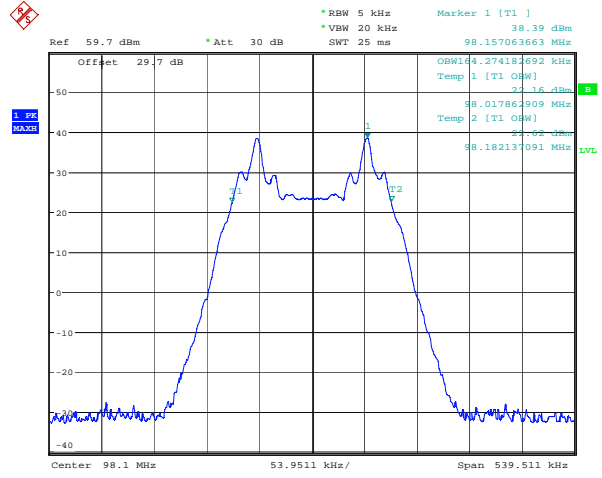

99% Occupied Bandwidth High Channel

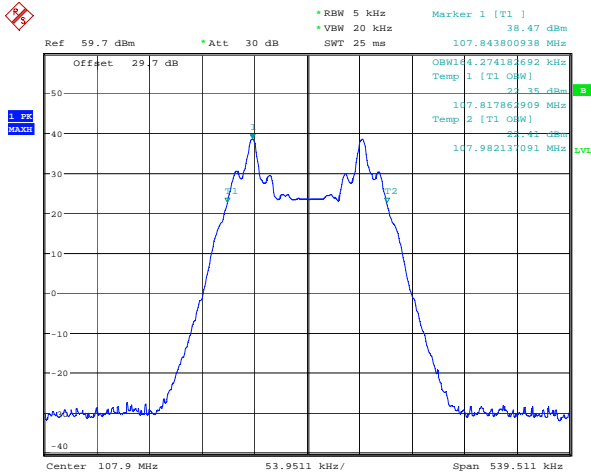

20 dB Bandwidth Low Channel

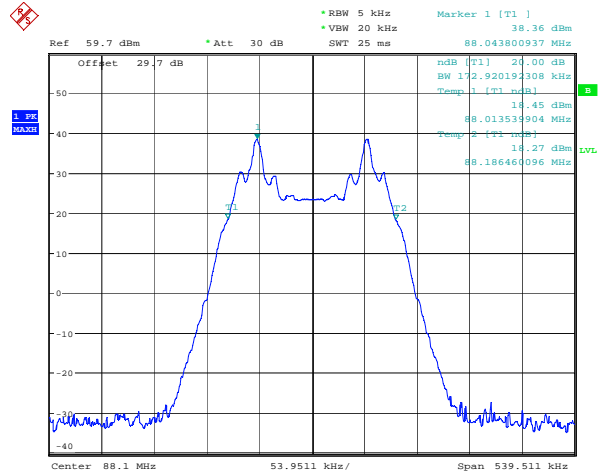

20 dB Bandwidth Middle Channel

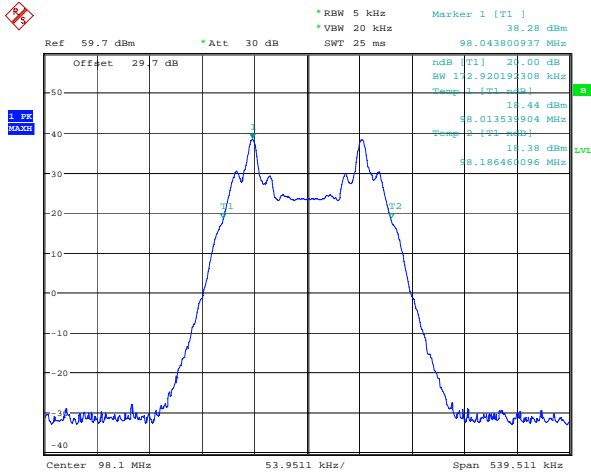

20 dB Bandwidth High Channel

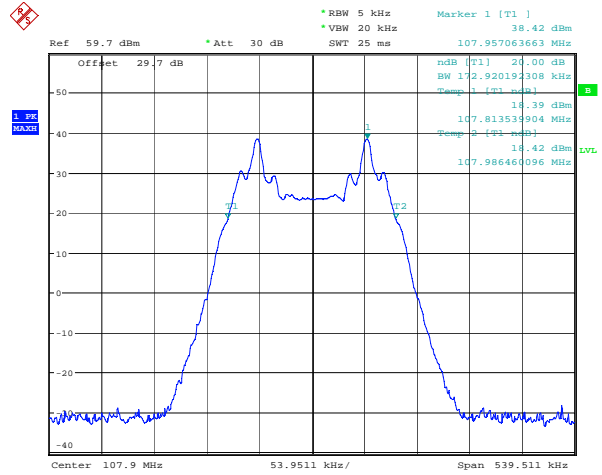

Date: 26.JUN.2023 20:55:29

Date: 26.JUN.2023 20:51:37

Emission Mask Low Channel

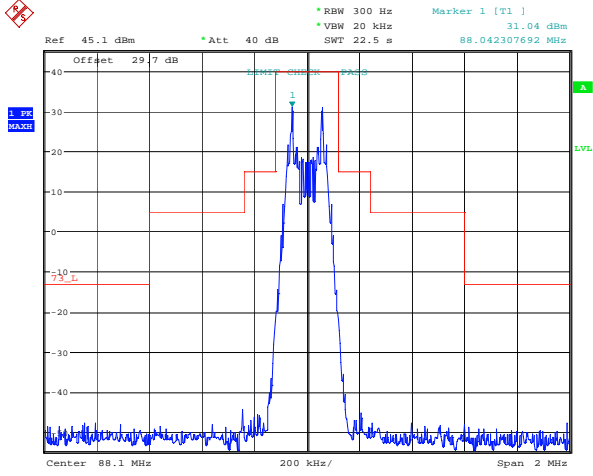

Date: 26.JUN.2023 20:59:00

Emission Mask Middle Channel

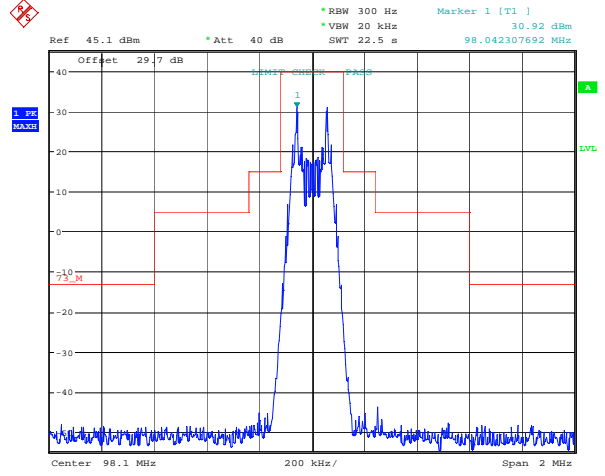

Date: 26.JUN.2023 20:54:45

Emission Mask High Channel

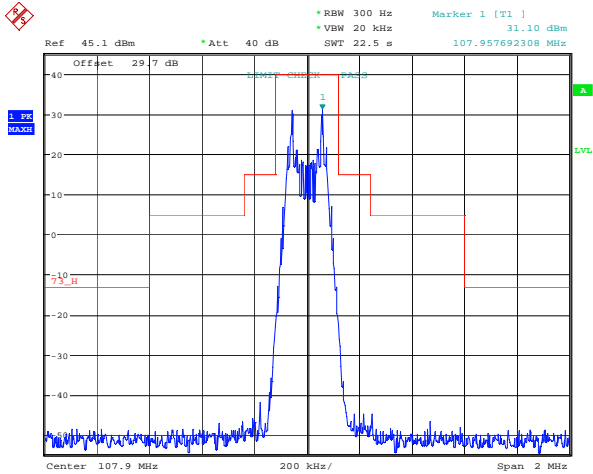

Date: 26.JUN.2023 20:52:49

4.4 Spurious Emission at Antenna Terminal

Serial Number:	1TPA-1	Test Date:	2023/3/12
Test Site:	RF	Test Mode:	Transmitting
Tester:	Arthur Su	Test Result:	Pass

Environmental Conditions:					
Temperature: (°C)	23.4	Relative Humidity: (%)	45	Temperature: (°C)	101.3

Test Equipment List and Details:

Manufacturer	Description	Model	Serial Number	Calibration Date	Calibration Due Date
R&S	Spectrum Analyzer	FSU26	200445	2022/04/05	2023/04/04
YINSAIGE	Coaxial Cable	LMR300	NJ0100001	Each time	N/A
YINSAIGE	Coaxial Cable	LMR300	NJ0100002	Each time	N/A
Weinschel	Coaxial Attenuator	300-WA-FFN-30	1171672	Each time	N/A
HP	RF Communications Test Set	8920A	3438A05209	2022/07/15	2023/07/14

* Statement of Traceability: China Certification ICT Co., Ltd (Dongguan) attests that all calibrations have been performed, traceable to National Primary Standards and International System of Units (SI).

Test Data:

Low Channel

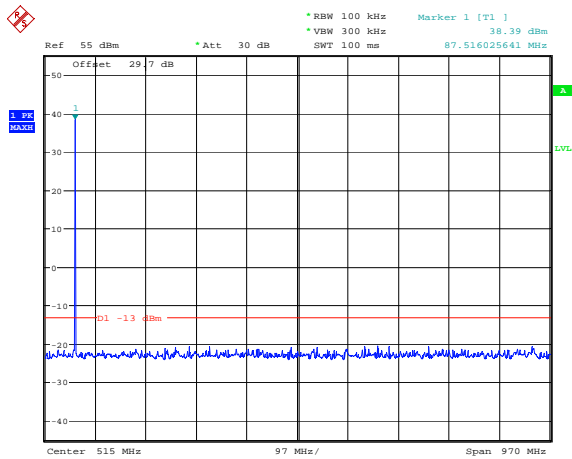

Date: 12.MAR.2023 13:31:58

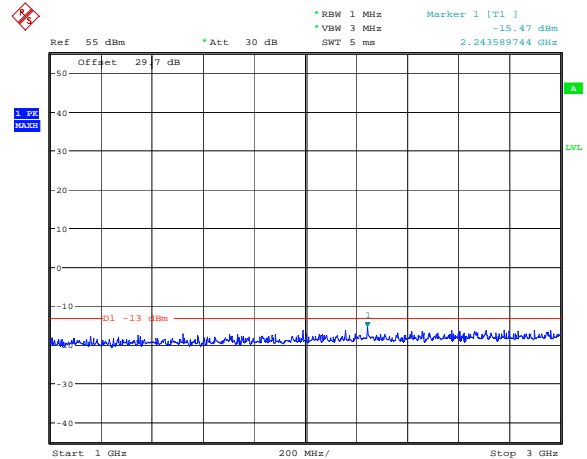

Date: 12.MAR.2023 13:34:04

Middle Channel

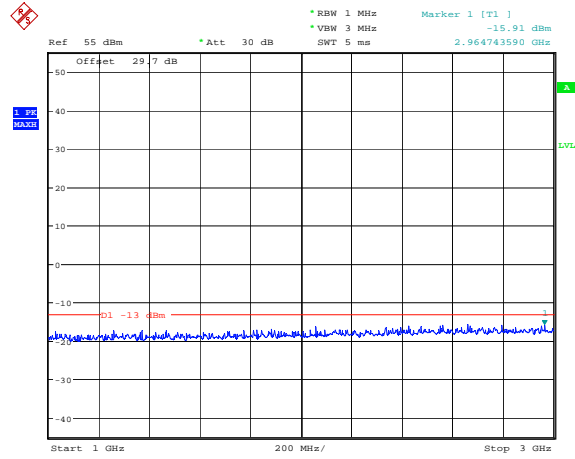
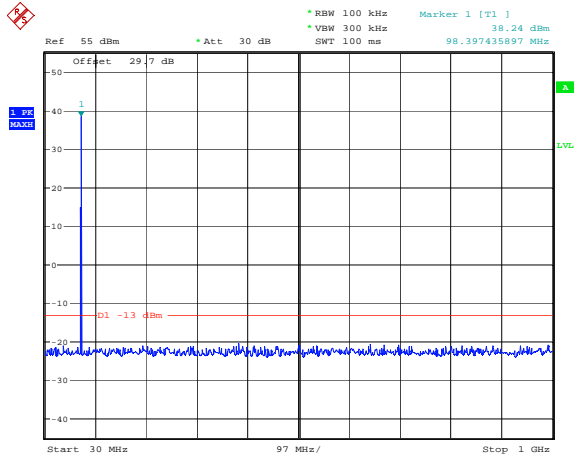

Date: 12.MAR.2023 13:30:14

Date: 12.MAR.2023 13:33:37

High Channel

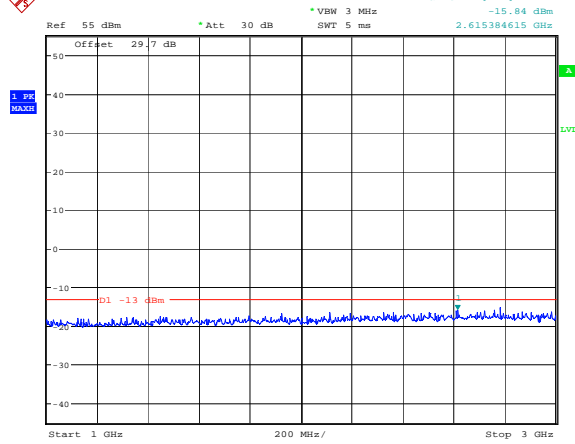
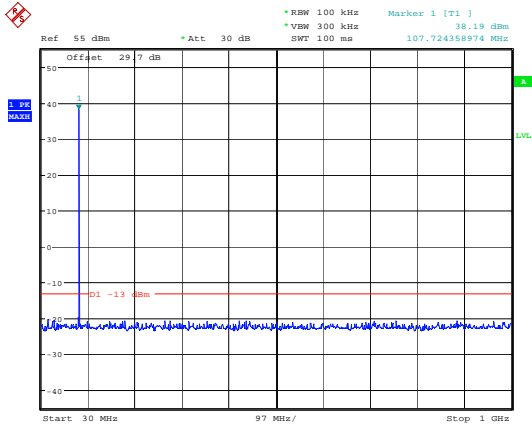

Date: 12.MAR.2023 13:29:01

Date: 12.MAR.2023 13:34:44

4.5 Spurious Radiated Emissions

Serial Number:	1TPA-1	Test Date:	2023/3/1~2023/3/2
Test Site:	966-2/966-1	Test Mode:	Transmitting
Tester:	Carl Xue, coco Tian	Test Result:	Pass

Environmental Conditions:

Temperature: (°C)	23.5~24.1	Relative Humidity: (%)	41~43	ATM Pressure: (kPa)	102.2~102.4
----------------------	-----------	---------------------------	-------	------------------------	-------------

Test Equipment List and Details:

Manufacturer	Description	Model	Serial Number	Calibration Date	Calibration Due Date
Sunol Sciences	Antenna	JB6	A082520-5	2020/10/19	2023/10/18
R&S	EMI Test Receiver	ESR3	102724	2022/07/15	2023/07/14
TIMES MICROWAVE	Coaxial Cable	LMR-600-UltraFlex	C-0470-02	2022/07/17	2023/07/16
TIMES MICROWAVE	Coaxial Cable	LMR-600-UltraFlex	C-0780-01	2022/07/17	2023/07/16
Sonoma	Amplifier	310N	186165	2022/07/17	2023/07/16
EMCO	Adjustable Dipole Antenna	3121C	9109-756	N/A	N/A
MICRO-COAX	Coaxial Cable	UFA210B-0-0720-300300	99G1448	2022/07/17	2023/07/16
Agilent	Signal Generator	E8247C	MY43321352	2022/04/01	2023/03/31
ETS-Lindgren	Horn Antenna	3115	9912-5985	2020/10/13	2023/10/12
R&S	Spectrum Analyzer	FSV40	101591	2022/07/15	2023/07/14
MICRO-COAX	Coaxial Cable	UFA210A-1-1200-70U300	217423-008	2022/08/07	2023/08/06
MICRO-COAX	Coaxial Cable	UFA210A-1-2362-300300	235780-001	2022/08/07	2023/08/06
Mini	Pre-amplifier	ZVA-183-S+	5969001149	2022/11/09	2023/11/08
AH	Double Ridge Guide Horn Antenna	SAS-571	1396	2021/10/18	2024/10/17

* Statement of Traceability: China Certification ICT Co., Ltd (Dongguan) attests that all calibrations have been performed, traceable to National Primary Standards and International System of Units (SI).

Test Data:

Frequency (MHz)	Polar (H/V)	Receiver Reading (dBμV)	Substituted Method			Absolute Level (dBm)	Limit (dBm)	Margin (dB)
			Substituted Level (dBm)	Antenna Gain (dBd/dBi)	Cable Loss (dB)			
Frequency: 88.1 MHz								
176.200	H	34.03	-78.29	0.00	0.25	-78.54	-13.00	65.54
176.200	V	33.64	-75.87	0.00	0.25	-76.12	-13.00	63.12
264.300	H	43.17	-68.39	0.00	0.31	-68.70	-13.00	55.70
264.300	V	39.04	-71.31	0.00	0.31	-71.62	-13.00	58.62
352.400	H	43.12	-66.81	0.00	0.36	-67.17	-13.00	54.17
352.400	V	40.20	-67.25	0.00	0.36	-67.61	-13.00	54.61
440.500	H	37.98	-70.28	0.00	0.42	-70.70	-13.00	57.70
440.500	V	43.44	-61.34	0.00	0.42	-61.76	-13.00	48.76
528.600	H	29.57	-76.70	0.00	0.44	-77.14	-13.00	64.14
528.600	V	38.38	-64.60	0.00	0.44	-65.04	-13.00	52.04
616.000	H	44.53	-60.25	0.00	0.48	-60.73	-13.00	47.73
616.000	V	48.61	-54.71	0.00	0.48	-55.19	-13.00	42.19
704.000	H	40.46	-64.06	0.00	0.55	-64.61	-13.00	51.61
704.000	V	42.75	-58.43	0.00	0.55	-58.98	-13.00	45.98
792.000	H	41.65	-60.86	0.00	0.61	-61.47	-13.00	48.47
792.000	V	38.18	-60.76	0.00	0.61	-61.37	-13.00	48.37
880.000	H	40.39	-59.52	0.00	0.59	-60.11	-13.00	47.11
880.000	V	39.11	-57.78	0.00	0.59	-58.37	-13.00	45.37
968.000	H	31.41	-65.84	0.00	0.59	-66.43	-13.00	53.43
968.000	V	31.93	-63.02	0.00	0.59	-63.61	-13.00	50.61
Frequency: 98.1 MHz								
196.200	H	44.85	-67.96	0.00	0.26	-68.22	-13.00	55.22
196.200	V	47.91	-61.48	0.00	0.26	-61.74	-13.00	48.74
294.300	H	42.75	-68.10	0.00	0.33	-68.43	-13.00	55.43
294.300	V	39.89	-69.17	0.00	0.33	-69.50	-13.00	56.50
392.400	H	36.11	-73.21	0.00	0.38	-73.59	-13.00	60.59
392.400	V	36.27	-70.14	0.00	0.38	-70.52	-13.00	57.52
490.500	H	35.29	-71.79	0.00	0.44	-72.23	-13.00	59.23
490.500	V	36.25	-66.77	0.00	0.44	-67.21	-13.00	54.21
588.600	H	35.60	-69.44	0.00	0.47	-69.91	-13.00	56.91
588.600	V	42.85	-60.74	0.00	0.47	-61.21	-13.00	48.21
686.700	H	37.25	-67.39	0.00	0.53	-67.92	-13.00	54.92
686.700	V	35.78	-65.82	0.00	0.53	-66.35	-13.00	53.35
784.000	H	35.35	-67.34	0.00	0.56	-67.90	-13.00	54.90
784.000	V	32.30	-66.85	0.00	0.56	-67.41	-13.00	54.41
882.000	H	34.38	-65.47	0.00	0.59	-66.06	-13.00	53.06
882.000	V	32.88	-63.97	0.00	0.59	-64.56	-13.00	51.56
980.000	H	31.37	-65.51	0.00	0.65	-66.16	-13.00	53.16
980.000	V	33.57	-61.12	0.00	0.65	-61.77	-13.00	48.77

Frequency (MHz)	Polar (H/V)	Receiver Reading (dB μ V)	Substituted Method			Absolute Level (dBm)	Limit (dBm)	Margin (dB)
			Substituted Level (dBm)	Antenna Gain (dBd/dBi)	Cable Loss (dB)			
Frequency: 107.9 MHz								
215.800	H	50.69	-61.89	0.00	0.27	-62.16	-13.00	49.16
215.800	V	48.45	-61.38	0.00	0.27	-61.65	-13.00	48.65
323.700	H	40.54	-69.82	0.00	0.34	-70.16	-13.00	57.16
323.700	V	33.78	-74.41	0.00	0.34	-74.75	-13.00	61.75
431.600	H	31.82	-76.65	0.00	0.40	-77.05	-13.00	64.05
431.600	V	38.61	-66.49	0.00	0.40	-66.89	-13.00	53.89
539.500	H	46.62	-59.43	0.00	0.46	-59.89	-13.00	46.89
539.500	V	49.24	-53.85	0.00	0.46	-54.31	-13.00	41.31
647.400	H	38.19	-66.53	0.00	0.52	-67.05	-13.00	54.05
647.400	V	37.73	-64.83	0.00	0.52	-65.35	-13.00	52.35
755.300	H	29.34	-74.01	0.00	0.52	-74.53	-13.00	61.53
755.300	V	31.50	-68.38	0.00	0.52	-68.90	-13.00	55.90
846.000	H	27.21	-73.73	0.00	0.57	-74.30	-13.00	61.30
846.000	V	27.61	-70.07	0.00	0.57	-70.64	-13.00	57.64
972.000	H	28.55	-68.58	0.00	0.59	-69.17	-13.00	56.17
972.000	V	29.14	-65.72	0.00	0.59	-66.31	-13.00	53.31
1079.000	H	34.02	-68.07	7.32	0.66	-61.41	-13.00	48.41
1079.000	V	34.76	-67.76	7.32	0.66	-61.10	-13.00	48.10

4.6 Modulation Characteristic

Serial Number:	1TPA-1	Test Date:	2023/3/4
Test Site:	RF	Test Mode:	Transmitting
Tester:	Arthur Su	Test Result:	Pass

Environmental Conditions:

Temperature: (°C)	20.1	Relative Humidity: (%)	60	ATM Pressure: (kPa)	100.9
----------------------	------	------------------------------	----	------------------------	-------

Test Equipment List and Details:

Manufacturer	Description	Model	Serial Number	Calibration Date	Calibration Due Date
HP	RF Communications Test Set	8920A	3438A05209	2022/07/15	2023/07/14
zhuoxiang	Coaxial Cable	SMA-178	211001	Each time	N/A
Weinschel	Coaxial Attenuator	300-WA-FFN-30	1171672	Each time	N/A
YINSAIGE	Coaxial Cable	LMR300	NJ0100001	Each time	N/A
YINSAIGE	Coaxial Cable	LMR300	NJ0100002	Each time	N/A

* Statement of Traceability: China Certification ICT Co., Ltd (Dongguan) attests that all calibrations have been performed, traceable to National Primary Standards and International System of Units (SI).

Test Data:

Modulation Limiting

Carrier Frequency: 98.1 MHz		
Power Input(Vpp)	Modulation (kHz)	Audio Frequency
1.99	45.00	300Hz
3.54	53.41	
6.29	56.16	
11.19	56.41	
19.9	56.49	
1.99	45.00	500Hz
3.54	54.10	
6.29	53.42	
11.19	52.17	
19.9	52.24	
1.99	45.00	1000Hz
3.54	47.33	
6.29	50.57	
11.19	45.24	
19.9	45.09	
1.99	45.00	3000Hz
3.54	45.99	
6.29	47.41	
11.19	46.74	
19.9	45.09	

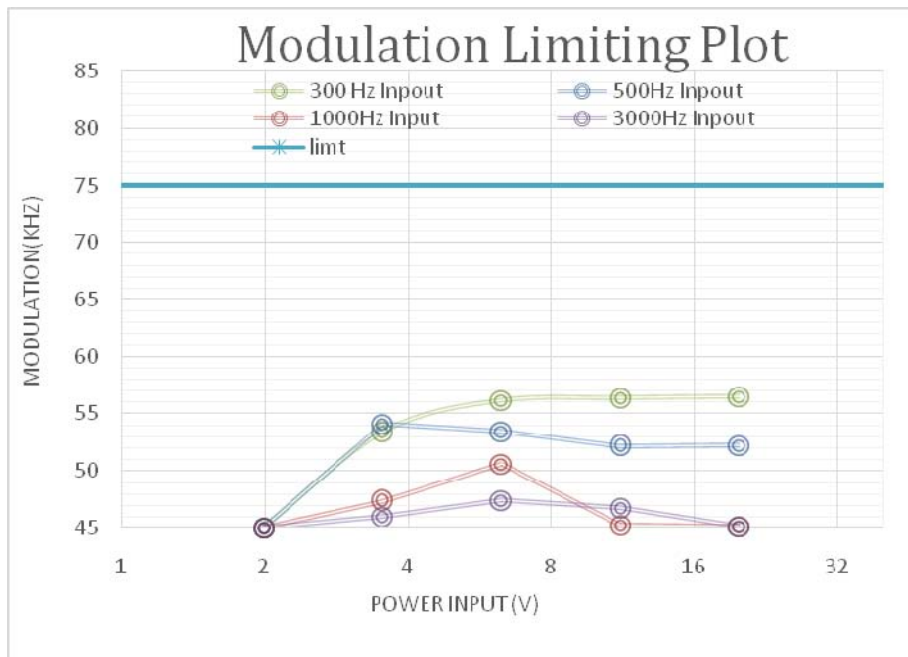

Peak MAX -:

Carrier Frequency: 98.1 MHz		
Power Input(Vpp)	Modulation (kHz)	Audio Frequency
1.99	45.00	300Hz
3.54	54.09	
6.3	54.91	
11.19	56.33	
19.9	56.42	
1.99	45.00	500Hz
3.54	54.10	
6.3	54.26	
11.19	52.52	
19.9	53.34	
1.99	45.00	1000Hz
3.54	47.27	
6.3	50.33	
11.19	45.91	
19.9	45.99	
1.99	45.00	3000Hz
3.54	45.92	
6.3	47.61	
11.19	46.62	
19.9	45.23	

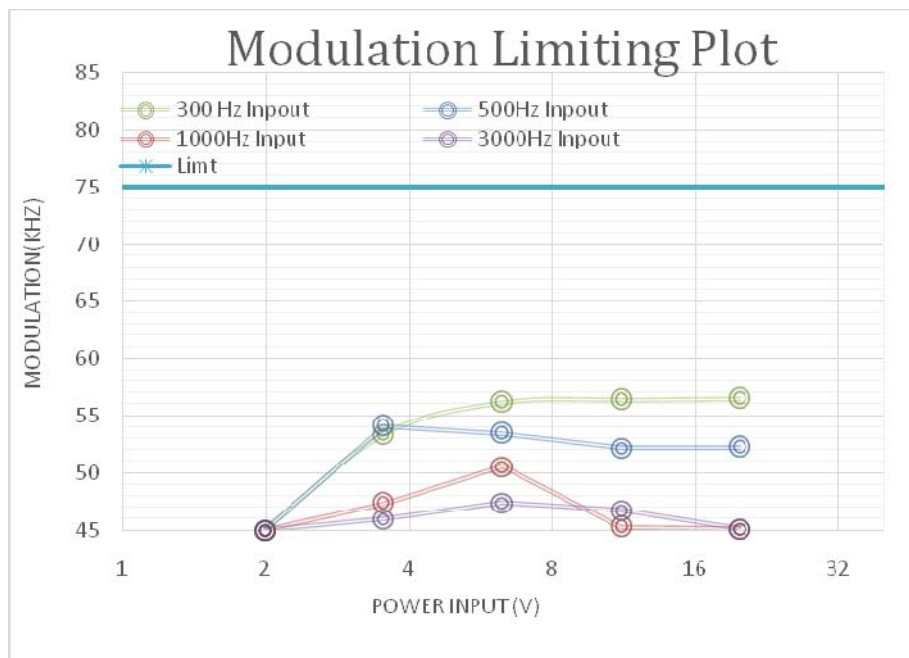

Audio Frequency Response:

Carrier Frequency: 98.1MHz	
Audio Frequency (Hz)	Response Attenuation(dB)
100	0.44
200	-1.35
300	-1.64
400	-1.54
500	-1.44
600	-1.11
700	-1.13
800	-0.71
900	-0.30
1000	0.00
1500	3.78
2000	-0.23
2500	-0.99
3000	-2.60
3500	-3.23
4000	-0.46
4500	1.38
5000	0.92

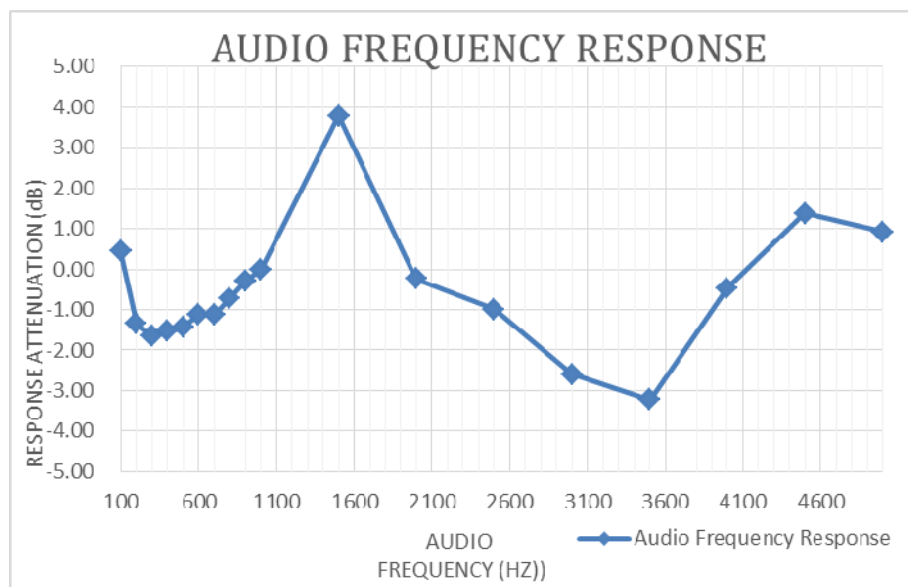

5 MAXIMUM PERMISSIBLE EXPOSURE (MPE)

5.1 Applicable Standard

According to FCC 1.1310, 2.1091 systems operating under the provisions of this section shall be operated in a manner that ensures the public is not exposed to RF energy level in excess of the communication guidelines.

Limits for Maximum Permissible Exposure (MPE)

Limits for Occupational/Controlled Exposure				
Frequency Range (MHz)	Electric Field Strength (E) (V/m)	Magnetic Field Strength (H) (A/m)	Power Density (S) (mW/cm ²)	Averaging Time E , H or S (minutes)
0.3- 3.0	614	1.63	(100)*	6
3.0 - 30	1842/f	4.89/f	(900/f ²)*	6
30-300	61.4	0.163	1.0	6
300-1500	/	/	f/300	6
1500-100,000	/	/	5	6

f = frequency in MHz;

* = Plane-wave equivalent power density;

According to RSS-102 § 4Table 6, RF Field Strength Limits for Devices Used by the General Public (Controlled Environment)

Table 6: RF Field Strength Limits for Controlled Use Devices (Controlled Environment)

Frequency Range (MHz)	Electric Field (V/m rms)	Magnetic Field (A/m rms)	Power Density (W/m ²)	Reference Period (minutes)
0.003-10 ²³	170	180	-	Instantaneous*
0.1-10	-	1.6/ f	-	6**
1.29-10	193/ f ^{0.5}	-	-	6**
10-20	61.4	0.163	10	6
20-48	129.8/ f ^{0.25}	0.3444/ f ^{0.25}	44.72/ f ^{0.5}	6
48-100	49.33	0.1309	6.455	6
100-6000	15.60 f ^{0.25}	0.04138 f ^{0.25}	0.6455 f ^{0.5}	6
6000-15000	137	0.364	50	6
15000-150000	137	0.364	50	616000/ f ^{1.2}
150000-300000	0.354 f ^{0.5}	9.40 x 10 ⁻⁴ f ^{0.5}	3.33 x 10 ⁻⁴ f	616000/ f ^{1.2}

Note: f is frequency in MHz.
 *Based on nerve stimulation (NS).
 ** Based on specific absorption rate (SAR).

5.2 MPE Calculation

Prediction of power density at the distance of the applicable MPE limit

$$S = PG/4\pi R^2$$

Where: S = power density (in appropriate units, e.g. mW/cm²);

P = power input to the antenna (in appropriate units, e.g., mW);

G = power gain of the antenna in the direction of interest relative to an isotropic radiator

R = distance to the center of radiation of the antenna (appropriate units, e.g., cm);

5.3 MPE Results

For FCC 2.1091:

Frequency (MHz)	Antenna Gain		Maximum Average output power including Tune-up Tolerance (mW)	Operation Duty Cycle (%)	Evaluation Distance (cm)	Power Density (mW/cm ²)	Power Density Limit (mW/cm ²)
	(dBi)	(numeric)					
88-108	0	1.0	10000	100	40	0.4974	1

Note: the maximum power including Tune-up Tolerance is 10 Watts.

Result: The device meet FCC MPE at 40 cm distance

For RSS-102:

Frequency (MHz)	Antenna Gain		Maximum Average output power including Tune-up Tolerance (mW)	Operation Duty Cycle (%)	Evaluation Distance (cm)	Power Density (W/m ²)	Power Density Limit (W/m ²)
	(dBi)	(numeric)					
88-108	0	1.0	10000	100	40	4.974	6.455

Note: the maximum power including Tune-up Tolerance is 10 Watts.

Result: The device meet ISEDC MPE at 40 cm distance

***** END OF REPORT *****