

1. Features

- Antenna for 2.4 – 2.5 GHz and 5.17 – 5.84 GHz applications: Wi-Fi 802.11a/b/g/n/ac
- Works over a ground plane. No clearance required.
- Ideal for wearables.
- Maintains high performance on device: DFI (Designed For Integration)
- SMD mounting
- Supplied on Tape and Reel

2. Description

Trogona is intended for use with all dual-band Wi-Fi applications. Only requires a small ground plane and integrates into the corner with minimal PCB clearance area. The design is centered on being part of the device and not designing the device around the antenna. Trogona is ideal for single and MIMO antenna systems.

3. Applications

- Wearable devices
- Access Points
- Portable Devices
- PC-cards
- Game Consoles
- Set-Top-Box
- Network Devices
- MIMO Systems



4. Part Number

Trogona: SR42W009

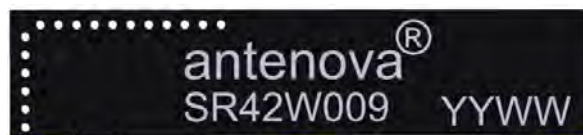

5. General Data

Product name	Trogona
Part Number	SR42W009
Frequency	2.4-2.5 GHz; 5.17-5.84 GHz
Polarization	Linear
Operating temperature	-40°C to 140°C
Environmental Condition Test	ISO16750-4 5.1.1.1/5.1.2.1/5.3.2
Impedance with matching	50 Ω
Weight	< 0.5 g
Antenna type	SMD
Dimensions	19.3 x 3.3 x 4.4 (mm)

6. RF Characteristics

	Typical performance	Conditions
Peak gain	5.03dBi	2.4 – 2.5 GHz frequency range All data measured on Antenna's evaluation PCB Part No. SR42W009- U1
Average gain	-1.5dBi	
Average efficiency	>70%	
Maximum return loss	-7.0dB	
Maximum VSWR	2.7:1	

	Typical performance	Conditions
Peak gain	5.32dBi	5.175 – 5.835 GHz frequency range All data measured on Antenna's evaluation PCB Part No. SR42W009- U1
Average gain	-2.2dBi	
Average efficiency	>60%	
Maximum return loss	-7.0dB	
Maximum VSWR	2.70:1	

Antennas for Wireless Applications

7. RF Performance

7.1 Return Loss

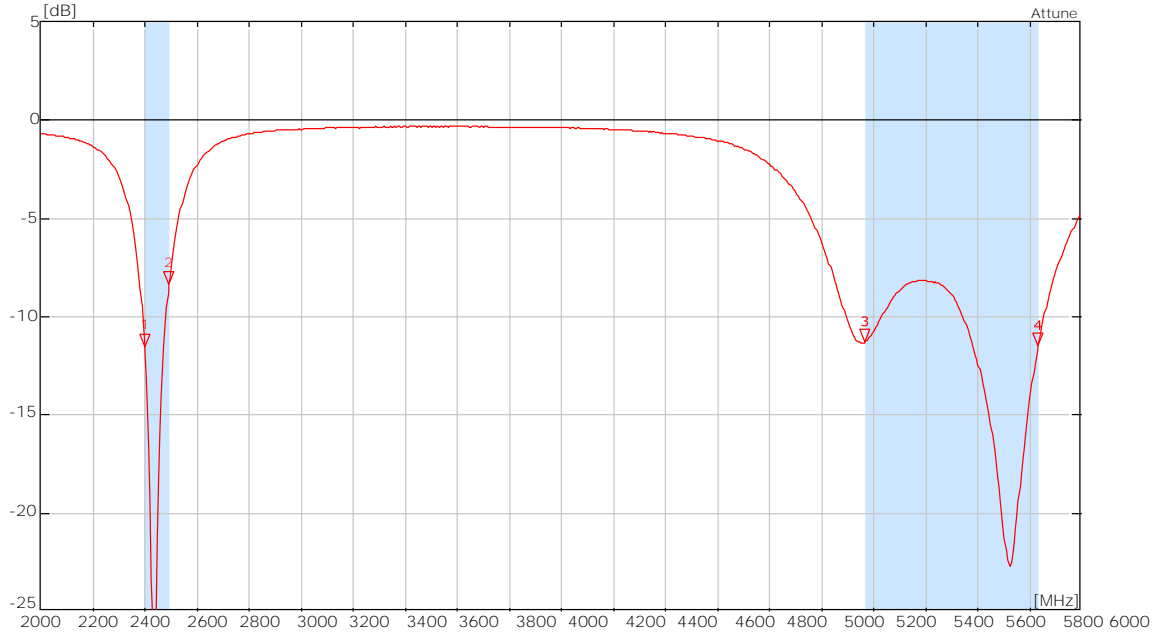

7.2 VSWR

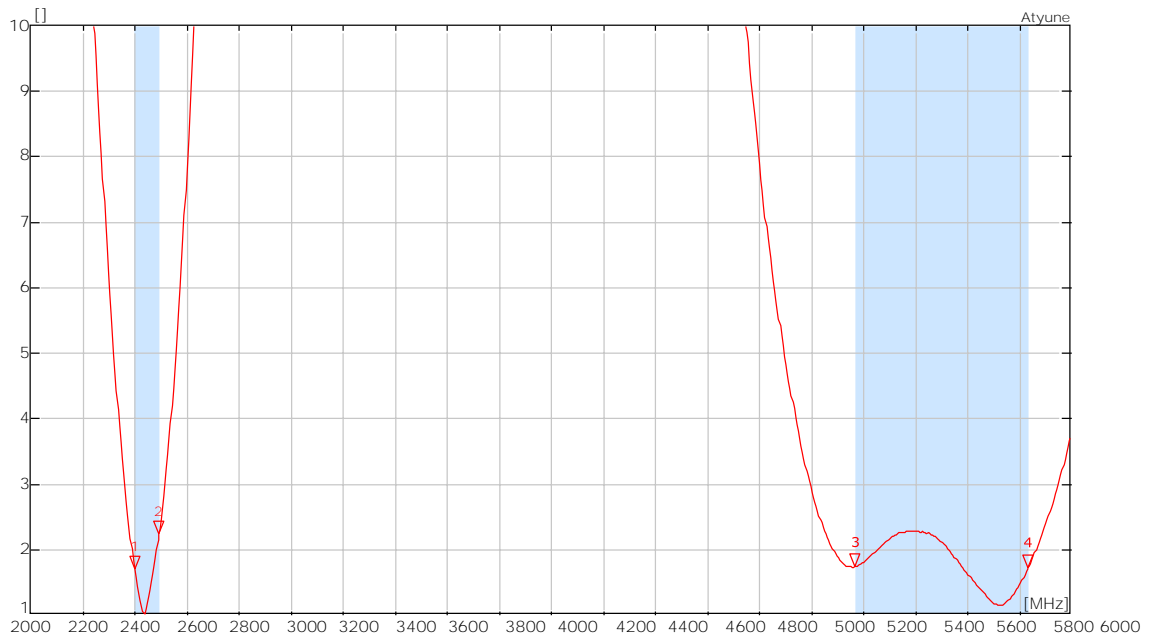

7.3 Antenna patterns

7.3.1 2400 MHz – 2500 MHz

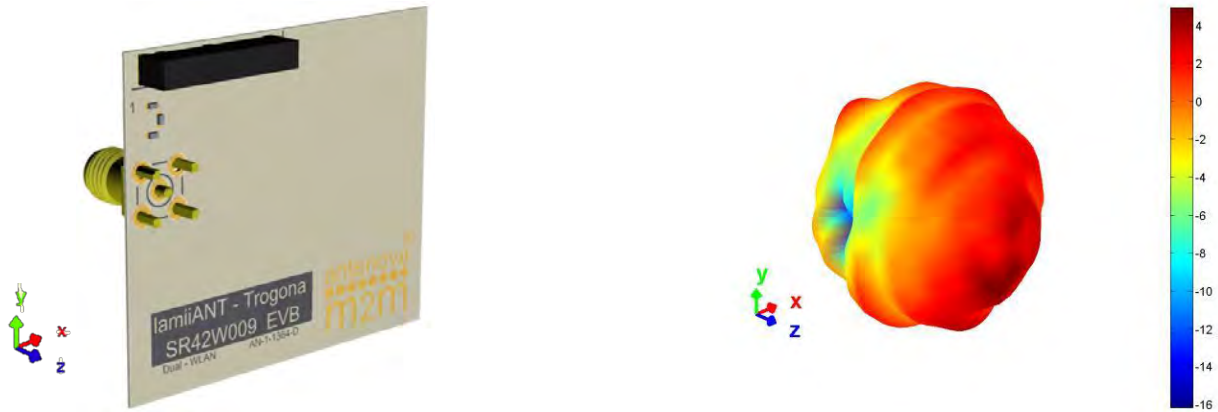

3D pattern at 2.45GHz
Drag to rotate pattern and PCB by using Adobe Reader
(Click to Activate)

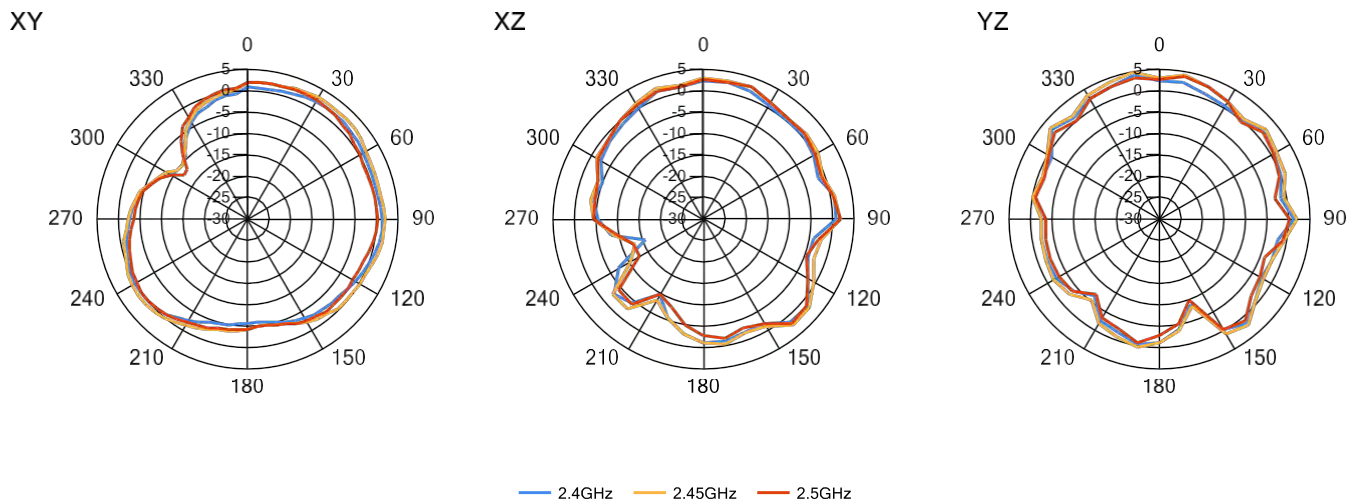

7.3.2 4900 MHz – 5900 MHz

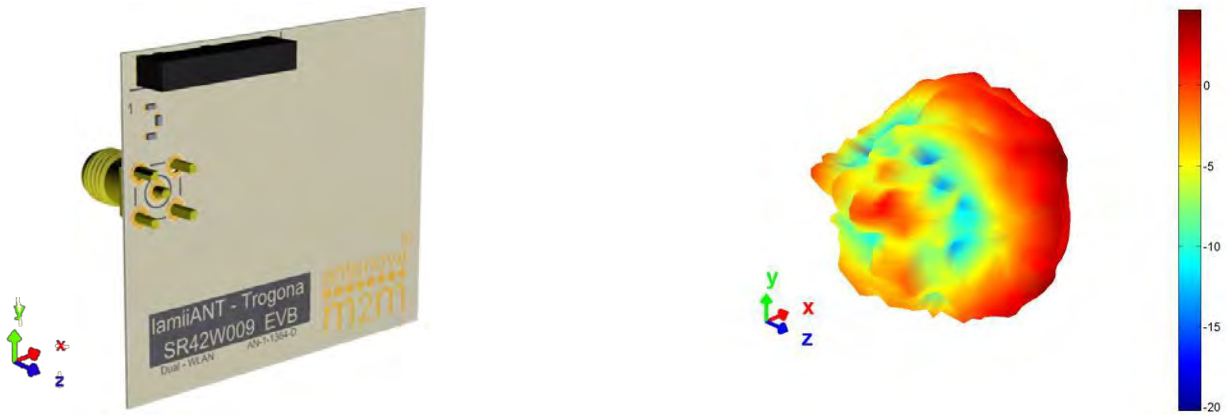

3D pattern at 5.5GHz
*Drag to rotate pattern and PCB by using Adobe Reader
(Click to Activate)*

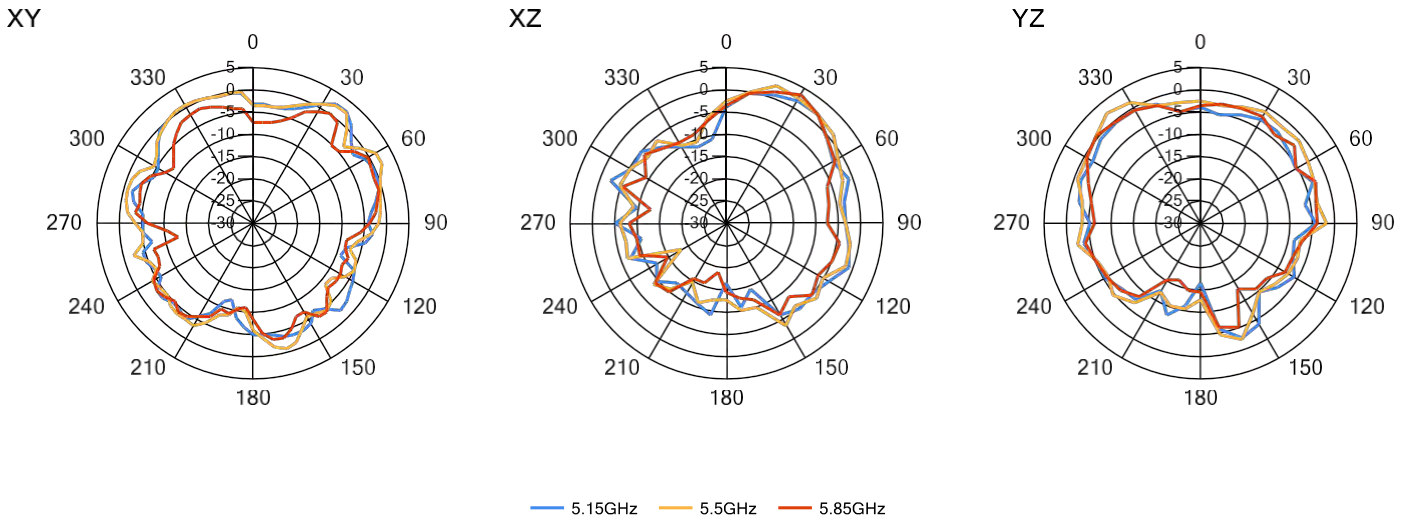

8. Antenna Dimensions



L	W	H
Length	Width	Height
19.3	3.3	4.4

All dimensions in mm

Bottom side dimensions

4 solder pads (3.2 x 1.2 mm)

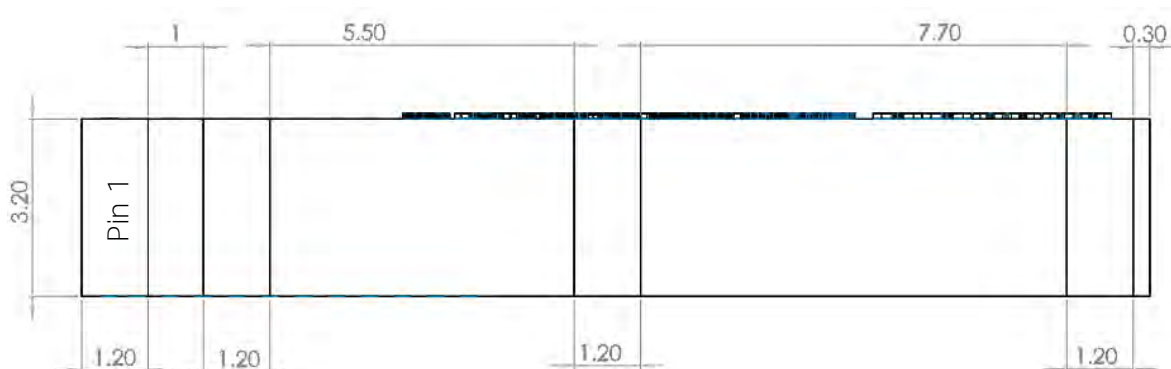

9. Antenna footprint

The recommended host PCB footprint is below.

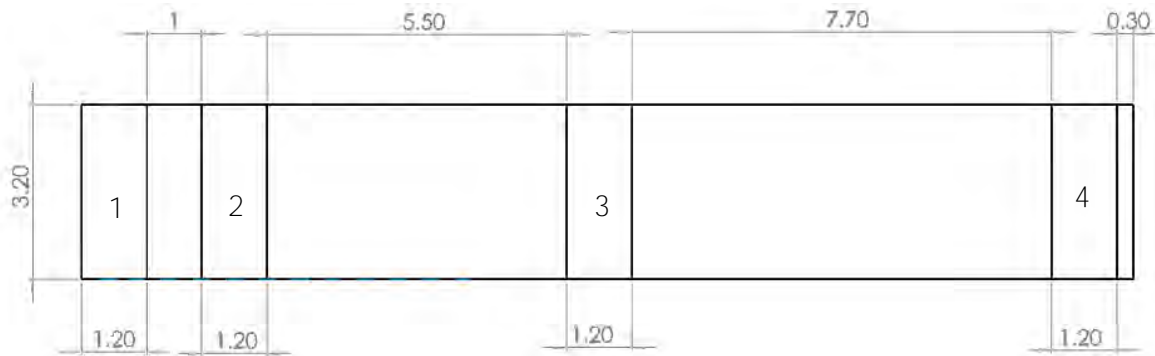

4 copper pads all 3.2 x 1.2 (mm)

10. Schematic

The circuit for the antenna and the matching components is below. The RF feed connection and GND connections are critical to the function of the antenna, and must be followed as shown. This circuit can be used for the circuit capture of the host PCB. Pin 2 the feed is connected to Pin 1 (GND) as shown below here and is essential to the antenna function.

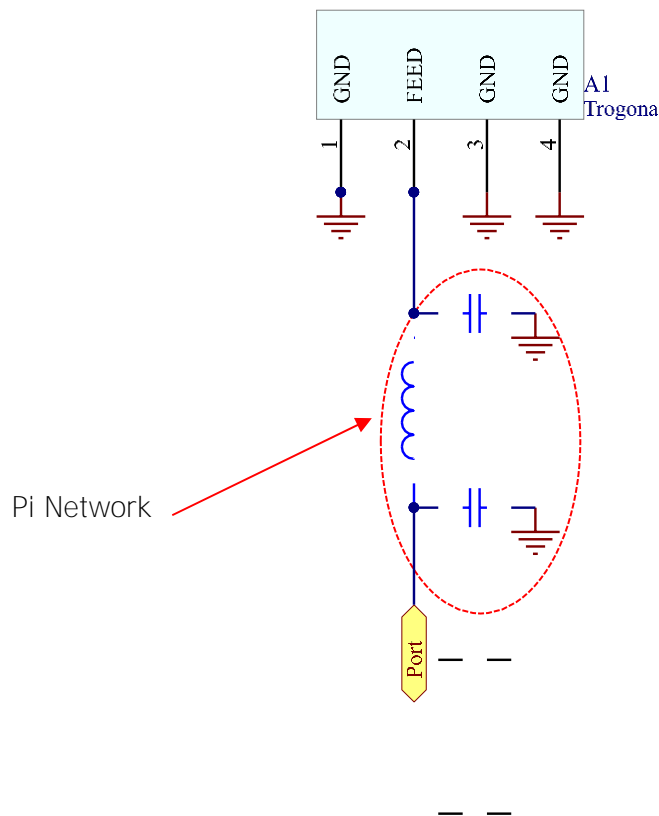

11. Electrical Interface

11.1 Transmission Line

All transmission lines should be designed to have a characteristic impedance of 50Ω.

- The length of the transmission lines should be kept to a minimum
- Any other parts of the RF system like transceivers, power amplifiers, etc, should also be designed to have an impedance of 50 Ω

Once the material for the PCB has been chosen (PCB thickness and dielectric constant), a coplanar transmission line can easily be designed using any of the commercial software packages for transmission line design. For the chosen PCB thickness, copper thickness and substrate dielectric constant, the program will calculate the appropriate transmission line width and gaps on either side of the feed.

11.2 Matching Circuit

The antenna requires a matching circuit that must be optimized for each product. The matching circuit will require up to three components and the following pad layout should be designed into the device so the correct circuit can be installed.

The Pi matching network must be placed close to the antenna feed to ensure it is more effective in tuning the antenna.

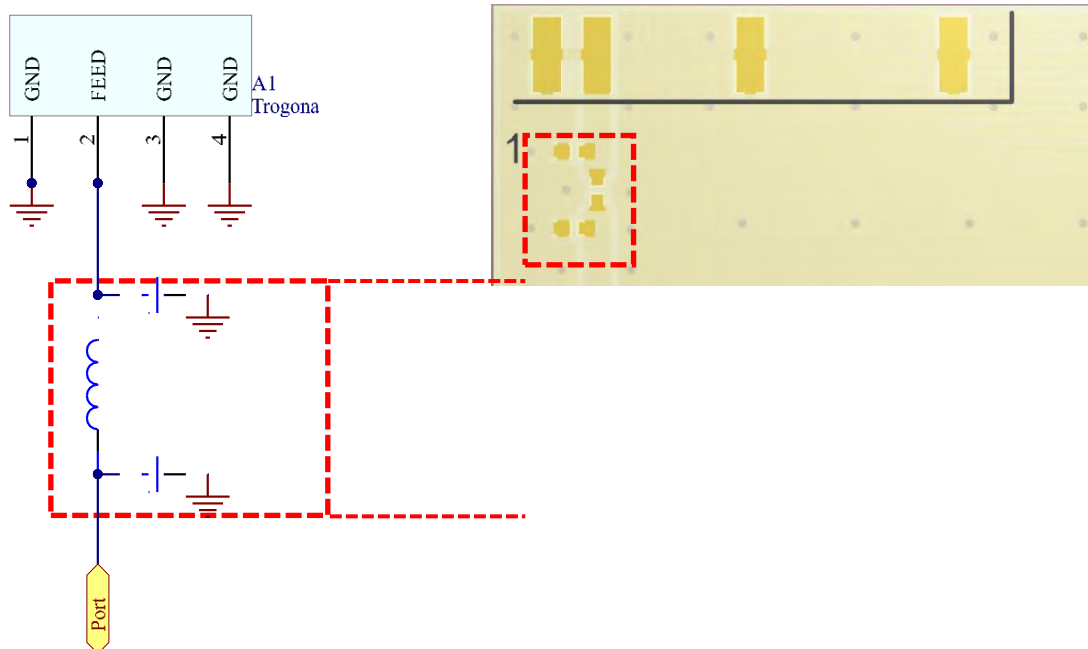

12.0 Antenna Integration Guide

12.1 Antenna Placement

Whichever the host PCB size used, the antenna should be placed into the PCB corner. Ideally Pin 1 should be closest to the PCB edge.

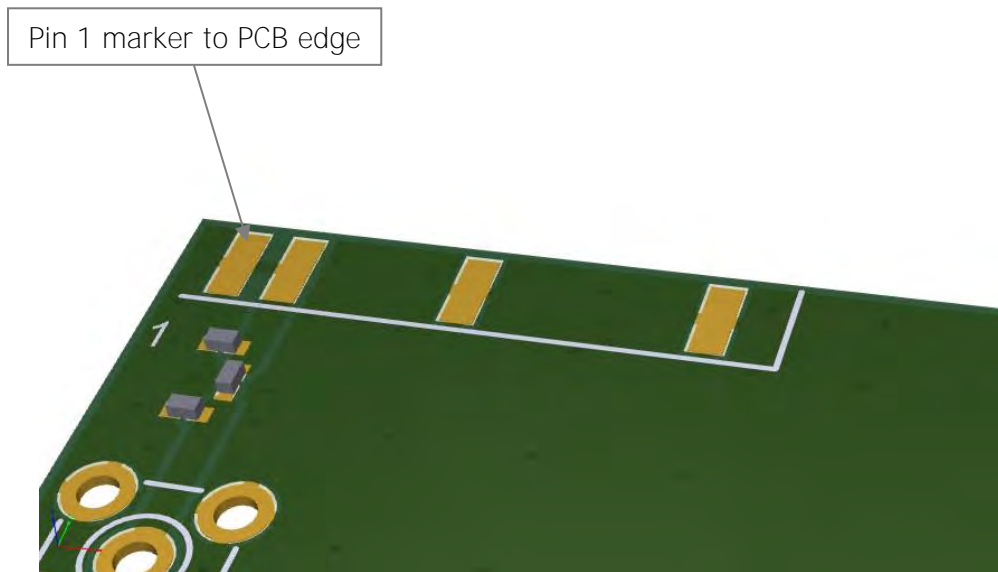

12.2 Host PCB Layout

The host PCB must ensure the footprint meets the antenna specification. An example of the PCB layout shows the antenna footprint. The antenna uses solder mask defined pads.

Example host layout



Below the footprint is shown again but without the solder mask. Pin 2 (feed) must be connected to pin 1 (GND) as shown here.

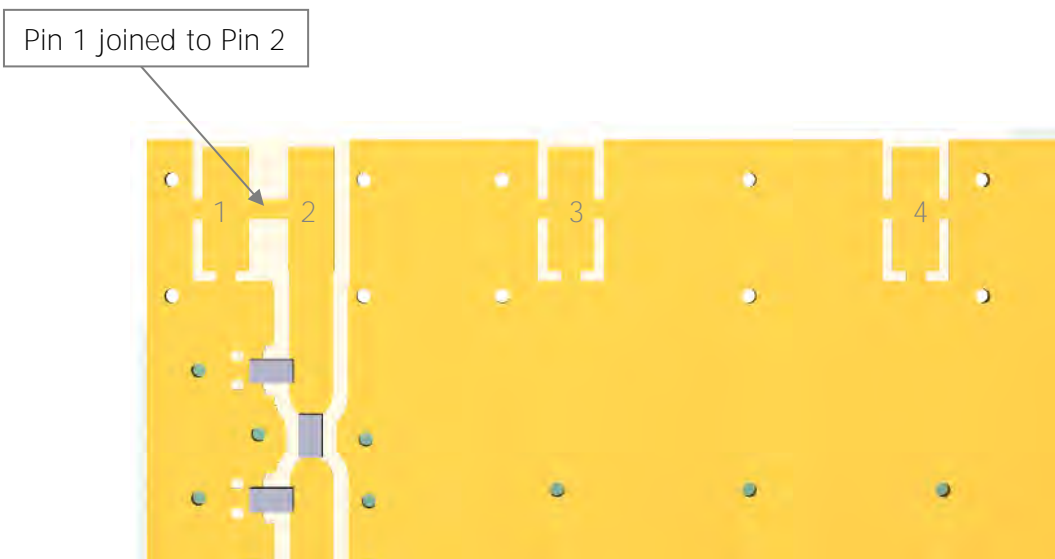

13.0 Reference Board

The reference board has been designed for evaluation purposes of SR42W009 and includes a SMA female connector.

SR42W009-U1 Evaluation Board

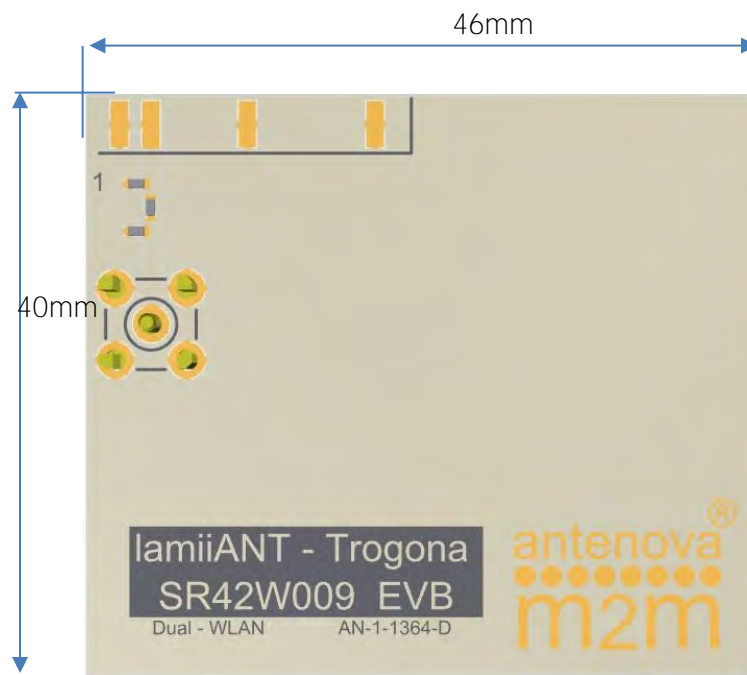

To order a reference board, please see www.antenna.com

13.1 Reference Board Matching Circuit

The reference board has been designed in order to evaluate the SR42W009 and is fitted with an SMA female connector.

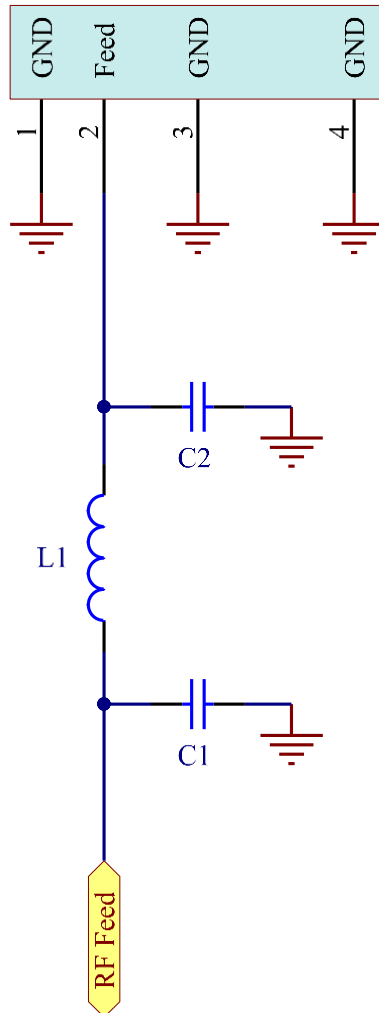

Designator	Type	Value	Description
C1	Capacitor	1.8pF	Murata GJM15 series
C2	Capacitor	Not fitted	Not fitted
L1	Inductor	1.8nH	Murata LQG15HN series

14. Soldering

This antenna is suitable for lead free soldering.

The reflow profile should be adjusted to suit the device, oven and solder paste, while observing the following conditions:

- The maximum temperature should not exceed 240 °C
- However for lead free soldering, a maximum temperature of 255 °C for no more than 20 seconds is permitted.
- The antenna should not be exposed to temperatures exceeding 120 °C more than 3 times during the soldering process.

15. Hazardous Material Regulation Conformance

The antenna has been tested to conform to RoHS requirements. A certificate of conformance is available from Antenova's website.

16. Packaging

16.1 Optimal Storage Conditions

Temperature	-10°C to 40°C
Humidity	Less than 75% RH
Shelf life	24 Months
Storage place	Away from corrosive gas and direct sunlight
Packaging	Reels should be stored in unopened sealed manufacturer's plastic packaging.

Note: Storage of open reels of antennas is not recommended due to possible oxidization of pads on antennas. If short term storage is necessary, then it is highly recommended that the bag containing the antenna reel is re-sealed and stored in like storage conditions as in above table.

16.2 Tape Characteristics

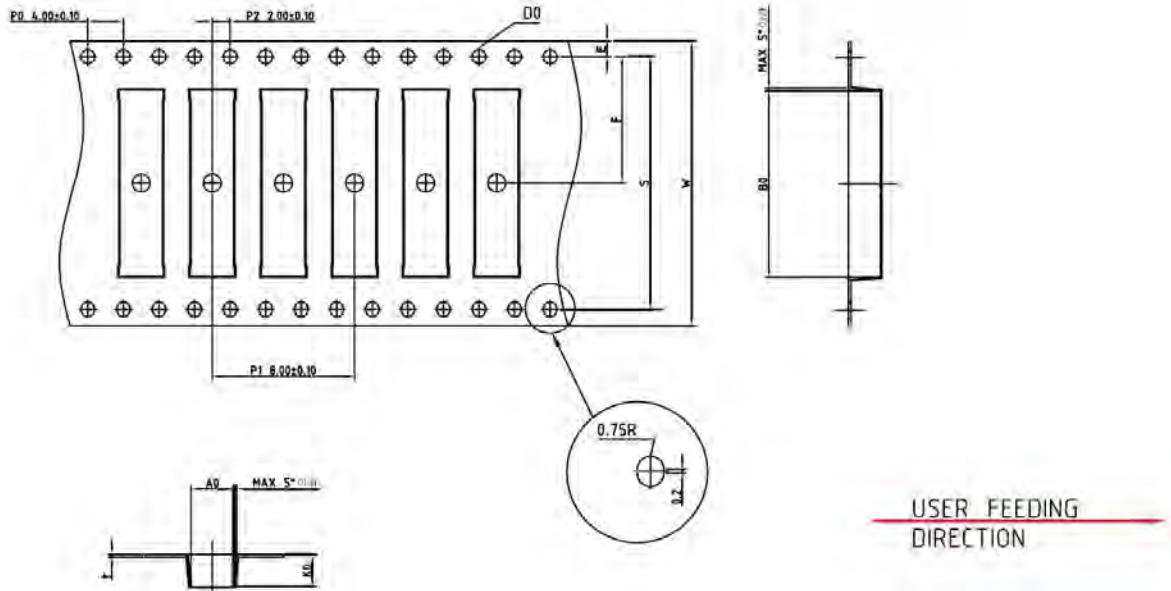

Do	Ao	Bo	P0	P1	P2
1.50 +0.1	3.60 ± 0.1	19.70 ± 0.1	4.00 ± 0.1	8.00 ± 0.1	2.00 ± 0.1

E	F	W	K0
1.75 ± 0.1	14.20 ± 0.1	32.00 ± 0.3	5.05 ± 0.1

Dimensions in mm

Notes:

- Sprocket hole pitch cumulative tolerance = ± 0.2 per 10
- Chamber not to exceed 1mm in 100mm
- Ao and Bo measured on a plane 0.1mm above the bottom of the pocket.
- K0 measured from a plane on the inside bottom of the pocket to the top surface of the carrier.

16.3 Reel Dimensions

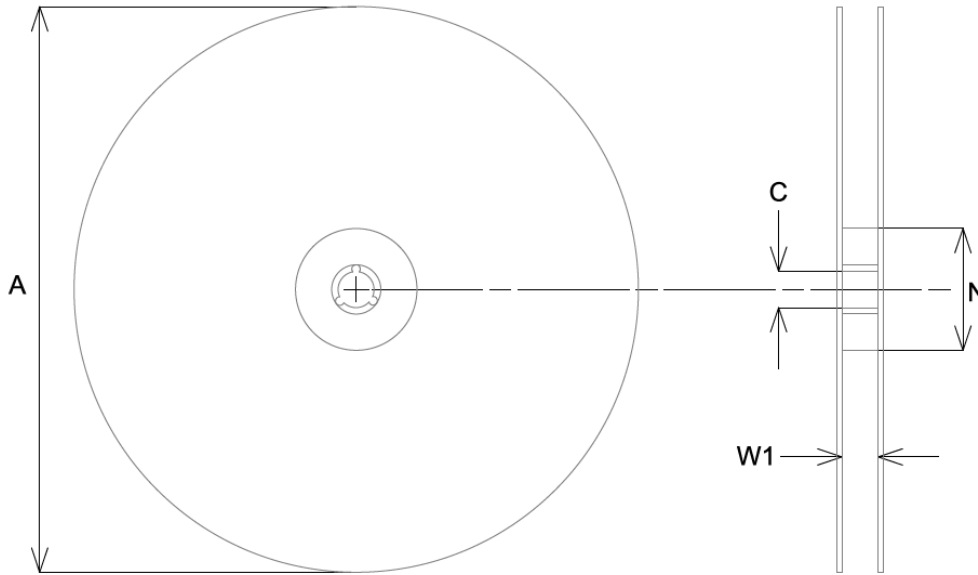

A	C	N	W1
178.0 ± 2.0	13.2 ± 0.5	60.0	14.0

All dimensions in mm

Quantity	Leading Space	Trailing Space
1000 pcs / reel	16 blank holders	24 blank holders

16.4 Box Dimensions

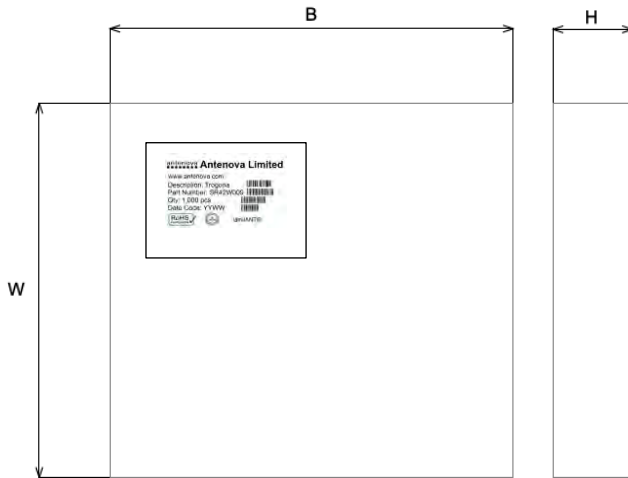

Width (W)	Breadth (B)	Thickness (H)
203mm	188mm	40mm

16.5 Bag Properties

Reels are supplied in protective plastic packaging.

16.6 Reel Label Information



Quality statements

Antenova's products conform to REACH and RoHS legislation. For our statements regarding these and other quality standards, please see www.antenova.com.



Antenna design, integration and test resources

Product designers – the details contained in this datasheet will help you to complete your embedded antenna design. Please follow our technical advice carefully to obtain optimum antenna performance.

It is our goal that every customer will create a high performing wireless product using Antenova's antennas. You will find a wealth of design resources, calculators and case studies to aid your design at our website.

Antenova's design laboratories are equipped with the latest antenna design tools and test chambers. We provide antenna design, test and technical integration services to help you complete your design and obtain certifications.

If you cannot find the antenna you require in our product range, please contact us to discuss creating a bespoke antenna to meet your requirement exactly.

Contacts

Join our online antenna design community: ask.antenova.com

Order antenna samples and evaluation boards at: www.antenova.com

Request a quotation for antennas by volume: sales@antenova.com

Global Headquarters:

**Antenova Ltd, 2nd Floor Titan Court, 3 Bishop Square,
Hatfield, AL10 9NA +44 (0) 1223 810600**

Copyright® Antenova Ltd. All Rights Reserved. Antenova®, gigaNOVA®, RADIONOVA®, the Antenova product family names and the Antenova logos are trademarks and/or registered trademarks of Antenova Ltd. Any other names and/or trademarks belong to their respective companies. The materials provided herein are believed to be reliable and correct at the time of printing. Antenova does not warrant the accuracy or completeness of the information, text, graphics or other items contained within this information. Antenova further assumes no responsibility for the use of this information, and all such information shall be entirely at the user's risk.