

SPECIFICATION FOR APPROVAL

2022110401

File No. _____

1.0

Revision _____

CUSTOMER: _____

CUSTOMER NO: _____

2.4-5.8GHz Antenna L=55MM

 PART NAME: _____

GC051G.300001.G01

 SUPPLIER NO: _____

Date:

Q'TY:

PCS

CUSTOMER APPROVED BY		
APPROVAL	CHIEF	SUPERVISOR

SUPPLIER SIGNATURE		
APPROVAL	CHECK	DESIGN
sunny	ZouJie	LuoYi

SH-RD-F04-A

List of Acknowledgement Items

NO.	(Contents)	(Number of Page)	(Page Code)
1	Spec Cover	1	1
2	Spec Item	1	2
3	Drawing	1	3
4	Test Reports	1	4
5	S Parameter	1	5
6	2.4G 2D/3D Pattern	1	6
7	5.8G 2D/3D Pattern	1	7
8			
9	.	.	.
10	.	.	.
11	.	.	.
12	.	.	.

Test Reports

Electrical Properties	
Frequency	2.4-2.5GHz 5.15-5.85GHz
Impedance	50 Ohm Nominal
V.S.W.R	1.92 : 1 Max
Return Loss	-10 dB Max
Radiation	Omni-directional
Gain (Peak)	3dBi
Efficiency	>60%
Polarization	Linear, Vertical
Admitted Power	1 W
Connector	
Physical Properties	
Antenna Material	FPC
Cable Type	O.D. 1.13mm // L= 55mm
Operating Temp.	-10 ~ +60 ° C
Storage Temp.	-10 ~ +70 ° C
Cable Color	Gray

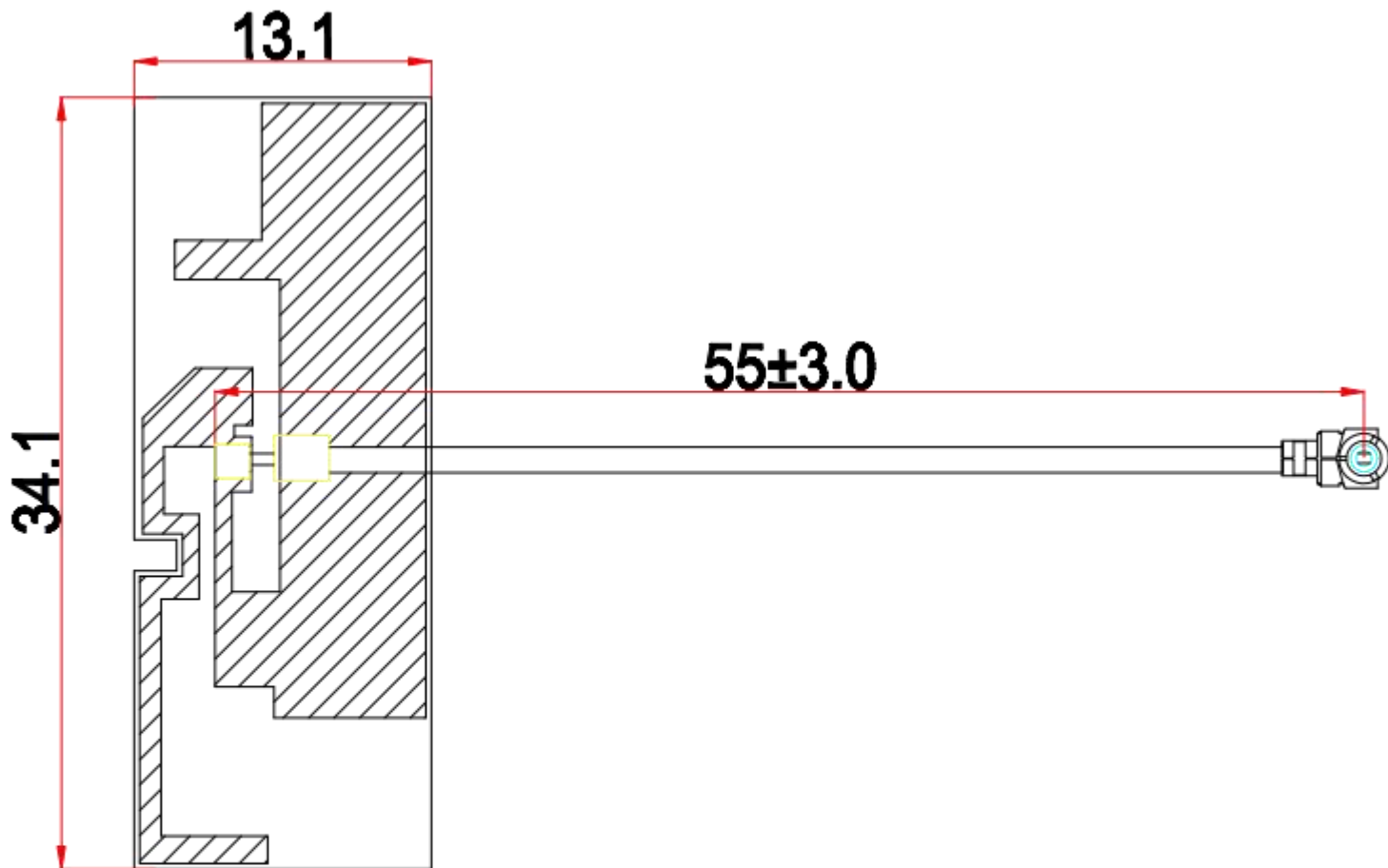

3	1-IPEX	O.D.1.13 special-purpose	1
2	FPC	34.1*13.1MM	1
1	Coaxial Cable	O.D.1.13 Gray	1
NO	PART NAME	DESCRIPTION	Q.TY

DongGuan GaoCang Co.,Ltd.			CUSTOMER			
			PART NO			
			TITLE wifi Antenna L=55mm			
			S.H P/NO GC051G.300001.G01			
	TOLERANCE UNLESS OTHERWISE SPECIFIED		SIZE	DRAWN	CHECKED	APPROVED
UNIT:mm	ANGLES ±0.5°	X. ±2.0	A4	LUOYI	ZOUJIE	
SHEET: 1/1	X.XX ±0.2	XX. ±5.0				
SCALE: 1/1	X.X ±0.5	DATE:2022-10-04				

S Parameter Test

Agilent E5071C

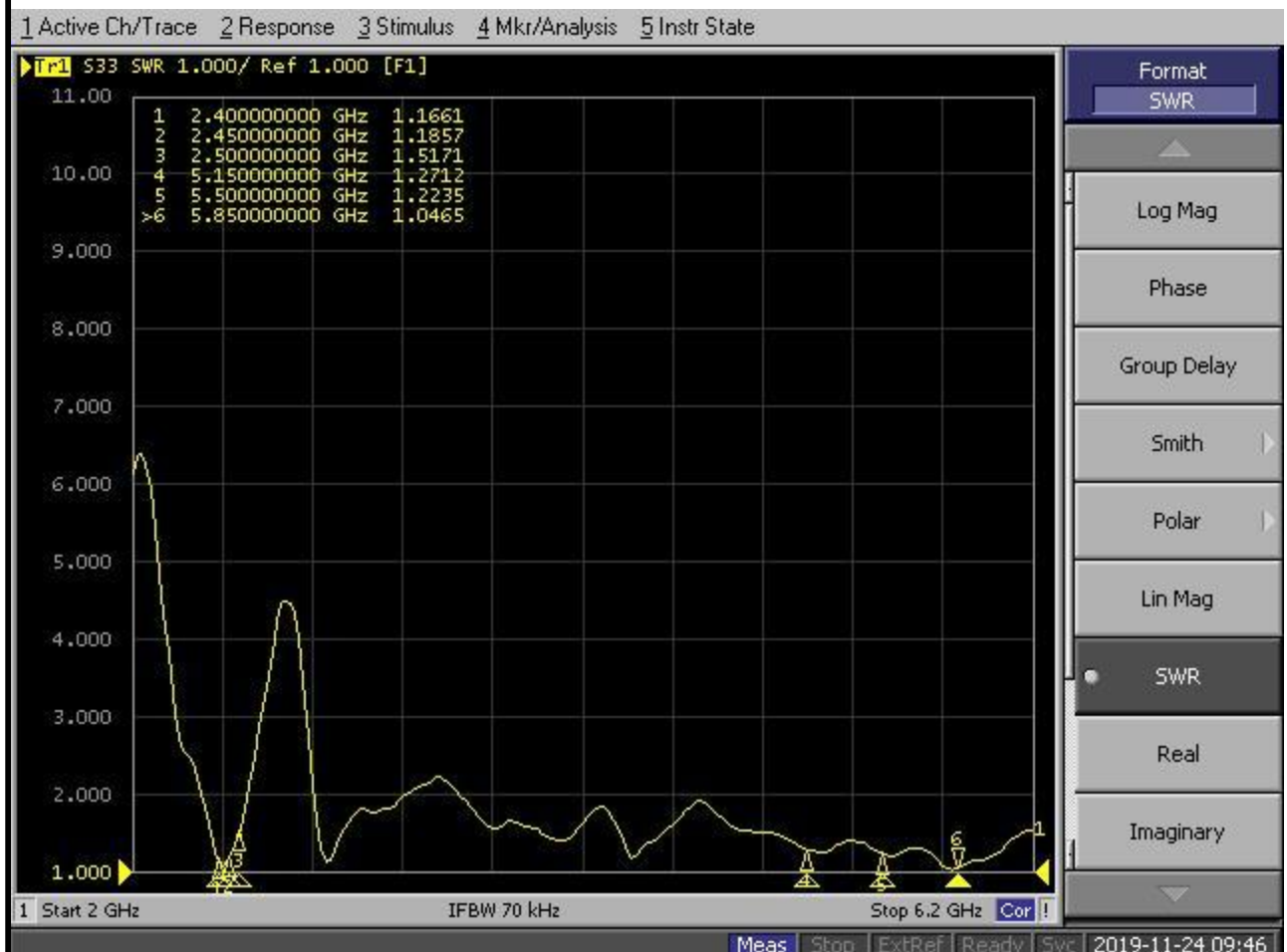

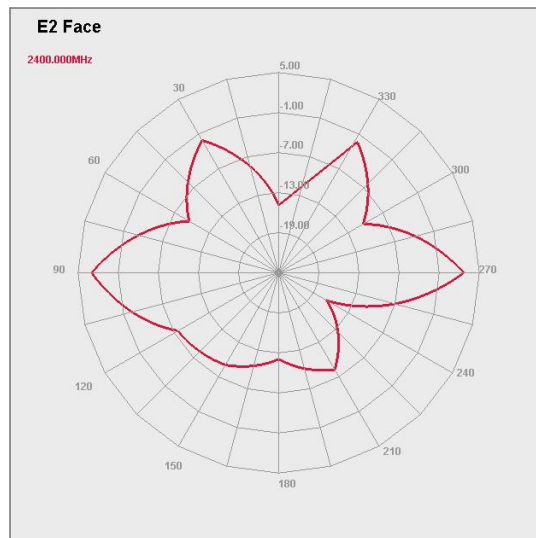
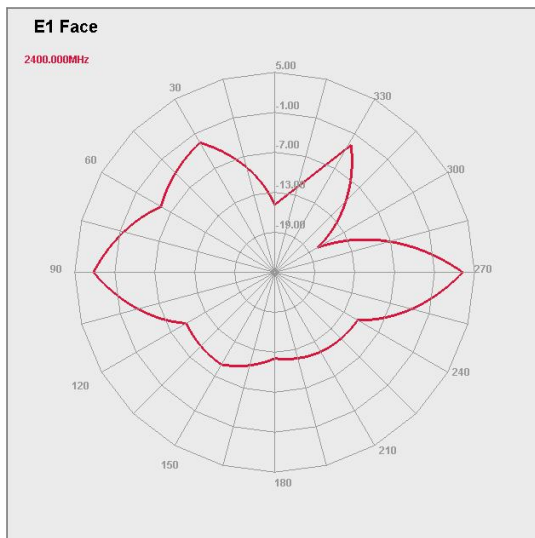
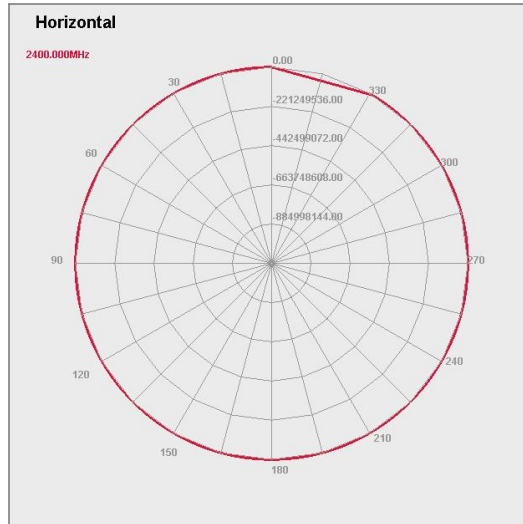
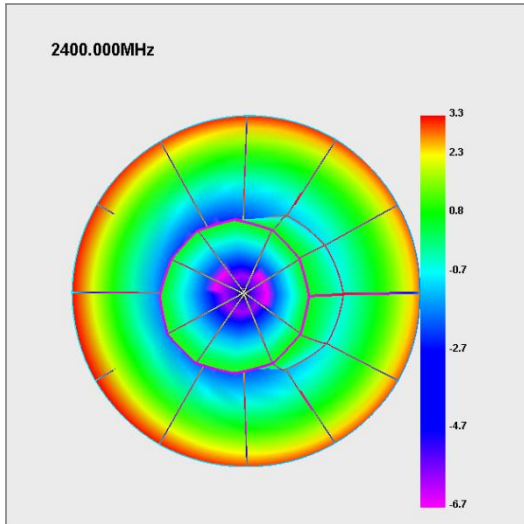

2.4G 2D/3D
2.4G 2D/3D Pattern

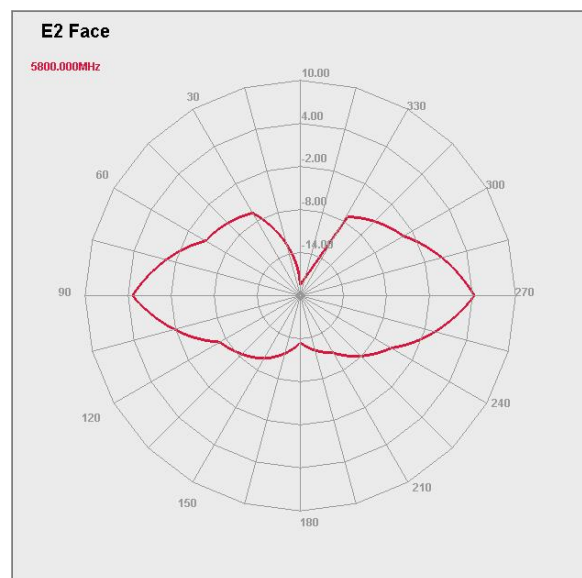
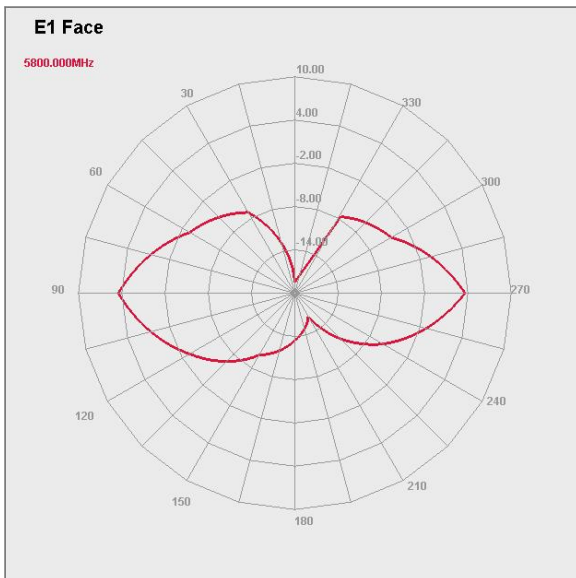
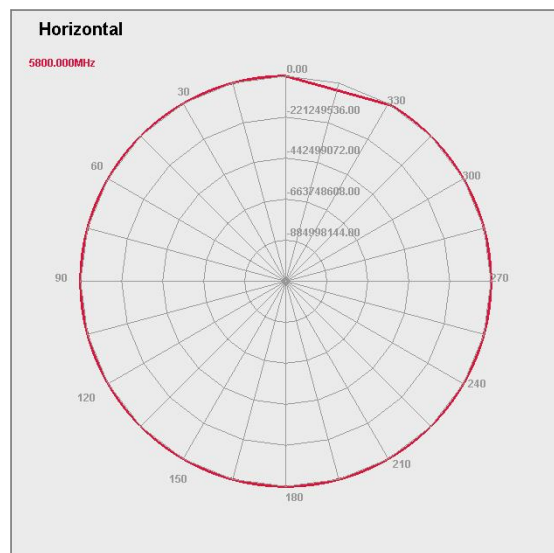
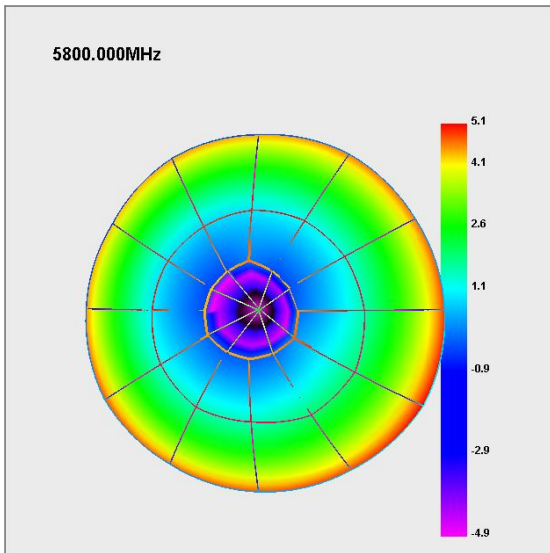

5.8G 2D/3D
5.8G 2D/3D Pattern