

KINGBOLEN

Version: V1.00.001

KINGBOLEN

FCC Requirement

Changes or modifications not expressly approved by the party responsible for compliance could void the user's authority to operate the equipment.

This device complies with Part 15 of the FCC Rules. Operation is subject to the following two conditions:

- (1) this device may not cause harmful interference, and
- (2) this device must accept any interference received, including interference that may cause undesired operation.

Note: This equipment has been tested and found to comply with the limits for a Class B digital device, pursuant to Part 15 of the FCC Rules. These limits are designed to provide reasonable protection against harmful interference in a residential installation. This equipment generates, uses, and can radiate radio frequency energy, and if not installed and used in accordance with the instructions, may cause harmful interference to radio communications. However, there is no guarantee that interference will not occur in a particular installation. If this equipment does cause harmful interference to radio or television reception, which can be determined by turning the equipment off and on, the user is encouraged to try to correct the interference by one or more of the following measures:

- Reorient or relocate the receiving antenna.
- Increase the separation between the equipment and receiver.
- Connect the equipment into an outlet on a circuit different from that to which the receiver is connected.
- Consult the dealer or an experienced radio/TV technician for help.

FCC WARNING

This equipment may generate or use radio frequency energy. Changes or modifications to this equipment may cause harmful interference unless the modifications are expressly approved in the instruction manual. The user could lose the authority to operate this equipment if an unauthorized change or modification is made.

This device complies with part 15 of the FCC Rules. Operation is subject to the following two conditions: (1) This device may not cause harmful interference, and (2) this device must accept any interference received, including interference that may cause undesired operation.

NOTE: This equipment has been tested and found to comply with the limits for a Class B digital device, pursuant to part 15 of the FCC Rules. These limits are designed to provide reasonable protection against harmful interference in a residential installation. This equipment generates, uses and can radiate radio frequency energy and, if not installed and used in accordance with the instructions, may cause harmful interference to radio communications. However, there is no guarantee that interference will not occur in a particular installation. If this equipment does cause harmful interference to radio or television reception, which can be determined by turning the equipment off and on, the user is encouraged to try to correct the interference by one or more of the following measures:

- Reorient or relocate the receiving antenna.
- Increase the separation between the equipment and receiver.
- Connect the equipment into an outlet on a circuit different from that to which the receiver is connected.
- Consult the dealer or an experienced radio/TV technician for help.
- The rating information is located at the bottom of the unit.

FCC/IC RF Radiation Exposure and SAR Statements

The device has been tested for body-worn Specific Absorption Rate (SAR) compliance. The FCC/IC has established detailed SAR requirements and has established that these requirements. RF Exposure Information The radio module has been evaluated under FCC Bulletin C95.1 and IEEE 1528 and found to be compliant to RF Exposure from radio frequency devices. This model meets the applicable government requirements for exposure to radio frequency waves. The highest reported SAR level for usage near the body (0mm) is 0.63 W/kg.

IC Statements

This device complies with Industry Canada license-exempt RSS standard(s). Operation is subject to the following two conditions: 1. This device may not cause interference, and 2. This device must accept any interference, including interference that may cause undesired operation of the device.

Le présent appareil est conforme aux CNR d'Industrie Canada applicables aux appareils radio exempts de licence. L'exploitation est autorisée aux deux conditions suivantes :

- (1) l'appareil ne doit pas produire de brouillage, et (2) l'utilisateur de l'appareil doit accepter tout brouillage radioélectrique subi, même si le brouillage est susceptible d'en compromettre le fonctionnement.

Copyright Information

Copyright © 2022 by SHENZHEN KINGBOLEN ELECTRONIC TECHNOLOGY.,LTD (hereinafter referred to as "KINGBOLEN"). All rights reserved. No part of this publication may be reproduced, stored in a retrieval system, or transmitted in any form or by any means, electronic, mechanical, photocopying and recording or otherwise, without the prior written permission of KINGBOLEN. The information contained herein is designed only for the use of this unit. KINGBOLEN is not responsible for any use of this information as applied to other units.

Neither KINGBOLEN nor its affiliates shall be liable to the purchaser of this unit or third parties for damages, losses, costs, or expenses incurred by purchaser or third parties as a result of: Accident, misuse, or abuse of this unit, or unauthorized modifications, repairs, or alterations to this unit, or failure to strictly comply with KINGBOLEN operating and maintenance instructions. KINGBOLEN shall not be liable for any damages or problems arising from the use of any options or any consumable products other than those designated as Original KINGBOLEN Products or KINGBOLEN Approved Products. Formal statement: The names of other products mentioned in this manual are intended to explain how to use this equipment, and the registered trademark ownership still belongs to the original company. This equipment is designed for professional technicians or maintenance personnel.

Safety Precautions and Warnings

To avoid personal injury, property loss, or accidental damage to the product, read all of the information in this section before using the product.

Handle equipment carefully

Do not drop, bend, or puncture the tool, or insert extra objects into or place heavy objects on the device. The vulnerable components inside may be damaged.

Do not disassemble or modify the equipment

The device is a sealed device with no user-serviceable parts inside. All internal repairs must be performed by an authorized maintenance organization or qualified technician. Attempts to disassemble or modify the device will void the warranty.

Do not try to replace the internal battery

The internal rechargeable lithium battery must be replaced by an authorized maintenance organization or qualified technician. Contact the dealer for factory replacement.

Adapter information

Avoid immersing the device in water or placing it in a location where it may absorb moisture or other liquids. During normal use, the charging device may become hot. Please ensure that there is good ventilation while charging device.

If any of the following situation occurs, please unplug the charging device:

- The charging device is exposed to rain, liquid or in an environment with excessive overlap.
- The charging device showed physical damage.
- Cleaning the charging device.

Data and Software Protection

Do not delete unknown files or change the names of files or directories created by others, otherwise the device software may not run.

 Note: Access to network resources makes the device vulnerable to computer viruses, hackers, spyware, and other malicious behaviors, and may damage the device, software, or data. To make ensure that you are using firewalls, anti-virus software and anti-spyware software to provide adequate protection for your computer and keep these softwares up to date.

Precautions on Using this tool

- To make sure the ignition switch should be in the OFF position when plugging and unplugging the diagnostic connector.
- Keep the connector in the storage box on the back of the main unit, when the vehicle diagnosis is finished.
- Gently press the diagnostic connector to pop up the diagnostic connector. Do not pull or use sharp objects to pry the diagnostic connector.

Precautions on Operating Vehicle's ECU

- Do not disconnect battery or any wiring cables in the vehicle when the ignition switch is on, as this could avoid damage to the sensors or the ECU.
- Do not place any magnetic objects near the ECU. Disconnect the power supply to the ECU before performing any welding operations on the vehicle.
- Use extreme caution when performing any operations near the ECU or sensors. Ground yourself when you disassemble PROM, otherwise ECU and sensors can be damaged by static electricity.
- When reconnecting the ECU harness connector, be sure it is attached firmly, otherwise electronic elements, such as ICs inside the ECU, can be damaged.

Content

1. Quick Start Manual	1
1.1 Initial Use.....	1
1.1.1 Turn on the Machine.....	1
1.1.2 Language Setting.....	1
1.1.3 Connect Wi-Fi.....	1
1.1.4 Choose Time Zone.....	2
1.1.5 User Agreement.....	2
1.1.6 Create an Account.....	2
1.1.7 VCI Activation.....	3
1.2 Diagnosis Flowchart.....	3
1.3 Function Menu.....	4
1.4 Charging.....	5
1.5 Battery.....	5
1.6 VCI Connections.....	5
1.7 Scope Box / Video Scope / Printer Installation.....	8
1.8 Wireless TPMS / Battery Tester Installation (Bluetooth).....	9
2. Introduction	9
2.1 Product Profile (KINGBOLEN K10/K10 Plus).....	9
2.2 Components & Controls.....	10
2.3 Parameters.....	12
3. Begin to Use	12
3.1 Intelligent Diagnosis.....	12
3.2 Diagnosis.....	13
3.2.1 Manual Diagnosis.....	13
3.2.2 Smart Scan.....	14
3.2.3 System Scan.....	15
3.2.4 Choose to Scan.....	15
3.2.5 System and Function.....	16
3.3 Quick Check.....	20
3.4 Maintenance.....	21
3.4.1 Oil Reset.....	21
3.4.2 Elec. Throttle Adaption.....	21
3.4.3 Steering Angle Reset.....	22
3.4.4 Battery Matching.....	22
3.4.5 ABS Bleeding.....	22
3.4.6 Brake-pad Reset.....	22
3.4.7 DPF Regeneration.....	23
3.4.8 Gear Learning.....	23
3.4.9 IMMO Service.....	23
3.4.10 Injector Coding.....	23
3.4.11 TPMS Reset.....	23
3.4.12 Suspension Matching.....	24
3.4.13 AFS Reset.....	24
3.4.14 A/T Learning.....	24
3.4.15 Sunroof Initialization.....	24
3.4.16 EGR Adaption.....	24
3.4.17 ODO Reset.....	24
3.4.18 Airbag Reset.....	24
3.4.19 Transport Mode.....	24
3.4.20 A/F Reset.....	25
3.4.21 Stop/Start Reset.....	25
3.4.22 NOx Sensor Reset.....	25
3.4.23 AdBlue Reset (Diesel Engine Exhaust Gas Filter).....	25

3.4.24	Seat Calibration	25
3.4.25	Coolant Bleeding	25
3.4.26	Tyre Reset	25
3.4.27	Windows Calibration	25
3.4.28	Language Change	25
3.4.29	AC System Relearn/Initialization	25
3.4.30	Intelligent Cruise Control System	25
3.4.31	Engine Power Balance Monitoring	26
3.4.32	Gas Particulate Filter Regeneration	26
3.4.33	Motor Angle Calibration	26
3.4.34	High Voltage Battery Diagnostics	26
3.4.35	IMMO PROG (optional)	26
3.5	TPMS Diagnosis.....	26
3.6	ADAS	27
3.7	Module.....	28
3.8	Remote Assistance.....	28
3.9	Store.....	29
3.10	File.....	29
3.11	Repair Info.....	30
3.11.1	OBD Fault Code Library.....	30
3.11.2	Coverage List.....	30
3.11.3	Learning materials	30
3.11.4	User Manual.....	30
3.12	Update	30
3.13	Feedback.....	31
4.	User Info	32
4.1	VCI.....	33
4.2	Activate VCI.....	33
4.3	Activate TPMS VCI.....	33
4.4	Fix VCI firmware/system.....	34
4.5	Data Stream Sample	34
4.6	My Order.....	34
4.7	Profile	34
4.8	Change Password	34
4.9	Wi-Fi	34
4.10	Diagnostic Software Clear	34
4.11	Business Information	34
4.12	Customer Management.....	34
4.13	Diagnostic Record	35
4.14	Photo Album	35
4.15	Screen Recorder	35
4.16	Clear VCI Data	35
4.17	Settings.....	35
4.17.1	Check for Updates	35
4.17.2	Sleep Time.....	35
4.17.3	Privacy Policy	35
4.17.4	System Upgrade	35
4.17.5	Units.....	36
4.17.6	Clear Cache	36
4.17.7	Mode Switch	36
4.17.8	Restore Factory Settings	36
4.18	Hotkey Setting	36
5.	FAQ	37

KINGBOLEN

1. Quick Start Manual

1.1 Initial Use

The following settings should be made when you initially use the device.

1.1.1 Turn on the Machine

After pressing the power button, images will be shown on the screen as follows.



1.1.2 Language Setting

Select the target language from the languages displayed on the interface.



1.1.3 Connect Wi-Fi

The system will automatically search all available Wi-Fi networks. Please connect to the trusted Wi-Fi.

⚠️ Tips: Wi-Fi must be set. If there is no Wi-Fi network is available nearby, you can try "Portable Mobile Hotspot".



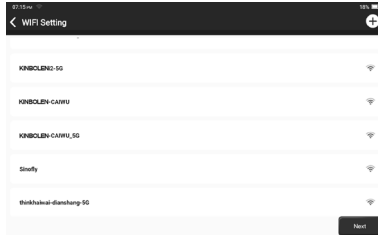

1.1.4 Choose Time Zone

Choose the time zone of the current location, then the system will automatically configure the time.



1.1.5 User Agreement

Please read all the terms and conditions of the user agreement carefully. Choose “Agree all the above terms”, and tap “Next” to complete the registration process.

Then the page will jump to the “Congratulations on your successful registration” interface.

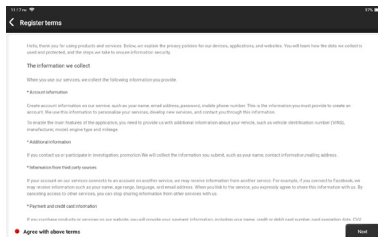

1.1.6 Create an Account

You need to use your email account to register a KINGBOLEN personal account. This account can be applied to all KINGBOLEN products, and you can log in directly with this account when using other KINGBOLEN device.

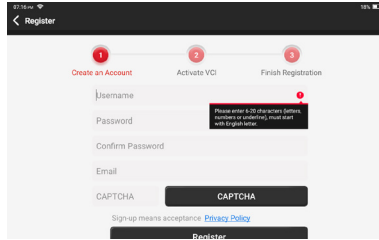

1.1.7 VCI Activation

Enter the connector serial number and activation code to activate and bind the diagnostic connector. If you have not activated it, you can also tap "Settings" on the main interface to enter and select "Activate" to operate.

⚠️ Tips: The activation code is an 8-digit number and is pasted on the "password letter".

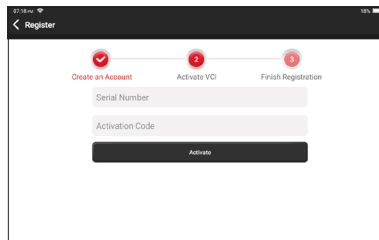

1.2 Diagnosis Flowchart

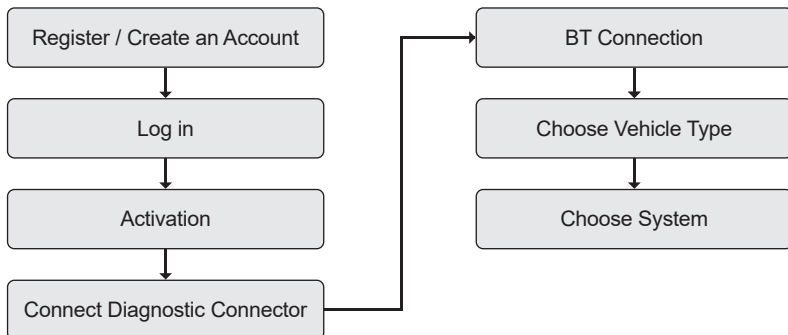

1.3 Function Menu

After startup, the system will automatically enter the homepage:



It mainly includes the following features:

- The device and diagnostic connector support wired communication and Bluetooth communication.
- Support powerful intelligent VIN recognition technology, which is convenient, fast and efficient.
- Quick check: Automatic Identification of Vehicle Information, Auto Checking and Report Printing.
- Modular expansion: printer, video scope, scope box, battery test clip, wireless TPMS tool.
- It can detect faults in the electronic control systems of most high-end, medium-end, and low-end vehicles in Asia, Europe, the United States and China. Powerful diagnostic functions include reading fault codes, clearing fault codes, reading data streams, action tests, and other special functions.
- Maintenance function: matching, coding, programming of most vehicles' programmable modules, and most commonly used maintenance and reset functions: Oil Reset; Elec. Throttle Adaption; IMMO Service; Injector Coding; Brake-pad Reset; Steering Angle Reset; ABS Bleeding; AFS Reset; Battery Matching; A/T Learning; DPF Regeneration; EGR Adaption; TPMS Reset; Sunroof Initialization; Suspension Matching; Gear Learning; Airbag Reset; ODO Meter Reset; AdBlue Reset; A/F Reset; Coolant Bleeding; Language Change; NOx Sensor Reset; Seat Calibration; Stop/Start Reset; Transport Mode; Tyre Reset; Windows Calibration; AC System Relearn/Initialization; Engine Power Balance Monitoring; Gas Particulate Filter Regeneration; High Voltage Battery Diagnostics; Intelligent Cruise Control System; Motor Angle Calibration; IMMO PROG (optional).
- TPMS: with wireless TPMS tool (optional), TPMS activation, programming and learning functions can be supported.
- Diagnostic software, client-side and firmware can be updated online.
- Feedback: In the process of diagnosis, if the software or function is abnormal, please feed back to us. Our professionals will follow up and deal with it in time.

KINGBOLEN

1.4 Charging

Follow the steps below to charge the device:

- Use the charger to connect the device and the power socket to charge.
- When the battery status displays , the device is charging.

When it displays , the charging process has been completed and you shall disconnect the device.

1.5 Battery

- It is normal that the device cannot be turn on when charging because the battery has not been used for a long time or maybe the power is exhausted. Please turn on the device again after charging the battery for a while.
- Please use the charger in the package to charge the device. Except for the chargers specified by the company, the company shall not be liable for any damage and loss caused by charging with other chargers.
- The battery can be recharged repeatedly. Please try not to recharge frequently to avoid battery loss and prolong battery life.
- The battery charging time varies with temperature and battery status.
- When the battery power is low, the system will pop up a prompt to remind you to connect the charger. When the battery power is too low, the device will turn off.

1.6 VCI Connections

Connection steps as below:

- (1) Locate vehicle's DLC socket. Most of the DLC are standard OBDII/EOBD diagnostic sockets (non-standard OBDII/EOBD vehicle diagnostic sockets need to use the corresponding adapter). The DLC is usually located 12 inches from the center of the instrument panel (dash), under or around the driver's side for most vehicles. If the DLC cannot be found, refer to the vehicle's service manual for the location.

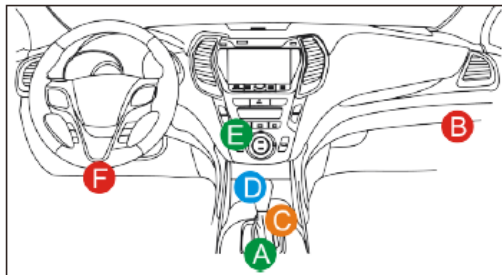

A	Opel, Volkswagen, Audi
B	Honda
C	Volkswagen
D	Opel, Volkswagen, Citroen
E	Changan
F	Hyundai, Daewoo, Kia, Honda, Toyota, Nissan, Mitsubishi, Renault, Opel, BMW, Mercedes-Benz, Mazda, Volkswagen, Audi, GM, Chrysler, Peugeot, Regal, Beijing Jeep, Citroen and most prevailing models

- (2) For OBDII/EOBD vehicle, follow the steps below to proceed:

- a. Plug the VCI dongle into the vehicle's DLC socket
- b. Use the OBDII/EOBD extension cable to connect the VCI dongle and DLC socket.

(3) For non-OBDII/EOBD vehicle, If the pin of the DLC is damaged or has insufficient power, please try any of the following methods to proceed:

- a. Cigarette Lighter Cable
- b. Battery Clamps Cable

(4) Non-standard 16-PIN vehicle diagnostic sockets (OBDI).

A. Introduction of OBD vehicle diagnosis connector

In the development history of automobile diagnosis and detection, OBD system is an online diagnostic system for internal combustion engines, which currently goes through a generation and a second generation, the second generation being EOBD/OBDII, as shown in the diagram below, with a unified hardware feature and interface definition for the diagnostic seat of the car.

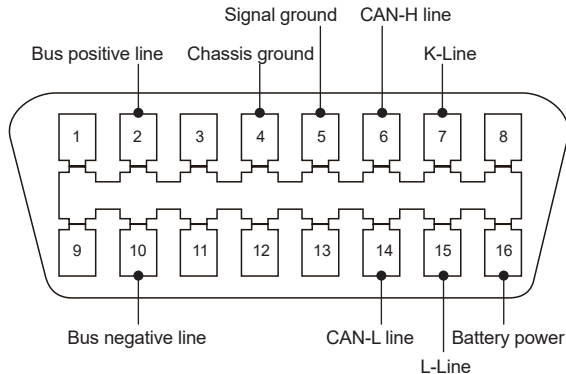



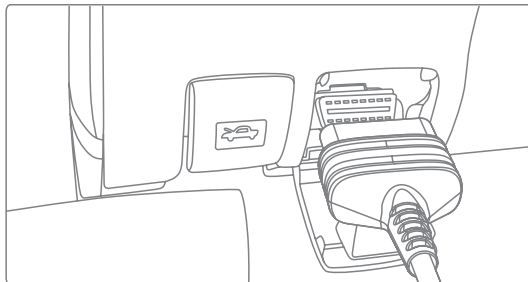



OBD II Connector and Pinout



OBD II Diagnostic Port of Automobile

KINGBOLEN

About 1996, before the United States unified the OBD II standard and during the transition period, different automobile manufacturers had different diagnostic port for OBD I. Such as three PIN like HONDA; 17 PIN like Toyota; 38 PIN like BENZ. At present, all overseas comprehensive diagnostic device are equipped with 10 OBD I diagnostic connectors, as shown in the table below:

CR-6 1 PC		BZ-38 1 PC	
TA-17 1 PC		TA-22 1 PC	
B-20 1 PC		GN-12 1 PC	

OBD I Diagnostic Port on the Packing List

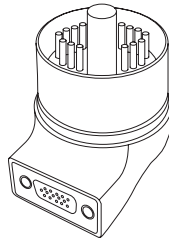

Diagnostic Connector for BMW 20

B. How to connect OBD I Diagnostic Port

The OBD I connector, which was set up to cater for older models of various car brands, has very few current applications as most older cars have been phased out. Cars that produced after 2005 are basically all OBD II connector. In USA, we still occasionally come across vintage or modified cars that still use OBD I. For this reason, a transfer from OBD II to OBD I is required.

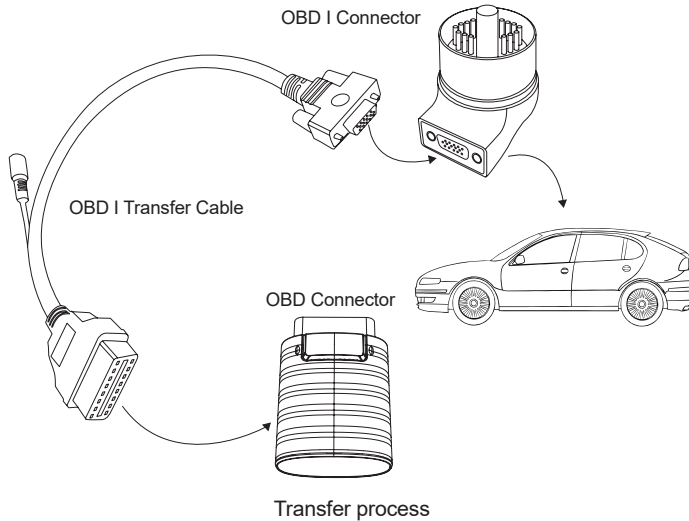

⚠ Note: when using older models, the Transfer Cable must be used, with the small power connector on it, which is connected to the power connector of the power double clamp cable, this is a solution for certain cars before 1996, whose diagnostic holders do not have a 12V power supply.

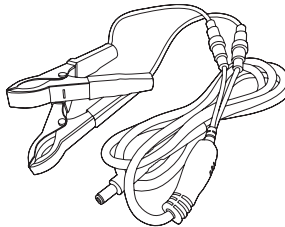

Application of the double clamp power cable

All other configurations with Non 16-PIN diagnostic connectors can be wired as shown in Picture 5 for achieving the diagnosis of the corresponding old models.

1.7 Scope Box / Video Scope / Printer Installation

The Scope Box and Video Scope are connected by USB cable. It will automatically enter the corresponding interface once they are connected.

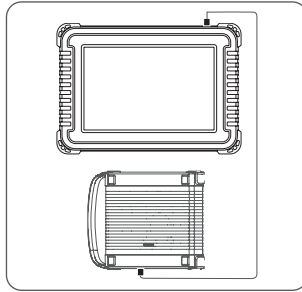

1.8 Wireless TPMS / Battery Tester Installation (Bluetooth).

Tap Wireless TPMS or Battery Tester, and you can detect the corresponding module in Bluetooth mode. You need to match the module by activating it.

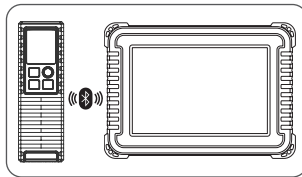

2. Introduction

2.1 Product Profile (KINGBOLEN K10/K10 Plus)

The device based on the Android 10 System, is a new generation of modular high-end intelligent diagnostic equipment developed by KINGBOLEN. The device adopts a unique modular design to meet various application scenarios, including diagnostic module, printer, videoscope, work light, thermal imager, scope box, moduledock and TPMS tool.

2.2 Components & Controls

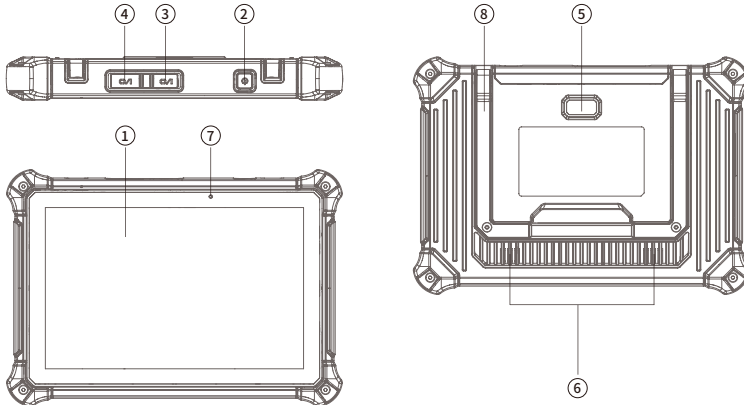

No.	Function
1	Display
2	Power Key: Hold the button for 3 seconds to turn the device on, or off, and 10 seconds for a forced restart. Press the button to wake up the device or turn off the device.
3	Type C Port: connect the supplied charger for charging.
4	USB Port: Reserved for add-on modules and other devices with similar port.
5	8 Megapixel Rear Camera
6	Speaker

KINGBOLEN

7	8 Megapixel Front Camera
8	Adjustable Kickstand: Able to keep the device standing on the desk, or hang the device on the steering wheel with 180 degree rotation.

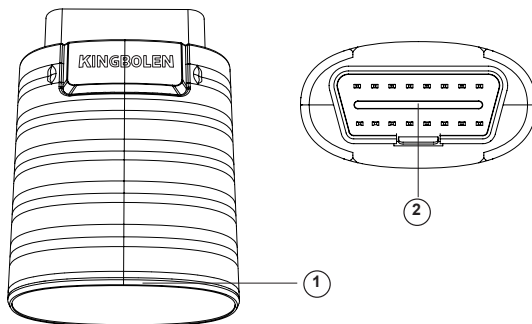

NO.	Name	Descriptions																		
1	Indicator Light	<p>LED indicator is located at the bottom, and the three status as follows:</p> <ul style="list-style-type: none"> • Power: Green light indicates that the power is on. • Diagnosis: Blue light shows that it enter the diagnosis mode. • Vehicle: Flashing-blue light means it is communicating with the vehicle. 																		
2	Diagnostic Port	Plug in the diagnostic cable whose OBD 16-pin connector is linked to the DLC of the vehicle.																		
3	Supporting protocols	<table border="0"> <tr> <td>ISO 9142</td> <td>Middlespeed CAN</td> </tr> <tr> <td>ISO 14230</td> <td>Lowspeed and Singlewire CAN</td> </tr> <tr> <td>ISO 15765</td> <td>GM UART</td> </tr> <tr> <td>K/L-Line</td> <td>TP 2.0</td> </tr> <tr> <td>Flashing Code</td> <td>TP 1.6</td> </tr> <tr> <td>CAN ISO 11898</td> <td>UART Echo Byte Protocol</td> </tr> <tr> <td>SAE-J1850 VPW</td> <td>Honda Diag-H Protocol</td> </tr> <tr> <td>SAE-J1850 PWM</td> <td>Fault-Tolerant CAN</td> </tr> <tr> <td>Hightspeed CAN</td> <td>SAE-J2610</td> </tr> </table>	ISO 9142	Middlespeed CAN	ISO 14230	Lowspeed and Singlewire CAN	ISO 15765	GM UART	K/L-Line	TP 2.0	Flashing Code	TP 1.6	CAN ISO 11898	UART Echo Byte Protocol	SAE-J1850 VPW	Honda Diag-H Protocol	SAE-J1850 PWM	Fault-Tolerant CAN	Hightspeed CAN	SAE-J2610
ISO 9142	Middlespeed CAN																			
ISO 14230	Lowspeed and Singlewire CAN																			
ISO 15765	GM UART																			
K/L-Line	TP 2.0																			
Flashing Code	TP 1.6																			
CAN ISO 11898	UART Echo Byte Protocol																			
SAE-J1850 VPW	Honda Diag-H Protocol																			
SAE-J1850 PWM	Fault-Tolerant CAN																			
Hightspeed CAN	SAE-J2610																			

2.3 Parameters

	K10	K10 PLUS
Operating System	Android 10.0	Android 10.0
Memory	4G	4G
Storage	64G	128G
Battery	12600mAh\3.7V	12600mAh\3.7V
Screen	10 inches	10 inches
Camera	Front Camera 8.0MP Rear Camera 8.0MP	Front Camera 8.0MP Rear Camera 8.0MP
Network	Wi-Fi, WLAN 802.11b/g/n	Wi-Fi, WLAN 802.11b/g/n
Bluetooth	Bluetooth 5.1	Bluetooth 5.1
Working Temperature	32 °F ~122 °F (0°C ~ 50°C)	32 °F ~122 °F (0°C ~ 50°C)
Storage Temperature	-4 °F ~140 °F (-20°C ~ 60°C)	-4 °F ~140 °F (-20°C ~ 60°C)

3. Begin to Use

Diagnostic function, covering more than 100 car brands, support intelligent diagnosis and traditional diagnosis, including OBDII full-function diagnosis. Full-system diagnosis includes: read fault code, clear fault code, read real-time data stream, special function, actuation test. A diagnosis report can be generated after the diagnosis.

3.1 Intelligent Diagnosis

Connect the vehicle first, tap "Intelligent Diagnosis" on the homepage, the device will start the smart diagnosis program and automatically read the vehicle VIN, as shown in below:



If the device failed to access the VIN information, please use "Diagnosis". At this point, you need to manually input the VIN code to gain the car information.

3.2 Diagnosis

In this mode, user can manually select vehicle models and systems for diagnosis.

3.2.1 Manual Diagnosis

The device also supports step-by-step manual selection of menus for diagnosis. To use the "DEMO" as an example to introduce how to start the diagnosis as below.

1. Select vehicle type: on the "demo" on the main diagnostic interface to enter.

⚠️ Tips: The diagnosis menu varies with different vehicles

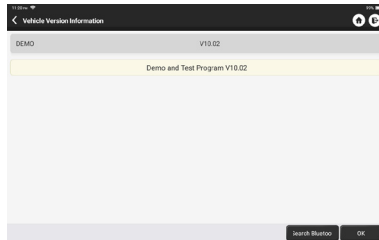

2. Select Diagnostic method: The interface has two display modes of system topology and system list, with the same functions. Switch according to personal preference.



System and function

System List ADAS Calibration

System	Status	Action
PCM (Powertrain Control Module)	Not Scanned	Enter
TCM (Transmission Control Module)	Not Scanned	Enter
ABS (Anti-lock Braking System)	Not Scanned	Enter
RCM (Restraint Control Module)	Not Scanned	Enter
BDM (Body Control Module)	Not Scanned	Enter
IMMO (Immobilizer)	Not Scanned	Enter
APIM (Accessory Protocol Interface Module)	Not Scanned	Enter

FCM: F300, 2012, VW, 1778WDTFC00000, 0000V1302 - F0B

Buttons: Smart Scan, System Scan, Code to Scan

3.2.2 Smart Scan

It enables you to quickly access all the electronic control units of the vehicle and generate a detailed report about vehicle health. (This function varies from vehicle to vehicle.) The system will start scanning Electronic Control Units to see if there are fault code and displays the specific results.

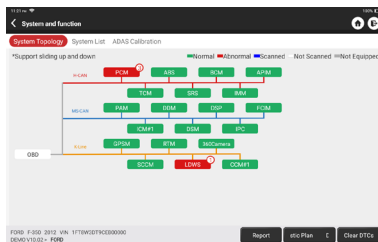

Tap "Report" to generate a vehicle health report.

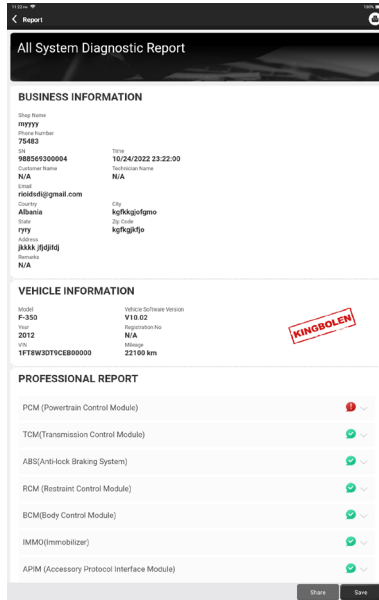

3.2.3 System Scan

To check how many systems the car is equipped with.

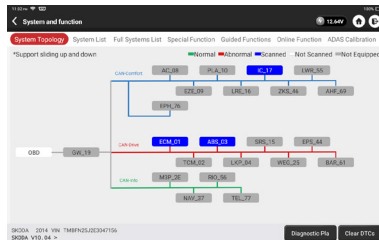

3.2.4 Choose to Scan

Choose the target automotive electronic control system to scan.

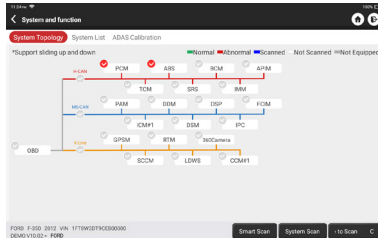

3.2.5 System and Function

After "Smart Scan", And then we can choose one system to check the detail information. Tap "PCM" as an example to demonstrate. The following page shows the selection interface.

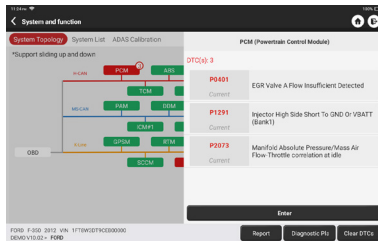

To check "System and Function", tap "Enter" to get a corn interface, which is the functional interface of each electronic control unit.

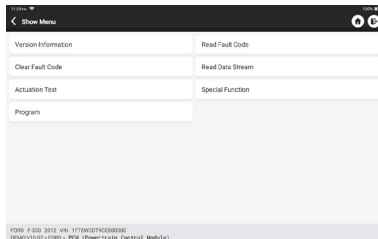

A. Version Information

As shown in the picture, "Version Information" to read the current version information of the car ECU.

B. Read Fault Code

This function is to read the DTC in the ECU memory, helping maintenance personnel to quickly identify

KINGBOLLEN

the cause of the vehicle breakdown. As shown below, “Read Fault Code”, and then the screen will display diagnostic results.

⚠️ Tips: Reading the DTC when troubleshooting a vehicle is only a small step in the entire diagnostic process.

Vehicle DTC are for reference only, and parts cannot be replaced directly based on the given DTC definition. Each DTC has a set of test procedures. The maintenance technician must strictly conform to the operation instructions and procedures described in the car maintenance manual to confirm the root cause of the breakdown.

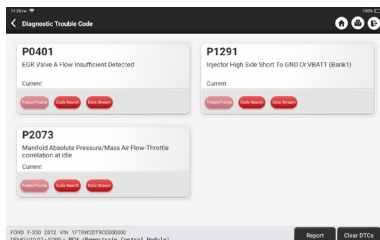

C. Clear Fault Code

On the diagnostic function selection screen, tap Clear Fault Code, the system will automatically delete the currently existing DTCs and display the dialog box of "DTCs Cleared".

⚠️ Note: For general models, please operate strictly according to the normal sequence: read DTC - clear DTC - test the car - retrieve DTC for verification - repair the car - clear DTC - recheck the car, to confirm that the DTC no longer appears.

D. Read Data Stream

This option lets you view and capture (record) real-time Live Data of ECU. This data, including current operating status for parameters and/or sensor information, can provide insight on overall vehicle performance. It can also be used to guide vehicle maintenance.

Select all and tap "ok" or just select the one you would like to check.

⚠️ Note: If you must drive the vehicle in order to perform a troubleshooting procedure, ALWAYS have a second person to help you. Trying to drive and operate the diagnostic device at the same time is dangerous, and could cause a serious traffic accident.

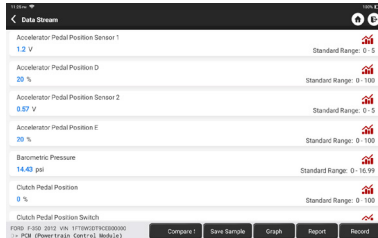

On-screen Buttons:

Display the parameters of the selected data stream in waveform. On the data stream waveform page, you can do the following:

[Combine]: Display in graph merge status for data comparison.

[Value]: Display the parameters in values and shown in list format.

[Customize]: Customize the data stream option to be viewed. Tap the button, a pull-down list of the data stream items appears on the screen. Select the desired items (max 12 items), and then screen will display the waveforms corresponding to these items immediately. If you need to remove any items, just deselect them.

[Graph]



Display the current (single) data stream in waveform graph. On the waveform graph page, you can do the following:

[Min/Max]: To define the maximum/minimum value. Once the value goes beyond the specified value, the system will alarm.

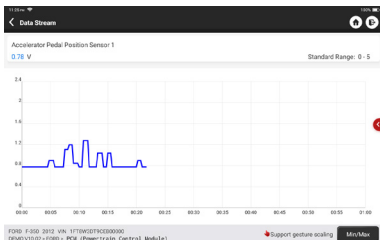

[]

[Customize]: Tap “” on the right side of the screen, to define the data stream option to be viewed.

 Note: Max 4 data streams can be displayed at the same time.

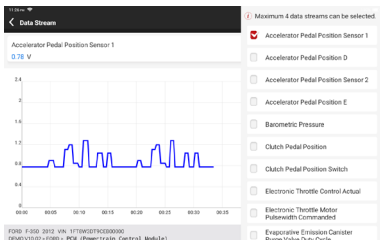

[Compare Sample]

To select the sample DS file. All the values you customized and saved in process of DS sampling will be imported into the Standard Range column for your comparison.

 Note: Before executing this function, you have to sample the values of data stream items and save it as a sample Data Stream file.

[Report]	To save the value of current data stream.
[Record]	<p>To record diagnostic data, for you to replay and review. Tap “Stop” button to end reading.</p> <p>The saved file follows the naming rule: It begins with vehicle type, and then the product S/N and ends with record starting time. All diagnostic records can be replayed from User Info -> My Report.</p>
[Save Sample]	<p>To sample data stream. After sampling, recording and saving the data stream, each time you review the data stream items, you will be able to call out the corresponding sample data to overwrite the current standard range.</p> <p>Tap it to start recording the sample data stream (Note: Only data stream items with measurement units will be recorded). Once the recording process is complete, tap to end recording, the system will automatically jump to the data revision screen.</p> <p>Tap the Min./Max. value to change it. After modifying all desired items, tap Save to save it as a sample DS file. All DS files are stored in User Info -> Data Stream Sample.</p>

E. Actuation Test

This function is used to test whether the execution components in the electronic control system can work normally.

F. Special Function

This function is used for data writing operation of electronic control unit. They all belong to this category, such as ECU data calibration, ECU Programming etc. Some Resetting functions are also included in this part.

3.3 Quick Check

It adopts smart detection mode. After the vehicle is connected, the system will automatically recognize the vehicle information, automatically check the vehicle, and automatically generates a report. Automatic printing can be set so that no human intervention is needed throughout the process.

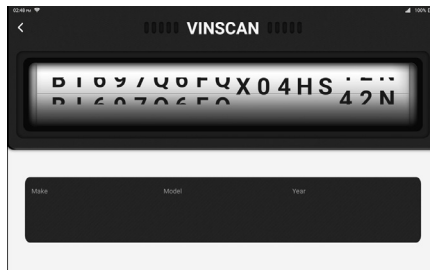

All System Diagnostic Report

BUSINESS INFORMATION

Shop Name: HWY77
 Plate Number: 75483
 Year: 2012
 Mile: 22169
 Title: N/A
 Customer Name: N/A
 Technician Name: N/A
 Email: roidid@gmail.com
 City: kgfkkgdgmso
 Country: Albania
 Registration No: 2012
 Mileage: kgfkkgdgmso
 Address: JAKKA JGJHJG
 Model: N/A

VEHICLE INFORMATION

Model: F330
 Vehicle Software Version: V18.02
 Year: 2012
 Registration No: N/A
 Mileage: 22169 km
 VIN: 1FT8W3D7YCEB00000

PROFESSIONAL REPORT

- PCM (Powertrain Control Module) !
- TCM(Transmission Control Module) ✓
- ABS(Anti-lock Braking System) ✓
- BCM (Restraint Control Module) ✓
- ECM(Body Control Module) ✓
- IMMO(Immobilizer) ✓
- APIM (Accessory Protocol Interface Module) ✓

Buttons: Done, Save

3.4 Maintenance

The device supports matching, coding, programming of most vehicles' programmable modules, and most commonly used maintenance and reset functions: Oil Reset; Elec. Throttle Adaption; IMMO Service; Injector Coding; Brake-pad Reset; Steering Angle Reset; ABS Bleeding; AFS Reset; Battery Matching; A/T Learning; DPF Regeneration; EGR Adaption; TPMS Reset; Sunroof Initialization; Suspension Matching; Gear Learning; Airbag Reset; ODO Meter Reset; AdBlue Reset; A/F Reset; Coolant Bleeding; Language Change; NOx Sensor Reset; Seat Calibration; Stop/Start Reset; Transport Mode; Tyre Reset; Windows Calibration; AC System Relearn/Initialization; Engine Power Balance Monitoring; Gas Particulate Filter Regeneration; High Voltage Battery Diagnostics; Intelligent Cruise Control System; Motor Angle Calibration; IMMO PROG (optional).

3.4.1 Oil Reset

The lightening of the car maintenance light indicates that the vehicle needs maintenance. Reset the mileage or driving time to zero after the maintenance, so the maintenance light will go out and the system will start a new maintenance cycle.

3.4.2 Elec. Throttle Adaption

Elec. Throttle Adaption is to utilize the car decoder to initialize the throttle actuator so that the learning

value of the ECU returns to the initial state. By doing these, the movement of the throttle (or idle motor) can be more accurately controlled, thus adjust the intake volume. Situations when throttle matching is needed:

- a. After replacing the electronic control unit, the relevant characteristics of the throttle operation have not been stored in the electronic control unit.
- b. After the electric control unit is powered off, the memory of the electric control unit's memory is lost.
- c. After replacing the throttle assembly, you need to match the throttle.
- d. After replacing or disassembling the intake port, the controlling of the idle speed by the coordination between the electronic control unit and the throttle body is affected.
- e. Although the characteristics of the idle throttle potentiometer have not changed, the intake volume has changed and the idle control characteristics have changed at the same throttle openings.

3.4.3 Steering Angle Reset

To reset the steering angle, first find the relative zero-point position for the car to drive in straight line. Taking this position as reference, the ECU can calculate the accurate angle for left and right steering. After replacing the steering angle position sensor, replacing steering mechanical parts (such as steering gearbox, steering column, end tie rod, steering knuckle), performing four-wheel alignment, or recovering car body, you must reset the steering angle.

3.4.4 Battery Matching

This function enables you to perform a resetting operation on the monitoring unit of vehicle battery, in which the original low battery fault information will be cleared and battery matching will be done.

Battery matching must be performed in the following cases:

- a. Main battery is replaced. Battery matching must be performed to clear original low battery information and prevent the related control module from detecting false information. If the related control module detects false information, it will invalidate some electric auxiliary functions, such as automatic start & stop function, sunroof without one-key trigger function, power window without automatic function.
- b. Battery monitoring sensor. Battery matching is performed to re-match the control module and motoring sensor to detect battery power usage more accurately, which can avoid an error message displaying on the instrument panel.

3.4.5 ABS Bleeding

When the ABS contains air, the ABS bleeding function must be performed to bleed the brake system to restore ABS brake sensitivity. If the ABS computer, ABS pump, brake master cylinder, brake cylinder, brake line, or brake fluid is replaced, the ABS bleeding function must be performed to bleed the ABS.

3.4.6 Brake-pad Reset

If the brake pad wears the brake pad sense line, the brake pad sense line sends a signal sense line to the on-board computer to replace the brake pad. After replacing the brake pad, you must reset the brake pad. Otherwise, the car alarms.

Reset must be performed in the following cases:

KINGBOLEN

- a. The brake pad is replaced or brake pad wear sensor.
- b. The brake pad indicator lamp is on.
- c. The brake pad sensor circuit is short, which is recovered.
- d. The servo motor is replaced.

3.4.7 DPF Regeneration

DPF regeneration is used to clear PM (Particulate Matter) from the DPF filter through continuous combustion oxidation mode (such as high temperature heating combustion, fuel additive or catalyst reduce PM ignition combustion) to stabilize the filter performance.

DPF regeneration may be performed in the following cases:

- a. The exhaust back pressure sensor is replaced.
- b. The PM trap is removed or replaced.
- c. The fuel additive nozzle is removed or replaced.
- d. The catalytic oxidizer is removed or replaced.
- e. The DPF regeneration MIL is on and maintenance is performed.
- f. The DPF regeneration control module is replaced.

3.4.8 Gear Learning

The crankshaft position sensor learns crankshaft gear machining tolerance and saves to the computer to more accurately diagnose engine misfires. If gear learning is not performed for a car equipped with Delphi engine, the MIL turns on after the engine is started. The diagnostic device detects the DTC P1336 'gear not learned'. In this case, you must use the diagnostic device to perform gear learning for the car. After gear learning is successful, the MIL turns off. After the engine ECU, crankshaft position sensor, or crankshaft flywheel is replaced, or the DTC 'gear not learned' is present, gear learning must be performed.

3.4.9 IMMO Service

To prevent the car being used by unauthorized keys, the anti-theft key matching function must be performed so that the immobilizer control system on the car identifies and authorizes remote control keys to normally use the car. When the ignition switch key, ignition switch, combined instrument panel, ECU, BCM, or remote-control battery is replaced, anti-theft key matching must be performed.

3.4.10 Injector Coding

Write injector actual code or rewrite code in the ECU to the injector code of the corresponding cylinder so as to more accurately control or correct cylinder injection quantity. After the ECU or injector is replaced, injector code of each cylinder must be confirmed or re-coded so that the cylinder can better identify injectors to accurately control fuel injection.

3.4.11 TPMS Reset

After the tire pressure MIL turns on and maintenance is performed, the tire pressure resetting function must be performed to reset tire pressure and turn off the tire pressure MIL. Tire pressure resetting must be performed after maintenance is performed in the following cases: tire pressure is too low, tire leaks, tire pressure monitoring device is replaced or installed, tire is replaced, tire pressure sensor is damaged, and

tire is replaced for the car with tire pressure monitoring function.

3.4.12 Suspension Matching

This function can adjust the height of the body. When replacing the body height sensor in the air suspension system, or control module or when the vehicle level is incorrect, you need to perform this function to adjust the body height sensor for level calibration.

3.4.13 AFS Reset

This feature is used to initialize the adaptive headlamp system. According to the ambient light intensity, the adaptive headlamp system may decide whether to automatically turn on the headlamps, and timely adjust the headlamp lighting angle while monitoring the vehicle speed and body posture.

3.4.14 A/T Learning

This function can complete the gearbox self-learning to improve gear shifting quality. When the gearbox is disassembled or repaired (after some of the car battery is powered off), it will lead to shift delay or impact problem. In this case, this function needs to be done so that the gearbox can automatically compensate according to the driving conditions so as to achieve more comfortable and better shift quality.

3.4.15 Sunroof Initialization

This function can set the sunroof lock off, closed when it rains, sliding / tilting sunroof memory function, temperature threshold outside the car etc.

3.4.16 EGR Adaption

This function is used to learn the EGR (Exhaust Gas Recirculation) valve after it is cleaned or replaced.

3.4.17 ODO Reset

- a. ODO reset is to copy, write, or rewrite the value of kilometers in the chip of odometer by using a car diagnostic computer and data cable, so that the odometer shows the actual mileage.
- b. Usually when the mileage is not correct due to the damaged vehicle speed sensor or odometer failure, it is necessary to do ODO reset after maintenance.

3.4.18 Airbag Reset

This function resets the airbag data to clear the airbag collision fault indicator. When the vehicle collides and the airbag deploys, the corresponding fault code of the collision data appears, the airbag indicator lights up, and the fault code cannot be cleared. Since the data inside the airbag computer is disposable, it is required that all new accessories must be replaced, but after performing this function, the data of the airbag computer can be recovered and the fault code can be cleared, the airbag light will go out, and the airbag computer can continue to use.

3.4.19 Transport Mode

In order to reduce power consumption, the following functions may be disabled, including limiting the vehicle speed, not waking up the door opening network, and disabling the remote-control key, etc. At this

KINGBOLEN

time, the transport mode needs to be deactivated to restore the vehicle to normal.

3.4.20 A/F Reset

This function is applied to set or learn Air/Fuel ratio parameters.

3.4.21 Stop/Start Reset

This function is used to open or close the automatic start-stop function via setting the hidden function in ECU (provided that the vehicle has a hidden function and supported by hardware).

3.4.22 NOx Sensor Reset

NOx sensor is a sensor used to detect the content of nitrogen oxides (NOx) in engine exhaust. If the NOx fault is re-initialized and the NOx catalytic converter is replaced, it is necessary to reset the catalytic converter learned value stored in the engine ECU.

3.4.23 AdBlue Reset (Diesel Engine Exhaust Gas Filter)

After the diesel exhaust treatment fluid (car urea) is replaced or filled up, urea reset operation is required.

3.4.24 Seat Calibration

This function is applied to match the seats with memory function that are replaced and repaired.

3.4.25 Coolant Bleeding

Use this function to activate the electronic water pump before venting the cooling system.

3.4.26 Tyre Reset

This function is used to set the size parameters of the modified or replaced tire.

3.4.27 Windows Calibration

This feature is designed to perform door window matching to recover ECU initial memory, and recover the automatic ascending and descending function of power window.

3.4.28 Language Change

This function is used to change the system language of the vehicle central control panel.

3.4.29 AC System Relearn/Initialization

If the ECU or actuator of the vehicle air conditioner is replaced, or the memory of the ECU memory is lost, air conditioner initialization learning is needed.

3.4.30 Intelligent Cruise Control System

For replacement of intelligent cruise control system of vehicle and matching after repairing.

3.4.31 Engine Power Balance Monitoring

At the power stroke of each cylinder, power balance monitors crankshaft acceleration, thus determining the relative power provided by each cylinder.

3.4.32 Gas Particulate Filter Regeneration

After long-term use of the particle catcher, fuel consumption can be increased, engine output power can be decreased, then in this case, the GPF needs to be replaced or regenerated.

3.4.33 Motor Angle Calibration

There is a deviation between the rotor position detected by the angle position sensor of the motor and the actual rotor magnetic field position, so it is necessary to calibrate the motor angle.

3.4.34 High Voltage Battery Diagnostics

For diagnosis and state information detection on high-voltage accumulator.

3.4.35 IMMO PROG (optional)

Anti-theft editor supports vehicle key chip read and write, EEPROM chip read and write, MCU chip read and write, engine ECU and transmission ECU EEPROM and FLASH read and write.

3.5 TPMS Diagnosis

The device can work with wireless tire pressure diagnostic tool (optional accessory) to achieve the features of TPMS activation, programming and learning.

A. Activation: to activate the sensor's ID, wheel pressure, sensor frequency, tire temperature and battery status.

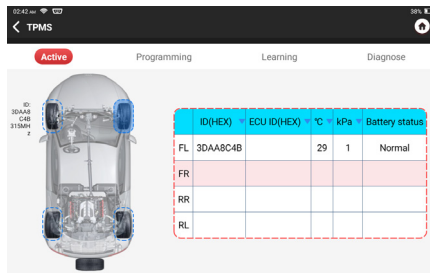

B. Programming: to program sensor data to a new KINGBOLEN sensor, so as to replace a sensor that is in low battery and does not function properly. There are three sensor programming methods available: Automatic, manual, and via activation replication.

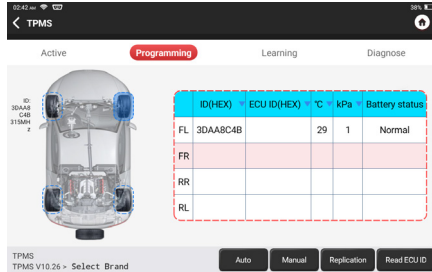

C. Learning: to write the sensor ID into the vehicle ECU for sensor identification.

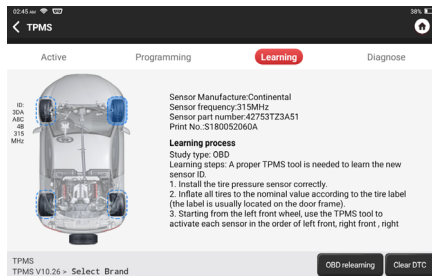

3.6 ADAS

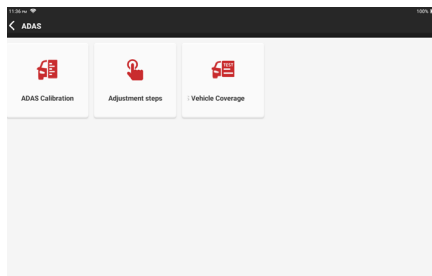

Advanced driver assistance systems (ADAS) is an electronic component in vehicles that include a variety of vehicle safety functions such as automatic emergency braking (AEB), lane departure warning (LDW), lane keeping assistance, blind spot elimination, night vision cameras, and self-adaptive lighting. For this function, it is necessary to use the ADAS calibration device produced and activate ADAS software.

Notes: ADAS function requires additional hardware (optional), which needs to be purchased.

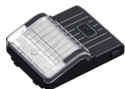
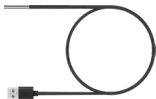
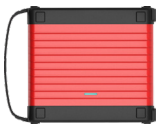

3.7 Module

The device supports optional function modules, list as below:

S/N	Name	Image	Description
1	Printer		Thermal printer, can be used with the device or module dock, quickly print diagnostic reports anytime and anywhere.
2	Video Scope		Ultra long custom coil pipeline design, flexible bending with durable materials, suitable for a variety of complex environments. Multiple uses with 3 kinds of special connectors (Hook, side view mirror, magnet). Supports 720P HD image. With 6 auxiliary lights for brighter light, it is easy to use in dark environment. Application scenario: 1. Engine combustion chamber inspection; 2. Engine internal carbon deposit inspection; 3. Three-way catalytic inspection; 4. Air-conditioning pipeline inspection; 5. Vehicle corners that are not easy to detect, such as falling screws, or water leakage, cracks, and foreign objects.
3	Scope Box		Equipped with 4 channels 100MHz bandwidth, sampling rate reaches up to 1GS/s. Combined with the device screen to achieve full touch control operation. Special automatic maintenance and detection menu and high-definition waveform display make it more convenient to use. Application scenarios: Scopebox can accurately determine the problems of sensors, actuators, control modules or circuits.
4	Wireless TPMS		Work with the device to complete tire pressure diagnosis related functions. Application scenario: 1. Read tire pressure information such as pressure, temperature, and battery status; 2. Replace the sensor for programming; 3. Change the position of the tire or other abnormalities that require sensor learning

3.8 Remote Assistance

In this function, you can request remote assistance through third-party software. By sending your device

KINGBOLLEN

ID number to the remote technician or after-sales personnel, you can authorize the other party to remotely operate the device, so as to guide you to the problems encountered in the process of using the device.

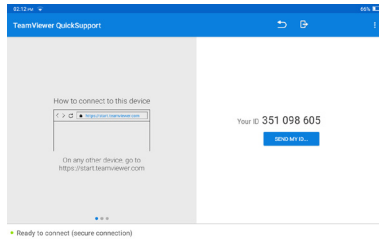

3.9 Store

In the store, vehicle diagnostic and maintenance software can be bought. Each diagnostic software has a detailed function introduction. All hardware products can also be purchased online.

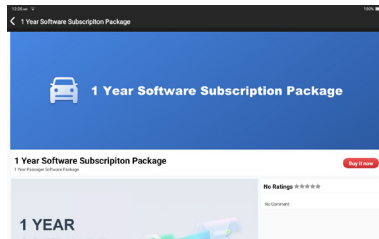

3.10 File

It is used to record and establish the file of the diagnosed vehicles. The file is created based on the vehicle VIN and check time, including all VIN-related data such as diagnostic reports, data stream records and pictures.

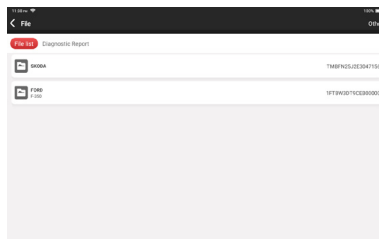

3.11 Repair Info

Tap "Repair Info" on the homepage, the following page will appear.

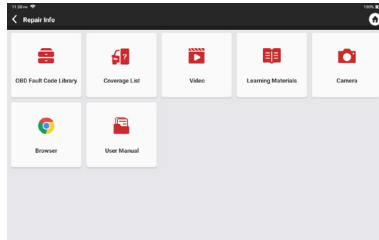

3.11.1 OBD Fault Code Library

You can enquire the definition of OBD fault codes.

3.11.2 Coverage List

You can enter the Vehicle brand, model, year and other information to enquire the support functions and diagnostic system.

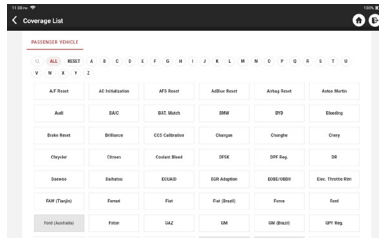

3.11.3 Learning materials

You can view the operation playback of the special functions of each brand model, to help users study the operation of the special functions online without connecting the vehicle.

3.11.4 User Manual

You can find the E-Manual in here.

3.12 Update

In order to let you enjoy better functions and upgrade services, we recommend you make software upgrades irregular. When there is a newer software version, the system will remind you to upgrade.

Tap "Software Upgrade" to enter the upgrade center. There are two function tabs on the upgrade page:

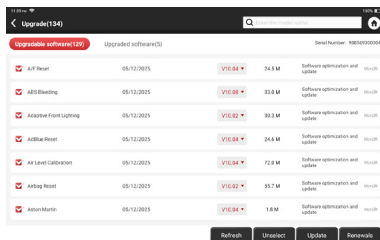

Upgradeable software: A list of software that can be upgraded to newer versions.

Upgraded software: A list of software that has been downloaded.

⚠️ **Note:** During the upgrade, please keep normal network connection. Upgrade many software may take a few minutes, please wait.

If you need to cancel certain software, please enter setting -> diagnostic software clear -> remove software to operate.

Renewals: Please contact your local dealer to purchase a K-code card when your vehicle model package expires.

Tap "Renewals" and enter the K-code and tap OK.

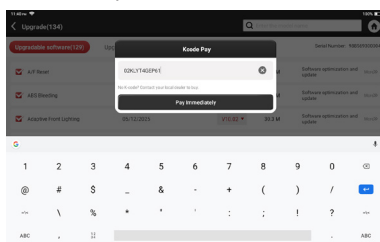

3.13 Feedback

If you encounter an unresolved problem or diagnostic software bug during diagnosis, you can revert the most recent 20 test records to KINGBOLEN Team. When we receive your feedback, we will analyze and troubleshoot it in a timely manner, to improve the quality of our products and user experience. Tap **Feedback**, the below pop-up message will appear:

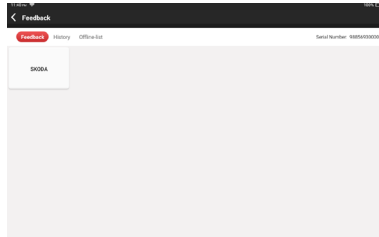

Tap **OK** to enter the vehicle diagnostic feedback selection screen. There are three options:

Feedback: Tap to show the list of all tested vehicle models.

Tap on the target diagnostic record, filling out some information and tap "Submit Result". After submission, our engineers will be able to analyze the data from the diagnostic report.

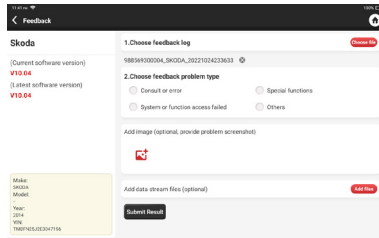

History: Tap to view all diagnostic feedback reverted and the processing progress.

Offline List: Tap to display all diagnostic feedback logs which have not been submitted successfully due to network failure. Once the tablet gets a stable network signal, it will be uploaded to the server automatically. On the Diagnostic Feedback page, tap the diagnostic record of certain vehicle model or special function to next step.

Tap Choose File to open the target folder and choose the desired diagnostic logs. Choose the failure type and fill with the detailed failure description in the text box, and leave your telephone or email address. After inputting, tap Upload Logs to revert feedback to us.

We will follow up your feedback as soon as we receive your diagnostic feedback, please keep an eye on the progress and results of your diagnostic feedback in Diagnostic Feedback History.

4. User Info

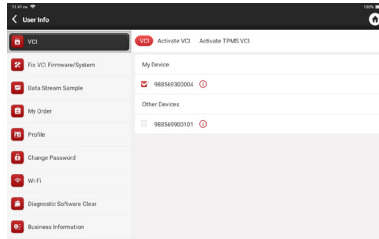

4.1 VCI

If several VCI connectors are registered on the device, this option allows you to choose one from those.

4.2 Activate VCI

This step allows you activate a new VCI connectors or get help. Input the Serial Number and Activation Code, and then tap "Activate" to activate it.

Serial Number

Activation Code

Activate

Once the VCI connector is activated, the serial number of it will be displayed in the list which located in the VCI.

4.3 Activate TPMS VCI

This step is for binding the Tire Pressure Monitoring System.

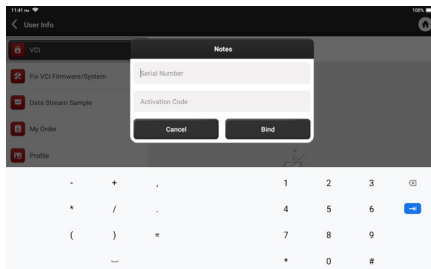

4.4 Fix VCI firmware/system

Use to repair the VCI firmware. During the repair, please don't power off or switch interfaces.

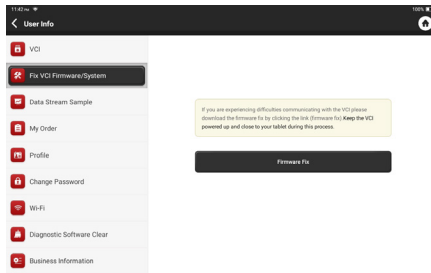

4.5 Data Stream Sample

This feature allows you to manage the recorded data stream sample files.

4.6 My Order

Use to manage order details.

4.7 Profile

Use to set and manage personal information.

4.8 Change Password

This item allows you to modify your login password.

4.9 Wi-Fi

Set up Wi-Fi networks that can be connected.

4.10 Diagnostic Software Clear

This option can clear some unused diagnostic software and free up the storage space.

4.11 Business Information

Add the information of the workshop, to which the scanner belongs, and it will be displayed to the customers in the diagnostic report.

4.12 Customer Management

Manage information of all customers, who conduct vehicle diagnostic on this equipment and display in turn.

KINGBOLEN

4.13 Diagnostic Record

You can check the diagnostic history in here.

4.14 Photo Album

This module saves the screenshots.

4.15 Screen Recorder

This module saves the screen recordings.

4.16 Clear VCI Data

Clearing VCI data will delete all download software, diagnostic records, and user setting, etc., which are associated with the VCI.

4.17 Settings

In here, we would be able to check the version, system, storage and other fundamental settings of the device.

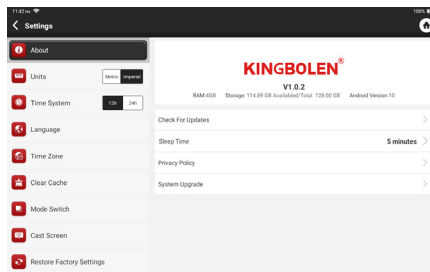

4.17.1 Check for Updates

It is for checking the version of the device and update it if it is necessary.

4.17.2 Sleep Time

This is used to set up the sleep time. If the device is not operated within the sleep time limit, the device will automatically turn off the screen.

4.17.3 Privacy Policy

You can find the seller's service information in here.

4.17.4 System Upgrade

To check the latest Android system version and upgrade it if it is necessary.

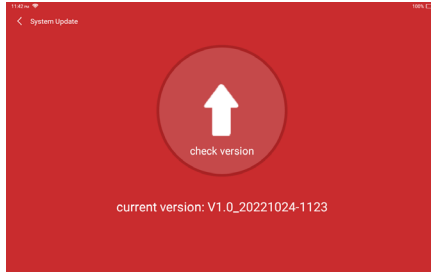

4.17.5 Units

It controls the data unit in the device. Choose the one that you are accustomed to reading.

4.17.6 Clear Cache

To clear all the storage software, account, information, setting, and all the records of the device to save the space. PLEASE USE IT WITH CAUTION.

4.17.7 Mode Switch

When connecting with other modules, HOST MODE must be used.



4.17.8 Restore Factory Settings

Factory Reset, delete all data and restore the original settings. PLEASE USE IT WITH CAUTION.

4.18 Hotkey Setting

Including: Wi-Fi, Bluetooth, screen recording, screenshot, screen flip, brightness and sound.

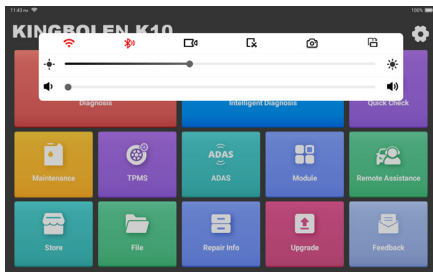

5.FAQ

Q: Can I use the same type of charger to charge the tablet?

A: No, please use original charger. Our company is not responsible for any damage and economic loss caused by using charger, which is not provided by KINGBOLEN.

Q: How to save power?

A: Please turn off the screen while the device isn't used, set a shorter standby time, and decrease the brightness of the screen.

Q: Why the tablet cannot be turned on after charging?

Possible reasons	Solutions
Battery loss caused by the device not using for a long time.	Charge it for more than 2 hours before turning it on.
Problem of Charger.	If there is a quality problem, please contact the dealer or after-sales service of KINGBOLEN.

Q: Why can't make register?

Possible reasons	Solutions
The device is not connected to the network.	Please make sure the network is connected.
Notes that your email has been registered.	Register with another e-mail account or log in with the username registered by e-mail (If you forget the username, you can retrieve it by e-mail).
The email didn't receive the verification code during the registration.	Check if the e-mail is correct and get the verification code again.

Q: Why can't I log in?

Possible reasons	Solutions
The device is not connected to the network.	Please make sure the network is connected.
The username or password is incorrect.	Check the username and password. Contact KINGBOLEN after-sales service or regional sales to retrieve the user name and password.
Server problem.	Server maintenance, please try again later.

Q: Why can't I activate the device?

Possible reasons	Solutions
The device is not connected to the network.	Please make sure the network is connected.
The serial number and activation code are inputted wrong.	Check the serial number and activation code and make sure they are correct (Serial number 12 digits, activation code 8 digits).
The activation code is invalid.	Contact KINGBOLEN after-sales service or regional sales.
Notes that the configuration is empty.	Contact KINGBOLEN after-sales service or regional sales.

Q: Why was the device not activated during the software update?

Possible reasons	Solution
The VCI connector may not be activated during registration.	Use the serial number and activation code to activate the connector. Steps are as follows: Click [Settings] -> [Activate VCI] Enter the correct serial number and activation code in the interface, and click [Activate].

KINGBOLEN

Q: Why the software upgrade failed?

Possible reasons	Solutions
The device is not connected to the network.	Check the network connection.
The username or password is wrong The device has not enough memory.	Check the username and password. Uninstall irrelevant applications and delete uncommonly used vehicle software (enter setting -> diagnostic software clear -> remove software to operate).
Server problem.	Server maintenance, please try again later.

Q: Why is there no power in the VCI dongle after connecting to the vehicle's DLC port?

Possible reasons	Solutions
Poor contact of vehicle's DLC port.	Plug out the VCI dongle, and then plug it in again.
Too low voltage of the vehicle battery.	<ul style="list-style-type: none">• Recharge the vehicle battery.• Replace the vehicle battery if it is damaged.
Damage of the VCI dongle.	Contact KINGBOLEN after-sales service to get support.

Q: Why can't tablets establish a connection with the VCI dongle?

Possible reasons	Solutions
Poor contact of the VCI dongle.	<ul style="list-style-type: none">• Plug out the VCI dongle, and then plug it in again.• Perform the VCI Bluetooth pairing again.
The firmware is damaged.	Enter the settings and tap "Fix Connector Firmware/System" to fix the firmware.

Q: Why is the communication error with the vehicle ECU displayed?

A: Please confirm:

Whether the VCI is correctly connected and whether the vehicle ignition switch is ON.

If all are normal, send vehicle production year, model and VIN number by Feedback feature.

Q: Why can't I access the vehicle ECU system?

A: Please confirm:

Whether the vehicle is equipped with the system, whether the VCI is correctly connected, and whether the vehicle ignition switch is ON.

Q: What if the connector is lost?

A: Contact KINGBOLEN after-sales service or regional sales.

Q: What if the downloaded diagnostic software is inconsistent with the serial number?

A: There are several connectors registered under the equipment account, and the serial number of right connector has not been selected. Enter the settings-[VCI] and select the right serial number of connector. Delete the problematic software, then enter the upgrade center to download the diagnostic software again.

Warranty Terms

- This warranty applies only to users and distributors who purchase KINGBOLEN products through normal procedures.
- Within one year from the date of delivery, KINGBOLEN warrants its electronic products for damages caused by defects in materials or workmanship.
- Damages to the equipment or components because of abuse, unauthorized modification, use for non-designed purposes, operation in a manner not specified in the instructions, etc. are not covered by this warranty.
- The compensation for dashboard damage caused by the defect of this equipment is limited to repair or replacement. KINGBOLEN does not bear any indirect and incidental losses.
- KINGBOLEN will judge the nature of the equipment damage according to its prescribed inspection methods. No agents, employees or business representatives of KINGBOLEN are authorized to make any confirmation, notice or promise related to KINGBOLEN products.

SHENZHEN KINGBOLEN ELECTRONIC TECHNOLOGY.,LTD

Service Line: (+86)0755-23445106

Customer Service Email: service@kingbolen.com

Official Website: www.kingbolen.com

Youtube: Kingbolen auto scanner center

Facebook: [@kingbolen.fans](https://www.facebook.com/kingbolen.fans)

Instagram: [@kingbolen.fans](https://www.instagram.com/kingbolen.fans)

Products tutorial, videos, Q&A and coverage list are available on KINGBOLEN official website.