



IoT Wireless Vibration / Pressure sensor module

LoRa, BLE ANTENNA

Part Numbers: 2195912-1 (20022844-00)

FEATURES & BENEFITS

LDS(Laser Direct Structuring) Antenna

- Ability to selectively and repeatably plate 3 dimensionally
- Implementation of two antennas (LoRa & BLE) on one substrate
- Ability to produce thin traces
- Flexibility of pattern design without changing tool

SPECIFICATIONS

	Vibration Sensor		
Frequency Range (MHz)	863 to 870 MHz	902 to 928 MHz	2400 to 2480 MHz
Average Gain	40.3 %	39.4 %	22.1 %
Average Gain	-3.95dBi	-4.06dBi	-6.57dBi
Peak Gain[dBi]	-1.47dBi	-1.22dBi	-1.61dBi
Target Frequency	868 MHz	915 MHz	2450 MHz
Target Frequency Gain	-3.74dBi	-4.22dBi	-6.72dBi
Feed Point Impedance	50 ohms unbalanced		
Polarization	Linear		
Size	Dia. 29.54 mm x 21.50 mm Height		
Weight	< 20.5 g		
Operating Temperature	-40 to +85°C		
Storage Temperature	-40 to +85°C		
Packaging Specification	Box		
Hazardous Materials	A certificate of conformance is available from the product page on TE website.		
Data measured Free Space condition			

SPECIFICATIONS

	Pressure Sensor		
Frequency Range (MHz)	863 to 870 MHz	902 to 928 MHz	2400 to 2480 MHz
Average Gain	60.5 %	59.4 %	27.9 %
Average Gain	-2.19dBi	-2.27dBi	-5.56dBi
Peak Gain[dB]	+0.39dBi	+0.68dBi	+0.00dBi
Target Frequency	868 MHz	915 MHz	2450 MHz
Target Frequency Gain	-1.99dBi	-2.46dBi	-5.72dBi
Feed Point Impedance	50 ohms unbalanced		
Polarization	Linear		
Size	Dia. 29.54 mm x 21.50 mm Height		
Weight	< 20.5 g		
Operating Temperature	-40 to +85°C		
Storage Temperature	-40 to +85°C		
Packaging Specification	Box		
Hazardous Materials	A certificate of conformance is available from the product page on TE website.		
Data measured Free Space condition			

Revision updated :

- Rev 1_Oct. 29th. 2021 : Old PCB version of the vibration sensor
- Rev 2_Mar. 22nd .2023 : Modified PCB and Antenna design for the vibration & the pressure sensor

RF DATA – Vibration Sensor condition

3D Chamber : Efficiency Measurement

	1	2	3	4	5	6	7	8
Frequency [MHz]	863	864	865	866	867	868	869	870
Efficiency [dB]	-4.35	-4.29	-4.22	-3.82	-3.77	-3.74	-3.73	-3.72
Efficiency [%]	36.7	37.3	37.9	41.5	42.0	42.3	42.3	42.5
Peak Gain [dB]	-2.12	-2.05	-1.97	-1.58	-1.52	-1.50	-1.49	-1.47

	1	2	3	4	5	6	7	8	9
Frequency [MHz]	902	905	909	912	915	918	922	925	928
Efficiency [dB]	-3.52	-3.52	-3.79	-4.20	-4.22	-4.27	-4.28	-4.36	-4.41
Efficiency [%]	44.5	44.5	41.8	38.0	37.9	37.4	37.3	36.7	36.3
Peak Gain [dB]	-1.22	-1.24	-1.55	-1.97	-2.03	-2.12	-2.13	-2.21	-2.25

	1	2	3	4	5	6	7	8	9
Frequency [MHz]	2400	2410	2420	2430	2440	2450	2460	2470	2480
Efficiency [dB]	-5.96	-6.24	-6.28	-6.44	-6.67	-6.72	-6.80	-7.03	-7.00
Efficiency [%]	25.4	23.8	23.6	22.7	21.5	21.3	20.9	19.8	19.9
Peak Gain [dB]	-1.61	-1.83	-1.80	-1.92	-2.13	-2.14	-2.16	-2.33	-2.29

RF DATA – Pressure Sensor condition

3D Chamber : Efficiency Measurement

	1	2	3	4	5	6	7	8
Frequency [MHz]	863	864	865	866	867	868	869	870
Efficiency [dB]	-2.56	-2.52	-2.45	-2.08	-2.02	-1.99	-1.97	-1.94
Efficiency [%]	55.4	55.9	56.8	62.0	62.8	63.3	63.6	63.9
Peak Gain [dB]	-0.26	-0.21	-0.14	0.24	0.30	0.33	0.35	0.39

	1	2	3	4	5	6	7	8	9
Frequency [MHz]	902	905	909	912	915	918	922	925	928
Efficiency [dB]	-1.87	-1.86	-2.08	-2.47	-2.46	-2.46	-2.39	-2.40	-2.40
Efficiency [%]	65.0	65.2	61.9	56.6	56.8	56.7	57.6	57.6	57.5
Peak Gain [dB]	0.68	0.68	0.46	0.07	0.08	0.07	0.14	0.13	0.12

	1	2	3	4	5	6	7	8	9
Frequency [MHz]	2400	2410	2420	2430	2440	2450	2460	2470	2480
Efficiency [dB]	-5.07	-5.30	-5.29	-5.41	-5.67	-5.72	-5.73	-5.96	-5.88
Efficiency [%]	31.1	29.5	29.6	28.8	27.1	26.8	26.7	25.3	25.9
Peak Gain [dB]	0.00	-0.19	-0.16	-0.26	-0.48	-0.51	-0.49	-0.77	-0.68

RF DATA – Vibration Sensor condition

VSWR

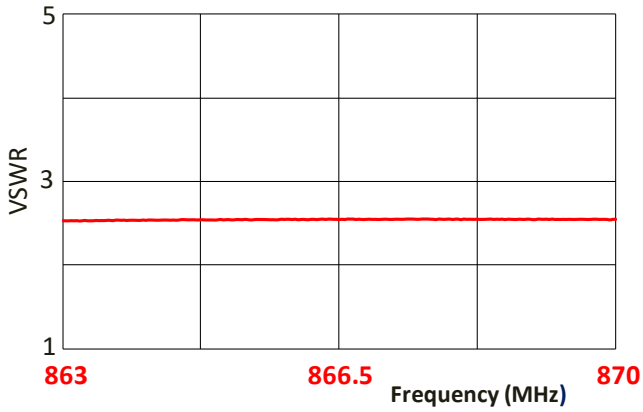

Return Loss

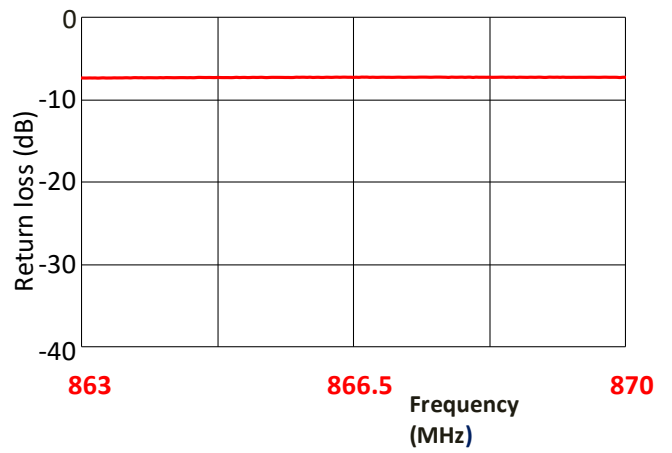

Peak Gain

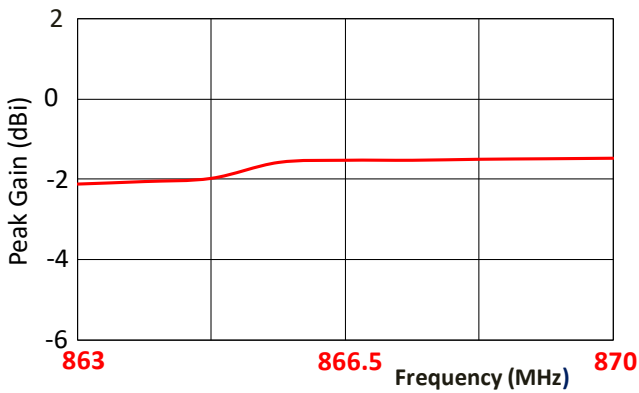

Efficiency

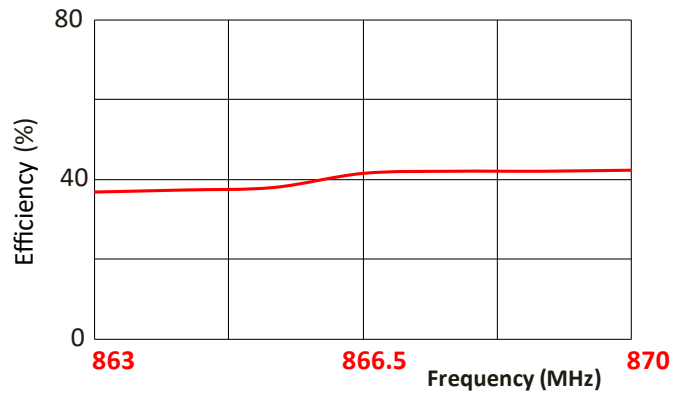

RF DATA – Pressure Sensor condition

VSWR

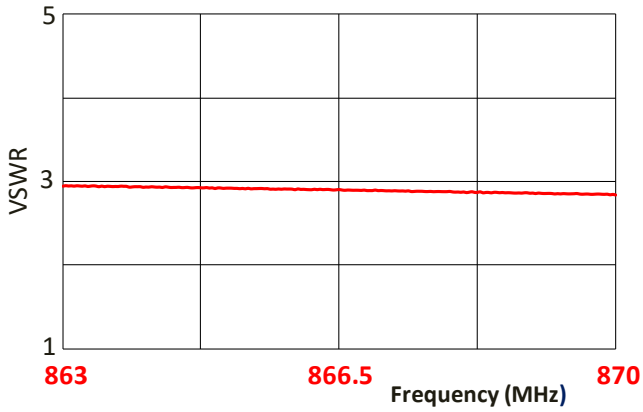

Return Loss

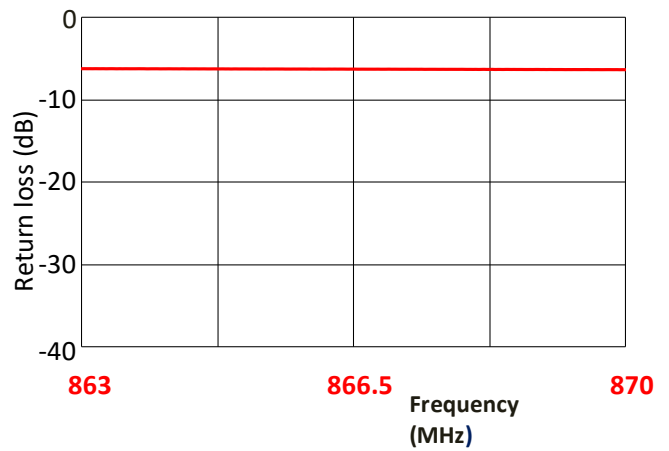

Peak Gain

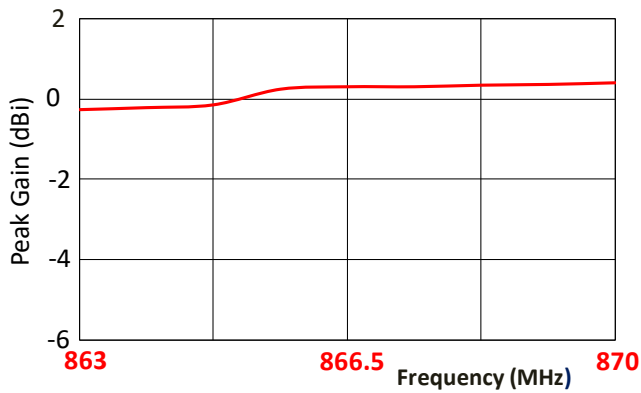

Efficiency

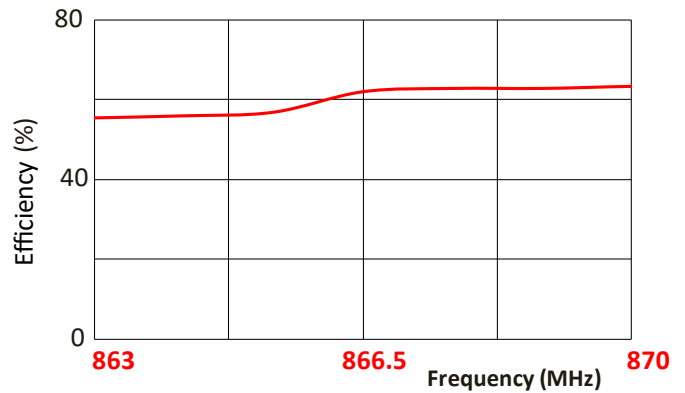

RF DATA – Vibration Sensor condition

VSWR

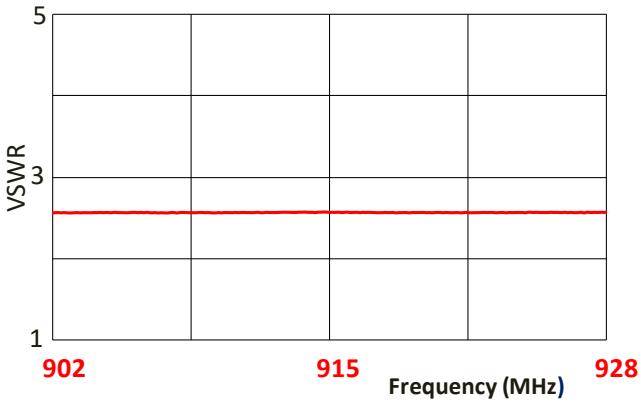

Return Loss

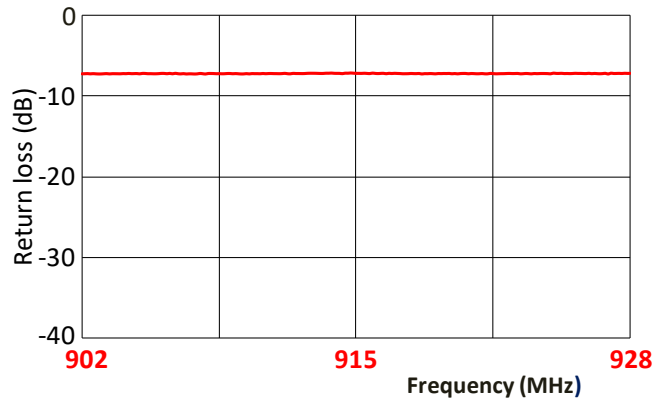

Peak Gain

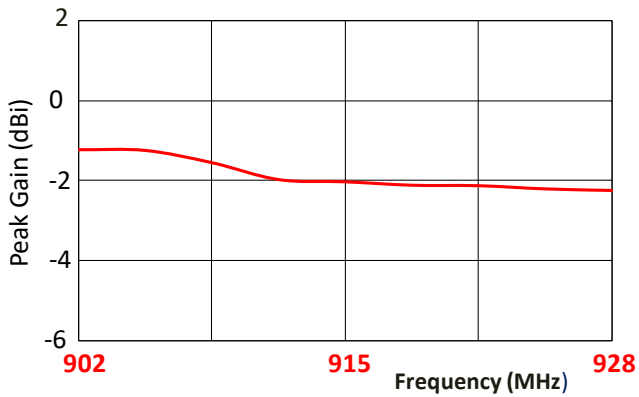

Efficiency

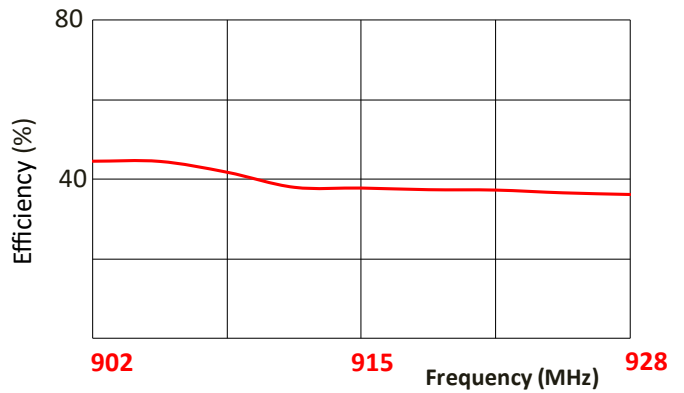

RF DATA – Pressure Sensor condition

VSWR

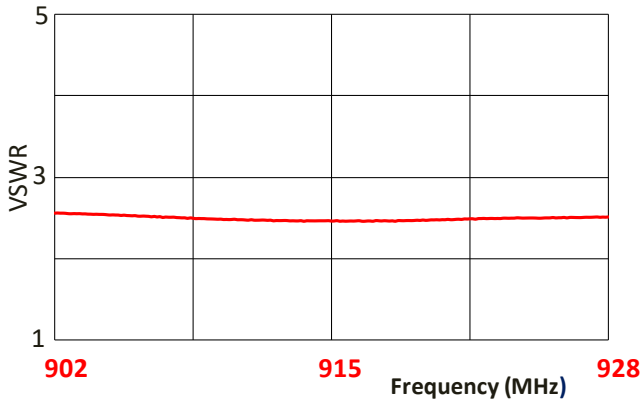

Return Loss

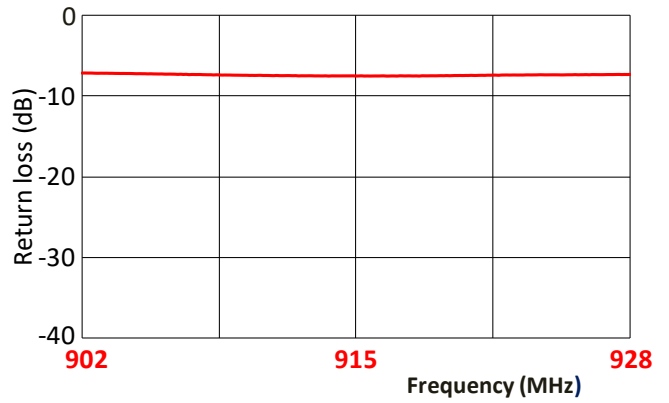

Peak Gain

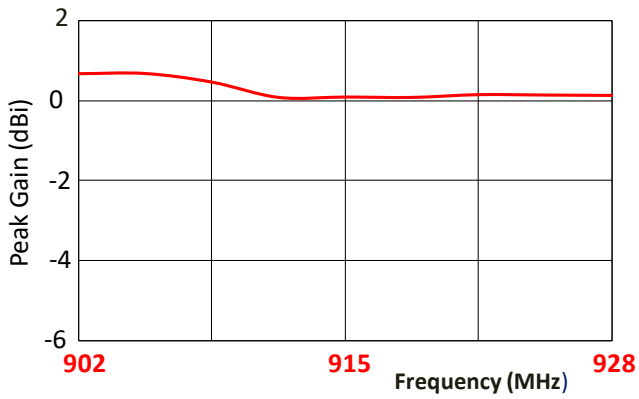

Efficiency

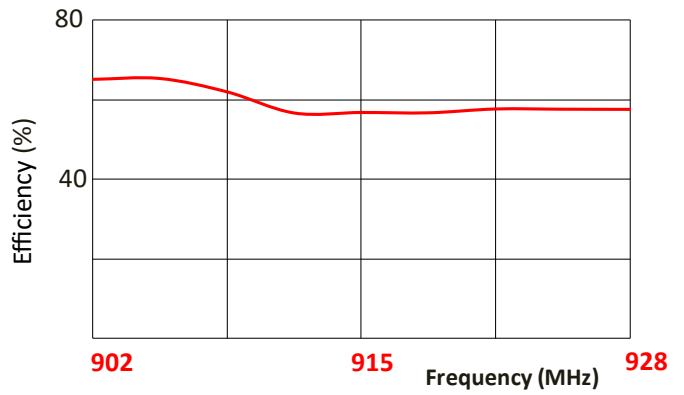

RF DATA – Vibration Sensor condition

VSWR

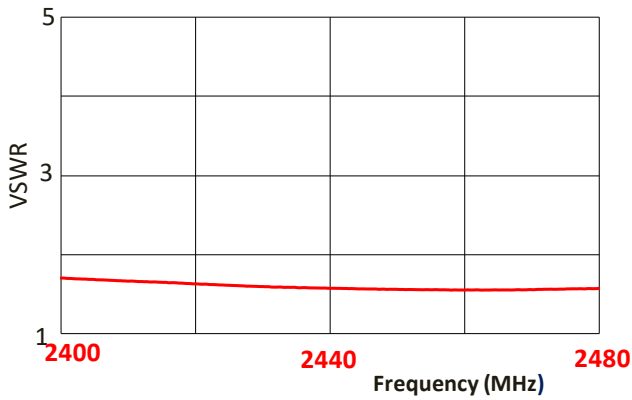

Return Loss

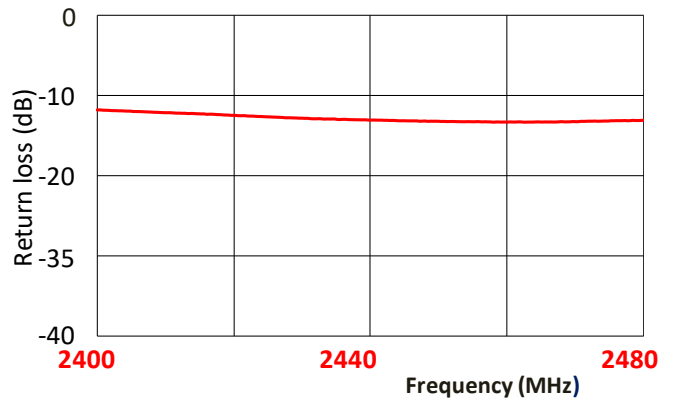

Peak Gain

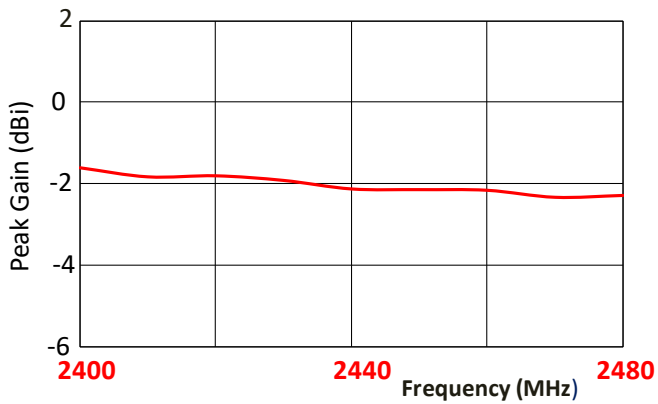

Efficiency

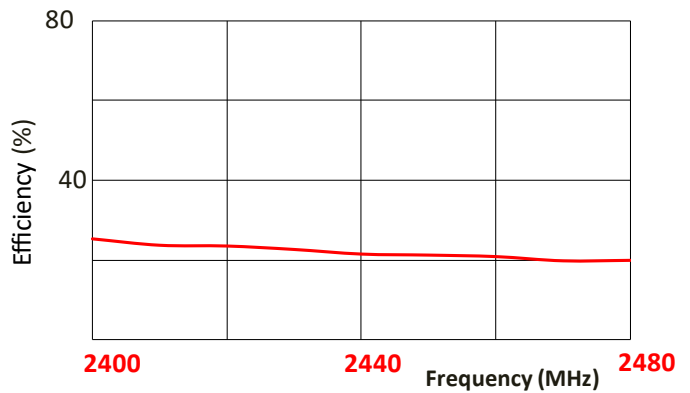

RF DATA – Pressure Sensor condition

VSWR

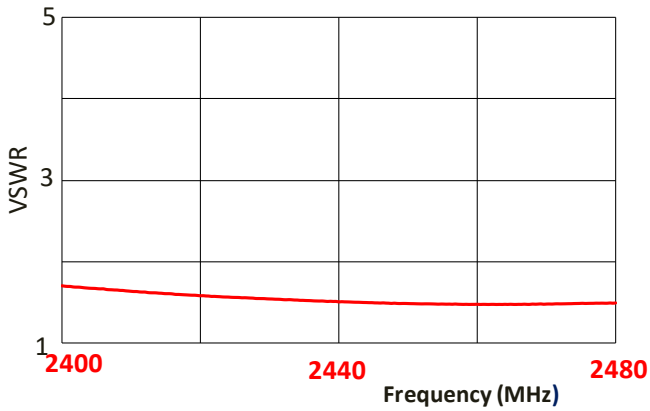

Return Loss

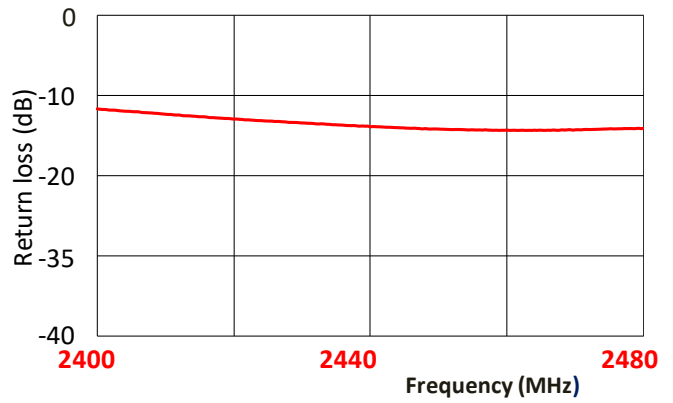

Peak Gain

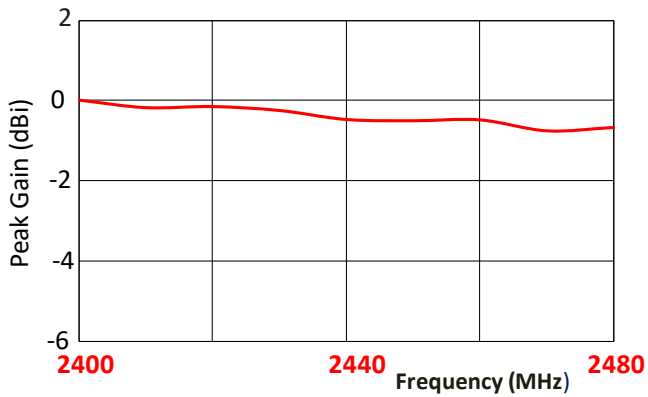

Efficiency

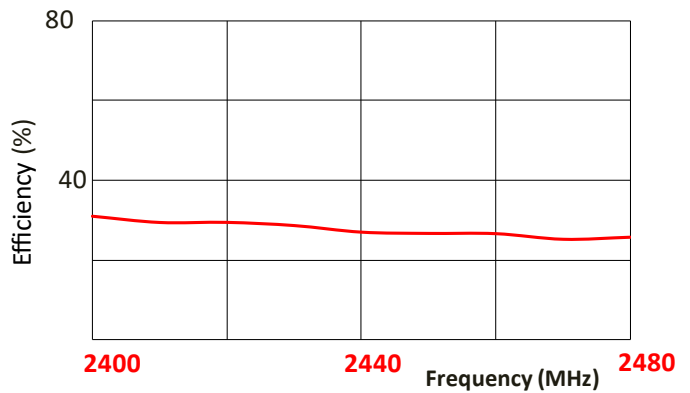

RADIATION PATTERN – Vibration Sensor condition

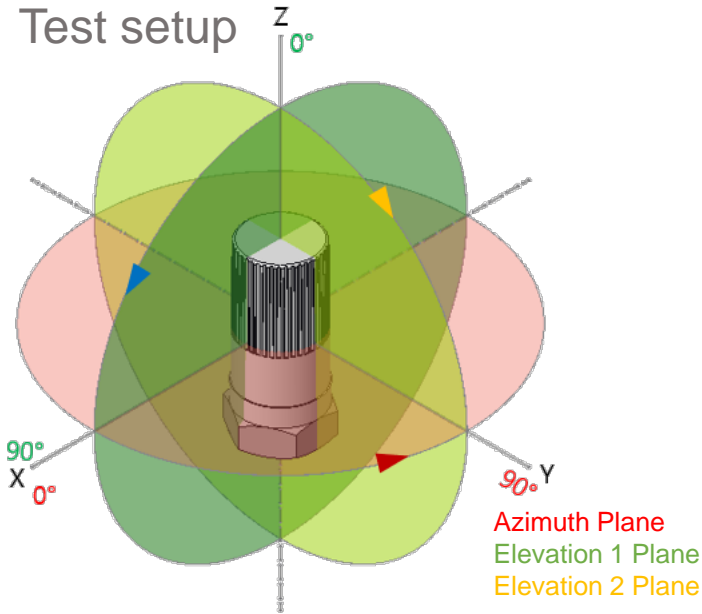

Azimuth

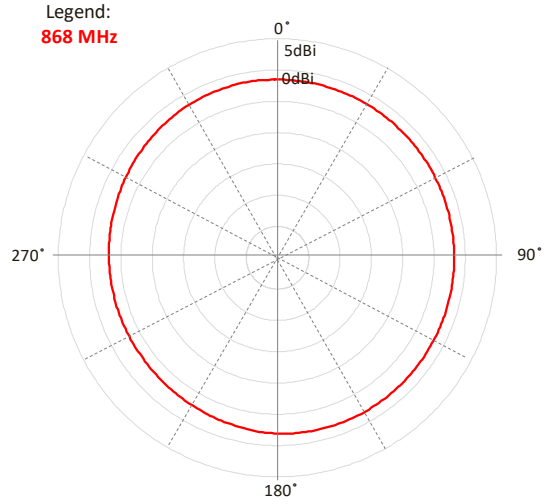

Elevation 1

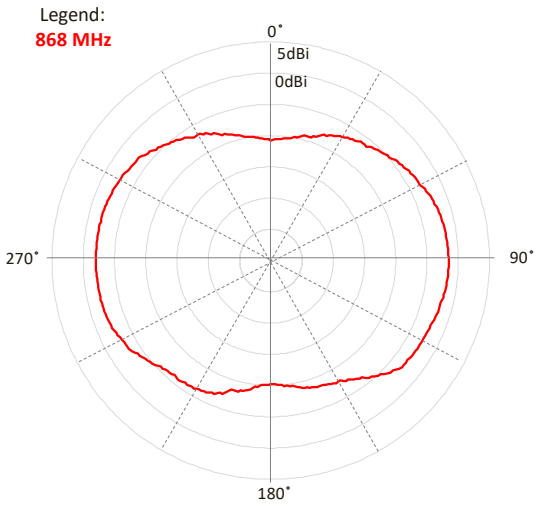

Elevation 2

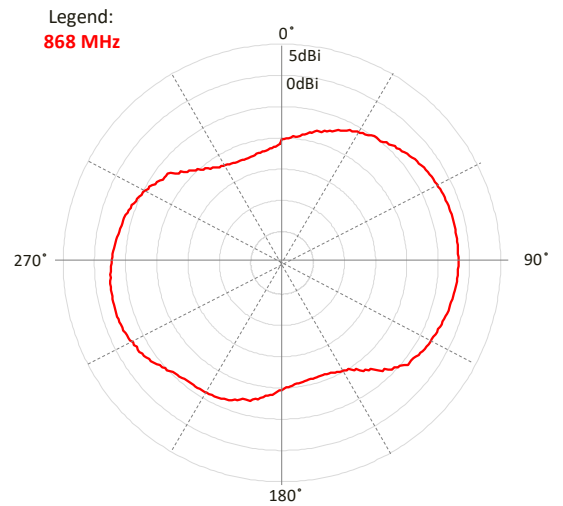

RADIATION PATTERN – Vibration Sensor condition

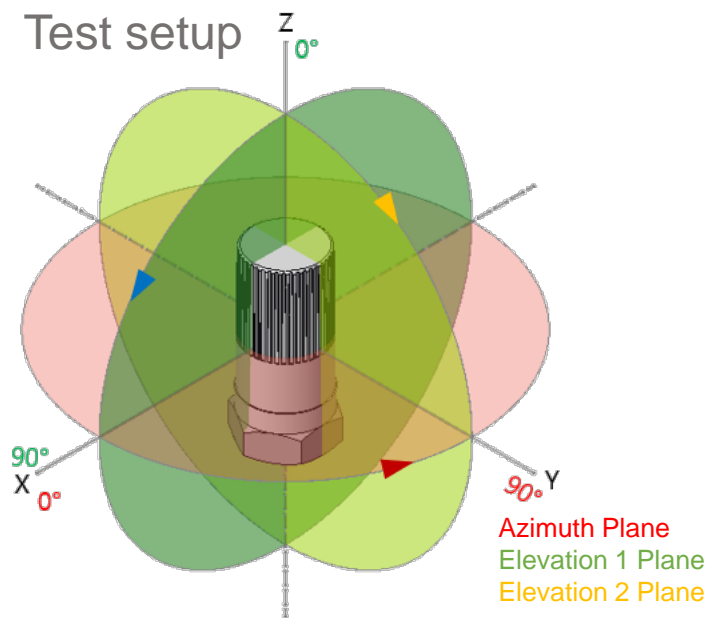

Azimuth

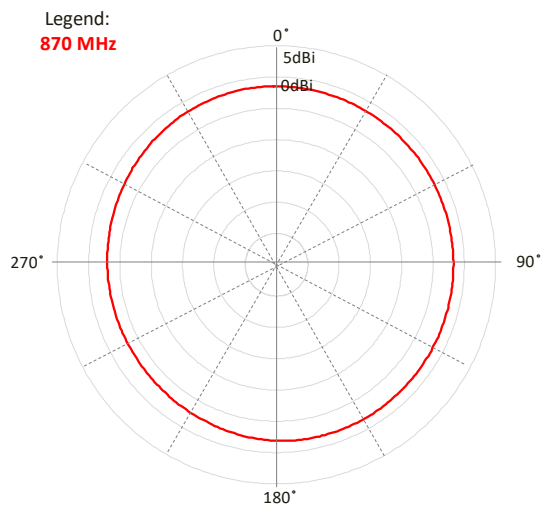

Elevation 1

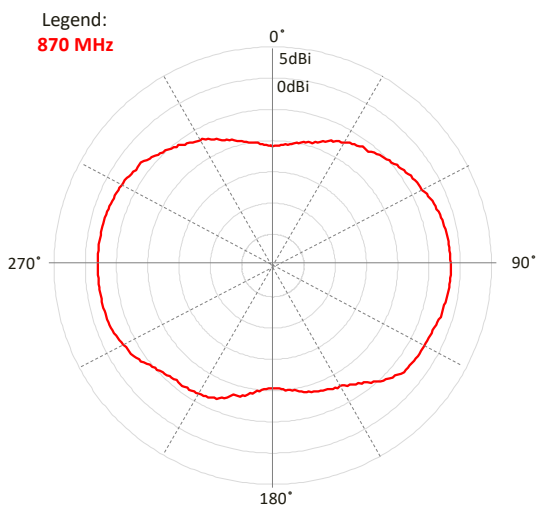

Elevation 2

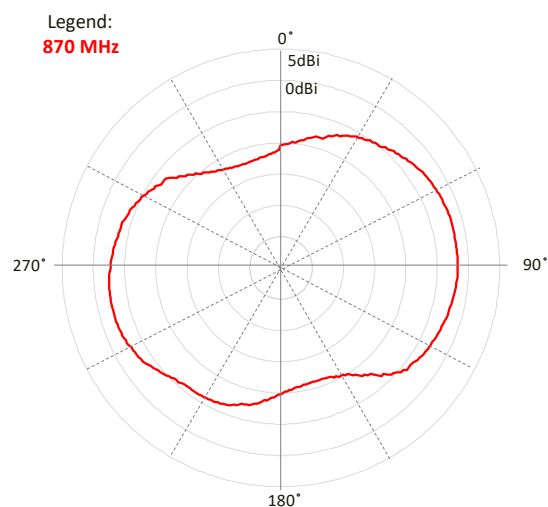

RADIATION PATTERN – Vibration Sensor condition

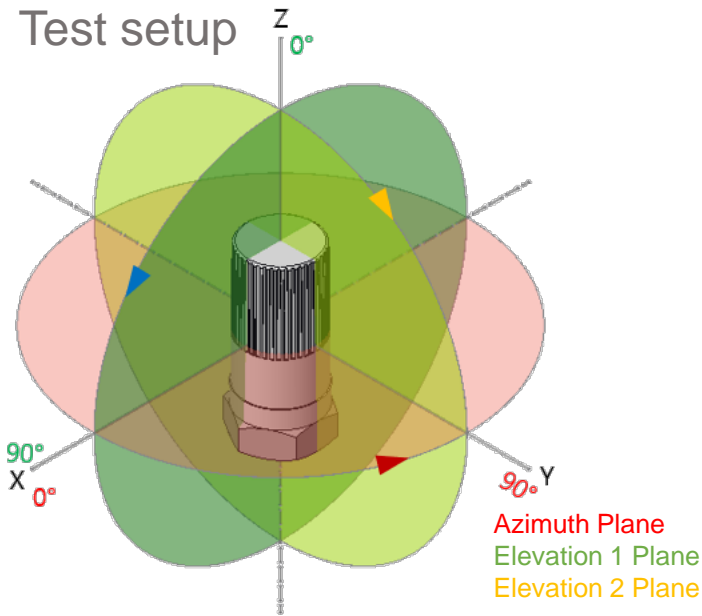

Azimuth

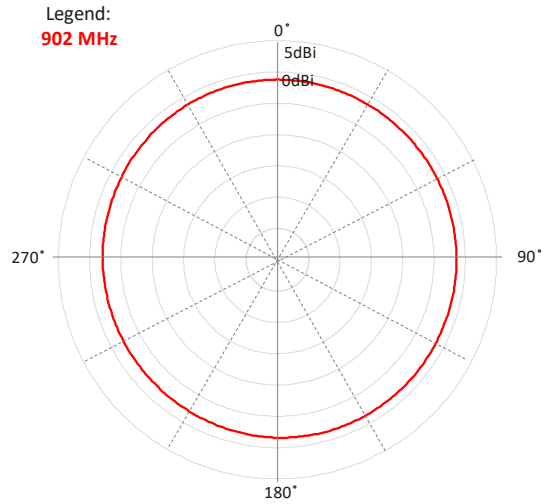

Elevation 1

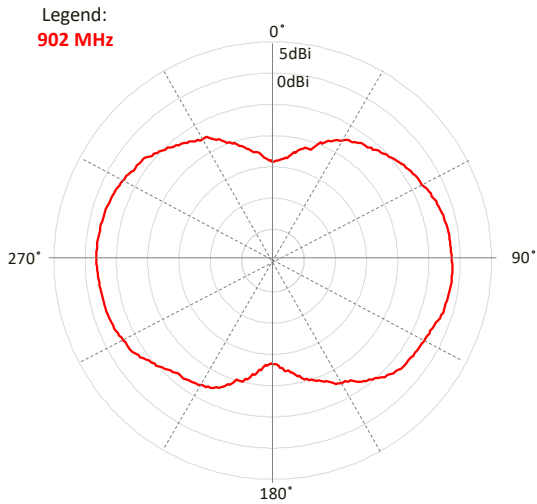

Elevation 2

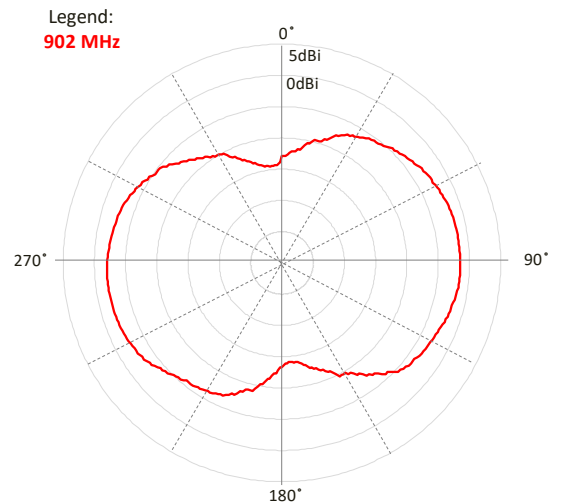

RADIATION PATTERN – Vibration Sensor condition

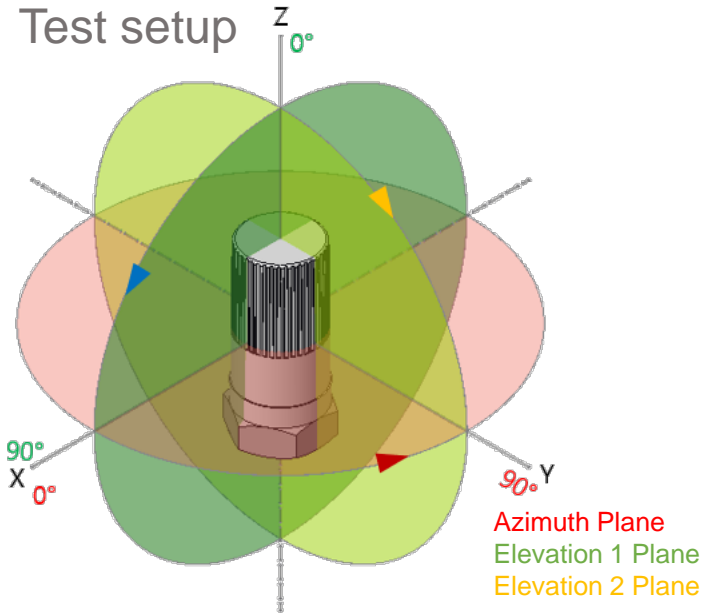

Azimuth

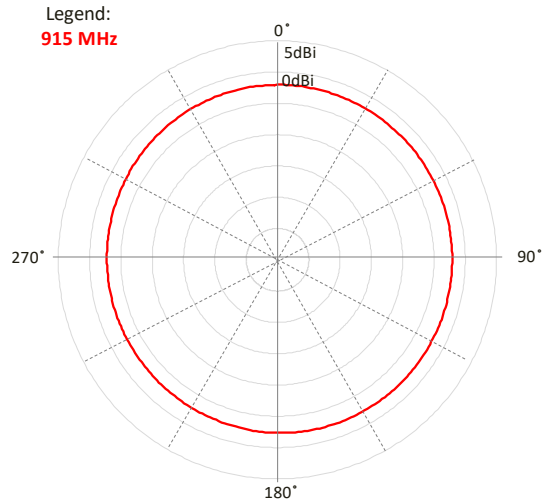

Elevation 1

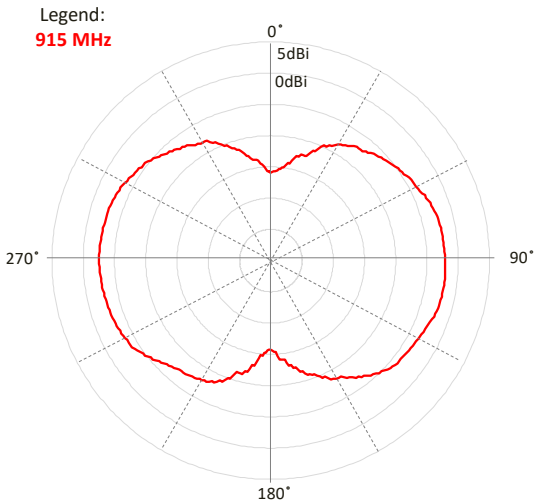

Elevation 2

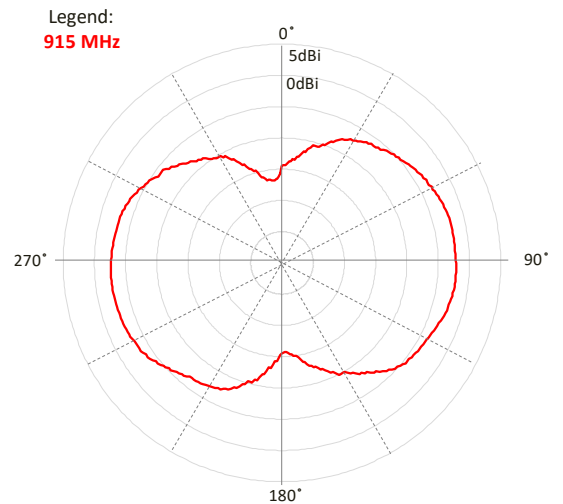

RADIATION PATTERN – Vibration Sensor condition

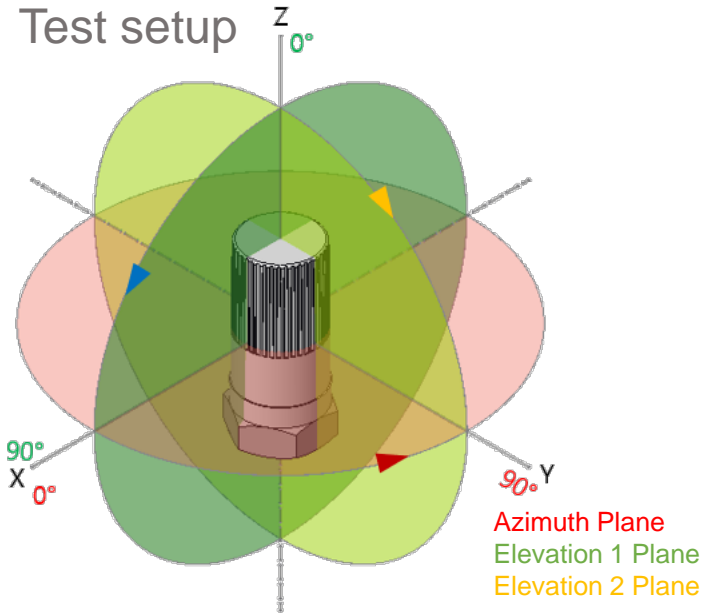

Azimuth

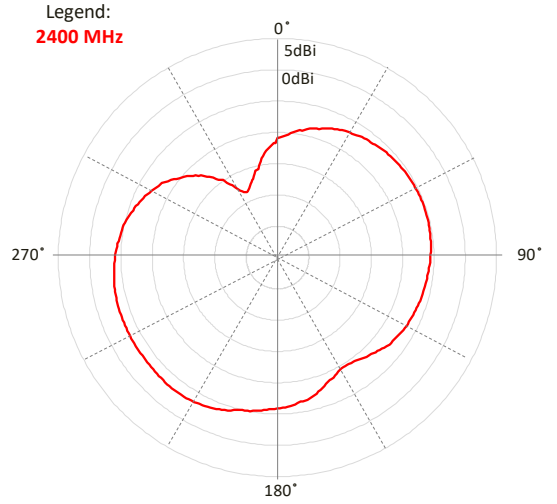

Elevation 1

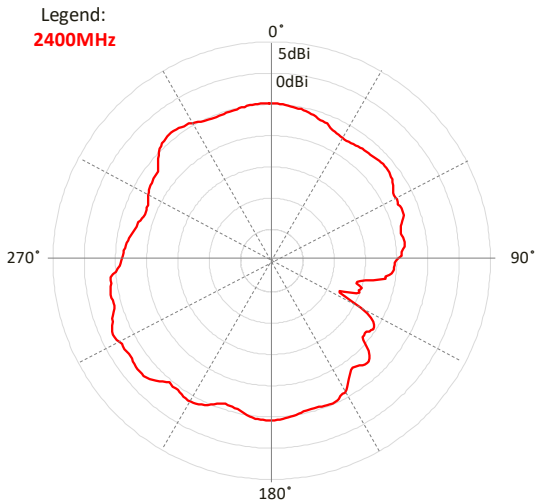

Elevation 2

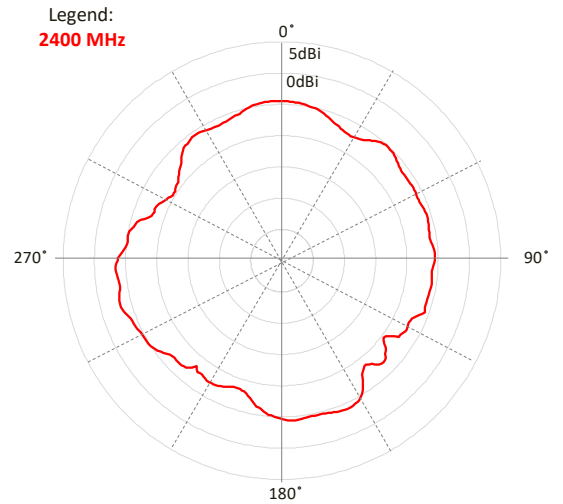

RADIATION PATTERN – Vibration Sensor condition

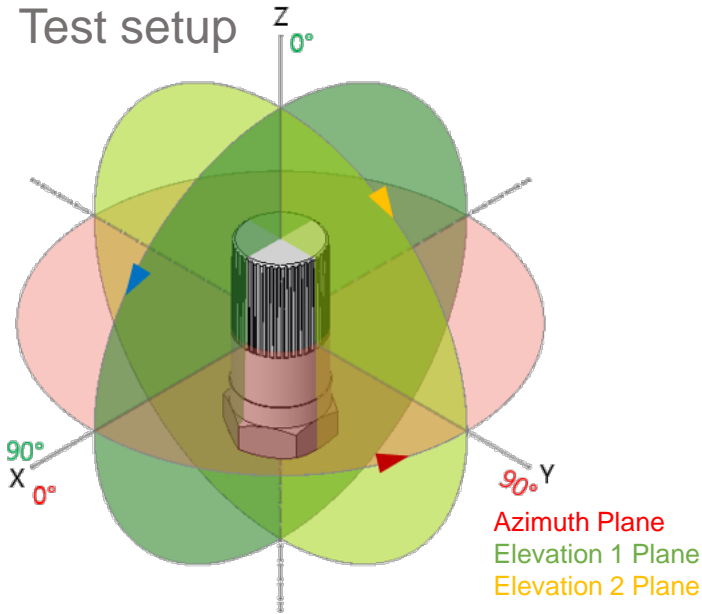

Azimuth

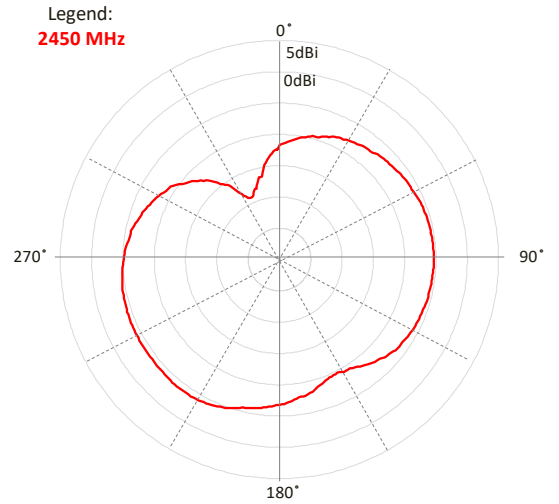

Elevation 1

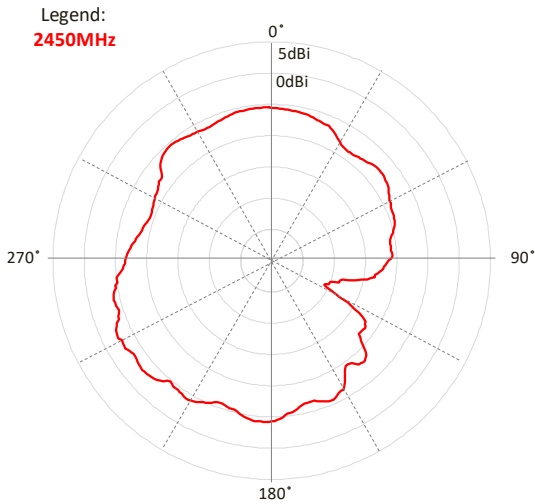

Elevation 2

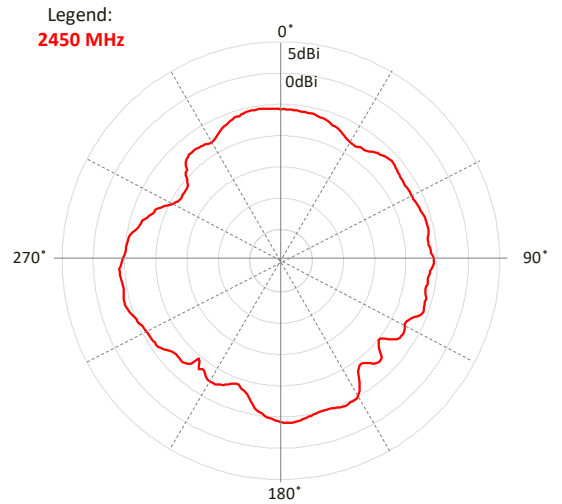

RADIATION PATTERN – Pressure Sensor condition

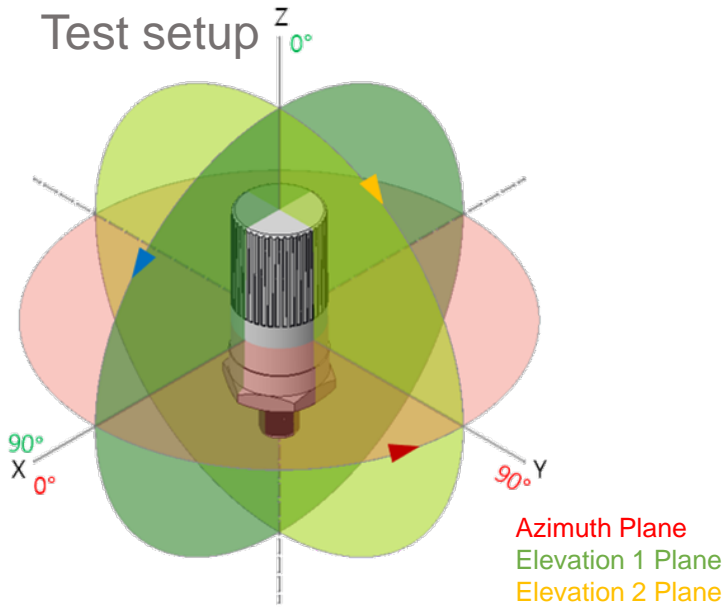

Azimuth

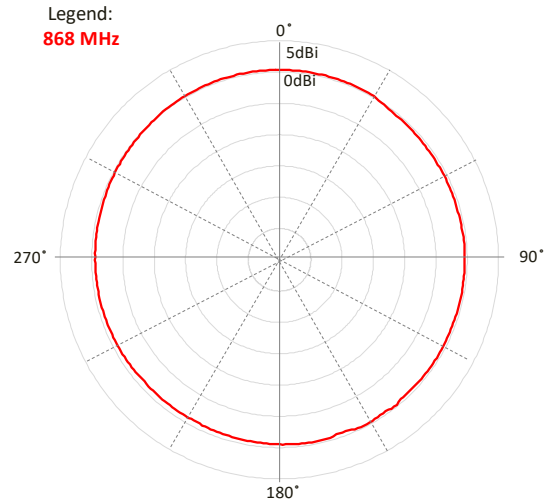

Elevation 1

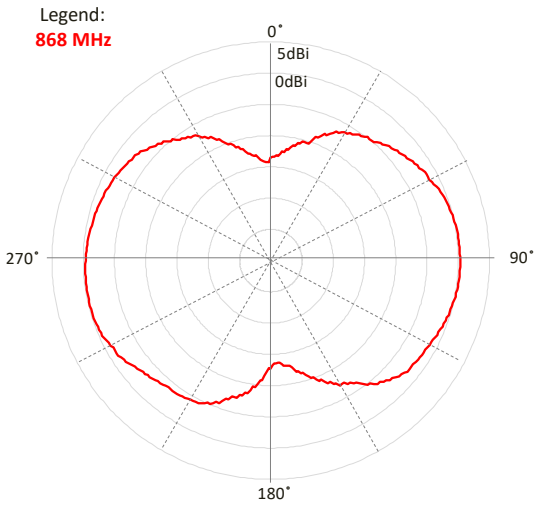

Elevation 2

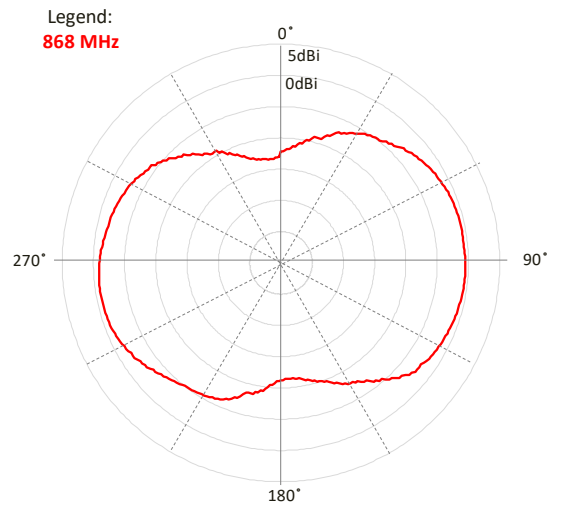

RADIATION PATTERN – Pressure Sensor condition

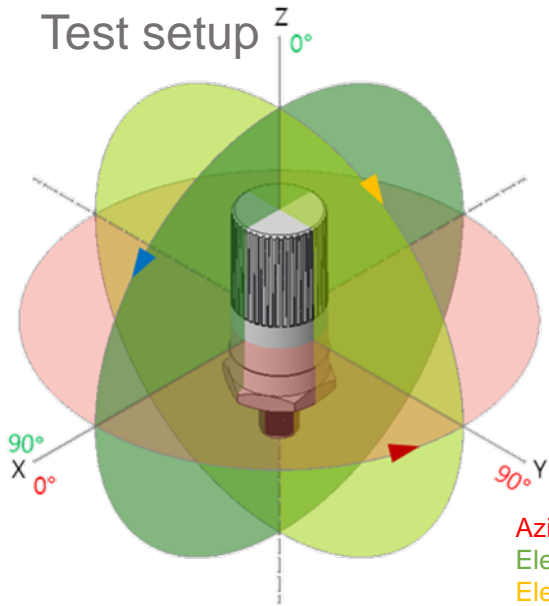

Azimuth

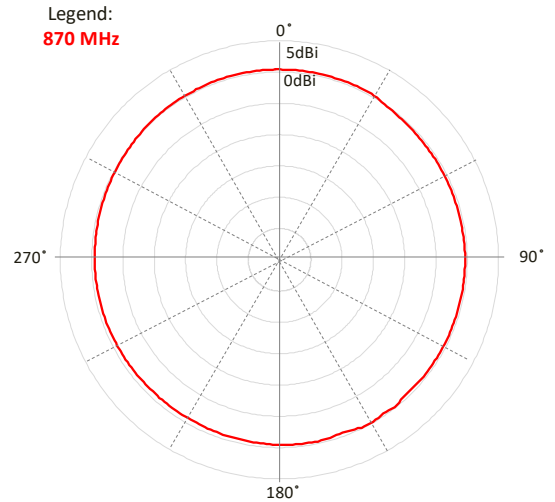

Elevation 1

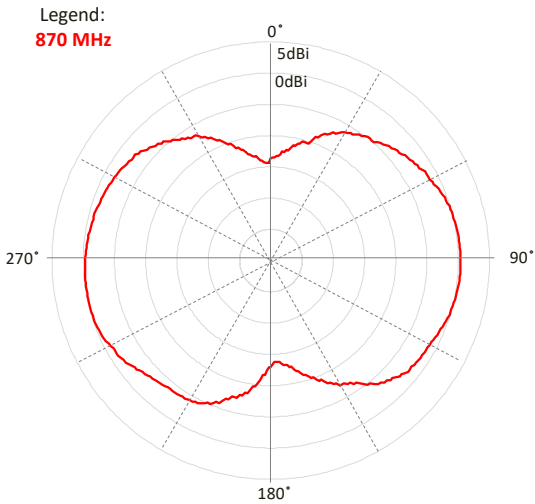

Elevation 2

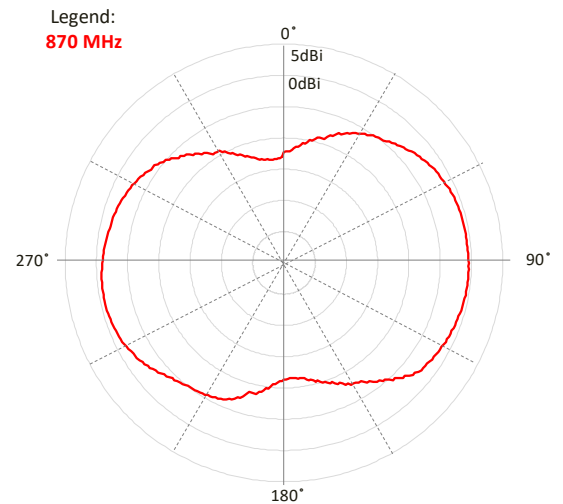

RADIATION PATTERN – Pressure Sensor condition

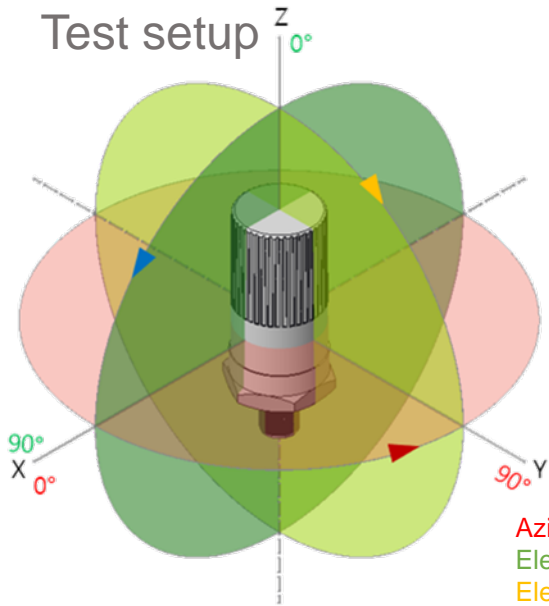

Azimuth

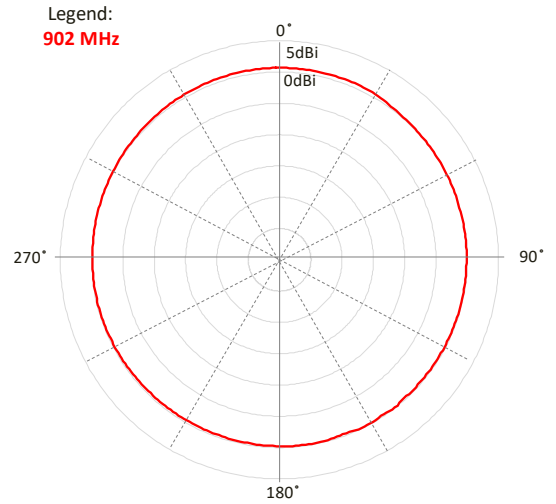

Elevation 1

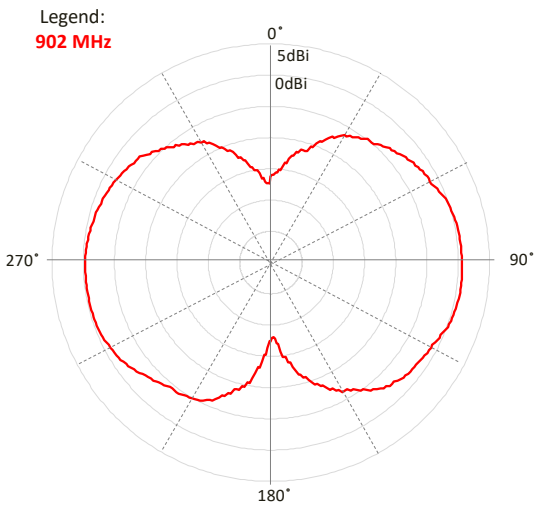

Elevation 2

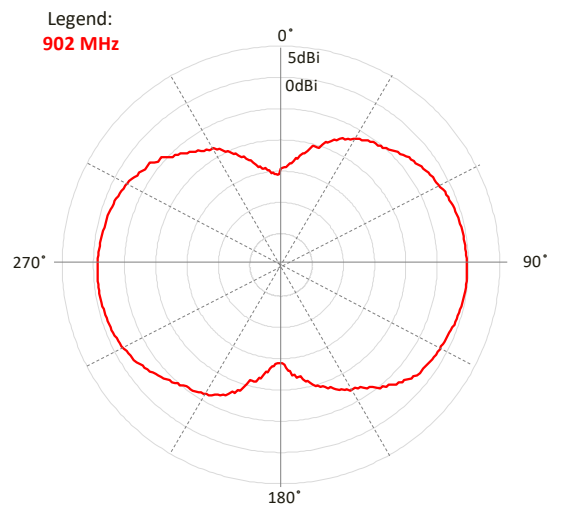

RADIATION PATTERN – Pressure Sensor condition

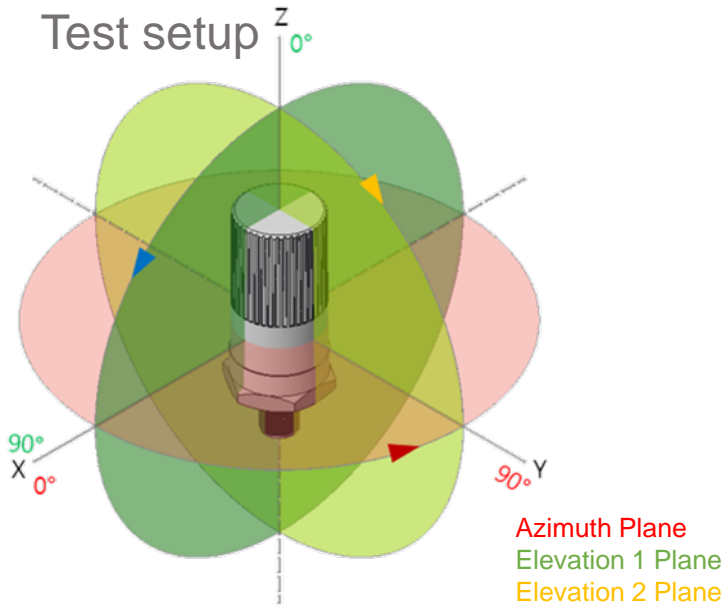

Azimuth

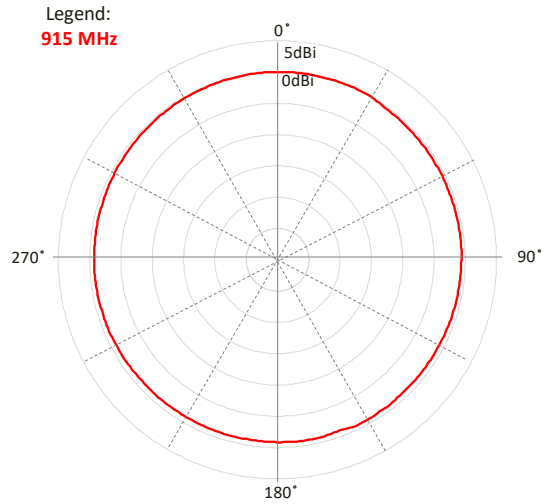

Elevation 1

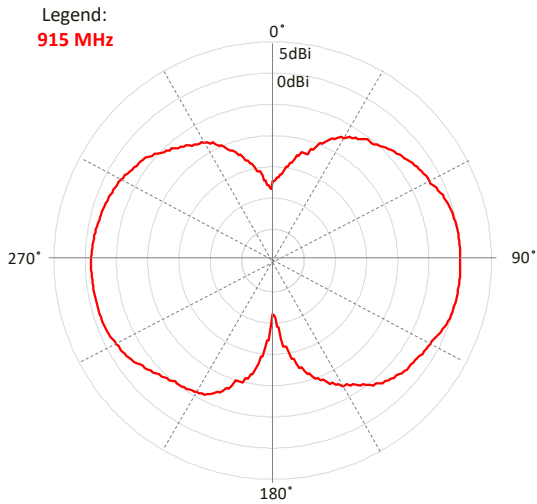

Elevation 2

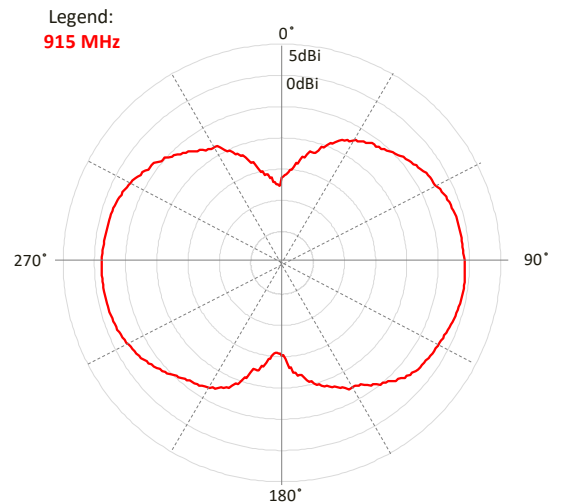

RADIATION PATTERN – Pressure Sensor condition

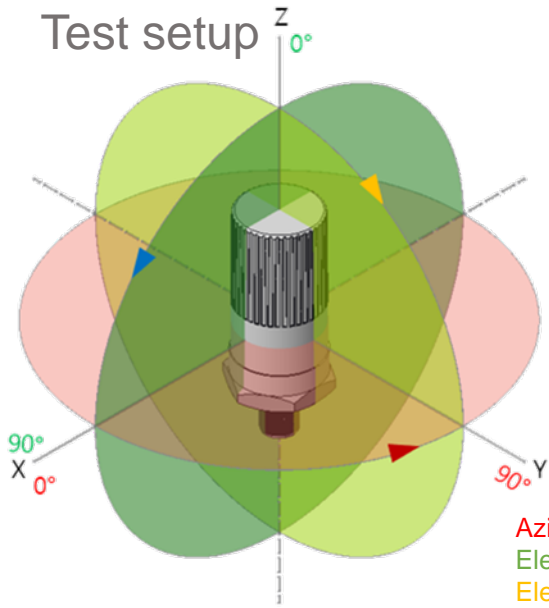

Azimuth

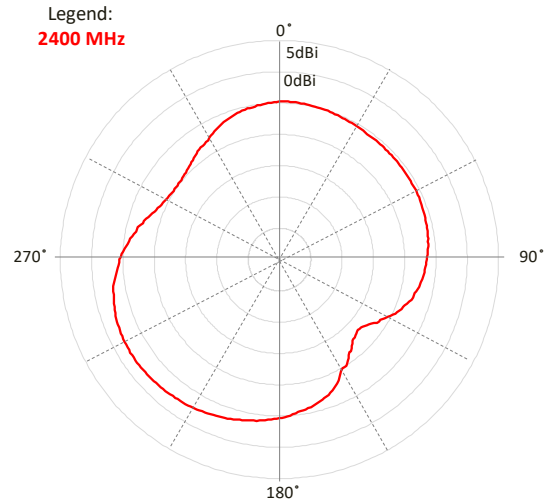

Elevation 1

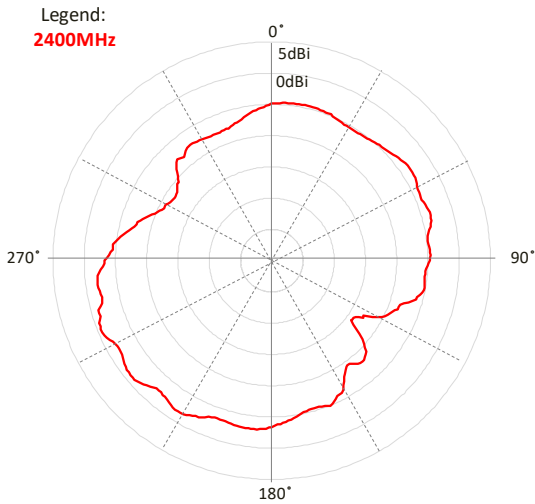

Elevation 2

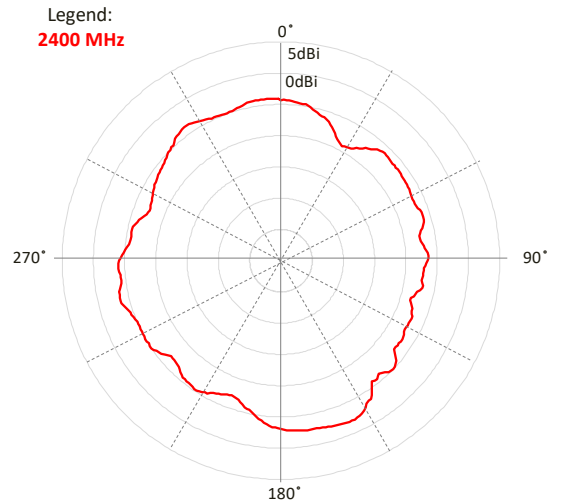

RADIATION PATTERN – Pressure Sensor condition

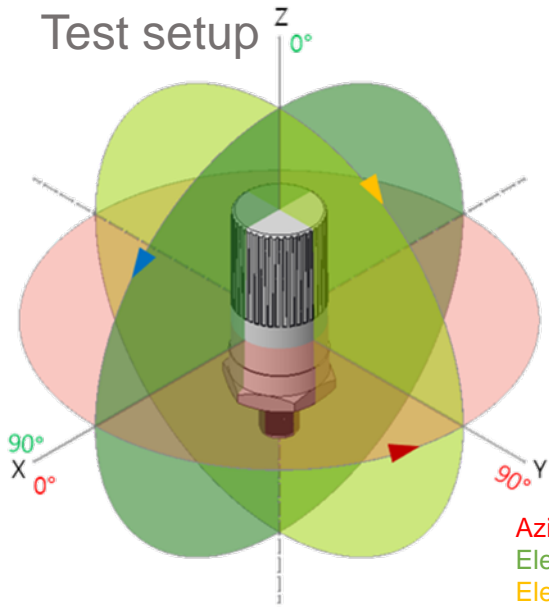

Azimuth

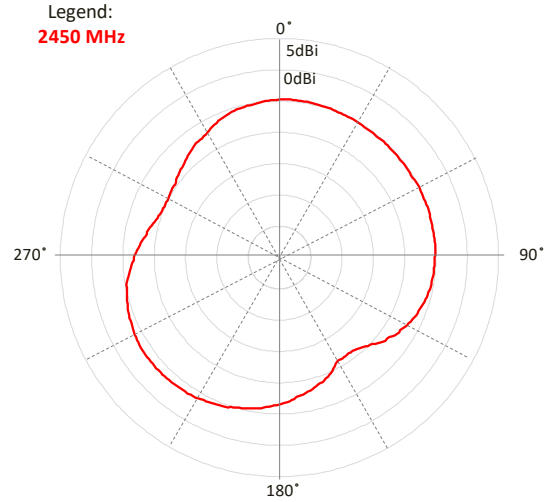

Elevation 1

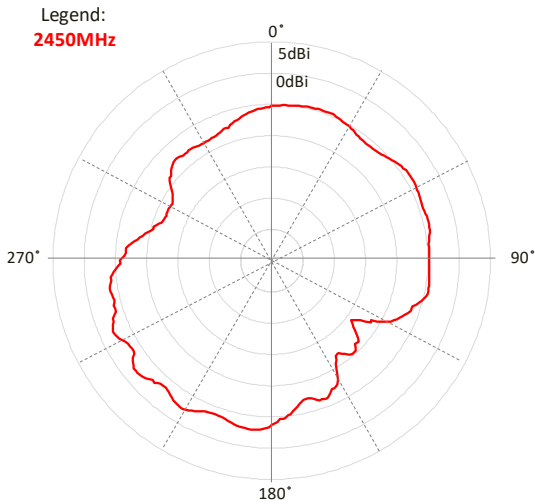

Elevation 2

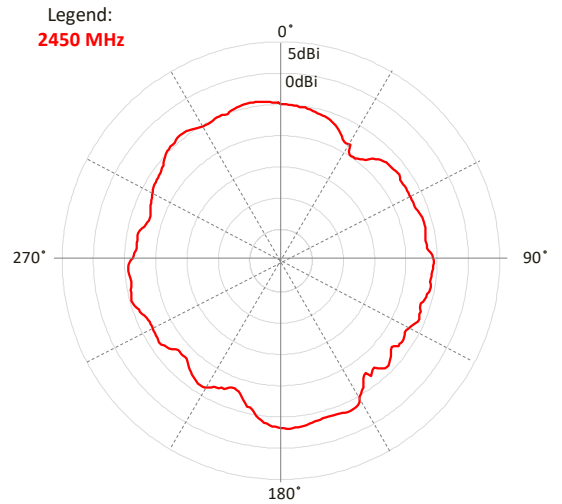

DIMENSIONS

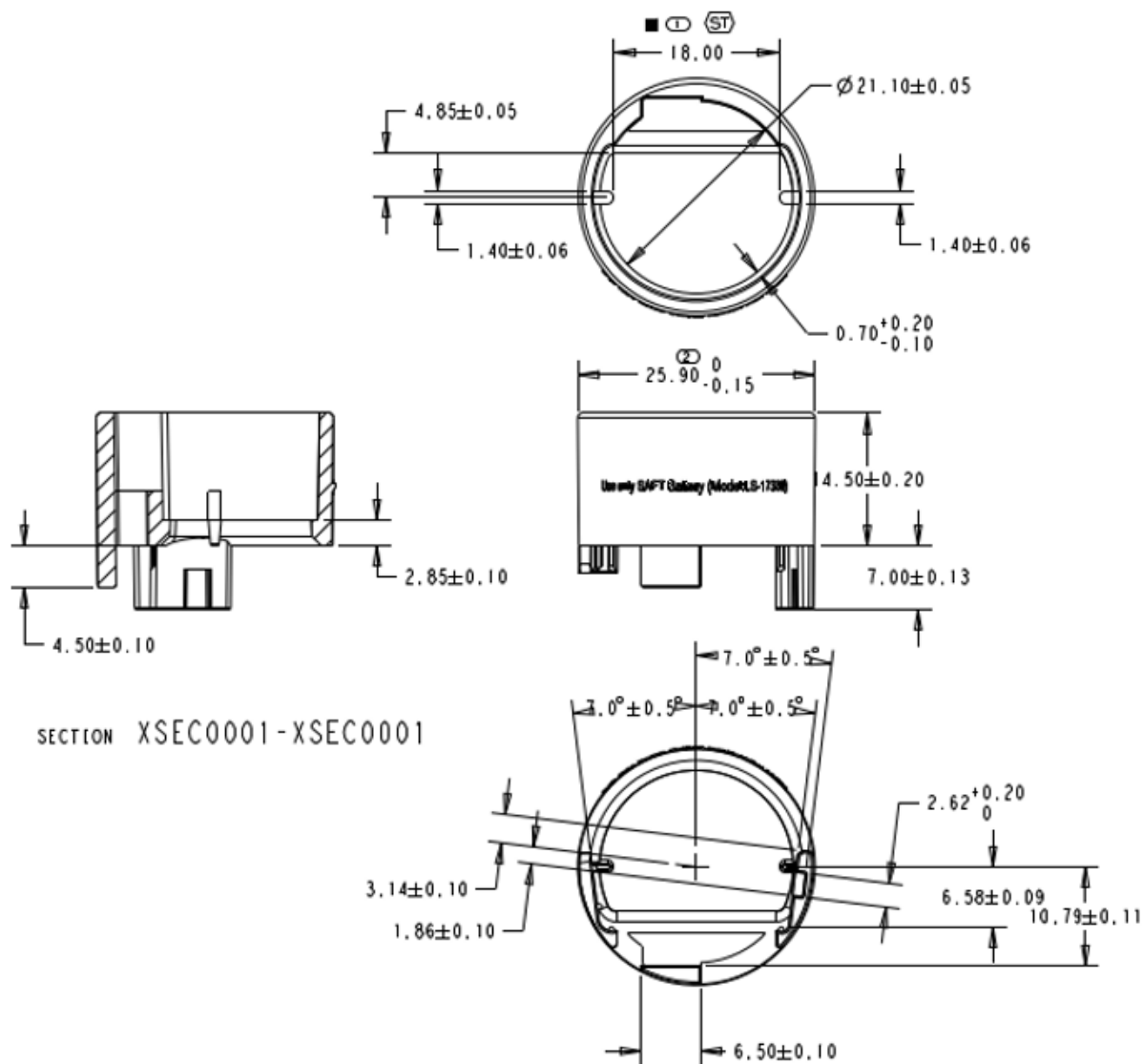

Dimension: mm

Diagrams is not to scale

APPENDIX



Vibration sensor



Pressure sensor

Test condition – Free space / Orientation

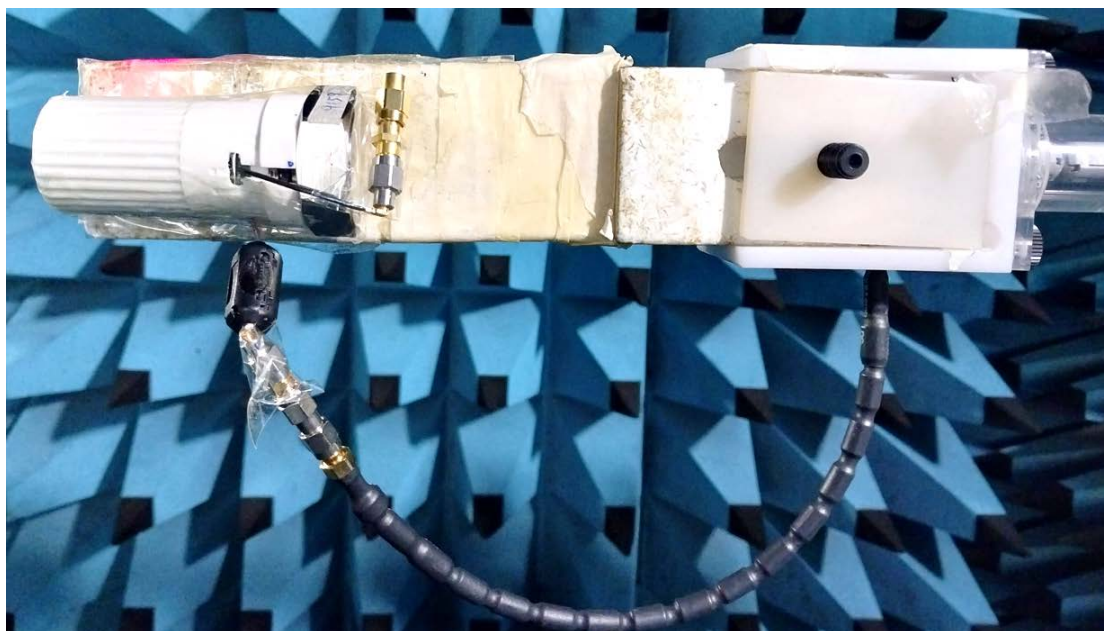
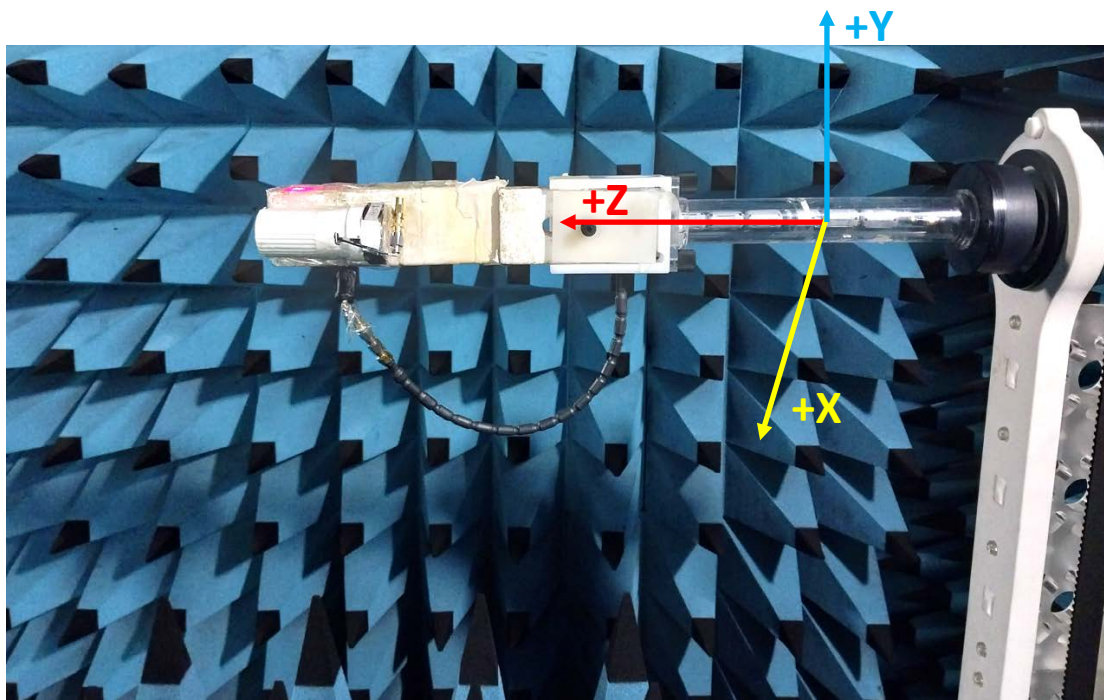

- Antenna measurement cables : Ferrite ring / 50 Ω Termination
- Chamber Measurement cable : With Ferrite rings

Test condition – Free space / Orientation

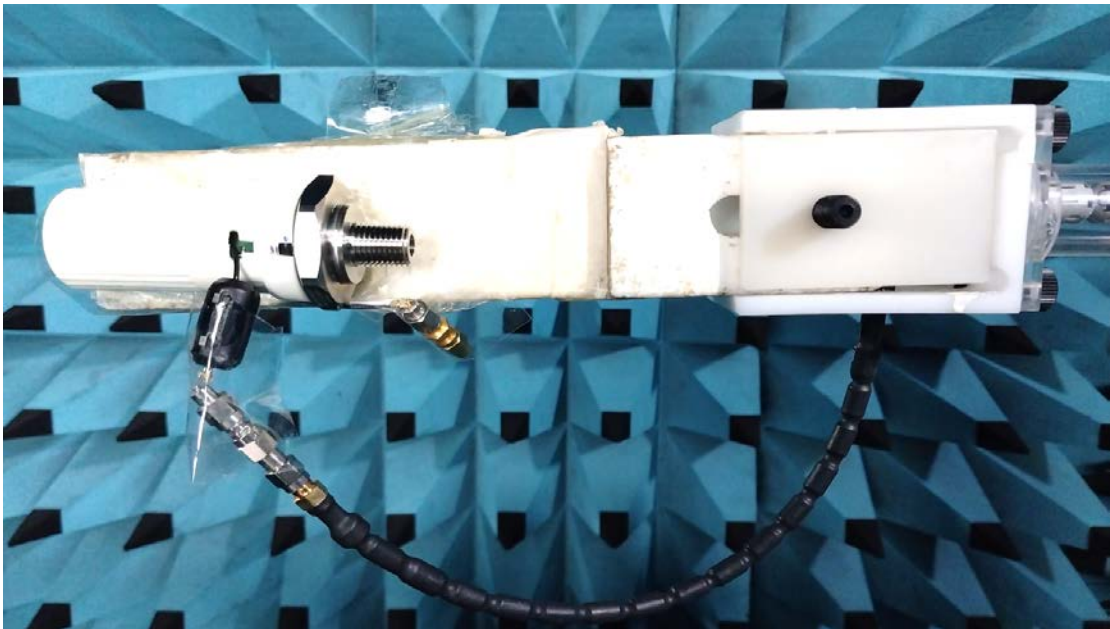
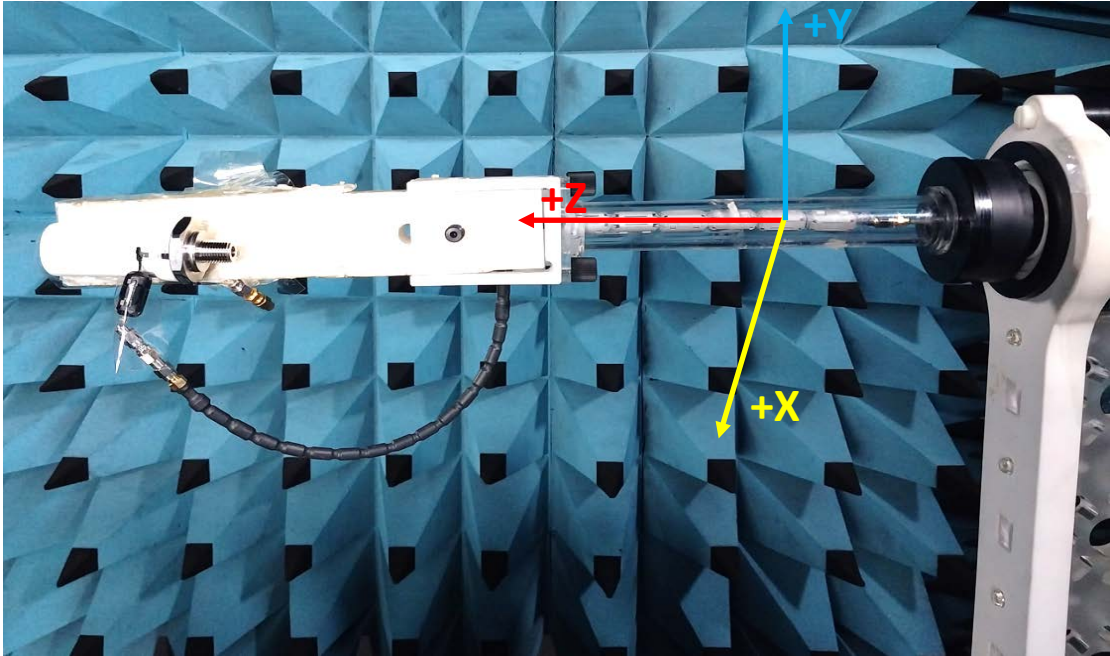

- Antenna measurement cables : Ferrite ring / 50 Ω Termination
- Chamber Measurement cable : With Ferrite rings

Matching circuit values

Vibration / Pressure Sensor condition

LoRa Antenna

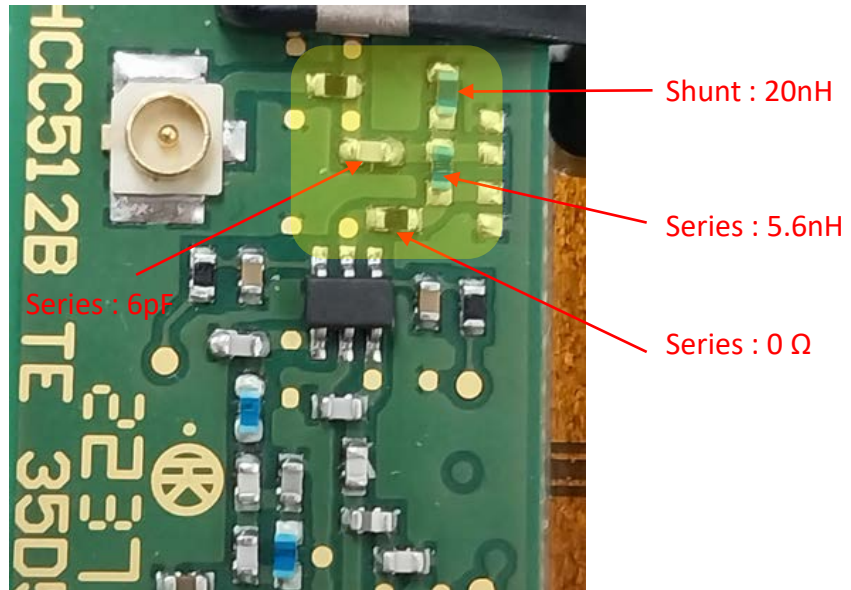

Matching circuit values
Ant – Series 6pF – shunt 20nH – Series 5.6nH – Series 0 Ω

BLE Antenna

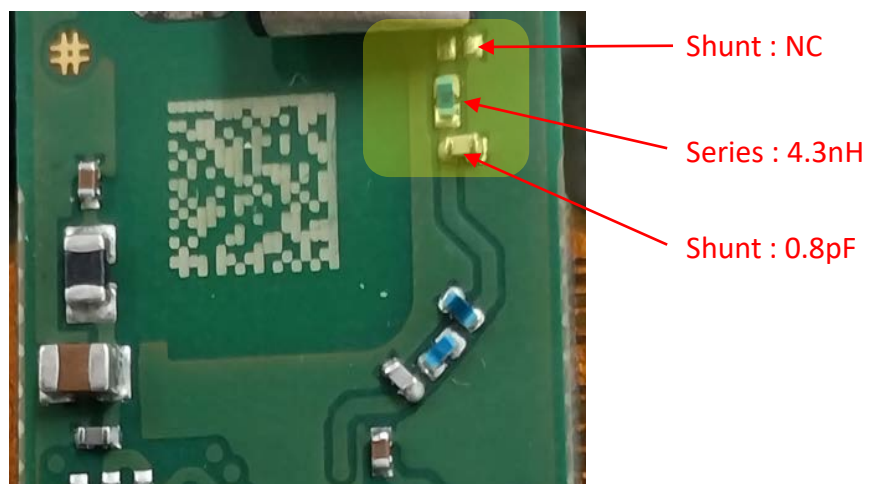

Matching circuit values
Ant – shunt NC – Series 4.3nH - Shunt 0.8pF

PACKAGING

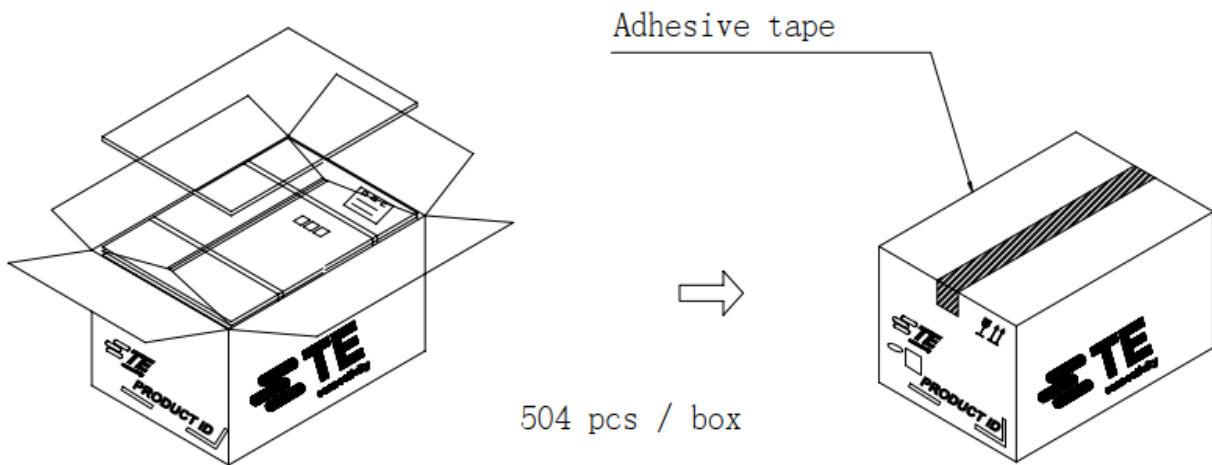

TE TECHNICAL SUPPORT CENTER

USA:	+1 (800) 522-7752
Canada:	+1 (905) 475-6222
Mexico:	+52 (0) 55-1106-0800
Latin/S. America:	+54 (0) 11-4733-2200
Germany:	+49 (0) 6251-133-1999
UK:	+44 (0) 800-267666
France:	+33 (0) 1-3420-8686
Netherlands:	+31 (0) 73-6246-999
China:	+86 (0) 400-820-6015

For phone numbers in other countries, go to te.com/support-center

te.com

TE Connectivity, TE Connectivity (logo) are trademarks. All other logos, products and/or company names referred to herein might be trademarks of their respective owners.

The information given herein, including drawings, illustrations and schematics which are intended for illustration purposes only, is believed to be reliable. However, TE Connectivity makes no warranties as to its accuracy or completeness and disclaims any liability in connection with its use. TE Connectivity's obligations shall only be as set forth in TE Connectivity's Standard Terms and Conditions of Sale for this product and in no case will TE Connectivity be liable for any incidental, indirect or consequential damages arising out of the sale, resale, use or misuse of the product. Users of TE Connectivity products should make their own evaluation to determine the suitability of each such product for the specific application.

© 2020 TE Connectivity Ltd. family of companies All Rights Reserved.

12/2022