

Shenzhen Aihui Technology Co. , Ltd.

Antenna specification

Antenna Sample Confirmation From

Name of supplier	ShenZhen Aihui Technology Co. , Ltd				
Customer name	Xin Xiang				
Sample name	R106				
model					
Sample size					
Inspection item	Performance test	Visual inspection	Structure	In the news	Test results
Notes					
Quality Audit		Project Audit	Caoyang	Business confirmation	

Address: 402TEL: 0755-23203435fax: 0755-23203435, Block C, Juxin Science and Technology Industrial Park, Nanchang community, xixiang, Baoan District, Shenzhen

Shenzhen Aihui Technology Co. , Ltd.

The following is to be completed by the client_____

Customer
feedback

Customer
signature/seal

date:

Antenna Test Report

Test Unit: Shenzhen Aihui Technology Co. , Ltd.

Materials

FPC coaxial line

Antenna
form

PIFA

Polarization mode

Linear

Shenzhen Aihui Technology Co. , Ltd.

Application			
scenario			
Working band	2400Mhz-2500Mhz	VSWR	≤2
Power	Max: 2W	Impedance	50 Ω
dBi	≤2dBi		
Test Equipment	HPE5071C、Shielding Room、3D automatic turntable		
<p>Antenna Description:</p> <p>1. Grounding processing and picture description: no</p> <p>2. Need to change the motherboard to match: no</p> <ul style="list-style-type: none"> ● Test voltage: 3.6V, check the antenna contact is good before testing. ● The RF cable of the integrated tester is kept in a natural state and can not be curled. <p>Specification:test the specified power level, all indicators must conform to the specifications.</p>			

Shenzhen Aihui Technology Co. , Ltd.

1. Project Image

2. Test Fixture

3. Antenna matching circuit

4. S11 test

5. Antenna passive efficiency and gain

6. Darkroom test equipment and data

7. Schematic diagram of antenna assembly

8. Antenna environment handling

9. Antenna mass production index

10. Structural drawing

Address: 402 TEL: 0755-23203435 fax: 0755-23203435, Block C, Juxin Science and Technology Industrial Park, Nanchang community, xixiang, Baoan District, Shenzhen

1. Project Image

The final verification antenna performance prototype in our company for at least one year, easy to analyze and solve the problem of antenna mass production, to ensure the quality of antenna shipment

2. Test Fixture

Objective: to test the passive parameters of antenna as accurately as possible. Making

Method: the handset is made of a 50 ohm coaxial cable, one end of which is connected to the test point of the back end of the matching circuit of the handset motherboard (front end of the RF test hole) , and the other end is connected to the SMA joint. The diagram is as follows:

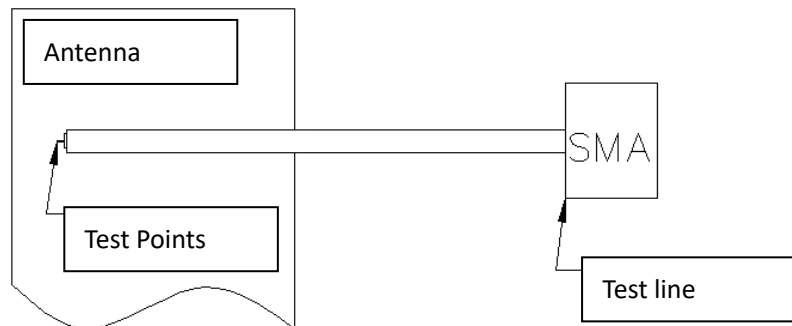

3. Antenna matching circuit

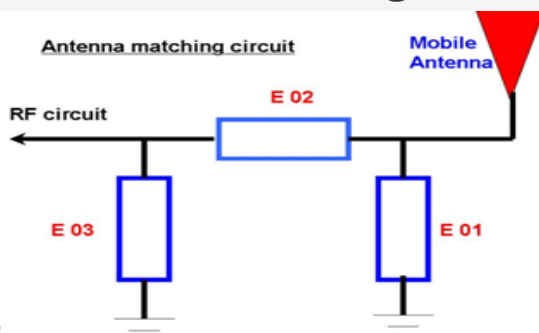

Modify

E01	E02	E03
No	No	No

Note: The match is unmodified.

4.S11 test

4.0 4.0s11 test method description of test equipment: Network Analyzer (E5071C) test method: a 50 ohm CABLE is used to export from the instrument test port. The SMA connector for connecting the handset is calibrated using a calibration piece, record the echo loss and standing wave ratio corresponding to the relevant frequency points. The test schematic is as follows:

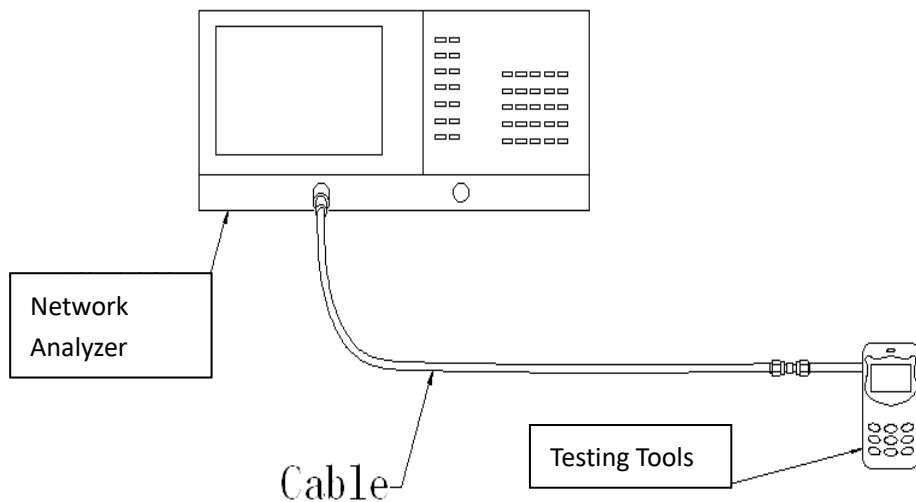

Shenzhen Aihui Technology Co. , Ltd.

4.1 SWR

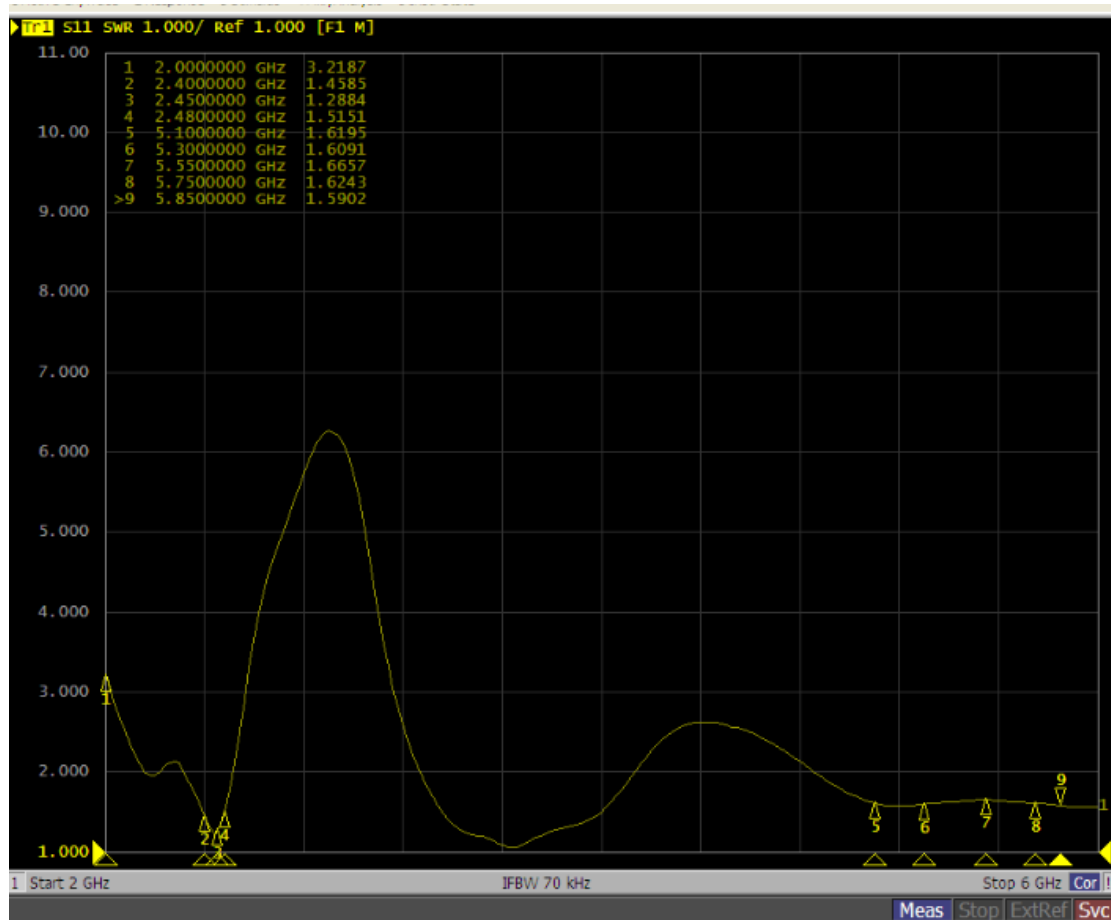

5. Darkroom test equipment and data

6. Test Equipment

Address: 402 TEL: 0755-23203435 fax: 0755-23203435, Block C, Juxin Science and Technology Industrial Park, Nanchang community, xixiang, Baoan District, Shenzhen

Shenzhen Aihui Technology Co. , Ltd.

Test system: shielded darkroom

The temperature was $22^{\circ}\text{C} \pm 3^{\circ}\text{C}$ and the humidity was $50\% \pm 15\%$

Test equipment: when testing passive data, use the Network analyzer AGILENTE5071C to test active data, use the omnibus CMW500

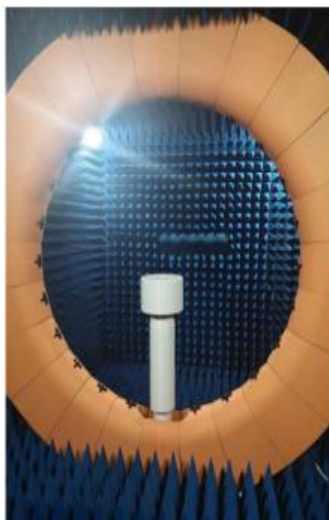

Address: 402TEL: 0755-23203435fax: 0755-23203435, Block C, Juxin Science and Technology Industrial Park, Nanchang community, xixiang, Baoan District, Shenzhen

Shenzhen Aihui Technology Co. , Ltd.

7.Active antenna test data

Frequency Band	2.4WIFI-B			2.4WIFI-G		
channel	L	M	H	L	M	H
TRP	13.5	13.8	13.9	11.5	12.8	12.3
TIS			-81.4			-71.2
Frequency Band	2.4WIFI-N					
channel	L	M	H			
TRP	12.4	12.3	12.5			
TIS			-66.3			

WIFI:		
WIFI: 2.4G		
Frequency (MHZ)	Efficiency (%)	Gain (dbi)
2400	55.4	1.14
2410	56.5	1.25
2420	57.5	1.30

Shenzhen Aihui Technology Co. , Ltd.

2430	54.2	1.42
2440	55.6	1.28
2450	60.0	1.30
2460	61.5	1.42
2470	64.5	2.00
2480	62.5	1.52
2490	61.8	1.31
2500	62.3	1.25

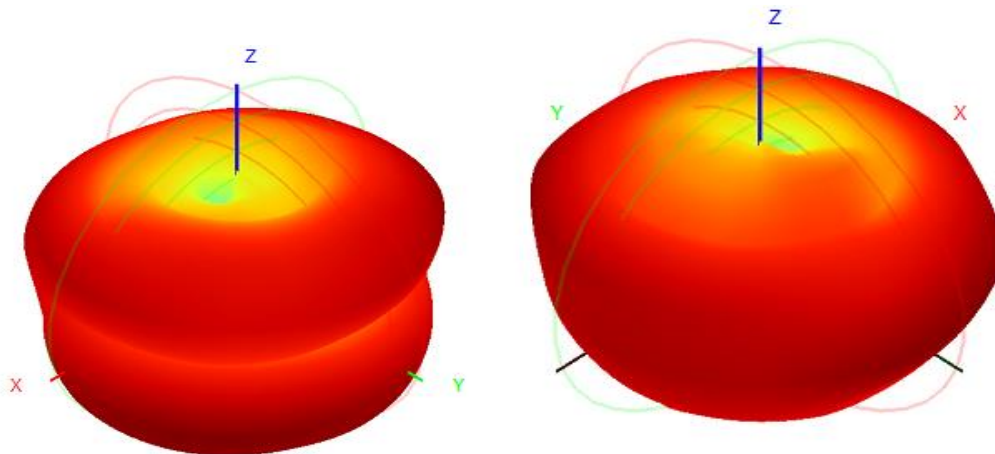

Shenzhen Aihui Technology Co. , Ltd.

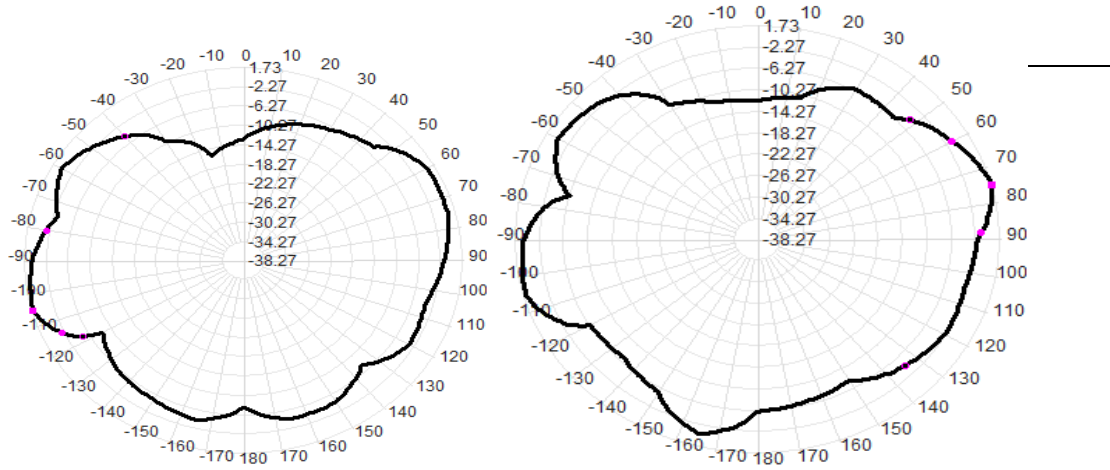

8.Schematic diagram of antenna assembly

9.Antenna environment handling

10.Antenna mass production index

When the antenna is mass-produced, the standing wave ratio is taken as the mass-produced test standard. Based on the differences of the project itself, the following criteria are given:	Standard for volume production
2400Mhz-2500Mhz	VSWR (Mass Production performance) & LT;

Shenzhen Aihui Technology Co. , Ltd.

	VSWR(recognition
	performance) 0.5

10.1 Structural drawings

