



# FCC TEST REPORT

## FCC ID:2A82U-SK02-1

Applicant: Shenzhen Kangerjian Intelligent Technology Co., Ltd.  
Address: 4 / F, Building C2, Fuyuan Industrial City, Zhoushi Road, Bao 'an District Shenzhen, Guangdong China

Manufacturer: Shenzhen Kangerjian Intelligent Technology Co., Ltd.  
Address: 4 / F, Building C2, Fuyuan Industrial City, Zhoushi Road, Bao 'an District Shenzhen, Guangdong China

EUT: Heated socks

Trade Mark: N/A

Model Number: SK-02  
SK-01, SK-03, SK-04, SK-05, SK-06, SK-07, SK-08, SK-09, SK-10

Date of Receipt: Aug. 10, 2025

Test Date: Aug. 10, 2025 to Sep. 12, 2025

Date of Report: Sep. 12, 2025

Prepared By: Shenzhen DL Testing Technology Co., Ltd.  
Address: 101-201, Comprehensive Building, Tongzhou Electronics Longgang Factory Area, No.1 Baolong Fifth Road, Baolong Community, Baolong Street, Longgang District, Shenzhen, China

Applicable Standards: FCC CFR Title 47 Part 15 Subpart C Section 15.247  
ANSI C63.10:2013

Test Result: Pass

Report Number: DLE-2509110011R

Prepared (Test Engineer): Dimon Tan

Reviewer (Supervisor): Jack Bu

Approved (Manager): Jade Yang



*This test report is based on a single evaluation of one sample of above mentioned products. It is not permitted to be duplicated in extracts without written approval of Shenzhen DL Testing Technology Co., Ltd.*

**Table of Contents****Page**

<b>1. VERSION</b> .....	<b>4</b>
<b>2. SUMMARY OF TEST RESULTS</b> .....	<b>5</b>
<b>2.1 TEST FACILITY</b> .....	<b>6</b>
<b>2.2 MEASUREMENT UNCERTAINTY</b> .....	<b>6</b>
<b>3. GENERAL INFORMATION</b> .....	<b>7</b>
<b>3.1 GENERAL DESCRIPTION OF EUT</b> .....	<b>7</b>
<b>3.2 DESCRIPTION OF TEST MODES</b> .....	<b>8</b>
<b>3.3 BLOCK DIGRAM SHOWING THE CONFIGURATION OF SYSTEM TESTED</b> .....	<b>9</b>
<b>3.4 DESCRIPTION OF SUPPORT UNITS(CONDUCTED MODE)</b> .....	<b>9</b>
<b>3.5 EQUIPMENTS LIST FOR ALL TEST ITEMS</b> .....	<b>10</b>
<b>4. EMC EMISSION TEST</b> .....	<b>11</b>
<b>4.1 CONDUCTED EMISSION MEASUREMENT</b> .....	<b>11</b>
<b>4.1.1 POWER LINE CONDUCTED EMISSION LIMITS</b> .....	<b>11</b>
<b>4.1.2 TEST PROCEDURE</b> .....	<b>11</b>
<b>4.1.3 DEVIATION FROM TEST STANDARD</b> .....	<b>11</b>
<b>4.1.4 TEST SETUP</b> .....	<b>12</b>
<b>4.1.5 EUT OPERATING CONDITIONS</b> .....	<b>12</b>
<b>4.1.6 TEST RESULT</b> .....	<b>13</b>
<b>4.2 RADIATED EMISSION MEASUREMENT</b> .....	<b>15</b>
<b>4.2.1 RADIATED EMISSION LIMITS</b> .....	<b>15</b>
<b>4.2.2 TEST PROCEDURE</b> .....	<b>16</b>
<b>4.2.3 DEVIATION FROM TEST STANDARD</b> .....	<b>16</b>
<b>4.2.4 TEST SETUP</b> .....	<b>16</b>
<b>4.2.5 EUT OPERATING CONDITIONS</b> .....	<b>17</b>
<b>4.2.6 TEST RESULTS</b> .....	<b>17</b>
<b>5. RADIATED BAND EMISSION MEASUREMENT</b> .....	<b>22</b>
<b>5.1 TEST REQUIREMENT</b> .....	<b>22</b>
<b>5.2 TEST PROCEDURE</b> .....	<b>22</b>
<b>5.3 DEVIATION FROM TEST STANDARD</b> .....	<b>23</b>
<b>5.4 TEST SETUP</b> .....	<b>23</b>
<b>5.5 EUT OPERATING CONDITIONS</b> .....	<b>23</b>
<b>5.6 TEST RESULT</b> .....	<b>24</b>
<b>6. POWER SPECTRAL DENSITY TEST</b> .....	<b>25</b>
<b>6.1 APPLIED PROCEDURES / LIMIT</b> .....	<b>25</b>

**Table of Contents**

	<b>Page</b>
<b>6.2 TEST PROCEDURE</b> .....	<b>25</b>
<b>6.3 DEVIATION FROM STANDARD</b> .....	<b>25</b>
<b>6.4 TEST SETUP</b> .....	<b>25</b>
<b>6.5 EUT OPERATION CONDITIONS</b> .....	<b>25</b>
<b>6.6 TEST RESULT</b> .....	<b>26</b>
<b>7. 6DB OCCUPIED BANDWIDTH</b> .....	<b>28</b>
<b>7.1 APPLIED PROCEDURES / LIMIT</b> .....	<b>28</b>
<b>7.2 TEST PROCEDURE</b> .....	<b>28</b>
<b>7.3 DEVIATION FROM STANDARD</b> .....	<b>28</b>
<b>7.4 TEST SETUP</b> .....	<b>28</b>
<b>7.5 EUT OPERATION CONDITIONS</b> .....	<b>28</b>
<b>7.6 TEST RESULT</b> .....	<b>29</b>
<b>8. PEAK OUTPUT POWER TEST</b> .....	<b>31</b>
<b>8.1 APPLIED PROCEDURES / LIMIT</b> .....	<b>31</b>
<b>8.2 TEST PROCEDURE</b> .....	<b>31</b>
<b>8.3 DEVIATION FROM STANDARD</b> .....	<b>31</b>
<b>8.4 TEST SETUP</b> .....	<b>31</b>
<b>8.5 EUT OPERATION CONDITIONS</b> .....	<b>31</b>
<b>8.6 TEST RESULT</b> .....	<b>32</b>
<b>9. CONDUCTED BAND EDGE AND SPURIOUS EMISSION</b> .....	<b>33</b>
<b>9.1 APPLICABLE STANDARD</b> .....	<b>33</b>
<b>9.2 TEST PROCEDURE</b> .....	<b>33</b>
<b>9.3 DEVIATION FROM STANDARD</b> .....	<b>34</b>
<b>9.4 TEST SETUP</b> .....	<b>34</b>
<b>9.5 EUT OPERATION CONDITIONS</b> .....	<b>34</b>
<b>9.6 TEST RESULTS</b> .....	<b>35</b>
<b>10. DUTY CYCLE</b> .....	<b>37</b>
<b>10.1 APPLIED PROCEDURES / LIMIT</b> .....	<b>37</b>
<b>10.2 DEVIATION FROM STANDARD</b> .....	<b>37</b>
<b>10.3 TEST SETUP</b> .....	<b>37</b>
<b>10.4 EUT OPERATION CONDITIONS</b> .....	<b>37</b>
<b>10.5 TEST RESULTS</b> .....	<b>38</b>
<b>11. ANTENNA REQUIREMENT</b> .....	<b>39</b>
<b>12. TEST SETUP PHOTO</b> .....	<b>40</b>
<b>13. EUT CONSTRUCTIONAL DETAILS</b> .....	<b>40</b>



**1. VERSION**

<b>Report No.</b>	<b>Version</b>	<b>Description</b>	<b>Approved</b>
DLE-2509110011R	Rev.01	Initial issue of report	Sep. 12, 2025



## 2. SUMMARY OF TEST RESULTS

Test procedures according to the technical standards:

FCC Part15 (15.247) , Subpart C			
Standard Section	Test Item	Judgment	Remark
FCC part 15.203/15.247(c)	Antenna requirement	PASS	
FCC part 15.207	AC Power Line Conducted Emission	PASS	
FCC part 15.247 (b)(3)	Conducted Peak Output Power	PASS	
FCC part 15.247 (a)(2)	6DB Occupied Bandwidth	PASS	
FCC part 15.247 (e)	Power Spectral Density	PASS	
FCC part 15.247 (d)	Conducted Band Edge & Unwanted Spurious Emission	PASS	
FCC part 15.205/15.209	Radiated Band Edge & Unwanted Spurious Emission	PASS	
ANSI C63.10:2013	Duty Cycle	PASS	

**NOTE:**

(1)"N/A" denotes test is not applicable in this Test Report



## 2.1 TEST FACILITY

Shenzhen DL Testing Technology Co., Ltd.

Add. : 101-201, Comprehensive Building, Tongzhou Electronics Longgang Factory Area, No.1 Baolong Fifth Road, Baolong Community, Baolong Street, Longgang District, Shenzhen, China

FCC Test Firm Registration Number: 854456

Designation Number: CN1307

IC Registered No.: 27485

CAB identifier: CN0118

## 2.2 MEASUREMENT UNCERTAINTY

The reported uncertainty of measurement  $y \pm U$ , where expanded uncertainty  $U$  is based on a standard uncertainty multiplied by a coverage factor of  $k=2$ , providing a level of confidence of approximately 95 %.

No.	Item	Uncertainty
1	3m chamber Radiated spurious emission(9KHz-30MHz)	U=4.5dB
2	3m chamber Radiated spurious emission(30MHz-1GHz)	U=4.8dB
3	3m chamber Radiated spurious emission(1GHz-6GHz)	U=4.9dB
4	3m chamber Radiated spurious emission(6GHz-40GHz)	U=5.0dB
5	Conducted disturbance	U=3.2dB
6	RF Band Edge	U=1.68dB
7	RF power conducted	U=1.86dB
8	RF conducted Spurious Emission	U=2.2dB
9	RF Occupied Bandwidth	U=1.8MHz
10	RF Power Spectral Density	U=1.75dB
11	humidity uncertainty	U=5.3%
12	Temperature uncertainty	U=0.59°C



### 3. GENERAL INFORMATION

#### 3.1 GENERAL DESCRIPTION OF EUT

Product Name:	Heated socks
Model No.:	SK-02
Serial No.:	SK-01, SK-03, SK-04, SK-05, SK-06, SK-07, SK-08, SK-09, SK-10
Model Different.:	All the model are the same circuit and RF module, only the model name are different.
Bluetooth Version:	V5.0
Hardware Version:	V1.0
Software Version:	V1.0
Sample(s) Status:	Engineer sample
Operation Frequency:	2402MHz~2480MHz
Channel Numbers:	40 Channels
Channel Separation:	2MHz
Modulation Type:	GFSK
Antenna Type:	PCB Antenna
Antenna Gain:	1.25dBi
Power Supply:	Input: 5V---2A Output: 5V---2A
Battery:	DC 3.7V, 6000mAh, 22.2Wh Max



Operation Frequency each of channel							
Channel	Frequency	Channel	Frequency	Channel	Frequency	Channel	Frequency
1	2402 MHz	11	2422 MHz	21	2442 MHz	31	2462 MHz
2	2404 MHz	12	2424 MHz	22	2444 MHz	32	2464 MHz
3	2406 MHz	13	2426 MHz	23	2446 MHz	33	2466 MHz
4	2408 MHz	14	2428 MHz	24	2448 MHz	34	2468 MHz
5	2410 MHz	15	2430 MHz	25	2450 MHz	35	2470 MHz
6	2412 MHz	16	2432 MHz	26	2452 MHz	36	2472 MHz
7	2414 MHz	17	2434 MHz	27	2454 MHz	37	2474 MHz
8	2416 MHz	18	2436 MHz	28	2456 MHz	38	2476 MHz
9	2418 MHz	19	2438 MHz	29	2458 MHz	39	2478 MHz
10	2420 MHz	20	2440 MHz	30	2460 MHz	40	2480 MHz

**Note:**

In section 15.31(m), regards to the operating frequency range over 10 MHz, the Lowest frequency, the middle frequency, and the highest frequency of channel were selected to perform the test, and the selected channel see below:

Channel	Frequency
The lowest channel	2402MHz
The middle channel	2440MHz
The Highest channel	2480MHz

**3.2 DESCRIPTION OF TEST MODES**

Transmitting mode	Keep the EUT in continuously transmitting mode
Remark: During the test, the test voltage was tuned from 85% to 115% of the nominal rated supply voltage, and found that the worst case was under the nominal rated supply condition. So the report just shows that condition's data. For battery operated equipment, the equipment tests shall be performed using a new battery.	
Test Software	FCC_assist_1.0.2.2
Power level setup	Default





### 3.3 BLOCK DIGRAM SHOWING THE CONFIGURATION OF SYSTEM TESTED

#### Conducted Emission



#### Radiated Emission

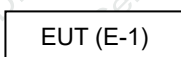

#### Conducted Spurious

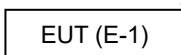

### 3.4 DESCRIPTION OF SUPPORT UNITS(CONDUCTED MODE)

The EUT has been tested as an independent unit together with other necessary accessories or support units. The following support units or accessories were used to form a representative test configuration during the tests.

Item	Equipment	Mfr/Brand	Model/Type No.	Series No.	Note
E-1	Heated socks	N/A	SK-02	N/A	EUT
E-2	AC/DC Adapter	SAMSUNG	EP-T4510	N/A	Auxiliary

Item	Shielded Type	Ferrite Core	Length	Note

#### Note:

- (1) The support equipment was authorized by Declaration of Confirmation.
- (2) For detachable type I/O cable should be specified the length in cm in 『Length』 column.
- (3) EUT is tested with new battery.



### 3.5 EQUIPMENTS LIST FOR ALL TEST ITEMS

#### Radiation test, Band-edge test and 6db bandwidth test equipment

Item	Equipment	Manufacturer	Type No.	Serial No.	Last calibration	Calibrated until
1	Spectrum Analyzer (9kHz-26.5GHz)	Agilent	E4408B	MY50140780	Nov. 01, 2024	Oct. 31, 2025
2	Test Receiver (9kHz-7GHz)	R&S	ESRP7	101393	Nov. 01, 2024	Oct. 31, 2025
3	Bilog Antenna (30MHz-1GHz)	R&S	VULB9162	00306	Nov. 01, 2024	Oct. 31, 2025
4	Horn Antenna (1GHz-18GHz)	Schwarzbeck	BBHA9120D	02139	Nov. 01, 2024	Oct. 31, 2025
5	Horn Antenna (18GHz-40GHz)	A.H. Systems	SAS-574	588	Nov. 01, 2024	Oct. 31, 2025
6	Amplifier (9KHz-6GHz)	Schwarzbeck	BBV9743B	00153	Nov. 01, 2024	Oct. 31, 2025
7	Amplifier (1GHz-18GHz)	EMEC	EM01G8GA	00270	Nov. 01, 2024	Oct. 31, 2025
8	Amplifier (18GHz-40GHz)	Quanjuda	DLE-161	97	Nov. 01, 2024	Oct. 31, 2025
9	Loop Antenna (9KHz-30MHz)	Schwarzbeck	FMZB1519B	00014	Nov. 01, 2024	Oct. 31, 2025
10	RF cables1 (9kHz-1GHz)	ChengYu	966	004	Nov. 01, 2024	Oct. 31, 2025
11	RF cables2 (1GHz-40GHz)	ChengYu	966	003	Nov. 01, 2024	Oct. 31, 2025
12	Antenna connector	Florida RF Labs	N/A	RF 01#	Nov. 01, 2024	Oct. 31, 2025
13	Power probe	KEYSIGHT	U2021XA	MY55210018	Nov. 01, 2024	Oct. 31, 2025
14	Signal Analyzer 9kHz-26.5GHz	Agilent	N9020A	MY55370280	Nov. 01, 2024	Oct. 31, 2025
15	Test Receiver 20kHz-40GHz	R&S	ESU 40	100376	Nov. 01, 2024	Oct. 31, 2025
16	D.C. Power Supply	LongWei	PS-305D	010964729	Nov. 01, 2024	Oct. 31, 2025

#### Conduction Test equipment

Item	Equipment	Manufacturer	Type No.	Serial No.	Last calibration	Calibrated until
1	843 Shielded Room	YIHENG	843 Room	843	Nov. 05, 2023	Nov. 04, 2026
2	EMI Receiver	R&S	ESR	101421	Nov. 01, 2024	Oct. 31, 2025
3	LISN	R&S	ENV216	102417	Nov. 01, 2024	Oct. 31, 2025
4	843 Cable 1#	ChengYu	CE Cable	001	Nov. 01, 2024	Oct. 31, 2025

#### Other

Item	Name	Manufacturer	Model	Software version
1	EMC Conduction Test System	FALA	EZ_EMCC	EMC-CON 3A1.1
2	EMC radiation test system	FALA	EZ_EMCC	FA-03A2
3	RF test system	MAIWEI	MTS8310	2.0.0.0
4	RF communication test system	MAIWEI	MTS8200	2.0.0.0



#### 4. EMC EMISSION TEST

##### 4.1 CONDUCTED EMISSION MEASUREMENT

Test Requirement:	FCC Part15 C Section 15.207
Test Method:	ANSI C63.10:2013
Test Frequency Range:	150KHz to 30MHz
Receiver setup:	RBW=9KHz, VBW=30KHz, Sweep time=auto

##### 4.1.1 POWER LINE CONDUCTED EMISSION LIMITS

FREQUENCY (MHz)	Limit (dBuV)		Standard
	Quas -peak	Average	
0.15 -0.5	66 - 56 *	56 - 46 *	FCC
0.50 -5.0	56.00	46.00	FCC
5.0 -30.0	60.00	50.00	FCC

Note:

(1) \*Decreases with the logarithm of the frequency.

##### 4.1.2 TEST PROCEDURE

- The EUT was placed 0.8 meters from the horizontal ground plane with EUT being connected to the power mains through a line impedance stabilization network (LISN). All other support equipments powered from additional LISN(s). The LISN provide 50 Ohm/ 50uH of coupling impedance for the measuring instrument.
- Interconnecting cables that hang closer than 40 cm to the ground plane shall be folded back and forth in the center forming a bundle 30 to 40 cm long.
- I/O cables that are not connected to a peripheral shall be bundled in the center. The end of the cable may be terminated, if required, using the correct terminating impedance. The overall length shall not exceed 1 m.
- LISN at least 80 cm from nearest part of EUT chassis.
- For the actual test configuration, please refer to the related Item –EUT Test Photos.

##### 4.1.3 DEVIATION FROM TEST STANDARD

No deviation



#### 4.1.4 TEST SETUP

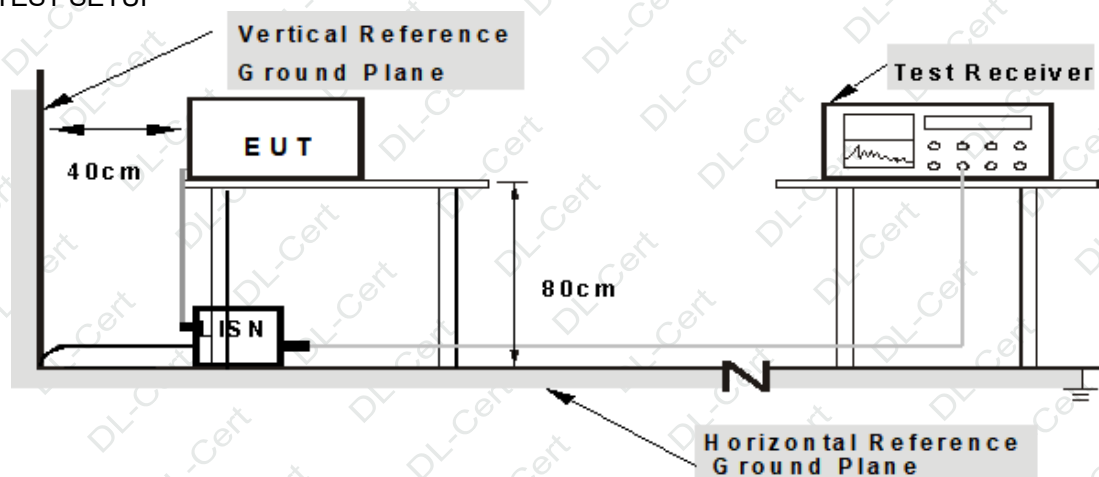

- Note:**
1. Support units were connected to second LISN.
  2. Both of LISNs (AMN) are 80 cm from EUT and at least 80 cm from other units and other metal planes

#### 4.1.5 EUT OPERATING CONDITIONS

The EUT was configured for testing in a typical fashion (as a customer would normally use it). The EUT has been programmed to continuously transmit during test. This operating condition was tested and used to collect the included data.



4.1.6 TEST RESULT

Temperature:	26°C	Relative Humidity:	54%
Pressure:	101 kPa	Polarization:	L
Test Voltage:	AC 120V/60Hz	Test Mode:	TX GFSK - 2402MHz

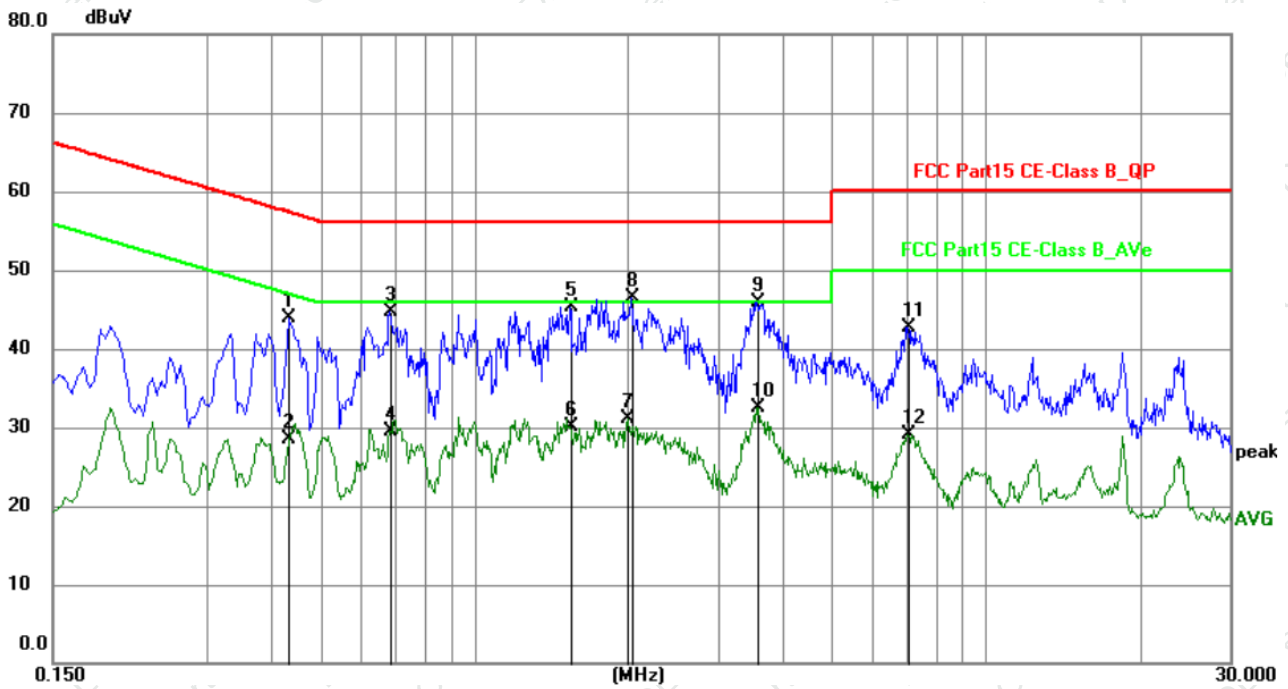

No.	Frequency (MHz)	Reading (dBuV)	Factor (dB)	Level (dBuV)	Limit (dBuV)	Margin (dB)	Detector	P/F	Remark
1	0.4335	23.55	20.32	43.87	57.19	-13.32	QP	P	
2	0.4351	8.26	20.32	28.58	47.15	-18.57	AVG	P	
3	0.6854	24.41	20.29	44.70	56.00	-11.30	QP	P	
4	0.6854	9.25	20.29	29.54	46.00	-16.46	AVG	P	
5	1.5404	25.01	20.30	45.31	56.00	-10.69	QP	P	
6	1.5404	9.77	20.30	30.07	46.00	-15.93	AVG	P	
7	1.9994	10.73	20.31	31.04	46.00	-14.96	AVG	P	
8	2.0264	26.17	20.31	46.48	56.00	-9.52	QP	P	
9	3.5655	25.61	20.34	45.95	56.00	-10.05	QP	P	
10	3.5655	12.15	20.34	32.49	46.00	-13.51	AVG	P	
11	7.0305	22.22	20.39	42.61	60.00	-17.39	QP	P	
12	7.0305	8.65	20.39	29.04	50.00	-20.96	AVG	P	

Notes:

1. An initial pre-scan was performed on the line and neutral lines with peak detector.
2. Quasi - Peak and Average measurement were performed at the frequencies with maximized peak emission.
3. Final Level = Reading level + Correct Factor.
4. Correct Factor = Lisen factor+ Cable loss factor + limiter factor.
5. Margin = Measurement Level-Limit.
6. The test data shows only the worst case TX GFSK - 2402MHz.



Temperature:	26°C	Relative Humidity:	54%
Pressure:	101 kPa	Polarization:	N
Test Voltage:	AC 120V/60Hz	Test Mode:	TX GFSK - 2402MHz

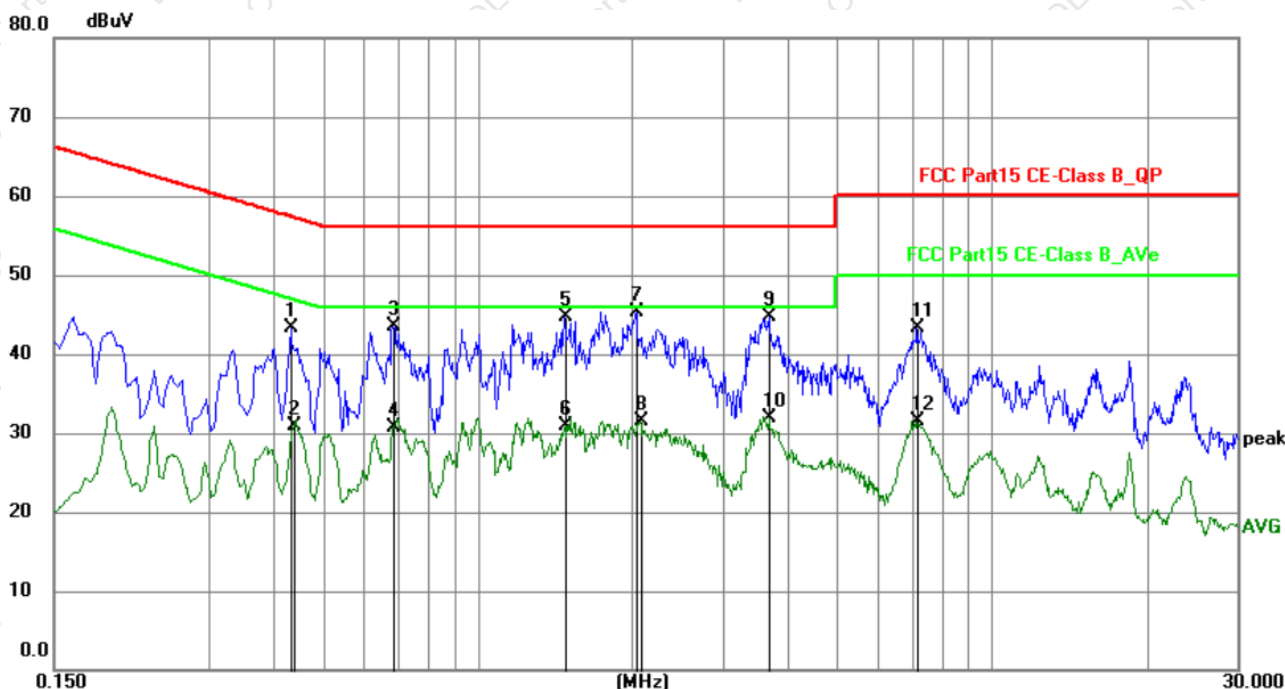

No.	Frequency (MHz)	Reading (dBuV)	Factor (dB)	Level (dBuV)	Limit (dBuV)	Margin (dB)	Detector	P/F	Remark
1	0.4334	22.89	20.32	43.21	57.19	-13.98	QP	P	
2	0.4396	10.66	20.31	30.97	47.07	-16.10	AVG	P	
3	0.6854	23.12	20.29	43.41	56.00	-12.59	QP	P	
4	0.6854	10.33	20.29	30.62	46.00	-15.38	AVG	P	
5	1.4774	24.42	20.31	44.73	56.00	-11.27	QP	P	
6	1.4818	10.61	20.31	30.92	46.00	-15.08	AVG	P	
7	2.0400	25.05	20.31	45.36	56.00	-10.64	QP	P	
8	2.0714	11.23	20.31	31.54	46.00	-14.46	AVG	P	
9	3.6825	24.28	20.34	44.62	56.00	-11.38	QP	P	
10	3.6825	11.66	20.34	32.00	46.00	-14.00	AVG	P	
11	7.1384	22.85	20.39	43.24	60.00	-16.76	QP	P	
12	7.1384	11.21	20.39	31.60	50.00	-18.40	AVG	P	

Notes:

1. An initial pre-scan was performed on the line and neutral lines with peak detector.
2. Quasi - Peak and Average measurement were performed at the frequencies with maximized peak emission.
3. Final Level = Reading level + Correct Factor.
4. Correct Factor = Lisen factor+ Cable loss factor + limiter factor.
5. Margin = Measurement Level-Limit.
6. The test data shows only the worst case TX GFSK - 2402MHz.



### 4.2 RADIATED EMISSION MEASUREMENT

Test Requirement:	FCC Part15 C Section 15.209				
Test Method:	ANSI C63.10:2013				
Test Frequency Range:	9kHz to 25GHz				
Test site:	Measurement Distance: 3m				
Receiver setup:	Frequency	Detector	RBW	VBW	Value
	9KHz-150KHz	Quasi-peak	200Hz	600Hz	Quasi-peak
	150KHz-30MHz	Quasi-peak	9KHz	30KHz	Quasi-peak
	30MHz-1GHz	Quasi-peak	120KHz	300KHz	Quasi-peak
	Above 1GHz	Peak	1MHz	3MHz	Peak
Peak		1MHz	10Hz	Average	

#### 4.2.1 RADIATED EMISSION LIMITS

Frequencies (MHz)	Field Strength (micровolts/meter)	Measurement Distance (meters)
0.009~0.490	2400/F(KHz)	300
0.490~1.705	24000/F(KHz)	30
1.705~30.0	30	30
30~88	100	3
88~216	150	3
216~960	200	3
Above 960	500	3

#### LIMITS OF RADIATED EMISSION MEASUREMENT

Frequency (MHz)	Limit (dBuV/m) (at 3M)	
	Peak	Average
Above 1000	74	54

Notes:

- (1) The limit for radiated test was performed according to FCC PART 15C.
- (2) The tighter limit applies at the band edges.
- (3) Emission level (dBuV/m)=20log Emission level (uV/m).



#### 4.2.2 TEST PROCEDURE

- a. The measuring distance of at 3 m shall be used for measurements at frequency up to 25GHz. For frequencies above 1GHz, any suitable measuring distance may be used.
- b. The EUT was placed on the top of a rotating table 0.8 meters above the ground at a 3 meter semi-chamber test. The table was rotated 360 degrees to determine the position of the highest radiation.
- c. The height of the equipment or of the substitution antenna shall be 0.8m; above 1GHz, the height was 1.5m, the height of the test antenna shall vary between 1 m to 4 m. Both horizontal and vertical polarizations of the antenna are set to make the measurement.
- d. The initial step in collecting conducted emission data is a spectrum analyzer peak detector mode pre-scanning the measurement frequency range. Significant peaks are then marked and then Quasi Peak detector mode re-measured.
- e. If the Peak Mode measured value compliance with and lower than Quasi Peak Mode Limit, the EUT shall be deemed to meet QP Limits and then no additional QP Mode measurement performed.
- f. For the actual test configuration, please refer to the related Item –EUT Test Photos.
- g. For the radiated emission test above 1GHz:  
Place the measurement antenna away from each area of the EUT determined to be a source of emissions at the specified measurement distance, while keeping the measurement antenna aimed at the source of emissions at each frequency of significant emissions, with polarization oriented for maximum response.  
The measurement antenna may have to be higher or lower than the EUT, depending on the radiation pattern of the emission and staying aimed at the emission source for receiving the maximum signal. The final measurement antenna elevation shall be that which maximizes the emissions. The measurement antenna elevation for maximum emissions shall be restricted to a range of heights of from 1 m to 4 m above the ground or reference ground plane.

Note:

Both horizontal and vertical antenna polarities were tested and performed pretest to three orthogonal axis. The worst case emissions were reported

#### 4.2.3 DEVIATION FROM TEST STANDARD

No deviation

#### 4.2.4 TEST SETUP

(A) Radiated Emission Test-Up Frequency Below 30MHz

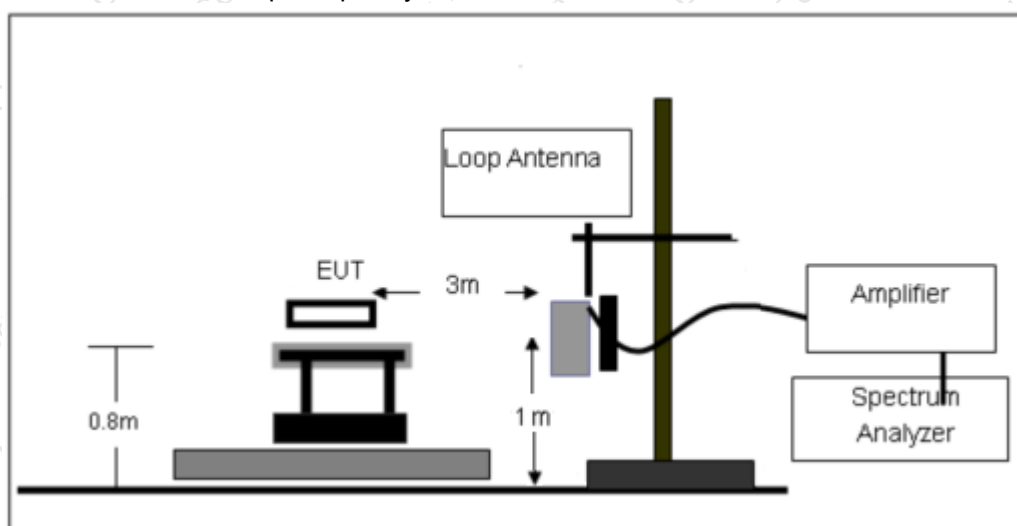



(B) Radiated Emission Test-Up Frequency 30MHz~1GHz

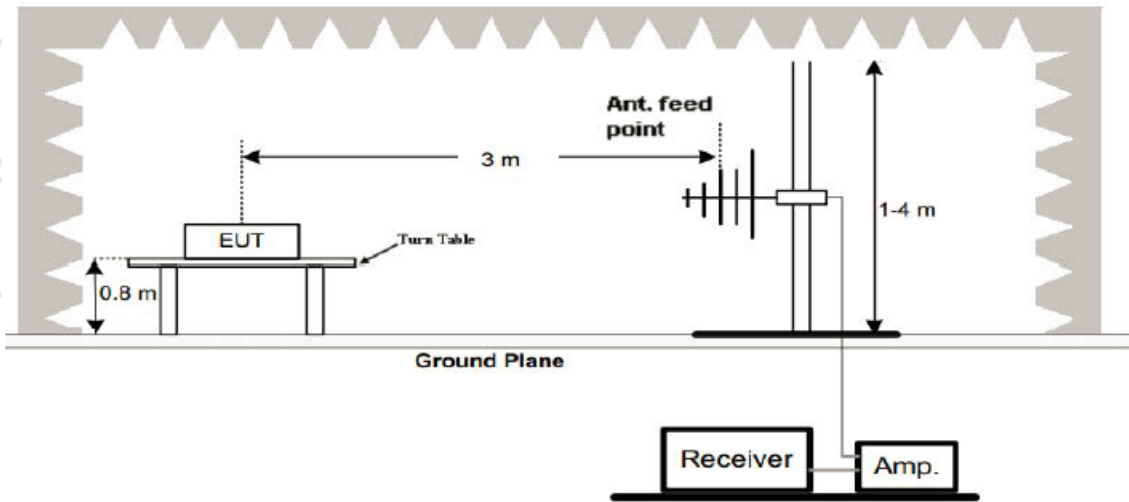

(C) Radiated Emission Test-Up Frequency Above 1GHz

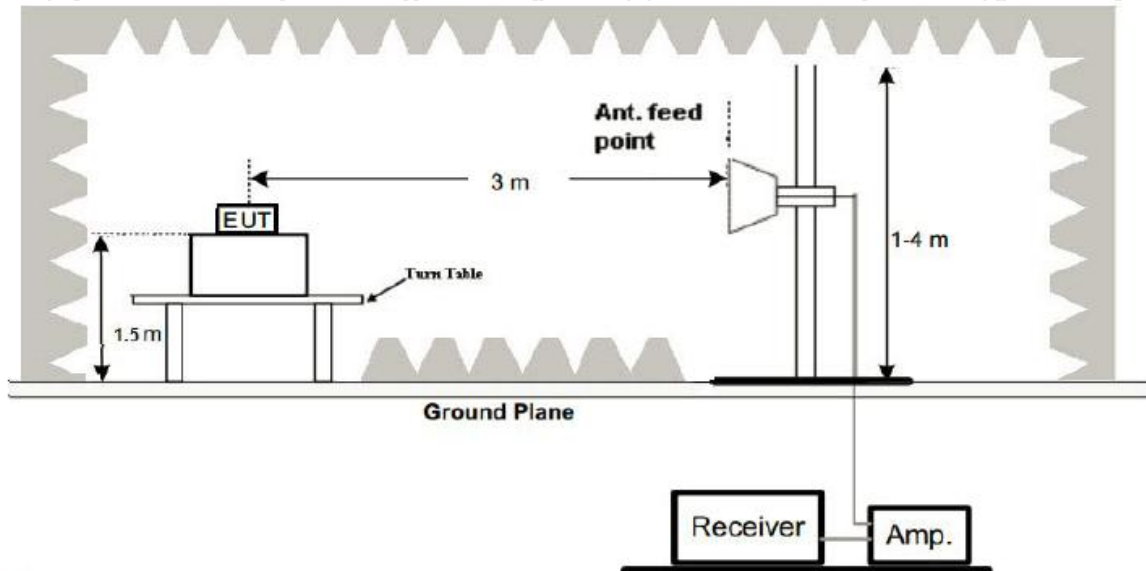

4.2.5 EUT OPERATING CONDITIONS

The EUT was configured for testing in a typical fashion (as a customer would normally use it). The EUT has been programmed to continuously transmit during test. This operating condition was tested and used to collect the included data.

4.2.6 TEST RESULTS

a, Between 9KHz – 30 MHz

The emission from 9 kHz to 30MHz was pre-tested and found the result was 20dB lower than the limit, and according to 15.31(o) & RSS-Gen 6.13, the test result no need to reported.



b. Between 30MHz – 1GHz

Temperature:	26°C	Relative Humidity:	54%
Pressure:	101 kPa	Polarization:	Horizontal
Test Voltage:	DC 3.7V	Test Mode :	TX GFSK - 2402MHz

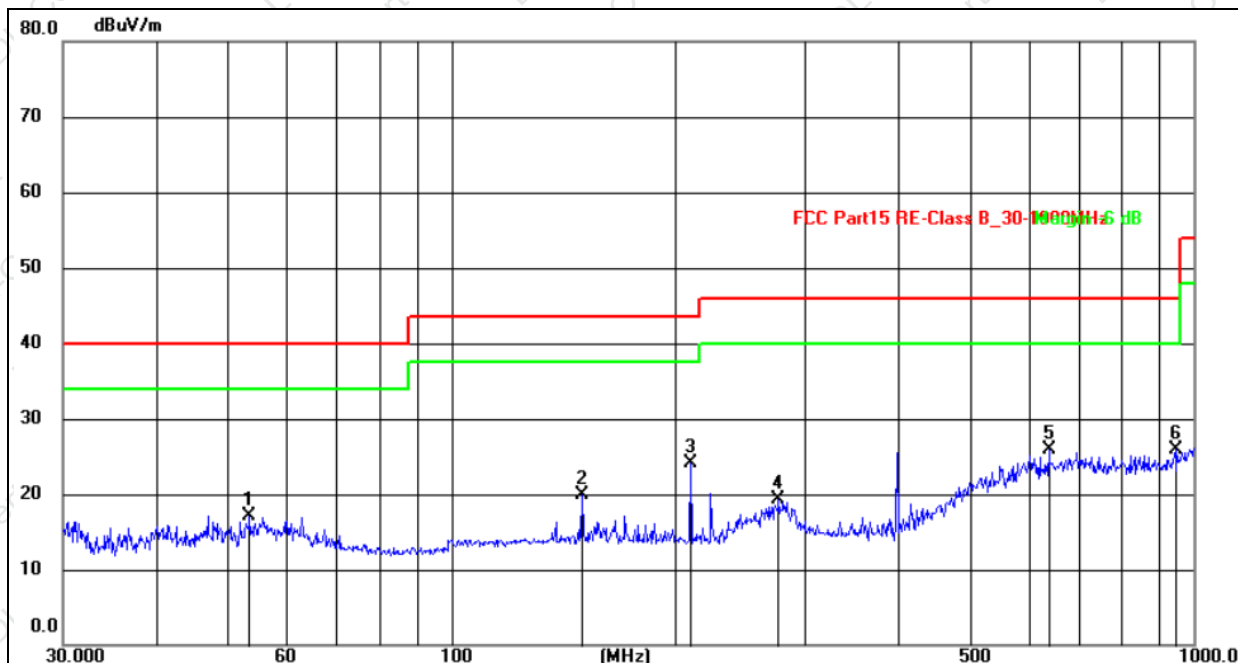

No.	Frequency (MHz)	Reading (dBuV)	Factor (dB/m)	Level (dBuV/m)	Limit (dBuV/m)	Margin (dB)	Detector
1	53.5052	31.02	-14.00	17.02	40.00	-22.98	QP
2	150.0107	36.31	-16.35	19.96	43.50	-23.54	QP
3	210.0481	42.08	-17.98	24.10	43.50	-19.40	QP
4	276.1234	33.55	-14.17	19.38	46.00	-26.62	QP
5	638.3686	33.52	-7.64	25.88	46.00	-20.12	QP
6	945.4400	31.56	-5.72	25.84	46.00	-20.16	QP

Remarks:

1. An initial pre-scan was performed on the peak detector.
2. Quasi - Peak measurement were performed at the frequencies with maximized peak emission.
3. The emission levels of other frequencies are very lower than the limit and not show in test report.
4. Final Level = Reading level + Correct Factor.
5. Correct Factor = Antenna factor+ Cable loss factor - Amplifier factor.
6. Margin = Measurement Level-Limit.
7. The test data shows only the worst case TX GFSK - 2402MHz.



Temperature:	26°C	Relative Humidity:	54%
Pressure:	101kPa	Polarization:	Vertical
Test Voltage:	DC 3.7V	Test Mode :	TX GFSK - 2402MHz

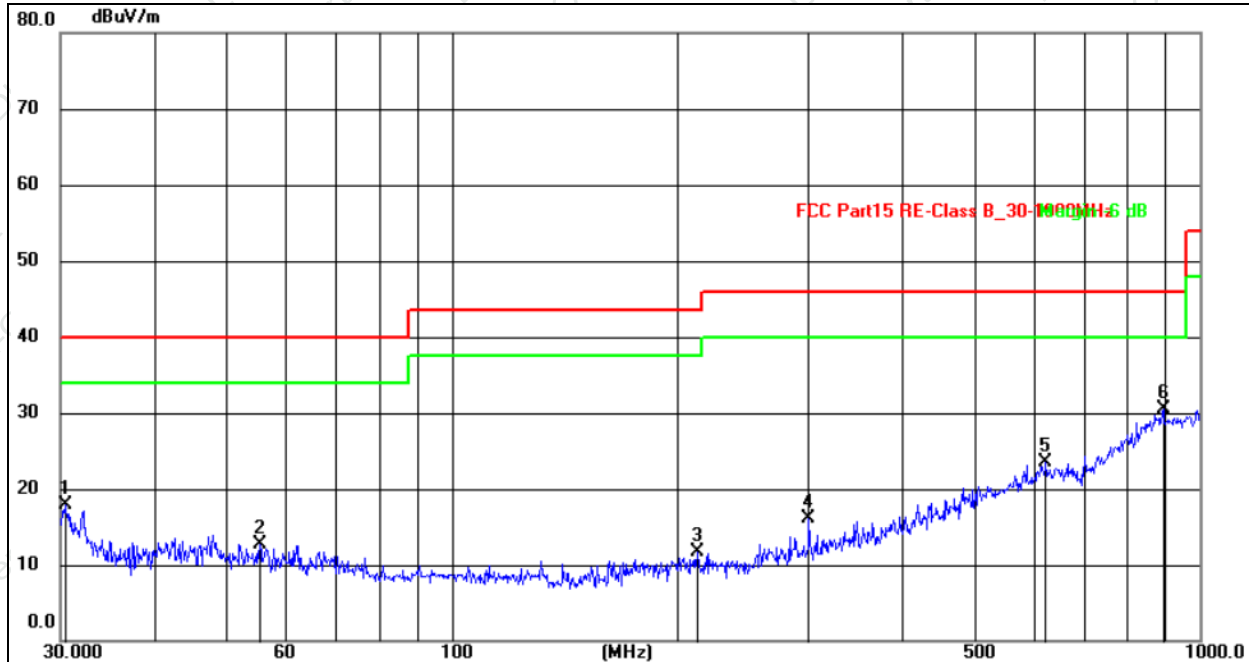

No.	Frequency (MHz)	Reading (dBuV)	Factor (dB/m)	Level (dBuV/m)	Limit (dBuV/m)	Margin (dB)	Detector
1	30.4237	36.10	-18.27	17.83	40.00	-22.17	QP
2	55.4147	30.45	-17.74	12.71	40.00	-27.29	QP
3	213.0149	31.91	-20.18	11.73	43.50	-31.77	QP
4	300.3672	33.95	-17.89	16.06	46.00	-29.94	QP
5	622.8900	30.76	-7.34	23.42	46.00	-22.58	QP
6	893.8564	31.20	-0.61	30.59	46.00	-15.41	QP

Remarks:

1. An initial pre-scan was performed on the peak detector.
2. Quasi - Peak measurement were performed at the frequencies with maximized peak emission.
3. The emission levels of other frequencies are very lower than the limit and not show in test report.
4. Final Level = Reading level + Correct Factor.
5. Correct Factor= Antenna factor+ Cable loss factor - Amplifier factor.
6. Margin= Measurement Level-Limit.
7. The test data shows only the worst case TX GFSK - 2402MHz.



1GHz~25GHz

Polar (H/V)	Frequency	Meter Reading	Pre-amplifier	Cable Loss	Antenna Factor	Emission Level	Limits	Margin	Detector Type
	(MHz)	(dBuV)	(dB)	(dB)	(dB)	(dBuV/m)	(dBuV/m)	(dB)	
Low Channel:2402MHz									
V	4804.00	54.55	30.55	5.77	24.66	54.43	74.00	-19.57	PK
V	4804.00	43.57	30.55	5.77	24.66	43.45	54.00	-10.55	AV
V	7206.00	53.84	30.33	6.32	24.55	54.38	74.00	-19.62	PK
V	7206.00	43.50	30.33	6.32	24.55	44.04	54.00	-9.96	AV
V	9608.00	54.83	30.85	7.45	24.69	56.12	74.00	-17.88	PK
V	9608.00	43.85	30.85	7.45	24.69	45.14	54.00	-8.86	AV
V	12010.00	53.60	31.02	8.99	25.57	57.14	74.00	-16.86	PK
V	12010.00	43.32	31.02	8.99	25.57	46.86	54.00	-7.14	AV
H	4804.00	51.08	30.55	5.77	24.66	50.96	74.00	-23.04	PK
H	4804.00	43.25	30.55	5.77	24.66	43.13	54.00	-10.87	AV
H	7206.00	53.60	30.33	6.32	24.55	54.14	74.00	-19.86	PK
H	7206.00	43.96	30.33	6.32	24.55	44.50	54.00	-9.50	AV
H	9608.00	50.68	30.85	7.45	24.69	51.97	74.00	-22.03	PK
H	9608.00	43.86	30.85	7.45	24.69	45.15	54.00	-8.85	AV
H	12010.00	51.31	31.02	8.99	25.57	54.85	74.00	-19.15	PK
H	12010.00	43.29	31.02	8.99	25.57	46.83	54.00	-7.17	AV

Polar (H/V)	Frequency	Meter Reading	Pre-amplifier	Cable Loss	Antenna Factor	Emission Level	Limits	Margin	Detector Type
	(MHz)	(dBuV)	(dB)	(dB)	(dB)	(dBuV/m)	(dBuV/m)	(dB)	
Middle Channel:2440MHz									
V	4880.00	53.03	30.55	5.77	24.66	52.91	74.00	-21.09	PK
V	4880.00	43.09	30.55	5.77	24.66	42.97	54.00	-11.03	AV
V	7320.00	53.53	30.33	6.32	24.55	54.07	74.00	-19.93	PK
V	7320.00	43.27	30.33	6.32	24.55	43.81	54.00	-10.19	AV
V	9760.00	51.56	30.85	7.45	24.69	52.85	74.00	-21.15	PK
V	9760.00	43.22	30.85	7.45	24.69	44.51	54.00	-9.49	AV
V	12200.00	51.03	31.02	8.99	25.57	54.57	74.00	-19.43	PK
V	12200.00	43.42	31.02	8.99	25.57	46.96	54.00	-7.04	AV
H	4880.00	50.88	30.55	5.77	24.66	50.76	74.00	-23.24	PK
H	4880.00	43.81	30.55	5.77	24.66	43.69	54.00	-10.31	AV
H	7320.00	54.01	30.33	6.32	24.55	54.55	74.00	-19.45	PK
H	7320.00	43.81	30.33	6.32	24.55	44.35	54.00	-9.65	AV
H	9760.00	53.07	30.85	7.45	24.69	54.36	74.00	-19.64	PK
H	9760.00	43.41	30.85	7.45	24.69	44.70	54.00	-9.30	AV
H	12200.00	50.81	31.02	8.99	25.57	54.35	74.00	-19.65	PK
H	12200.00	43.89	31.02	8.99	25.57	47.43	54.00	-6.57	AV



Polar (H/V)	Frequency	Meter Reading	Pre-amplifier	Cable Loss	Antenna Factor	Emission Level	Limits	Margin	Detector Type
	(MHz)	(dBuV)	(dB)	(dB)	(dB)	(dBuV/m)	(dBuV/m)	(dB)	
High Channel:2480MHz									
V	4960.00	50.28	30.55	5.77	24.66	50.16	74.00	-23.84	PK
V	4960.00	43.72	30.55	5.77	24.66	43.60	54.00	-10.40	AV
V	7440.00	53.13	30.33	6.32	24.55	53.67	74.00	-20.33	PK
V	7440.00	43.96	30.33	6.32	24.55	44.50	54.00	-9.50	AV
V	9920.00	51.80	30.85	7.45	24.69	53.09	74.00	-20.91	PK
V	9920.00	43.96	30.85	7.45	24.69	45.25	54.00	-8.75	AV
V	12400.00	53.82	31.02	8.99	25.57	57.36	74.00	-16.64	PK
V	12400.00	43.58	31.02	8.99	25.57	47.12	54.00	-6.88	AV
H	4960.00	54.24	30.55	5.77	24.66	54.12	74.00	-19.88	PK
H	4960.00	43.51	30.55	5.77	24.66	43.39	54.00	-10.61	AV
H	7440.00	51.18	30.33	6.32	24.55	51.72	74.00	-22.28	PK
H	7440.00	43.58	30.33	6.32	24.55	44.12	54.00	-9.88	AV
H	9920.00	50.37	30.85	7.45	24.69	51.66	74.00	-22.34	PK
H	9920.00	43.52	30.85	7.45	24.69	44.81	54.00	-9.19	AV
H	12400.00	52.90	31.02	8.99	25.57	56.44	74.00	-17.56	PK
H	12400.00	43.94	31.02	8.99	25.57	47.48	54.00	-6.52	AV

**Remark:**

1. Emission Level = Meter Reading + Antenna Factor + Cable Loss – Pre-amplifier, Margin= Emission Level - Limit
2. If peak below the average limit, the average emission was no test.
3. The amplitude of spurious emissions which are attenuated by more than 20dB below the permissible value has no need to be reported.



## 5. RADIATED BAND EMISSION MEASUREMENT

### 5.1 TEST REQUIREMENT

Test Requirement:	FCC Part15 C Section 15.209 and 15.205				
Test Method:	ANSI C63.10: 2013				
Test Frequency Range:	All of the restrict bands were tested, only the worst band's (2310MHz to 2500MHz) data was showed.				
Test site:	Measurement Distance: 3m				
Receiver setup:	Frequency	Detector	RBW	VBW	Value
	Above 1GHz	Peak	1MHz	3MHz	Peak
		Average	1MHz	3MHz	Average

### LIMITS OF RADIATED EMISSION MEASUREMENT (Above 1000MHz)

Frequency (MHz)	Limit (dBuV/m) (at 3M)	
	Peak	Average
Above 1000	74	54

#### Notes:

- (1) The limit for radiated test was performed according to FCC PART 15C.
- (2) The tighter limit applies at the band edges.
- (3) Emission level (dBuV/m)=20log Emission level (uV/m).

Spectrum Parameter	Setting
Attenuation	Auto
Start Frequency	2310MHz
Stop Frequency	2500MHz
RB / VB (emission in restricted band)	1 MHz / 3 MHz for Peak, 1 MHz / 3MHz for Average

### 5.2 TEST PROCEDURE

Above 1GHz test procedure as below:

- a. 1. The EUT was placed on the top of a rotating table 1.5 meters above the ground at a 3 meter camber. The table was rotated 360 degrees to determine the position of the highest radiation.
- b. The EUT was set 3 meters away from the interference-receiving antenna, which was mounted on the top of a variable-height antenna tower.
- c. The antenna height is varied from one meter to four meters above the ground to determine the maximum value of the field strength. Both horizontal and vertical polarizations of the antenna are set to make the measurement.
- d. For each suspected emission, the EUT was arranged to its worst case and then the antenna was tuned to heights from 1 meter to 4 meters and the rota table was turned from 0 degrees to 360 degrees to find the maximum reading.
- e. The test-receiver system was set to Peak Detect Function and Specified Bandwidth with Maximum Hold Mode.
- f. If the emission level of the EUT in peak mode was 10dB lower than the limit specified, then testing could be stopped and the peak values of the EUT would be reported. Otherwise the emissions that did not have 10dB margin would be re-tested one by one using peak, quasi-peak or average method as specified and then reported in a data sheet.



g. Test the EUT in the lowest channel, the highest channel

Note:

Both horizontal and vertical antenna polarities were tested and performed pretest to three orthogonal axes. The worst case emissions were reported.

### 5.3 DEVIATION FROM TEST STANDARD

No deviation

### 5.4 TEST SETUP

Radiated Emission Test-Up Frequency Above 1GHz

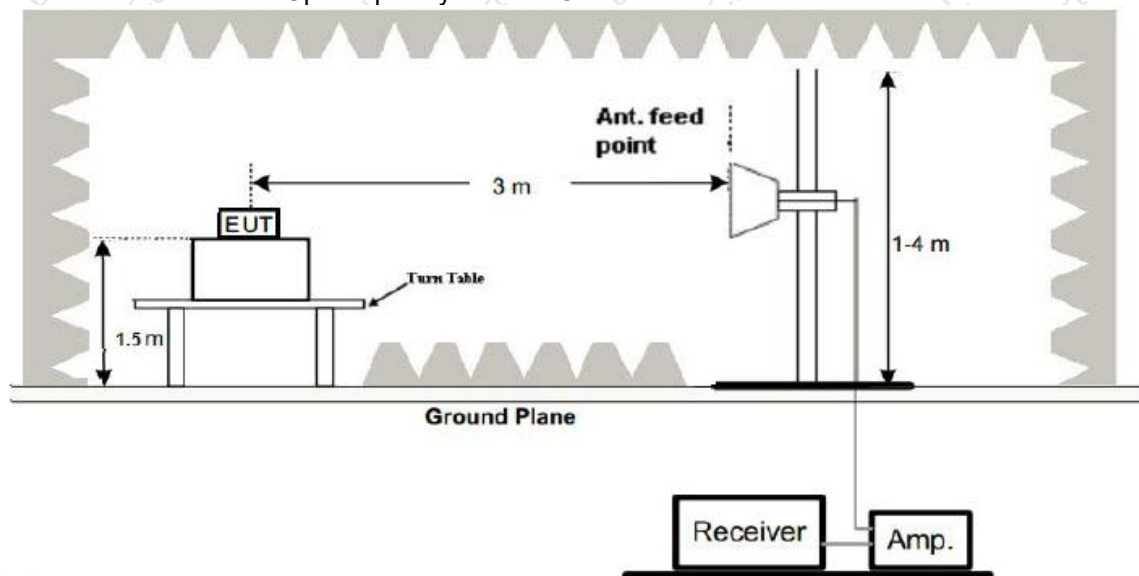

### 5.5 EUT OPERATING CONDITIONS

The EUT was configured for testing in a typical fashion (as a customer would normally use it). The EUT has been programmed to continuously transmit during test. This operating condition was tested and used to collect the included data.



5.6 TEST RESULT

	Polar (H/V)	Frequency (MHz)	Meter Reading (dBUV)	Pre-amplifier (dB)	Cable Loss (dB)	Antenna Factor (dB/m)	Emission level (dBUV/m)	Limit (dBU V/m)	Margin (dB)	Detect or Type	Result
GFSK	Low Channel: 2402MHz										
	H	2310.00	54.52	30.22	4.85	23.98	53.13	74.00	-20.87	PK	PASS
	H	2310.00	44.52	30.22	4.85	23.98	43.13	54.00	-10.87	AV	PASS
	H	2350.00	54.06	30.22	4.85	23.98	52.67	74.00	-21.33	PK	PASS
	H	2350.00	44.72	30.22	4.85	23.98	43.33	54.00	-10.67	AV	PASS
	H	2390.00	53.14	30.22	4.85	23.98	51.75	74.00	-22.25	PK	PASS
	H	2390.00	44.41	30.22	4.85	23.98	43.02	54.00	-10.98	AV	PASS
	V	2310.00	53.46	30.22	4.85	23.98	52.07	74.00	-21.93	PK	PASS
	V	2310.00	44.27	30.22	4.85	23.98	42.88	54.00	-11.12	AV	PASS
	V	2350.00	53.07	30.22	4.85	23.98	51.68	74.00	-22.32	PK	PASS
	V	2350.00	44.25	30.22	4.85	23.98	42.86	54.00	-11.14	AV	PASS
	V	2390.00	53.95	30.22	4.85	23.98	52.56	74.00	-21.44	PK	PASS
	V	2390.00	44.12	30.22	4.85	23.98	42.73	54.00	-11.27	AV	PASS
	High Channel: 2480MHz										
	H	2483.50	53.85	30.22	4.85	23.98	52.46	74.00	-21.54	PK	PASS
	H	2483.50	44.19	30.22	4.85	23.98	42.80	54.00	-11.20	AV	PASS
	H	2490.00	54.43	30.22	4.85	23.98	53.04	74.00	-20.96	PK	PASS
	H	2490.00	44.75	30.22	4.85	23.98	43.36	54.00	-10.64	AV	PASS
	H	2500.00	53.86	30.22	4.85	23.98	52.47	74.00	-21.53	PK	PASS
	H	2500.00	44.00	30.22	4.85	23.98	42.61	54.00	-11.39	AV	PASS
	V	2483.50	54.87	30.22	4.85	23.98	53.48	74.00	-20.52	PK	PASS
	V	2483.50	44.03	30.22	4.85	23.98	42.64	54.00	-11.36	AV	PASS
	V	2490.00	53.48	30.22	4.85	23.98	52.09	74.00	-21.91	PK	PASS
	V	2490.00	44.24	30.22	4.85	23.98	42.85	54.00	-11.15	AV	PASS
V	2500.00	54.56	30.22	4.85	23.98	53.17	74.00	-20.83	PK	PASS	
V	2500.00	44.97	30.22	4.85	23.98	43.58	54.00	-10.42	AV	PASS	

Remark:

1. Emission Level = Meter Reading + Antenna Factor + Cable Loss – Pre-amplifier, Margin= Emission Level - Limit.





## 6. POWER SPECTRAL DENSITY TEST

Test Requirement:	FCC Part15 C Section 15.247 (e)
Test Method:	KDB558074 D01 15.247 Meas Guidance v05r02

### 6.1 APPLIED PROCEDURES / LIMIT

FCC Part15 (15.247) , Subpart C				
Section	Test Item	Limit	Frequency Range (MHz)	Result
15.247 (e)	Power Spectral Density	8dBm/3kHz	2400-2483.5	PASS

### 6.2 TEST PROCEDURE

1. Set analyzer center frequency to DTS channel center frequency.
2. Set the span to 1.5 times the DTS bandwidth.
3. Set the RBW to:  $3 \text{ kHz} \leq \text{RBW} \leq 100 \text{ kHz}$ .
4. Set the VBW  $\geq 3 \times \text{RBW}$ .
5. Detector = peak.
6. Sweep time = auto couple.
7. Trace mode = max hold.
8. Allow trace to fully stabilize.
9. Use the peak marker function to determine the maximum amplitude level within the RBW.
10. If measured value exceeds limit, reduce RBW (no less than 3 kHz) and repeat.

### 6.3 DEVIATION FROM STANDARD

No deviation.

### 6.4 TEST SETUP

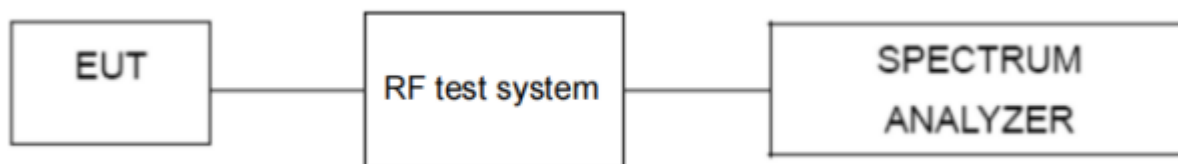

### 6.5 EUT OPERATION CONDITIONS

The EUT tested system was configured as the statements of chapter 3, Unless otherwise a special operating condition is specified in the follows during the testing.



## 6.6 TEST RESULT

Temperature :	26°C	Relative Humidity :	54%
Pressure:	101kPa	Test Voltage:	DC 3.7V

Test Mode	Frequency (MHz)	Power Spectral Density (dBm/3kHz)	Limit (dBm/3kHz)	Result
GFSK	2402	-14.326	8	PASS
	2440	-14.957	8	PASS
	2480	-15.976	8	PASS



CH01

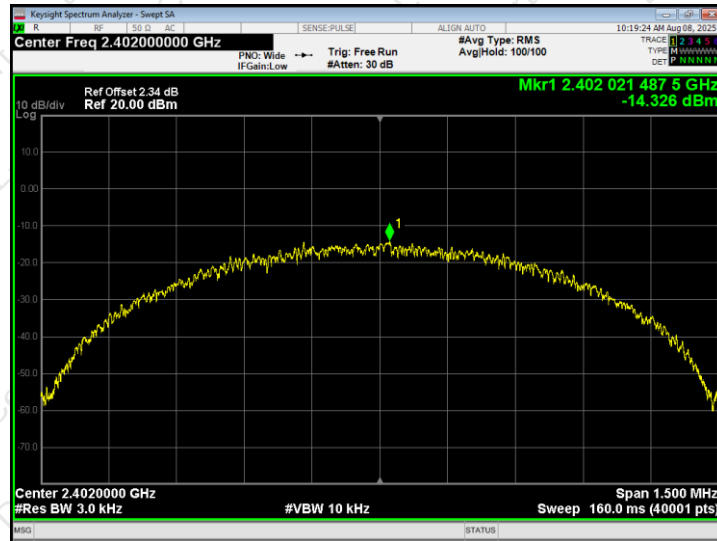

CH20

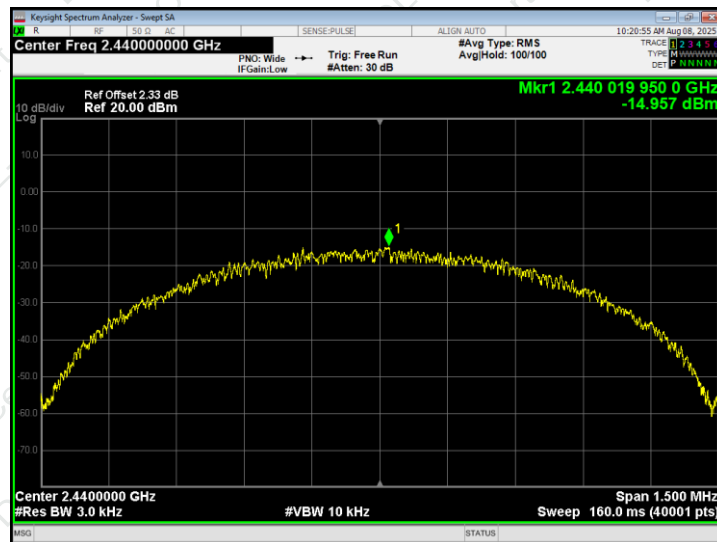

CH40

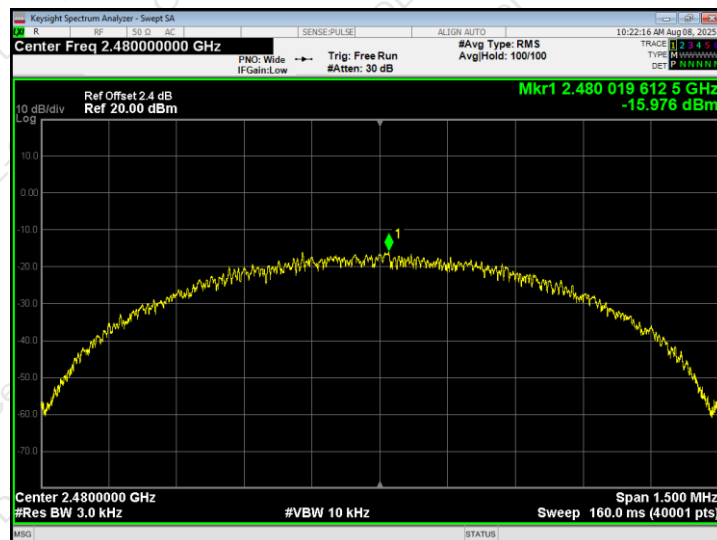



## 7. 6DB OCCUPIED BANDWIDTH

Test Requirement:	FCC Part15 C Section 15.247 (a)(2)
Test Method:	KDB558074 D01 15.247 Meas Guidance v05r02

### 7.1 APPLIED PROCEDURES / LIMIT

FCC Part15 (15.247) , Subpart C				
Section	Test Item	Limit	Frequency Range	Result
15.247(a)(2)	Bandwidth	$\geq 500\text{kHz}$ (6dB Occupied Bandwidth)	2400-2483.5 (MHz)	PASS

### 7.2 TEST PROCEDURE

1. Set RBW = 100 kHz.
2. Set the video bandwidth (VBW)  $\geq 3 \times$  RBW.
3. Detector = Peak.
4. Trace mode = max hold.
5. Sweep = auto couple.
6. Allow the trace to stabilize.
7. Measure the maximum width of the emission that is constrained by the frequencies associated with the two outermost amplitude points (upper and lower frequencies) that are attenuated by 6 dB relative to the maximum level measured in the fundamental emission.

### 7.3 DEVIATION FROM STANDARD

No deviation.

### 7.4 TEST SETUP

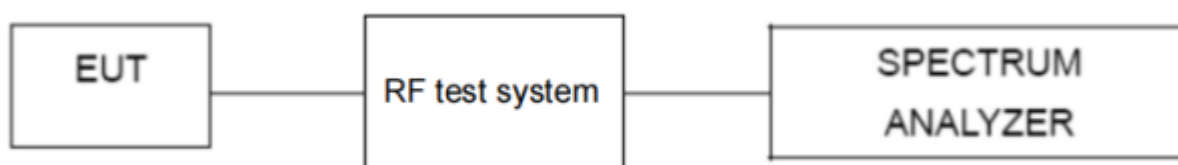

### 7.5 EUT OPERATION CONDITIONS

The EUT tested system was configured as the statements of chapter 3, Unless otherwise a special operating condition is specified in the follows during the testing.



## 7.6 TEST RESULT

Temperature :	26°C	Relative Humidity :	54%
Pressure:	101kPa	Test Voltage:	DC 3.7V

Test Mode	Frequency (MHz)	6dB Occupied Bandwidth (MHz)	Limit (kHz)	Result
GFSK	2402	0.7030	>500	Pass
	2440	0.6604		
	2480	0.6549		



CH 01

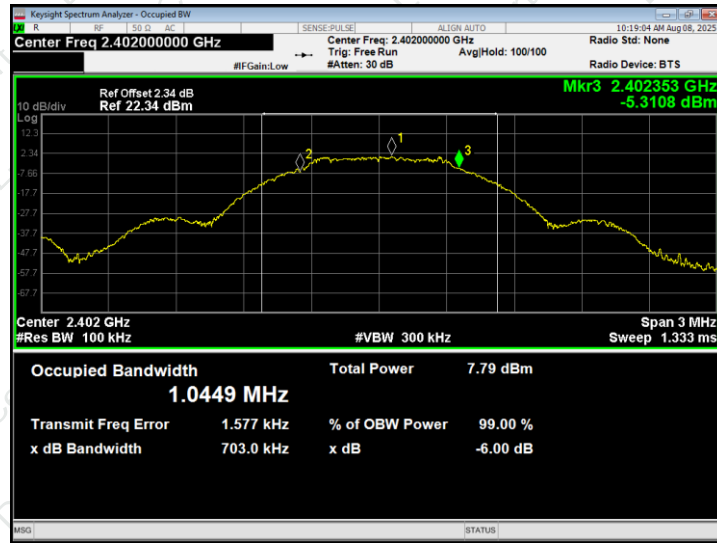

CH20

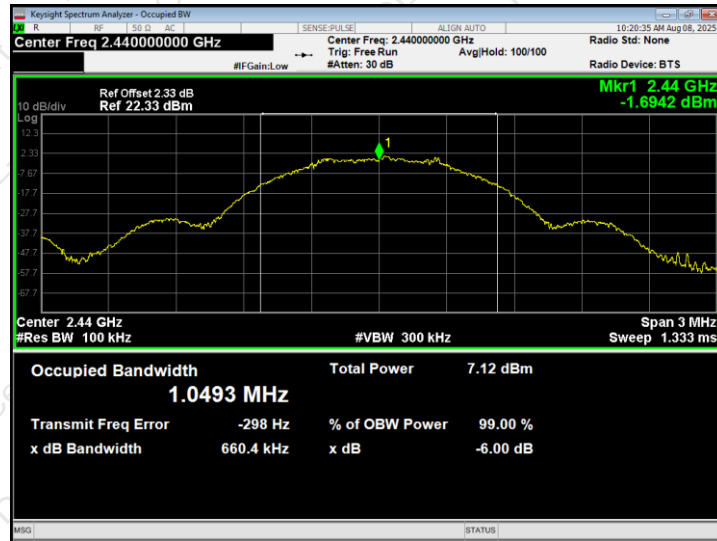

CH40

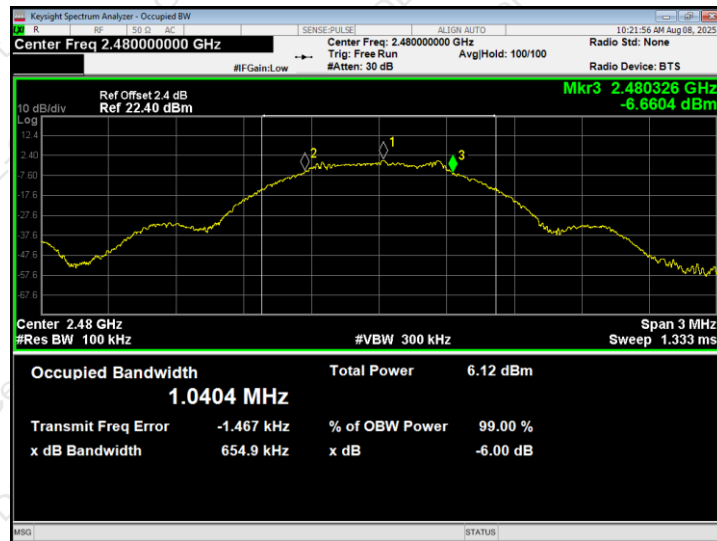



## 8. PEAK OUTPUT POWER TEST

Test Requirement:	FCC Part15 C Section 15.247 (b)(3)
Test Method:	KDB558074 D01 15.247 Meas Guidance v05r02

### 8.1 APPLIED PROCEDURES / LIMIT

FCC Part15 (15.247) , Subpart C				
Section	Test Item	Limit	Frequency Range	Result
15.247(b)(3)	Peak Output Power	1 watt or 30dBm	2400-2483.5 (MHz)	PASS

### 8.2 TEST PROCEDURE

- a. The EUT was directly connected to the Power meter

### 8.3 DEVIATION FROM STANDARD

No deviation.

### 8.4 TEST SETUP



### 8.5 EUT OPERATION CONDITIONS

The EUT tested system was configured as the statements of chapter 3, Unless otherwise a special operating condition is specified in the follows during the testing.



## 8.6 TEST RESULT

Temperature :	26°C	Relative Humidity :	54%
Pressure:	101kPa	Test Voltage:	DC 3.7V

Test Mode	Test Frequency (MHz)	Peak Output Power (dBm)	Limit (dBm)	Result
GFSK	2402	1.633	30.00	Pass
	2440	1.204		
	2480	0.129		





## 9. CONDUCTED BAND EDGE AND SPURIOUS EMISSION

Test Requirement:	FCC Part15 C Section 15.247 (d)
Test Method:	KDB558074 D01 15.247 Meas Guidance v05r02

### 9.1 APPLICABLE STANDARD

Typical regulatory requirements specify that in any 100 kHz bandwidth outside of the authorized frequency band, the power shall be attenuated according to the following conditions<sup>89</sup>:

The maximum peak conducted output power procedure was used to determine compliance as described in 11.9.1, then the peak output power measured in any 100 kHz bandwidth outside of the authorized frequency band shall be attenuated by at least 20 dB relative to the maximum in-band peak PSD level in 100 kHz (i.e., 20 dBc).

### 9.2 TEST PROCEDURE

A. Reference level measurement, establish a reference level by using the following procedure:

- a) Set instrument center frequency to DTS channel center frequency.
- b) Set the span to  $\geq 1.5$  times the DTS bandwidth.
- c) Set the RBW = 100 kHz.
- d) Set the VBW  $\geq [3 \times \text{RBW}]$ .
- e) Detector = peak.
- f) Sweep time = auto couple.
- g) Trace mode = max hold.
- h) Allow trace to fully stabilize.
- i) Use the peak marker function to determine the maximum PSD level.

Note that the channel found to contain the maximum PSD level can be used to establish the reference level.

B. Emission level measurement, establish an emission level by using the following procedure:

- a) Set the center frequency and span to encompass frequency range to be measured.
- b) Set the RBW = 100 kHz.
- c) Set the VBW  $\geq [3 \times \text{RBW}]$ .
- d) Detector = peak.
- e) Sweep time = auto couple.
- f) Trace mode = max hold.
- g) Allow trace to fully stabilize.
- h) Use the peak marker function to determine the maximum amplitude level.

Ensure that the amplitude of all unwanted emissions outside of the authorized frequency band (excluding restricted frequency bands) is attenuated by at least the minimum requirements specified in 11.11. Report the three highest emissions relative to the limit.



### 9.3 DEVIATION FROM STANDARD

No deviation.

### 9.4 TEST SETUP

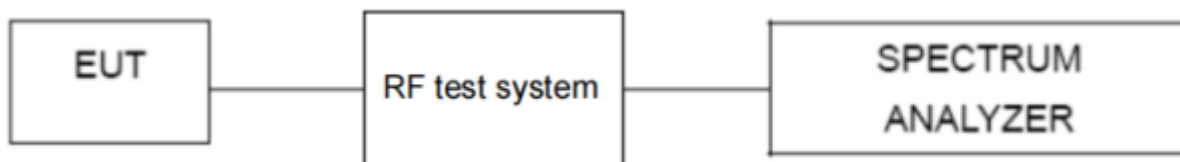

### 9.5 EUT OPERATION CONDITIONS

The EUT tested system was configured as the statements of chapter 3, Unless otherwise a special operating condition is specified in the follows during the testing.



9.6 TEST RESULTS

Temperature :	26°C	Relative Humidity :	54%
Pressure:	101kPa	Test Voltage:	DC 3.7V

Band Edge, Left Side

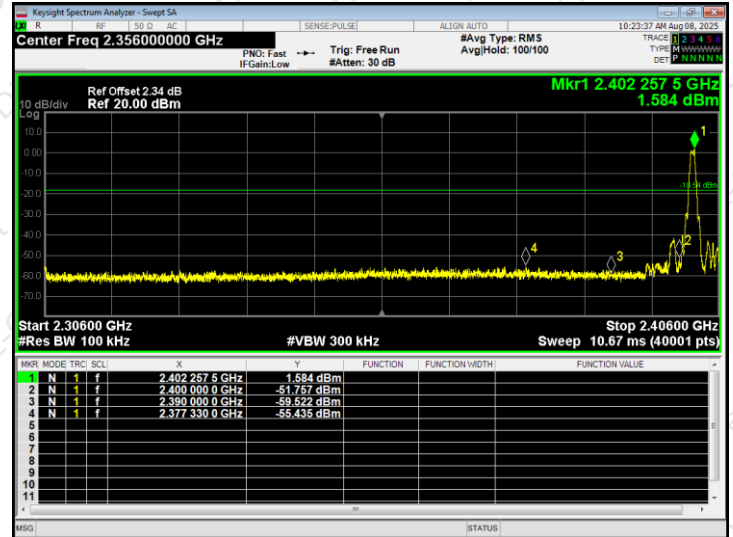
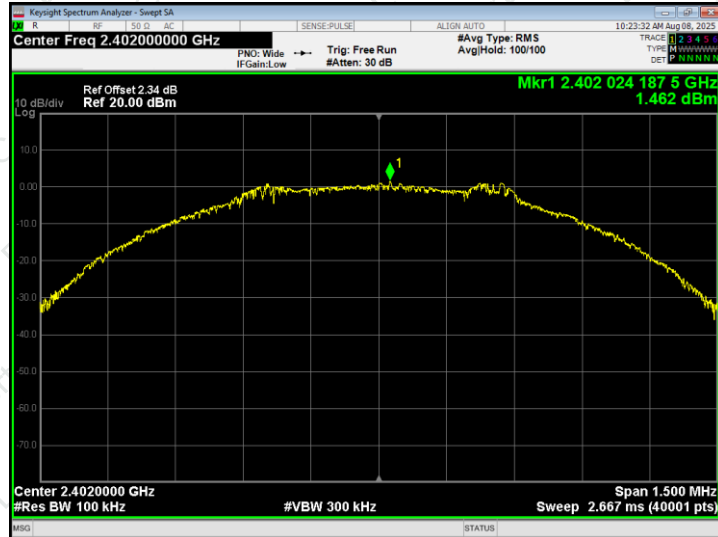

Band Edge, Right Side

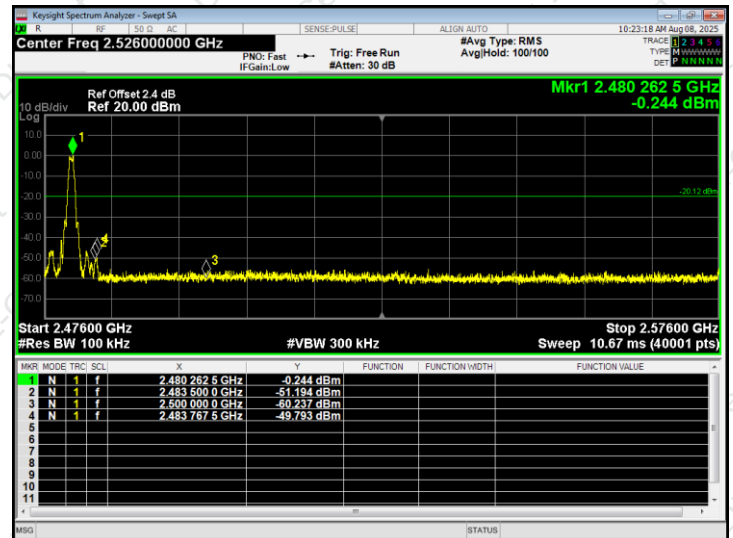
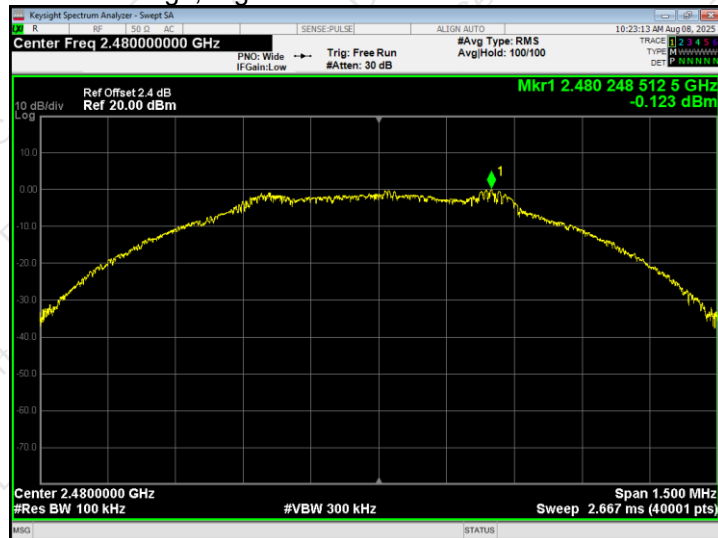



Lowest channel

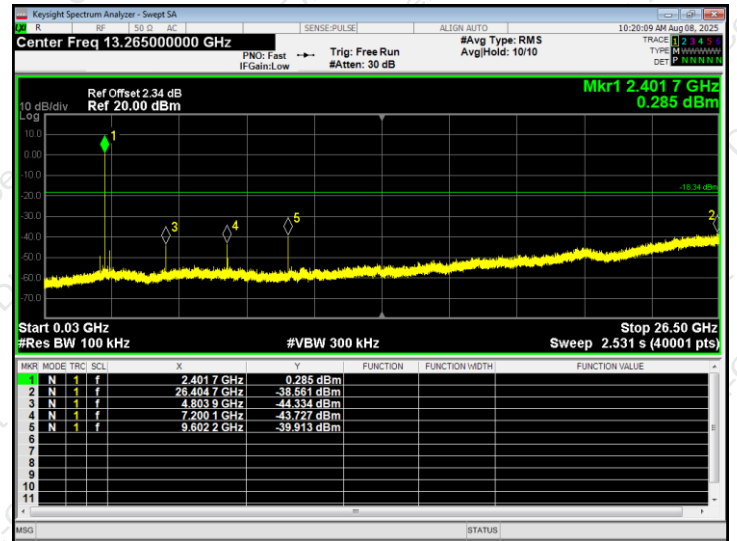
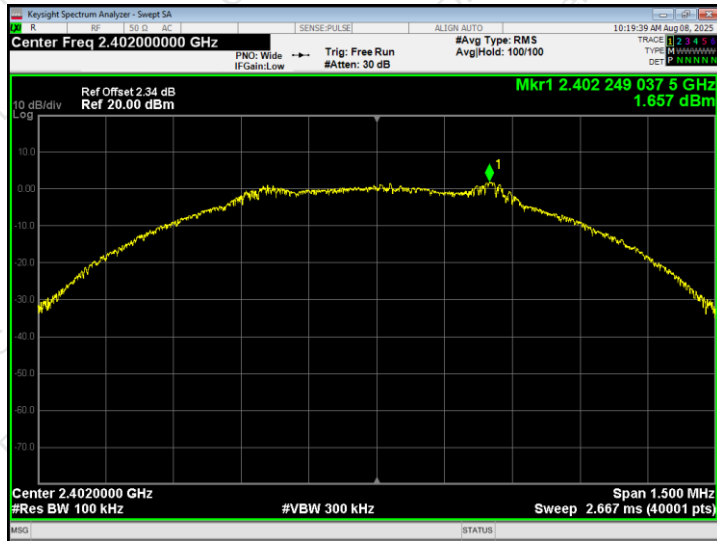

Middle channel

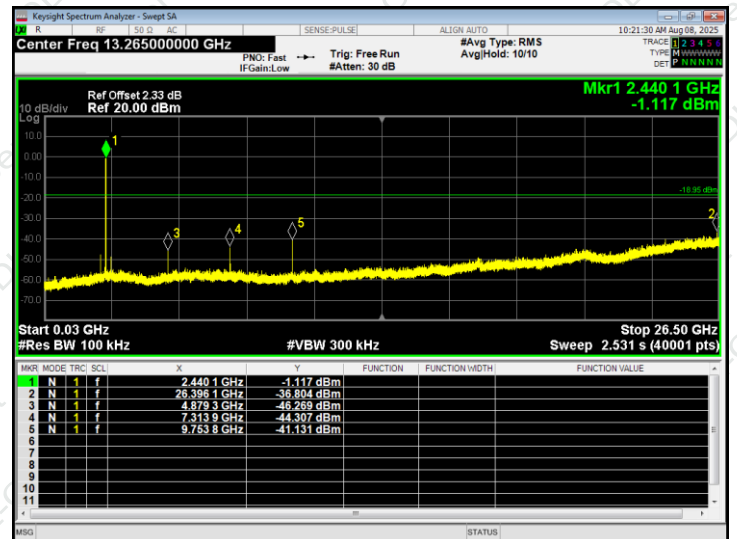
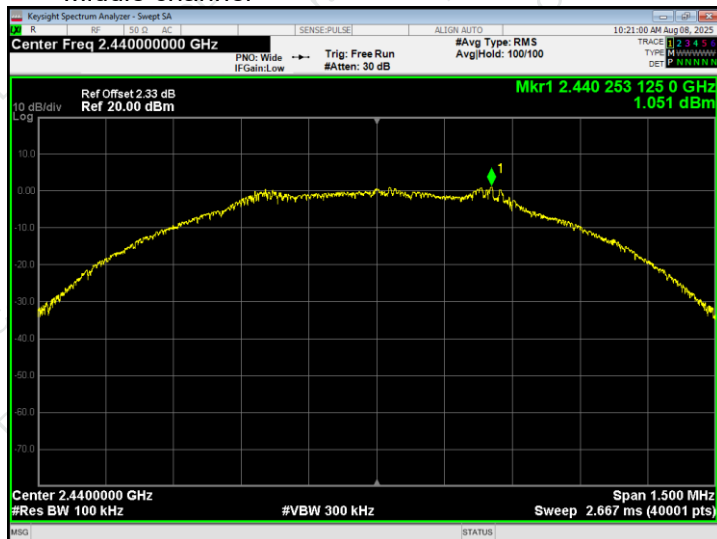

Highest channel

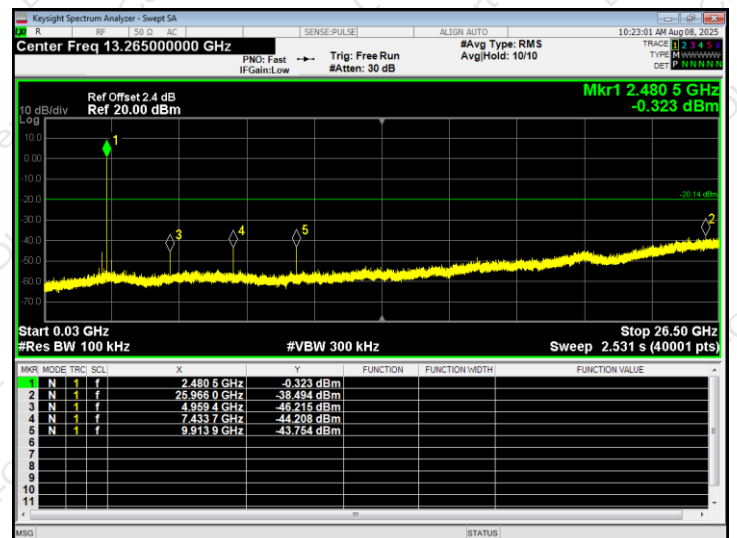
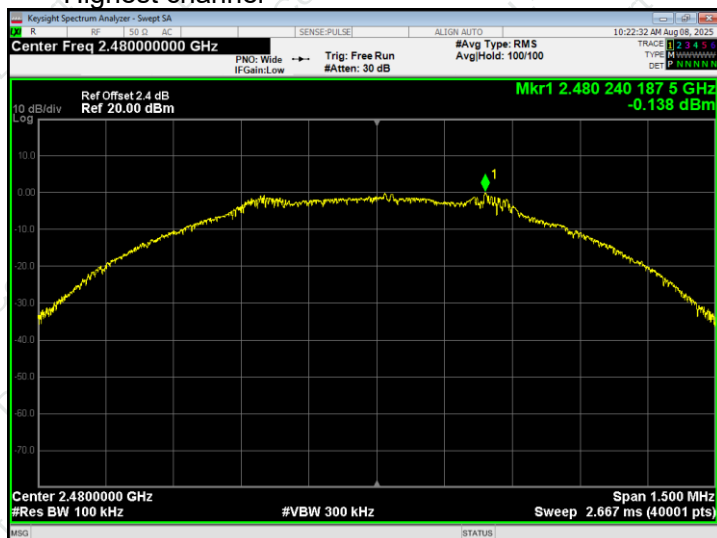

30MHz-26.5GHz



## 10. DUTY CYCLE

Test Method:	ANSI C63.10:2013
--------------	------------------

### 10.1 APPLIED PROCEDURES / LIMIT

Measurements of duty cycle and transmission duration shall be performed using one of the following techniques:

- a) A diode detector and an oscilloscope that together have a sufficiently short response time to permit accurate measurements of the ON and OFF times of the transmitted signal.
- b) The zero-span mode on a spectrum analyzer or EMI receiver if the response time and spacing between bins on the sweep are sufficient to permit accurate measurements of the ON and OFF times of the transmitted signal:
  - 1) Set the center frequency of the instrument to the center frequency of the transmission.
  - 2) Set  $RBW \geq OBW$  if possible; otherwise, set RBW to the largest available value.
  - 3) Set  $VBW \geq RBW$ . Set detector = peak or average.
  - 4) The zero-span measurement method shall not be used unless both RBW and VBW are  $> 50/T$  and the number of sweep points across duration  $T$  exceeds 100. (For example, if VBW and/or RBW are limited to 3 MHz, then the zero-span method of measuring the duty cycle shall not be used if  $T \leq 16.7 \mu s$ .)

### 10.2 DEVIATION FROM STANDARD

No deviation.

### 10.3 TEST SETUP

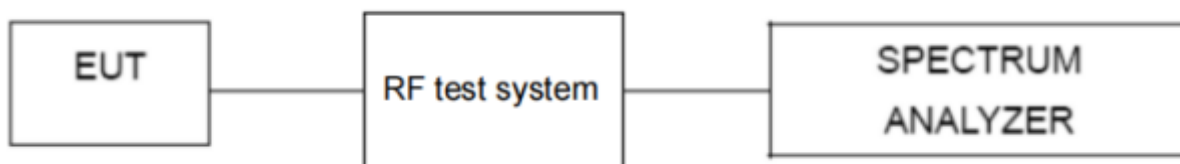

### 10.4 EUT OPERATION CONDITIONS

The EUT tested system was configured as the statements of chapter 3, Unless otherwise a special operating condition is specified in the follows during the testing.



10.5 TEST RESULTS

Temperature :	26°C	Relative Humidity :	54%
Pressure:	101kPa	Test Voltage:	DC 3.7V

Test Mode	Frequency (MHz)	Duty Cycle (%)	Duty Cycle Correction Factor (dB)	Result
GFSK	2402	85.32	0.69	Pass

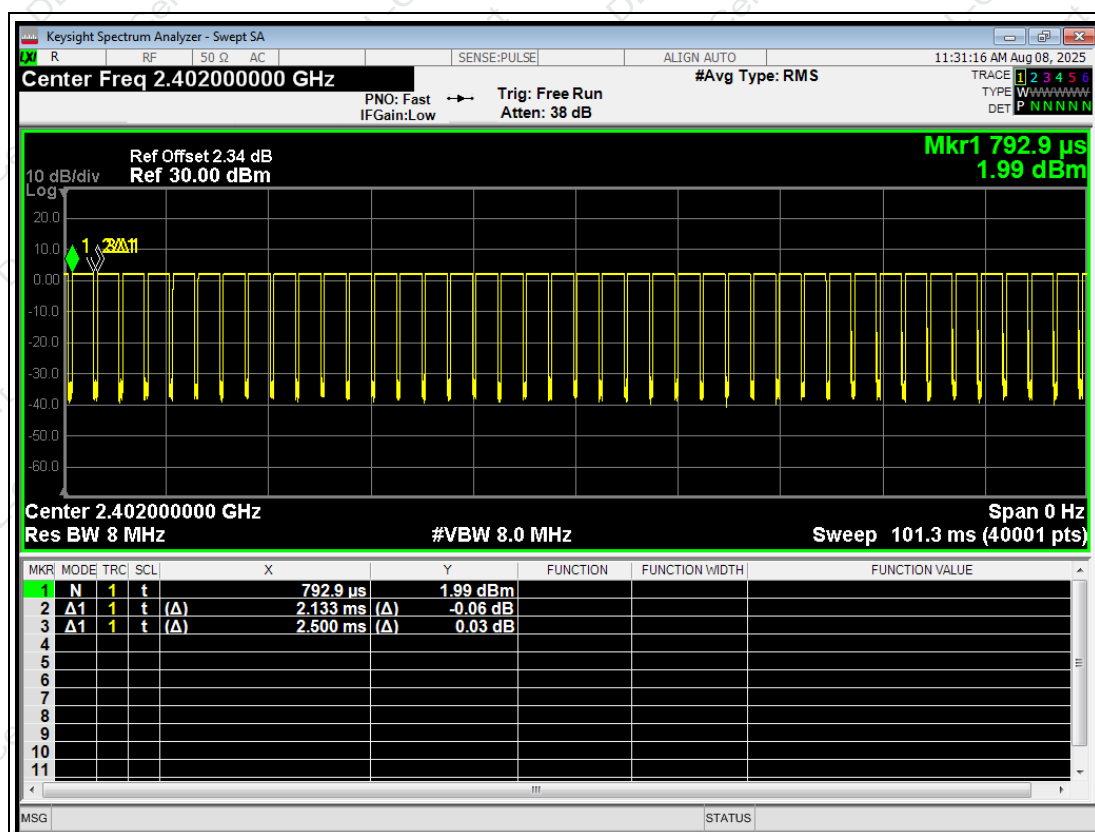

Note: All channel have been tested, and the report only reflects the worst case data.

Duty Cycle = Ton /Total\*100%

Duty Cycle Correction Factor = 10log (1/Duty Cycle)

**11. ANTENNA REQUIREMENT**

Standard requirement:	FCC Part15 C Section 15.203 /247(c)
15.203 requirement: An intentional radiator shall be designed to ensure that no antenna other than that furnished by the responsible party shall be used with the device. The use of a permanently attached antenna or of an antenna that uses a unique coupling to the intentional radiator, the manufacturer may design the unit so that a broken antenna can be replaced by the user, but the use of a standard antenna jack or electrical connector is prohibited.	
15.247(c) (1)(i) requirement: (i) Systems operating in the 2400-2483.5 MHz band that is used exclusively for fixed. Point-to-point operations may employ transmitting antennas with directional gain greater than 6dBi provided the maximum conducted output power of the intentional radiator is reduced by 1 dB for every 3 dB that the directional gain of the antenna exceeds 6dBi.	
EUT Antenna:	
The antenna is PCB antenna, the best case gain of the antennas is 1.25dBi, reference to the appendix II for details	



## 12. TEST SETUP PHOTO

Reference to the appendix I for details.

## 13. EUT CONSTRUCTIONAL DETAILS

Reference to the appendix II for details.

**\*\*\*\*\* END OF REPORT \*\*\*\*\***