



# FCC - TEST REPORT

Report Number : **709502400285-00B** Date of Issue: April 1, 2024

Model : STORM S2, STORM S1, STORM S3, STORM S6

Product Type : STORM Series Thermal Imaging Scope

Applicant : Visir Inc.

Address : 39899 Balentine Drive STE 200 Newark, CA 94560

Manufacturer : Visir Inc.

Address : 39899 Balentine Drive STE 200 Newark, CA 94560

Test Result :  Positive  Negative

Total pages including Appendices : 66



*TÜV SÜD Certification and Testing (China) Co., Ltd. Shanghai Branch is a subcontractor to TÜV SÜD Product Service GmbH according to the principles outlined in ISO 17025.*

*TÜV SÜD Certification and Testing (China) Co., Ltd. Shanghai Branch reports apply only to the specific samples tested under stated test conditions. Construction of the actual test samples has been documented. It is the manufacturer's responsibility to assure that additional production units of this model are manufactured with identical electrical and mechanical components. The manufacturer/importer is responsible to the Competent Authorities in Europe for any modifications made to the production units which result in non-compliance to the relevant regulations. TÜV SÜD Certification and Testing (China) Co., Ltd. Shanghai Branch shall have no liability for any deductions, inferences or generalizations drawn by the client or others from TÜV SÜD Certification and Testing (China) Co., Ltd. Shanghai Branch issued reports.*

*This report is the confidential property of the client. As a mutual protection to our clients, the public and ourselves, extracts from the test report shall not be reproduced except in full without our written approval.*



# 1 Table of Contents

1	Table of Contents .....	2
2	Details about the Test Laboratory.....	3
3	Description of the Equipment under Test .....	4
4	Summary of Test Standards.....	6
5	Summary of Test Results.....	7
6	General Remarks .....	8
7	Test Setups .....	9
8	Systems test configuration.....	11
9	Technical Requirement .....	12
9.1	Conducted peak(average) output power.....	12
9.2	6dB bandwidth .....	25
9.3	Power spectral density.....	29
9.4	Spurious RF conducted emissions .....	33
9.5	Band edge .....	43
9.6	Spurious radiated emissions for transmitter .....	50
10	Test Equipment List.....	63
11	System Measurement Uncertainty .....	64
12	Photographs of Test Set-ups .....	65
13	Photographs of EUT .....	66



## 2 Details about the Test Laboratory

### Test Site 1

Company name: TÜV SÜD Certification and Testing (China) Co., Ltd. Shanghai Branch  
No.16 Lane, 1951 Du Hui Road,  
Shanghai 201108,  
P.R. China

Test Firm FCC  
Registration  
Number: 820234

Designation  
number: CN1183

IC Company  
Number: 31668

CAB identifier: CN0101

Telephone: +86 21 6141 0123  
Fax: +86 21 6140 8600



### 3 Description of the Equipment under Test

Product: STORM Series Thermal Imaging Scope

Model no.: STORM S2, STORM S1, STORM S3, STORM S6

FCC ID: 2A7ZZ-5A-03

Rating: 3.6V DC (rechargeable lithium-ion battery)  
External power supply 5V (type C)

RF Transmission Frequency: For 802.11b/g/n-HT20: 2412~2462 MHz

No. of Operated Channel: 2.4GHz WIFI: 11 for 802.11b/802.11g/802.11(H20)

Modulation: For 2.4GHz WIFI:  
Direct Sequence Spread Spectrum (DSSS) for 802.11b  
Orthogonal Frequency Division Multiplexing (OFDM) for 802.11g/n

Channel list:

802.11b/g/n(HT20)			
Ch	Fre(MHz)	Ch	Fre(MHz)
1	2412	7	2442
2	2417	8	2447
3	2422	9	2452
4	2427	10	2457
5	2432	11	2462
6	2437		

Antenna Type: FPC antenna

Antenna Gain: 0.5dBi

Description of the EUT:

The Equipment Under Test (EUT) is a STORM Series Thermal Imaging Scope which support 2.4GHz Wi-Fi. According to client's declaration, STORM S1, STORM S6 have the same appearance and technical construction including circuit diagram, PCB Layout, components and component layout, all electrical construction and mechanical construction, with STORM S2, STORM S3. The difference lies only is the lens size of the different models. The difference between STORM S2/ STORM S1 and STORM S3/ STORM S6 is the Detector Connect Board, see below.

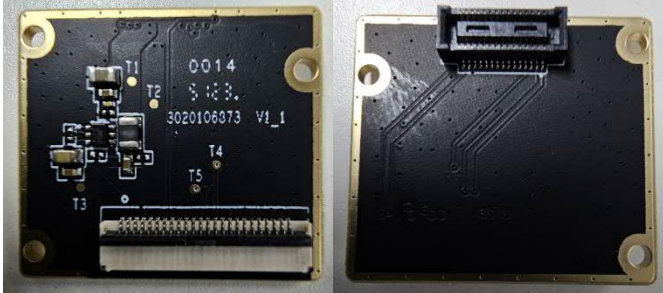
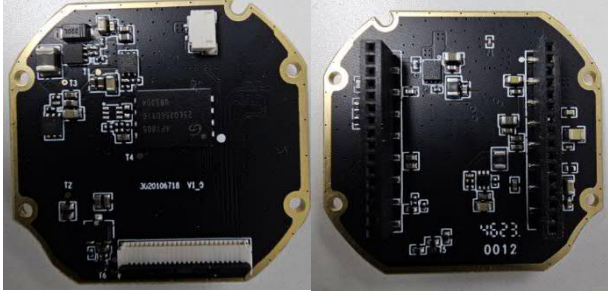
Model name	Different description
STORM S2/ STORM S1	
STORM S3/ STORM S6	

We chose model STORM S3 to perform all tests and model STORM S2 to only perform radiated spurious emissions below 1GHz, listed the worst data in this report.

Test sample no.:

- SHA-784114-1 (STORM S3 RF radiated);
- SHA-784114-2 (STORM S3 RF conducted);
- SHA-784114-3 (STORM S2 RF radiated);

The sample's mentioned in this report is/are submitted/ supplied/ manufactured by client. The laboratory therefore assumes no responsibility for accuracy of information on the brand name, model number, origin of manufacture, consignment or any information supplied.



## 4 Summary of Test Standards

Test Standards	
FCC Part 15 Subpart C	PART 15 - RADIO FREQUENCY DEVICES Subpart C - Intentional Radiators

All the test methods were according to KDB 558074 D01 15.247 Meas Guidance v05r02 Measurement Guidance and ANSI C63.10-2020.

## 5 Summary of Test Results

Technical Requirements						
FCC Part 15 Subpart C						
Test Condition		Pages	Test Site	Test Result		
				Pass	Fail	N/A
§15.207	Conducted emission AC power port	---	Site 1	<input type="checkbox"/>	<input type="checkbox"/>	<input checked="" type="checkbox"/>
§15.247 (b) (3)	Conducted peak(average) output power	13-24	Site 1	<input checked="" type="checkbox"/>	<input type="checkbox"/>	<input type="checkbox"/>
§15.247(a)(1)	20dB bandwidth	---	---	<input type="checkbox"/>	<input type="checkbox"/>	<input checked="" type="checkbox"/>
§15.247(a)(1)	Carrier frequency separation	---	---	<input type="checkbox"/>	<input type="checkbox"/>	<input checked="" type="checkbox"/>
§15.247(a)(1)(iii)	Number of hopping frequencies	---	---	<input type="checkbox"/>	<input type="checkbox"/>	<input checked="" type="checkbox"/>
§15.247(a)(1)(iii)	Dwell Time	---	---	<input type="checkbox"/>	<input type="checkbox"/>	<input checked="" type="checkbox"/>
§15.247(a)(2)	6dB bandwidth	25-28	Site 1	<input checked="" type="checkbox"/>	<input type="checkbox"/>	<input type="checkbox"/>
§15.247(e)	Power spectral density	29-32	Site 1	<input checked="" type="checkbox"/>	<input type="checkbox"/>	<input type="checkbox"/>
§15.247(d)	Spurious RF conducted emissions	33-42	Site 1	<input checked="" type="checkbox"/>	<input type="checkbox"/>	<input type="checkbox"/>
§15.247(d)	Band edge	43-49	Site 1	<input checked="" type="checkbox"/>	<input type="checkbox"/>	<input type="checkbox"/>
§15.247(d) & §15.209	Spurious radiated emissions for transmitter	50-62	Site 1	<input checked="" type="checkbox"/>	<input type="checkbox"/>	<input type="checkbox"/>
§15.203	Antenna requirement	See note 1		<input checked="" type="checkbox"/>	<input type="checkbox"/>	<input type="checkbox"/>

Remark 1: N/A – Not Applicable. Conducted emission is not apply for battery operated device.

Note 1: The EUT uses FPC antenna, which gain is 0.5dBi. In accordance to §15.203, It is considered sufficiently to comply with the provisions of this section.



## 6 General Remarks

### Remarks

This submittal(s) (test report) is intended for FCC ID: 2A7ZZ-5A-03, complies with Section 15.209, 15.247 of the FCC Part 15, Subpart C Rules.

### SUMMARY:

All tests according to the regulations cited on page 5 were

■ - Performed

□ - **Not** Performed

The Equipment under Test

■ - **Fulfills** the general approval requirements.

□ - **Does not** fulfill the general approval requirements.

Sample Received Date: January 18, 2024

Testing Start Date: January 19, 2024

Testing End Date: April 1, 2024

-TÜV SÜD Certification and Testing (China) Co., Ltd. Shanghai Branch

Reviewed by:

Prepared by:

Tested by:



Hui TONG  
Review Engineer

Jiayi XU  
Project Engineer

Zeng Jianqing  
Test Engineer



## 7 Test Setups

### 7.1 Radiated test setups

#### 9kHz ~ 30MHz Test Setup:

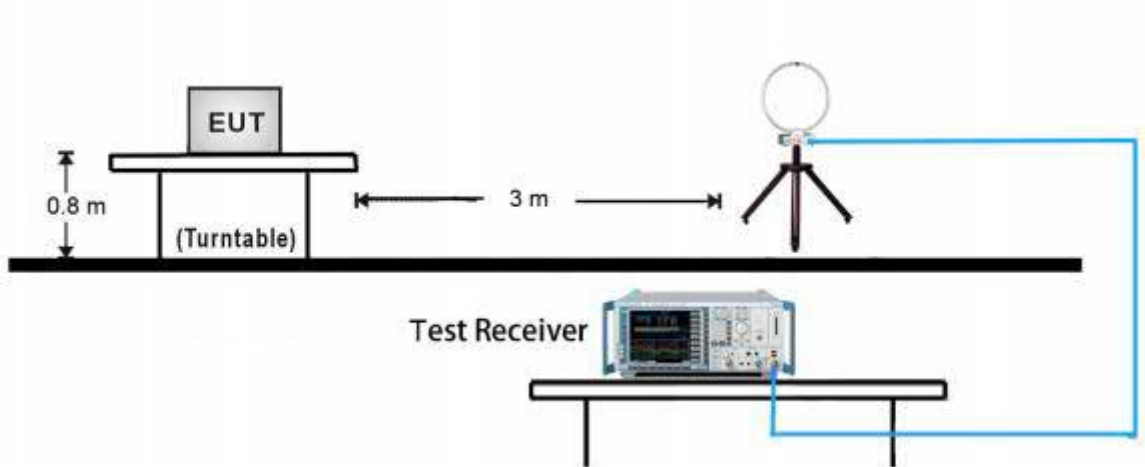

#### 30MHz ~ 1GHz Test Setup:

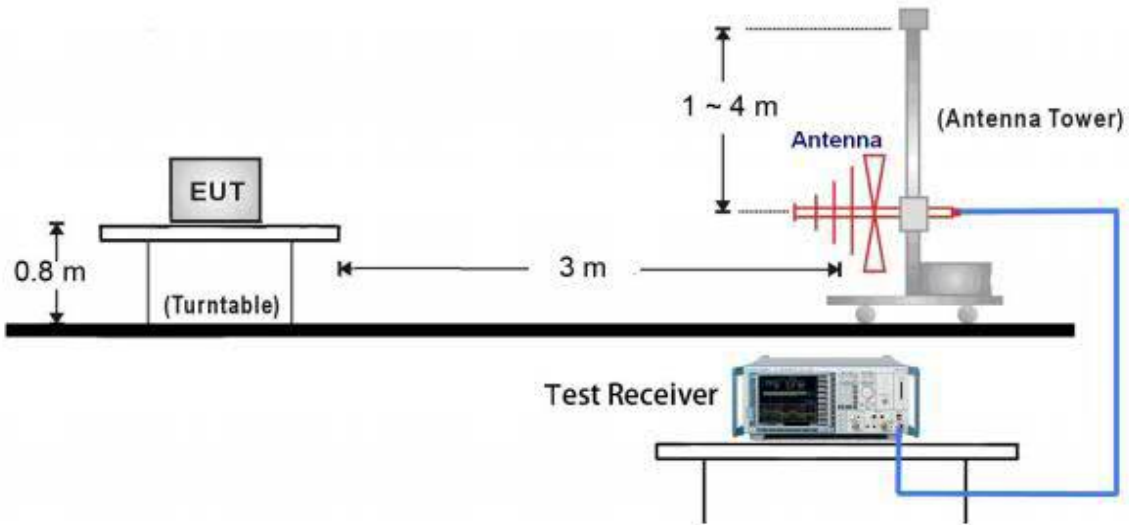

1GHz ~ 18GHz Test Setup:

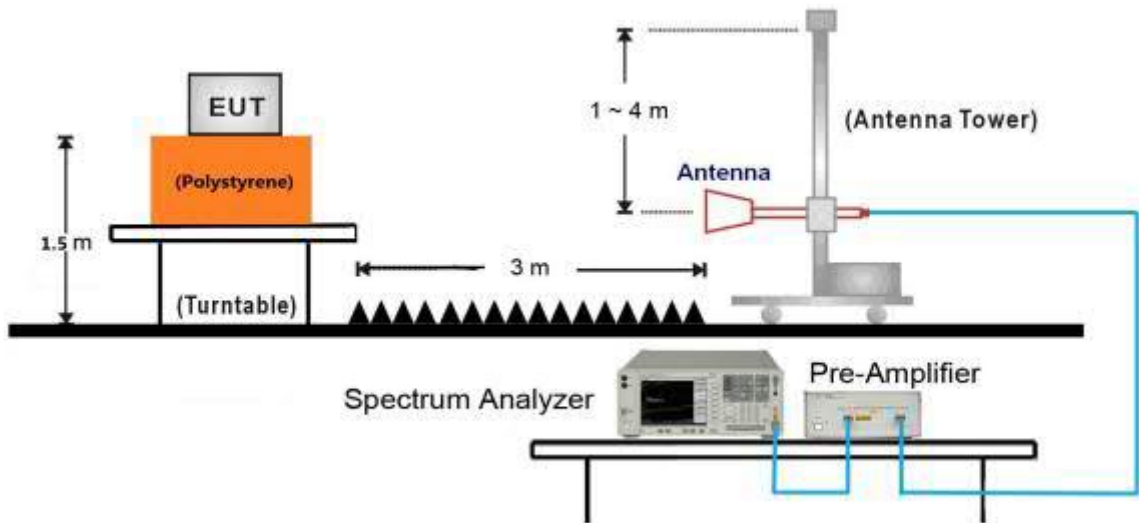

18GHz ~ 25GHz Test Setup:

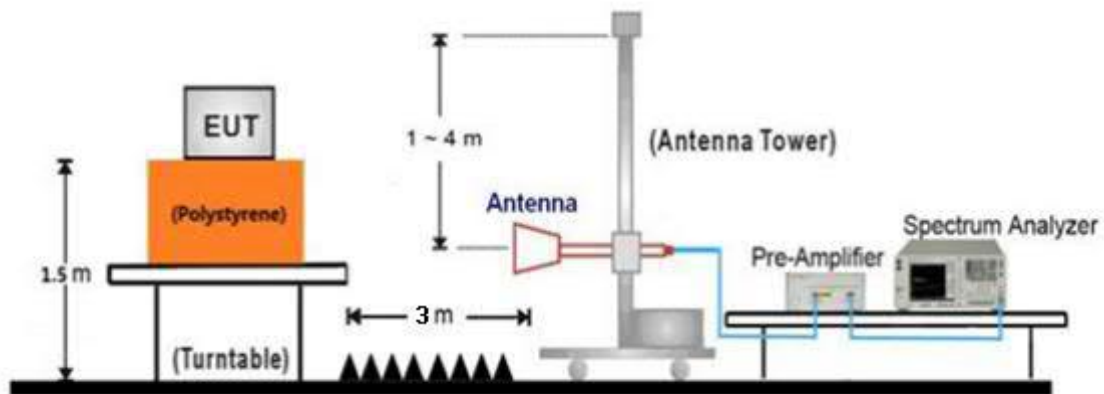

7.2 Conducted RF test setups

For Conducted peak output power

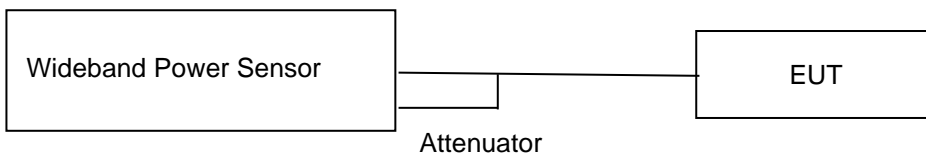

For other test items



## 8 Systems test configuration

Auxiliary Equipment Used during Test:

DESCRIPTION	MANUFACTURER	MODEL NO.(SHIELD)	S/N(LENGTH)
Notebook	Lenovo	E470	PF-OU5TS7 17/09
AC/DC adapter	SHENZHEN KEYU POWER	KA12C-0502000US	N/A

Test software: iwpriv commend.

Test Mode Applicability and Tested Channel Detail:

Mode	Tested Channel	Data Rate (Mbps)	Modulation	(Power level setting
802.11b	1	1	CCK	17
	6	1	CCK	17
	11	1	CCK	17
802.11g	1	6	OFDM	14
	6	6	OFDM	14
	11	6	OFDM	14
802.11n HT20	1	MCS0	OFDM	14
	6	MCS0	OFDM	14
	11	MCS0	OFDM	14

Non-hopping mode: The system was configured to operate at a signal channel transmitting. The test software allows the configuration and operation at the worst-case duty and the highest transmit power.

## 9 Technical Requirement

### 9.1 Conducted peak(average) output power

#### Test Method (1)

1. Measure the duty cycle D of the transmitter output signal.
2. Set span to at least 1.5 times the OBW.
3. Set RBW = 1% to 5% of the OBW, not to exceed 1 MHz.
4. Set VBW  $\geq [3 \times \text{RBW}]$ .
5. Number of points in sweep  $\geq [2 \times \text{span} / \text{RBW}]$ . (This gives bin-to-bin spacing  $\leq \text{RBW} / 2$ , so that narrowband signals are not lost between frequency bins.)
6. Sweep time = auto.
7. Detector = RMS (i.e., power averaging), if available. Otherwise, use the sample detector mode.
8. Do not use sweep triggering. Allow the sweep to "free run."
9. Trace average at least 100 traces in power averaging (rms) mode; however, the number of traces to be averaged shall be increased above 100 as needed such that the average accurately represents the true average over the ON and OFF periods of the transmitter.
10. Compute power by integrating the spectrum across the OBW of the signal using the instrument's band power measurement function with band limits set equal to the OBW band edges. If the instrument does not have a band power function, then sum the spectrum levels (in power units) at intervals equal to the RBW extending across the entire OBW of the spectrum.
11. Add  $[10 \log (1 / D)]$ , where D is the duty cycle, to the measured power to compute the average power during the actual transmission times (because the measurement represents an average over both the ON and OFF times of the transmission).

#### Test Method (2)

- 1) The EUT is configured to transmit continuously, or to transmit with a constant duty cycle.
- 2) At all times when the EUT is transmitting, it shall be transmitting at its maximum power control level.
- 3) The integration period of the power meter exceeds the repetition period of the transmitted signal by at least a factor of five.
- 4) Measure the peak power of the transmitter. This measurement is a peak over both the ON and OFF periods of the transmitter.

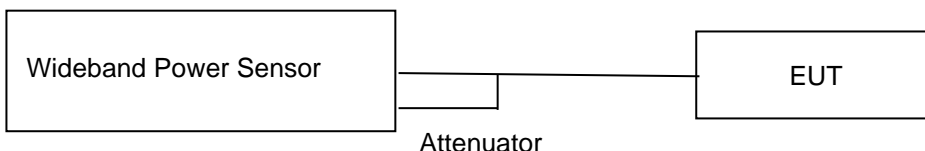

**Wideband Power Sensor conducted test setup**



**Limits**

According to §15.247 (b) (1) conducted peak (average) output power limit as below:

Frequency Range MHz	Limit W	Limit dBm
2400-2483.5	≤1	≤30

Test result (average power) as below table:

802.11b

Frequency (MHz)	Duty cycle Factor (dB)	Conducted Power (dBm)	Total Power(average) (dBm)	Result
Low channel 2412MHz	0	15.96	15.96	Pass
Middle channel 2437MHz	0	15.58	15.58	Pass
High channel 2462MHz	0	15.89	15.89	Pass

802.11g

Frequency (MHz)	Duty cycle Factor (dB)	Conducted Power (dBm)	Total Power(average) (dBm)	Result
Low channel 2412MHz	0.09	11.45	11.54	Pass
Middle channel 2437MHz	0.19	11.77	11.96	Pass
High channel 2462MHz	0	12.18	12.18	Pass

802.11n(HT20)

Frequency (MHz)	Duty cycle Factor (dB)	Conducted Power (dBm)	Total Power(average) (dBm)	Result
Low channel 2412MHz	0.16	11.28	11.44	Pass
Middle channel 2437MHz	0.31	11.77	12.08	Pass
High channel 2462MHz	0.18	12.15	12.33	Pass

Test result (conducted peak) as below:

802.11b		
Frequency (MHz)	Conducted Peak Output Power(dBm)	Result
2412	18.57	Pass
2437	18.85	Pass
2462	19.33	Pass
802.11g		
Frequency (MHz)	Conducted Peak Output Power(dBm)	Result
2412	23.91	Pass
2437	23.85	Pass
2462	24.23	Pass
802.11n(HT20)		
Frequency (MHz)	Conducted Peak Output Power(dBm)	Result
2412	23.30	Pass
2437	23.67	Pass
2462	24.06	Pass



Duty cycle

Condition	Mode	Frequency (MHz)	Antenna	Duty Cycle (%)	Correction Factor (dB)
NVNT	b	2412	Ant1	99.15	0
NVNT	b	2437	Ant1	98.78	0
NVNT	b	2462	Ant1	98.71	0
NVNT	g	2412	Ant1	97.91	0.09
NVNT	g	2437	Ant1	95.82	0.19
NVNT	g	2462	Ant1	98.29	0
NVNT	n20	2412	Ant1	96.48	0.16
NVNT	n20	2437	Ant1	93.02	0.31
NVNT	n20	2462	Ant1	96	0.18

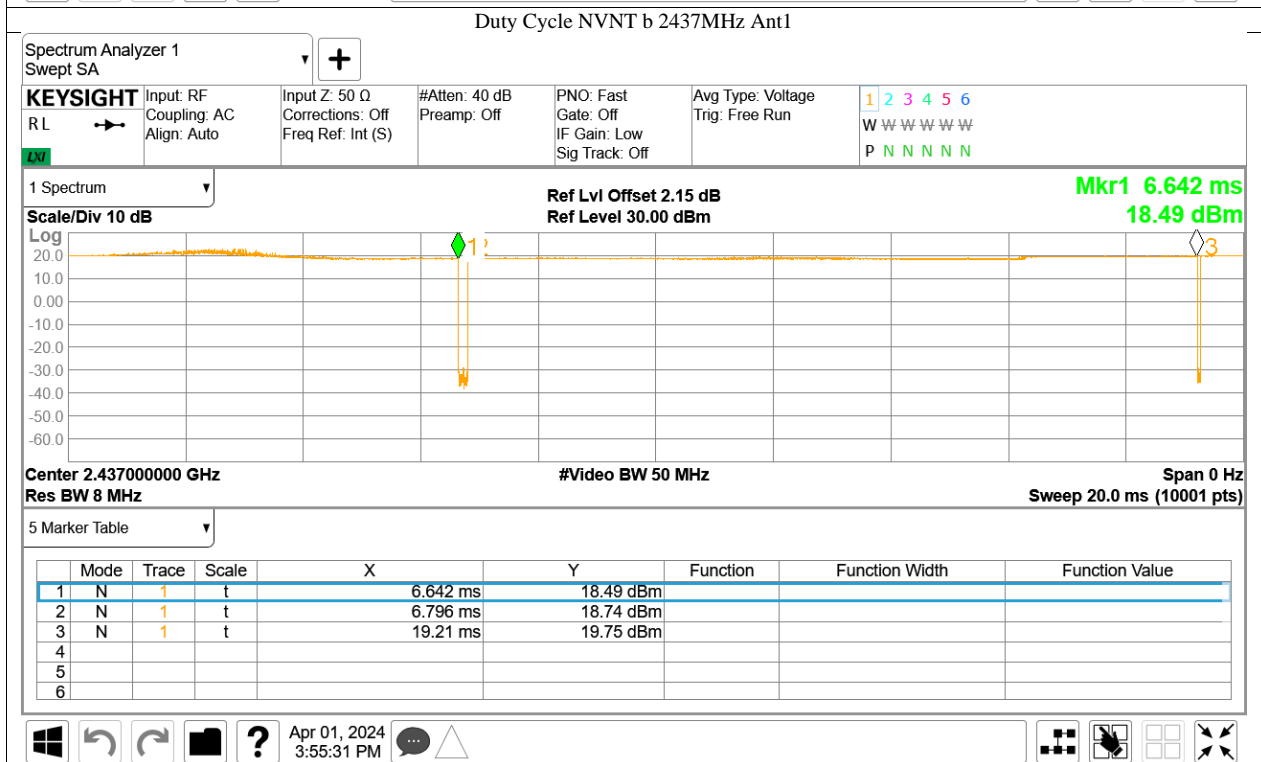
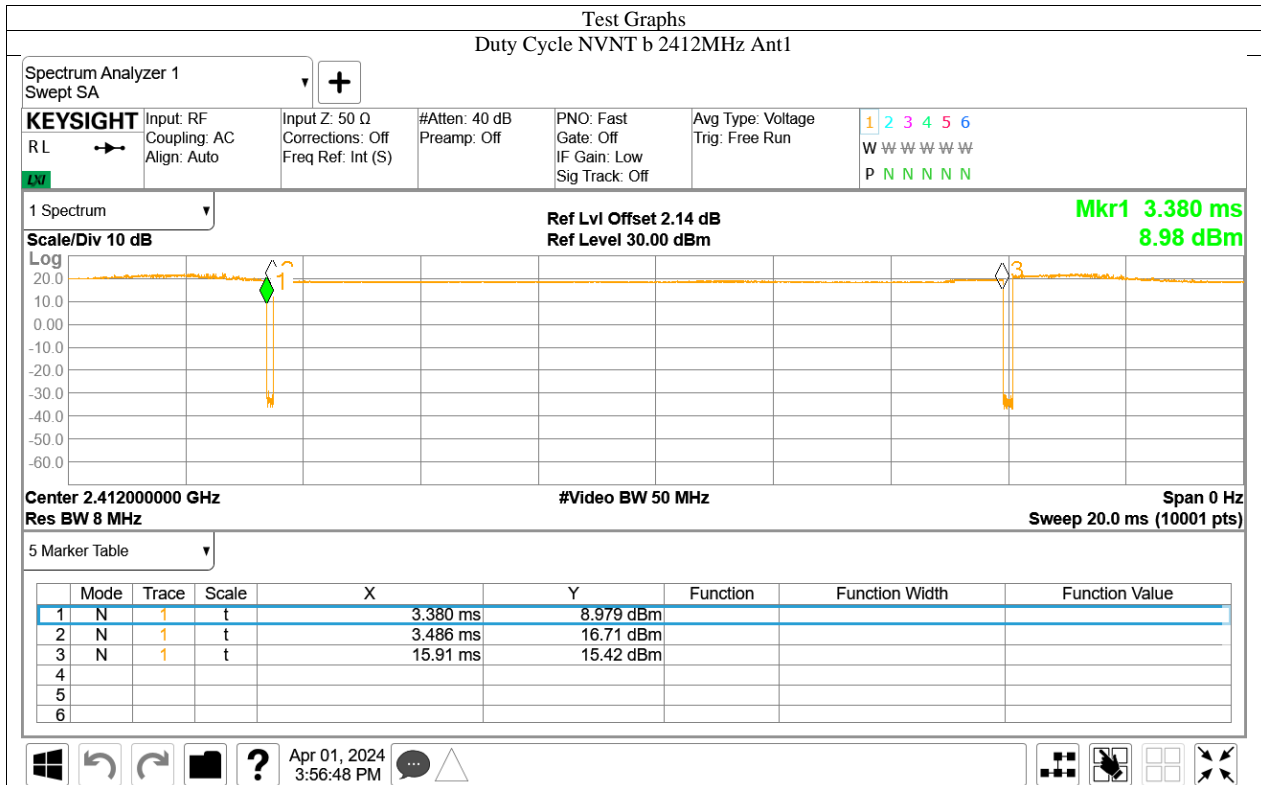

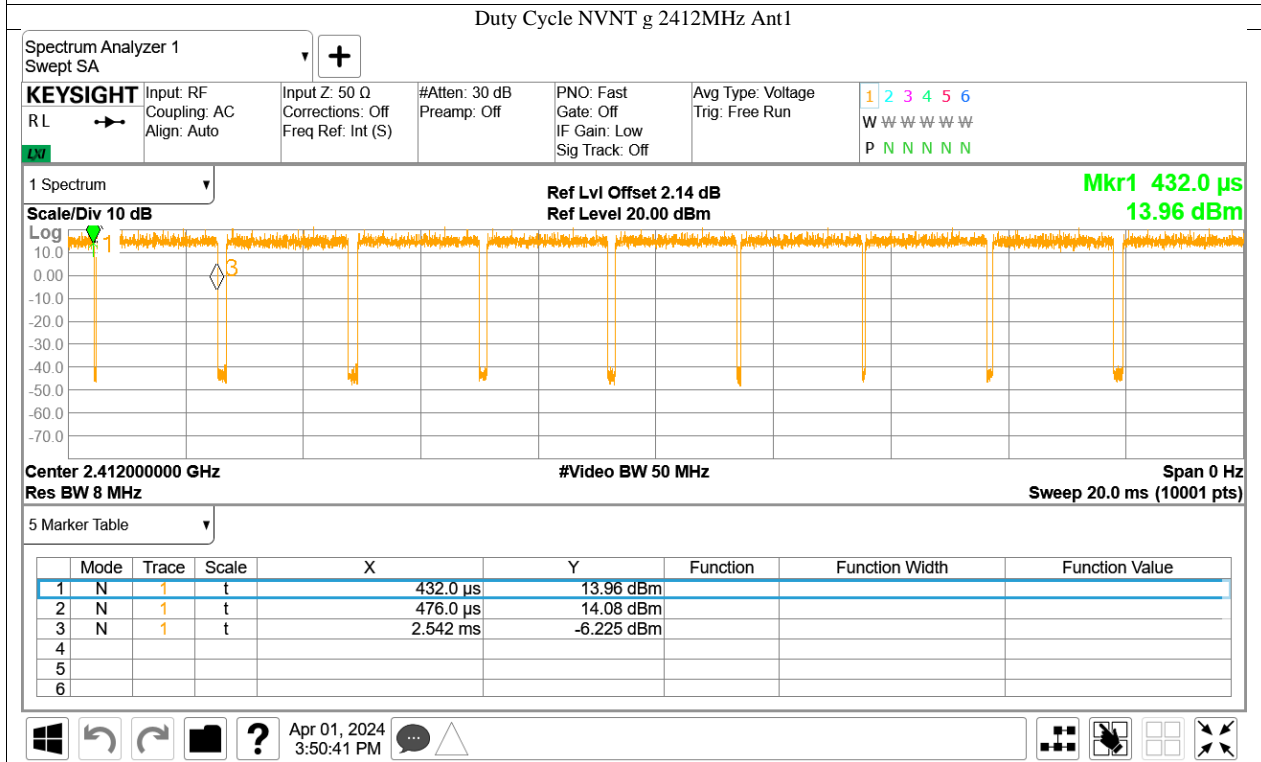
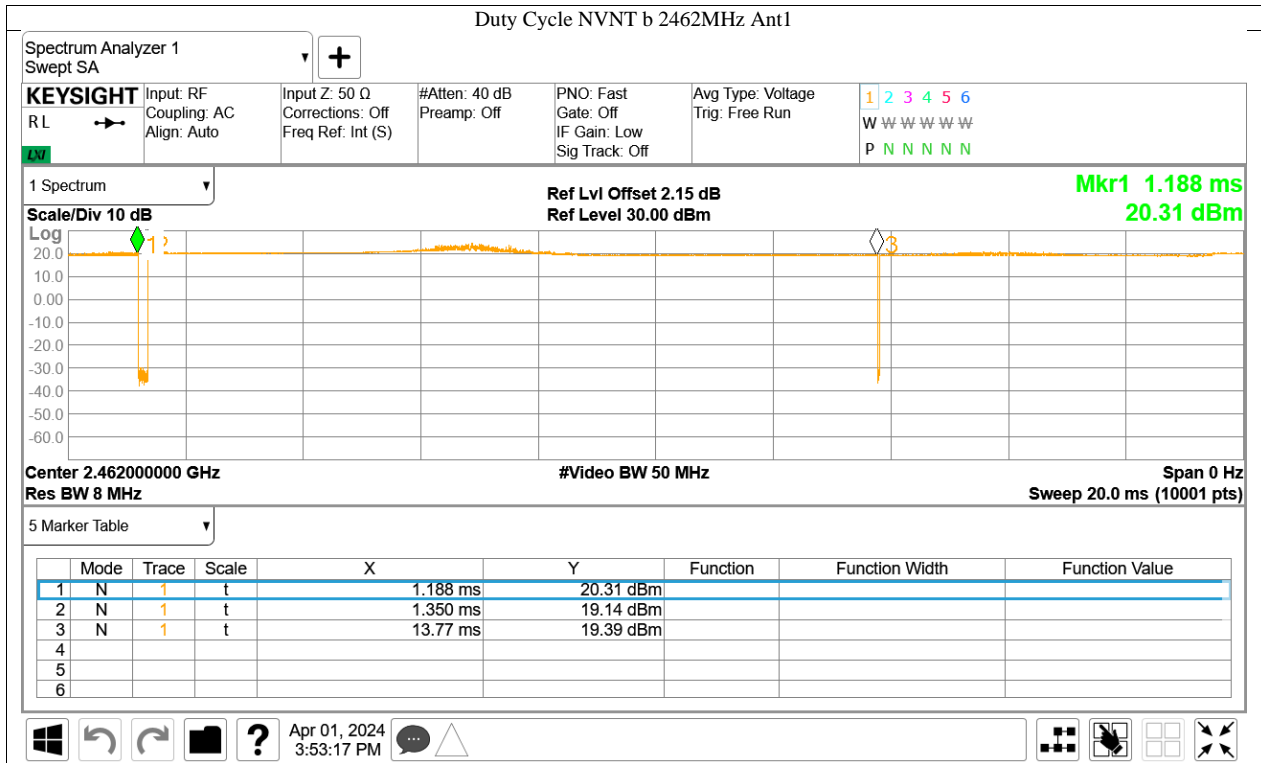



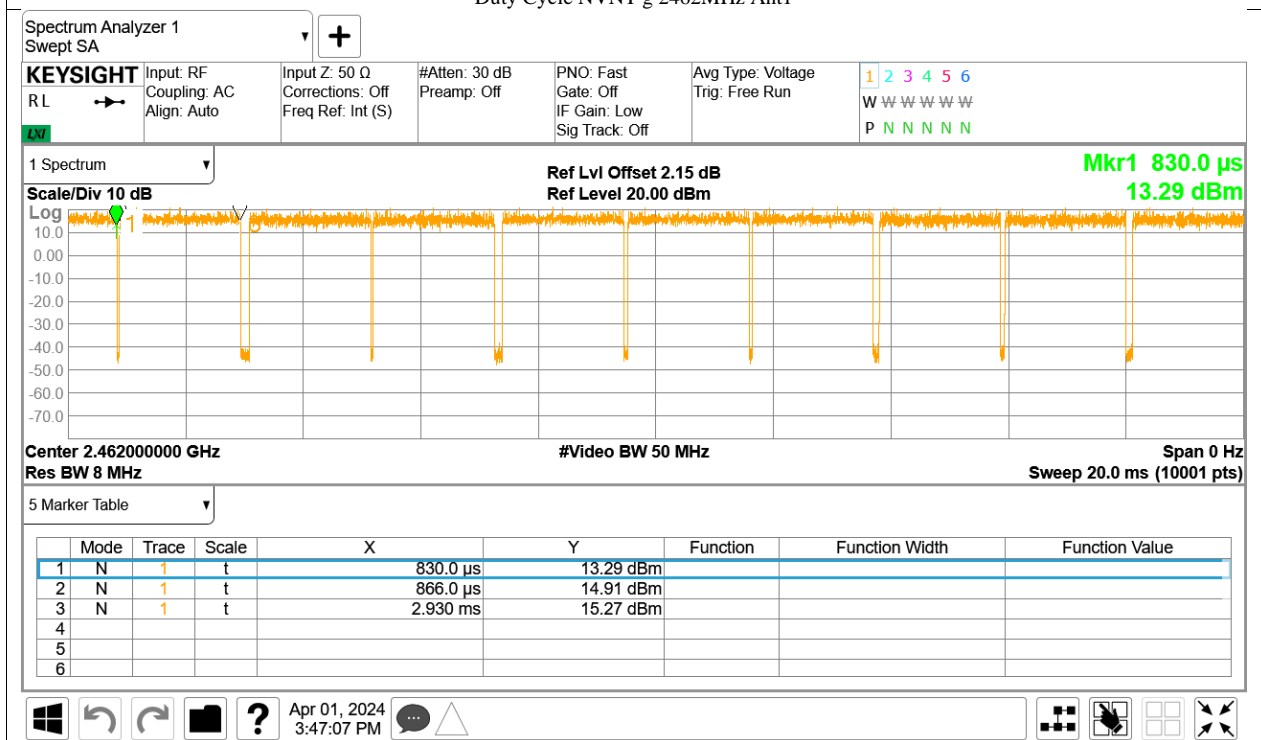
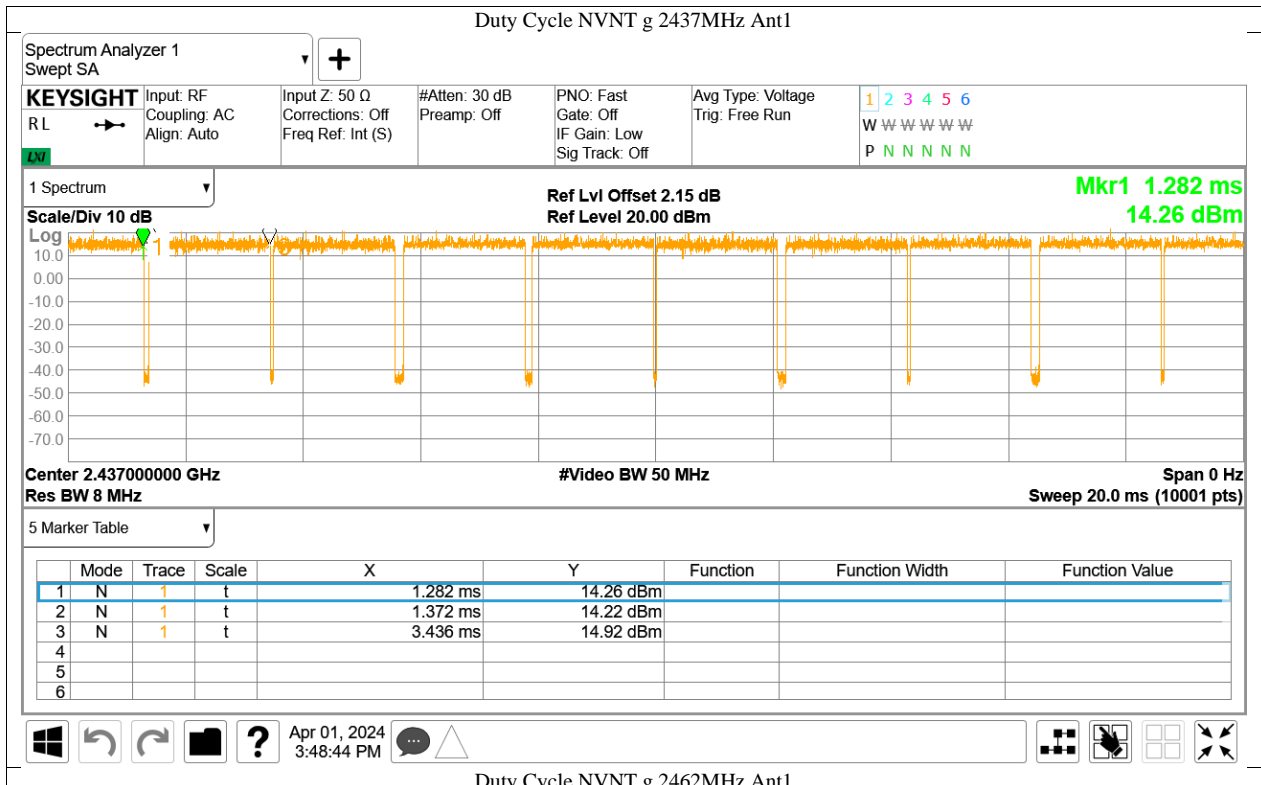

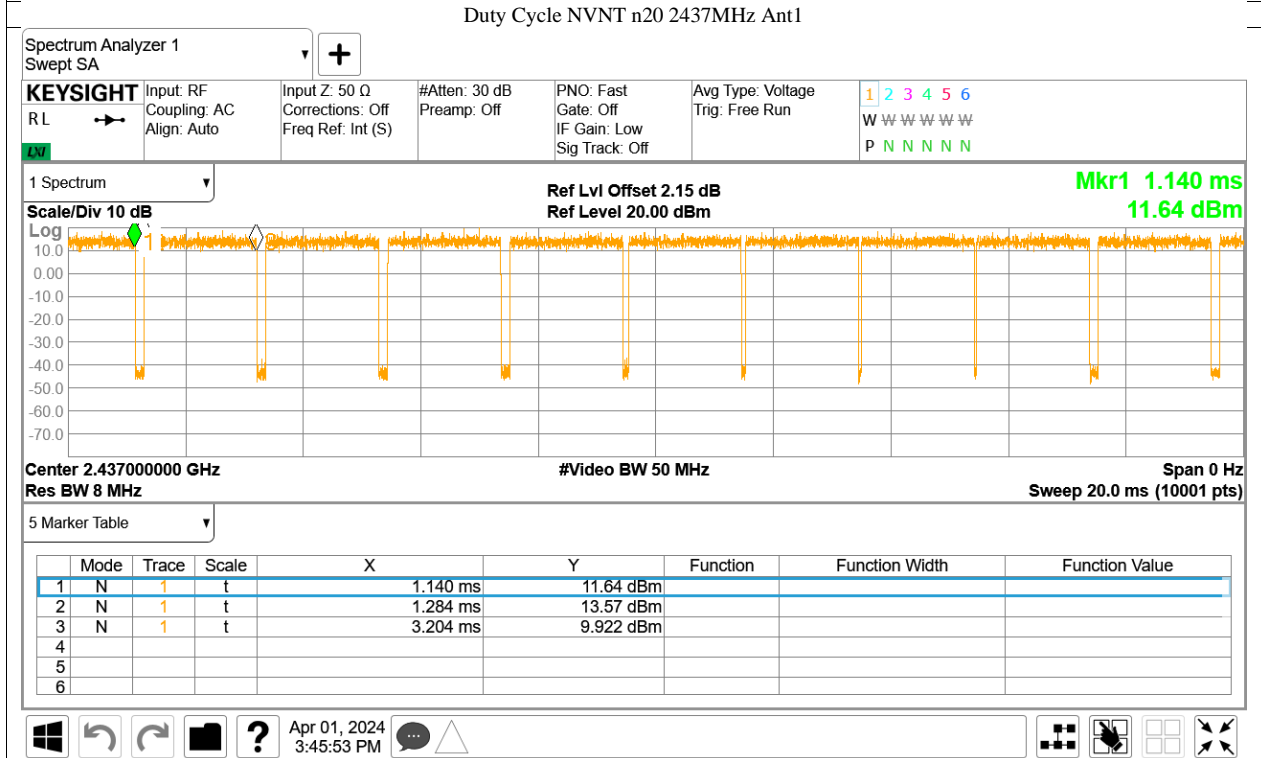
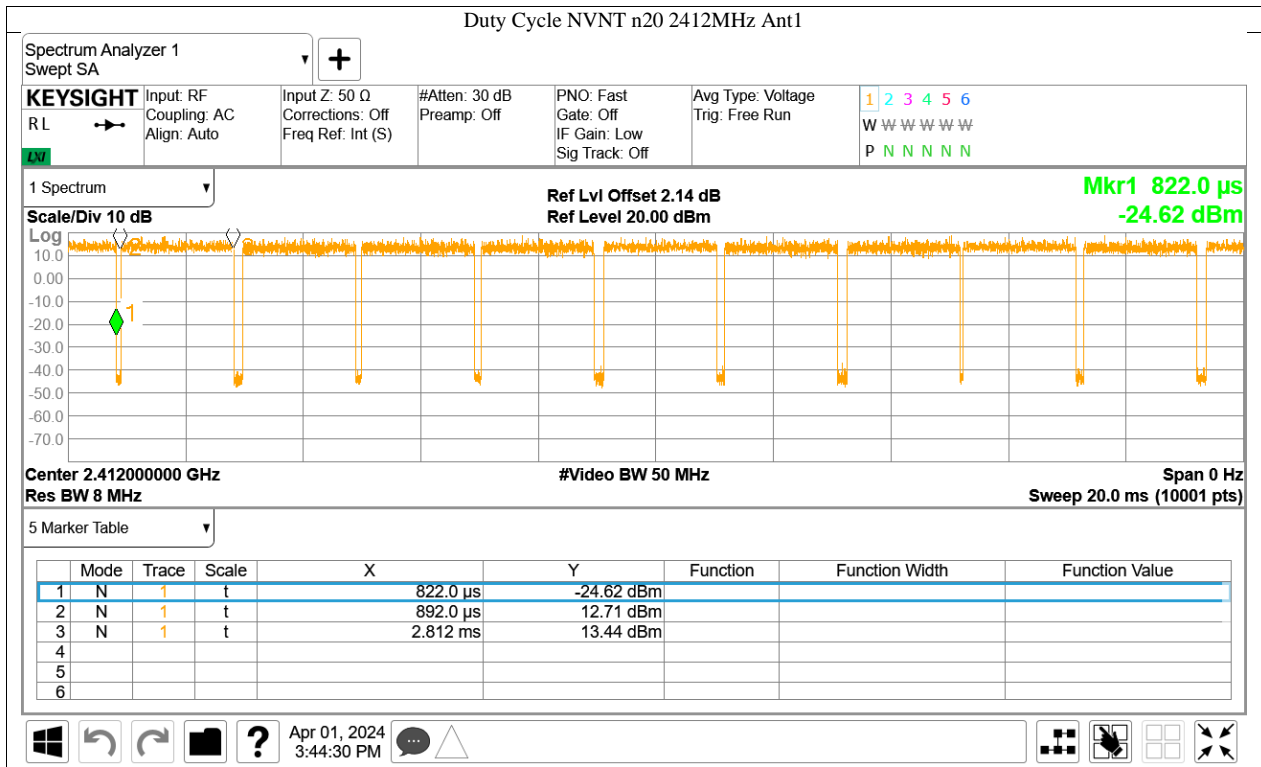

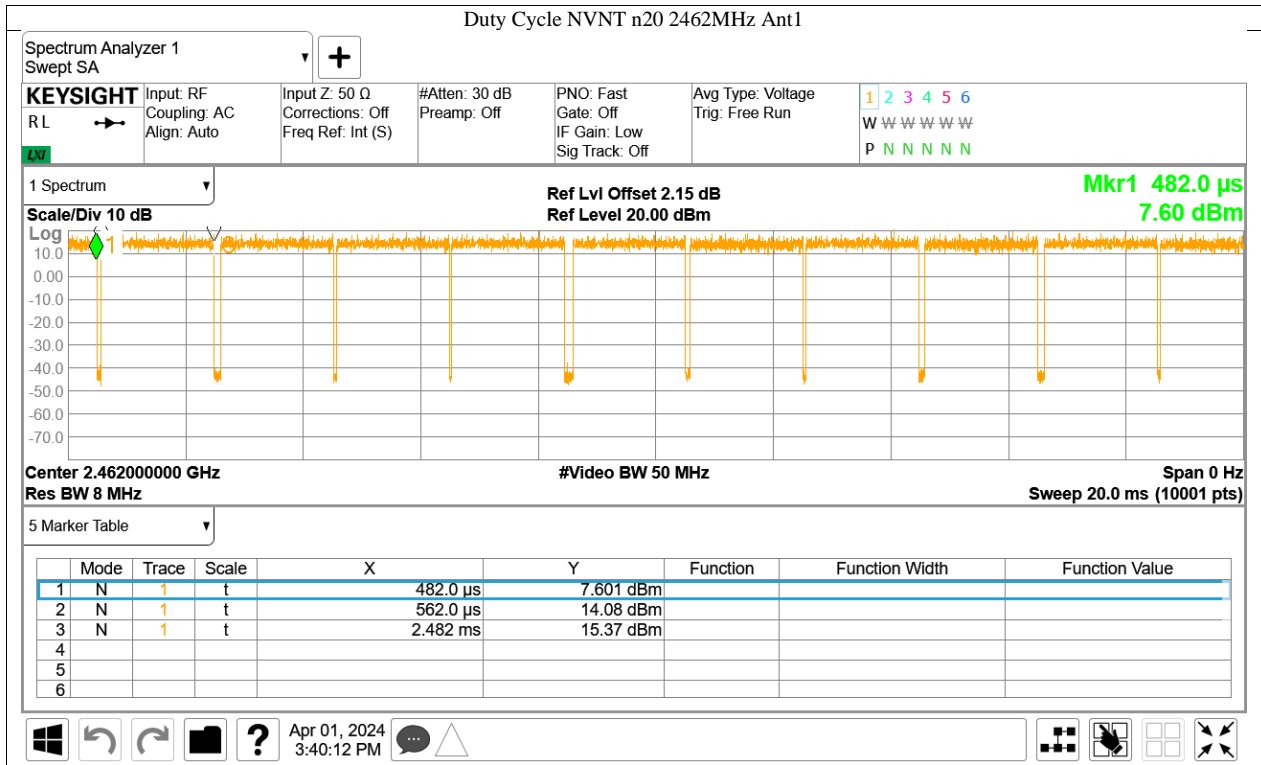



### Conducted power

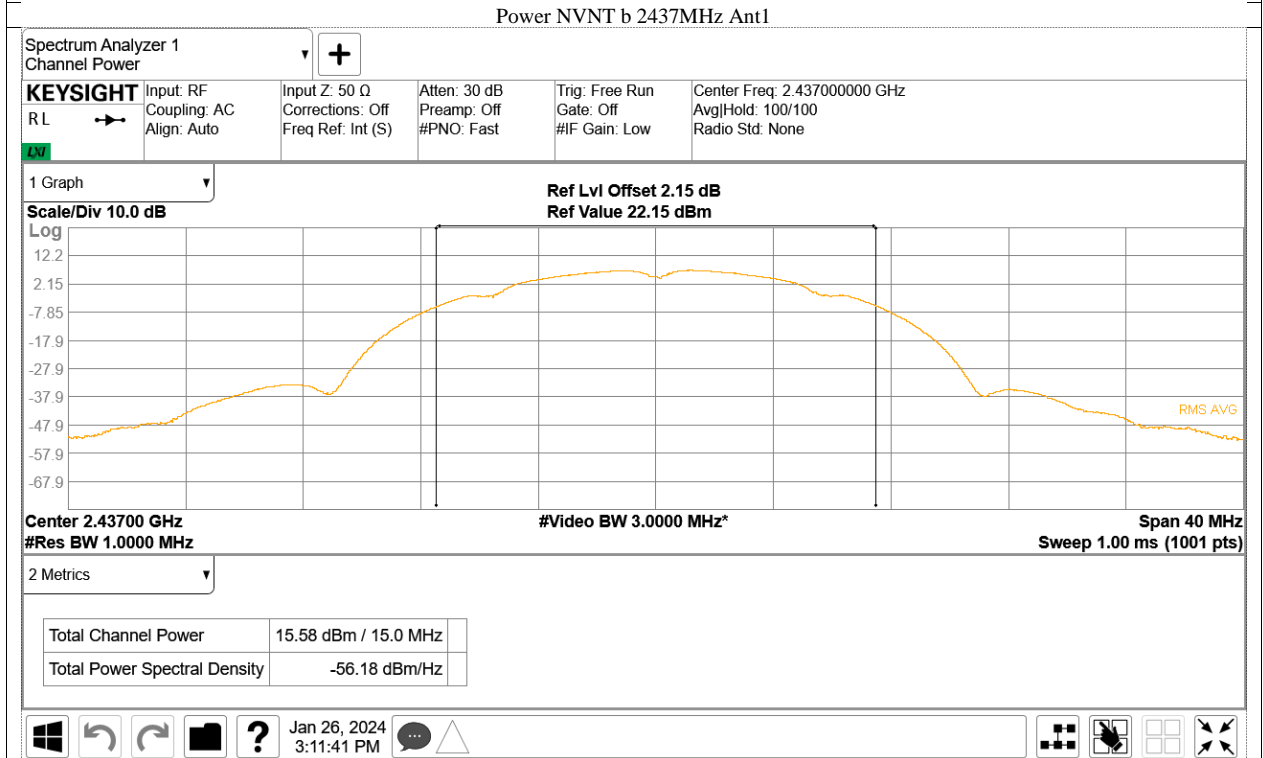
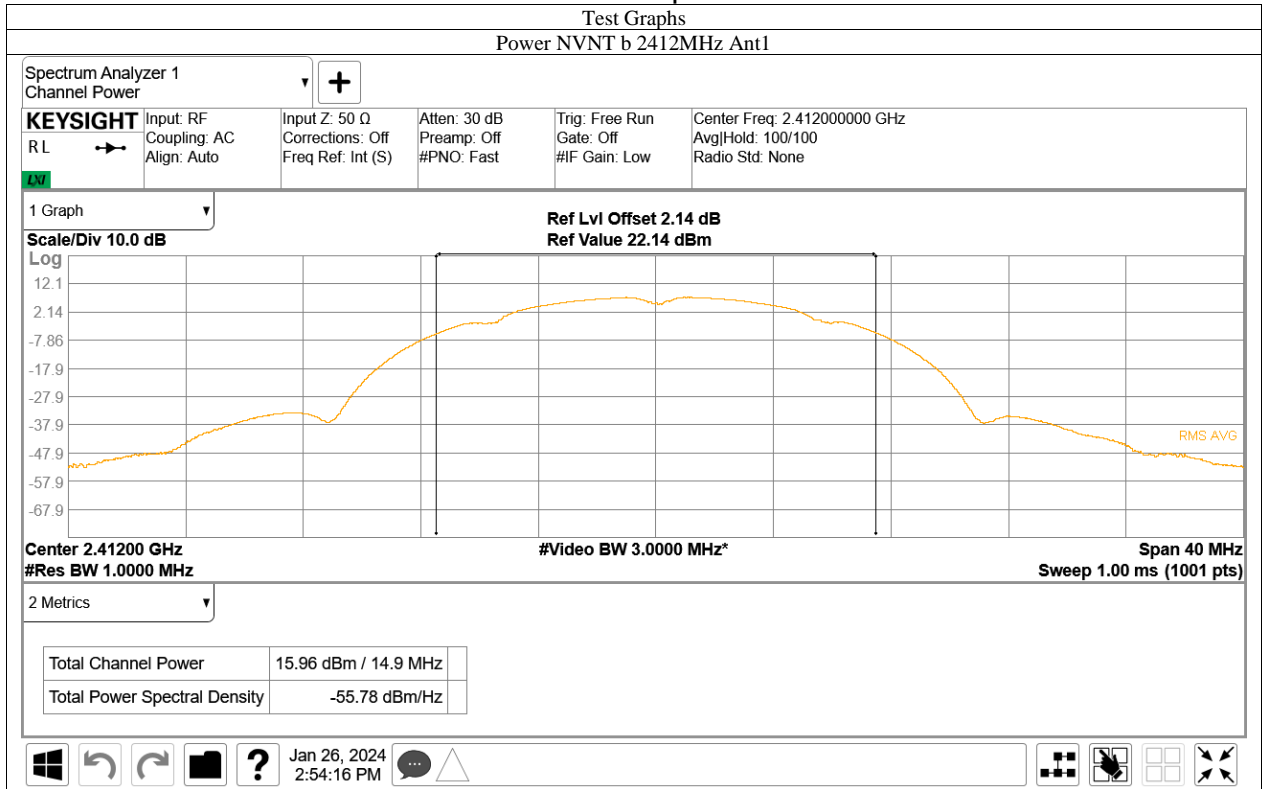

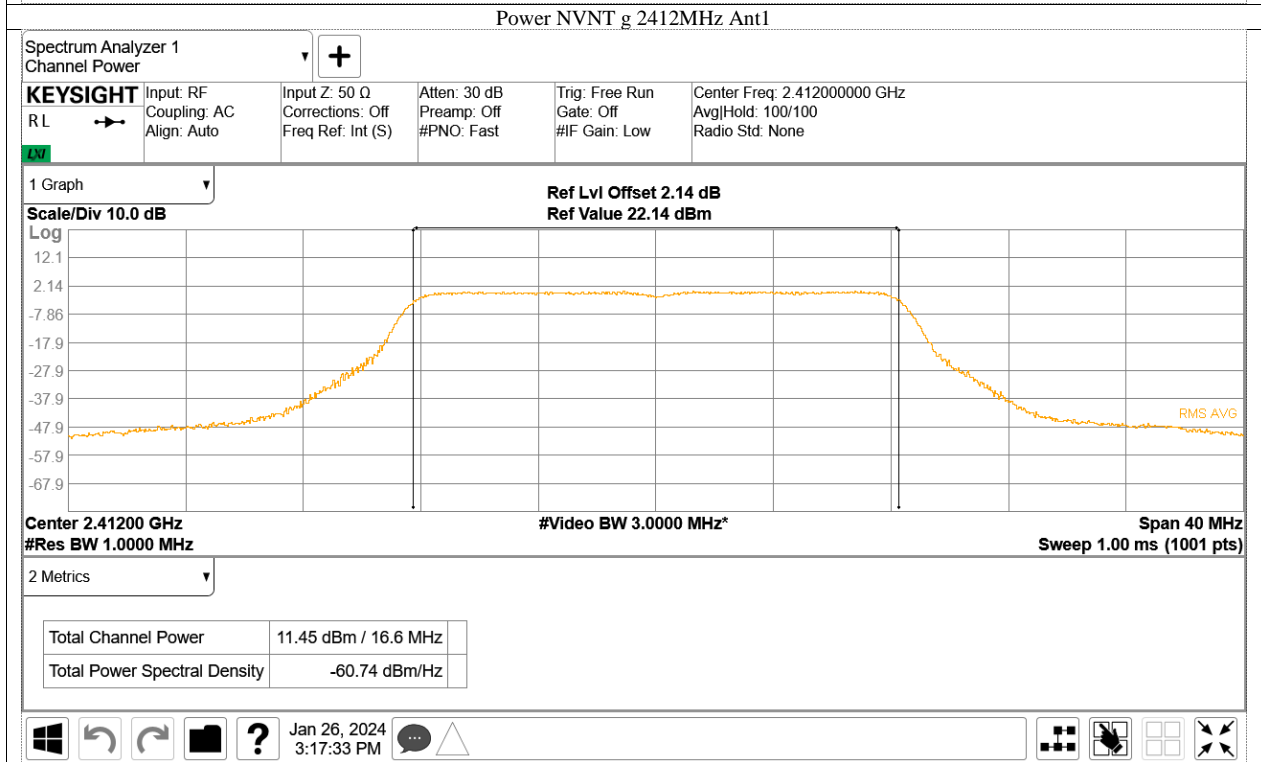
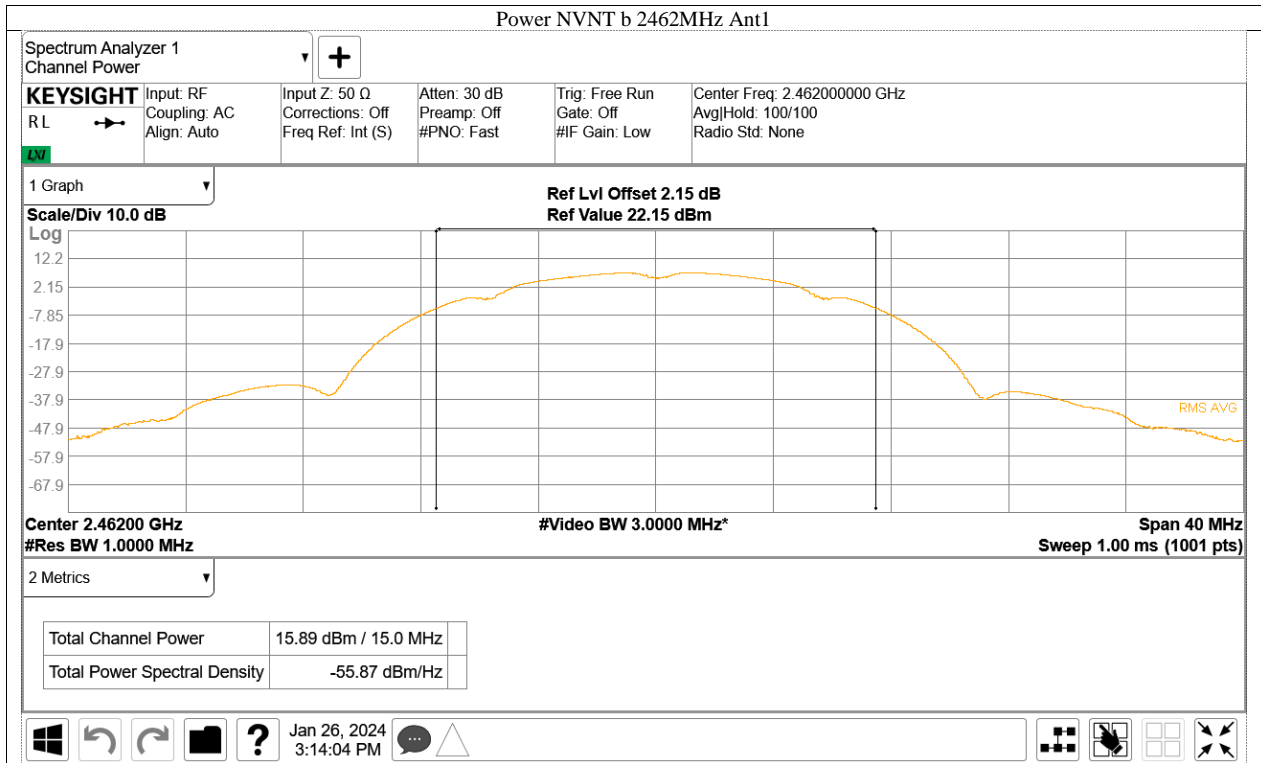

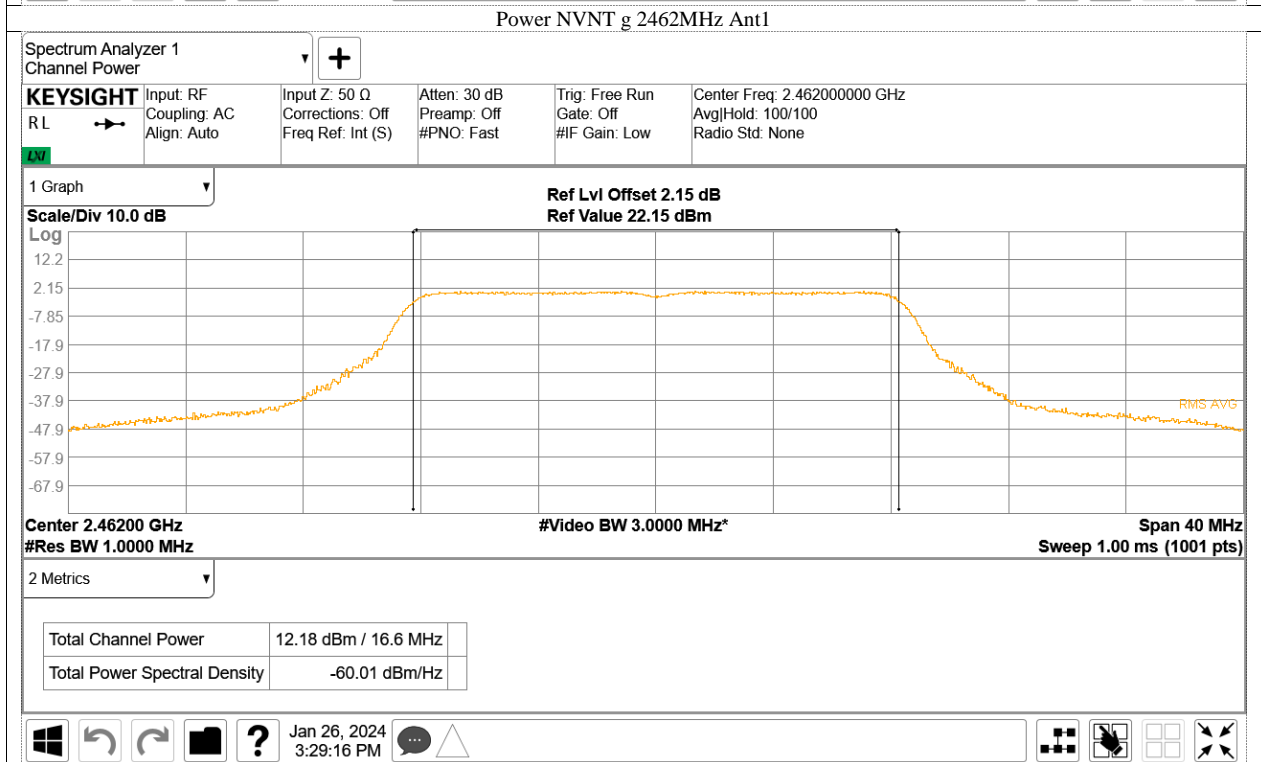
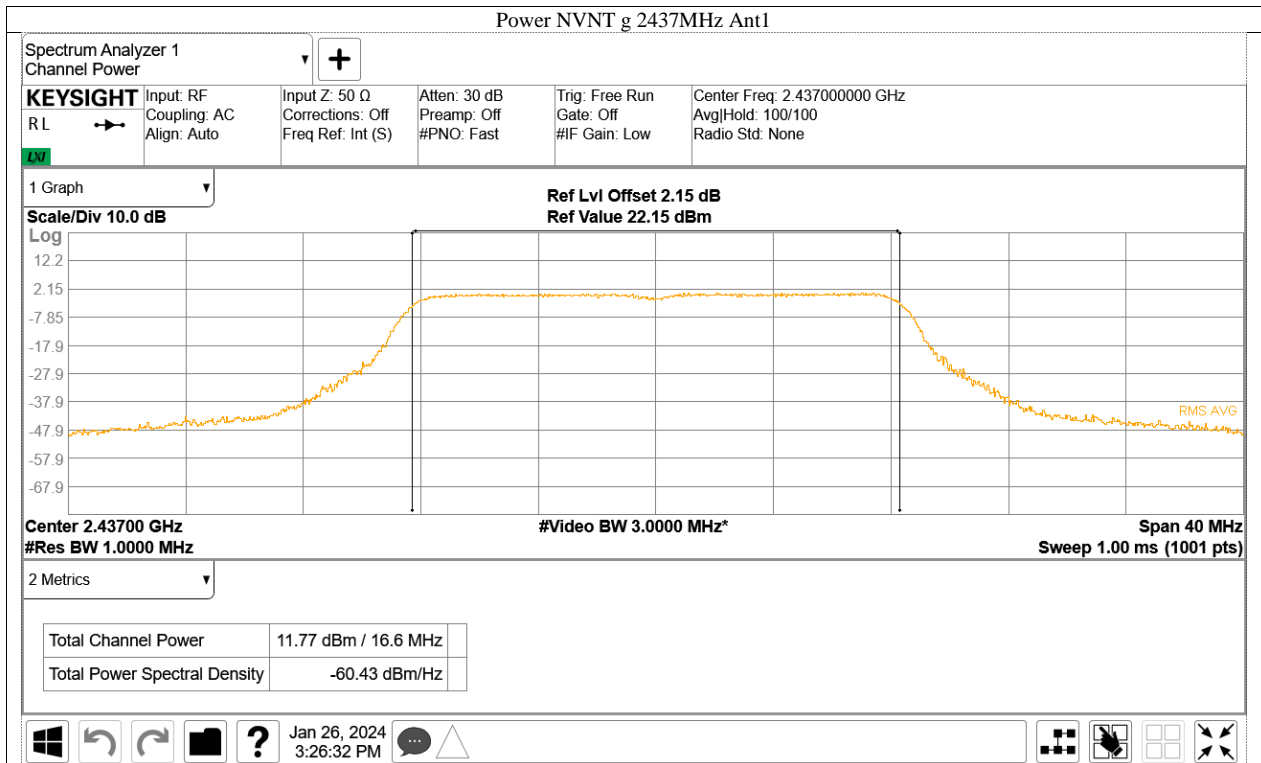

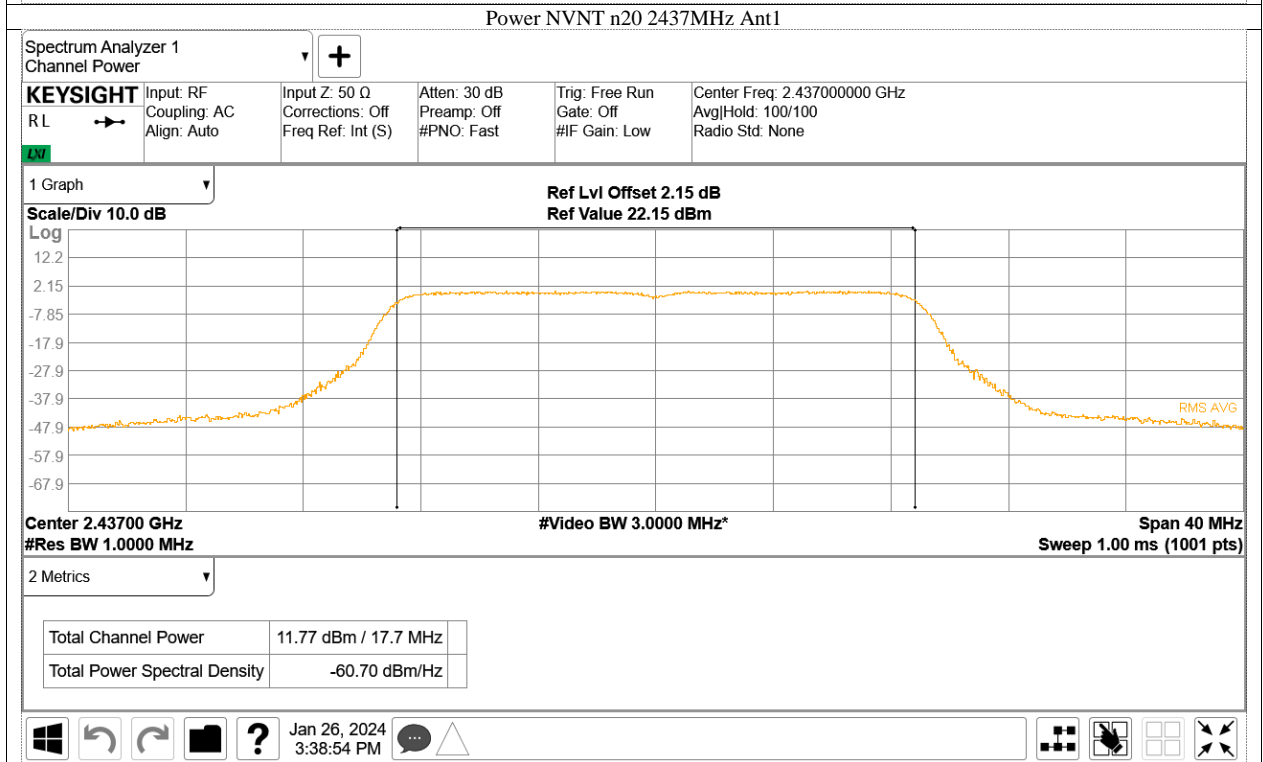
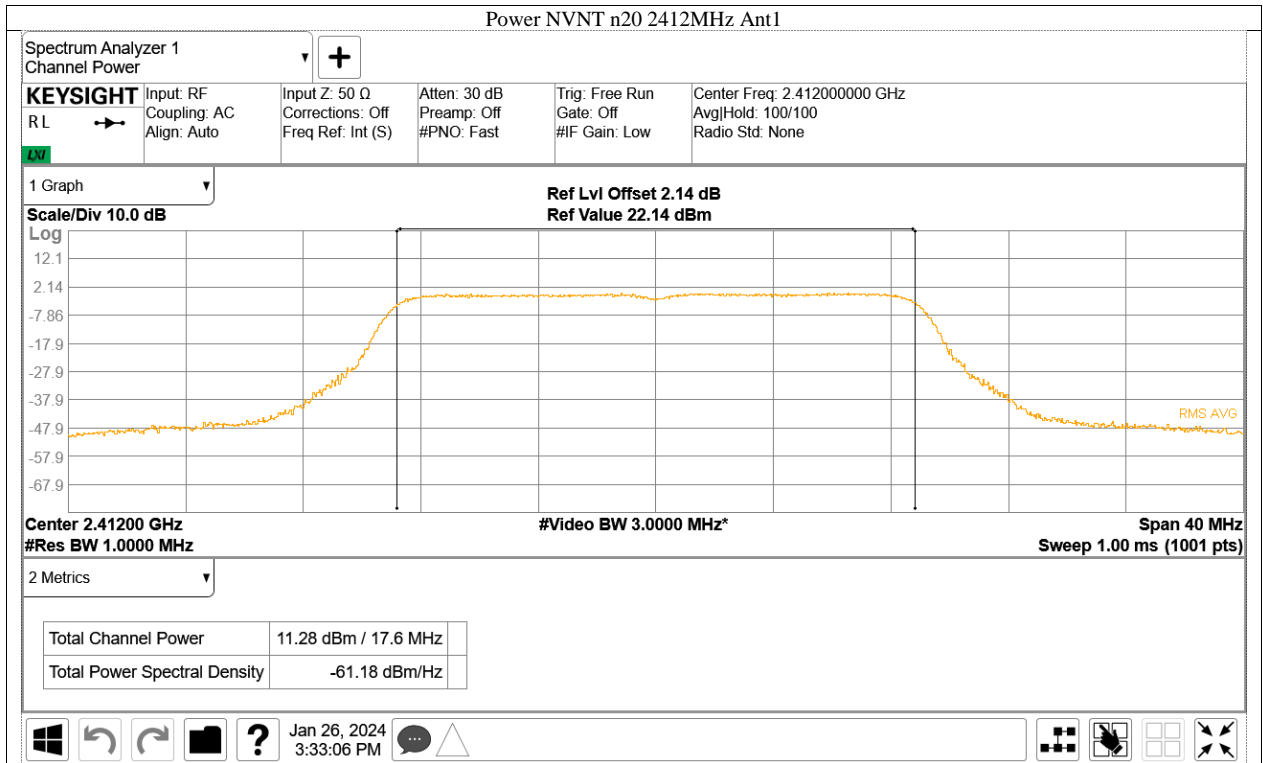

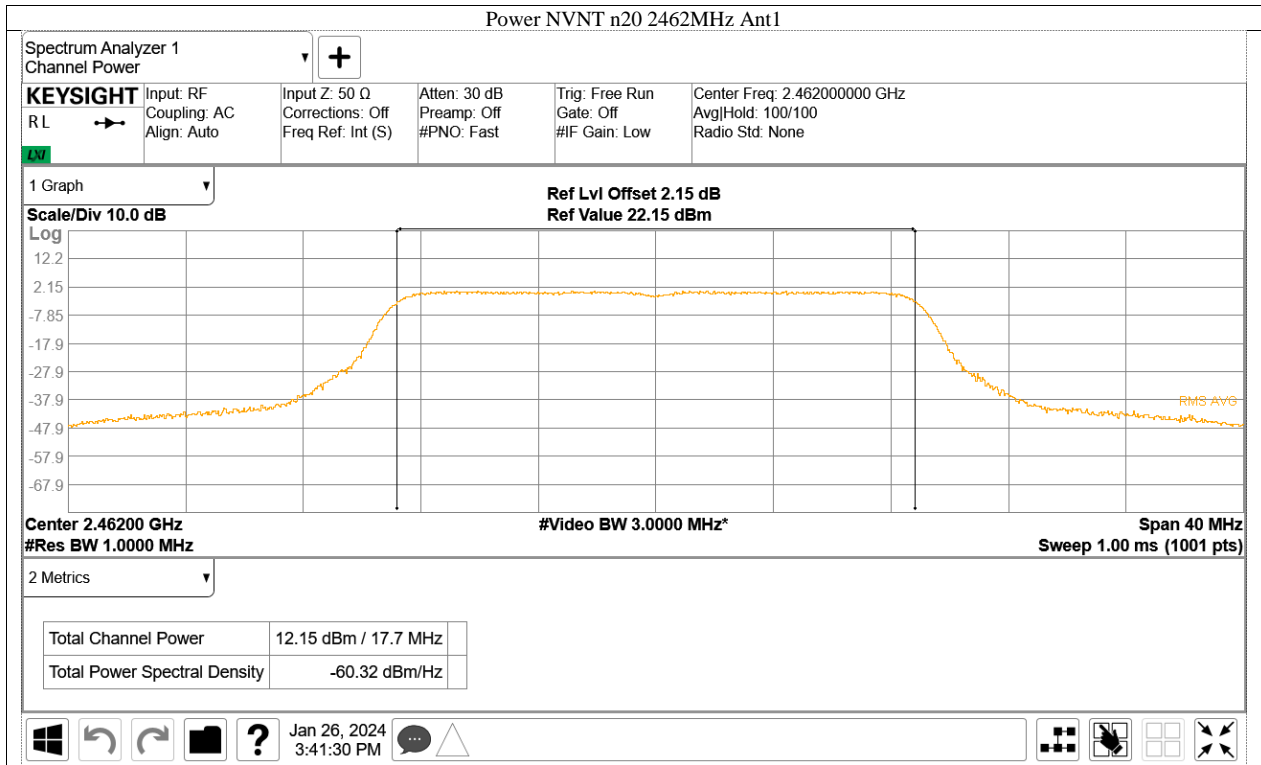





## 9.2 6dB bandwidth

### Test Method

1. The RF output of EUT was connected to the spectrum analyzer. The path loss was compensated to the results for each measurement.
2. Set to the maximum power setting, the instrument center frequency is set to the nominal EUT channel center frequency enable the EUT transmit continuously.
3. Use the following spectrum analyzer settings:  
RBW=100KHz, VBW≥3RBW, Sweep = auto, Detector function = peak, Trace = max hold
4. Use the automatic bandwidth measurement capability of an instrument, use the X dB bandwidth mode with X set to 6 dB.
5. Allow the trace to stabilize, record the 6 dB Bandwidth value.

### Limit

**Limit [kHz]**

---

≥500

### Test result

Test Mode	Frequency MHz	6dB bandwidth (MHz)		Result
		result	limit	verdict
802.11b	2412	9.044	≥0.5	Pass
	2437	9.106	≥0.5	Pass
	2462	10.03	≥0.5	Pass
802.11g	2412	16.343	≥0.5	Pass
	2437	16.335	≥0.5	Pass
	2462	16.327	≥0.5	Pass
802.11n(HT20)	2412	17.539	≥0.5	Pass
	2437	17.55	≥0.5	Pass
	2462	17.545	≥0.5	Pass



6 dB Bandwidth

11B\_Ant1\_2412

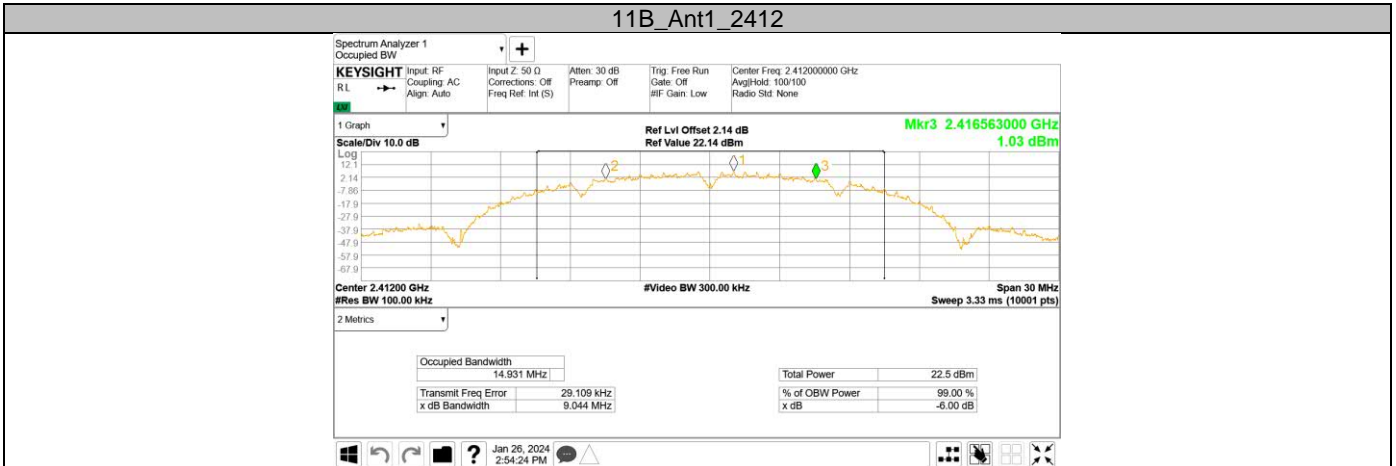

11B\_Ant1\_2437

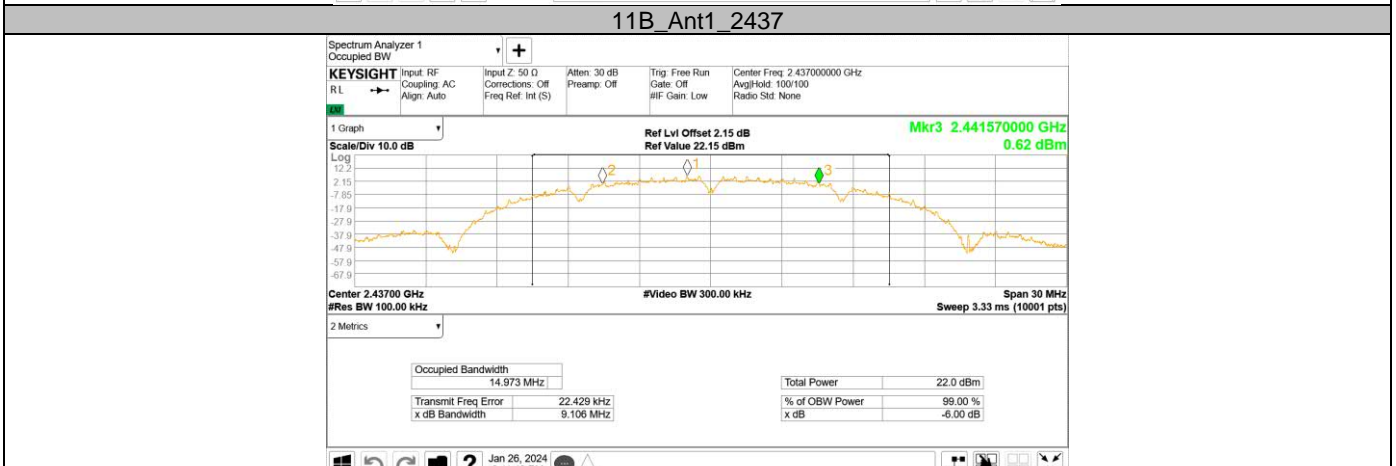

11B\_Ant1\_2462

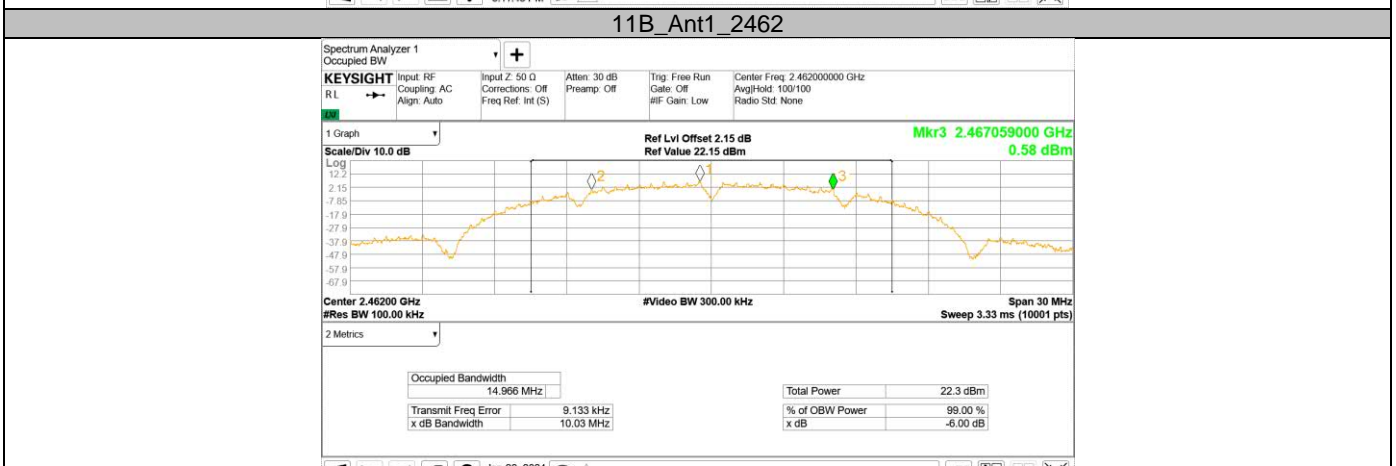

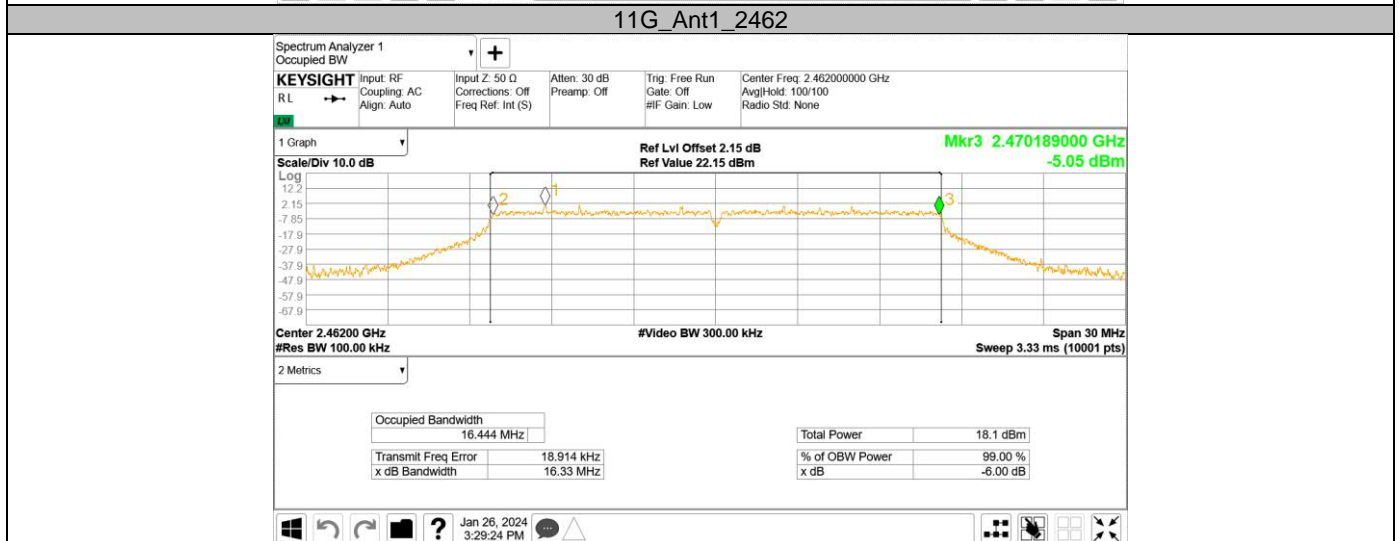
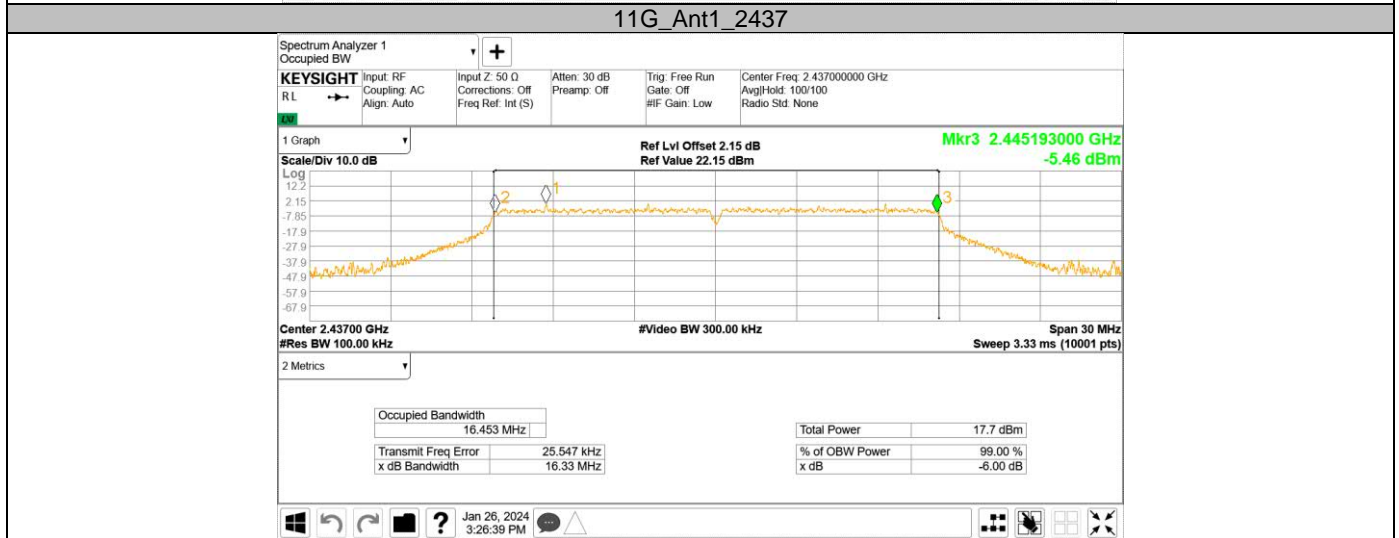
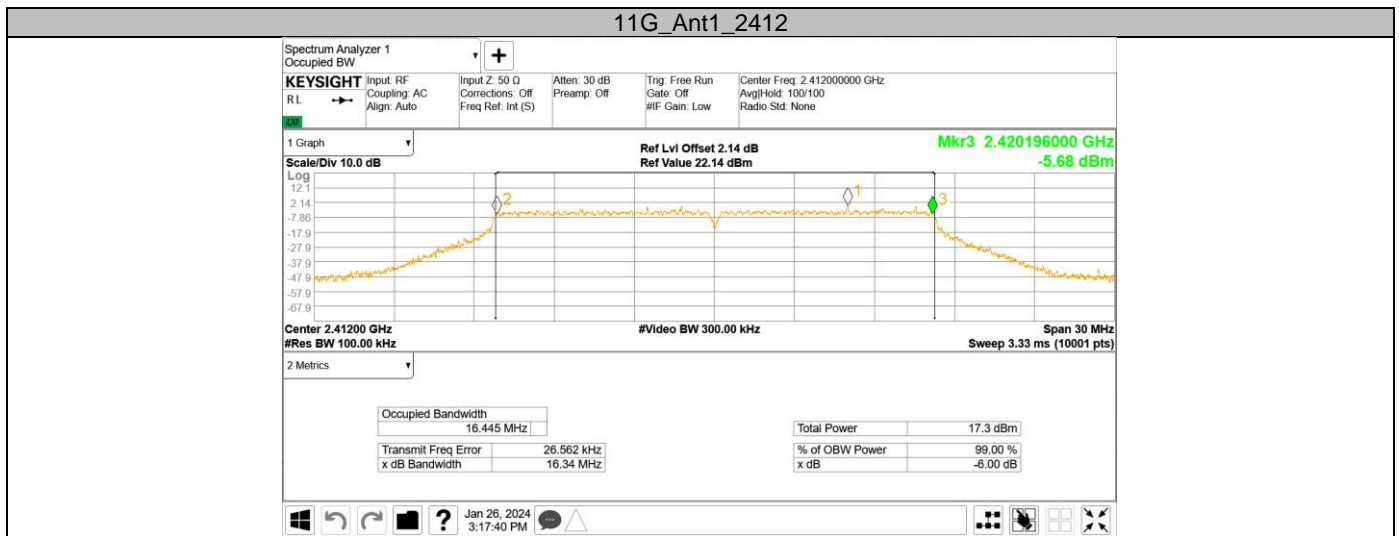

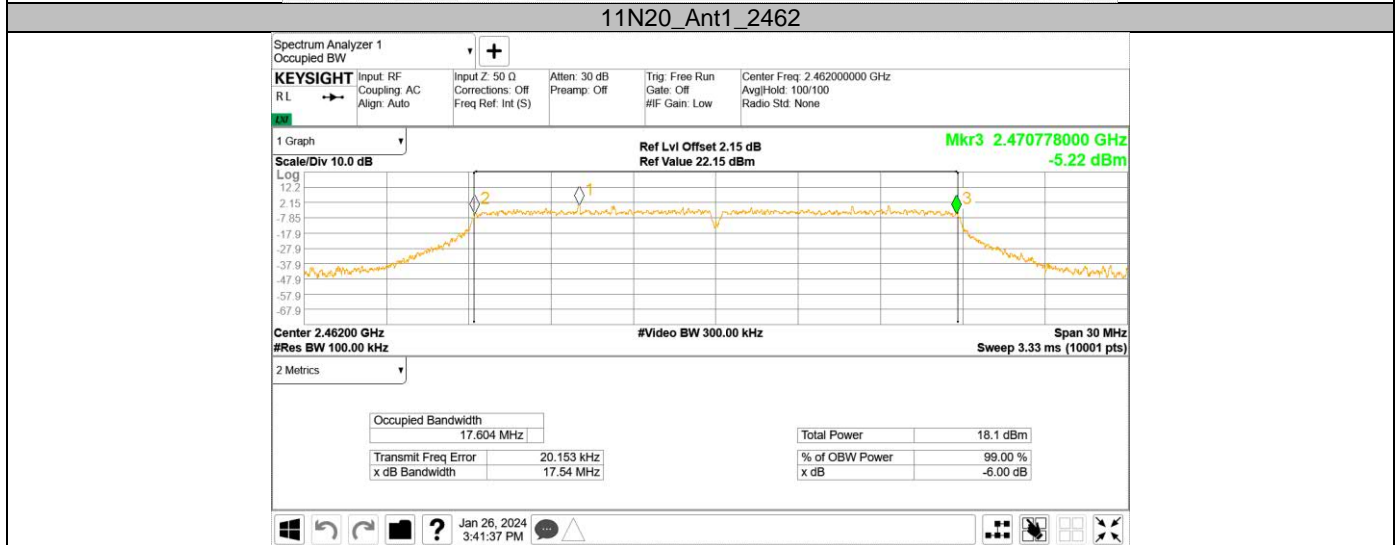
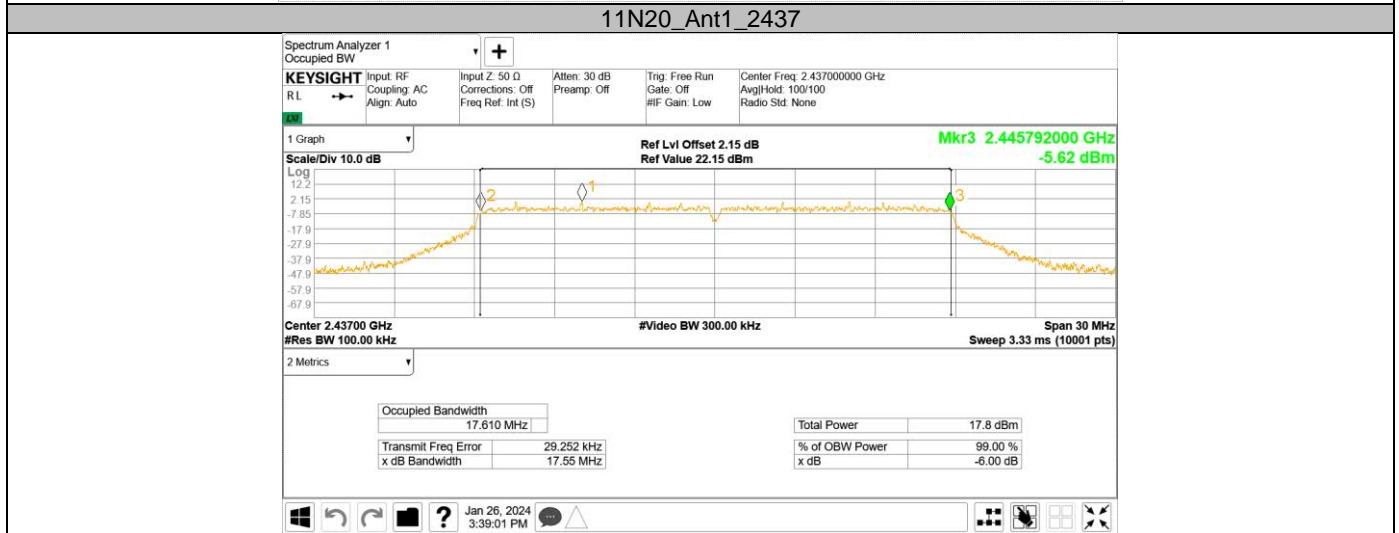
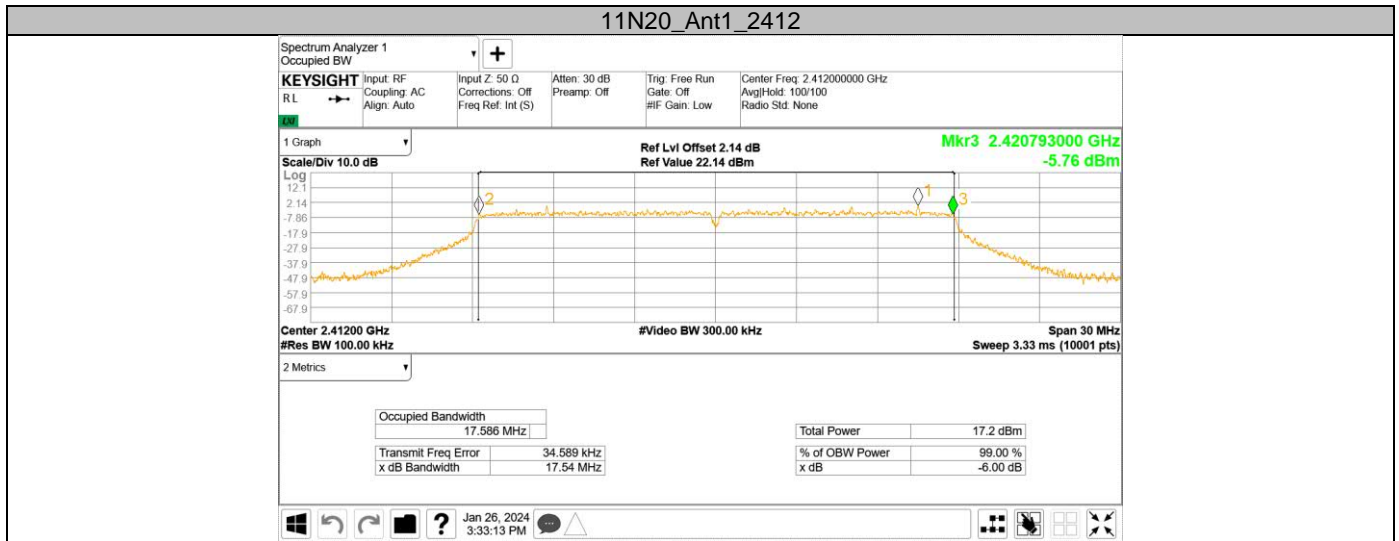



### 9.3 Power spectral density

#### Test Method

This procedure shall be used if maximum peak conducted output power was used to demonstrate compliance:

1. The RF output of EUT was connected to the spectrum analyzer. The path loss was compensated to the results for each measurement.
2. Set to the maximum power setting, the instrument center frequency is set to the nominal EUT channel center frequency enable the EUT transmit continuously.
3. Use the following spectrum analyzer settings:
4. Set analyzer center frequency to DTS channel center frequency. RBW=3kHz, VBW≥3RBW, Span=1.5 times DTS bandwidth, Detector=Peak, Sweep=auto, Trace= max hold.
5. Allow trace to fully stabilize, use the peak marker function to determine the maximum amplitude level within the RBW.
6. Repeat above procedures until other frequencies measured were completed.

#### Limit

Limit [dBm/3kHz]

≤8

Test result  
802.11 b

Frequency MHz	Power spectral density dBm/3kHz	Result
Low channel 2412MHz	-6.76	Pass
Middle channel 2437MHz	-6.77	Pass
High channel 2462MHz	-7.30	Pass

802.11 g

Frequency MHz	Power spectral density dBm/3kHz	Result
Low channel 2412MHz	-12.94	Pass
Middle channel 2437MHz	-13.25	Pass
High channel 2462MHz	-12.93	Pass

802.11 n (HT20)

Frequency MHz	Power spectral density dBm/3kHz	Result
Low channel 2412MHz	-11.87	Pass
Middle channel 2437MHz	-12.68	Pass
High channel 2462MHz	-13.33	Pass



### Power spectral density

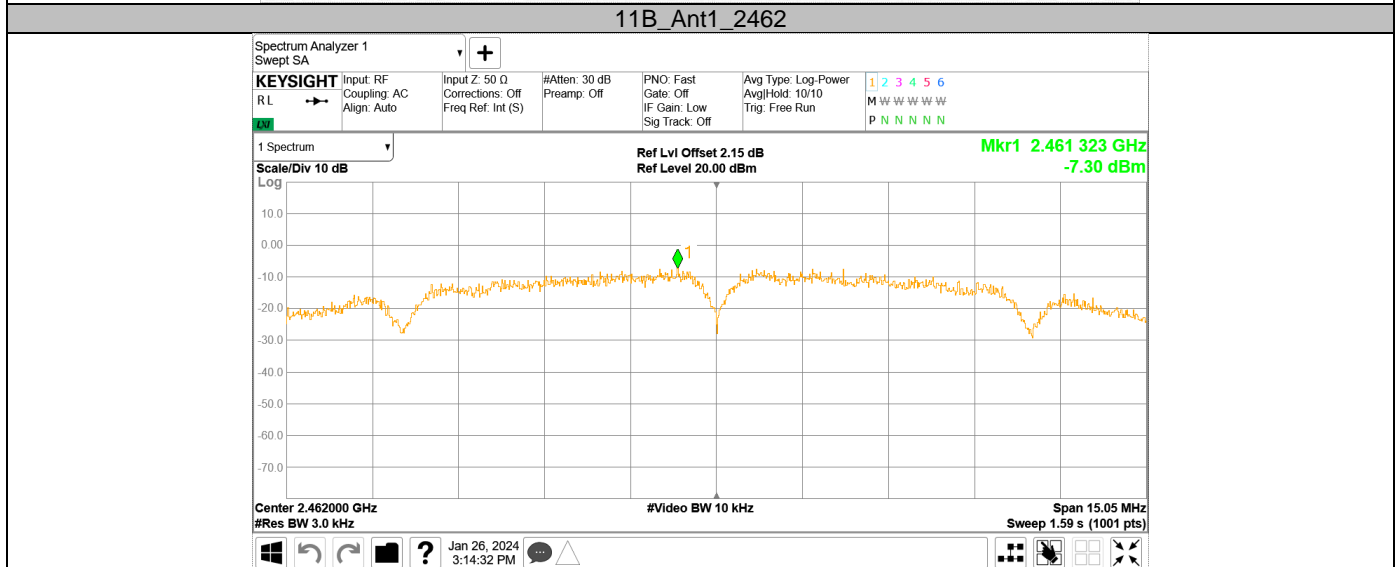
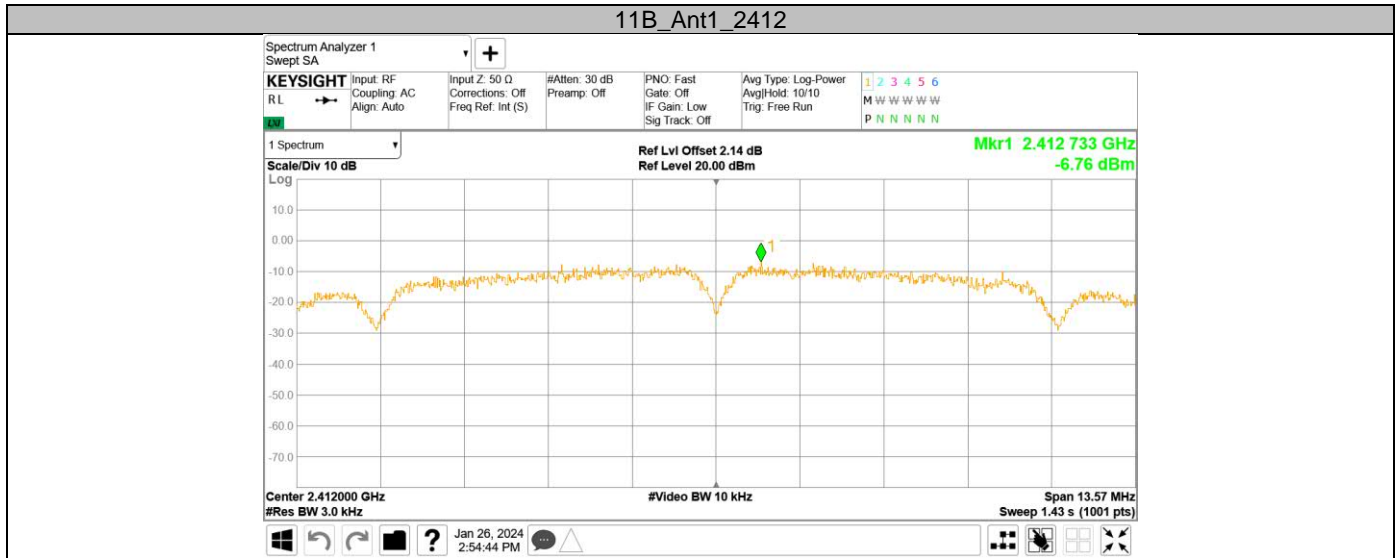



11G\_Ant1\_2412

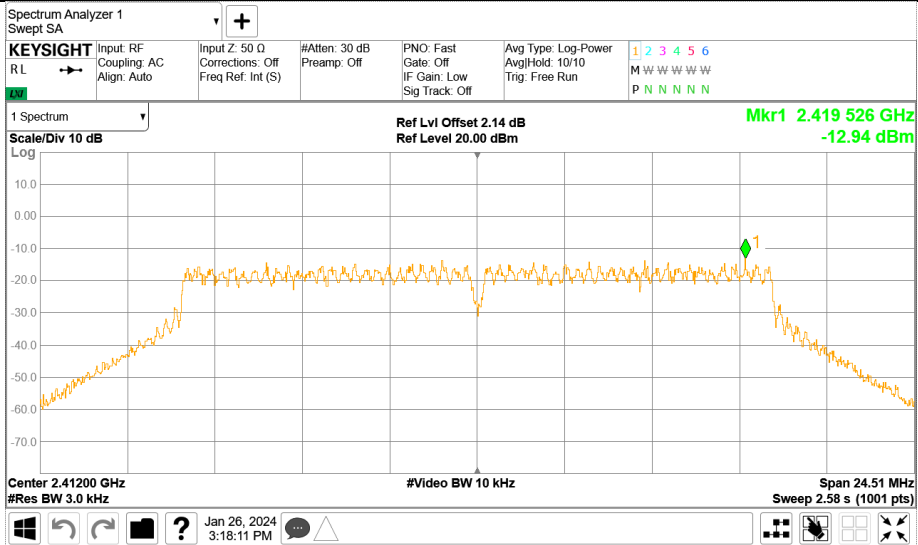

11G\_Ant1\_2437

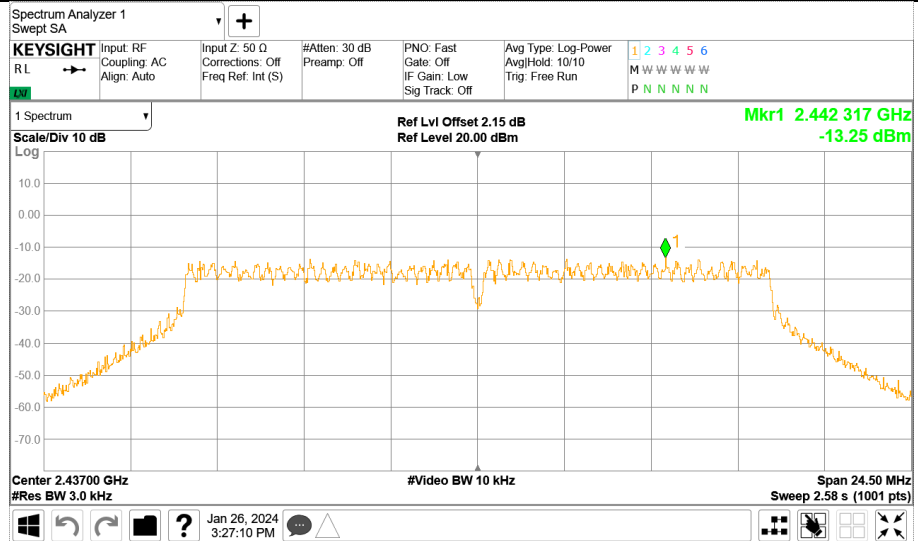

11G\_Ant1\_2462

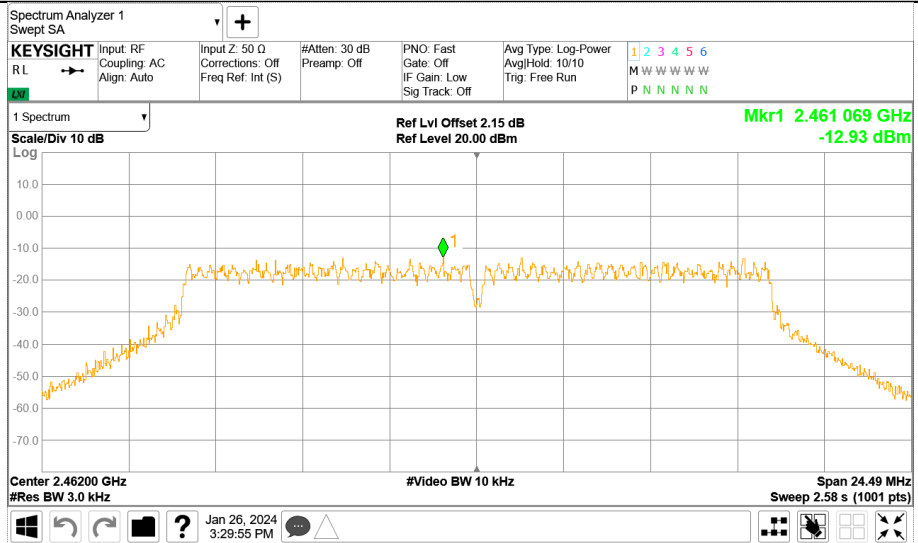





11N20SISO\_Ant1\_2412

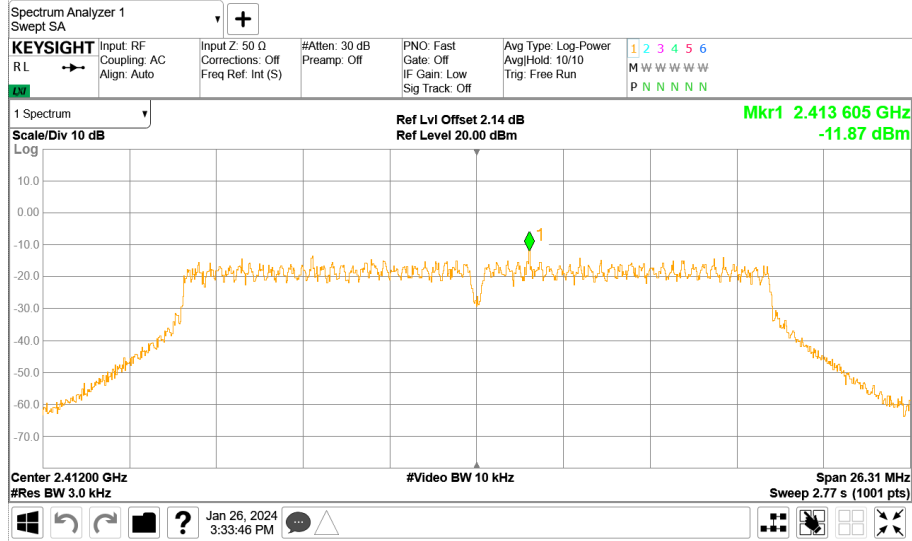

11N20SISO\_Ant1\_2437

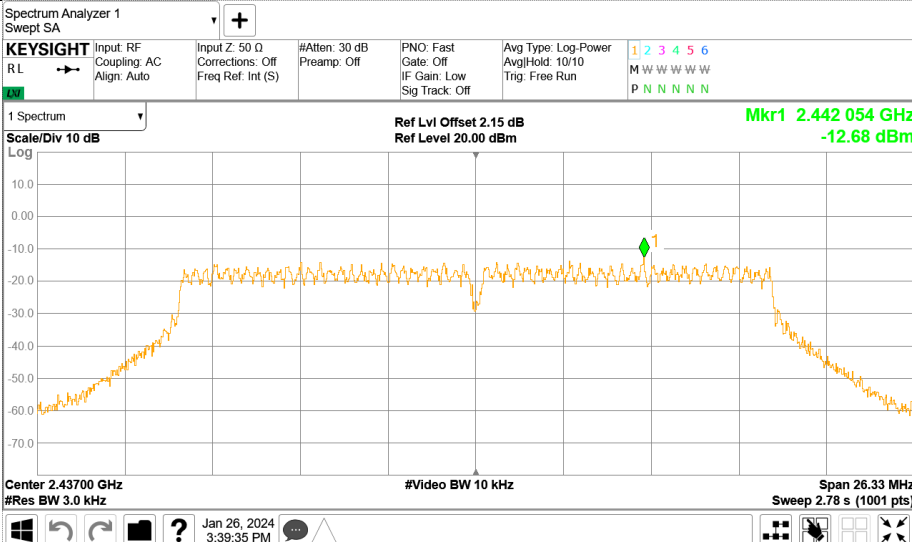

11N20SISO\_Ant1\_2462







## 9.4 Spurious RF conducted emissions

### Test Method

1. The RF output of EUT was connected to the spectrum analyzer by RF cable. The path loss was compensated to the results for each measurement.
2. Set to the maximum power setting, the instrument center frequency is set to the nominal EUT channel center frequency enable the EUT transmit continuously.
3. Use the following spectrum analyzer settings:  
 Span = wide enough to capture the peak level of the in-band emission and all spurious emissions (e.g., harmonics) from the lowest frequency generated in the EUT up through the 10<sup>th</sup> harmonic. Typically, several plots are required to cover this entire span.  
 RBW = 100 kHz, VBW≥3RBW, Sweep = auto, Detector function = peak, Trace = max hold
4. Allow the trace to stabilize. Set the marker on the peak of any spurious emission recorded.
5. The level displayed must comply with the limit specified in this Section. Submit these plots.
6. Repeat above procedures until all frequencies measured were complete.

### Limit

Frequency Range MHz	Limit (dBc)
30-25000	-20

**Spurious RF conducted emissions**

802.11 B

Out-of-Band Emissions

Channel 1 (2412MHz)

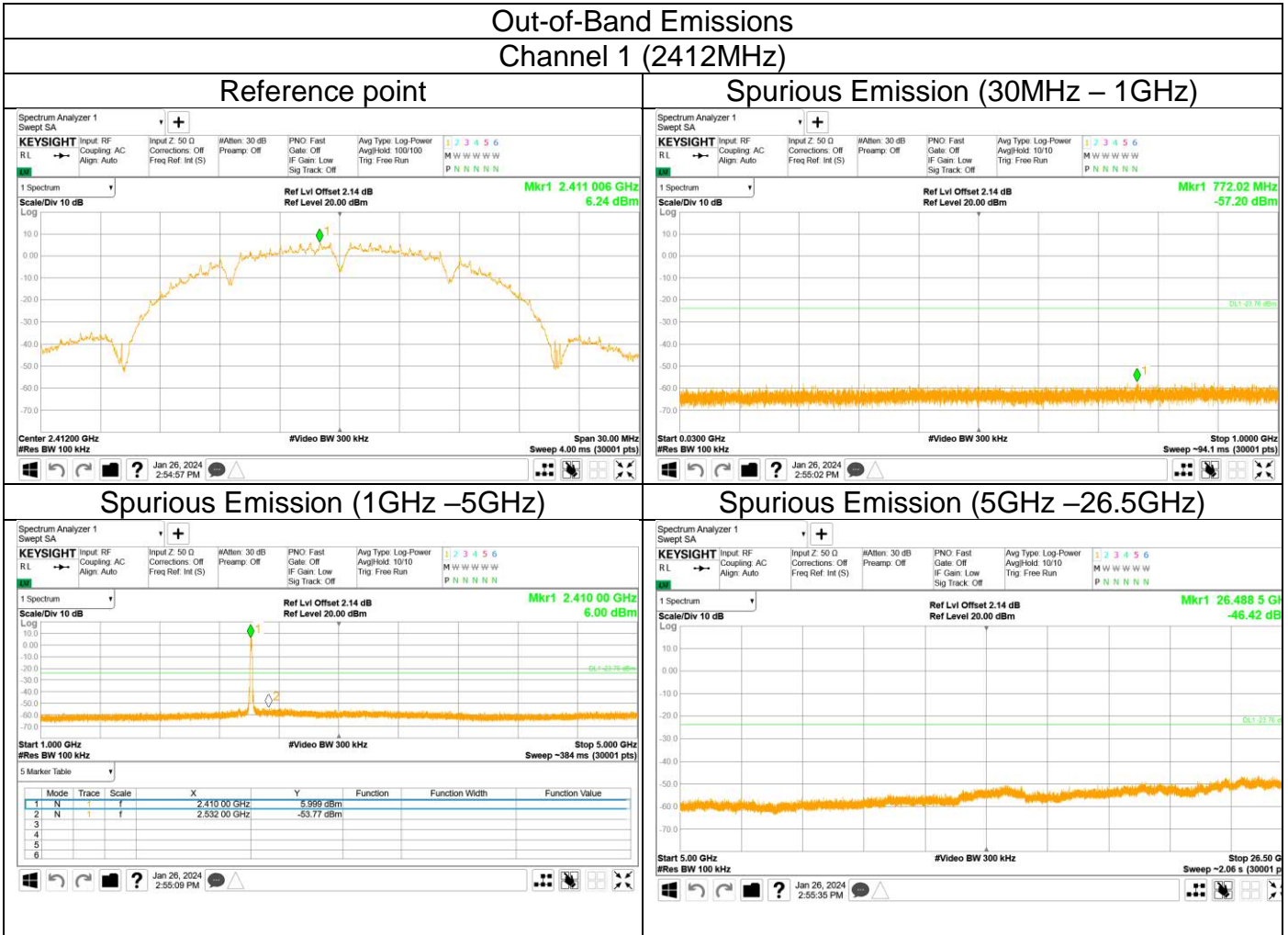



## Out-of-Band Emissions Channel 6 (2437MHz)

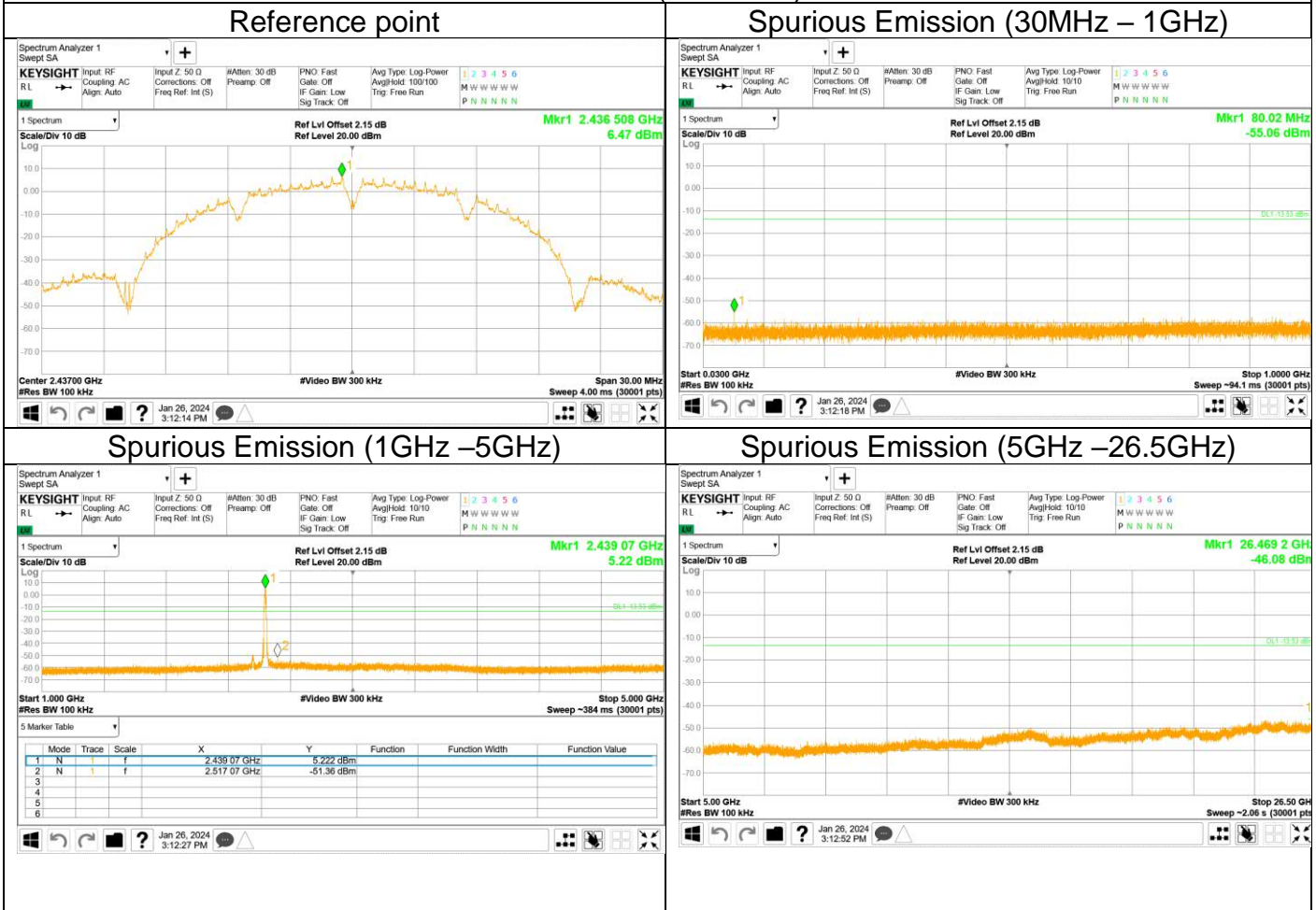



Out-of-Band Emissions  
Channel 11 (2462MHz)

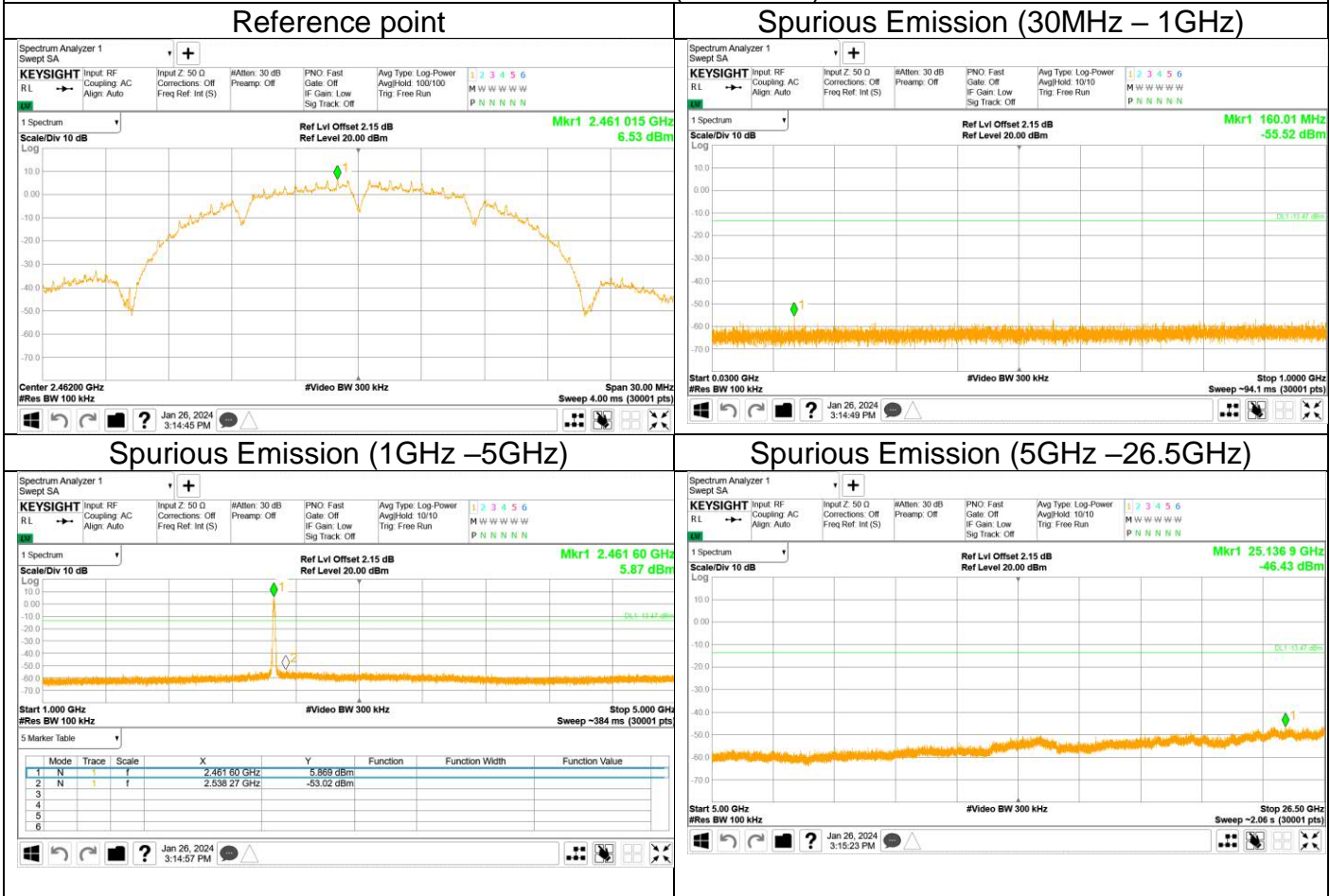



802.11 G

Out-of-Band Emissions  
Channel 1 (2412MHz)

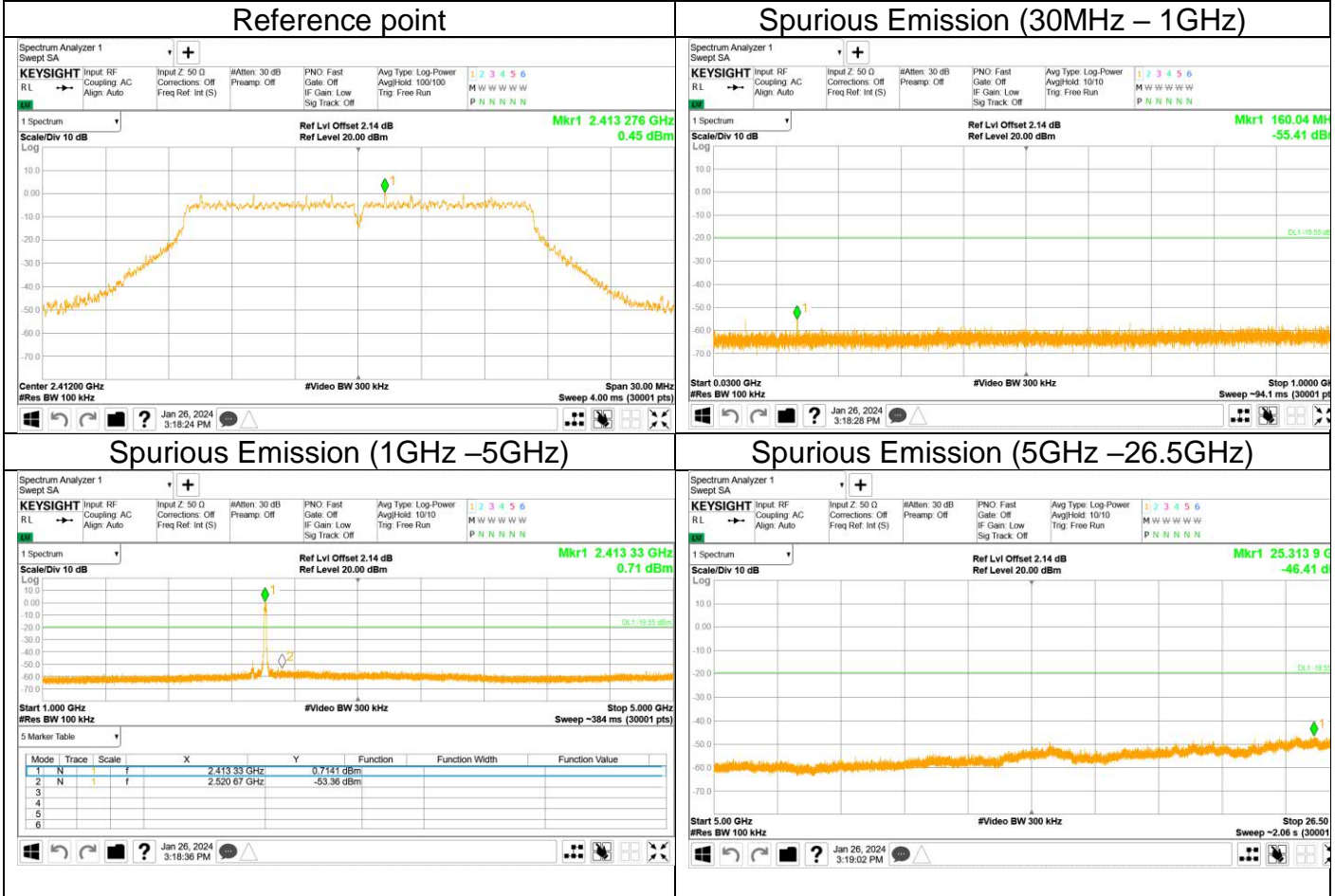



### Out-of-Band Emissions Channel 6 (2437MHz)

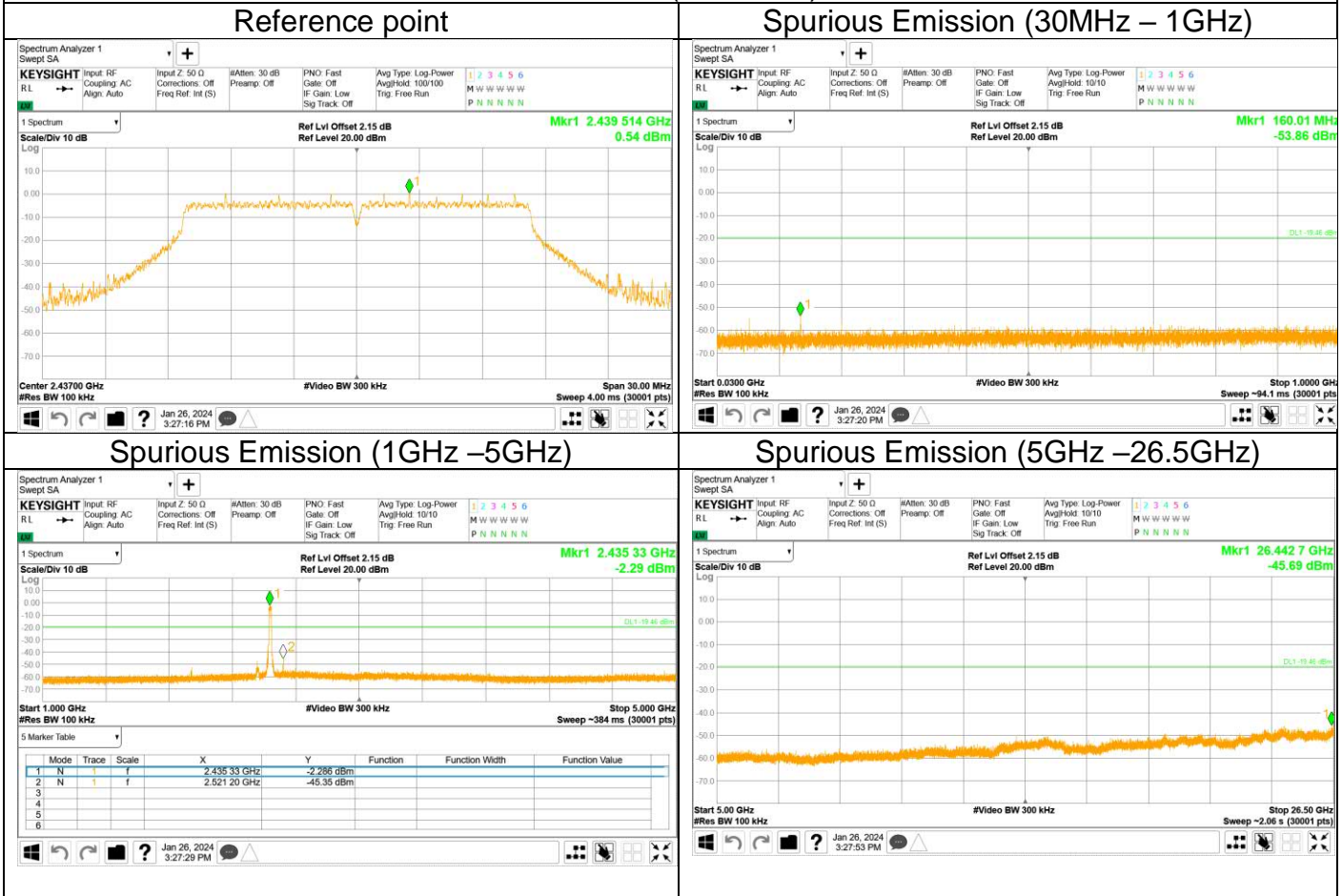





## Out-of-Band Emissions Channel 11 (2462MHz)

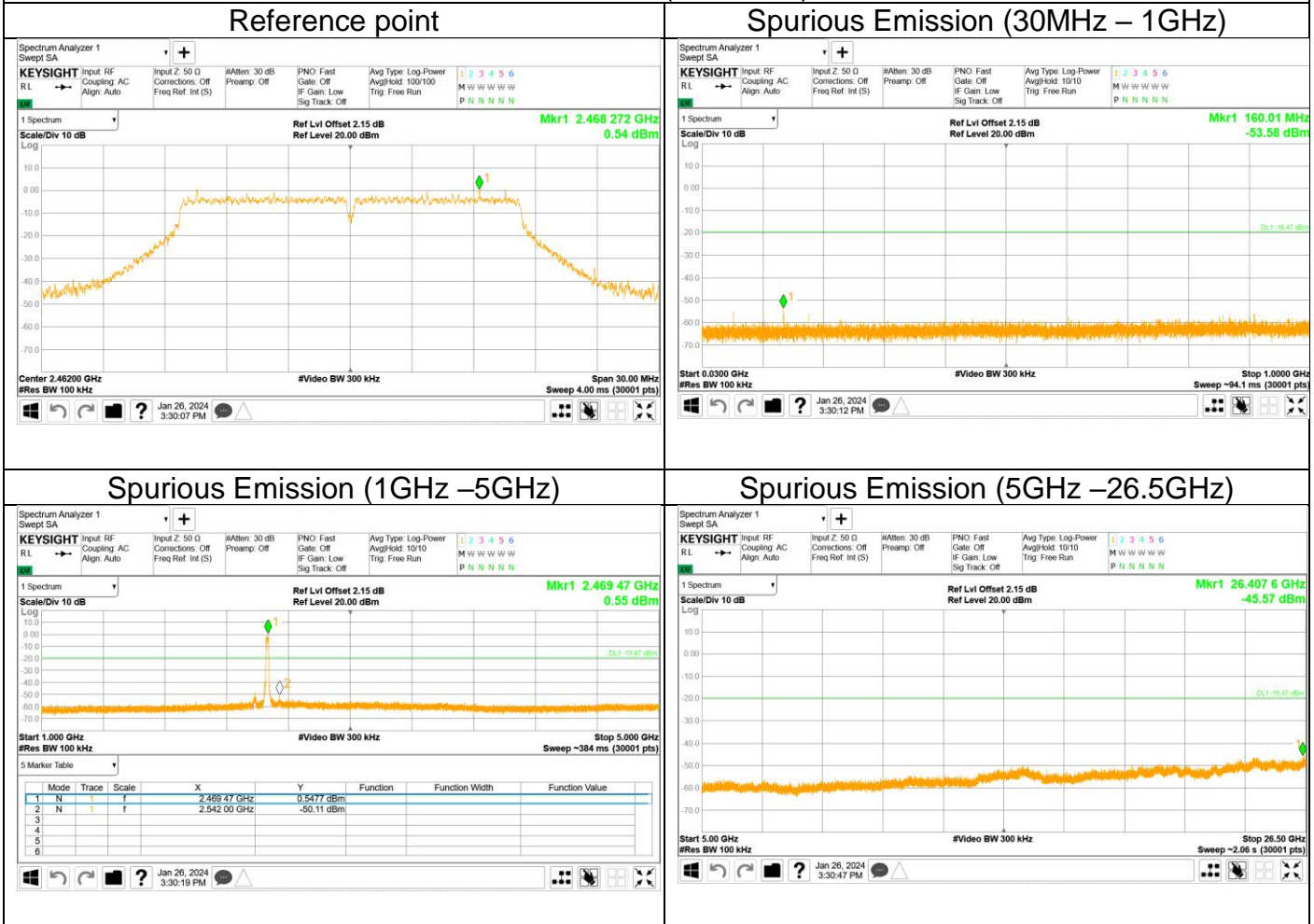



802.11 N HT20

Out-of-Band Emissions

Channel 1 (2412MHz)

Reference point



Spurious Emission (30MHz – 1GHz)

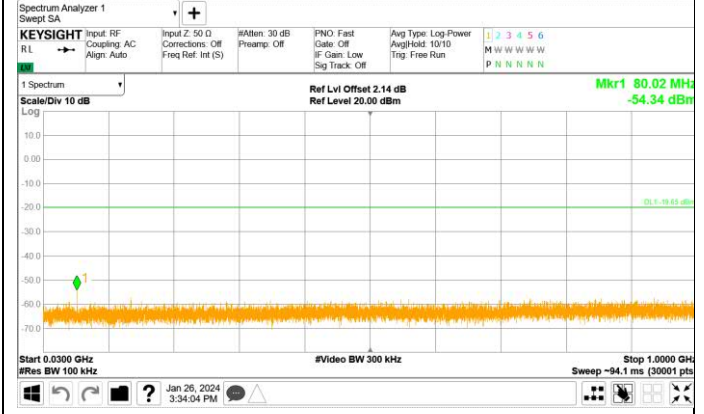

Spurious Emission (1GHz –5GHz)



Spurious Emission (5GHz –26.5GHz)







## Out-of-Band Emissions Channel 6 (2437MHz)

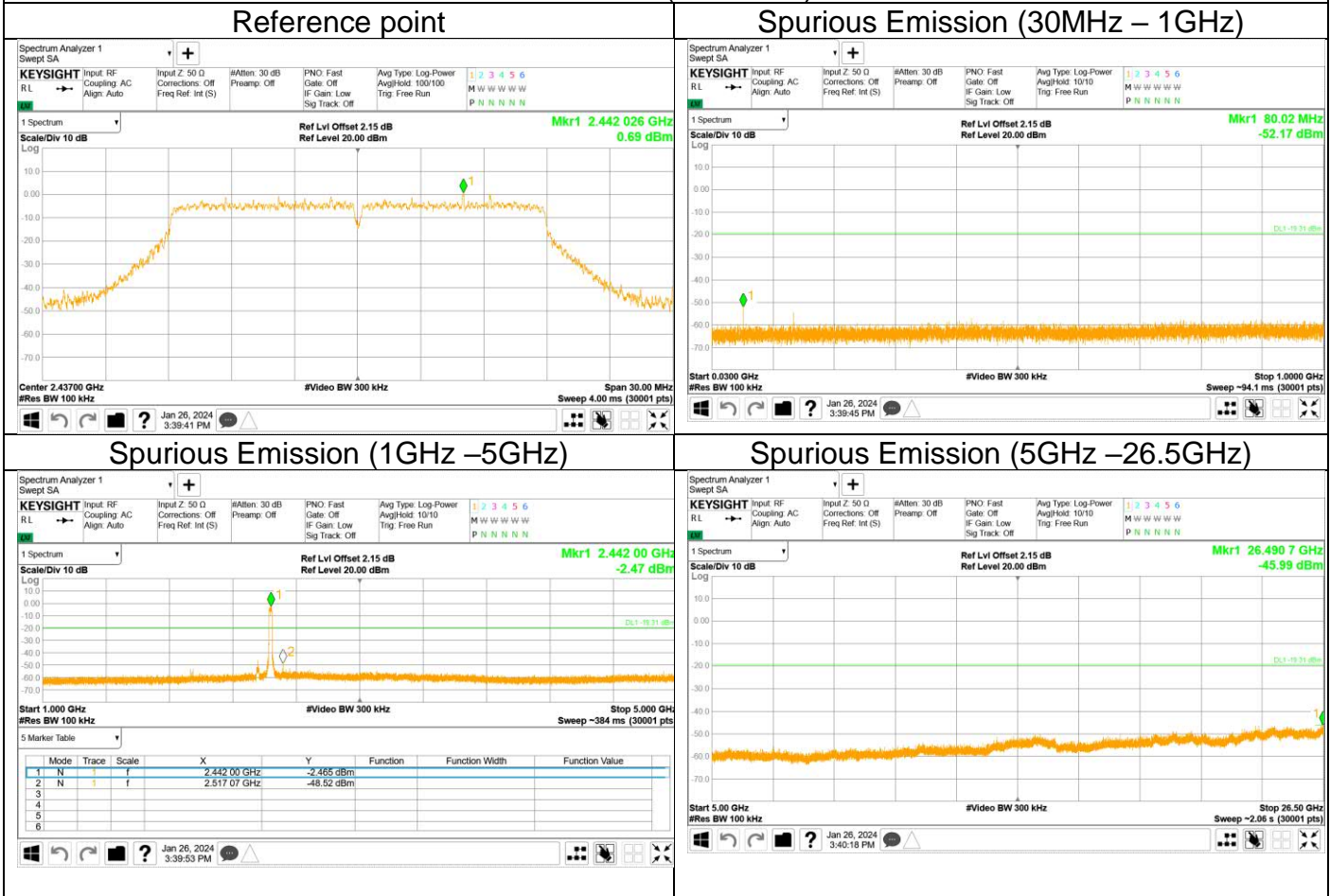



## Out-of-Band Emissions Channel 11 (2462MHz)

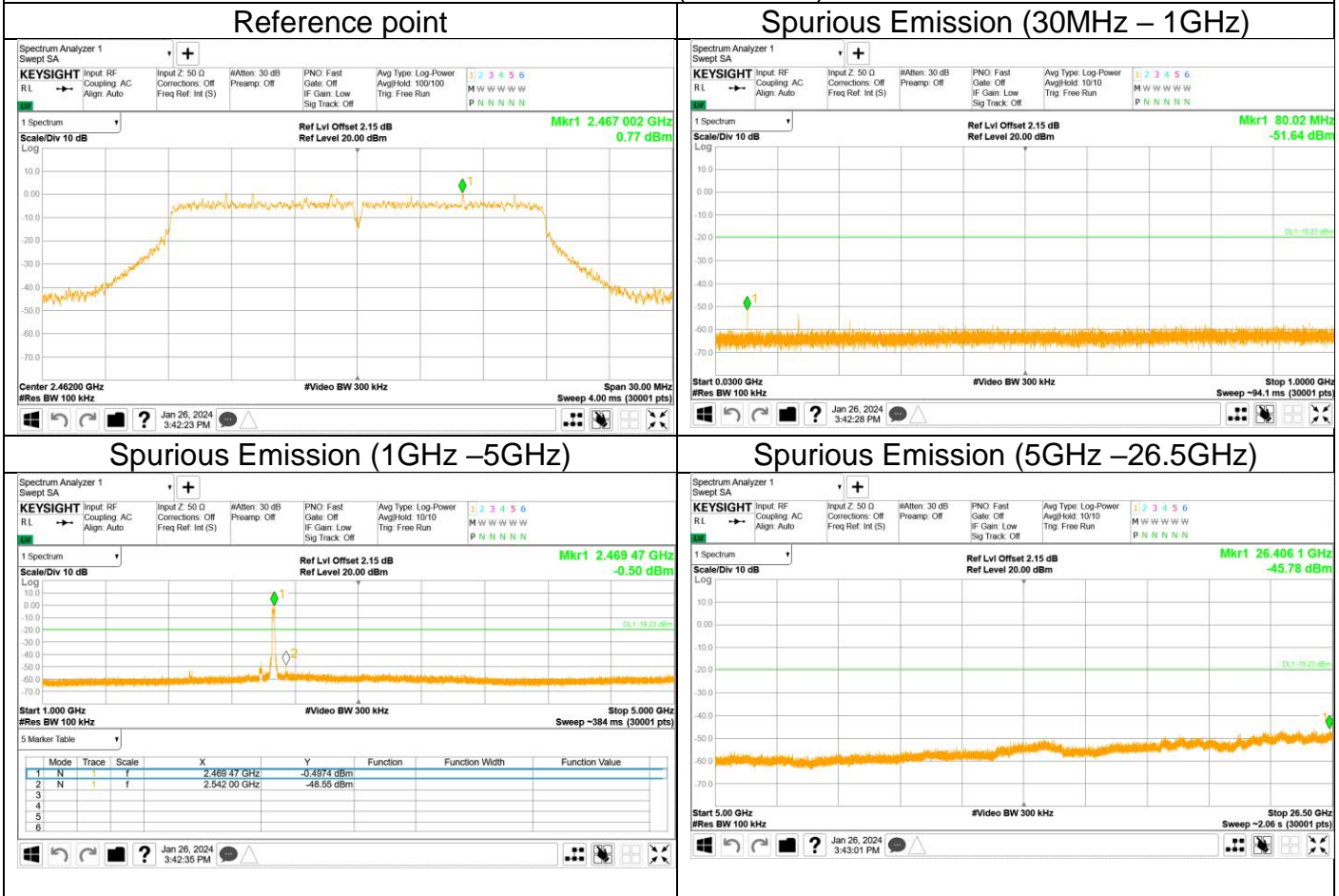

## 9.5 Band edge

### Test Method

1. The RF output of EUT was connected to the spectrum analyzer by RF cable. The path loss was compensated to the results for each measurement.
2. Set to the maximum power setting, the instrument center frequency is set to the nominal EUT channel center frequency enable the EUT transmit continuously.
3. Use the following spectrum analyzer settings:  
Span = wide enough to capture the peak level of the in-band emission and all spurious  
RBW = 100 kHz, VBW $\geq$ 3RBW, Sweep = auto, Detector function = peak, Trace = max hold
4. Allow the trace to stabilize, use the peak and delta measurement to record the result.
5. The level displayed must comply with the limit specified in this Section.
6. Repeat above procedures until all frequencies measured were complete and submit all the plots.

### Limit

In any 100 kHz bandwidth outside the frequency band in which the spread spectrum or digitally modulated device is operating, the RF power that is produced shall be at least 20 dB below that in the 100 kHz bandwidth within the band that contains the highest level of the desired power, based on either an RF conducted or a radiated measurement, provided that the transmitter demonstrates compliance with the peak conducted power limits. If the transmitter complies with the conducted power limits based on the use of RMS averaging over a time interval, as permitted under § 15.247(b)(3), the attenuation required shall be 30 dB instead of 20 dB.



Test result

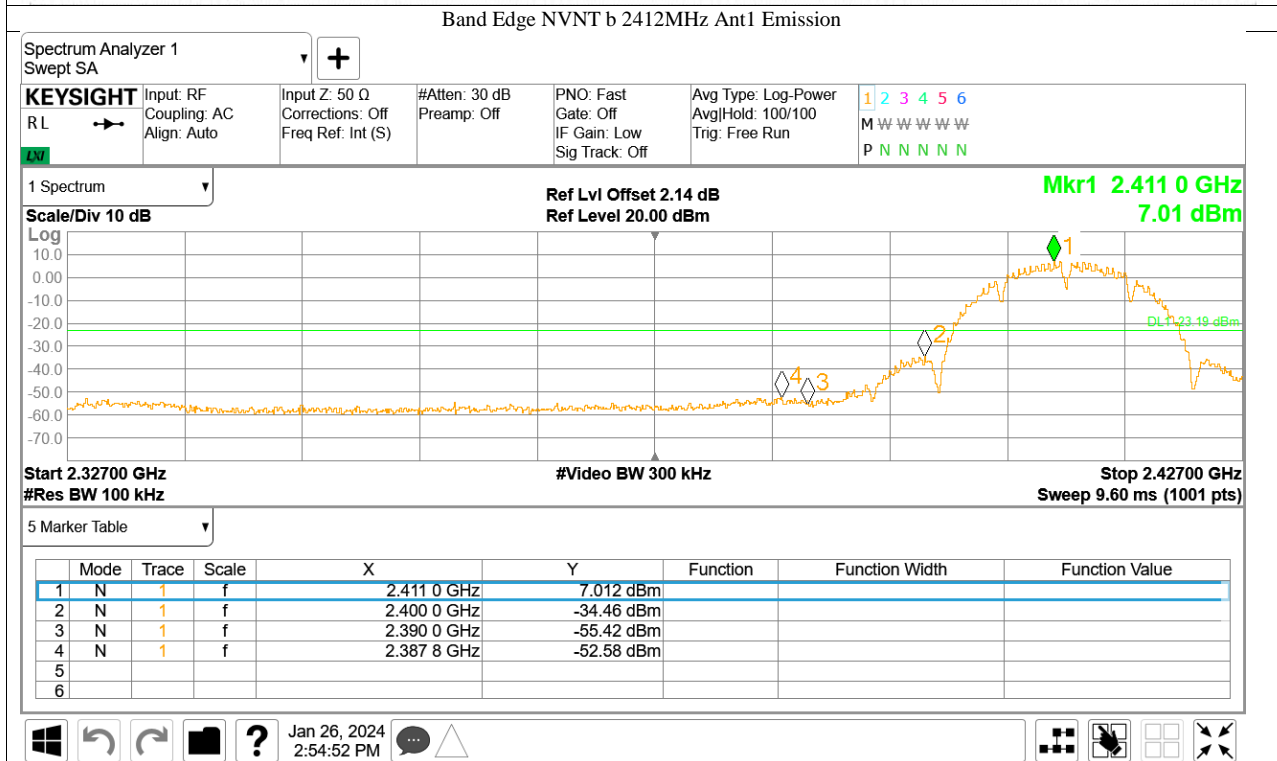

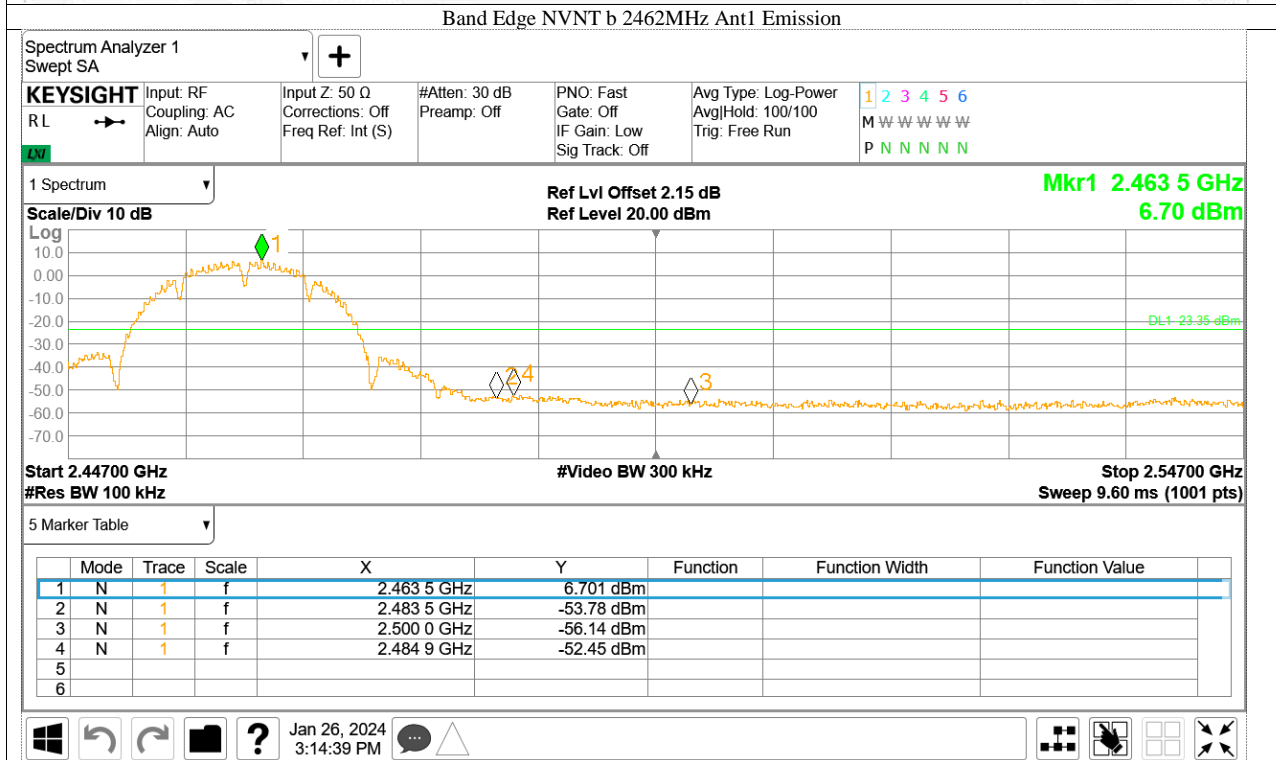

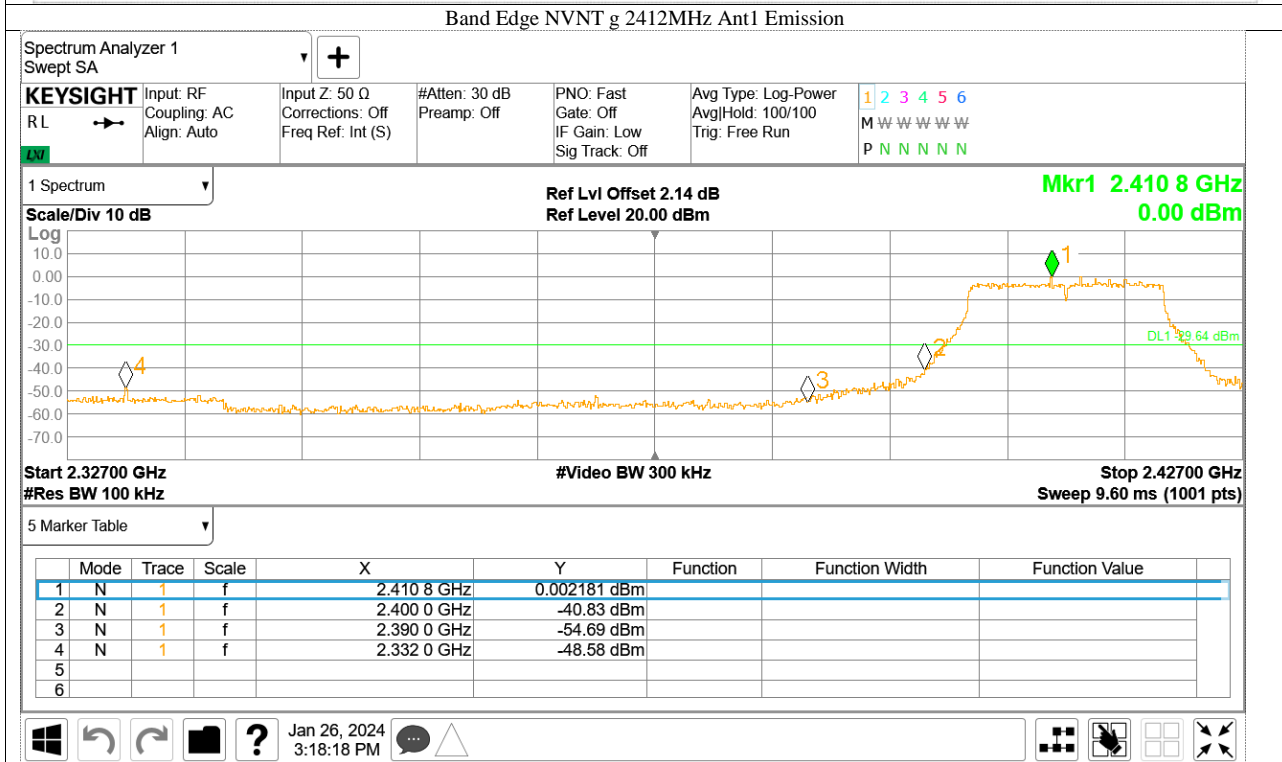



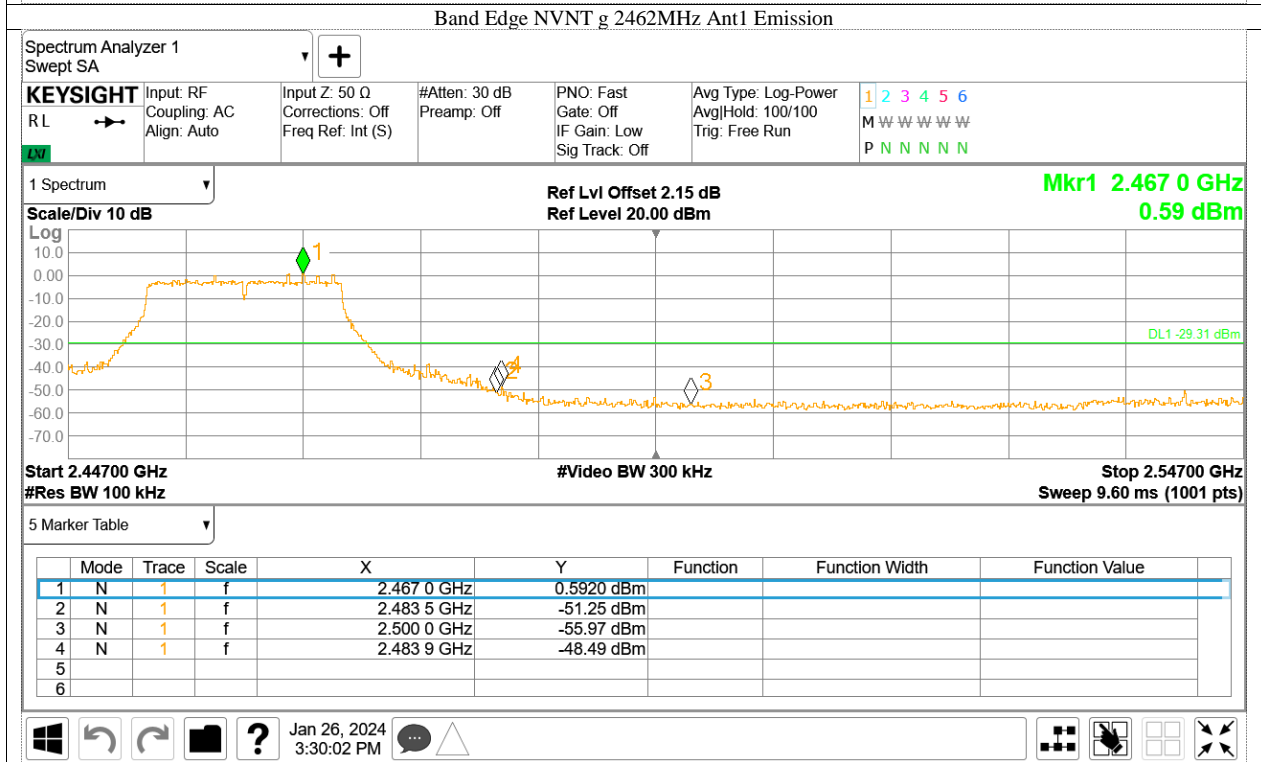
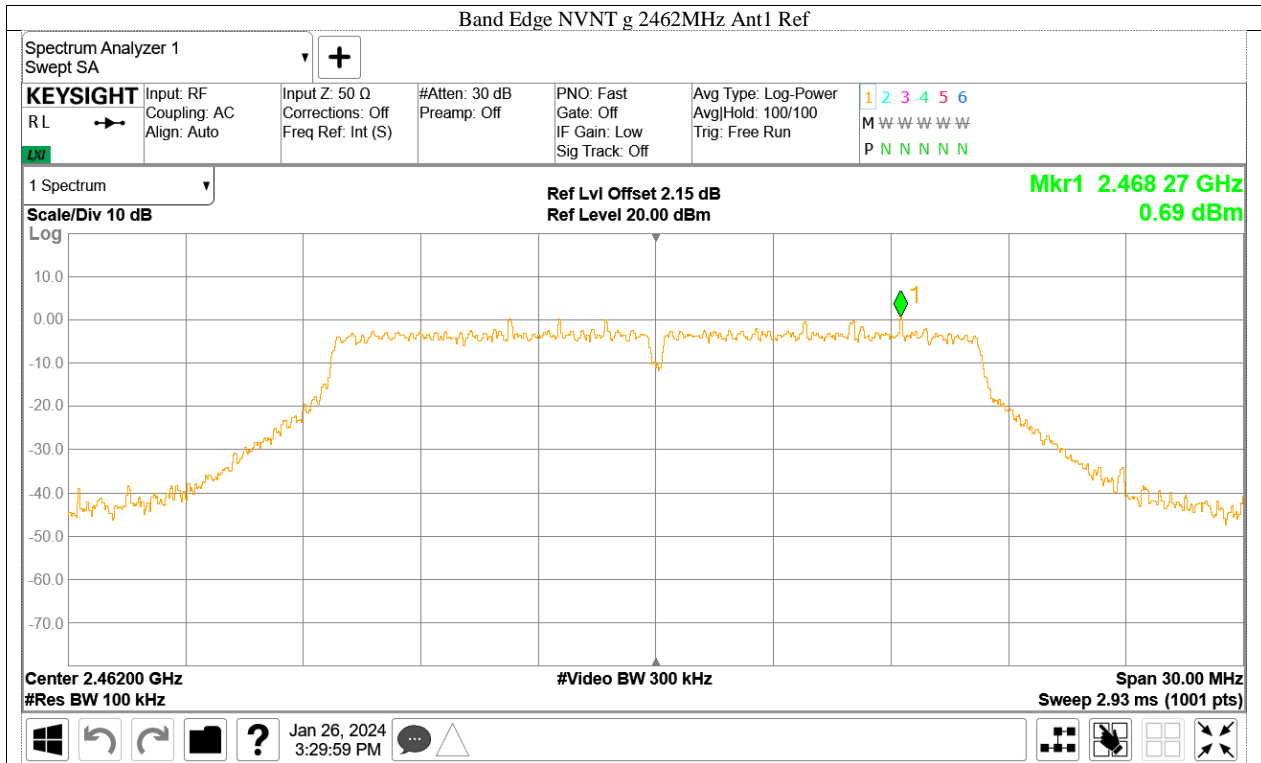

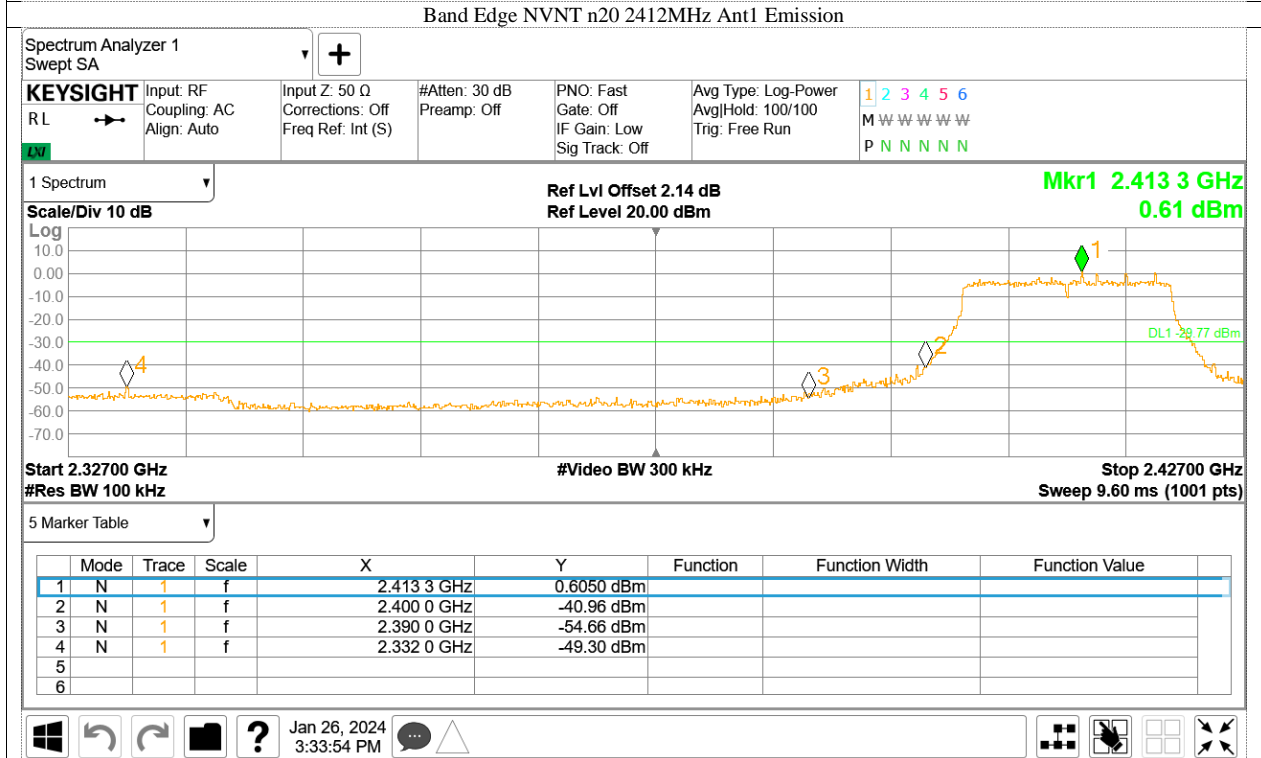
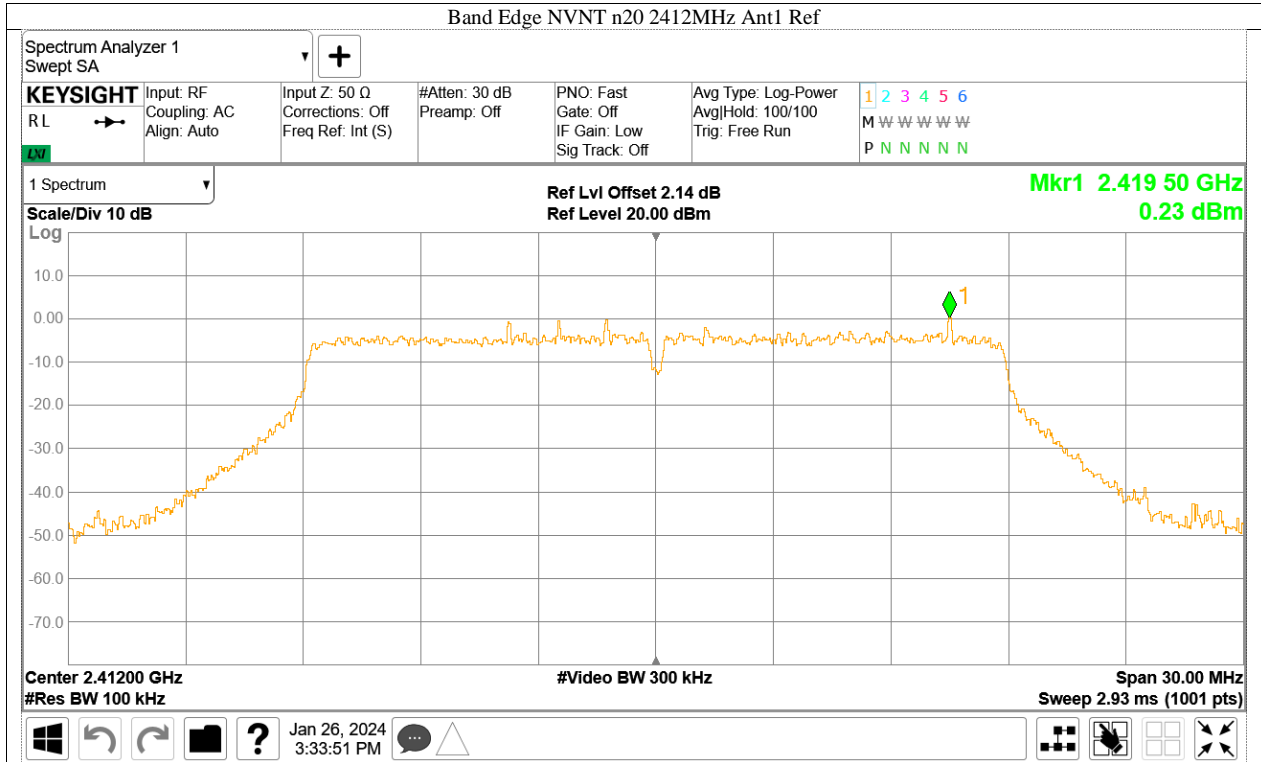



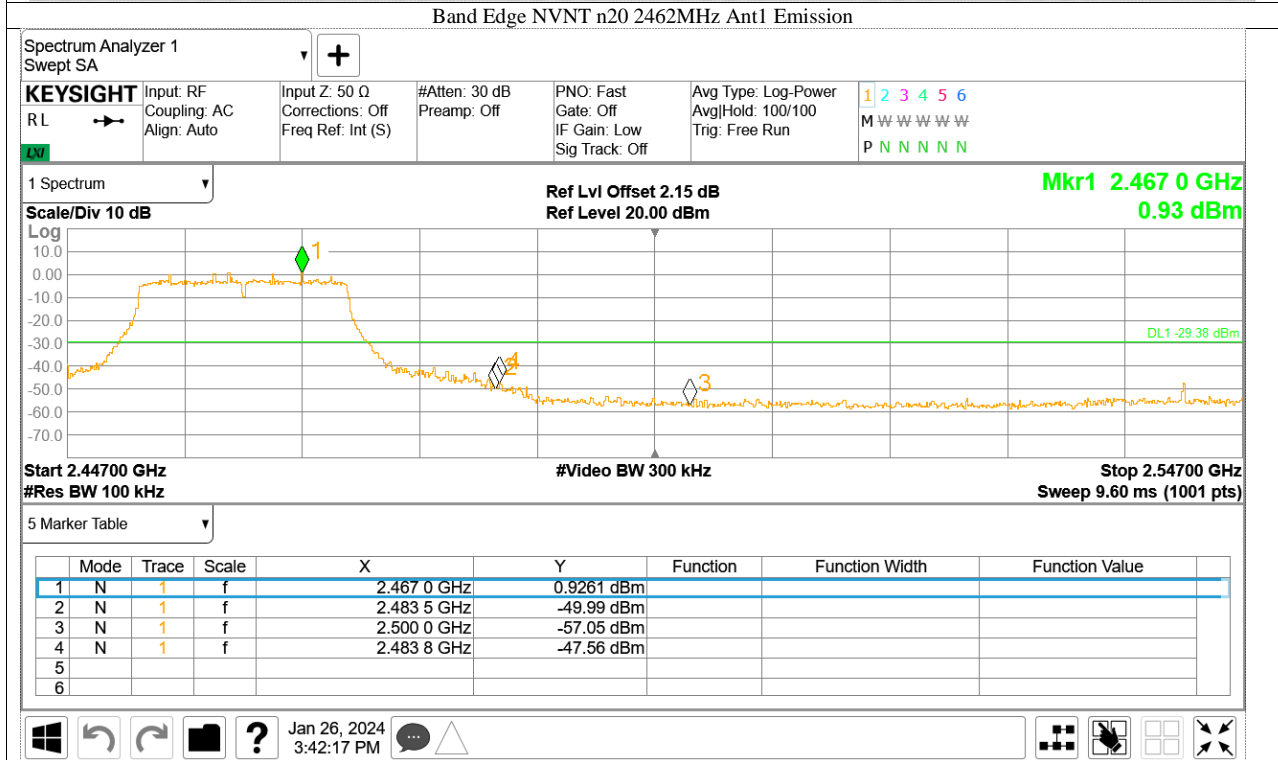
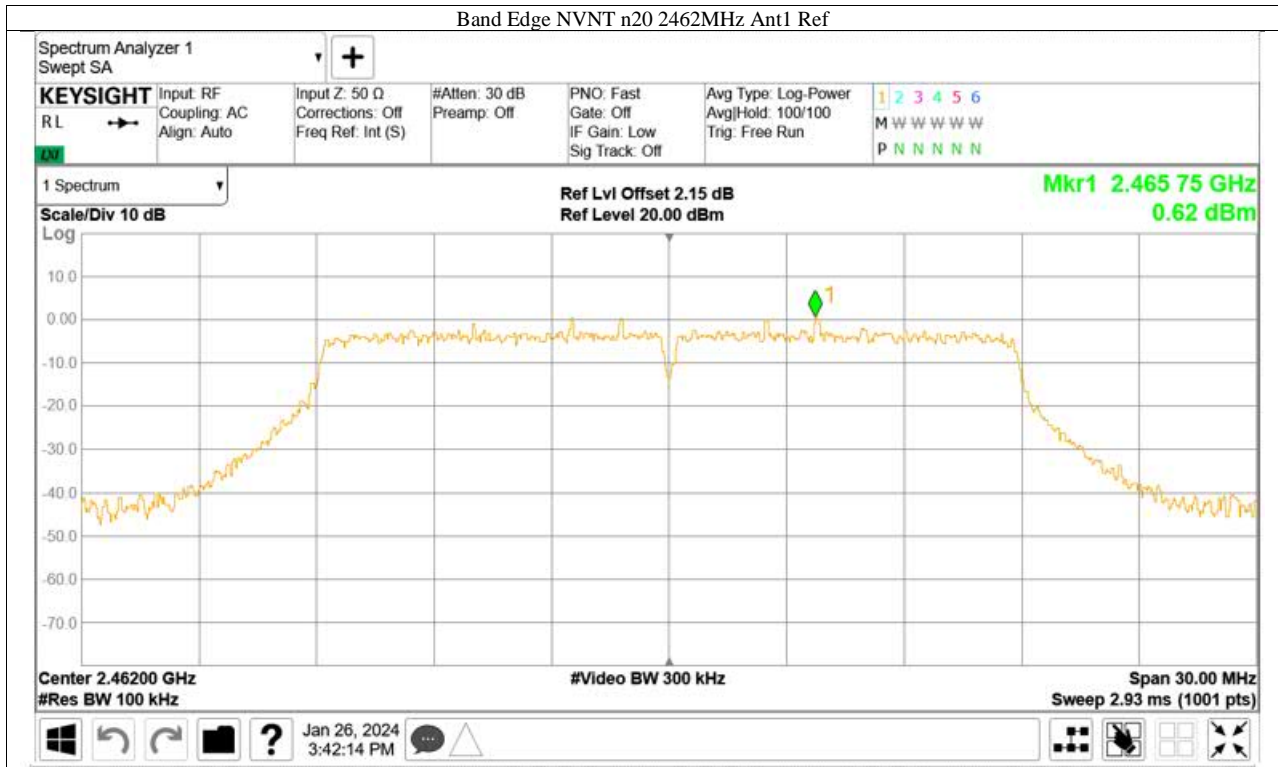

## 9.6 Spurious radiated emissions for transmitter

### Test Method

1. The EUT was placed on a turn table which is 1.5m above ground plane for above 1GHz and 0.8m above ground for below 1GHz at 3 meter chamber room for test. The table was rotated 360 degrees to determine the position of the highest radiation.
2. The EUT was set 3 meters away from the interference – receiving antenna, which was mounted on the top of a variable – height antenna tower.
3. The height of antenna is varied from one meter to four meters above the ground to determine the maximum value of the field strength. Both horizontal and vertical polarizations of the antenna are set to make the measurement.
4. For each suspected emission, the EUT was arranged to its worst case and then the antenna was tuned to heights from 1 meter to 4 meters and the rotatable table was turned from 0 degrees to 360 degrees to find the maximum reading.
5. Use the following spectrum analyzer settings According to C63.10
  - 1) Procedure for Unwanted Emissions Measurements Below 1000 MHz  
Span = wide enough to capture the peak level of the in-band emission and all spurious  
RBW = 100 kHz to 120kHz, VBW ≥ RBW for peak measurement, Sweep = auto, Detector function = peak, Trace = max hold.
  - 2) For Peak unwanted emissions Above 1GHz:  
Span = wide enough to capture the peak level of the in-band emission and all spurious  
RBW = 1MHz, VBW ≥ RBW for peak measurement, Sweep = auto, Detector function = peak, Trace = max hold.  
Procedures for average unwanted emissions measurements above 1GHz
    - a) RBW = 1MHz.
    - b) VBW \ [3 × RBW].
    - c) Detector = RMS (power averaging), if [span / (# of points in sweep)] \ RBW / 2.  
Satisfying this condition can require increasing the number of points in the sweep or reducing the span. If the condition is not satisfied, then the detector mode shall be set to peak.
    - d) Averaging type = power (i.e., rms) (As an alternative, the detector and averaging type may be set for linear voltage averaging. Some instruments require linear display mode to use linear voltage averaging. Log or dB averaging shall not be used.)
    - e) Sweep time = auto.
    - f) Perform a trace average of at least 100 traces if the transmission is continuous. If the transmission is not continuous, then the number of traces shall be increased by a factor of 1 / D, where D is the duty cycle. For example, with 50% duty cycle, at least 200 traces shall be averaged. (If a specific emission is demonstrated to be continuous—i.e., 100% duty cycle—then rather than turning ON and OFF with the transmit cycle, at least 100 traces shall be averaged.)
    - g) If tests are performed with the EUT transmitting at a duty cycle less than 98%, then a correction factor shall be added to the measurement results prior to comparing with the emission limit, to compute the emission level that would have been measured had the test been performed at 100% duty cycle. The correction factor is computed as follows:
      - 1) If power averaging (rms) mode was used in the preceding step e), then the correction factor is  $[10 \log (1 / D)]$ , where D is the duty cycle. For example, if the transmit duty cycle was 50%, then 3 dB shall be added to the measured emission levels.



2) If linear voltage averaging mode was used in the preceding step e), then the correction factor is  $[20 \log (1 / D)]$ , where D is the duty cycle. For example, if the transmit duty cycle was 50%, then 6 dB shall be added to the measured emission levels.

3) If a specific emission is demonstrated to be continuous (100% duty cycle) rather than turning ON and OFF with the transmit cycle, then no duty cycle correction is required for that emission (AV) at frequency above 1GHz.

**Limit**

In any 100 kHz bandwidth outside the frequency band in which the spread spectrum or digitally modulated device is operating, the RF power that is produced shall be at least 20 dB below that in the 100 kHz bandwidth within the band that contains the highest level of the desired power, based on either an RF conducted or a radiated measurement, provided that the transmitter demonstrates compliance with the peak conducted power limits. If the transmitter complies with the conducted power limits based on the use of RMS averaging over a time interval, as permitted under § 15.247(b)(3), the attenuation required shall be 30 dB instead of 20 dB. Attenuation below the general field strength limits specified in § 15.209(a) is not required. In addition, radiated emissions which fall in the restricted bands, as defined in § 15.205(a), must also comply with the radiated emission limits specified in § 15.209(a).

Frequency MHz	Field Strength µV/m	Field Strength dBµV/m	Detector	Measurement distance meters
0.009-0.490	2400/F(kHz)	48.5-13.8	AV	300
0.490-1.705	24000/F(kHz)	33.8-23.0	QP	30
1.705-30	30	29.5	QP	30
30-88	100	40	QP	3
88-216	150	43.5	QP	3
216-960	200	46	QP	3
960-1000	500	54	QP	3
Above 1000	500	54	AV	3
Above 1000	5000	74	PK	3

Note 1:  $\text{Limit } 3\text{m(dB}\mu\text{V/m)} = \text{Limit } 300\text{m(dB}\mu\text{V/m)} + 40\text{Log}(300\text{m}/3\text{m})$  (Below 30MHz)

Note 2:  $\text{Limit } 3\text{m(dB}\mu\text{V/m)} = \text{Limit } 30\text{m(dB}\mu\text{V/m)} + 40\text{Log}(30\text{m}/3\text{m})$  (Below 30MHz)

### Spurious radiated emissions for transmitter

According to C63.10, if the peak (or quasi-peak) measured value complies with the average limit, it is unnecessary to perform an average measurement, so AV emission value did not show in below table if the peak value complies with average limit.

Data of measurement within frequency range 9kHz-30MHz is the noise floor or attenuated more than 20dB below the permissible limits or the field strength is too small to be measured, so test data does not present in this report.

### Transmitting spurious emission test result as below:

Test mode:802.11B (2412MHz)									
Frequency MHz	Original Receiver (dBuV/m)	Correct Factor (dB)	Measure Level (dBuV/m)	Limit (dBuV/M)	Margin (dB)	Hight (cm)	Azimuth (deg)	Detector	Polarization
2384.24	44.83	-4.80	40.03	74.00	33.97	298	23	PK	Hoizrnotal
4823.86	44.28	-1.80	42.48	74.00	31.52	102	254	PK	Hoizrnotal
2385.08	44.88	-4.80	40.08	74.00	33.92	150	127	PK	Vertical
4823.86	46.79	-1.80	44.99	74.00	29.01	230	19	PK	Vertical

Test mode:802.11B (2437MHz)									
Frequency MHz	Original Receiver (dBuV/m)	Correct Factor (dB)	Measure Level (dBuV/m)	Limit (dBuV/M)	Margin (dB)	Hight (cm)	Azimuth (deg)	Detector	Polarization
4873.73	44.38	-1.70	42.68	74.00	31.32	215	32	PK	Hoizrnotal
4873.73	45.48	-1.70	43.78	74.00	30.22	266	109	PK	Vertical

Test mode:802.11B (2462MHz)									
Frequency MHz	Original Receiver (dBuV/m)	Correct Factor (dB)	Measure Level (dBuV/m)	Limit (dBuV/M)	Margin (dB)	Hight (cm)	Azimuth (deg)	Detector	Polarization
2483.56	45.22	-2.70	42.52	74.00	31.48	206	189	PK	Hoizrnotal
4923.60	44.78	-1.50	43.28	74.00	30.72	111	330	PK	Hoizrnotal
2483.55	45.82	-2.70	43.12	74.00	30.88	210	345	PK	Vertical
4923.60	43.04	-1.50	41.54	74.00	32.46	182	147	PK	Vertical



Test mode:802.11G (2412MHz)									
Frequency MHz	Original Receiver (dBuV/m)	Correct Factor (dB)	Measure Level (dBuV/m)	Limit (dBuV/M)	Margin (dB)	Hight (cm)	Azimuth (deg)	Detector	Polarization
2380.05	45.06	-4.80	40.26	74.00	33.74	296	257	PK	Hoirznotal
4823.30	42.02	-1.80	40.22	74.00	33.78	234	304	PK	Hoirznotal
2385.08	45.25	-4.80	40.45	74.00	33.55	165	245	PK	Vertical
4823.86	41.94	-1.80	40.14	74.00	33.86	140	62	PK	Vertical

Test mode:802.11G (2437MHz)									
Frequency MHz	Original Receiver (dBuV/m)	Correct Factor (dB)	Measure Level (dBuV/m)	Limit (dBuV/M)	Margin (dB)	Hight (cm)	Azimuth (deg)	Detector	Polarization
4872.03	42.27	-1.70	40.57	74.00	33.43	291	229	PK	Hoirznotal
4873.73	42.59	-1.70	40.89	74.00	33.11	234	98	PK	Vertical

Test mode:802.11G (2462MHz)									
Frequency MHz	Original Receiver (dBuV/m)	Correct Factor (dB)	Measure Level (dBuV/m)	Limit (dBuV/M)	Margin (dB)	Hight (cm)	Azimuth (deg)	Detector	Polarization
2483.54	45.54	-2.70	42.84	74.00	31.16	216	348	PK	Hoirznotal
4925.30	41.74	-1.50	40.24	74.00	33.76	243	359	PK	Hoirznotal
2483.56	50.72	-2.70	48.02	74.00	25.98	161	323	PK	Vertical
4924.16	42.28	-1.50	40.78	74.00	33.22	134	200	PK	Vertical



Test mode:802.11N20 (2412MHz)									
Frequency MHz	Original Receiver (dBuV/m)	Correct Factor (dB)	Measure Level (dBuV/m)	Limit (dBuV/M)	Margin (dB)	Hight (cm)	Azimuth (deg)	Detector	Polarization
2389.90	51.87	-4.80	47.07	74.00	26.93	278	1	PK	Hoirznotal
4823.86	42.68	-1.80	40.88	74.00	33.12	135	10	PK	Hoirznotal
2389.71	51.40	-4.80	46.60	74.00	27.40	277	149	PK	Vertical
4825.00	42.99	-1.80	41.19	74.00	32.81	300	52	PK	Vertical

Test mode:802.11N20 (2437MHz)									
Frequency MHz	Original Receiver (dBuV/m)	Correct Factor (dB)	Measure Level (dBuV/m)	Limit (dBuV/M)	Margin (dB)	Hight (cm)	Azimuth (deg)	Detector	Polarization
4875.54	43.45	-1.70	41.75	74.00	32.25	215	129	PK	Hoirznotal
4873.73	41.67	-1.70	39.97	74.00	34.03	214	163	PK	Vertical

Test mode:802.11N20 (2462MHz)									
Frequency MHz	Original Receiver (dBuV/m)	Correct Factor (dB)	Measure Level (dBuV/m)	Limit (dBuV/M)	Margin (dB)	Hight (cm)	Azimuth (deg)	Detector	Polarization
2483.50	45.49	-2.70	42.79	74.00	31.21	120	195	PK	Hoirznotal
4924.73	44.10	-1.50	42.60	74.00	31.40	261	53	PK	Hoirznotal
2483.57	45.42	-2.70	42.72	74.00	31.28	221	298	PK	Vertical
4924.73	41.58	-1.50	40.08	74.00	33.92	260	303	PK	Vertical

Remark:

- (1) Emission level= Original Receiver Reading + Correct Factor
- (2) Correct Factor = Antenna Factor + Cable Loss -Amplifier gain
- (3) Margin = limit – Corrected Reading

The worst case of Radiated Emission below 1GHz: TX at 2412MHz (802.11b)

## 30-1000MHz Radiated Emission

### EUT Information

EUT Name:	STORM Series Thermal Imaging Scope
Model:	STORM S3
Client:	Visir Inc
Op Cond:	Power on, TX_2412MHz, DC 3.6V, T21.2, 41.4%, P103.3kPa
Operator:	jianqing ZENG
Test Spec:	FCC Part 15.209
Comment:	Horizontal
Sample No:	SHA-784114-1

### Sweep Setup: RE\_VULB9168\_pre\_Cont\_30-1000 [EMI radiated]

Hardware Setup:	RE_VULB9168
Receiver:	[ESR 3]
Level Unit:	dBuV/m

Subrange	Step Size	Detectors	Bandwidth	Sweep Time	Preamp
30 MHz - 1 GHz	48.5 kHz	PK+	120 kHz	0.2 s	20 dB

RE\_VULB9168\_pre\_Cont\_30-1000

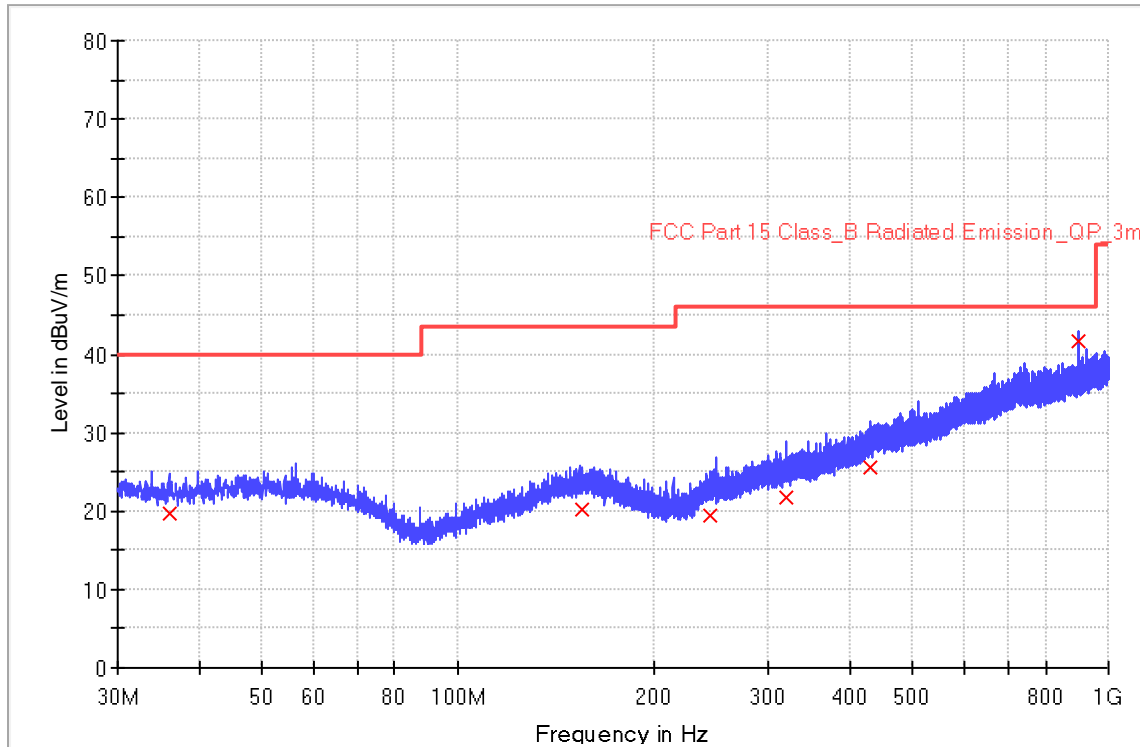

## Limit and Margin

Frequency (MHz)	QuasiPeak (dBuV/m)	Meas. Time (ms)	Bandwidth (kHz)	Height (cm)	Pol	Azimuth (deg)	Corr. (dB/m)	Margin - QPK (dB)	Limit - QPK (dBuV/m)
35.960000	19.6	1000.0	120.000	142.0	H	13.0	19.7	20.4	40.0
154.880000	20.1	1000.0	120.000	151.0	H	293.0	21.0	23.4	43.5
244.760000	19.4	1000.0	120.000	176.0	H	107.0	19.8	26.6	46.0
320.080000	21.8	1000.0	120.000	130.0	H	84.0	22.2	24.2	46.0
430.360000	25.7	1000.0	120.000	213.0	H	184.0	25.3	20.4	46.0
900.000000	41.7	1000.0	120.000	124.0	H	355.0	33.3	4.3	46.0





# 30-1000MHz Radiated Emission

## EUT Information

EUT Name: STORM Series Thermal Imaging Scope  
 Model: STORM S3  
 Client: Visir Inc  
 Op Cond: Power on, TX\_2412MHz, DC 3.6V, T21.2, 41.4%, P103.3kPa  
 Operator: Jianqing ZENG  
 Test Spec: FCC Part 15.209  
 Comment: Vertical  
 Sample No: SHA-784114-1

## Sweep Setup: RE\_VULB9168\_pre\_Cont\_30-1000 [EMI radiated]

Hardware Setup: RE\_VULB9168  
 Receiver: [ESR 3]  
 Level Unit: dBuV/m

Subrange	Step Size	Detectors	Bandwidth	Sweep Time	Preamp
30 MHz - 1 GHz	48.5 kHz	PK+	120 kHz	0.2 s	20 dB

RE\_VULB9168\_pre\_Cont\_30-1000

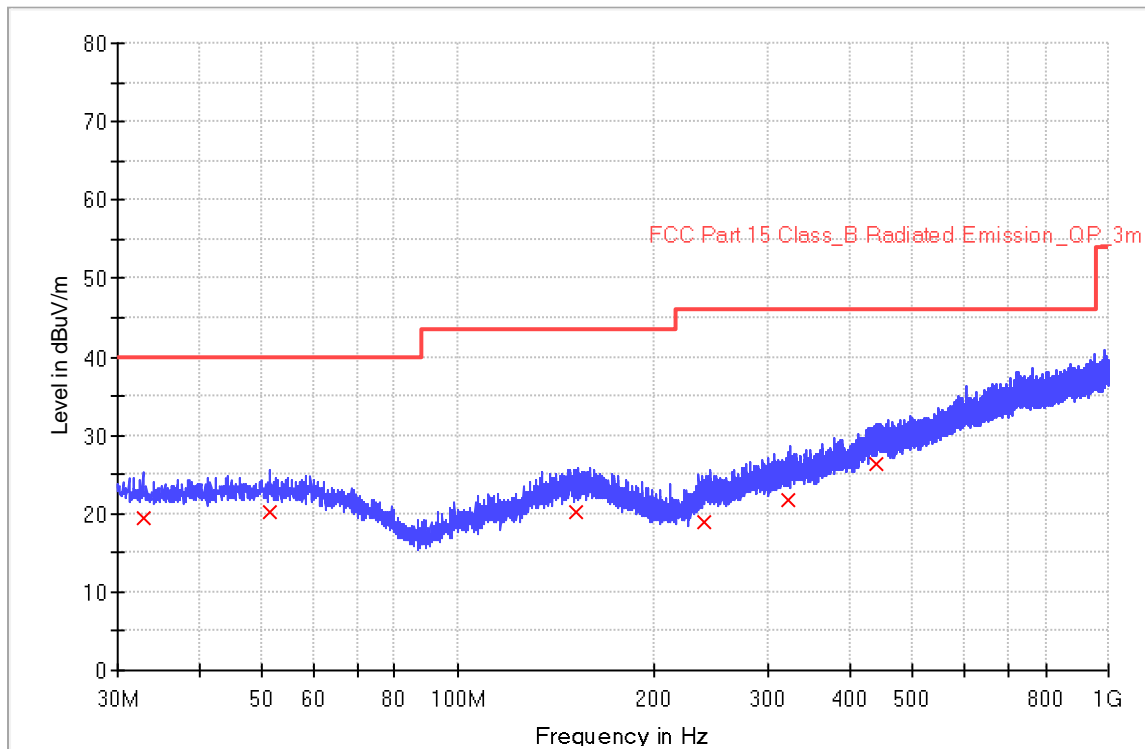

## Limit and Margin

Frequency (MHz)	QuasiPeak (dBuV/m)	Meas. Time (ms)	Bandwidth (kHz)	Height (cm)	Pol	Azimuth (deg)	Corr. (dB/m)	Margin - QPK (dB)	Limit - QPK (dBuV/m)
32.800000	19.5	1000.0	120.000	156.0	V	89.0	19.4	20.5	40.0
51.280000	20.1	1000.0	120.000	103.0	V	211.0	20.6	19.9	40.0
151.560000	20.3	1000.0	120.000	128.0	V	185.0	20.9	23.2	43.5
238.840000	19.0	1000.0	120.000	140.0	V	313.0	19.4	27.0	46.0
320.960000	21.8	1000.0	120.000	121.0	V	274.0	22.3	24.2	46.0
439.040000	26.3	1000.0	120.000	133.0	V	56.0	25.6	19.8	46.0

Note 1: Measure Level (dBuV/m) = Reading Level (dBuV) + Factor (dB)

Factor (dB) = Cable Loss (dB) + Antenna Factor (dB/m)

Note 2: The test trace is same as the ambient noise and the amplitude of the emissions are attenuated more than 20dB below the permissible (the test frequency range: 9kHz ~ 30MHz, 18GHz ~ 25GHz), therefore no data appear in the report.



# 30-1000MHz Radiated Emission

## EUT Information

EUT Name: STORM Series Thermal Imaging Scope  
 Model: STORM S2  
 Client: Visir Inc  
 Op Cond: Power on, TX\_2412MHz, DC 3.6V, T21.2, 41.4%, P103.3kPa  
 Operator: Jianqing ZENG  
 Test Spec: FCC Part 15.209  
 Comment: Horizontal  
 Sample No: SHA-784114-3

## Sweep Setup: RE\_VULB9168\_pre\_Cont\_30-1000 [EMI radiated]

Hardware Setup: RE\_VULB9168  
 Receiver: [ESR 3]  
 Level Unit: dBuV/m

Subrange	Step Size	Detectors	Bandwidth	Sweep Time	Preamp
30 MHz - 1 GHz	48.5 kHz	PK+	120 kHz	0.2 s	20 dB

RE\_VULB9168\_pre\_Cont\_30-1000

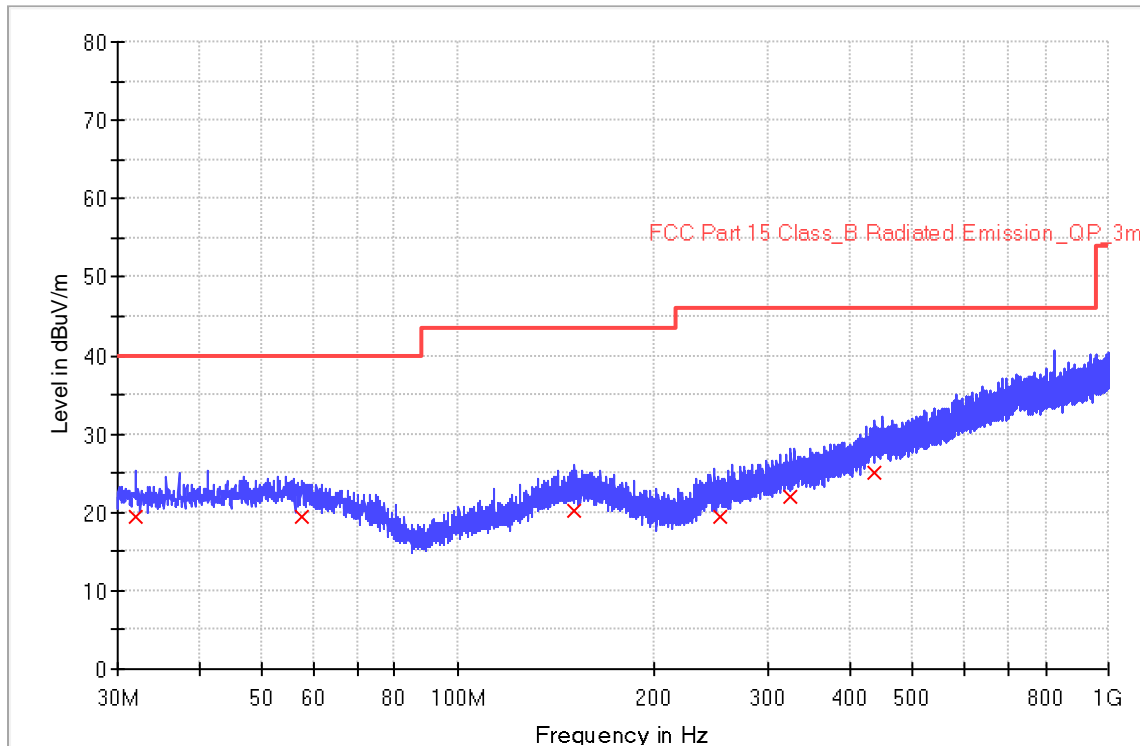



## Limit and Margin

Frequency (MHz)	QuasiPeak (dBuV/m)	Meas. Time (ms)	Bandwidth (kHz)	Height (cm)	Pol	Azimuth (deg)	Corr. (dB/m)	Margin - QPK (dB)	Limit - QPK (dBuV/m)
31.920000	19.5	1000.0	120.000	214.0	H	124.0	19.4	20.5	40.0
57.600000	19.4	1000.0	120.000	125.0	H	33.0	20.3	20.7	40.0
151.280000	20.2	1000.0	120.000	102.0	H	278.0	20.9	23.3	43.5
252.280000	19.5	1000.0	120.000	158.0	H	319.0	19.9	26.5	46.0
325.360000	22.1	1000.0	120.000	179.0	H	359.0	22.5	23.9	46.0
437.360000	25.2	1000.0	120.000	130.0	H	199.0	25.6	20.9	46.0



# 30-1000MHz Radiated Emission

## EUT Information

EUT Name: STORM Series Thermal Imaging Scope  
 Model: STORM S2  
 Client: Visir Inc  
 Op Cond: Power on, TX\_2412MHz, DC 3.6V, T21.2, 41.4%, P103.3kPa  
 Operator: Jianqing ZENG  
 Test Spec: FCC Part 15.209  
 Comment: Vertical  
 Sample No: SHA-784114-3

## Sweep Setup: RE\_VULB9168\_pre\_Cont\_30-1000 [EMI radiated]

Hardware Setup: RE\_VULB9168  
 Receiver: [ESR 3]  
 Level Unit: dBuV/m

Subrange	Step Size	Detectors	Bandwidth	Sweep Time	Preamp
30 MHz - 1 GHz	48.5 kHz	PK+	120 kHz	0.2 s	20 dB

RE\_VULB9168\_pre\_Cont\_30-1000

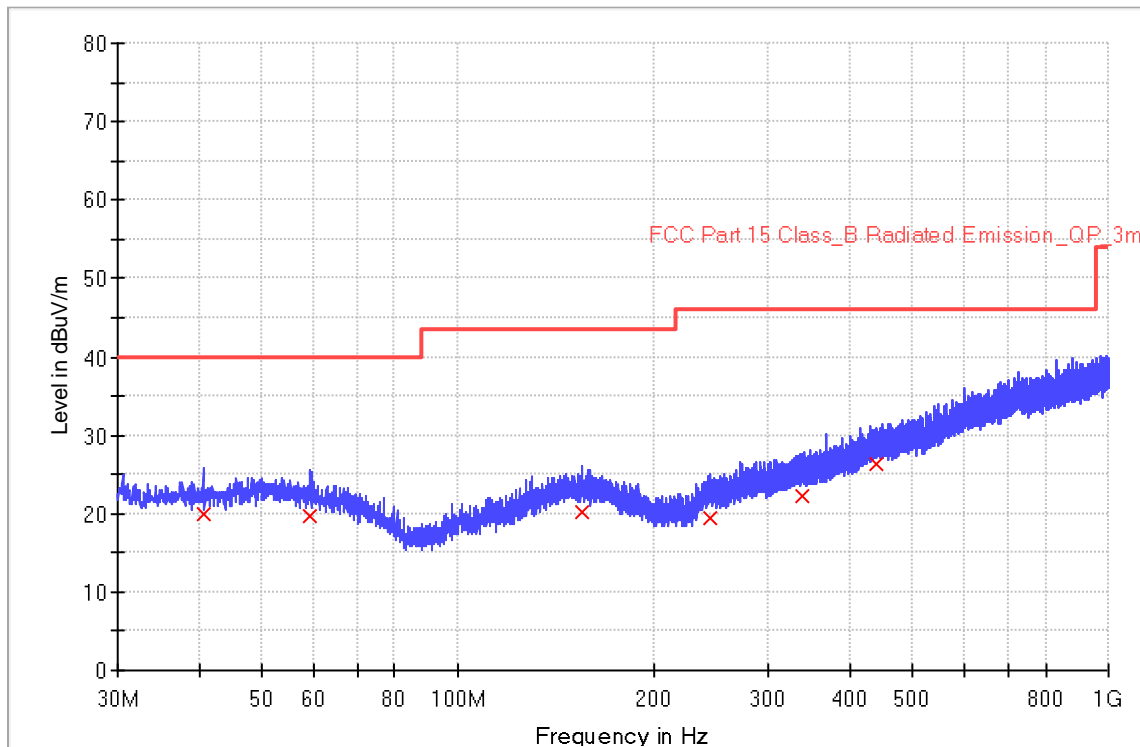



## Limit and Margin

Frequency (MHz)	QuasiPeak (dBuV/m)	Meas. Time (ms)	Bandwidth (kHz)	Height (cm)	Pol	Azimuth (deg)	Corr. (dB/m)	Margin - QPK (dB)	Limit - QPK (dBuV/m)
40.560000	19.9	1000.0	120.000	121.0	V	189.0	20.0	20.1	40.0
59.240000	19.7	1000.0	120.000	155.0	V	12.0	20.2	20.3	40.0
155.240000	20.2	1000.0	120.000	114.0	V	85.0	21.0	23.3	43.5
244.720000	19.5	1000.0	120.000	103.0	V	316.0	19.8	26.5	46.0
337.960000	22.2	1000.0	120.000	186.0	V	227.0	22.6	23.8	46.0
439.400000	26.2	1000.0	120.000	140.0	V	106.0	25.6	19.8	46.0



## 10 Test Equipment List

List of Test Instruments  
Test Site1

	DESCRIPTION	MANUFACTURER	MODEL NO.	SERIAL NO.	CAL. DATE	CAL. DUE DATE
C	Signal spectrum analyzer	Agilent	N9020B	MY59050168	2024-2-19	2025-2-18
	Wideband power sensor	Rohde & Schwarz	NRP-Z81	105903	2024-2-19	2025-2-18
	10dB Attenuator	Aeroflex Weinschel	CG-4689	93459	2024-2-19	2025-2-18
RE	EMI Test Receiver	Rohde & Schwarz	ESR3	101906	2023-8-1	2024-7-31
	Signal Analyzer	Rohde & Schwarz	FSV40	101091	2023-8-1	2024-7-31
	Trilog Super Broadband Test Antenna	Schwarzbeck	VULB 9168	961	2021-9-23	2024-9-22
	Horn Antenna	Rohde & Schwarz	HF907	102393	2021-4-13	2024-4-12
	Pre-amplifier	Rohde & Schwarz	SCU-18D	19006451	2023-8-1	2024-7-31
	Loop antenna	Rohde & Schwarz	HFH2-Z2	100443	2023-6-15	2024-6-14
	DOUBLE-RIDGED WAVEGUIDE HORN WITH PRE-AMPLIFIER (18 GHZ - 40 GHZ)	ETS-Lindgren	3116C	00246076	2023-7-7	2026-7-6
	3m Semi-anechoic chamber	TDK	9X6X6	----	2021-5-8	2024-5-7
CE	EMI Test Receiver	Rohde & Schwarz	ESR3	101907	2023-8-1	2024-7-31
	LISN	Rohde & Schwarz	ENV216	101924	2023-8-1	2024-7-31

Measurement Software Information			
Test Item	Software	Manufacturer	Version
C	MTS 8310	MWRFTtest	3.0.0.0
	Power Viewer	Rohde & Schwarz	V 11.0
RE	EMC 32	Rohde & Schwarz	V10.50.40
CE	EMC 32	Rohde & Schwarz	V9.15.03

**C - Conducted RF tests**

- Conducted peak output power
- 6dB bandwidth and 99% Occupied Bandwidth
- Power spectral density\*
- Spurious RF conducted emissions
- Band edge



## 11 System Measurement Uncertainty

For a 95% confidence level, the measurement expanded uncertainties for defined systems, in accordance with the recommendations of ISO 17025 were:

Items	Extended Uncertainty
Conducted Disturbance at Mains Terminals	150kHz to 30MHz, LISN, 3.16dB
Radiated Disturbance	30MHz to 1GHz, 5.03dB (Horizontal) 5.12dB (Vertical) 1GHz to 18GHz, 5.49dB 18GHz to 40GHz, 5.63dB
Carrier power conducted measurement	50MHz~18GHz, 1.238dB
Spurious Emission Conducted Measurement	9kHz ~40GHz, 1.224dB

Measurement Uncertainty Decision Rule:

Determination of conformity with the specification limits is based on the decision rule according to IEC Guide 115: 2021, clause 4.4.3 and 4.5.1.





## 12 Photographs of Test Set-ups

Refer to the < Test Setup photos >.



## 13 Photographs of EUT

Refer to the < External Photos > & < Internal Photos >.

-----End of Test Report-----