



## CTC Laboratories, Inc.

2/F., Building 1 and 1-2/F., Building 2, Jiaquan Building, Guanlan High-Tech Park, Longhua District, Shenzhen, Guangdong, China

Tel : +86-0755-27521059 Fax: +86-0755-27521011 <http://www.sz-ctc.org.cn>

# TEST REPORT

**Report No.** .....: **CTC20221491E01**  
**FCC ID**.....: **2A786CP-150**  
**Applicant**.....: **GOLDEN DESIGNS INC**  
**Address**.....: 3550 JURUPA STREET, UNIT B ONTARIO, CA 91761, UNITED STATES  
**Manufacturer**.....: GUANGDONG DAXIANG HEALTH TECH.CO.,LTD  
**Address**.....: AREA C, BLOCK 12TH, NO.28 MAOGANG ROAD, BAIHE TOWN, KAIPING CITY, GUANGDONG PROVINCE, CHINA  
**Product Name**.....: **Bluetooth Module for Sauna Control System**  
**Trade Mark**.....: /  
**Model/Type reference**.....: CP-1.50  
**Listed Model(s)** .....: CP-1.51, CP-1.52, CP-1.53, CP-1.54, CP-1.55, CP-1.56, CP-1.57, CP-1.58, CP-1.59  
**Standard**.....: **FCC CFR Title 47 Part 15 Subpart C Section 15.247**  
**Date of receipt of test sample**...: Aug. 1, 2022  
**Date of testing**.....: Aug. 1, 2022 to Aug. 10, 2022  
**Date of issue**.....: Aug. 10, 2022  
**Result**.....: **PASS**

Compiled by:

(Printed name+signature)

Jim Jiang

*Jim Jiang*

Supervised by:

(Printed name+signature)

Miller Ma

*Miller Ma*

Approved by:

(Printed name+signature)

Totti Zhao

*Totti Zhao*

This test report may be duplicated completely for legal use with the approval of the applicant. It should not be reproduced except in full, without the written approval of our laboratory. The client should not use it to claim product endorsement by CTC. The test results in the report only apply to the tested sample. The test report shall be invalid without all the signatures of testing engineers, reviewer and approver. Any objections must be raised to CTC within 15 days since the date when the report is received. It will not be taken into consideration beyond this limit. The test report merely correspond to the test sample.



Table of Contents

Page

- 1. TEST SUMMARY ..... 3
  - 1.1. TEST STANDARDS..... 3
  - 1.2. REPORT VERSION ..... 3
  - 1.3. TEST DESCRIPTION..... 3
  - 1.4. TEST FACILITY ..... 4
  - 1.5. MEASUREMENT UNCERTAINTY ..... 4
  - 1.6. ENVIRONMENTAL CONDITIONS..... 5
- 2. GENERAL INFORMATION ..... 6
  - 2.1. CLIENT INFORMATION ..... 6
  - 2.2. GENERAL DESCRIPTION OF EUT ..... 6
  - 2.3. ACCESSORY EQUIPMENT INFORMATION ..... 7
  - 2.4. OPERATION STATE ..... 8
  - 2.5. MEASUREMENT INSTRUMENTS LIST ..... 9
- 3. TEST ITEM AND RESULTS ..... 11
  - 3.1. CONDUCTED EMISSION..... 11
  - 3.2. RADIATED EMISSION ..... 14
  - 3.3. BAND EDGE EMISSIONS (RADIATED) ..... 28
  - 3.4. BAND EDGE AND SPURIOUS EMISSIONS (CONDUCTED) ..... 41
  - 3.5. BANDWIDTH..... 56
  - 3.6. CHANNEL SEPARATION..... 63
  - 3.7. NUMBER OF HOPPING CHANNEL ..... 65
  - 3.8. DWELL TIME ..... 67
  - 3.9. PEAK OUTPUT POWER ..... 72
  - 3.10. DUTY CYCLE ..... 73
  - 3.11. ANTENNA REQUIREMENT ..... 77



# 1. TEST SUMMARY

## 1.1. Test Standards

The tests were performed according to following standards:

[FCC Rules Part 15.247](#): Operation within the bands of 902-928MHz, 2400-2483.5MHz, and 5725-5850MHz.

[RSS-247 Issue 2](#): Standard Specifications for Frequency Hopping Systems (FHSs) and Digital Transmission Systems (DTSs) Operating in the Bands 902-928MHz, 2400-2483.5MHz and 5725-5850MHz.

[ANSI C63.10-2013](#): American National Standard for Testing Unlicensed Wireless Devices.

## 1.2. Report Version

Revised No.	Date of issue	Description
01	Aug. 10, 2022	Original

## 1.3. Test Description

FCC Part 15 Subpart C (15.247)/ RSS-247 Issue 2				
Test Item	Standard Section		Result	Test Engineer
	FCC	IC		
Antenna Requirement	15.203	/	Pass	Jim Jiang
Conducted Emission	15.207	RSS-Gen 8.8	Pass	Jim Jiang
Restricted Bands	15.205	RSS-Gen 8.10	Pass	Jim Jiang
Hopping Channel Separation	15.247(a)(1)	RSS-247 5.1 (b)	Pass	Jim Jiang
Dwell Time	15.247(a)(iii)	RSS-247 5.1 (d)	Pass	Jim Jiang
Peak Output Power	15.247(b)(1)	RSS-247 5.4 (b)	Pass	Jim Jiang
Number of Hopping Frequency	15.247(a)(iii)	RSS-247 5.1 (d)	Pass	Jim Jiang
Band Edge Emissions	15.247(d)	RSS-247 5.5	Pass	Jim Jiang
Radiated Spurious Emission	15.247(d)&15.209	RSS-247 5.5& RSS-Gen 8.9	Pass	Jim Jiang
20dB Bandwidth	15.247(a)	RSS-247 5.1 (b)	Pass	Jim Jiang

Note: The measurement uncertainty is not included in the test result.



## 1.4. Test Facility

### CTC Laboratories, Inc.

Add: 1-2/F., Building 2, Jiaquan Building, Guanlan High-Tech Park, Shenzhen, Guangdong, China

### Laboratory accreditation

The test facility is recognized, certified, or accredited by the following organizations:

#### **A2LA-Lab Cert. No.: 4340.01**

CTC Laboratories, Inc. EMC Laboratory has been accredited by A2LA for technical competence in the field of electrical testing, and proved to be in compliance with ISO/IEC 17025:2017 General Requirements for the Competence of Testing and Calibration Laboratories and any additional program requirements in the identified field of testing.

#### **Industry Canada (Registration No.: 9783A, CAB Identifier: CN0029)**

CTC Laboratories, Inc. EMC Laboratory has been registered by Certification and Engineer Bureau of Industry Canada for the performance of with Registration NO.: 9783A on Jan, 2016.

#### **FCC (Registration No.: 951311, Designation Number CN1208)**

CTC Laboratories, Inc. EMC Laboratory has been registered and fully described in a report filed with the (FCC) Federal Communications Commission. The acceptance letter from the FCC is maintained in our files. Registration 951311, Aug 26, 2017.

## 1.5. Measurement Uncertainty

The data and results referenced in this document are true and accurate. The reader is cautioned that there may be errors within the calibration limits of the equipment and facilities. The measurement uncertainty was calculated for all measurements listed in this test report acc. to TR-100028-01 "Electromagnetic compatibility and Radio spectrum Matters (ERM); Uncertainties in the measurement of mobile radio equipment characteristics; Part 1" and TR-100028-02 "Electromagnetic compatibility and Radio spectrum Matters (ERM); Uncertainties in the measurement of mobile radio equipment characteristics; Part 2" and is documented in the CTC Laboratories, Inc. quality system acc. to DIN EN ISO/IEC 17025. Furthermore, component and process variability of devices similar to that tested may result in additional deviation. The manufacturer has the sole responsibility of continued compliance of the device.

Below is the best measurement capability for CTC Laboratories, Inc.



Test Items	Measurement Uncertainty	Notes
Transmitter power conducted	0.42 dB	(1)
Transmitter power Radiated	2.14 dB	(1)
Conducted spurious emissions 9kHz~40GHz	1.60 dB	(1)
Radiated spurious emissions 9kHz~40GHz	2.20 dB	(1)
Conducted Emissions 9kHz~30MHz	3.20 dB	(1)
Radiated Emissions 30~1000MHz	4.70 dB	(1)
Radiated Emissions 1~18GHz	5.00 dB	(1)
Radiated Emissions 18~40GHz	5.54 dB	(1)
Occupied Bandwidth	-----	(1)

Note (1): This uncertainty represents an expanded uncertainty expressed at approximately the 95% confidence level using a coverage factor of  $k=2$ .

## 1.6. Environmental Conditions

During the measurement the environmental conditions were within the listed ranges:

Temperature:	21°C~27°C
Relative Humidity:	40%~60%
Atmospheric Pressure:	101kPa



## 2. GENERAL INFORMATION

### 2.1. Client Information

Applicant:	GOLDEN DESIGNS INC
Address:	3550 JURUPA STREET, UNIT B ONTARIO, CA 91761, UNITED STATES
Manufacturer:	GUANGDONG DAXIANG HEALTH TECH.CO.,LTD
Address:	AREA C, BLOCK 12TH, NO.28 MAOGANG ROAD, BAIHE TOWN, KAIPING CITY, GUANGDONG PROVINCE, CHINA

### 2.2. General Description of EUT

Product Name:	Bluetooth Module for Sauna Control System
Trade Mark:	/
Model/Type reference:	CP-1.50
Listed Model(s):	CP-1.51, CP-1.52, CP-1.53, CP-1.54, CP-1.55, CP-1.56, CP-1.57, CP-1.58, CP-1.59
Model Difference:	All these models are identical in the same PCB, layout and electrical circuit. The difference is the model name and version number.
Power supply:	Input: DC5V 500mA
Hardware version:	/
Software version:	/
<b>Bluetooth 5.0+BR/EDR</b>	
Modulation:	GFSK, $\pi/4$ -DQPSK, 8-DPSK
Operation frequency:	2402MHz~2480MHz
Channel number:	79
Channel separation:	1MHz
Antenna type:	PCB Antenna
Antenna gain:	1.7dBi



## 2.3. Accessory Equipment Information

Equipment Information			
Name	Model	S/N	Manufacturer
Notebook	ThinkPad T460s	/	Lenovo
Cable Information			
Name	Shielded Type	Ferrite Core	Length
USB Cable	Unshielded	NO	120cm
Test Software Information			
Name	Version	/	/
BT_Tool	V1.0.9	/	/



### 2.4. Operation State

Operation Frequency List: The EUT has been tested under typical operating condition. The Applicant provides communication tools software to control the EUT for staying in continuous transmitting and receiving mode for testing. BT EDR, 79 channels are provided to the EUT. Channels 00/39/78 were selected for testing.

Operation Frequency List:

Channel	Frequency (MHz)
<b>00</b>	<b>2402</b>
01	2403
:	:
38	2440
<b>39</b>	<b>2441</b>
40	2442
:	:
77	2479
<b>78</b>	<b>2480</b>

Note: The display in grey were the channel selected for testing.

#### Test mode

For RF test items:
The engineering test program was provided and enabled to make EUT continuous transmit
For AC power line conducted emissions:
The EUT was set to connect with the Bluetooth instrument under large package sizes transmission.
For Radiated spurious emissions test item:
The engineering test program was provided and enabled to make EUT continuous transmit. The EUT in each of three orthogonal axis emissions had been tested, but only the worst case (X axis) data recorded in the report.





## 2.5. Measurement Instruments List

Tonscend JS0806-2 Test system					
Item	Test Equipment	Manufacturer	Model No.	Serial No.	Calibrated until
1	Spectrum Analyzer	Rohde & Schwarz	FSU26	100105	Dec. 23, 2022
2	Spectrum Analyzer	Rohde & Schwarz	FUV40-N	101331	Mar. 15, 2023
3	MXG Vector Signal Generator	Agilent	N5182A	MY47420864	Dec. 23, 2022
4	Signal Generator	Agilent	E8257D	MY46521908	Dec. 23, 2022
5	Power Sensor	Agilent	U2021XA	MY5365004	Mar. 15, 2023
6	Power Sensor	Agilent	U2021XA	MY5365006	Mar. 15, 2023
7	Simultaneous Sampling DAQ	Agilent	U2531A	TW54493510	Mar. 15, 2023
8	Climate Chamber	TABAI	PR-4G	A8708055	Dec. 23, 2022
9	Wideband Radio Communication Tester	Rohde & Schwarz	CMW500	116410	Dec. 23, 2022
10	Climate Chamber	ESPEC	MT3065	/	Dec. 23, 2022
11	300328 v2.2.2 test system	TONSCEND	v2.6	/	/

Radiated Emission and Transmitter spurious emission					
Item	Test Equipment	Manufacturer	Model No.	Serial No.	Calibrated until
1	Trilog-Broadband Antenna	Schwarzbeck	VULB 9168	9168-759	Nov. 09, 2022
2	Horn Antenna	Schwarzbeck	BBHA 9120D	9120D-647	Dec. 23, 2022
3	Test Receiver	Keysight	N9038A	MY56400071	Dec. 23, 2022
4	Broadband Prempplier	SCHWARZBECK	BBV9743B	259	Dec. 23, 2022
5	Mirowave Broadband Amplifier	SCHWARZBECK	BBV9718C	111	Dec. 23, 2022
6	3m chamber 3	YIHENG	EE106	/	Sep. 09, 2023



Conducted Emission					
Item	Test Equipment	Manufacturer	Model No.	Serial No.	Calibrated until
1	LISN	R&S	ENV216	101112	Dec. 23, 2022
2	LISN	R&S	ENV216	101113	Dec. 23, 2022
3	EMI Test Receiver	R&S	ESCS30	100353	Dec. 23, 2022
4	ISN CAT6	Schwarzbeck	NTFM 8158	CAT6-8158-0046	Dec. 23, 2022
5	ISN CAT5	Schwarzbeck	NTFM 8158	CAT5-8158-0046	Dec. 23, 2022

Note:

1. The Cal. Interval was one year.
2. The cable loss has calculated in test result which connection between each test instruments.

### 3. TEST ITEM AND RESULTS

#### 3.1. Conducted Emission

**Limit**

FCC CFR Title 47 Part 15 Subpart C Section 15.207/ RSS – Gen 8.8

Frequency range (MHz)	Limit (dBuV)	
	Quasi-peak	Average
0.15-0.5	66 to 56*	56 to 46*
0.5-5	56	46
5-30	60	50

\* Decreases with the logarithm of the frequency.

**Test Configuration**

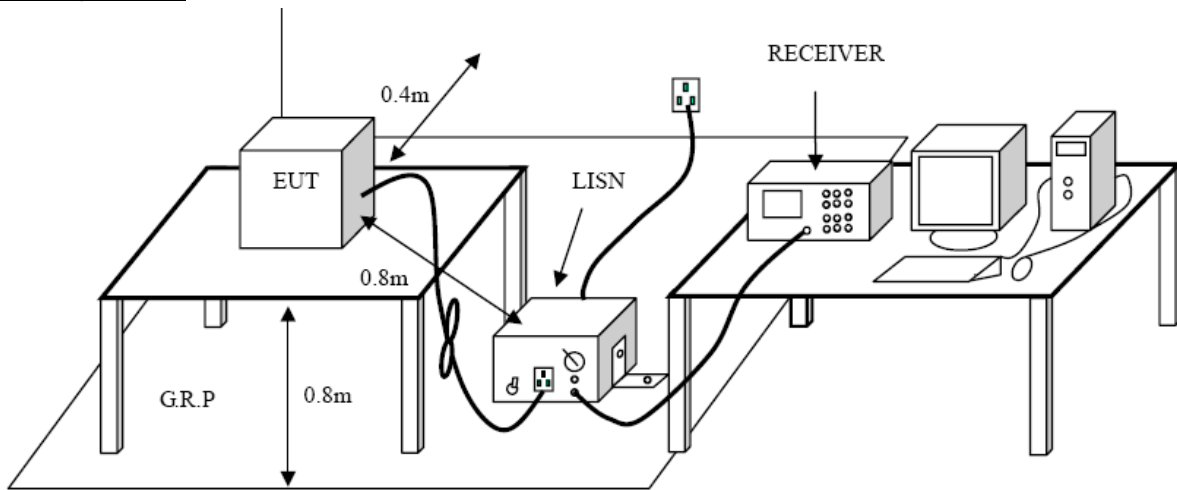

**Test Procedure**

1. The EUT was setup according to ANSI C63.10:2013 requirements.
2. The EUT was placed on a platform of nominal size, 1 m by 1.5 m, raised 80 cm above the conducting ground plane. The vertical conducting plane was located 40 cm to the rear of the EUT. All other surfaces of EUT were at least 80 cm from any other grounded conducting surface.
3. The EUT and simulators are connected to the main power through a line impedances stabilization network (LISN). The LISN provides a 50ohm /50uH coupling impedance for the measuring equipment. The peripheral devices are also connected to the main power through a LISN. (Please refer to the block diagram of the test setup and photographs)
4. Each current-carrying conductor of the EUT power cord, except the ground (safety) conductor, was individually connected through a LISN to the input power source.
5. The excess length of the power cord between the EUT and the LISN receptacle were folded back and forth at the center of the lead to form a bundle not exceeding 40 cm in length.
6. Conducted Emissions were investigated over the frequency range from 0.15MHz to 30MHz using a receiver bandwidth of 9 kHz.
7. During the above scans, the emissions were maximized by cable manipulation.

**Test Mode**

Please refer to the clause 2.4.



**Test Results**

<b>Test Voltage:</b>	AC 120V/60 Hz
<b>Terminal:</b>	Line

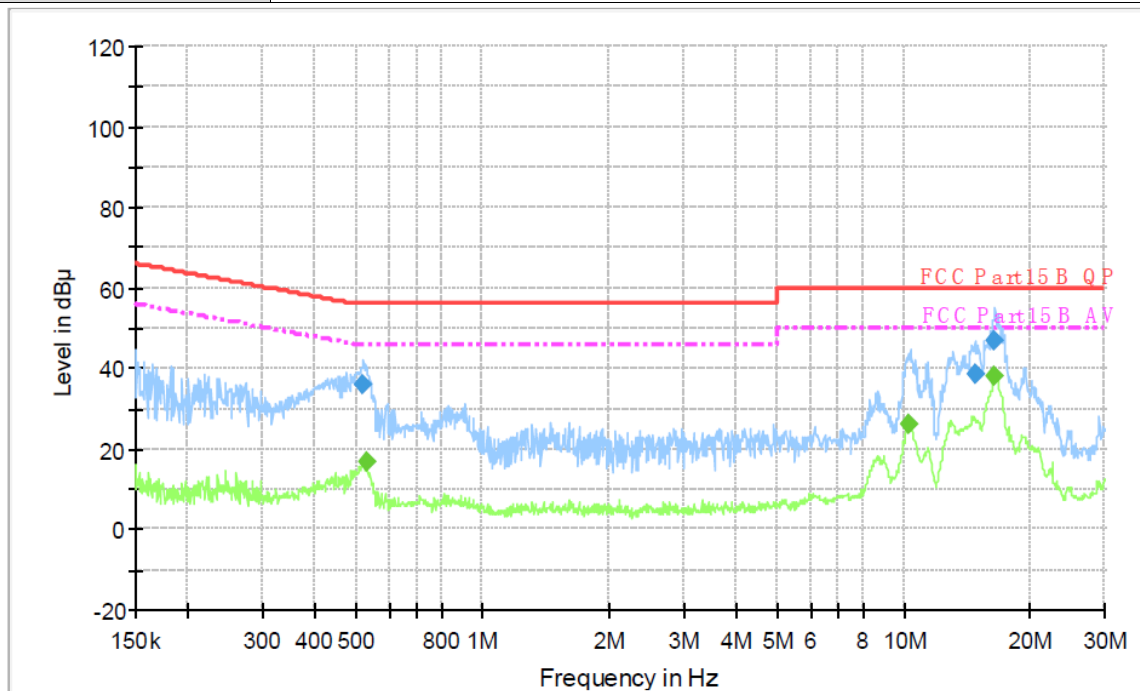

**Final Measurement Detector 1**

Frequency (MHz)	QuasiPeak (dBµ V)	Meas. Time (ms)	Bandwidth (kHz)	Filter	Line	Corr. (dB)	Margin (dB)	Limit (dBµ V)	Comment
0.521210	35.9	1000.00	9.000	On	L1	9.7	20.1	56.0	
14.727450	38.7	1000.00	9.000	On	L1	9.8	21.3	60.0	
16.469160	46.9	1000.00	9.000	On	L1	9.8	13.1	60.0	

**Final Measurement Detector 2**

Frequency (MHz)	Average (dBµ V)	Meas. Time (ms)	Bandwidth (kHz)	Filter	Line	Corr. (dB)	Margin (dB)	Limit (dBµ V)	Comment
0.529600	16.6	1000.00	9.000	On	L1	9.7	29.4	46.0	
10.241410	26.2	1000.00	9.000	On	L1	9.8	23.8	50.0	
16.469160	38.3	1000.00	9.000	On	L1	9.8	11.7	50.0	

Emission Level= Read Level+ Correct Factor



<b>Test Voltage:</b>	AC 120V/60 Hz
<b>Terminal:</b>	Neutral

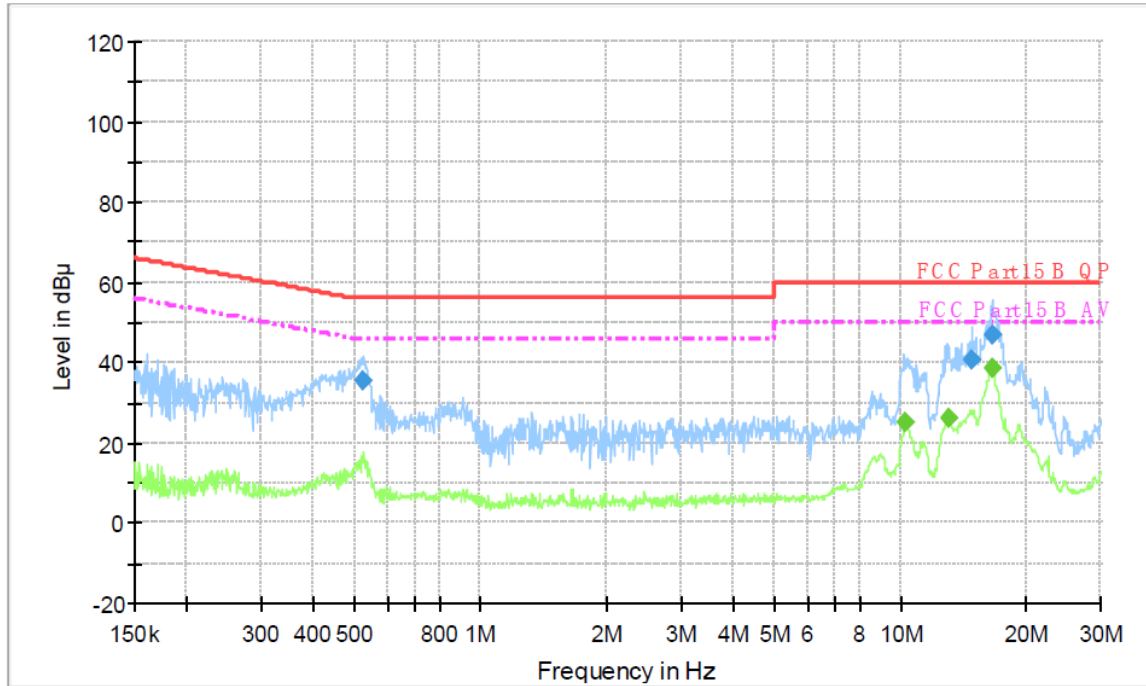

### Final Measurement Detector 1

Frequency (MHz)	QuasiPeak (dBµ V)	Meas. Time (ms)	Bandwidth (kHz)	Filter	Line	Corr. (dB)	Margin (dB)	Limit (dBµ V)	Comment
0.527490	35.6	1000.00	9.000	On	N	10.0	20.4	56.0	
14.786360	40.5	1000.00	9.000	On	N	10.0	19.5	60.0	
16.535040	47.0	1000.00	9.000	On	N	10.0	13.0	60.0	

### Final Measurement Detector 2

Frequency (MHz)	Average (dBµ V)	Meas. Time (ms)	Bandwidth (kHz)	Filter	Line	Corr. (dB)	Margin (dB)	Limit (dBµ V)	Comment
10.241410	25.0	1000.00	9.000	On	N	10.0	25.0	50.0	
13.065200	26.1	1000.00	9.000	On	N	10.0	23.9	50.0	
16.535040	38.4	1000.00	9.000	On	N	10.0	11.6	50.0	

Emission Level= Read Level+ Correct Factor



### 3.2. Radiated Emission

#### Limit

#### FCC CFR Title 47 Part 15 Subpart C Section 15.209/ RSS – Gen 8.9

Frequency (MHz)	Field Strength (microvolts/meter)	Measurement Distance (meters)
0.009~0.490	2400/F(KHz)	300
0.490~1.705	24000/F(KHz)	30
1.705~30.0	30	30
30~88	100	3
88~216	150	3
216~960	200	3
960~1000	500	3

Frequency (MHz)	dB(uV/m) (at 3 meters)	
	Peak	Average
Above 1000	74	54

#### **Note:**

- (1) The tighter limit applies at the band edges.
- (2) Emission Level (dBuV/m)=20log Emission Level (uV/m).

#### Test Configuration

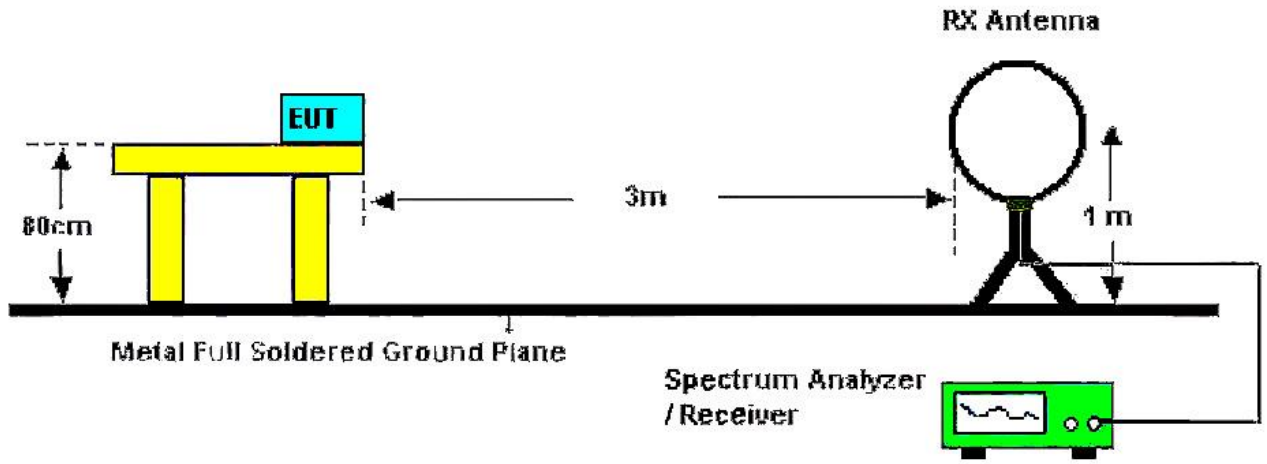

Below 30MHz Test Setup

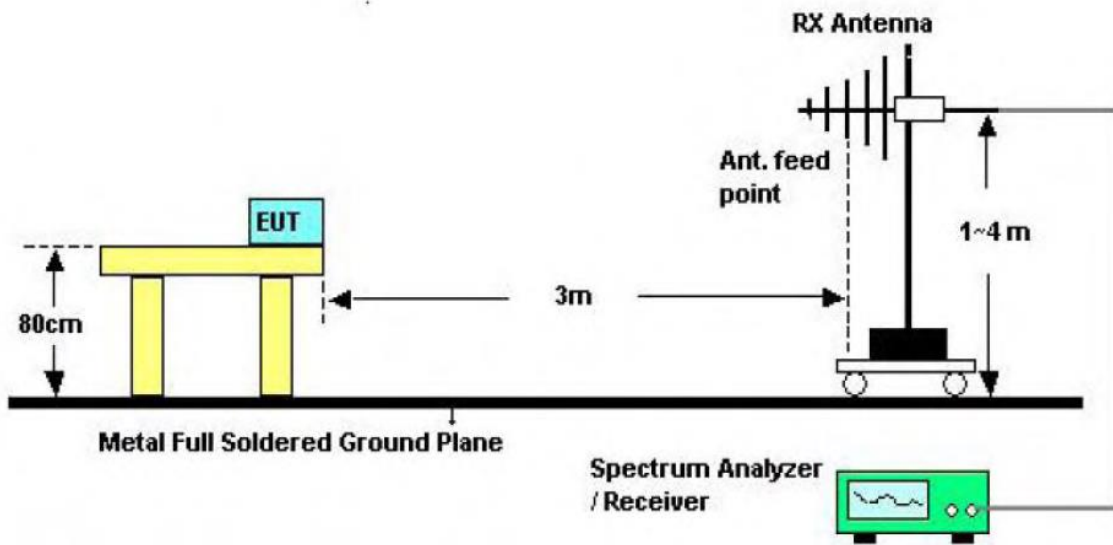

30-1000MHz Test Setup

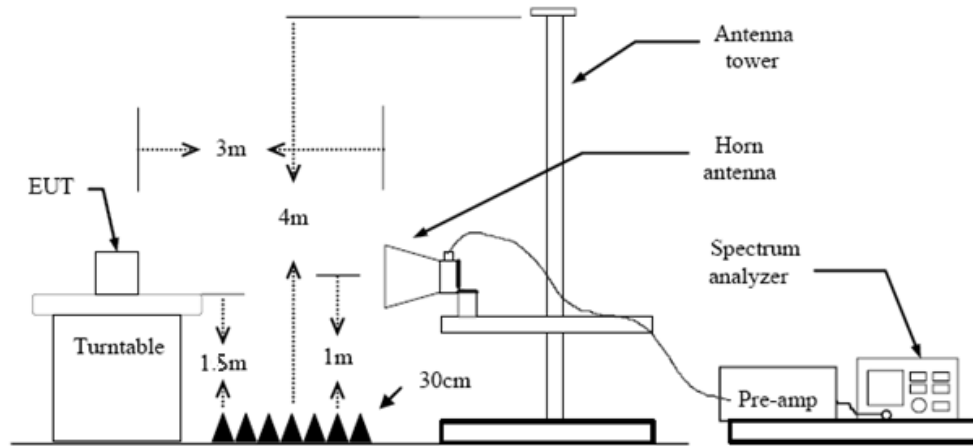

Above 1GHz Test Setup

### **Test Procedure**

1. The EUT was setup and tested according to ANSI C63.10:2013
2. The EUT is placed on a turn table which is 0.8 meter above ground for below 1 GHz, and 1.5 m for above 1 GHz. The turn table is rotated 360 degrees to determine the position of the maximum emission level.
3. The EUT was set 3 meters from the receiving antenna, which was mounted on the top of a variable height antenna tower.
4. For each suspected emission, the EUT was arranged to its worst case and then tune the Antenna tower (from 1 m to 4 m) and turntable (from 0 degree to 360 degrees) to find the maximum reading. A pre-amp and a high pass filter are used for the test in order to get better signal level to comply with the guidelines.
5. Set to the maximum power setting and enable the EUT transmit continuously.
6. Use the following spectrum analyzer settings
  - (1) Span shall wide enough to fully capture the emission being measured;
  - (2) Below 1 GHz:  
RBW=120 kHz, VBW=300 kHz, Sweep=auto, Detector function=peak, Trace=max hold;  
If the emission level of the EUT measured by the peak detector is 3 dB lower than the applicable limit, the peak emission level will be reported. Otherwise, the emission measurement will be repeated using the quasi-peak detector and reported.
  - (3) From 1 GHz to 10<sup>th</sup> harmonic:  
RBW=1MHz, VBW=3MHz Peak detector for Peak value.  
RBW=1MHz, VBW=3MHz RMS detector for Average value.

### **Test Mode**

Please refer to the clause 2.4.

### **Test Result**

#### **9 KHz~30 MHz**

From 9 KHz to 30 MHz: Conclusion: PASS

Note: The amplitude of spurious emissions which are attenuated by more than 20dB below the permissible value has no need to be reported.





30MHz-1GHz

Ant. Pol.	Horizontal
Test Mode:	TX GFSK Mode 2402MHz
Remark:	Only worse case is reported

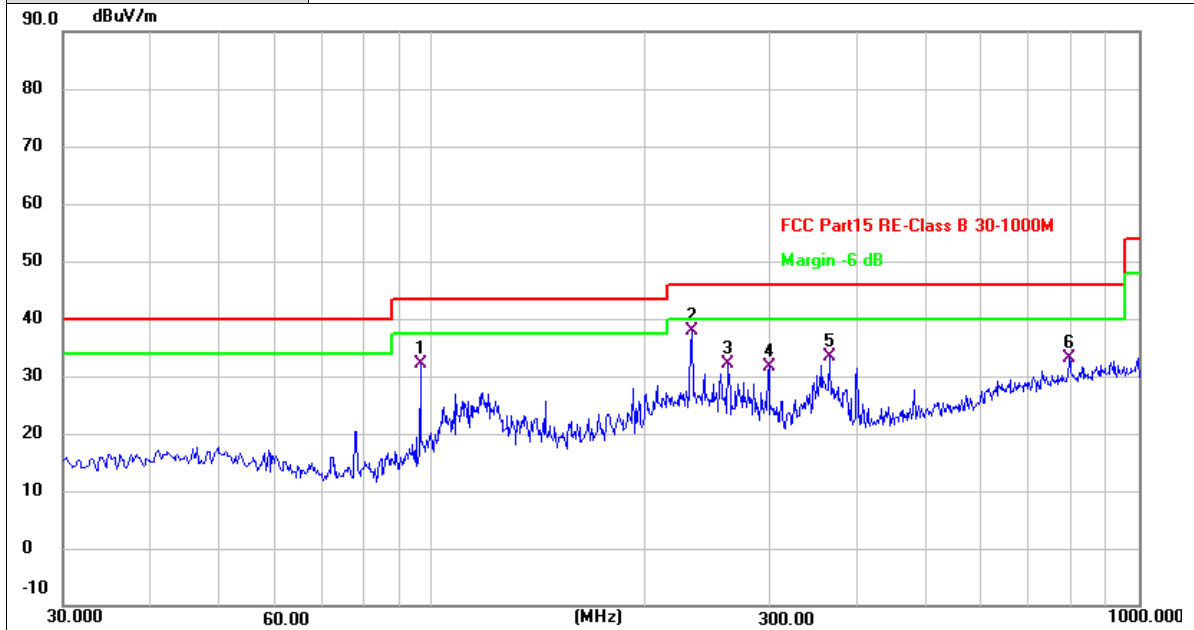

No.	Frequency (MHz)	Reading (dBuV)	Factor (dB/m)	Level (dBuV/m)	Limit (dBuV/m)	Margin (dB)	Detector
1	96.2833	49.08	-16.98	32.10	43.50	-11.40	QP
2 *	233.3767	52.88	-15.11	37.77	46.00	-8.23	QP
3	262.8000	46.53	-14.35	32.18	46.00	-13.82	QP
4	299.9832	45.05	-13.54	31.51	46.00	-14.49	QP
5	365.2967	45.28	-11.92	33.36	46.00	-12.64	QP
6	796.9467	37.19	-4.16	33.03	46.00	-12.97	QP

Remarks:

- Factor (dB/m) = Antenna Factor (dB/m)+Cable Factor (dB)-Pre-amplifier Factor
- Margin value = Level -Limit value



Ant. Pol.	Vertical
Test Mode:	TX GFSK Mode 2402MHz
Remark:	Only worse case is reported

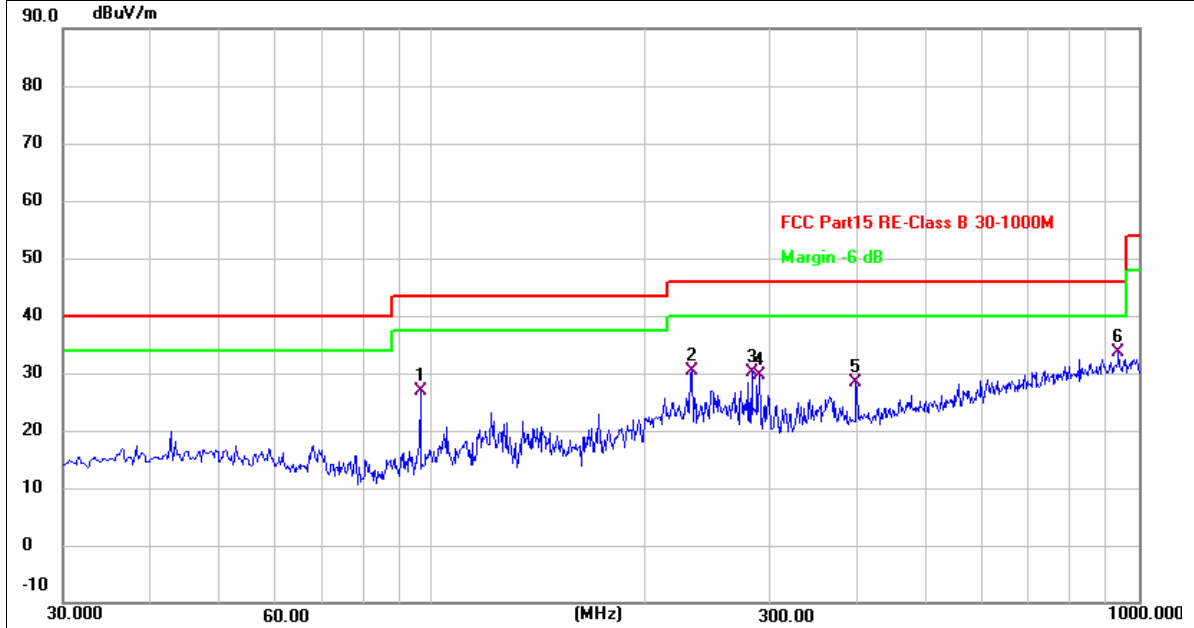

No.	Frequency (MHz)	Reading (dBuV)	Factor (dB/m)	Level (dBuV/m)	Limit (dBuV/m)	Margin (dB)	Detector
1	96.2833	43.77	-16.98	26.79	43.50	-16.71	QP
2	233.3767	45.37	-15.11	30.26	46.00	-15.74	QP
3	283.4932	44.02	-13.90	30.12	46.00	-15.88	QP
4	290.2832	43.38	-13.75	29.63	46.00	-16.37	QP
5	398.9233	39.48	-11.08	28.40	46.00	-17.60	QP
6 *	935.9800	35.93	-2.28	33.65	46.00	-12.35	QP

Remarks:

1. Factor (dB/m) = Antenna Factor (dB/m)+Cable Factor (dB)-Pre-amplifier Factor
2. Margin value = Level -Limit value



## Above 1GHz

<b>Ant. Pol.</b>	Horizontal
<b>Test Mode:</b>	TX GFSK Mode 2402MHz
<b>Remark:</b>	No report for the emission which more than 20 dB below the pre-scribed limit.

No.	Frequency (MHz)	Reading (dBuV)	Factor (dB/m)	Level (dBuV/m)	Limit (dBuV/m)	Margin (dB)	Detector
1	4804.213	41.71	2.16	43.87	74.00	-30.13	peak
2 *	4804.250	29.89	2.16	32.05	54.00	-21.95	AVG

## Remarks:

- 1.Factor (dB/m) = Antenna Factor (dB/m)+Cable Factor (dB)-Pre-amplifier Factor
- 2.Margin value = Level -Limit value

<b>Ant. Pol.</b>	Vertical
<b>Test Mode:</b>	TX GFSK Mode 2402MHz
<b>Remark:</b>	No report for the emission which more than 20 dB below the pre-scribed limit.

No.	Frequency (MHz)	Reading (dBm)	Factor (dB)	Level (dBm)	Limit (dBm)	Margin (dB)	Detector
1	4803.990	40.96	2.56	43.52	74.00	-30.48	peak
2 *	4804.246	29.12	2.56	31.68	54.00	-22.32	AVG

## Remarks:

- 1.Factor (dB/m) = Antenna Factor (dB/m)+Cable Factor (dB)-Pre-amplifier Factor
- 2.Margin value = Level -Limit value



<b>Ant. Pol.</b>	Horizontal
<b>Test Mode:</b>	TX GFSK Mode 2441MHz
<b>Remark:</b>	No report for the emission which more than 20 dB below the prescribed limit.

No.	Frequency (MHz)	Reading (dBuV)	Factor (dB/m)	Level (dBuV/m)	Limit (dBuV/m)	Margin (dB)	Detector
1 *	4881.931	29.54	2.31	31.85	54.00	-22.15	AVG
2	4882.050	41.29	2.31	43.60	74.00	-30.40	peak

Remarks:

1.Factor (dB/m) = Antenna Factor (dB/m)+Cable Factor (dB)-Pre-amplifier Factor

2.Margin value = Level -Limit value

<b>Ant. Pol.</b>	Vertical
<b>Test Mode:</b>	TX GFSK Mode 2441MHz
<b>Remark:</b>	No report for the emission which more than 20 dB below the prescribed limit.

No.	Frequency (MHz)	Reading (dBm)	Factor (dB)	Level (dBm)	Limit (dBm)	Margin (dB)	Detector
1	4882.058	39.91	2.79	42.70	74.00	-31.30	peak
2 *	4882.107	27.85	2.79	30.64	54.00	-23.36	AVG

Remarks:

1.Factor (dB/m) = Antenna Factor (dB/m)+Cable Factor (dB)-Pre-amplifier Factor

2.Margin value = Level -Limit value



<b>Ant. Pol.</b>	Horizontal
<b>Test Mode:</b>	TX GFSK Mode 2480MHz
<b>Remark:</b>	No report for the emission which more than 20 dB below the prescribed limit.

No.	Frequency (MHz)	Reading (dBuV)	Factor (dB/m)	Level (dBuV/m)	Limit (dBuV/m)	Margin (dB)	Detector
1 *	4959.869	28.42	2.48	30.90	54.00	-23.10	AVG
2	4960.121	40.58	2.48	43.06	74.00	-30.94	peak

Remarks:

1.Factor (dB/m) = Antenna Factor (dB/m)+Cable Factor (dB)-Pre-amplifier Factor

2.Margin value = Level -Limit value

<b>Ant. Pol.</b>	Vertical
<b>Test Mode:</b>	TX GFSK Mode 2480MHz
<b>Remark:</b>	No report for the emission which more than 20 dB below the prescribed limit.

No.	Frequency (MHz)	Reading (dBm)	Factor (dB)	Level (dBm)	Limit (dBm)	Margin (dB)	Detector
1	4960.085	39.57	3.04	42.61	74.00	-31.39	peak
2 *	4960.109	27.42	3.04	30.46	54.00	-23.54	AVG

Remarks:

1.Factor (dB/m) = Antenna Factor (dB/m)+Cable Factor (dB)-Pre-amplifier Factor

2.Margin value = Level -Limit value



<b>Ant. Pol.</b>	Horizontal
<b>Test Mode:</b>	TX $\pi/4$ -DQPSK Mode 2402MHz
<b>Remark:</b>	No report for the emission which more than 20 dB below the prescribed limit.

No.	Frequency (MHz)	Reading (dBuV)	Factor (dB/m)	Level (dBuV/m)	Limit (dBuV/m)	Margin (dB)	Detector
1	4803.970	40.60	2.16	42.76	74.00	-31.24	peak
2 *	4804.211	28.20	2.16	30.36	54.00	-23.64	AVG

Remarks:

- 1.Factor (dB/m) = Antenna Factor (dB/m)+Cable Factor (dB)-Pre-amplifier Factor
- 2.Margin value = Level -Limit value

<b>Ant. Pol.</b>	Vertical
<b>Test Mode:</b>	TX $\pi/4$ -DQPSK Mode 2402MHz
<b>Remark:</b>	No report for the emission which more than 20 dB below the prescribed limit.

No.	Frequency (MHz)	Reading (dBm)	Factor (dB)	Level (dBm)	Limit (dBm)	Margin (dB)	Detector
1	4803.951	40.32	2.56	42.88	74.00	-31.12	peak
2 *	4804.007	27.68	2.56	30.24	54.00	-23.76	AVG

Remarks:

- 1.Factor (dB/m) = Antenna Factor (dB/m)+Cable Factor (dB)-Pre-amplifier Factor
- 2.Margin value = Level -Limit value



<b>Ant. Pol.</b>	Horizontal
<b>Test Mode:</b>	TX $\pi/4$ -DQPSK Mode 2441MHz
<b>Remark:</b>	No report for the emission which more than 20 dB below the prescribed limit.

No.	Frequency (MHz)	Reading (dBm)	Factor (dB)	Level (dBm)	Limit (dBm)	Margin (dB)	Detector
1	4882.128	40.31	2.79	43.10	74.00	-30.90	peak
2 *	4882.139	27.78	2.79	30.57	54.00	-23.43	AVG

Remarks:

- 1.Factor (dB/m) = Antenna Factor (dB/m)+Cable Factor (dB)-Pre-amplifier Factor
- 2.Margin value = Level -Limit value

<b>Ant. Pol.</b>	Vertical
<b>Test Mode:</b>	TX $\pi/4$ -DQPSK Mode 2441MHz
<b>Remark:</b>	No report for the emission which more than 20 dB below the prescribed limit.

No.	Frequency (MHz)	Reading (dBm)	Factor (dB)	Level (dBm)	Limit (dBm)	Margin (dB)	Detector
1 *	4882.033	27.51	2.79	30.30	54.00	-23.70	AVG
2	4882.100	40.23	2.79	43.02	74.00	-30.98	peak

Remarks:

- 1.Factor (dB/m) = Antenna Factor (dB/m)+Cable Factor (dB)-Pre-amplifier Factor
- 2.Margin value = Level -Limit value



<b>Ant. Pol.</b>	Horizontal
<b>Test Mode:</b>	TX $\pi/4$ -DQPSK Mode 2480MHz
<b>Remark:</b>	No report for the emission which more than 20 dB below the prescribed limit.

No.	Frequency (MHz)	Reading (dBm)	Factor (dB)	Level (dBm)	Limit (dBm)	Margin (dB)	Detector
1	4960.104	40.36	3.04	43.40	74.00	-30.60	peak
2 *	4960.160	28.11	3.04	31.15	54.00	-22.85	AVG

Remarks:

1.Factor (dB/m) = Antenna Factor (dB/m)+Cable Factor (dB)-Pre-amplifier Factor

2.Margin value = Level -Limit value

<b>Ant. Pol.</b>	Vertical
<b>Test Mode:</b>	TX $\pi/4$ -DQPSK Mode 2480MHz
<b>Remark:</b>	No report for the emission which more than 20 dB below the prescribed limit.

No.	Frequency (MHz)	Reading (dBm)	Factor (dB)	Level (dBm)	Limit (dBm)	Margin (dB)	Detector
1	4960.021	39.78	3.04	42.82	74.00	-31.18	peak
2 *	4960.119	27.32	3.04	30.36	54.00	-23.64	AVG

Remarks:

1.Factor (dB/m) = Antenna Factor (dB/m)+Cable Factor (dB)-Pre-amplifier Factor

2.Margin value = Level -Limit value





<b>Ant. Pol.</b>	Horizontal
<b>Test Mode:</b>	TX 8-DPSK Mode 2402MHz
<b>Remark:</b>	No report for the emission which more than 20 dB below the prescribed limit.

No.	Frequency (MHz)	Reading (dBm)	Factor (dB)	Level (dBm)	Limit (dBm)	Margin (dB)	Detector
1 *	4803.950	28.38	2.56	30.94	54.00	-23.06	AVG
2	4804.111	40.30	2.56	42.86	74.00	-31.14	peak

Remarks:

1.Factor (dB/m) = Antenna Factor (dB/m)+Cable Factor (dB)-Pre-amplifier Factor

2.Margin value = Level -Limit value

<b>Ant. Pol.</b>	Vertical
<b>Test Mode:</b>	TX 8-DPSK Mode 2402MHz
<b>Remark:</b>	No report for the emission which more than 20 dB below the prescribed limit.

No.	Frequency (MHz)	Reading (dBm)	Factor (dB)	Level (dBm)	Limit (dBm)	Margin (dB)	Detector
1	4804.125	40.36	2.56	42.92	74.00	-31.08	peak
2 *	4804.308	27.58	2.56	30.14	54.00	-23.86	AVG

Remarks:

1.Factor (dB/m) = Antenna Factor (dB/m)+Cable Factor (dB)-Pre-amplifier Factor

2.Margin value = Level -Limit value



<b>Ant. Pol.</b>	Horizontal
<b>Test Mode:</b>	TX 8-DPSK Mode 2441MHz
<b>Remark:</b>	No report for the emission which more than 20 dB below the prescribed limit.

No.	Frequency (MHz)	Reading (dBm)	Factor (dB)	Level (dBm)	Limit (dBm)	Margin (dB)	Detector
1	4882.201	39.94	2.79	42.73	74.00	-31.27	peak
2 *	4882.341	26.86	2.79	29.65	54.00	-24.35	AVG

## Remarks:

1.Factor (dB/m) = Antenna Factor (dB/m)+Cable Factor (dB)-Pre-amplifier Factor

2.Margin value = Level -Limit value

<b>Ant. Pol.</b>	Vertical
<b>Test Mode:</b>	TX 8-DPSK Mode 2441MHz
<b>Remark:</b>	No report for the emission which more than 20 dB below the prescribed limit.

No.	Frequency (MHz)	Reading (dBm)	Factor (dB)	Level (dBm)	Limit (dBm)	Margin (dB)	Detector
1	4881.962	40.41	2.79	43.20	74.00	-30.80	peak
2 *	4882.016	27.29	2.79	30.08	54.00	-23.92	AVG

## Remarks:

1.Factor (dB/m) = Antenna Factor (dB/m)+Cable Factor (dB)-Pre-amplifier Factor

2.Margin value = Level -Limit value



<b>Ant. Pol.</b>	Horizontal
<b>Test Mode:</b>	TX 8-DPSK Mode 2480MHz
<b>Remark:</b>	No report for the emission which more than 20 dB below the prescribed limit.

No.	Frequency (MHz)	Reading (dBm)	Factor (dB)	Level (dBm)	Limit (dBm)	Margin (dB)	Detector
1 *	4960.126	27.38	3.04	30.42	54.00	-23.58	AVG
2	4960.189	39.96	3.04	43.00	74.00	-31.00	peak

Remarks:

1.Factor (dB/m) = Antenna Factor (dB/m)+Cable Factor (dB)-Pre-amplifier Factor

2.Margin value = Level -Limit value

<b>Ant. Pol.</b>	Vertical
<b>Test Mode:</b>	TX 8-DPSK Mode 2480MHz
<b>Remark:</b>	No report for the emission which more than 20 dB below the prescribed limit.

No.	Frequency (MHz)	Reading (dBm)	Factor (dB)	Level (dBm)	Limit (dBm)	Margin (dB)	Detector
1 *	4959.872	27.80	3.04	30.84	54.00	-23.16	AVG
2	4960.003	40.12	3.04	43.16	74.00	-30.84	peak

Remarks:

1.Factor (dB/m) = Antenna Factor (dB/m)+Cable Factor (dB)-Pre-amplifier Factor

2.Margin value = Level -Limit value

### 3.3. Band Edge Emissions (Radiated)

#### Limit

FCC CFR Title 47 Part 15 Subpart C Section 15.247 (d):

Restricted Frequency Band (MHz)	(dBuV/m)(at 3m)	
	Peak	Average
2310 ~2390	74	54
2483.5 ~2500	74	54

Conducted band edge limit: The highest point of the operating frequency waveform down 20dB

#### Test Configuration

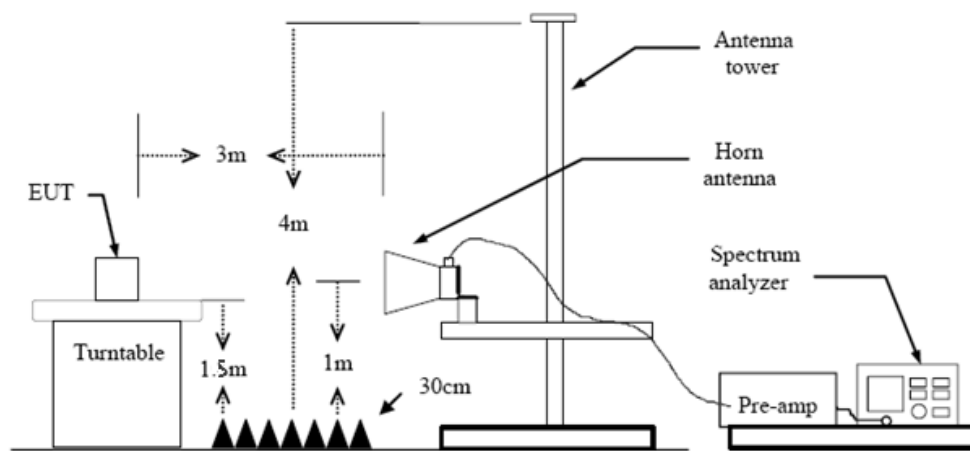

#### Test Procedure

1. The EUT was setup and tested according to ANSI C63.10:2013 requirements.
2. The EUT is placed on a turn table which is 1.5 meter above ground. The turn table is rotated 360 degrees to determine the position of the maximum emission level.
3. The EUT was positioned such that the distance from antenna to the EUT was 3 meters.
4. The antenna is scanned from 1 meter to 4 meters to find out the maximum emission level. This is repeated for both horizontal and vertical polarization of the antenna. In order to find the maximum emission, all of the interface cables were manipulated according to ANSI C63.10:2013 on radiated measurement.
5. The receiver set as follow:  
 RBW=1MHz, VBW=3MHz Peak detector for Peak value.  
 RBW=1MHz, VBW see note 1 with Peak Detector for Average Value.

Note 1: For measurements above 1 GHz the resolution bandwidth is set to 1 MHz, then the video bandwidth is set to 3 MHz for peak measurements and 1 MHz resolution bandwidth with 1/T video bandwidth with peak detector for average measurements. For the Duty Cycle please refer to clause 3.10 Duty Cycle.

#### Test Mode

Please refer to the clause 2.4.



Test Results

(1) Radiation Test

Ant. Pol.	Horizontal
Test Mode:	GFSK Mode 2402MHz

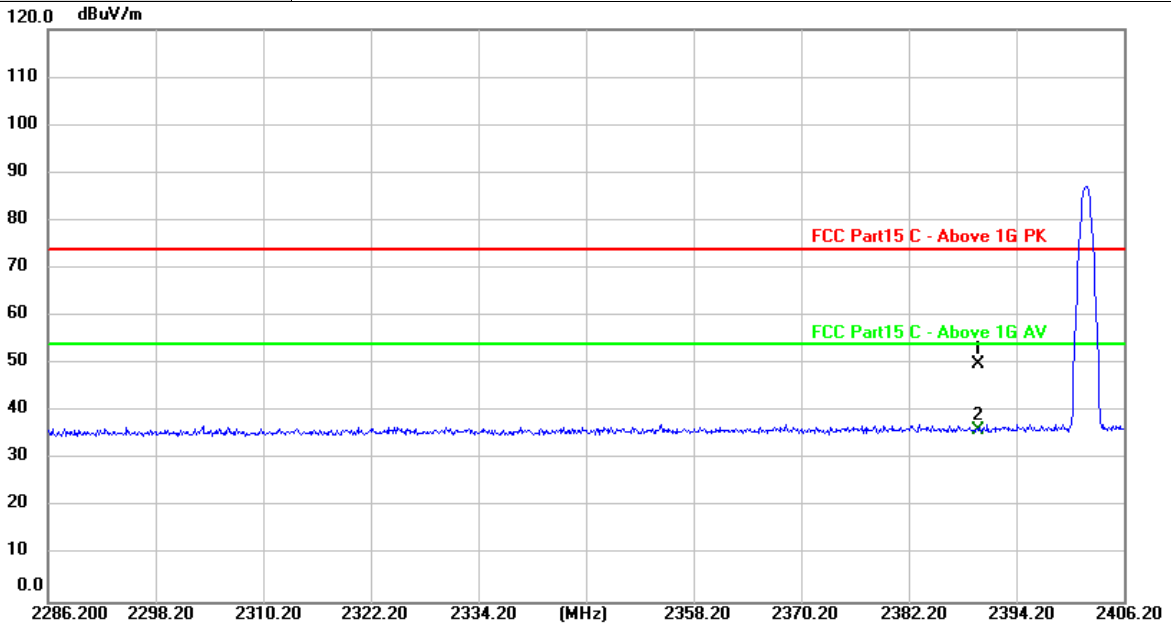

No.	Frequency (MHz)	Reading (dBuV)	Factor (dB/m)	Level (dBuV/m)	Limit (dBuV/m)	Margin (dB)	Detector
1	2390.000	19.07	30.84	49.91	74.00	-24.09	peak
2 *	2390.000	5.38	30.84	36.22	54.00	-17.78	AVG

Remarks:

- 1. Factor (dB/m) = Antenna Factor (dB/m)+Cable Factor (dB)-Pre-amplifier Factor
- 2. Margin value = Level -Limit value



Ant. Pol.	Vertical
Test Mode:	GFSK Mode 2402MHz

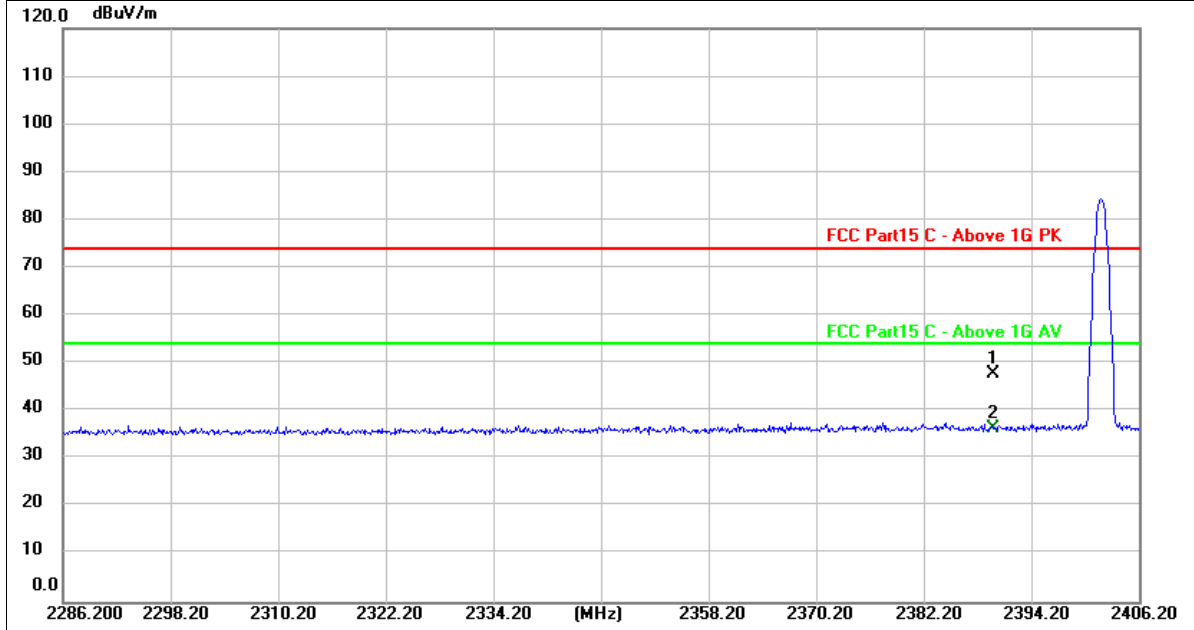

No.	Frequency (MHz)	Reading (dBuV)	Factor (dB/m)	Level (dBuV/m)	Limit (dBuV/m)	Margin (dB)	Detector
1	2390.000	17.12	30.84	47.96	74.00	-26.04	peak
2 *	2390.000	5.58	30.84	36.42	54.00	-17.58	AVG

Remarks:

1. Factor (dB/m) = Antenna Factor (dB/m)+Cable Factor (dB)-Pre-amplifier Factor
2. Margin value = Level -Limit value



Ant. Pol.	Horizontal
Test Mode:	GFSK Mode 2480 MHz

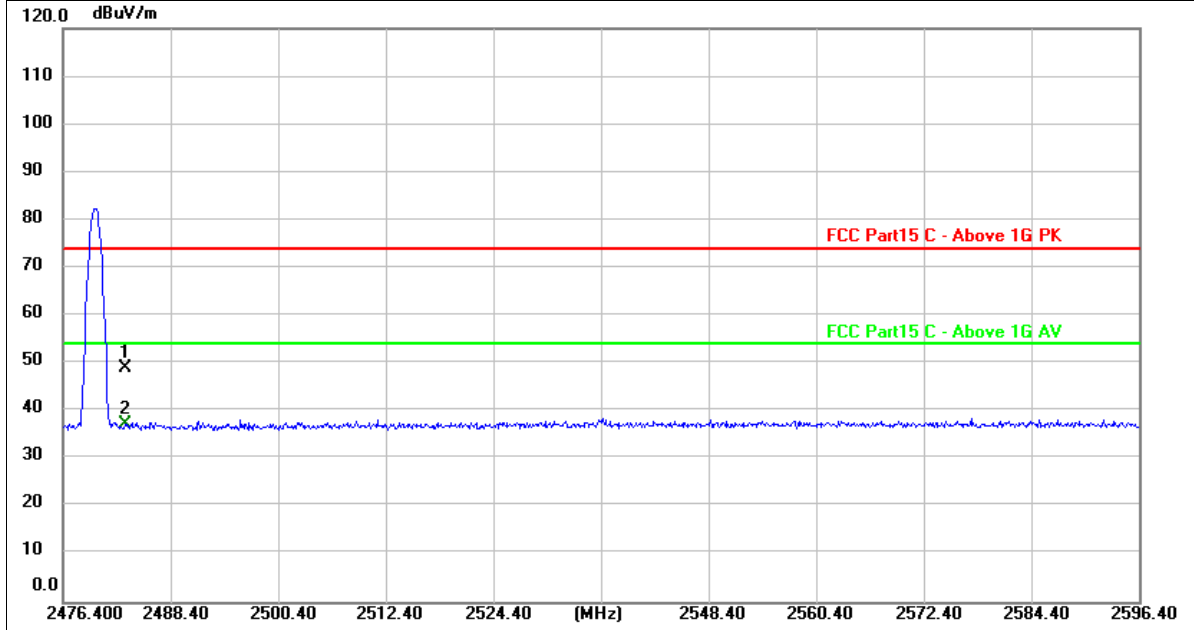

No.	Frequency (MHz)	Reading (dBuV)	Factor (dB/m)	Level (dBuV/m)	Limit (dBuV/m)	Margin (dB)	Detector
1	2483.500	17.86	31.24	49.10	74.00	-24.90	peak
2 *	2483.500	5.99	31.24	37.23	54.00	-16.77	AVG

Remarks:

- 1. Factor (dB/m) = Antenna Factor (dB/m)+Cable Factor (dB)-Pre-amplifier Factor
- 2. Margin value = Level -Limit value





<b>Ant. Pol.</b>	Vertical
<b>Test Mode:</b>	GFSK Mode 2480 MHz

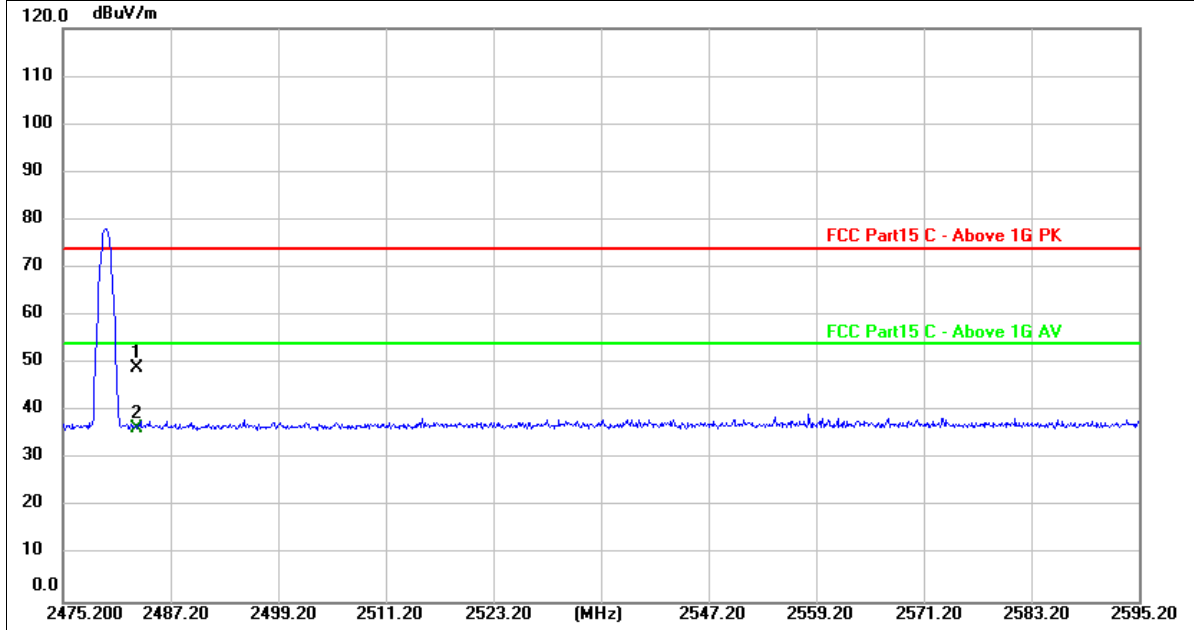

No.	Frequency (MHz)	Reading (dBuV)	Factor (dB/m)	Level (dBuV/m)	Limit (dBuV/m)	Margin (dB)	Detector
1	2483.500	17.92	31.24	49.16	74.00	-24.84	peak
2 *	2483.500	5.24	31.24	36.48	54.00	-17.52	AVG

Remarks:  
 1. Factor (dB/m) = Antenna Factor (dB/m)+Cable Factor (dB)-Pre-amplifier Factor  
 2. Margin value = Level -Limit value





Ant. Pol.	Horizontal
Test Mode:	$\pi/4$ -DQPSK Mode 2402MHz

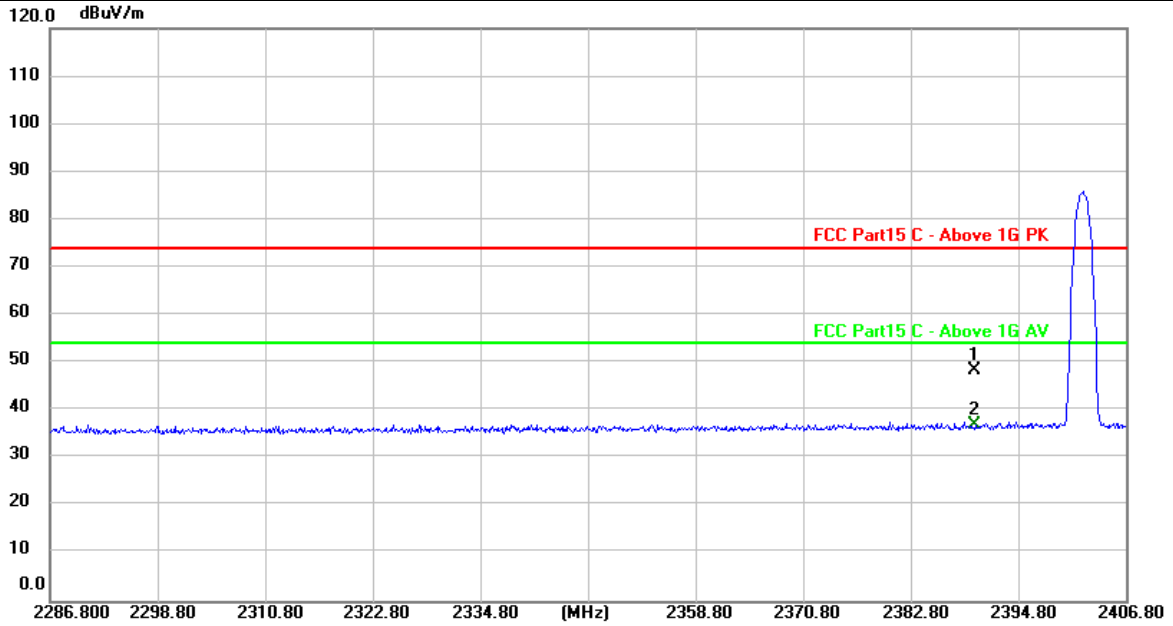

No.	Frequency (MHz)	Reading (dBuV)	Factor (dB/m)	Level (dBuV/m)	Limit (dBuV/m)	Margin (dB)	Detector
1	2390.000	17.69	30.84	48.53	74.00	-25.47	peak
2 *	2390.000	6.34	30.84	37.18	54.00	-16.82	AVG

Remarks:

1. Factor (dB/m) = Antenna Factor (dB/m)+Cable Factor (dB)-Pre-amplifier Factor
2. Margin value = Level -Limit value



Ant. Pol.	Vertical
Test Mode:	$\pi/4$ -DQPSK Mode 2402MHz

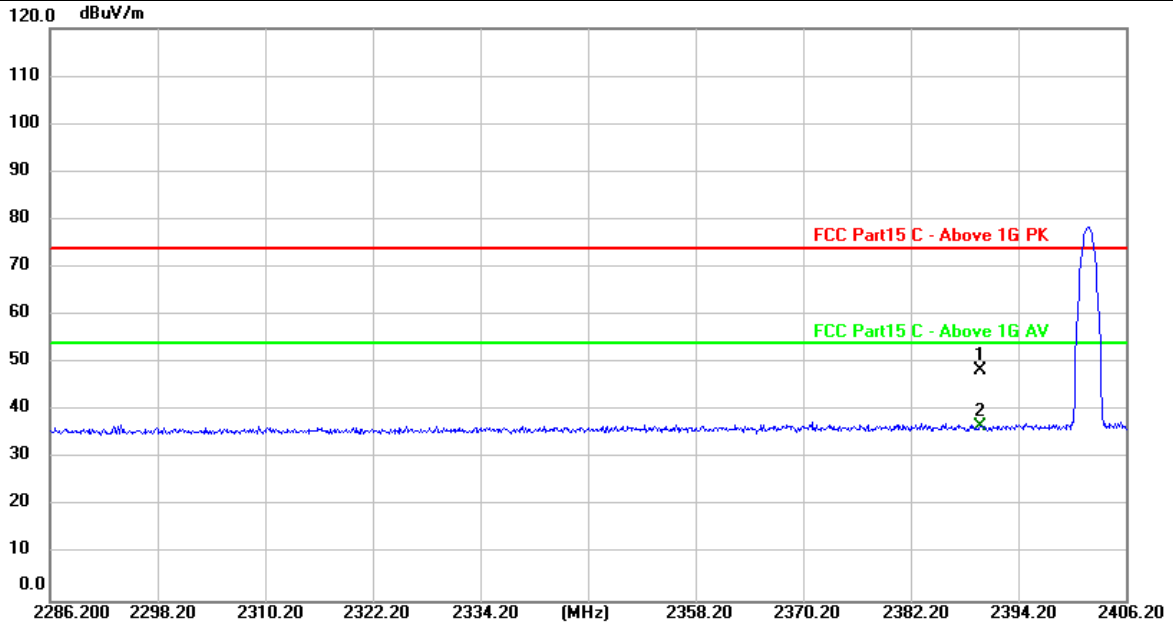

No.	Frequency (MHz)	Reading (dBuV)	Factor (dB/m)	Level (dBuV/m)	Limit (dBuV/m)	Margin (dB)	Detector
1	2390.000	17.48	30.84	48.32	74.00	-25.68	peak
2 *	2390.000	5.80	30.84	36.64	54.00	-17.36	AVG

Remarks:

- 1. Factor (dB/m) = Antenna Factor (dB/m)+Cable Factor (dB)-Pre-amplifier Factor
- 2. Margin value = Level -Limit value



<b>Ant. Pol.</b>	Horizontal
<b>Test Mode:</b>	$\pi/4$ -DQPSK Mode 2480MHz

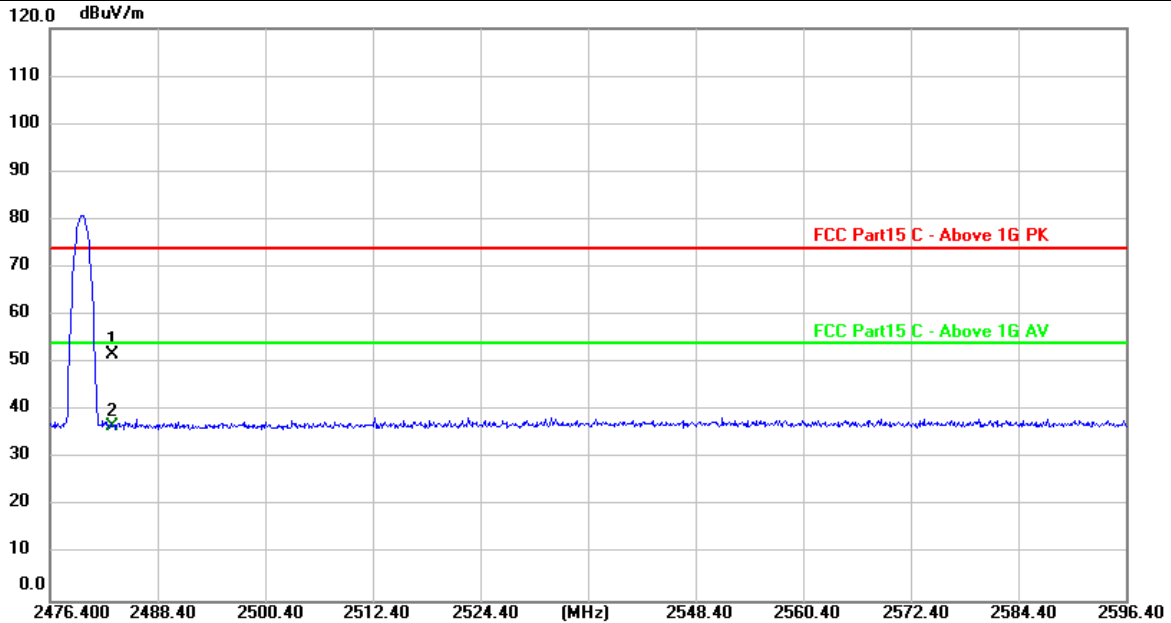

No.	Frequency (MHz)	Reading (dBuV)	Factor (dB/m)	Level (dBuV/m)	Limit (dBuV/m)	Margin (dB)	Detector
1	2483.500	20.58	31.24	51.82	74.00	-22.18	peak
2 *	2483.500	5.66	31.24	36.90	54.00	-17.10	AVG

Remarks:

- Factor (dB/m) = Antenna Factor (dB/m)+Cable Factor (dB)-Pre-amplifier Factor
- Margin value = Level -Limit value



<b>Ant. Pol.</b>	Vertical
<b>Test Mode:</b>	$\pi/4$ -DQPSK Mode 2480MHz

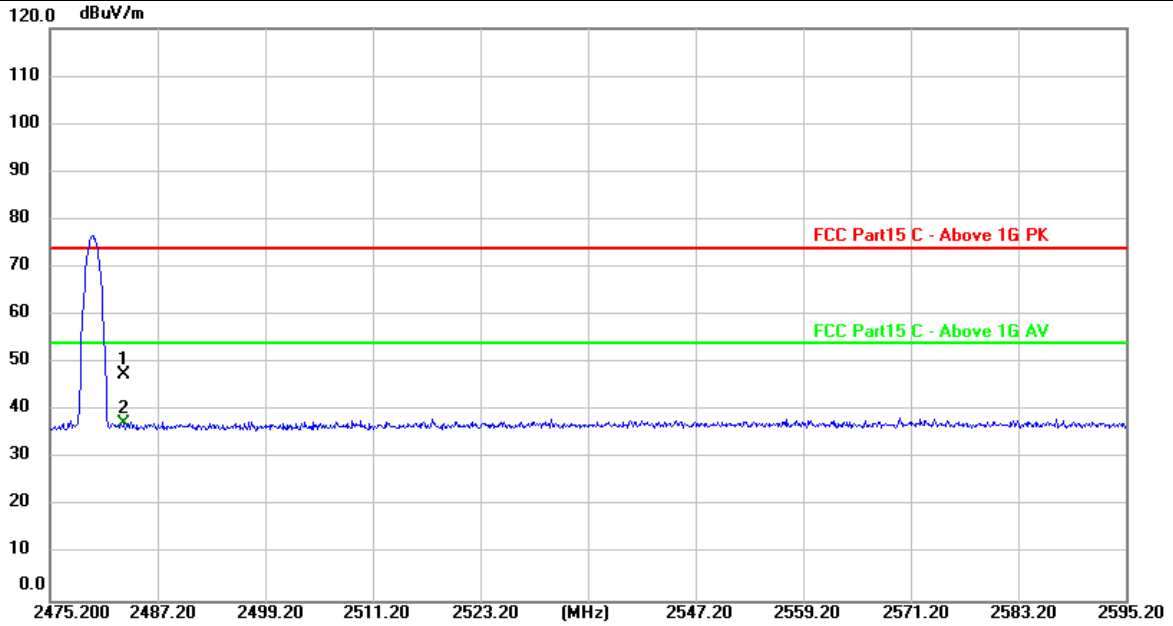

No.	Frequency (MHz)	Reading (dBuV)	Factor (dB/m)	Level (dBuV/m)	Limit (dBuV/m)	Margin (dB)	Detector
1	2483.500	16.35	31.24	47.59	74.00	-26.41	peak
2 *	2483.500	5.98	31.24	37.22	54.00	-16.78	AVG

Remarks:

- Factor (dB/m) = Antenna Factor (dB/m)+Cable Factor (dB)-Pre-amplifier Factor
- Margin value = Level -Limit value



Ant. Pol.	Horizontal
Test Mode:	8-DPSK Mode 2402MHz

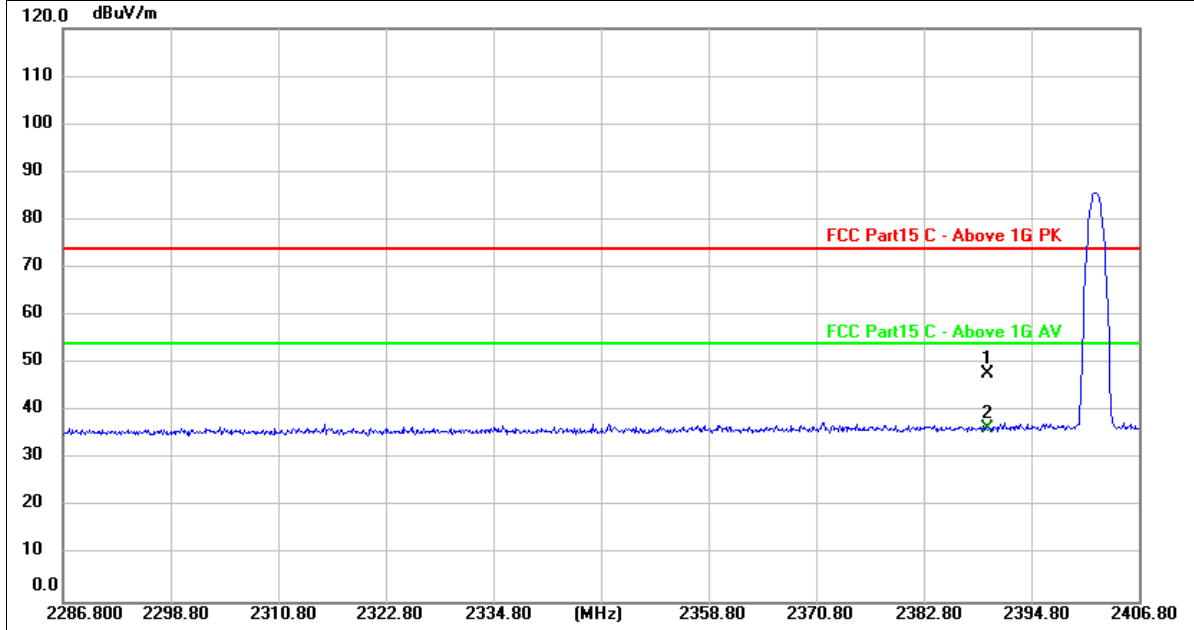

No.	Frequency (MHz)	Reading (dBuV)	Factor (dB/m)	Level (dBuV/m)	Limit (dBuV/m)	Margin (dB)	Detector
1	2390.000	17.14	30.84	47.98	74.00	-26.02	peak
2 *	2390.000	5.50	30.84	36.34	54.00	-17.66	AVG

Remarks:  
 1. Factor (dB/m) = Antenna Factor (dB/m)+Cable Factor (dB)-Pre-amplifier Factor  
 2. Margin value = Level -Limit value



Ant. Pol.	Vertical
Test Mode:	8-DPSK Mode 2402MHz

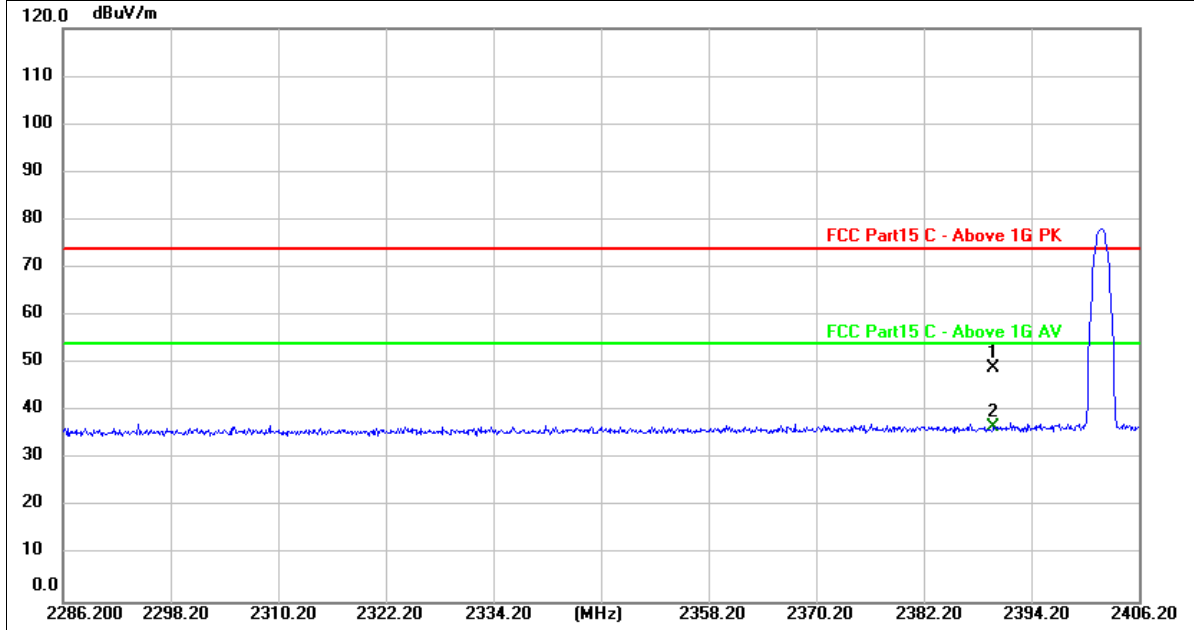

No.	Frequency (MHz)	Reading (dBuV)	Factor (dB/m)	Level (dBuV/m)	Limit (dBuV/m)	Margin (dB)	Detector
1	2390.000	18.21	30.84	49.05	74.00	-24.95	peak
2 *	2390.000	5.89	30.84	36.73	54.00	-17.27	AVG

Remarks:

- 1.Factor (dB/m) = Antenna Factor (dB/m)+Cable Factor (dB)-Pre-amplifier Factor
- 2.Margin value = Level -Limit value



Ant. Pol.	Horizontal
Test Mode:	8-DPSK Mode 2480MHz

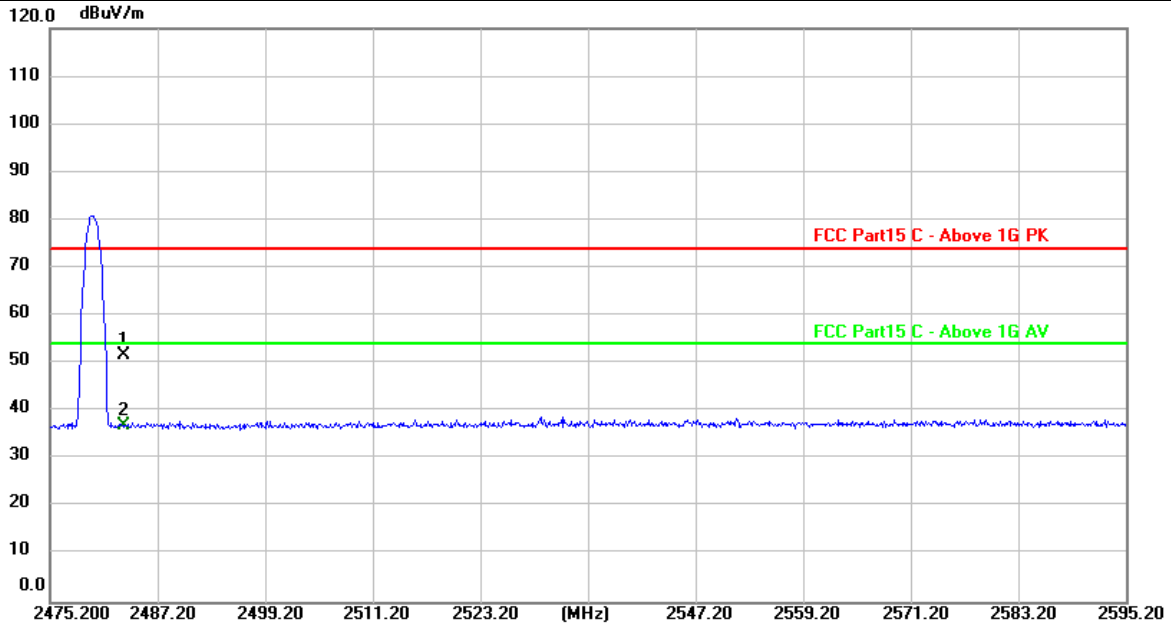

No.	Frequency (MHz)	Reading (dBuV)	Factor (dB/m)	Level (dBuV/m)	Limit (dBuV/m)	Margin (dB)	Detector
1	2483.500	20.49	31.24	51.73	74.00	-22.27	peak
2 *	2483.500	5.68	31.24	36.92	54.00	-17.08	AVG

Remarks:

- Factor (dB/m) = Antenna Factor (dB/m)+Cable Factor (dB)-Pre-amplifier Factor
- Margin value = Level -Limit value



<b>Ant. Pol.</b>	Vertical
<b>Test Mode:</b>	8-DPSK Mode 2480MHz

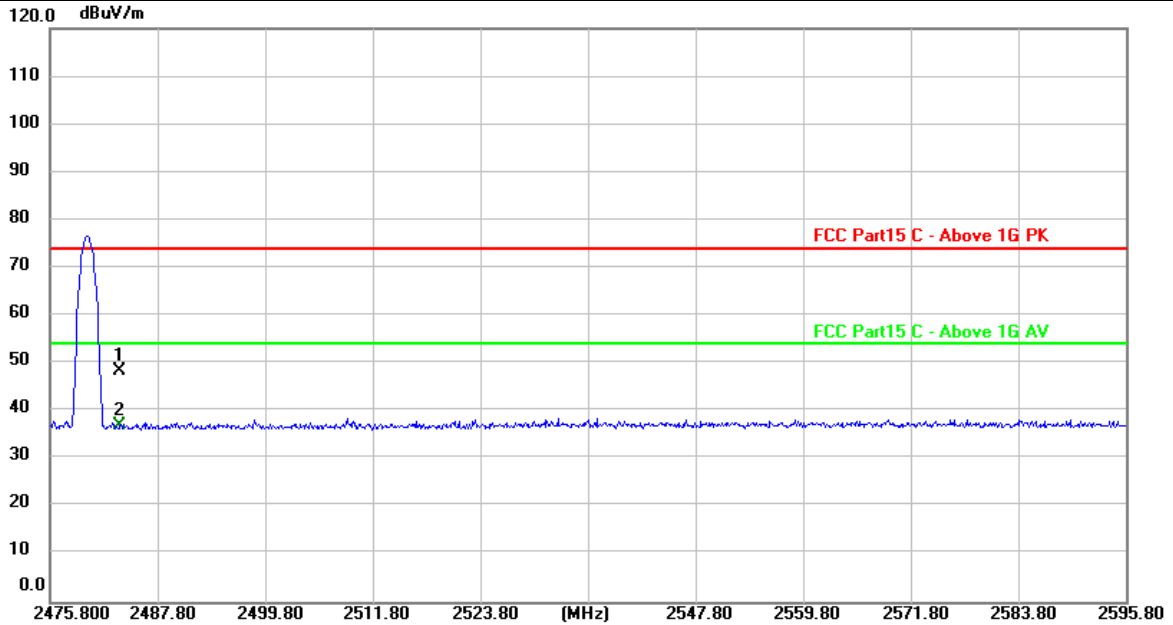

No.	Frequency (MHz)	Reading (dBuV)	Factor (dB/m)	Level (dBuV/m)	Limit (dBuV/m)	Margin (dB)	Detector
1	2483.500	17.31	31.24	48.55	74.00	-25.45	peak
2 *	2483.500	5.82	31.24	37.06	54.00	-16.94	AVG

Remarks:

- Factor (dB/m) = Antenna Factor (dB/m)+Cable Factor (dB)-Pre-amplifier Factor
- Margin value = Level -Limit value



### 3.4. Band edge and Spurious Emissions (Conducted)

#### Limit

FCC CFR Title 47 Part 15 Subpart C Section 15.247 (d): In any 100 kHz bandwidth outside the frequency band in which the spread spectrum intentional radiator is operating, the radio frequency power that is produced by the intentional radiator shall be at least 20 dB below that in the 100 kHz bandwidth within the band that contains the highest level of the desired power, based on either an RF conducted or a radiated measurement.

#### Test Configuration

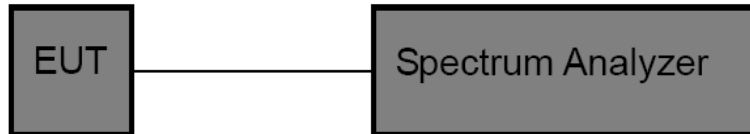

#### Test Procedure

1. The transmitter output was connected to the spectrum analyzer through an attenuator, the path loss was compensated to the results for each measurement.
2. Set to the maximum power setting and enable the EUT transmit continuously
3. Use the following spectrum analyzer settings:  
RBW = 100 kHz, VBW ≥ RBW, scan up through 10<sup>th</sup> harmonic.  
Sweep = auto, Detector function = peak, Trace = max hold
4. Measure and record the results in the test report.

#### Test Mode

Please refer to the clause 2.4.

#### Test Results

##### (1) Band edge Conducted Test

Test Mode	Ch Name	Frequency (MHz)	Ref Level [dBm]	Result [dBm]	Limit [dBm]	Verdict
GFSK	Low	2402	-3.52	-55.55	≤-23.52	PASS
	High	2480	-4.12	-57.68	≤-24.12	PASS
	Low	Hop_2402	-3.68	-56.68	≤-23.68	PASS
	High	Hop_2480	-6.33	-58.64	≤-26.33	PASS
π/4-DQPSK	Low	2402	-3.74	-58.24	≤-23.74	PASS
	High	2480	-4.35	-57.27	≤-24.35	PASS
	Low	Hop_2402	-5.73	-58.30	≤-25.73	PASS
	High	Hop_2480	-4.92	-57.95	≤-24.92	PASS
8-DPSK	Low	2402	-3.47	-53.37	≤-23.47	PASS
	High	2480	-4.04	-58.29	≤-24.04	PASS
	Low	Hop_2402	-4.33	-58.85	≤-24.33	PASS
	High	Hop_2480	-4.14	-57.83	≤-24.14	PASS



Test plot as follows:

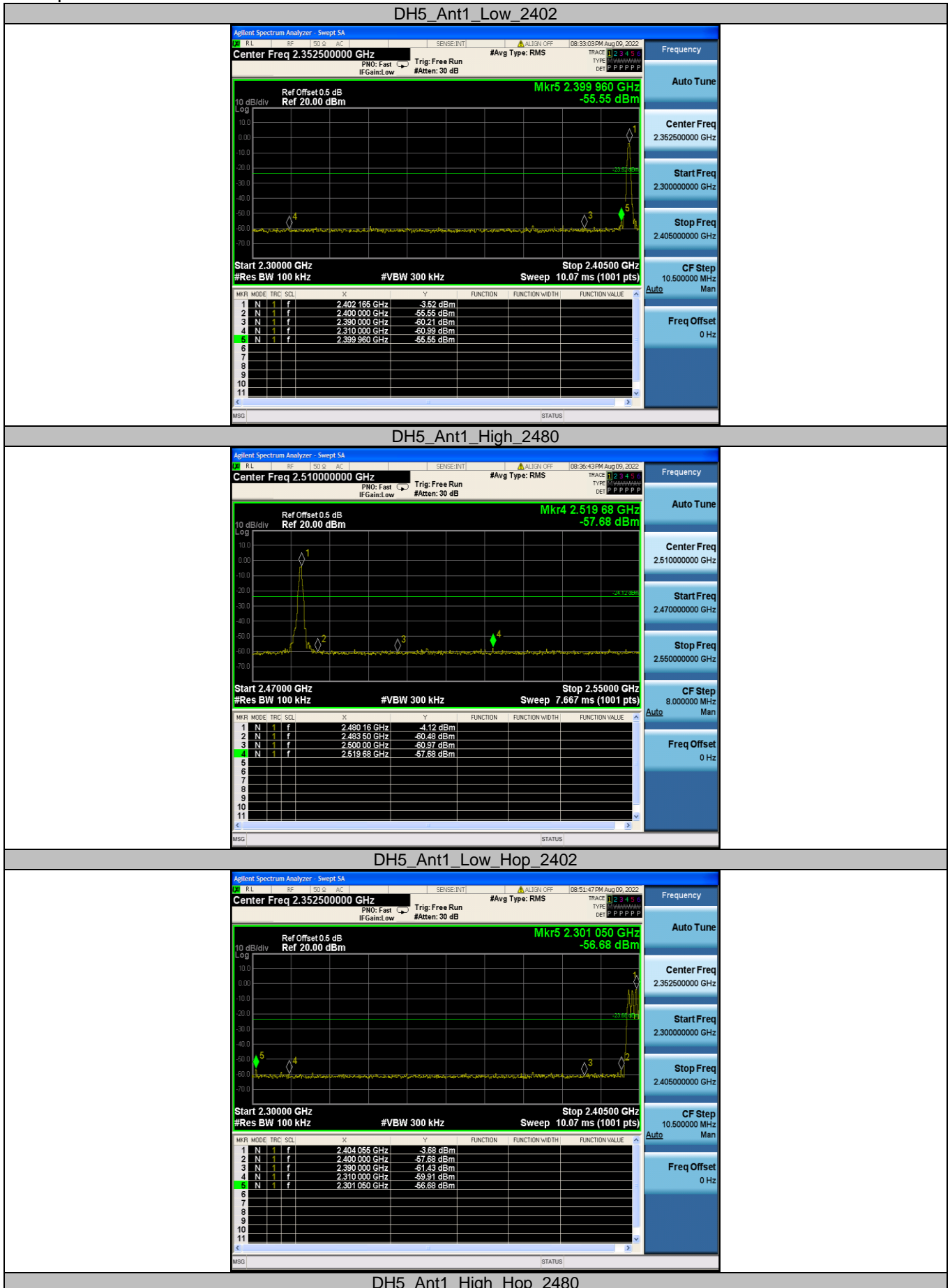

CTC Laboratories, Inc.

1-2/F., Building 2, Jiaquan Building, Guanlan High-Tech Park, Shenzhen, Guangdong, China  
 Tel.: (86)755-27521059 Fax: (86)755-27521011 Http://www.sz-ctc.org.cn



For anti-fake verification, please visit the official website of Certification and Accreditation Administration of the People's Republic of China : [yz.cnca.cn](http://yz.cnca.cn)

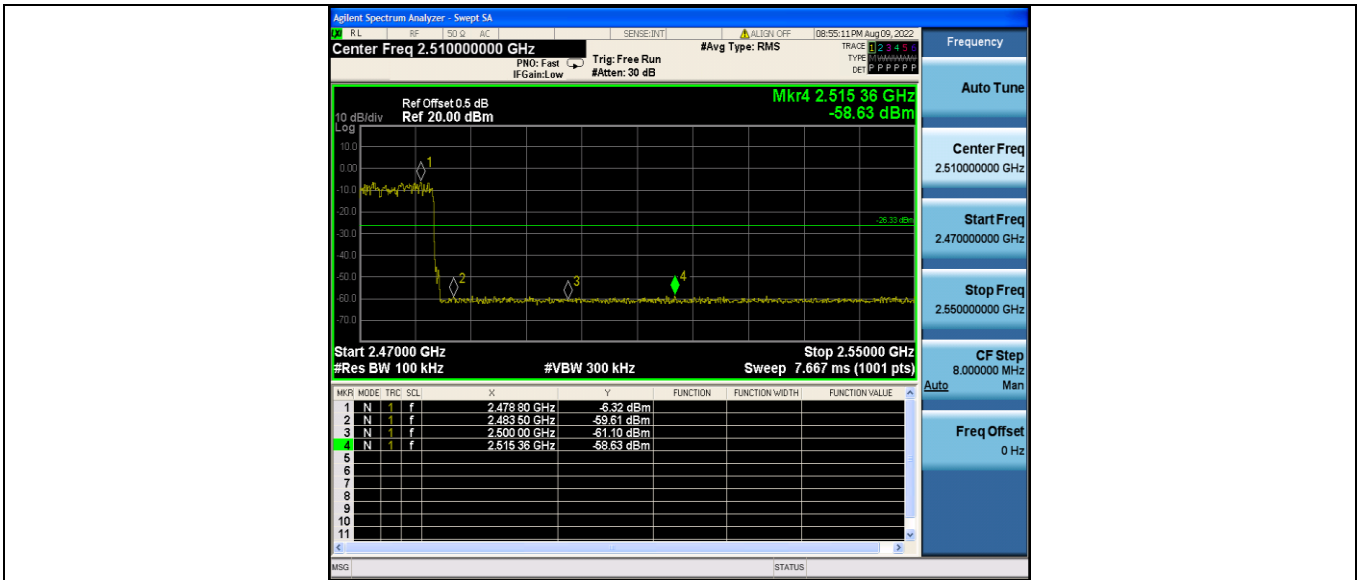

2DH5\_Ant1\_Low\_2402

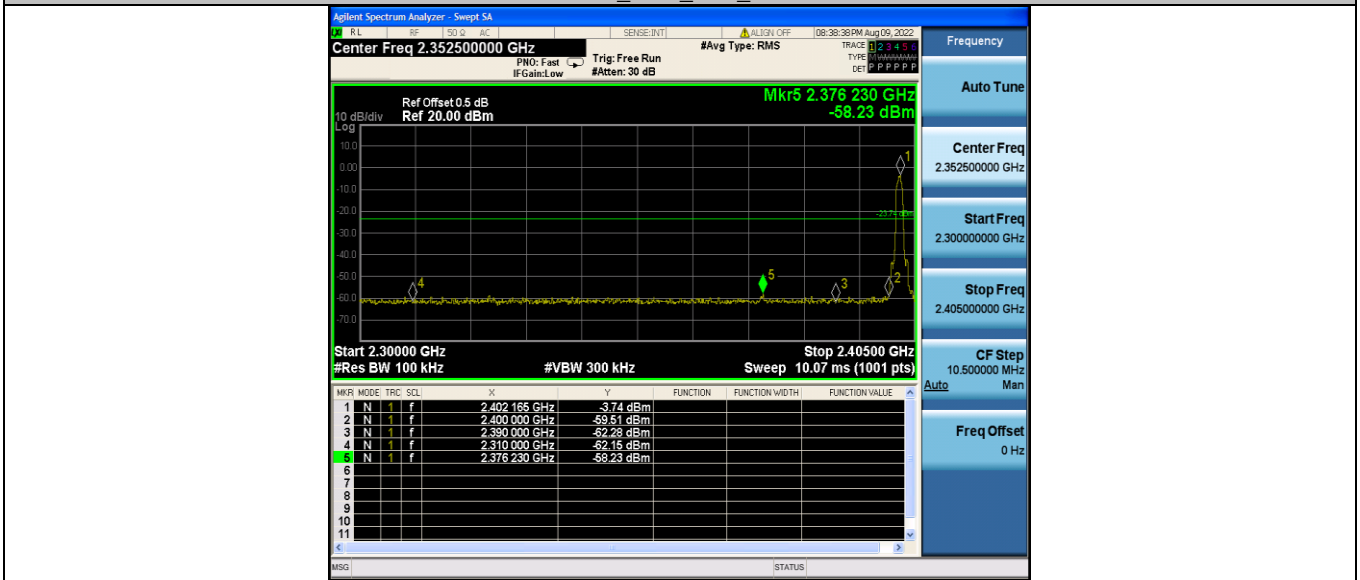

2DH5\_Ant1\_High\_2480

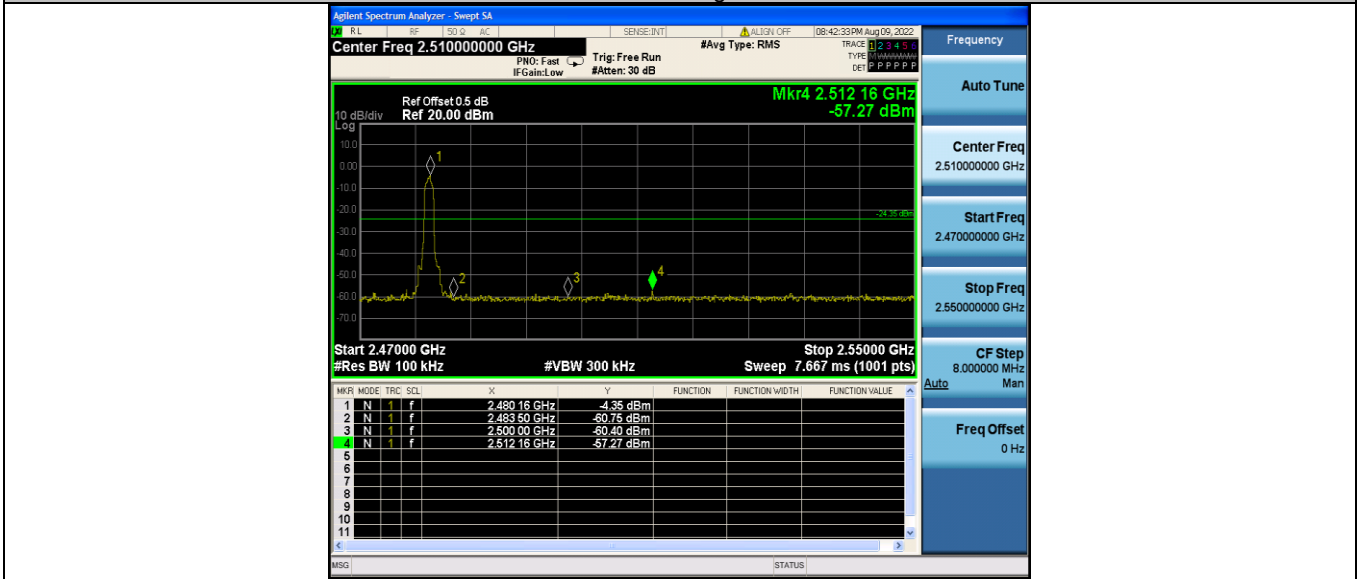

2DH5\_Ant1\_Low\_Hop\_2402

CTC Laboratories, Inc.

1-2/F., Building 2, Jiaquan Building, Guanlan High-Tech Park, Shenzhen, Guangdong, China  
Tel.: (86)755-27521059

Fax: (86)755-27521011 Http://www.sz-ctc.org.cn  
For anti-fake verification, please visit the official website of Certification and Accreditation Administration of the People's Republic of China : [yz.cnca.cn](http://yz.cnca.cn)



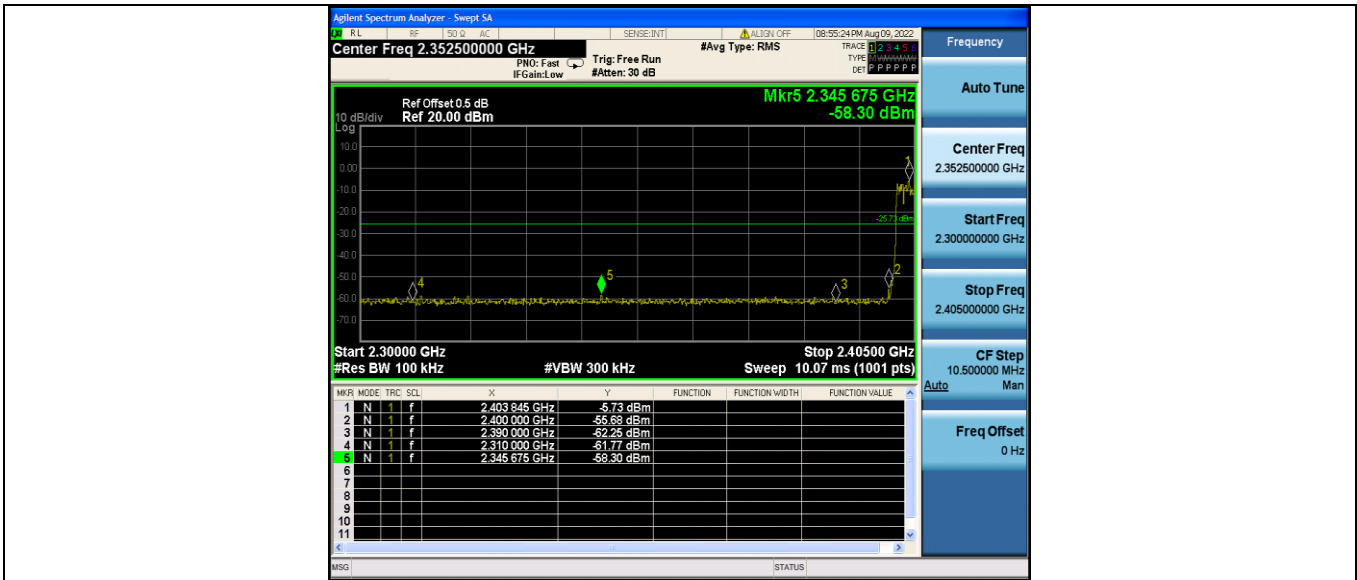

2DH5 Ant1 High Hop 2480

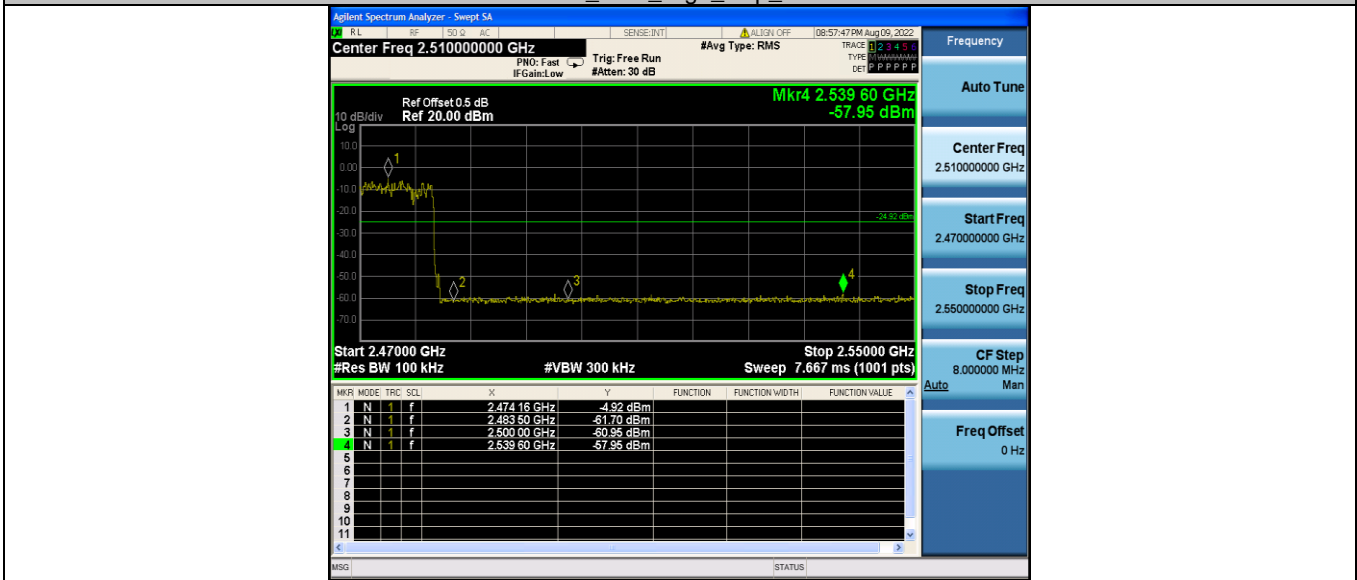

3DH5 Ant1 Low 2402

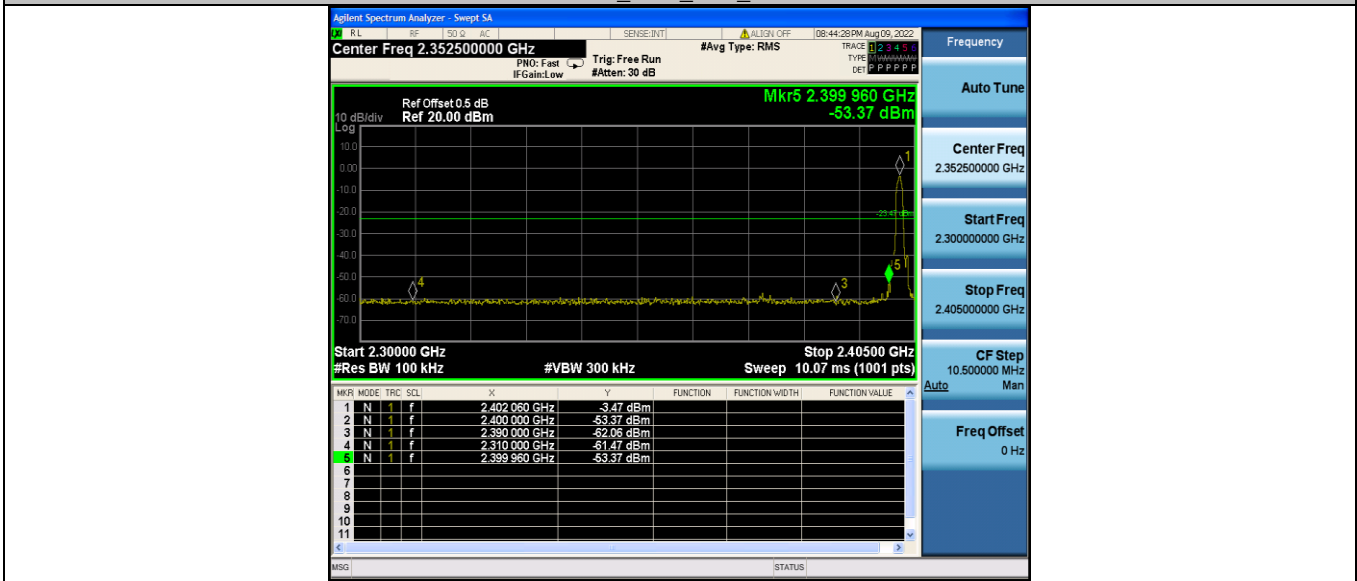

3DH5 Ant1 High 2480

CTC Laboratories, Inc.

1-2/F., Building 2, Jiaquan Building, Guanlan High-Tech Park, Shenzhen, Guangdong, China  
Tel.: (86)755-27521059

Fax: (86)755-27521011 Http://www.sz-ctc.org.cn  
For anti-fake verification, please visit the official website of Certification and Accreditation Administration of the People's Republic of China : [yz.cnca.cn](http://yz.cnca.cn)



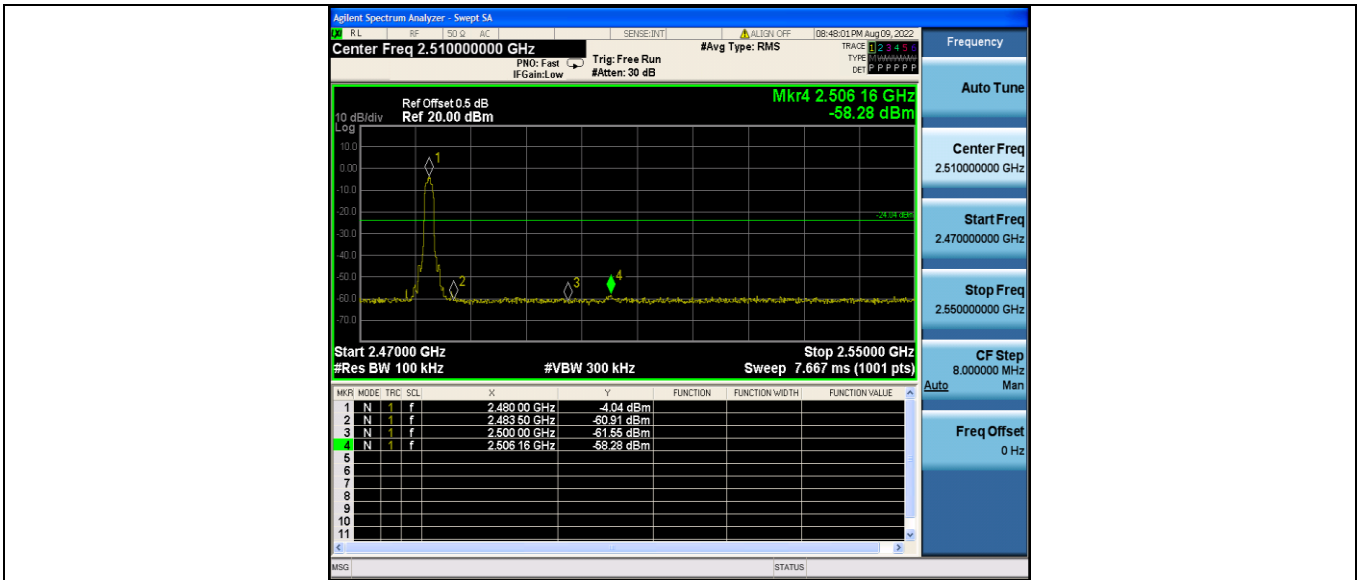

3DH5\_Ant1\_Low\_Hop\_2402

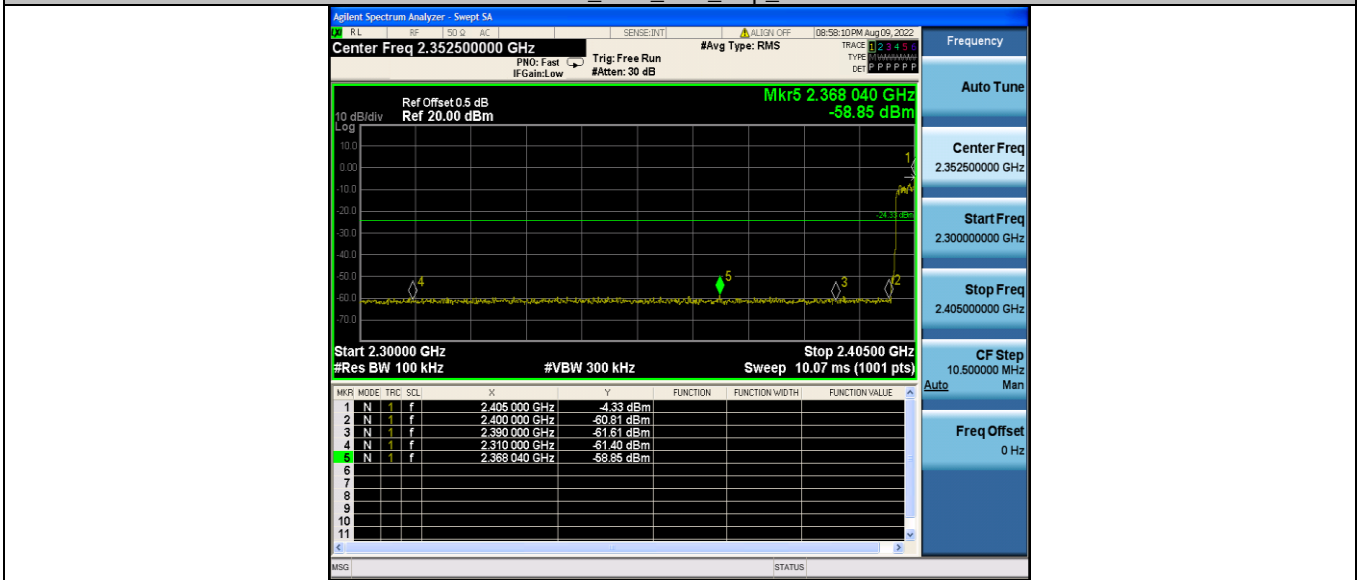

3DH5\_Ant1\_High\_Hop\_2480

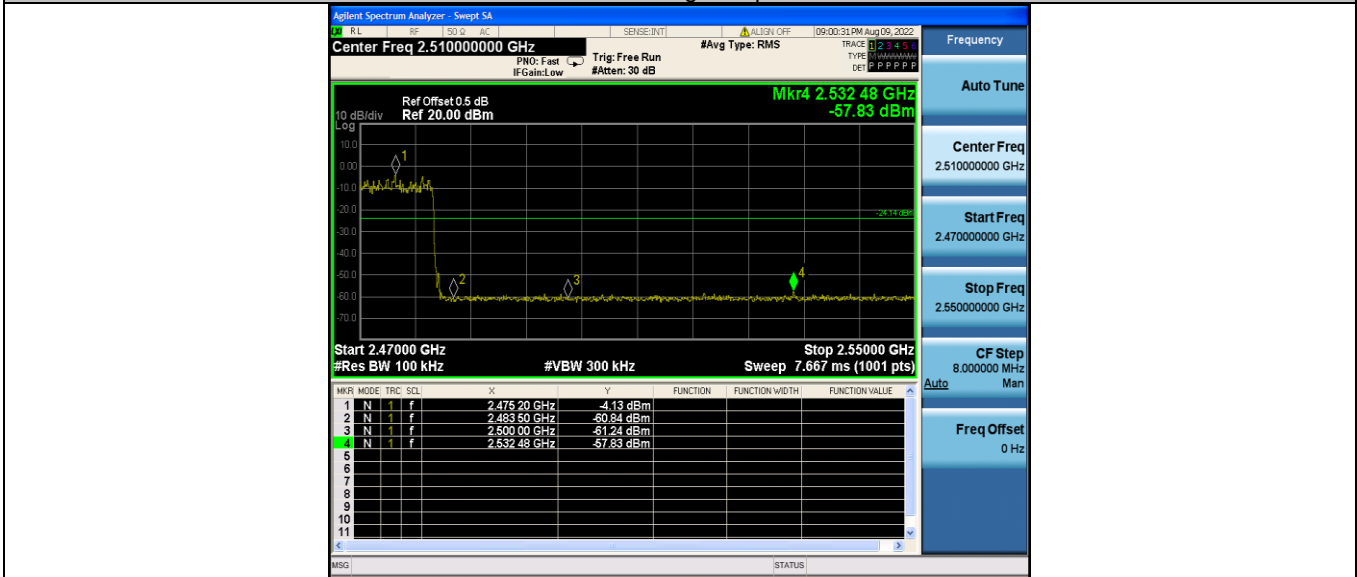

**(2) Conducted Spurious Emissions Test**

Test Mode	Antenna	Frequency (MHz)	Freq Range [MHz]	Ref Level [dBm]	Result [dBm]	Limit [dBm]	Verdict
GFSK	Ant1	2402	Reference	-3.57	-3.57	---	PASS
			30~1000	-3.57	-51.84	≤-23.57	PASS
			1000~26500	-3.57	-44.72	≤-23.57	PASS
		2441	Reference	-3.66	-3.66	---	PASS
			30~1000	-3.66	-51.99	≤-23.66	PASS
			1000~26500	-3.66	-43.65	≤-23.66	PASS
		2480	Reference	-4.16	-4.16	---	PASS
			30~1000	-4.16	-59.60	≤-24.16	PASS
			1000~26500	-4.16	-42.58	≤-24.16	PASS
π/4-DQPSK	Ant1	2402	Reference	-3.97	-3.97	---	PASS
			30~1000	-3.97	-62.07	≤-23.97	PASS
			1000~26500	-3.97	-46.17	≤-23.97	PASS
		2441	Reference	-3.85	-3.85	---	PASS
			30~1000	-3.85	-61.94	≤-23.85	PASS
			1000~26500	-3.85	-44.46	≤-23.85	PASS
		2480	Reference	-4.55	-4.55	---	PASS
			30~1000	-4.55	-61.93	≤-24.55	PASS
			1000~26500	-4.55	-43.65	≤-24.55	PASS
8-DPSK	Ant1	2402	Reference	-3.47	-3.47	---	PASS
			30~1000	-3.47	-58.25	≤-23.47	PASS
			1000~26500	-3.47	-43.79	≤-23.47	PASS
		2441	Reference	-3.57	-3.57	---	PASS
			30~1000	-3.57	-47.86	≤-23.57	PASS
			1000~26500	-3.57	-45.95	≤-23.57	PASS
		2480	Reference	-4.11	-4.11	---	PASS
			30~1000	-4.11	-54.70	≤-24.11	PASS
			1000~26500	-4.11	-44.22	≤-24.11	PASS



Test plot as follows:

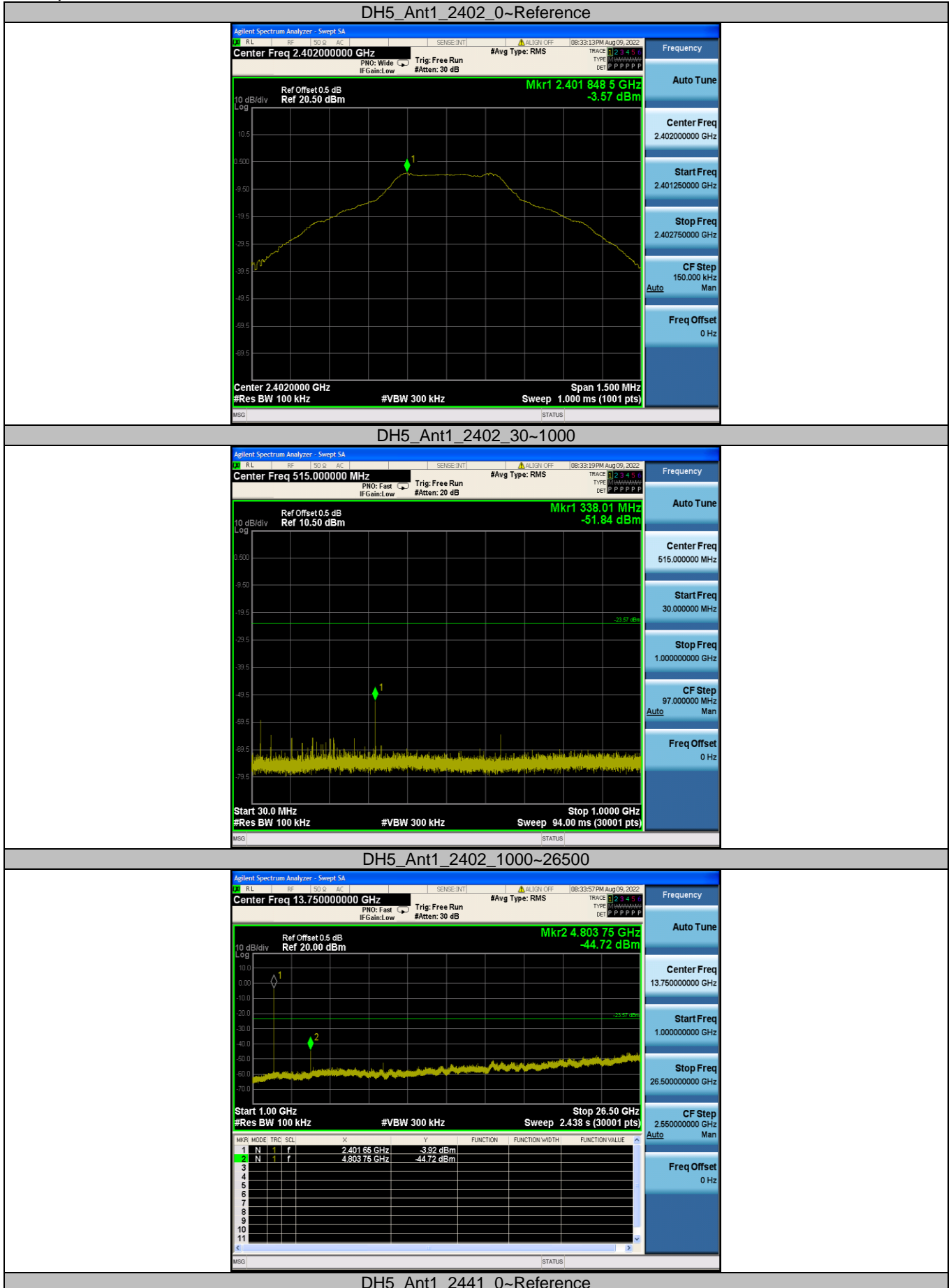

CTC Laboratories, Inc.

1-2/F., Building 2, Jiaquan Building, Guanlan High-Tech Park, Shenzhen, Guangdong, China  
Tel.: (86)755-27521059 Fax: (86)755-27521011 Http://www.sz-ctc.org.cn



For anti-fake verification, please visit the official website of Certification and Accreditation Administration of the People's Republic of China : [yz.cnca.cn](http://yz.cnca.cn)



DH5\_Ant1\_2441\_30~1000

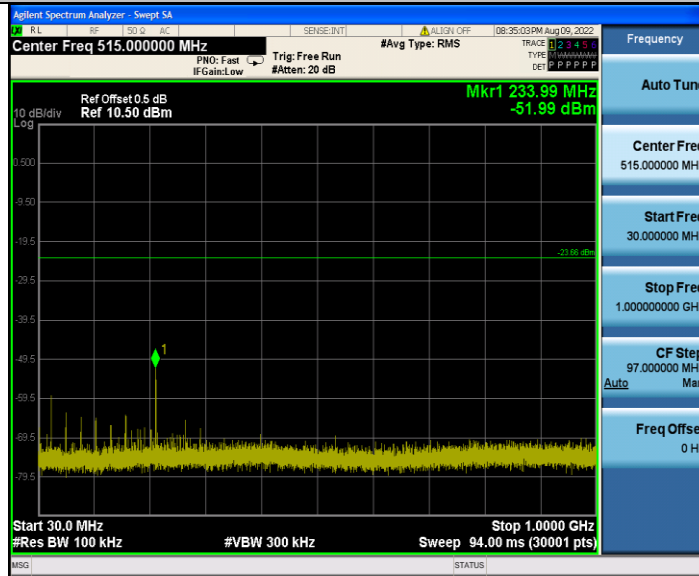

DH5\_Ant1\_2441\_1000~26500

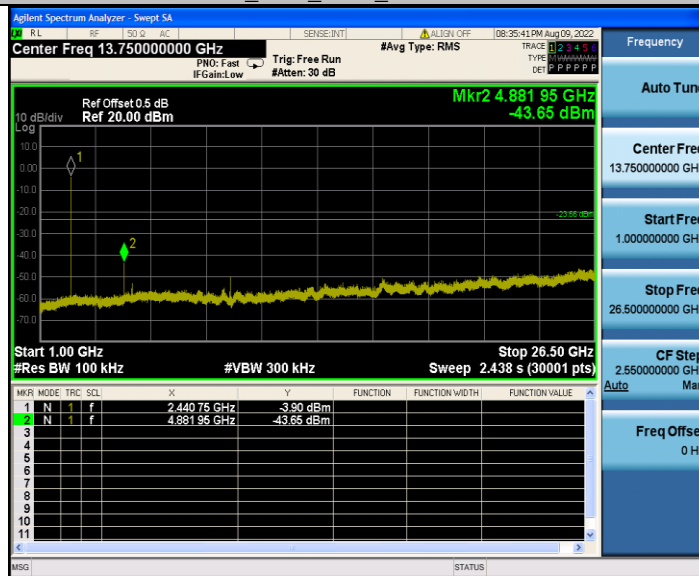

DH5\_Ant1\_2480\_0~Reference

CTC Laboratories, Inc.

1-2/F., Building 2, Jiaquan Building, Guanlan High-Tech Park, Shenzhen, Guangdong, China  
Tel.: (86)755-27521059

Fax: (86)755-27521011 Http://www.sz-ctc.org.cn  
For anti-fake verification, please visit the official website of Certification and Accreditation Administration of the People's Republic of China : [yz.cnca.cn](http://yz.cnca.cn)







DH5\_Ant1\_2480\_30~1000

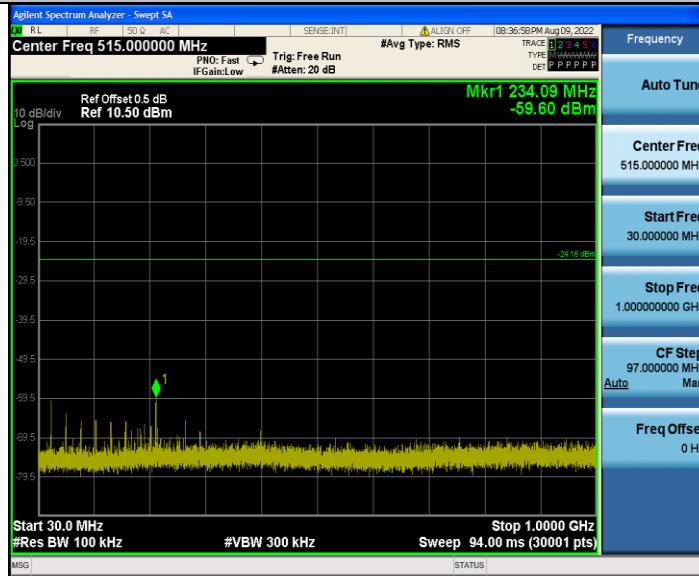

DH5\_Ant1\_2480\_1000~26500

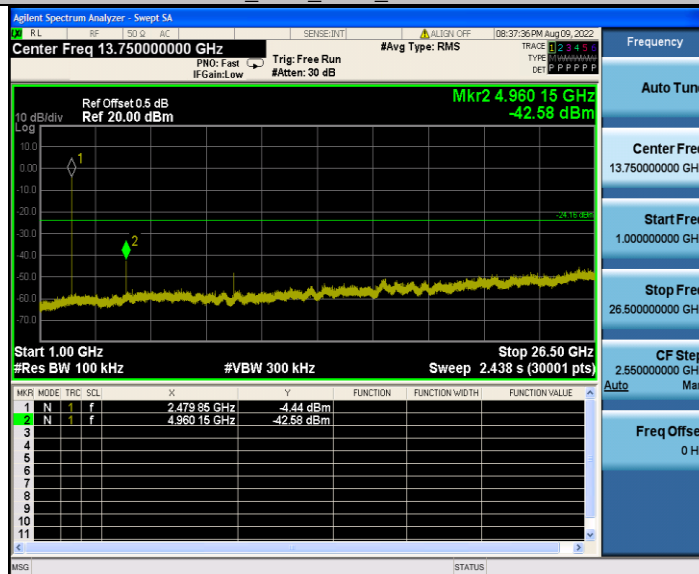

2DH5\_Ant1\_2402\_0~Reference

CTC Laboratories, Inc.

1-2/F., Building 2, Jiaquan Building, Guanlan High-Tech Park, Shenzhen, Guangdong, China  
Tel.: (86)755-27521059

Fax: (86)755-27521011 Http://www.sz-ctc.org.cn  
For anti-fake verification, please visit the official website of Certification and Accreditation Administration of the People's Republic of China : [yz.cnca.cn](http://yz.cnca.cn)



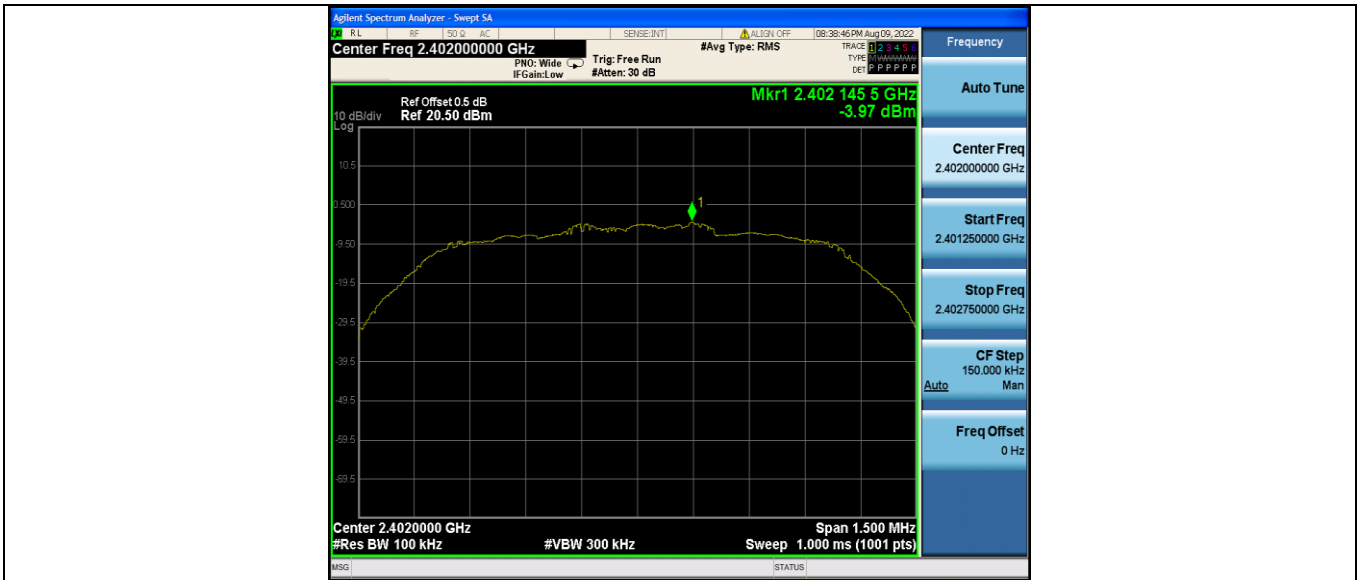

2DH5\_Ant1\_2402\_30~1000

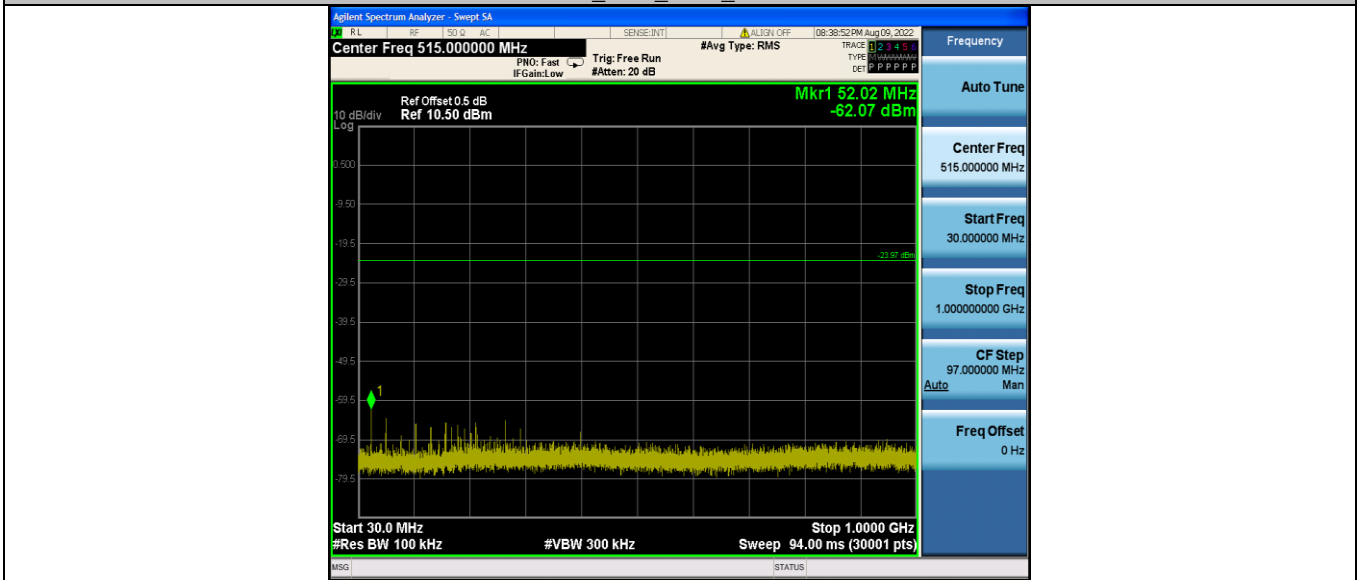

2DH5\_Ant1\_2402\_1000~26500

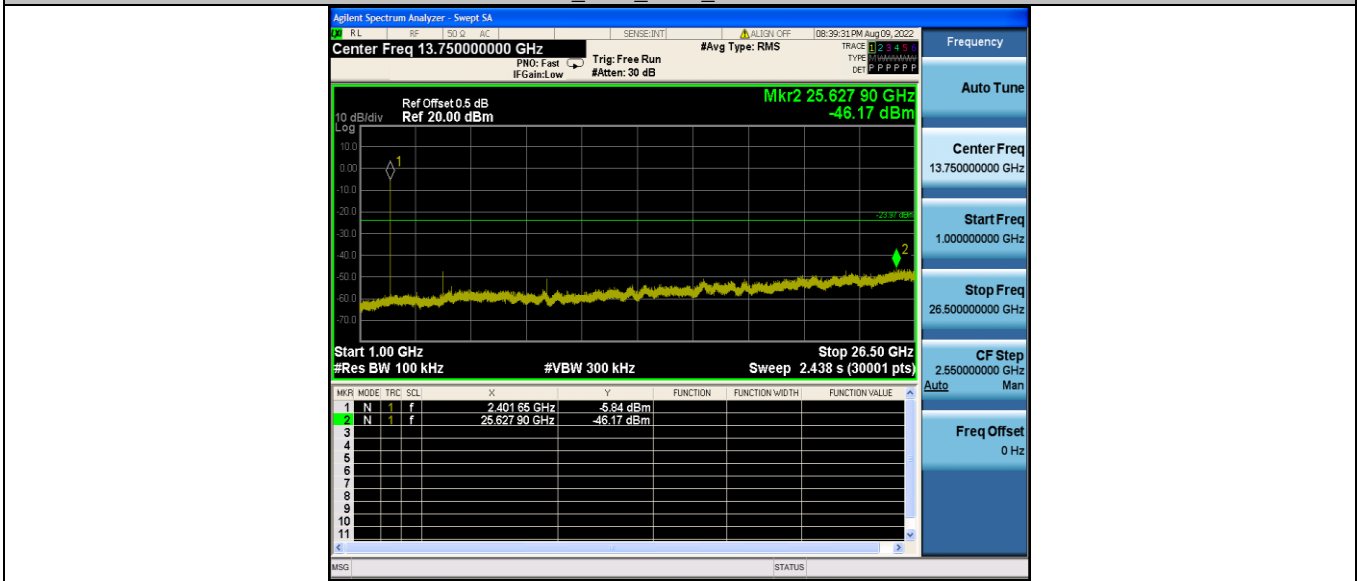

2DH5\_Ant1\_2441\_0~Reference

CTC Laboratories, Inc.

1-2/F., Building 2, Jiaquan Building, Guanlan High-Tech Park, Shenzhen, Guangdong, China  
Tel.: (86)755-27521059

Fax: (86)755-27521011 Http://www.sz-ctc.org.cn  
For anti-fake verification, please visit the official website of Certification and Accreditation Administration of the People's Republic of China : [yz.cnca.cn](http://yz.cnca.cn)

