



CFR 47 FCC PART 15 SUBPART C(DSS)

TEST REPORT

For

Portable Thermal Printer

**MODEL NUMBER: APA46Y, A46, A46L, A46S, ITP05, ITP05S, A46H, A41, MP-8018,
MP-8018T, LJA4A46A, A42, A42H, A43, A43H, TPA46H, A46YPRO, TPA46YH,
A46PRO**

REPORT NUMBER: E04A25010474F00401

ISSUE DATE: February 26, 2025

FCC ID: 2A74AA46Y

Prepared for

Xiamen Lujiang Technology Co., Ltd.

**Room 601-2, No.63-1, Wanghai Road, Software Park Phase II, Torch Hi-Tech Zone,
Xiamen, China**

Prepared by

Guangdong Global Testing Technology Co., Ltd.

**Room 101-105, 203-210, Building 1, No.2, Keji 8 Road, Songshan Lake Park,
Dongguan city, Guangdong, People's Republic of China, 523808**

**This report is based on a single evaluation of the submitted sample(s) of the above
mentioned product, it does not imply an assessment of the production of the products.**

**This report shall not be reproduced, except in full, without the written approval of
Guangdong Global Testing Technology Co., Ltd.**

Revision History

Rev.	Issue Date	Revisions	Revised By
V0	February 26, 2025	Initial Issue	

Summary of Test Results

Test Item	Clause	Limit/Requirement	Result
Antenna Requirement	N/A	FCC Part 15.203/15.247 (c)	Pass
AC Power Line Conducted Emission	ANSI C63.10-2013 Clause 6.2	FCC Part 15.207	Pass
Conducted Output Power	ANSI C63.10-2013 Clause 7.8.5	FCC Part 15.247 (b)(1)	Pass
20 dB Bandwidth and 99% Occupied Bandwidth	ANSI C63.10-2013 Clause 6.9.2	FCC Part 15.247 (a)(1)	Pass
Carrier Hopping Channel Separation	ANSI C63.10-2013 Clause 7.8.2	FCC Part 15.247 (a)(1)	Pass
Number of Hopping Frequency	ANSI C63.10-2013 Clause 7.8.3	FCC Part 15.247 (b)(1)	Pass
Time of Occupancy (Dwell Time)	ANSI C63.10-2013 Clause 7.8.4	FCC Part 15.247 (a)(1)	Pass
Conducted Bandedge and Spurious Emission	ANSI C63.10-2013 Clause 6.10.4 & Clause 7.8.8	FCC Part 15.247(d)	Pass
Radiated Band edge and Spurious Emission	ANSI C63.10-2013 Clause 6.3 & 6.5 & 6.6	FCC Part 15.205/15.209	Pass
Duty Cycle	ANSI C63.10-2013, Clause 11.6	None; for reporting purposes only.	Pass

*This test report is only published to and used by the applicant, and it is not for evidence purpose in China.

*The measurement result for the sample received is <Pass> according to <CFR 47 FCC PART 15 SUBPART C(DSS)> when <Accuracy Method> decision rule is applied.

CONTENTS

1.	ATTESTATION OF TEST RESULTS.....	5
2.	TEST METHODOLOGY.....	6
3.	FACILITIES AND ACCREDITATION.....	6
4.	CALIBRATION AND UNCERTAINTY	7
4.1.	<i>MEASURING INSTRUMENT CALIBRATION</i>	<i>7</i>
4.2.	<i>MEASUREMENT UNCERTAINTY.....</i>	<i>7</i>
5.	EQUIPMENT UNDER TEST	8
5.1.	<i>DESCRIPTION OF EUT</i>	<i>8</i>
5.2.	<i>CHANNEL LIST</i>	<i>8</i>
5.3.	<i>Maximum Peak Output Power.....</i>	<i>9</i>
5.4.	<i>TEST CHANNEL CONFIGURATION.....</i>	<i>9</i>
5.5.	<i>THE WORSE CASE POWER SETTING PARAMETER.....</i>	<i>9</i>
5.6.	<i>DESCRIPTION OF AVAILABLE ANTENNAS</i>	<i>10</i>
5.7.	<i>SUPPORT UNITS FOR SYSTEM TEST</i>	<i>10</i>
5.8.	<i>SETUP DIAGRAM</i>	<i>10</i>
6.	MEASURING EQUIPMENT AND SOFTWARE USED.....	12
7.	ANTENNA PORT TEST RESULTS	14
7.1.	<i>Conducted Output Power.....</i>	<i>14</i>
7.2.	<i>20 dB Bandwidth and 99% Occupied Bandwidth.....</i>	<i>15</i>
7.3.	<i>Carrier Hopping Channel Separation</i>	<i>16</i>
7.4.	<i>Number of Hopping Frequency</i>	<i>18</i>
7.5.	<i>Time of Occupancy (Dwell Time)</i>	<i>19</i>
7.6.	<i>Conducted Bandedge and Spurious Emission</i>	<i>21</i>
7.7.	<i>Duty Cycle</i>	<i>23</i>
8.	RADIATED TEST RESULTS.....	24
8.1.	<i>Radiated Band edge and Spurious Emission</i>	<i>30</i>
9.	ANTENNA REQUIREMENT	42
10.	AC POWER LINE CONDUCTED EMISSION	43
11.	TEST DATA - Appendix A.....	46

1. ATTESTATION OF TEST RESULTS

Applicant Information

Company Name: Xiamen Lujiang Technology Co., Ltd.
Address: Room 601-2, No.63-1, Wanghai Road, Software Park Phase II, Torch Hi-Tech Zone, Xiamen, China

Manufacturer Information

Company Name: Xiamen Lujiang Technology Co., Ltd.
Address: Room 601-2, No.63-1, Wanghai Road, Software Park Phase II, Torch Hi-Tech Zone, Xiamen, China

EUT Information

Product Description: Portable Thermal Printer
Model: APA46Y
Series Model: A46, A46L, A46S, ITP05, ITP05S, A46H, A41, MP-8018, MP-8018T, LJA4A46A, A42, A42H, A43, A43H, TPA46H, A46YPRO, TPA46YH, A46PRO
Brand: /
Sample Received Date: January 17, 2025
Sample Status: Normal
Sample ID: A25010474 001
Date of Tested: January 17, 2025 to February 26, 2025

APPLICABLE STANDARDS	
STANDARD	TEST RESULTS
CFR 47 FCC PART 15 SUBPART C(DSS)	Pass

Prepared By:

Win Huang

Win Huang

Project Engineer

Checked By:

Alan He

Alan He

Laboratory Leader

Approved By:

Shawn Wen

Shawn Wen

Laboratory Manager



2. TEST METHODOLOGY

All tests were performed in accordance with the standard CFR 47 FCC PART 15 SUBPART C(DSS)

3. FACILITIES AND ACCREDITATION

Accreditation Certificate	<p>A2LA (Certificate No.: 6947.01) Guangdong Global Testing Technology Co., Ltd. has been assessed and proved to be in compliance with A2LA.</p> <p>FCC (FCC Designation No.: CN1343) Guangdong Global Testing Technology Co., Ltd. has been recognized to perform compliance testing on equipment subject to Supplier's Declaration of Conformity (SDoC) and Certification rules</p> <p>ISED (Company No.: 30714) Guangdong Global Testing Technology Co., Ltd. has been registered and fully described in a report filed with ISED. The Company Number is 30714 and the test lab Conformity Assessment Body Identifier (CABID) is CN0148.</p>
---------------------------	--

Note: All tests measurement facilities use to collect the measurement data are located at Room 101-105, 203-210, Building 1, No.2, Keji 8 Road, Songshan Lake Park, Dongguan city, Guangdong, People's Republic of China, 523808

4. CALIBRATION AND UNCERTAINTY

4.1. MEASURING INSTRUMENT CALIBRATION

The measuring equipment utilized to perform the tests documented in this report has been calibrated in accordance with the manufacturer's recommendations and is traceable to recognized national standards.

4.2. MEASUREMENT UNCERTAINTY

Where relevant, the following measurement uncertainty levels have been estimated for tests performed on the apparatus:

Test Items	k	Uncertainty
DTS Bandwidth	1.96	±9.2 PPM
20dB Emission Bandwidth	1.96	±9.2 PPM
Carrier Frequency Separation	1.96	±9.2 PPM
Time of Occupancy	1.96	±0.57%
Conducted Output Power	1.96	±1.5 dB
Power Spectral Density Level	1.96	±1.9 dB
Conducted Spurious Emission	1.96	9 kHz-30 MHz: ± 0.95 dB 30 MHz-1 GHz: ± 1.5 dB 1GHz-12.75GHz: ± 1.8 dB 12.75 GHz-26.5 GHz: ± 2.1dB

Note: This uncertainty represents an expanded uncertainty expressed at approximately the 95% confidence level using a coverage factor of k=1.96.

Test Item	Measurement Frequency Range	K	U(dB)
Conducted emissions from the AC mains power ports (AMN)	150 kHz ~ 30 MHz	2	3.37
Radiated emissions	9 kHz ~ 30 MHz	2	4.16
Radiated emissions	30 MHz ~ 1 GHz	2	3.79
Radiated emissions	1 GHz ~ 18 GHz	2	5.62
Radiated emissions	18 GHz ~ 40 GHz	2	5.54

Note: This uncertainty represents an expanded uncertainty expressed at approximately the 95% confidence level using a coverage factor of k=2.

5. EQUIPMENT UNDER TEST

5.1. DESCRIPTION OF EUT

EUT Name		Portable Thermal Printer
Model		APA46Y
Series Model		A46, A46L, A46S, ITP05, ITP05S, A46H, A41, MP-8018, MP-8018T, LJA4A46A, A42, A42H, A43, A43H, TPA46H, A46YPRO, TPA46YH, A46PRO
Model Difference		Note: Only the model names are different.
Hardware Version		V1.0
Software Version		V1.0
Ratings		DC 5V = 2A
Power Supply	DC	5V
	Battery	DC 3.7V 1500mAh, 11.1Wh

Frequency Band:	2400 MHz to 2483.5 MHz
Frequency Range:	2402 MHz to 2480 MHz
Bluetooth Version:	Bluetooth V5.2
Bluetooth Mode:	Bluetooth BR
Modulation Technique:	Frequency Hopping Spread Spectrum(FHSS)
Type of Modulation:	GFSK
Number of Channels:	79
Channel Separation:	1 MHz
Maximum Peak Output Power:	-1.43 dBm
Antenna Type:	PCB Antenna
Antenna Gain:	2.58 dBi
Normal Test Voltage:	5 Vdc
EUT Test software:	fcc_test_tool
Note:	The Antenna Gain was provided by customer, and this information may affect the validity of the results, customer should be responsible for this.

5.2. CHANNEL LIST

Channel	Frequency (MHz)	Channel	Frequency (MHz)	Channel	Frequency (MHz)	Channel	Frequency (MHz)
00	2402	20	2422	40	2442	60	2462
01	2403	21	2423	41	2443	61	2463
02	2404	22	2424	42	2444	62	2464
03	2405	23	2425	43	2445	63	2465
04	2406	24	2426	44	2446	64	2466
05	2407	25	2427	45	2447	65	2467
06	2408	26	2428	46	2448	66	2468
07	2409	27	2429	47	2449	67	2469

08	2410	28	2430	48	2450	68	2470
09	2411	29	2431	49	2451	69	2471
10	2412	30	2432	50	2452	70	2472
11	2413	31	2433	51	2453	71	2473
12	2414	32	2434	52	2454	72	2474
13	2415	33	2435	53	2455	73	2475
14	2416	34	2436	54	2456	74	2476
15	2417	35	2437	55	2457	75	2477
16	2418	36	2438	56	2458	76	2478
17	2419	37	2439	57	2459	77	2479
18	2420	38	2440	58	2460	78	2480
19	2421	39	2441	59	2461	/	/

5.3. MAXIMUM PEAK OUTPUT POWER

Test Mode	Frequency (MHz)	Channel Number	Maximum Peak Output Power (dBm)	Maximum EIRP (dBm)
GFSK	2402 ~ 2480	0-78[79]	-1.43	/

5.4. TEST CHANNEL CONFIGURATION

Test Mode	Test Channel	Frequency
GFSK	CH 0(Low Channel), CH 39(MID Channel), CH 78(High Channel)	2402 MHz, 2441 MHz, 2480 MHz

Note: The hop is hopping mode.

PACKET TYPE CONFIGURATION

Test Mode	Packet Type	Setting (Packet Length)
GFSK	DH1	27
	DH3	183
	DH5	339

5.5. THE WORSE CASE POWER SETTING PARAMETER

WORST-CASE CONFIGURATIONS

Bluetooth Mode	Modulation Technology	Modulation Type	Data Rate (Mbps)
BR	FHSS	GFSK	1Mbit/s

Note: Pre-Scan has been conducted to determine the worst-case mode from all possible combinations between available modulations, data rates.

The Worst Case Power Setting Parameter under 2400 ~ 2483.5MHz Band				
Test Software		fcc_test_tool		
Modulation Type	Transmit Antenna Number	Test Software setting value		
		CH 00	CH 39	CH 78

GFSK	1	default	default	default
------	---	---------	---------	---------

5.6. DESCRIPTION OF AVAILABLE ANTENNAS

Antenna	Frequency (MHz)	Antenna Type	MAX Antenna Gain (dBi)
1	2402-2480	PCB	2.58

Test Mode	Transmit and Receive Mode	Description
GFSK	<input checked="" type="checkbox"/> 1TX, 1RX	Antenna 1 can be used as transmitting/receiving antenna.
Note:		

5.7. SUPPORT UNITS FOR SYSTEM TEST

The following support units or accessories were used to form a representative test configuration during the tests.

Item	Equipment	Mfr/Brand	Model/Type No.	Series No.	Note
E-1	Laptop	Lenovo	Thinkpad T14	PF-3EAKYR	GTG Support
E-2	Adapter	Xiaomi	MDY-11-EX	N/A	GTG Support
E-3	Serial Port Tool	N/A	N/A	N/A	GTG Support

The following cables were used to form a representative test configuration during the tests.

Item	Type of cable	Shielded Type	Ferrite Core	Length
C-1	USB cable	Unshielded	without ferrite	1.0 m
C-2	Dupont cable	Unshielded	without ferrite	0.6 m

5.8. SETUP DIAGRAM

Radiated emissions:

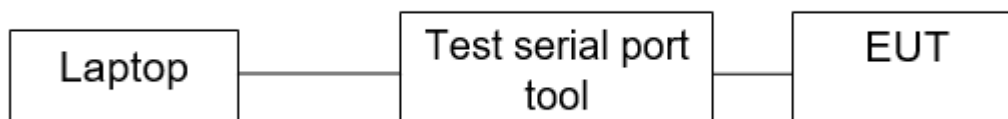

AC Power Line Conducted Emission:

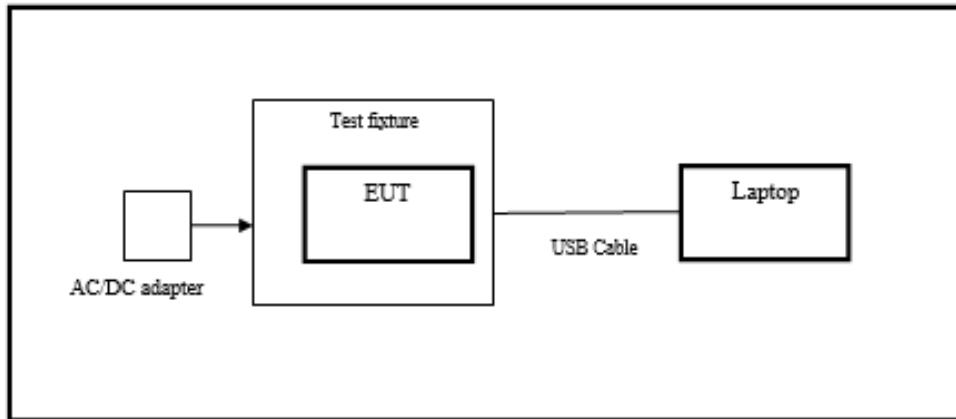

6. MEASURING EQUIPMENT AND SOFTWARE USED

Test Equipment of Conducted RF					
Equipment	Manufacturer	Model No.	Serial No.	Last Cal.	Due Date
Spectrum Analyzer	Rohde & Schwarz	FSV40	102257	2024/09/14	2025/09/13
Spectrum Analyzer	KEYSIGHT	N9020A	MY51285127	2024/09/14	2025/09/13
EXG Analog Signal Generator	KEYSIGHT	N5173B	MY61253075	2024/09/14	2025/09/13
Vector Signal Generator	Rohde & Schwarz	SMM100A	101899	2024/09/14	2025/09/13
RF Control box	MWRF-test	MW100-RFCB	MW220926GTG	2024/09/14	2025/09/13
Wideband Radio Communication Tester	Rohde & Schwarz	CMW270	102792	2024/09/14	2025/09/13
Wideband Radio Communication Tester	Rohde & Schwarz	CMW500	103235	2024/09/14	2025/09/13
temperature humidity chamber	Espec	SH-241	SH-241-2014	2024/09/14	2025/09/13
RF Test Software	MWRF-test	MTS8310E (Ver. V2/0)	N/A	N/A	N/A

Test Equipment of Radiated emissions below 1GHz					
Equipment	Manufacturer	Model No.	Serial No.	Last Cal.	Due Date
3m Semi-anechoic Chamber	ETS	9m*6m*6m	Q2146	2022/08/30	2025/08/29
EMI Test Receiver	Rohde & Schwarz	ESCI3	101409	2024/09/14	2025/09/13
Spectrum Analyzer	KEYSIGHT	N9020A	MY51283932	2024/09/14	2025/09/13
Pre-Amplifier	HZEMC	HPA-9K0130	HYP A21001	2024/09/14	2025/09/13
Biconilog Antenna	Schwarzbeck	VULB 9168	01315	2022/10/10	2025/10/09
Biconilog Antenna	ETS	3142E	00243646	2022/03/23	2025/03/22
Loop Antenna	ETS	6502	243668	2022/03/30	2025/03/29
Test Software	Farad	EZ-EMC (Ver.FA-03A2 RE)	N/A	N/A	N/A

Test Equipment of Radiated emissions above 1GHz					
Equipment	Manufacturer	Model No.	Serial No.	Last Cal.	Due Date
3m Semi-anechoic Chamber	ETS	9m*6m*6m	Q2149	2022/08/30	2025/08/29
Spectrum Analyzer	Rohde & Schwarz	FSV40	101413	2024/09/14	2025/09/13
Spectrum Analyzer	KEYSIGHT	N9020A	MY51283932	2024/09/14	2025/09/13
Pre-Amplifier	A-INFO	HPA-1G1850	HYP A21003	2024/09/14	2025/09/13
Horn antenna	A-INFO	3117	246069	2022/03/11	2025/03/10
Pre-Amplifier	ZKJC	HPA-184057	HYP A21004	2024/09/14	2025/09/13

Horn antenna	ZKJC	3116C	246265	2022/03/29	2025/03/28
Test Software	Farad	EZ-EMC (Ver.FA-03A2 RE+)	N/A	N/A	N/A

Test Equipment of Conducted emissions					
Equipment	Manufacturer	Model No.	Serial No.	Last Cal.	Due Date
Shielded Room	CHENG YU	8m*5m*4m	N/A	2022/10/29	2025/10/28
EMI Test Receiver	Rohde & Schwarz	ESR3	102647	2024/09/14	2025/09/13
LISN/AMN	Rohde & Schwarz	ENV216	102843	2024/09/14	2025/09/13
NNLK 8129 RC	Schwarzbeck	NNLK 8129 RC	5046	2024/09/14	2025/09/13
Test Software	Farad	EZ-EMC (Ver. EMC-con-3A1 1+)	N/A	N/A	N/A

7. ANTENNA PORT TEST RESULTS

7.1. CONDUCTED OUTPUT POWER

LIMITS

CFR 47 FCC Part15 (15.247) Subpart C ISED RSS-247 ISSUE 3			
Section	Test Item	Limit	Frequency Range (MHz)
CFR 47 FCC 15.247(b)(3) ISED RSS-247 5.4 (d)	Peak Conduct Output Power	1 watt or 30 dBm	2400-2483.5

TEST PROCEDURE

Connect the EUT to a low loss RF cable from the antenna port to the power sensor (video bandwidth is greater than the occupied bandwidth).

Measure peak emission level, the indicated level is the peak output power, after any corrections for external attenuators and cables.

TEST SETUP

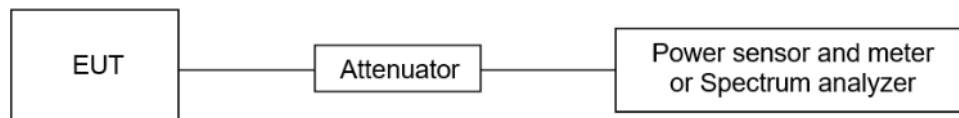

TEST ENVIRONMENT

Temperature	22.2°C	Relative Humidity	51%
Atmosphere Pressure	101kPa		

TEST RESULTS

Please refer to section "Test Data" - Appendix A

7.2. 20 DB BANDWIDTH AND 99% OCCUPIED BANDWIDTH

LIMITS

CFR 47FCC Part15 (15.247) Subpart C			
Section	Test Item	Limit	Frequency Range (MHz)
CFR 47 FCC 15.247 (a) (1)	20 dB Bandwidth	None; for reporting purposes only.	2400-2483.5

TEST PROCEDURE

Refer to ANSI C63.10-2013 clause 6.9.2.

Connect the EUT to the spectrum analyser and use the following settings:

Center Frequency	The center frequency of the channel under test
Detector	Peak
RBW	For 20 dB Bandwidth: 1 % to 5 % of the 20 dB bandwidth For 99 % Occupied Bandwidth: 1 % to 5 % of the occupied bandwidth
VBW	For 20 dB Bandwidth: approximately 3×RBW For 99 % Occupied Bandwidth: ≥ 3×RBW
Span	Approximately 2 to 3 times the 20dB bandwidth
Trace	Max hold
Sweep	Auto couple

a) Use the occupied bandwidth function of the instrument, allow the trace to stabilize and report the measured 99 % occupied bandwidth and 20 dB Bandwidth.

TEST SETUP

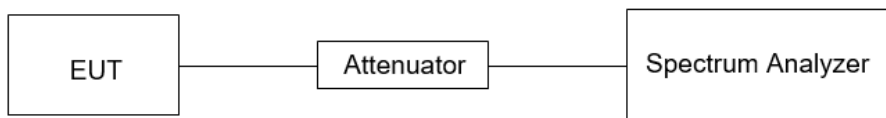

TEST ENVIRONMENT

Temperature	22.2°C	Relative Humidity	51%
Atmosphere Pressure	101kPa		

TEST RESULTS

Please refer to section "Test Data" - Appendix A

7.3. CARRIER HOPPING CHANNEL SEPARATION

LIMITS

CFR 47 FCC Part15 (15.247),			
Section	Test Item	Limit	Frequency Range (MHz)
CFR 47 FCC 15.247 (a) (1)	Carrier Frequency Separation	Frequency hopping systems shall have hopping channel carrier frequencies separated by a minimum of 25 kHz or the 20 dB bandwidth of the hopping channel, whichever is greater. Alternatively, frequency hopping systems operating in the 2400-2483.5 MHz band may have hopping channel carrier frequencies that are separated by 25 kHz or two-thirds of the 20 dB bandwidth of the hopping channel.	2400-2483.5

TEST PROCEDURE

Refer to ANSI C63.10-2013 clause 7.8.2.

Connect the EUT to the spectrum analyzer and use the following settings:

Center Frequency	The center frequency of the channel under test
Span	wide enough to capture the peaks of two adjacent channels
Detector	Peak
RBW	Start with the RBW set to approximately 30 % of the channel spacing; adjust as necessary to best identify the center of each individual channel.
VBW	≥RBW
Trace	Max hold
Sweep time	Auto couple

Allow the trace to stabilize and use the marker-delta function to determine the separation between the peaks of the adjacent channels.

Compliance of an EUT with the appropriate regulatory limit shall be determined.

TEST SETUP

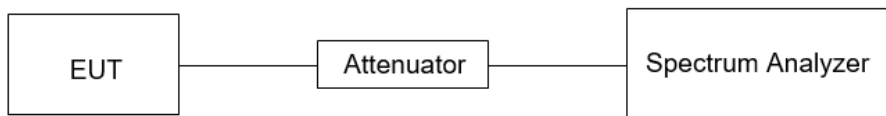

TEST ENVIRONMENT

Temperature	22.2°C	Relative Humidity	51%
Atmosphere Pressure	101kPa		

TEST RESULTS

Please refer to section "Test Data" - Appendix A

7.4. NUMBER OF HOPPING FREQUENCY

LIMITS

CFR 47 FCC Part15 (15.247), Subpart C		
Section	Test Item	Limit
CFR 47 15.247 (a) (1) III	Number of Hopping Frequency	at least 15 hopping channels

TEST PROCEDURE

Refer to ANSI C63.10-2013 clause 7.8.3.

Connect the EUT to the spectrum Analyzer and use the following settings:

Detector	Peak
RBW	To identify clearly the individual channels, set the RBW to less than 30% of the channel spacing or the 20 dB bandwidth, whichever is smaller.
VBW	≥RBW
Span	The frequency band of operation. Depending on the number of channels the device supports, it may be necessary to divide the frequency range of operation across multiple spans, to allow the individual channels to be clearly seen.
Trace	Max hold
Sweep time	Auto couple

Set EUT to transmit maximum output power and switch on frequency hopping function. then set enough count time (larger than 5000 times) to get all the hopping frequency channel displayed on the screen of spectrum analyzer, count the quantity of peaks to get the number of hopping channels.

TEST SETUP

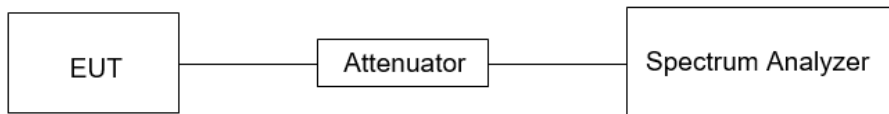

TEST ENVIRONMENT

Temperature	22.2°C	Relative Humidity	51%
Atmosphere Pressure	101kPa		

TEST RESULTS

Please refer to section "Test Data" - Appendix A

7.5. TIME OF OCCUPANCY (DWELL TIME)

LIMITS

CFR 47 FCC Part15 (15.247), Subpart C		
Section	Test Item	Limit
CFR 47 15.247 (a) (1) III	Time of Occupancy (Dwell Time)	The average time of occupancy on any channel shall not be greater than 0.4 seconds within a period of 0.4 seconds, multiplied by the number of hopping channels employed.

TEST PROCEDURE

Refer to ANSI C63.10-2013 clause 7.8.4.

Connect the EUT to the spectrum Analyzer and use the following settings:

Center Frequency	The center frequency of the channel under test
Detector	Peak
RBW	1 MHz
VBW	≥RBW
Span	Zero span, centered on a hopping channel
Trace	Max hold
Sweep time	As necessary to capture the entire dwell time per hopping channel; where possible use a video trigger and trigger delay so that the transmitted signal starts a little to the right of the start of the plot. The trigger level might need slight adjustment to prevent triggering when the system hops on an adjacent channel

Use the marker-delta function to determine the transmit time per hop (Burst Width). If this value varies with different modes of operation (data rate, modulation format, number of hopping channels, etc.), then repeat this test for each variation in transmit time.

For FHSS Mode (79 Channel):

DH1/3DH1 Dwell Time: $\text{Burst Width} * (1600/2) * 31.6 / (\text{channel number})$

DH3/3DH3 Dwell Time: $\text{Burst Width} * (1600/4) * 31.6 / (\text{channel number})$

DH5/3DH5 Dwell Time: $\text{Burst Width} * (1600/6) * 31.6 / (\text{channel number})$

For AFHSS Mode (20 Channel):

DH1/3DH1 Dwell Time: $\text{Burst Width} * (1600/2) * 8 / (\text{channel number})$

DH3/3DH3 Dwell Time: $\text{Burst Width} * (1600/4) * 8 / (\text{channel number})$

DH5/3DH5 Dwell Time: $\text{Burst Width} * (1600/6) * 8 / (\text{channel number})$

TEST SETUP

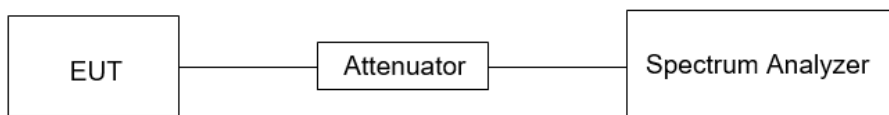

TEST ENVIRONMENT

Temperature	22.2°C	Relative Humidity	51%
Atmosphere Pressure	101kPa		

TEST RESULTS

Please refer to section "Test Data" - Appendix A

7.6. CONDUCTED BANDEDGE AND SPURIOUS EMISSION

LIMITS

CFR 47 FCC Part15 (15.247), Subpart C		
Section	Test Item	Limit
CFR 47 FCC §15.247 (d)	Conducted Spurious Emission	at least 20 dB below that in the 100 kHz bandwidth within the band that contains the highest level of the desired power

TEST PROCEDURE

Refer to ANSI C63.10-2013 clause 7.8.6 and 7.8.8.

Connect the EUT to the spectrum analyser and use the following settings for reference level measurement:

Center Frequency	The center frequency of the channel under test
Detector	Peak
RBW	100 kHz
VBW	$\geq 3 \times \text{RBW}$
Span	1.5 x DTS bandwidth
Trace	Max hold
Sweep time	Auto couple.

Allow trace to fully stabilize and use the peak marker function to determine the maximum PSD level.

Change the settings for emission level measurement:

Span	Set the center frequency and span to encompass frequency range to be measured
Detector	Peak
RBW	100 kHz
VBW	$\geq 3 \times \text{RBW}$
measurement points	$\geq \text{span}/\text{RBW}$
Trace	Max hold
Sweep time	Auto couple.

Allow trace to fully stabilize and use the peak marker function to determine the maximum PSD level. Ensure that the amplitude of all unwanted emissions outside of the authorized frequency band (excluding restricted frequency bands) is attenuated by at least the minimum

TEST SETUP

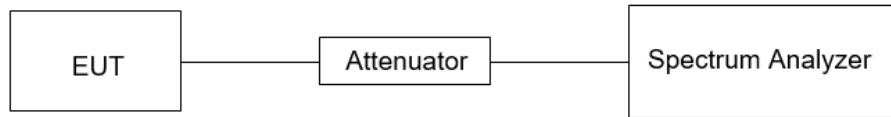

TEST ENVIRONMENT

Temperature	22.2°C	Relative Humidity	51%
Atmosphere Pressure	101kPa		

TEST RESULTS

Please refer to section "Test Data" - Appendix A

7.7. DUTY CYCLE

LIMITS

None; for reporting purposes only.

TEST PROCEDURE

Refer to ANSI C63.10-2013 Zero – Span Spectrum Analyzer method.

TEST SETUP

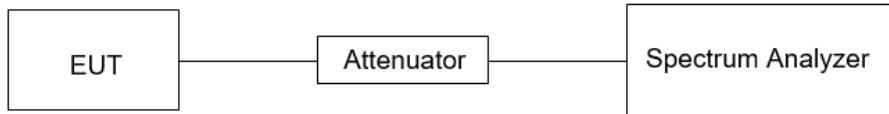

TEST ENVIRONMENT

Temperature	22.2°C	Relative Humidity	51%
Atmosphere Pressure	101kPa		

TEST RESULTS

Please refer to section "Test Data" - Appendix A

8. RADIATED TEST RESULTS

LIMITS

Please refer to CFR 47 FCC §15.205 and §15.209.

Radiation Disturbance Test Limit for FCC (Class B) (9 kHz-1 GHz)

Emissions radiated outside of the specified frequency bands above 30 MHz			
Frequency Range (MHz)	Field Strength Limit (uV/m) at 3 m	Field Strength Limit (dBuV/m) at 3 m	
		Quasi-Peak	
30 - 88	100	40	
88 - 216	150	43.5	
216 - 960	200	46	
Above 960	500	54	
Above 1000	500	Peak	Average
		74	54

FCC Emissions radiated outside of the specified frequency bands below 30 MHz		
Frequency (MHz)	Field strength (microvolts/meter)	Measurement distance (meters)
0.009-0.490	2400/F(kHz)	300
0.490-1.705	24000/F(kHz)	30
1.705-30.0	30	30

FCC Restricted bands of operation refer to FCC §15.205 (a):

MHz	MHz	MHz	GHz
0.090-0.110	16.42-16.423	399.9-410	4.5-5.15
¹ 0.495-0.505	16.69475-16.69525	608-614	5.35-5.46
2.1735-2.1905	16.80425-16.80475	960-1240	7.25-7.75
4.125-4.128	25.5-25.67	1300-1427	8.025-8.5
4.17725-4.17775	37.5-38.25	1435-1626.5	9.0-9.2
4.20725-4.20775	73-74.6	1645.5-1646.5	9.3-9.5
6.215-6.218	74.8-75.2	1660-1710	10.6-12.7
6.26775-6.26825	108-121.94	1718.8-1722.2	13.25-13.4
6.31175-6.31225	123-138	2200-2300	14.47-14.5
8.291-8.294	149.9-150.05	2310-2390	15.35-16.2
8.362-8.366	156.52475-156.52525	2483.5-2500	17.7-21.4
8.37625-8.38675	156.7-156.9	2690-2900	22.01-23.12
8.41425-8.41475	162.0125-167.17	3260-3267	23.6-24.0
12.29-12.293	167.72-173.2	3332-3339	31.2-31.8
12.51975-12.52025	240-285	3345.8-3358	36.43-36.5
12.57675-12.57725	322-335.4	3600-4400	(²)
13.36-13.41			

Note: ¹Until February 1, 1999, this restricted band shall be 0.490-0.510 MHz.

²Above 38.6c

TEST PROCEDURE

Below 30 MHz

The setting of the spectrum analyser

RBW	200 Hz (From 9 kHz to 0.15 MHz)/ 9 kHz (From 0.15 MHz to 30 MHz)
VBW	200 Hz (From 9 kHz to 0.15 MHz)/ 9 kHz (From 0.15 MHz to 30 MHz)
Sweep	Auto

1. The testing follows the guidelines in ANSI C63.10-2013 clause 6.4.
2. The EUT was arranged to its worst case and then turntable (from 0 degree to 360 degrees) to find the maximum reading. A pre-amp and a high pass filter are used for the test in order to get better signal level. Both Horizontal, Face-on and Face-off polarizations of the antenna are set to make the measurement.
3. The EUT was placed on a turntable with 80 cm above ground.
4. The EUT was set 3 meters from the interference receiving antenna, which was mounted on the top of a 1 m height antenna tower.
5. The radiated emission limits are based on measurements employing a CISPR quasi-peak detector except for the frequency bands 9-90 kHz, 110-490 kHz and above 1000 MHz Radiated emission limits in these three bands are based on measurements employing an average detector.
6. For measurement below 1 GHz, the initial step in collecting conducted emission data is a spectrum analyzer peak detector mode pre-scanning the measurement frequency range. Significant peaks are then marked and then Quasi Peak and average detector mode re-measured. If the emission level of the EUT measured by the peak detector is 3 dB lower than the applicable limit, the peak emission level will be reported. Otherwise, the emission measurement will be repeated using the quasi-peak and average detector and reported.
7. Although these tests were performed other than open field site, adequate comparison measurements were confirmed against 30m open field site. Therefore sufficient tests were made to demonstrate that the alternative site produces results that correlate with the ones of tests made in an open field site based on KDB 414788.
8. The limits in CFR 47, Part 15, Subpart C, paragraph 15.209 (a), are identical to those in RSS-GEN Section 8.9, Table 6, since the measurements are performed in terms of magnetic field strength and converted to electric field strength levels (as reported in the table) using the free space impedance of 377Ω . For example, the measurement frequency X KHz resulted in a level of Y dBuV/m, which is equivalent to $Y-51.5 = Z$ dBuA/m, which has the same margin, W dB, to the corresponding RSS-GEN Table 6 limit as it has to be 15.209(a) limit.

Below 1 GHz and above 30 MHz

The setting of the spectrum analyser

RBW	120 kHz
VBW	300 kHz
Sweep	Auto
Detector	Peak/QP
Trace	Max hold

1. The testing follows the guidelines in ANSI C63.10-2013 clause 6.5.
2. The EUT was arranged to its worst case and then tune the antenna tower (from 1 m to 4 m) and turntable (from 0 degree to 360 degrees) to find the maximum reading. A pre-amp and a high pass filter are used for the test in order to get better signal level. Both horizontal and vertical polarizations of the antenna are set to make the measurement.
3. The EUT was placed on a turntable with 80 cm above ground.
4. The EUT was set 3 meters from the interference receiving antenna, which was mounted on the top of a variable height antenna tower.
5. For measurement below 1 GHz, the initial step in collecting conducted emission data is a spectrum analyzer peak detector mode pre-scanning the measurement frequency range. Significant peaks are then marked and then Quasi Peak detector mode re-measured. If the emission level of the EUT measured by the peak detector is 3 dB lower than the applicable limit, the peak emission level will be reported. Otherwise, the emission measurement will be repeated using the quasi-peak detector and reported.

Above 1 GHz

The setting of the spectrum analyser

RBW	1 MHz
VBW	PEAK: 3 MHz AVG: see note 6
Sweep	Auto
Detector	Peak
Trace	Max hold

1. The testing follows the guidelines in ANSI C63.10-2013 clause 6.6.
2. The EUT was arranged to its worst case and then tune the antenna tower (from 1 m to 4 m) and turntable (from 0 degree to 360 degrees) to find the maximum reading. A pre-amp and a high pass filter are used for the test in order to get better signal level. Both horizontal and vertical polarizations of the antenna are set to make the measurement.
3. The EUT was placed on a turntable with 1.5 m above ground.
4. The EUT was set 3 meters from the interference receiving antenna, which was mounted on the top of a variable height antenna tower.
5. For measurement above 1 GHz, the emission measurement will be measured by the peak detector. This peak level, once corrected, must comply with the limit specified in Section 15.209.
6. For measurements above 1 GHz the resolution bandwidth is set to 1 MHz, then the video bandwidth is set to 3 MHz for peak measurements and 1 MHz resolution bandwidth with 1/T video bandwidth with peak detector for average measurements. For the Duty Cycle please refer to clause 7.1.ON TIME AND DUTY CYCLE.

X axis, Y axis, Z axis positions:

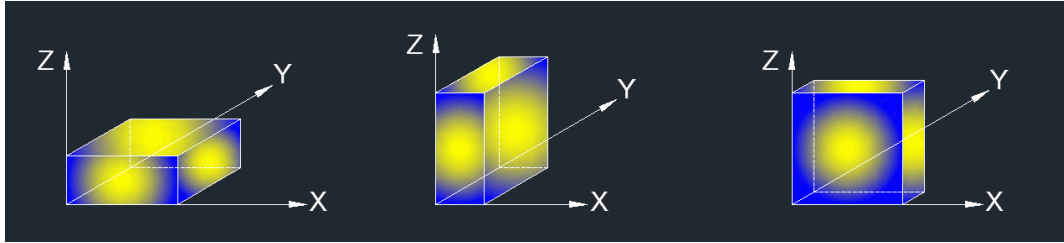

Note 1: For all radiated test, EUT in each of three orthogonal axis emissions had been tested, but only the worst case (X axis) data recorded in the report.

Note 2: The EUT was fully exercised with external accessories during the test. In the case of multiple accessory external ports, an external accessory shall be connected to one of each type of port.

TEST SETUP

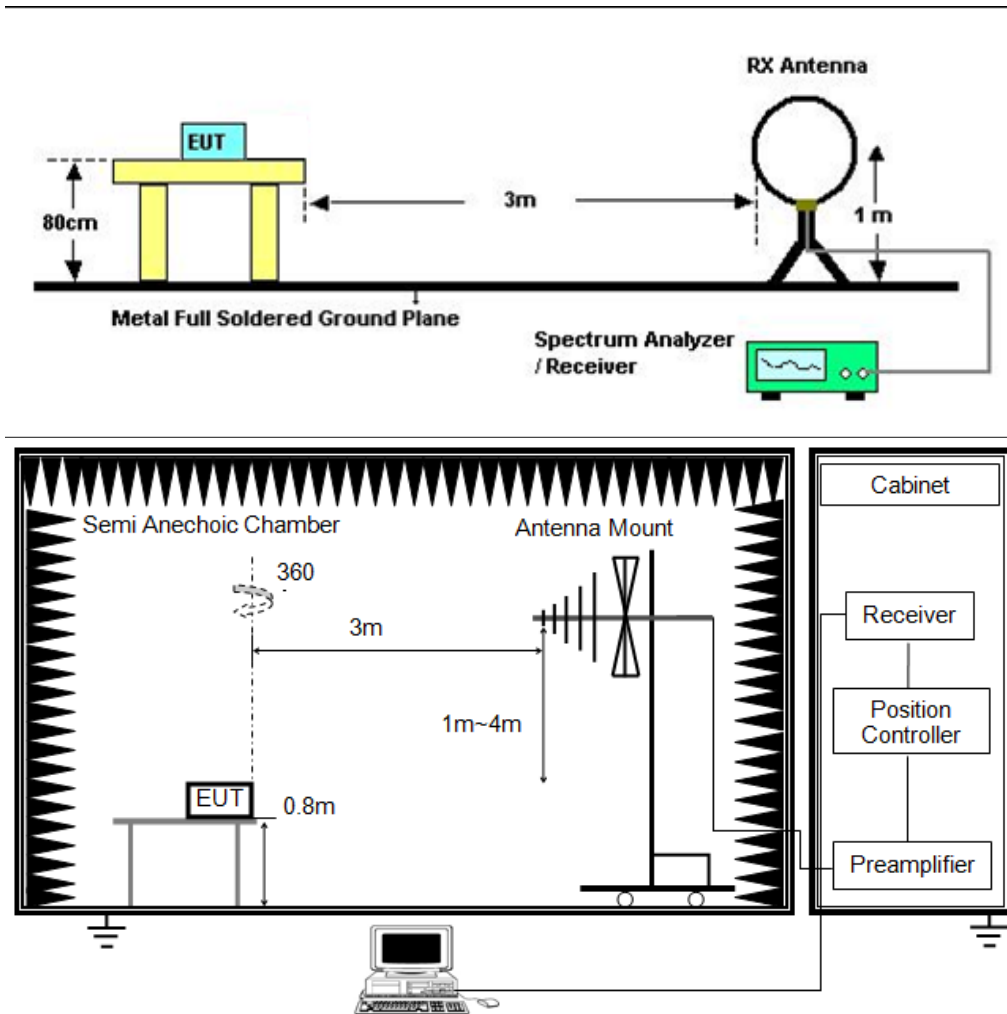

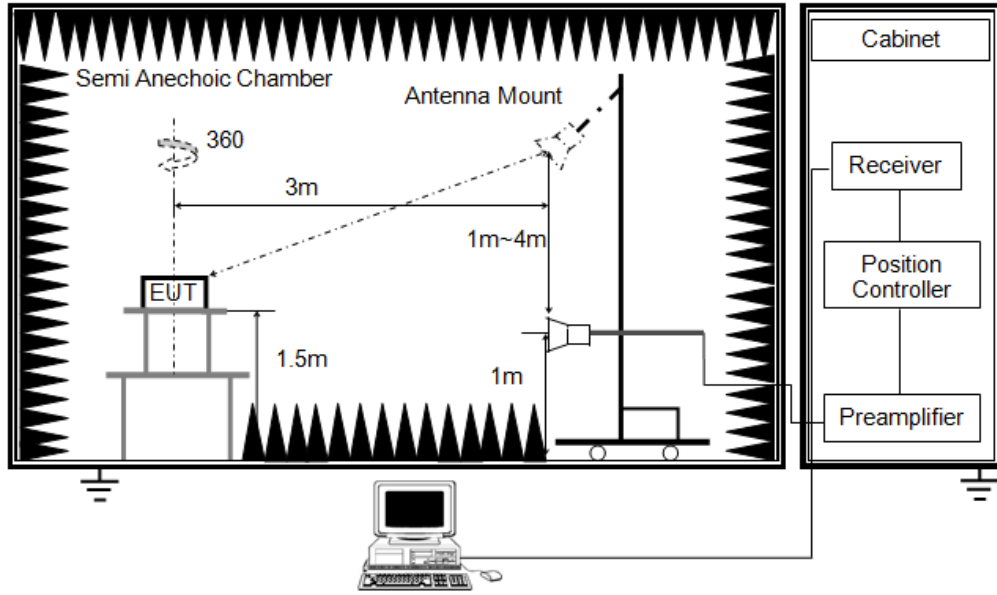

TEST ENVIRONMENT

Temperature	24.9°C, 22.1°C	Relative Humidity	53%, 51%
Atmosphere Pressure	101kPa		

TEST RESULTS

8.1. RADIATED BAND EDGE AND SPURIOUS EMISSION

Undesirable radiated Spurious Emission below 1GHz (30MHz to 1GHz)

All modes have been tested and the worst result as bellow:

Mode:	1-DH5-2402
Power:	DC 5V
TE:	Berny
Date	2025/01/21
T/A/P	24.9°C/53%/101Kpa

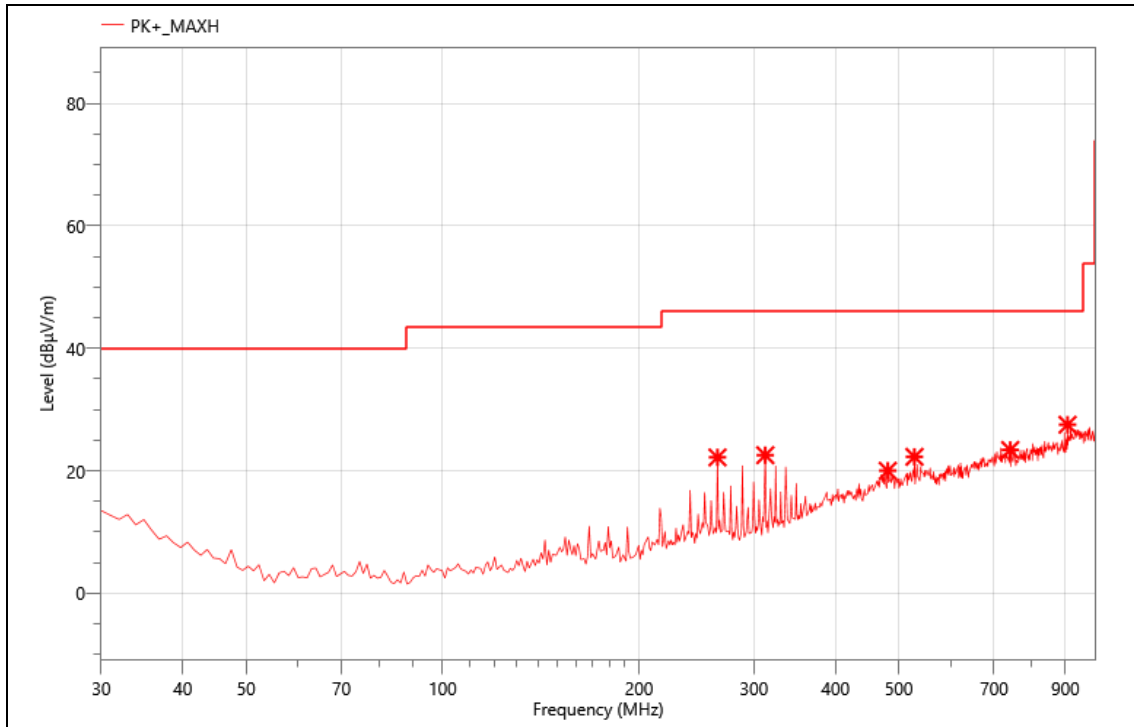

Critical_Freqs

No.	Freq. (MHz)	Reading (dBµV)	Corr. (dB)	Meas. (dBµV/m)	Limit (dBµV/m)	Margin (dB)	Det.	Pol.
1	263.770	40.34	-18.14	22.20	46.00	23.80	PK+	H
2	312.270	40.61	-18.05	22.56	46.00	23.44	PK+	H
3	481.050	32.64	-12.62	20.02	46.00	25.98	PK+	H
4	528.580	32.81	-10.51	22.30	46.00	23.70	PK+	H
5	741.010	29.95	-6.54	23.41	46.00	22.59	PK+	H
6	906.880	31.44	-3.91	27.53	46.00	18.47	PK+	H

Mode:	1-DH5-2402
Power:	DC 5V
TE:	Berny
Date	2025/01/21
T/A/P	24.9°C/53%/101Kpa

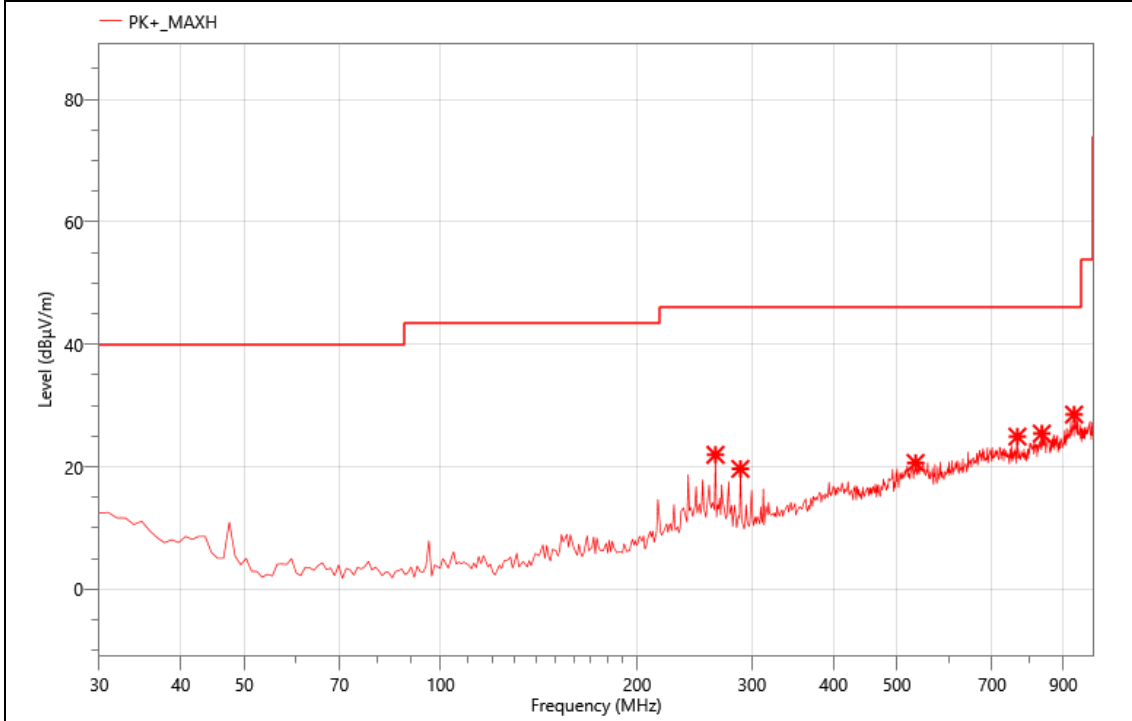

Critical_Freqs

No.	Freq. (MHz)	Reading (dBµV)	Corr. (dB)	Meas. (dBµV/m)	Limit (dBµV/m)	Margin (dB)	Det.	Pol.
1	263.770	40.11	-18.14	21.97	46.00	24.03	PK+	V
2	288.020	39.08	-19.4	19.68	46.00	26.32	PK+	V
3	534.400	30.91	-10.26	20.65	46.00	25.35	PK+	V
4	765.260	31.68	-6.74	24.94	46.00	21.06	PK+	V
5	834.130	30.69	-5.25	25.44	46.00	20.56	PK+	V
6	935.010	30.70	-2.16	28.54	46.00	17.46	PK+	V

Undesirable radiated Spurious Emission Above 1GHz (1GHz to 40GHz)

All modes have been tested and the worst result as bellow:

Mode:	1-DH5-2402
Power:	DC 5V
TE:	Big
Date	2025/02/13
T/A/P	22.1°C/51%/101Kpa

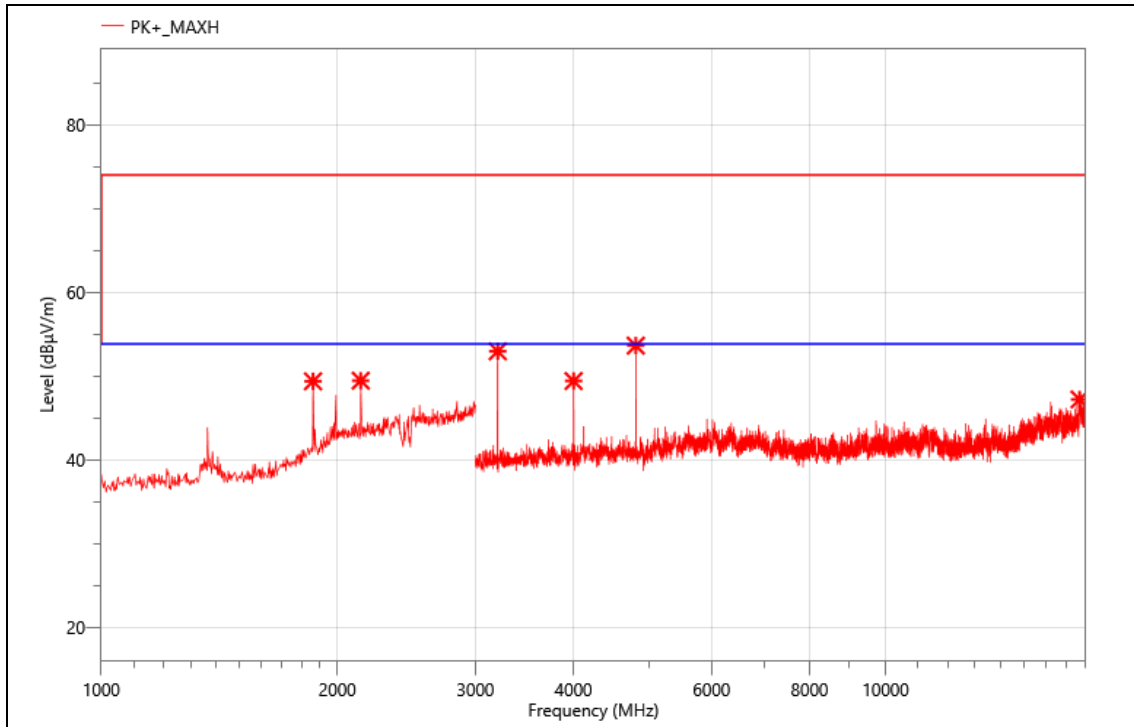

Critical_Freqs

No.	Freq. (MHz)	Reading (dBµV)	Corr. (dB)	Meas. (dBµV/m)	Limit (dBµV/m)	Margin (dB)	Det.	Pol.
1	1862.000	59.81	-10.41	49.40	74.00	24.60	PK+	H
2	2142.000	58.52	-9.05	49.47	74.00	24.53	PK+	H
3	3202.500	67.76	-14.79	52.97	74.00	21.03	PK+	H
4	4002.000	62.79	-13.36	49.43	74.00	24.57	PK+	H
5	4803.000	64.99	-11.34	53.65	74.00	20.35	PK+	H
6	17674.500	46.91	0.32	47.23	74.00	26.77	PK+	H

Mode:	1-DH5-2402
Power:	DC 5V
TE:	Big
Date	2025/02/13
T/A/P	22.1°C/51%/101Kpa

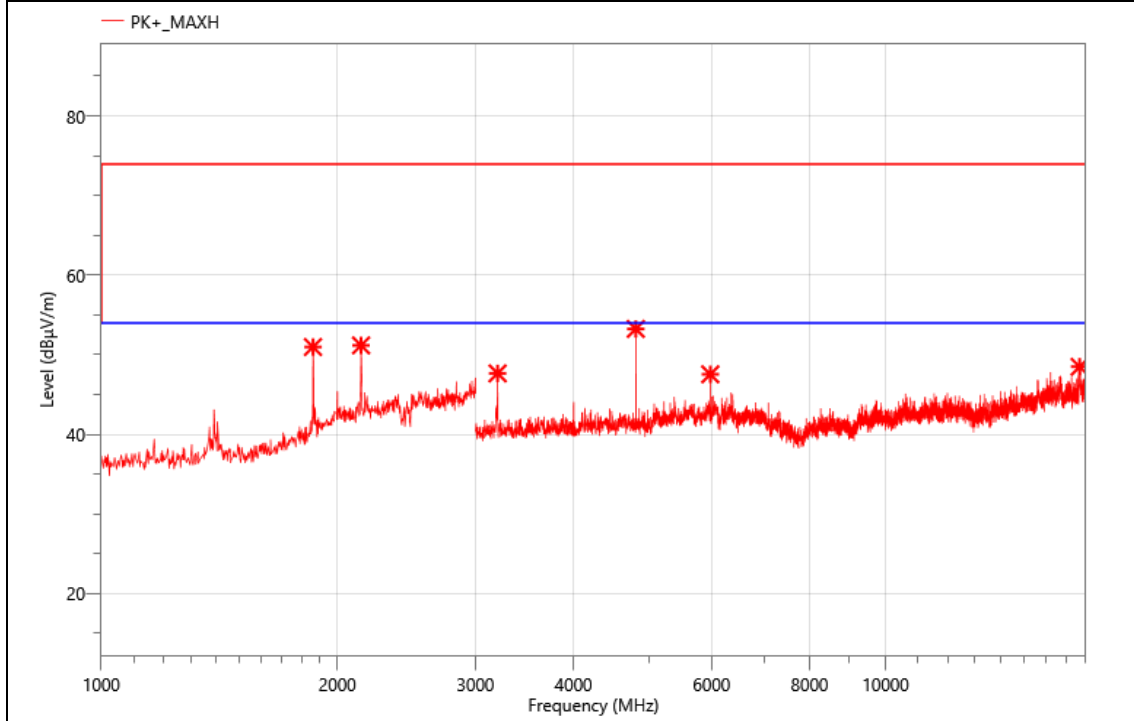

Critical_Freqs

No.	Freq. (MHz)	Reading (dBµV)	Corr. (dB)	Meas. (dBµV/m)	Limit (dBµV/m)	Margin (dB)	Det.	Pol.
1	1862.000	61.39	-	50.98	74.00	23.02	PK+	V
2	2144.000	60.23	-9.05	51.18	74.00	22.82	PK+	V
3	3201.000	62.46	-14.8	47.66	74.00	26.34	PK+	V
4	4803.000	64.59	-	53.25	74.00	20.75	PK+	V
5	5977.500	56.50	-8.95	47.55	74.00	26.45	PK+	V
6	17679.000	48.20	0.29	48.49	74.00	25.51	PK+	V

Mode:	1-DH5-2441
Power:	DC 5V
TE:	Big
Date	2025/02/13
T/A/P	22.1°C/51%/101Kpa

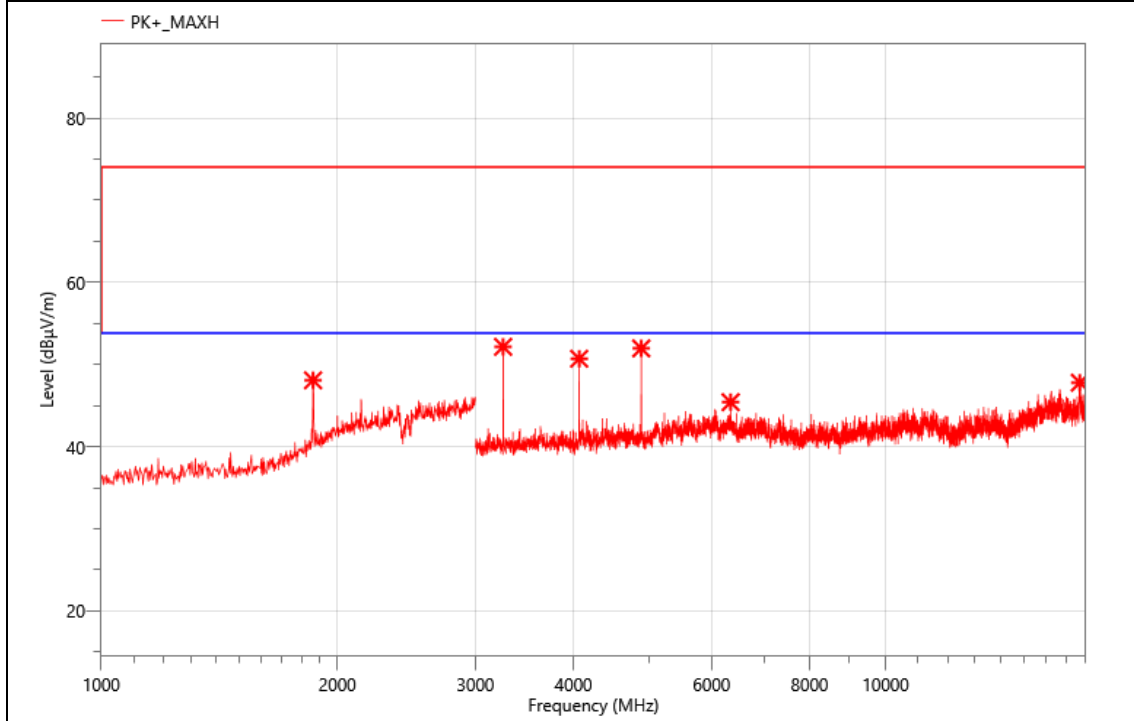

Critical_Freqs

No.	Freq. (MHz)	Reading (dBµV)	Corr. (dB)	Meas. (dBµV/m)	Limit (dBµV/m)	Margin (dB)	Det.	Pol.
1	1862.000	58.49	-10.41	48.08	74.00	25.92	PK+	H
2	3253.500	66.92	-14.76	52.16	74.00	21.84	PK+	H
3	4068.000	63.57	-12.86	50.71	74.00	23.29	PK+	H
4	4881.000	63.11	-11.14	51.97	74.00	22.03	PK+	H
5	6345.000	53.40	-7.98	45.42	74.00	28.58	PK+	H
6	17689.500	47.55	0.24	47.79	74.00	26.21	PK+	H

Mode:	1-DH5-2441
Power:	DC 5V
TE:	Big
Date	2025/02/13
T/A/P	22.1°C/51%/101Kpa

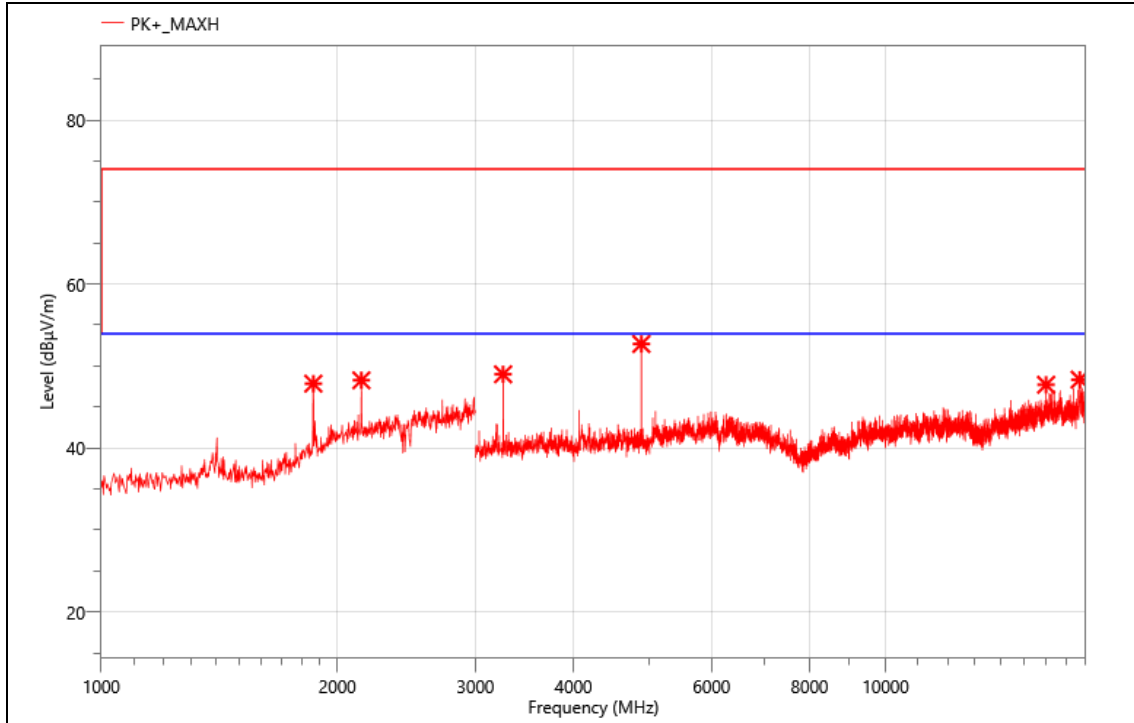

Critical_Freqs

No.	Freq. (MHz)	Reading (dBµV)	Corr. (dB)	Meas. (dBµV/m)	Limit (dBµV/m)	Margin (dB)	Det.	Pol.
1	1864.000	58.25	-10.4	47.85	74.00	26.15	PK+	V
2	2146.000	57.31	-9.05	48.26	74.00	25.74	PK+	V
3	3253.500	63.75	-14.76	48.99	74.00	25.01	PK+	V
4	4882.500	63.84	-11.15	52.69	74.00	21.31	PK+	V
5	16020.000	49.78	-2.07	47.71	74.00	26.29	PK+	V
6	17682.000	48.06	0.28	48.34	74.00	25.66	PK+	V

Mode:	1-DH5-2480
Power:	DC 5V
TE:	Big
Date	2025/02/13
T/A/P	22.1°C/51%/101Kpa

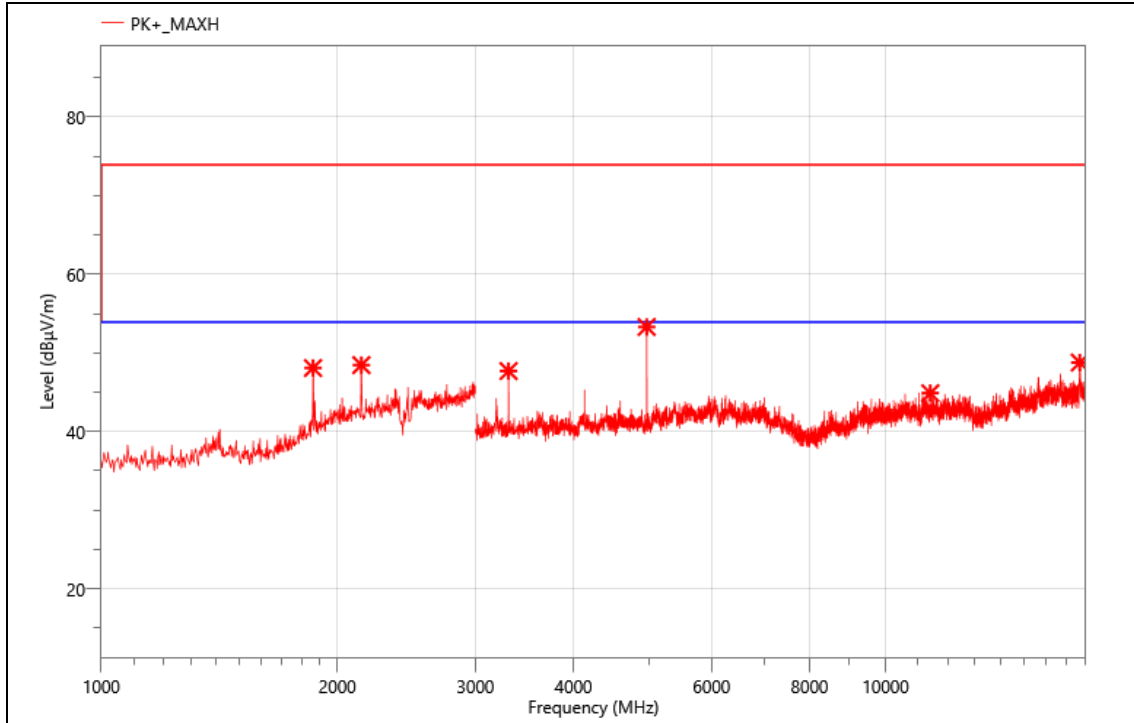

Critical_Freqs

No.	Freq. (MHz)	Reading (dBµV)	Corr. (dB)	Meas. (dBµV/m)	Limit (dBµV/m)	Margin (dB)	Det.	Pol.
1	1862.000	58.49	-10.41	48.08	74.00	25.92	PK+	V
2	2146.000	57.50	-9.05	48.45	74.00	25.55	PK+	V
3	3306.000	62.09	-14.4	47.69	74.00	26.31	PK+	V
4	4959.000	64.65	-11.35	53.30	74.00	20.70	PK+	V
5	11404.500	49.26	-4.38	44.88	74.00	29.12	PK+	V
6	17688.000	48.52	0.25	48.77	74.00	25.23	PK+	V

Mode:	1-DH5-2480
Power:	DC 5V
TE:	Big
Date	2025/02/13
T/A/P	22.1°C/51%/101Kpa

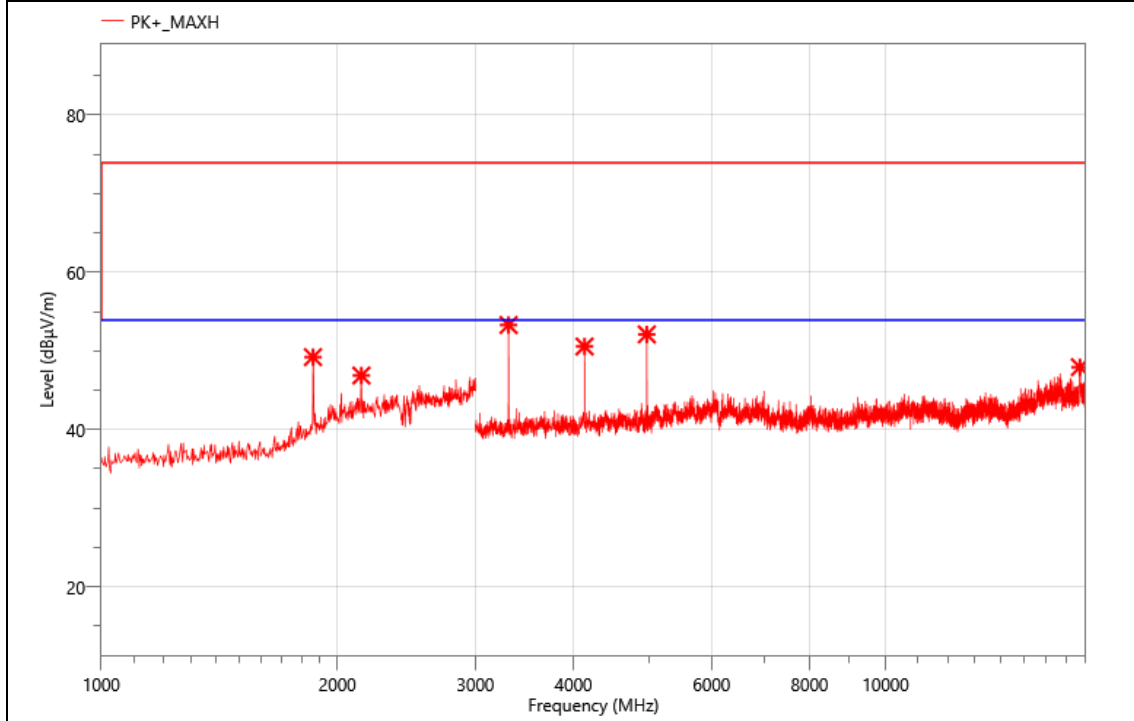

Critical_Freqs

No.	Freq. (MHz)	Reading (dBµV)	Corr. (dB)	Meas. (dBµV/m)	Limit (dBµV/m)	Margin (dB)	Det.	Pol.
1	1862.000	59.62	-10.41	49.21	74.00	24.79	PK+	H
2	2146.000	55.92	-9.05	46.87	74.00	27.13	PK+	H
3	3306.000	67.69	-14.4	53.29	74.00	20.71	PK+	H
4	4132.500	63.20	-12.64	50.56	74.00	23.44	PK+	H
5	4960.500	63.44	-11.34	52.10	74.00	21.90	PK+	H
6	17694.000	47.72	0.21	47.93	74.00	26.07	PK+	H

For the frequency above 18 GHz, a pre-scan was performed, and the result was 20 dB lower than the limit line, the test data was not shown in the report.

Band Edge

All modes have been tested and the worst result as bellow:

Mode:	1-DH5-2402
Power:	DC 5V
TE:	Berny
Date	2025/01/21
T/A/P	24.9°C/53%/101Kpa

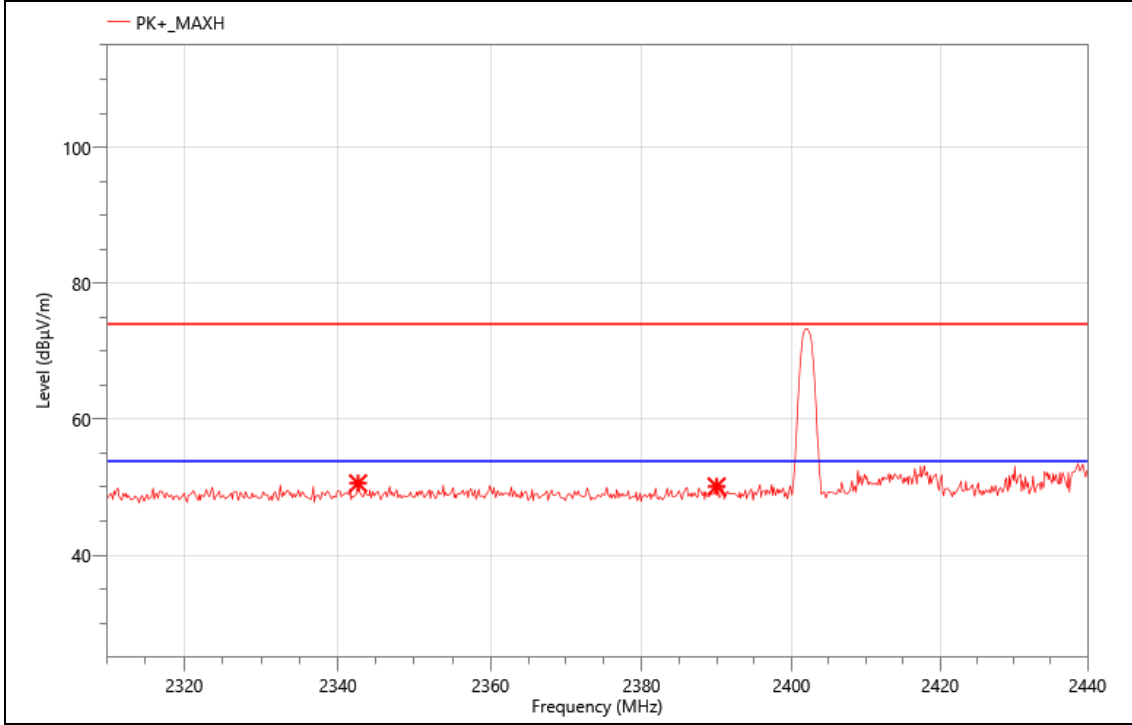

Critical_Freqs

No.	Freq. (MHz)	Reading (dBµV)	Corr. (dB)	Meas. (dBµV/m)	Limit (dBµV/m)	Margin (dB)	Det.	Pol.
1	2342.630	27.91	22.67	50.58	74.00	23.42	PK+	V
2	2390.000	27.40	22.72	50.12	74.00	23.88	PK+	V

Mode:	1-DH5-2402
Power:	DC 5V
TE:	Berny
Date	2025/01/21
T/A/P	24.9°C/53%/101Kpa

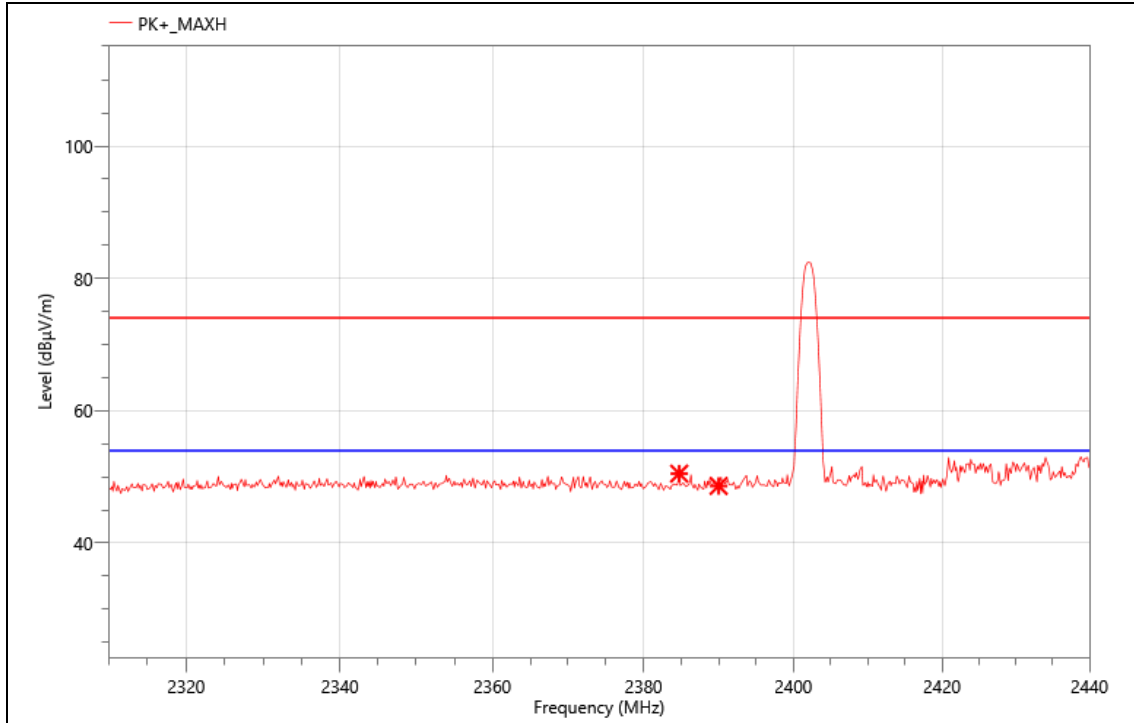

Critical_Freqs

No.	Freq. (MHz)	Reading (dBµV)	Corr. (dB)	Meas. (dBµV/m)	Limit (dBµV/m)	Margin (dB)	Det.	Pol.
1	2384.750	27.87	22.62	50.49	74.00	23.51	PK+	H
2	2390.000	25.90	22.72	48.62	74.00	25.38	PK+	H

Mode:	1-DH5-2480
Power:	DC 5V
TE:	Berny
Date	2025/01/21
T/A/P	24.9°C/53%/101Kpa

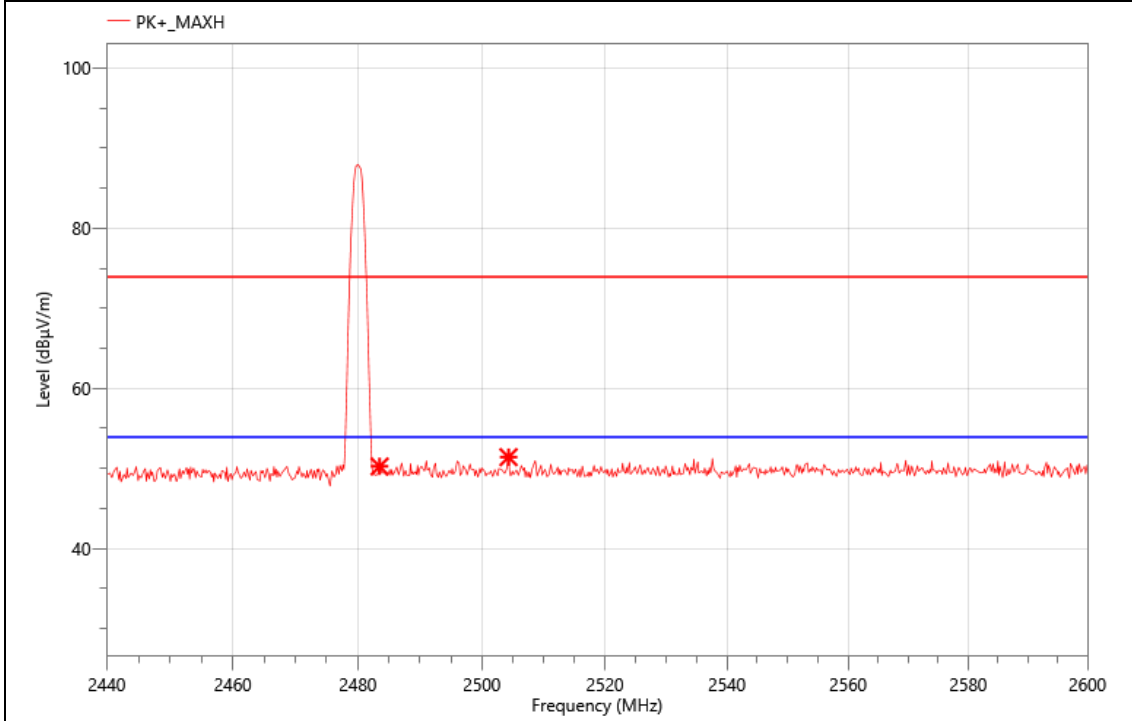

Critical_Freqs

No.	Freq. (MHz)	Reading (dBµV)	Corr. (dB)	Meas. (dBµV/m)	Limit (dBµV/m)	Margin (dB)	Det.	Pol.
1	2483.500	27.09	23.15	50.24	74.00	23.76	PK+	H
2	2504.320	28.30	23.1	51.40	74.00	22.60	PK+	H

Mode:	1-DH5-2480
Power:	DC 5V
TE:	Berny
Date	2025/01/21
T/A/P	24.9°C/53%/101Kpa

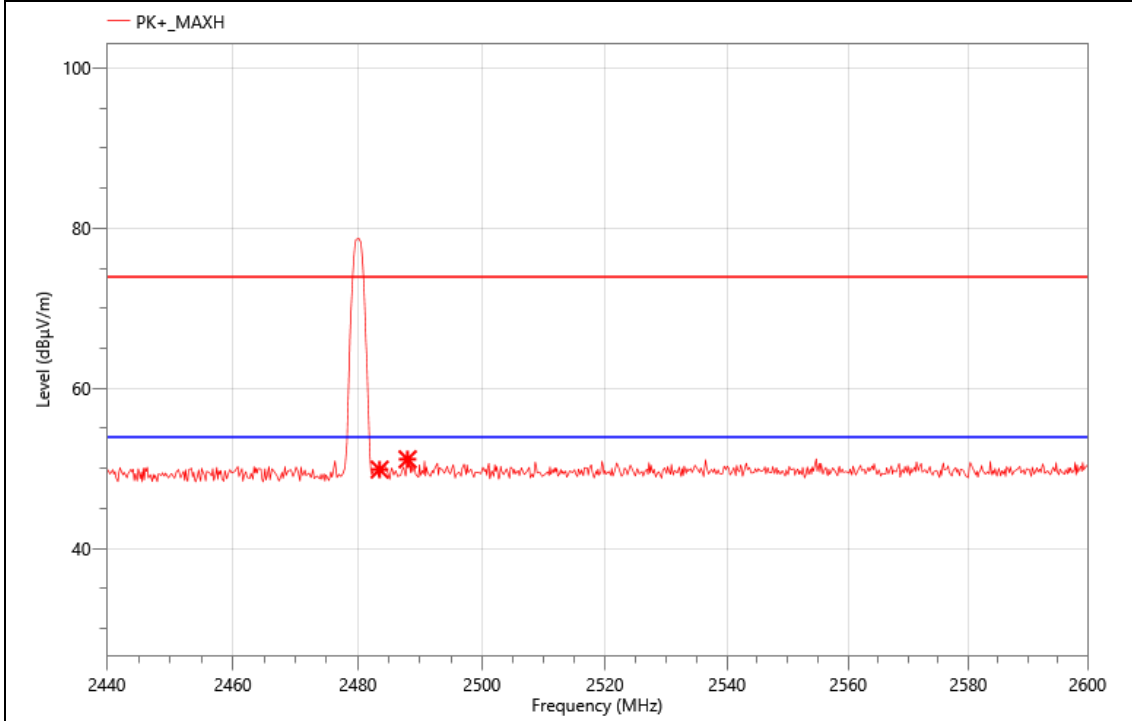

Critical_Freqs

No.	Freq. (MHz)	Reading (dBµV)	Corr. (dB)	Meas. (dBµV/m)	Limit (dBµV/m)	Margin (dB)	Det.	Pol.
1	2483.500	26.70	23.15	49.85	74.00	24.15	PK+	V
2	2488.000	27.99	23.14	51.13	74.00	22.87	PK+	V

9. ANTENNA REQUIREMENT

REQUIREMENT

Please refer to FCC §15.203

An intentional radiator shall be designed to ensure that no antenna other than that furnished by the responsible party shall be used with the device. The use of a permanently attached antenna or of an antenna that uses a unique coupling to the intentional radiator shall be considered sufficient to comply with the provisions of this section. The manufacturer may design the unit so that a broken antenna can be replaced by the user, but the use of a standard antenna jack or electrical connector is prohibited.

Please refer to FCC §15.247(b)(4)

The conducted output power limit specified in paragraph (b) of this section is based on the use of antennas with directional gains that do not exceed 6 dBi. Except as shown in paragraph (c) of this section, if transmitting antennas of directional gain greater than 6 dBi are used, the conducted output power from the intentional radiator shall be reduced below the stated values in paragraphs (b)(1), (b)(2), and (b)(3) of this section, as appropriate, by the amount in dB that the directional gain of the antenna exceeds 6 dBi.

DESCRIPTION

Pass.

10. AC POWER LINE CONDUCTED EMISSION

LIMITS

Please refer to CFR 47 FCC §15.207 (a) and ISED RSS-Gen Clause 8.8

FREQUENCY (MHz)	Quasi-peak	Average
0.15 -0.5	66 - 56 *	56 - 46 *
0.50 -5.0	56.00	46.00
5.0 -30.0	60.00	50.00

TEST PROCEDURE

Refer to ANSI C63.10-2013 clause 6.2.

The EUT is put on a table of non-conducting material that is 80 cm high. The vertical conducting wall of shielding is located 40 cm to the rear of the EUT. The power line of the EUT is connected to the AC mains through a Artificial Mains Network (A.M.N.). A EMI Measurement Receiver is used to test the emissions from the AC line. According to the requirements in Section 6.2 of ANSI C63.10-2013. Conducted emissions from the EUT measured in the frequency range between 0.15 MHz and 30 MHz using CISPR Quasi-Peak and average detector mode. The bandwidth of EMI test receiver is set at 9 kHz.

The arrangement of the equipment is installed to meet the standards and operating in a manner, which tends to maximize its emission characteristics in a normal application.

TEST SETUP

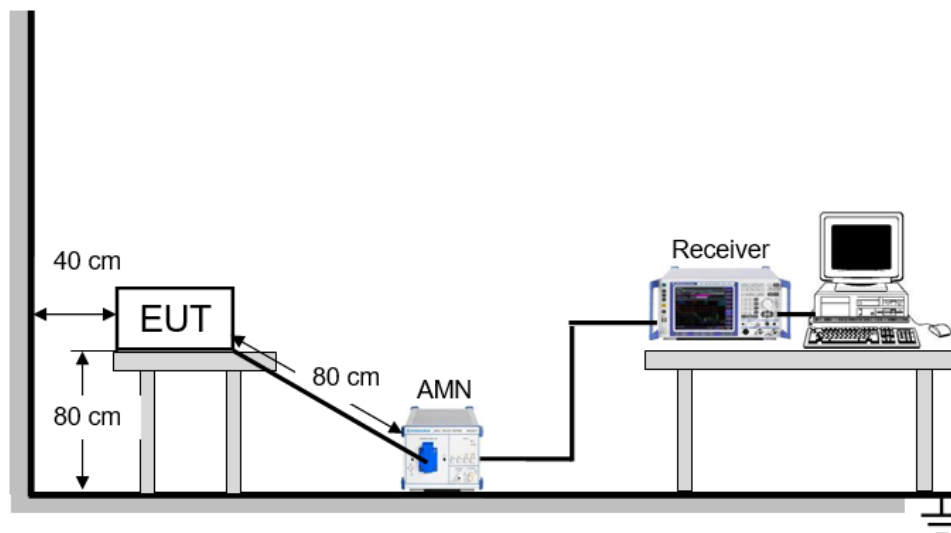

TEST ENVIRONMENT

Temperature	26°C	Relative Humidity	54%
Atmosphere Pressure	101kPa		

TEST RESULTS

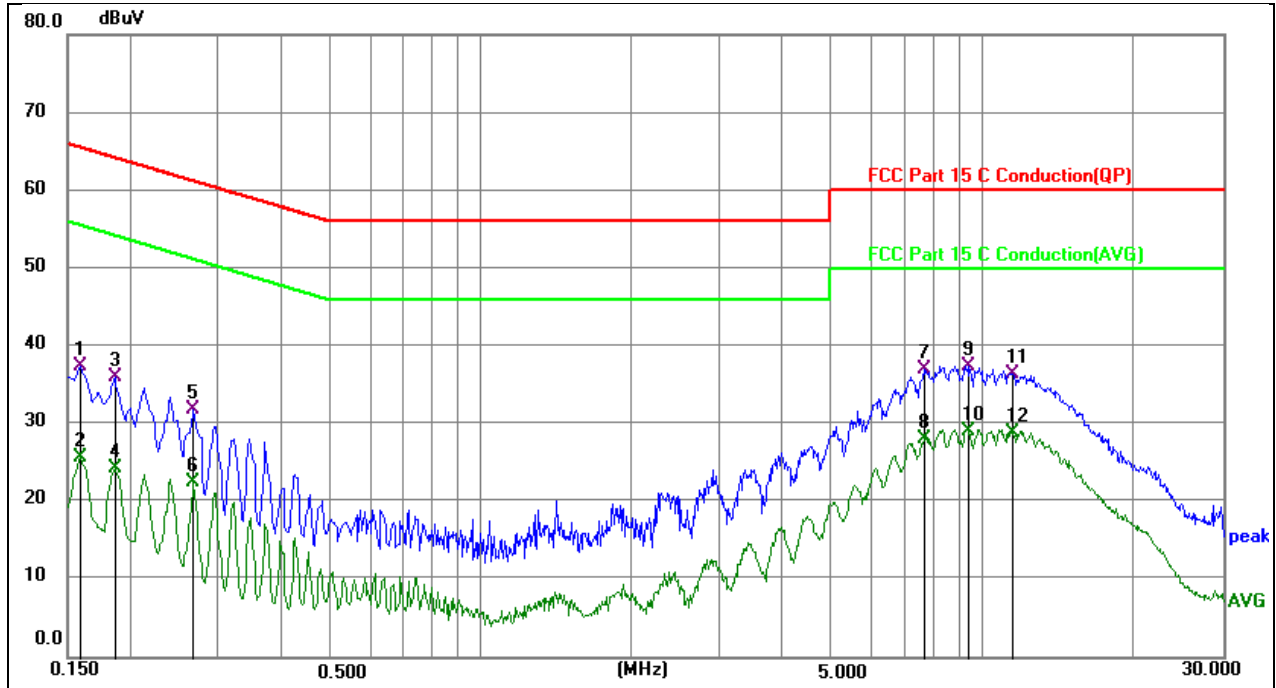

Phase: L1

Mode: DH5 2402MHz

No.	Frequency (MHz)	Reading (dBuV)	Correct (dB)	Result (dBuV)	Limit (dBuV)	Margin (dB)	Remark
1	0.1590	27.63	9.71	37.34	65.52	-28.18	QP
2	0.1590	15.96	9.71	25.67	55.52	-29.85	AVG
3	0.1860	26.36	9.71	36.07	64.21	-28.14	QP
4	0.1860	14.69	9.71	24.40	54.21	-29.81	AVG
5	0.2670	22.13	9.73	31.86	61.21	-29.35	QP
6	0.2670	12.89	9.73	22.62	51.21	-28.59	AVG
7	7.6290	27.15	9.88	37.03	60.00	-22.97	QP
8	7.6290	18.30	9.88	28.18	50.00	-21.82	AVG
9	9.3164	27.56	9.89	37.45	60.00	-22.55	QP
10	9.3164	19.14	9.89	29.03	50.00	-20.97	AVG
11	11.4855	26.49	9.94	36.43	60.00	-23.57	QP
12	11.4855	19.01	9.94	28.95	50.00	-21.05	AVG

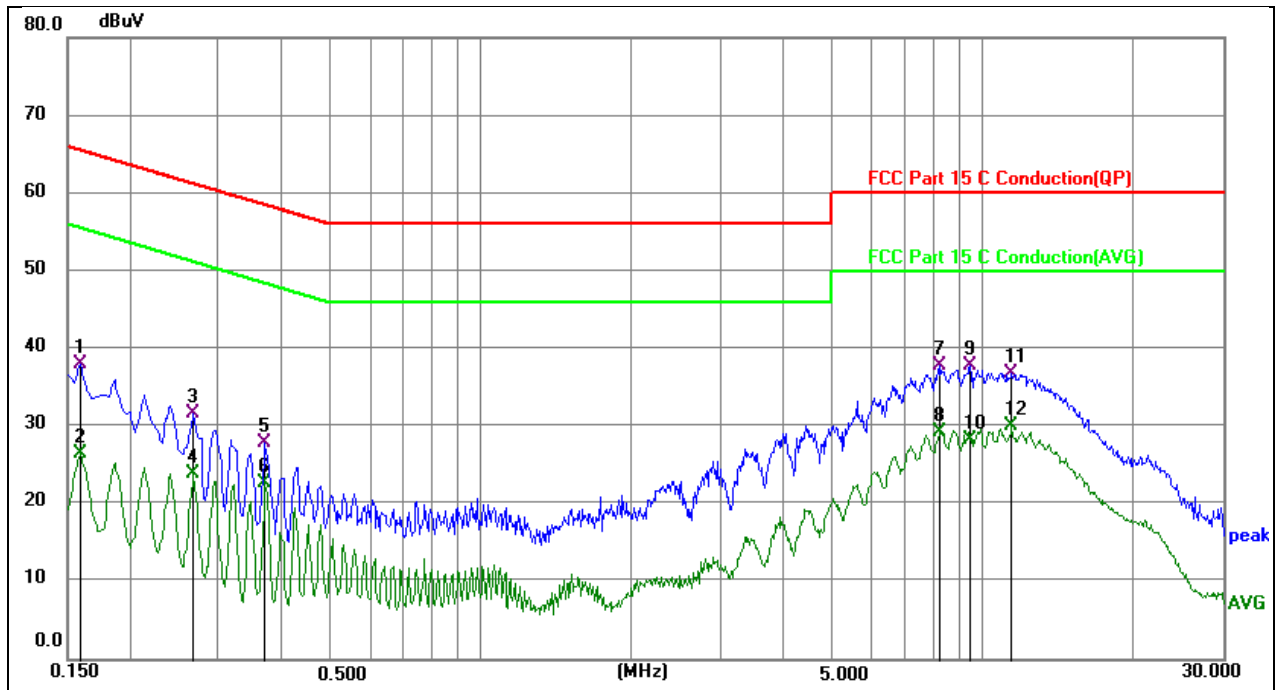

Phase: N	Mode: DH5 2402MHz
----------	-------------------

No.	Frequency (MHz)	Reading (dBuV)	Correct (dB)	Result (dBuV)	Limit (dBuV)	Margin (dB)	Remark
1	0.1590	28.13	9.89	38.02	65.52	-27.50	QP
2	0.1590	16.61	9.89	26.50	55.52	-29.02	AVG
3	0.2670	21.89	9.79	31.68	61.21	-29.53	QP
4	0.2670	14.06	9.79	23.85	51.21	-27.36	AVG
5	0.3704	18.10	9.76	27.86	58.49	-30.63	QP
6	0.3704	12.92	9.76	22.68	48.49	-25.81	AVG
7	8.2230	27.82	9.98	37.80	60.00	-22.20	QP
8	8.2230	19.30	9.98	29.28	50.00	-20.72	AVG
9	9.4110	27.78	9.99	37.77	60.00	-22.23	QP
10	9.4110	18.24	9.99	28.23	50.00	-21.77	AVG
11	11.4135	26.76	9.98	36.74	60.00	-23.26	QP
12	11.4135	20.05	9.98	30.03	50.00	-19.97	AVG

- Note: 1. Result = Reading + Correct Factor.
 2. If QP Result complies with AV limit, AV Result is deemed to comply with AV limit.
 3. Test setup: RBW: 200 Hz (9 kHz ~ 150 kHz), 9 kHz (150 kHz ~ 30 MHz).
 4. Step size: 80 Hz (0.009 MHz ~ 0.15 MHz), 4 kHz (0.15 MHz ~ 30 MHz), Scan time: auto.

Note: All the modes have been tested, only the worst data was recorded in the report.

11. TEST DATA - Appendix A

Maximum Conducted Output Power

Condition	Mode	Frequency (MHz)	Antenna	Conducted Power (dBm)	Limit (dBm)	Verdict
NVNT	1-DH5	2402	Ant1	-2.06	21	Pass
NVNT	1-DH5	2441	Ant1	-1.43	21	Pass
NVNT	1-DH5	2480	Ant1	-2.12	21	Pass

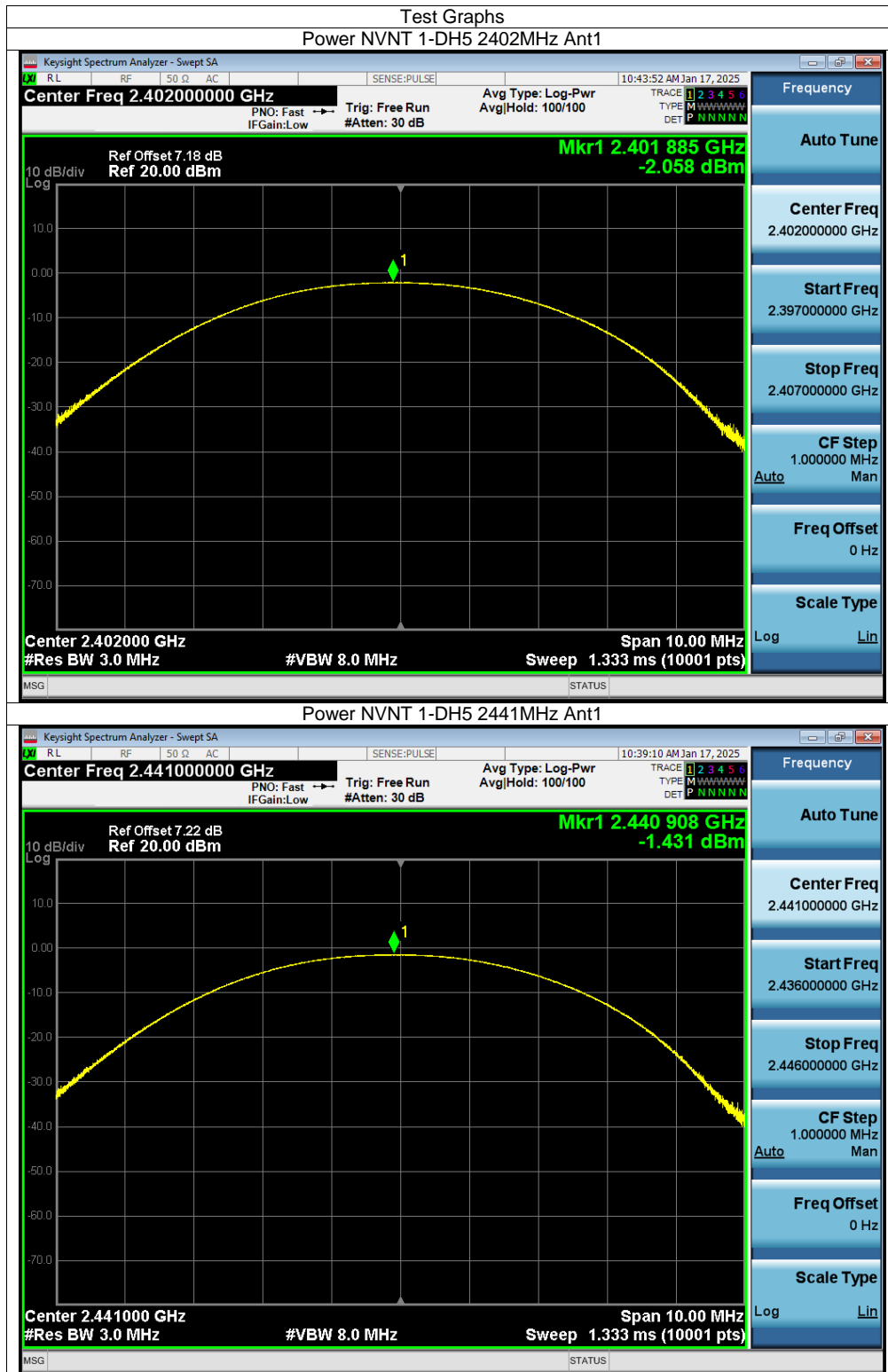

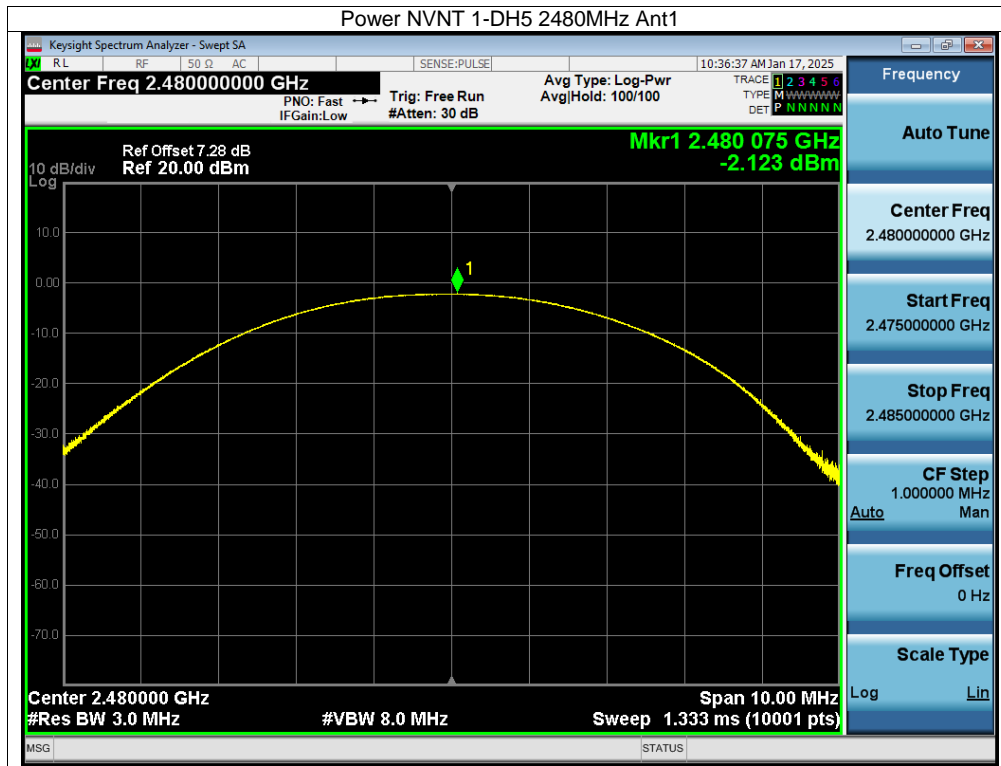

-20dB Bandwidth

Condition	Mode	Frequency (MHz)	Antenna	-20 dB Bandwidth (MHz)	Limit -20 dB Bandwidth (MHz)	Verdict
NVNT	1-DH5	2402	Ant1	0.95	N/A	N/A
NVNT	1-DH5	2441	Ant1	0.96	N/A	N/A
NVNT	1-DH5	2480	Ant1	0.94	N/A	N/A

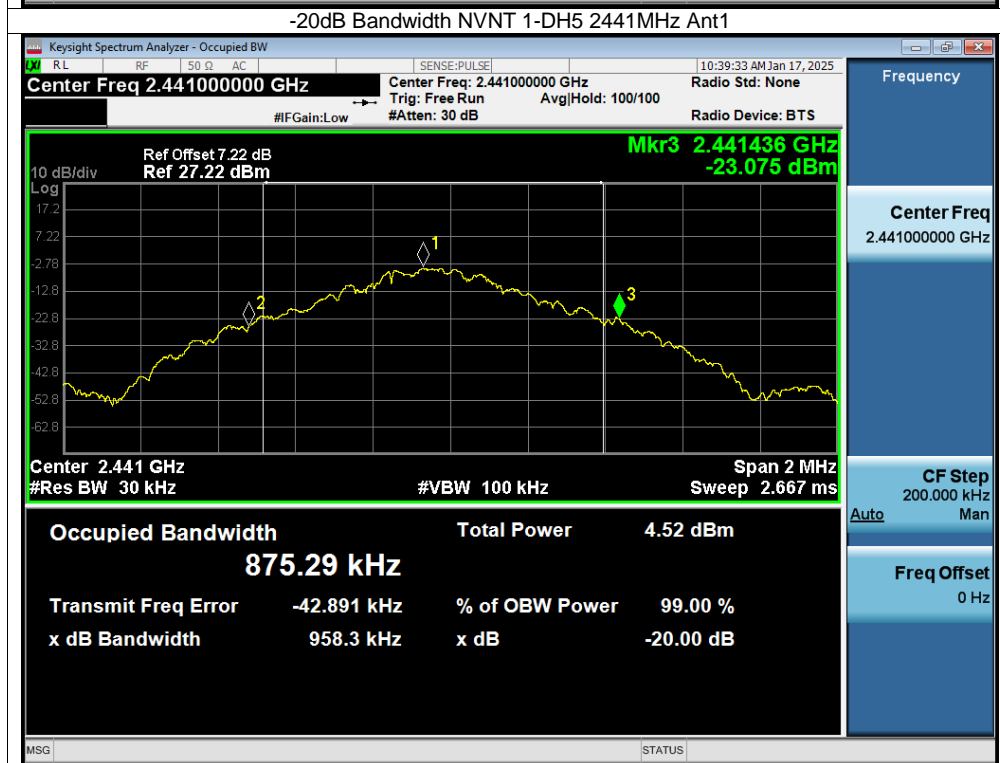
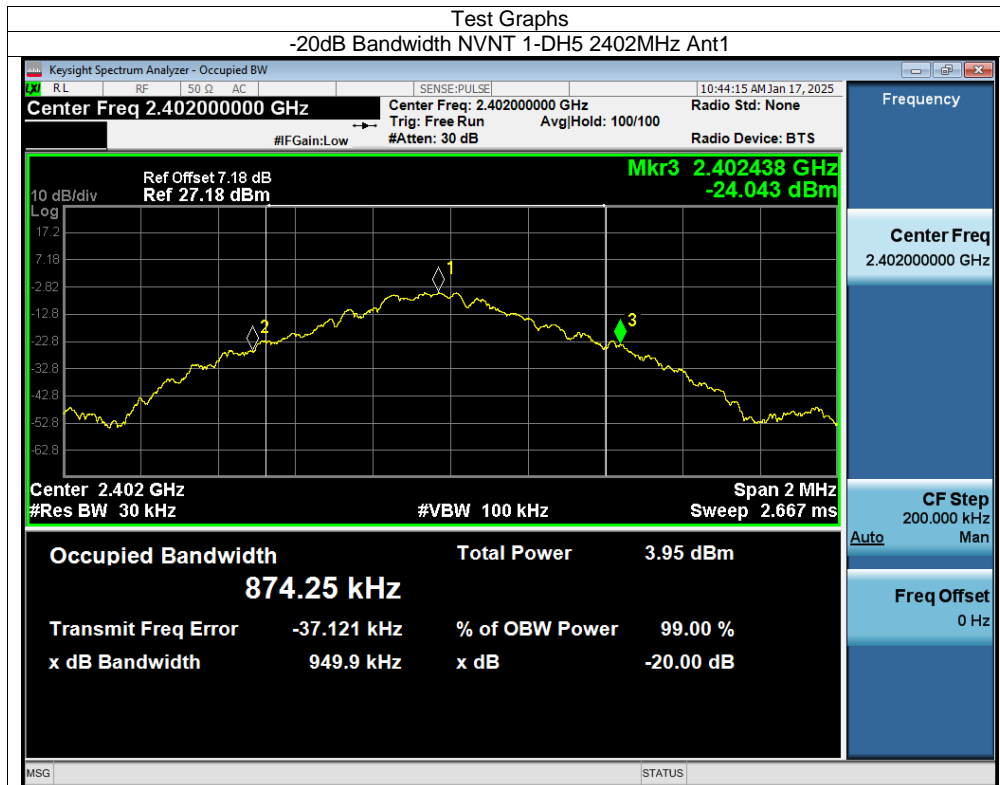

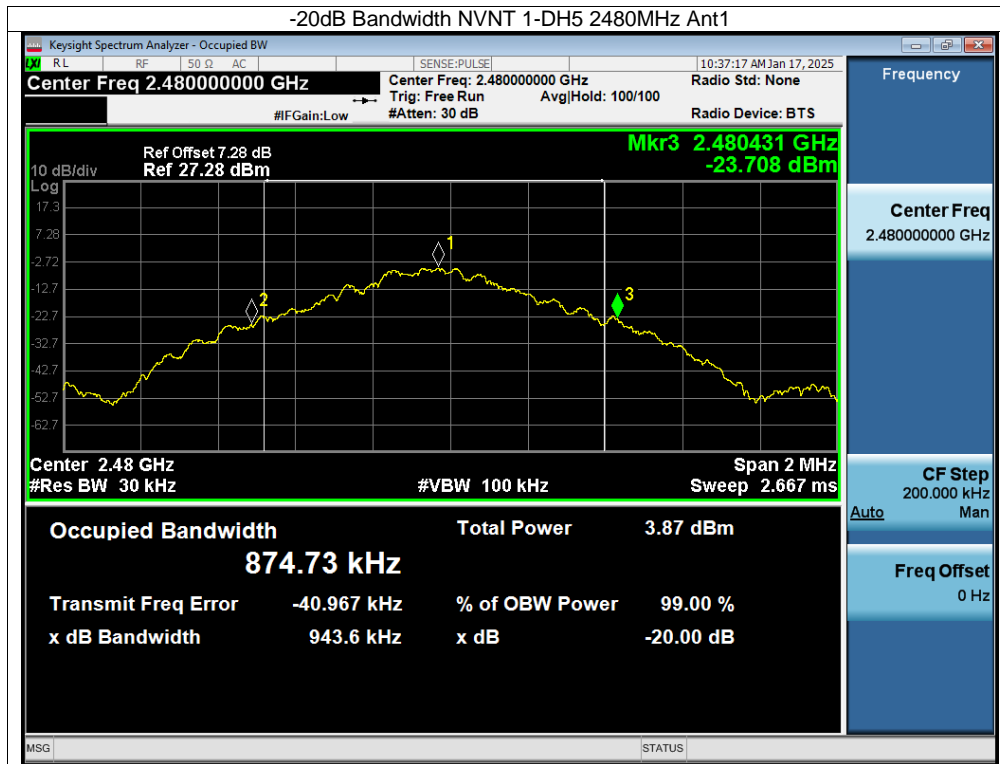

Occupied Channel Bandwidth

Condition	Mode	Frequency (MHz)	Antenna	99% OBW (MHz)
NVNT	1-DH5	2402	Ant1	0.872
NVNT	1-DH5	2441	Ant1	0.873
NVNT	1-DH5	2480	Ant1	0.881

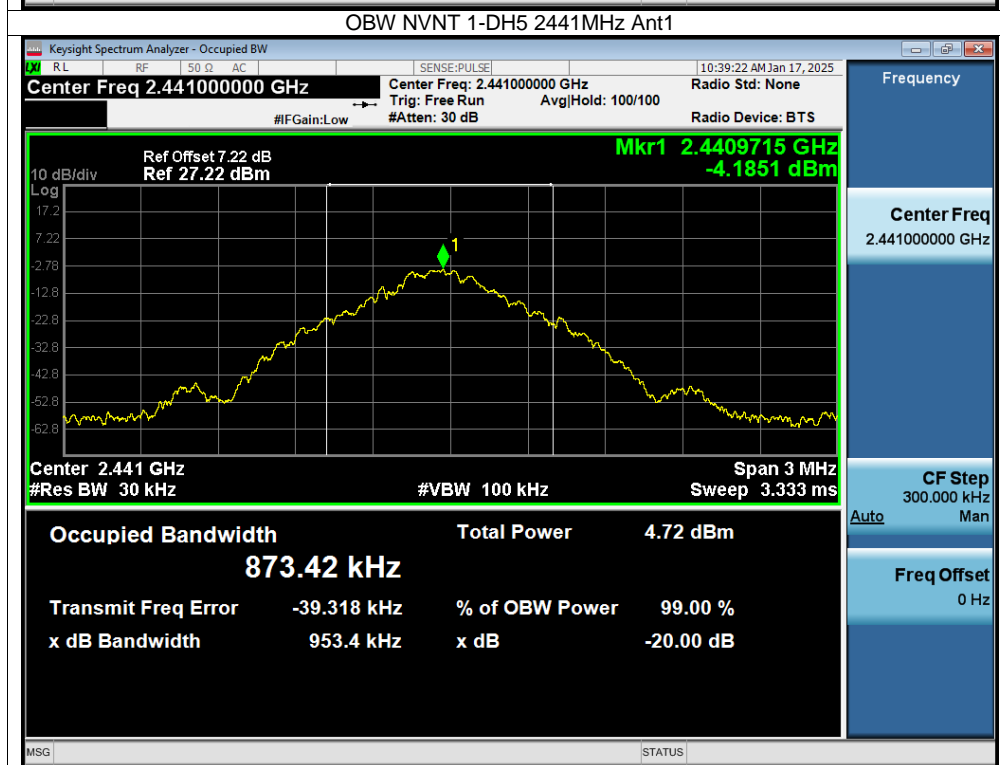
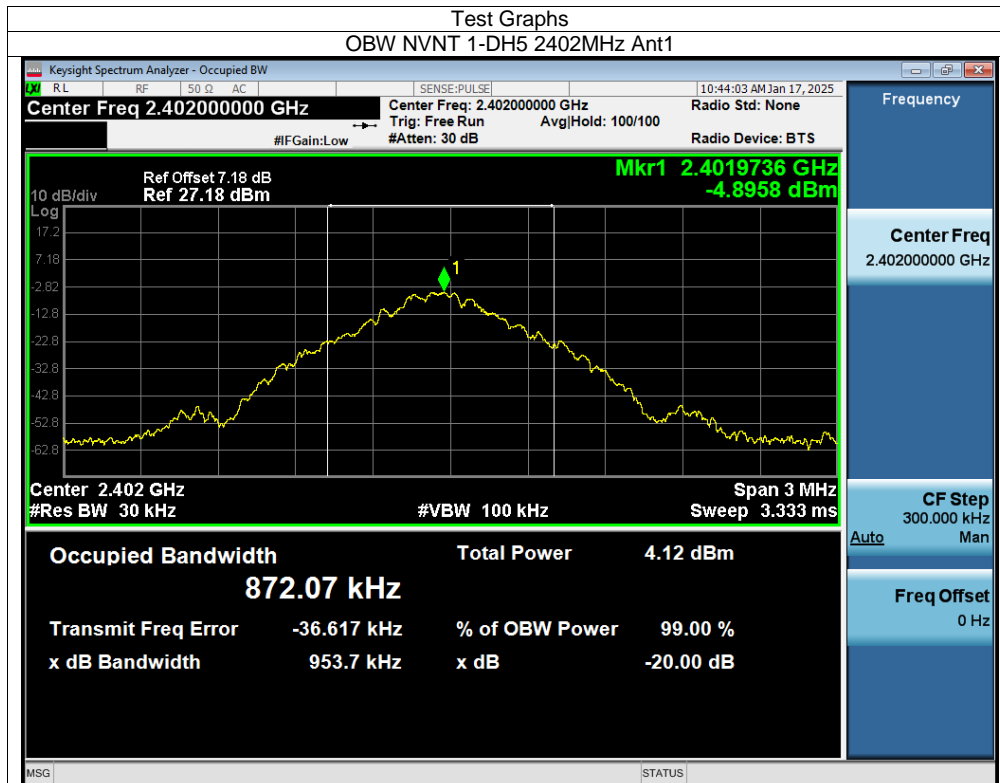



Carrier Frequencies Separation

Condition	Mode	Antenna	Hopping Freq1 (MHz)	Hopping Freq2 (MHz)	HFS (MHz)	Limit (MHz)	Verdict
NVNT	1-DH5	Ant1	2401.928	2402.968	1.04	0.633	Pass
NVNT	1-DH5	Ant1	2440.974	2441.972	0.998	0.64	Pass
NVNT	1-DH5	Ant1	2478.97	2479.972	1.002	0.627	Pass

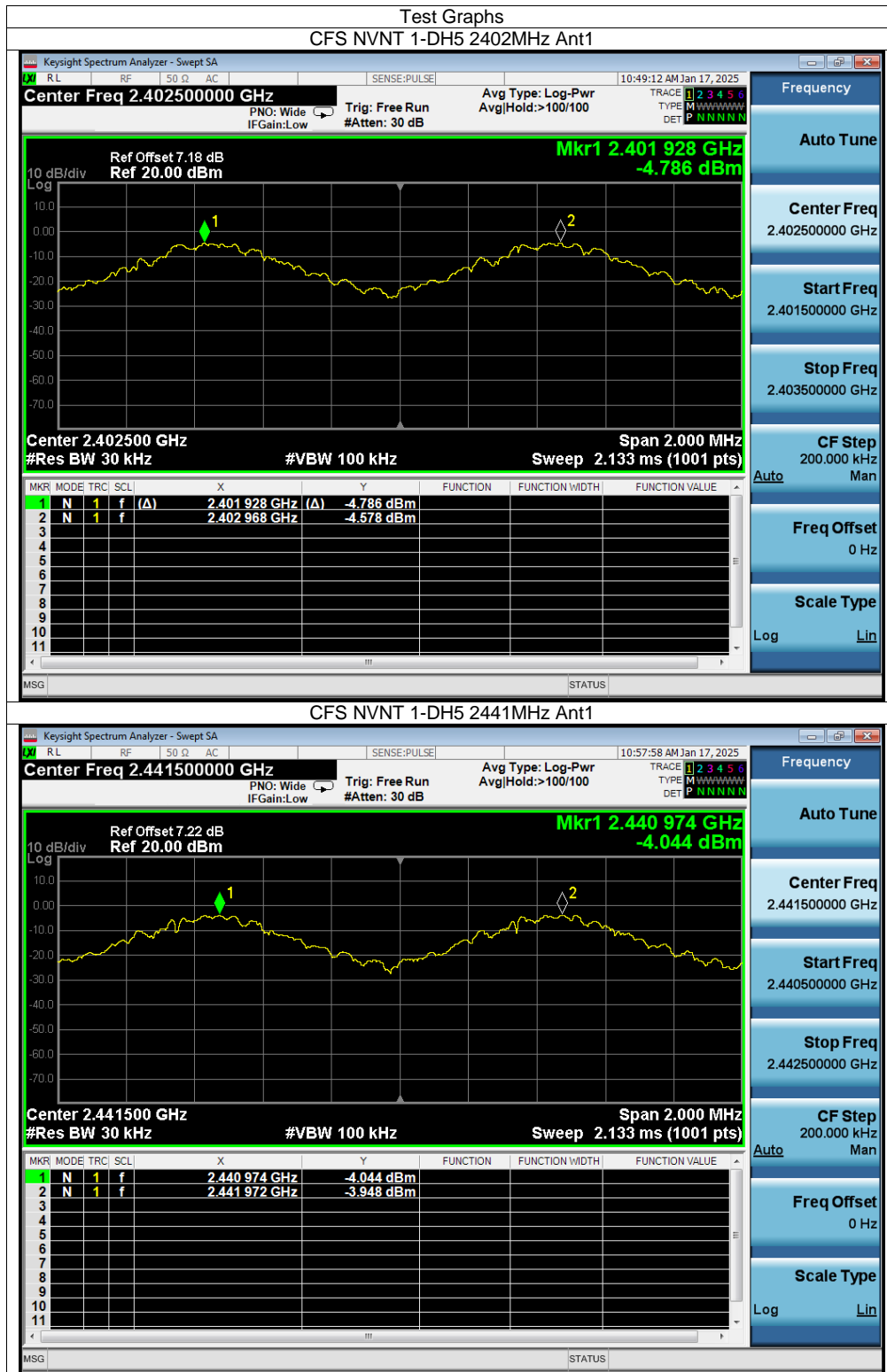



Number of Hopping Channel

Condition	Mode	Antenna	Hopping Number	Limit	Verdict
NVNT	1-DH5	Ant1	79	15	Pass

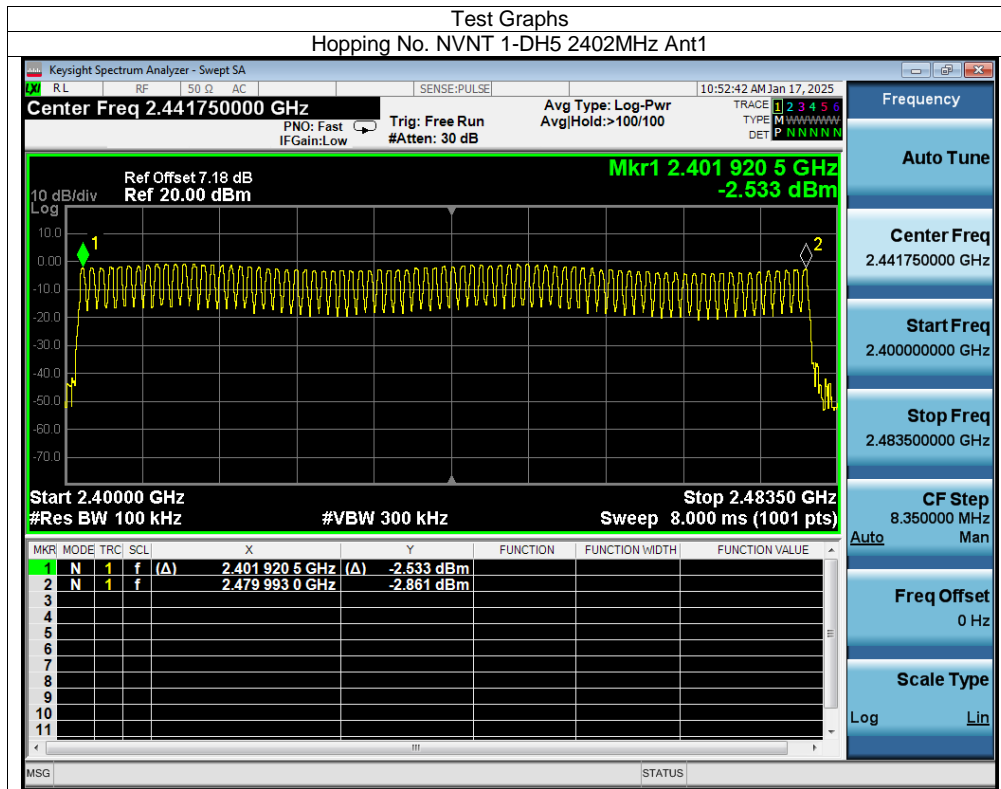

Dwell Time

Condition	Mode	Frequency (MHz)	Antenna	Pulse Time (ms)	Total Dwell Time (ms)	Burst Count	Period Time (ms)	Limit (ms)	Verdict
NVNT	1-DH5	2402	Ant1	2.809	112.36	40	31600	400	Pass
NVNT	1-DH5	2441	Ant1	2.809	112.36	40	31600	400	Pass
NVNT	1-DH5	2480	Ant1	2.809	112.36	40	31600	400	Pass

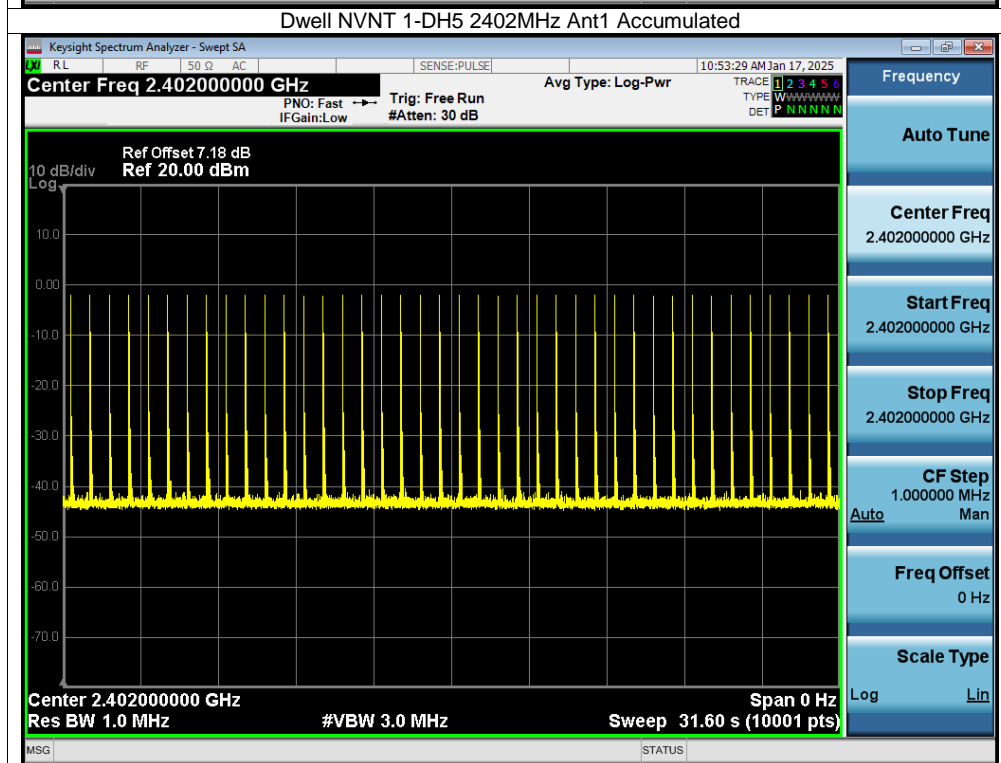
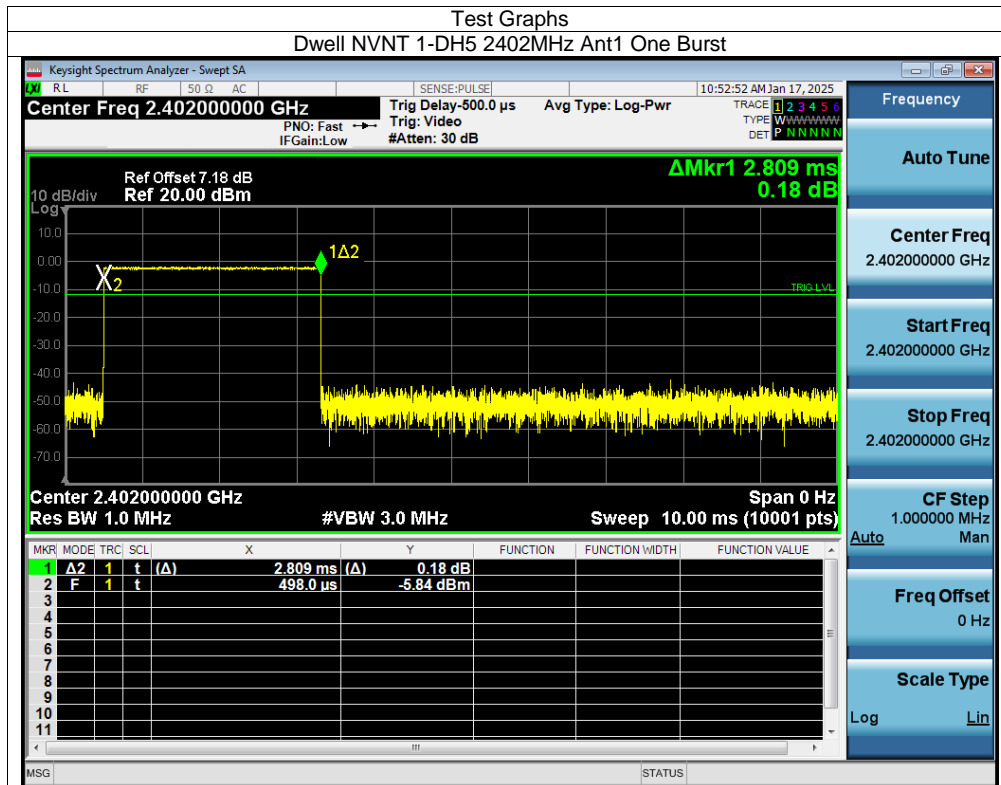

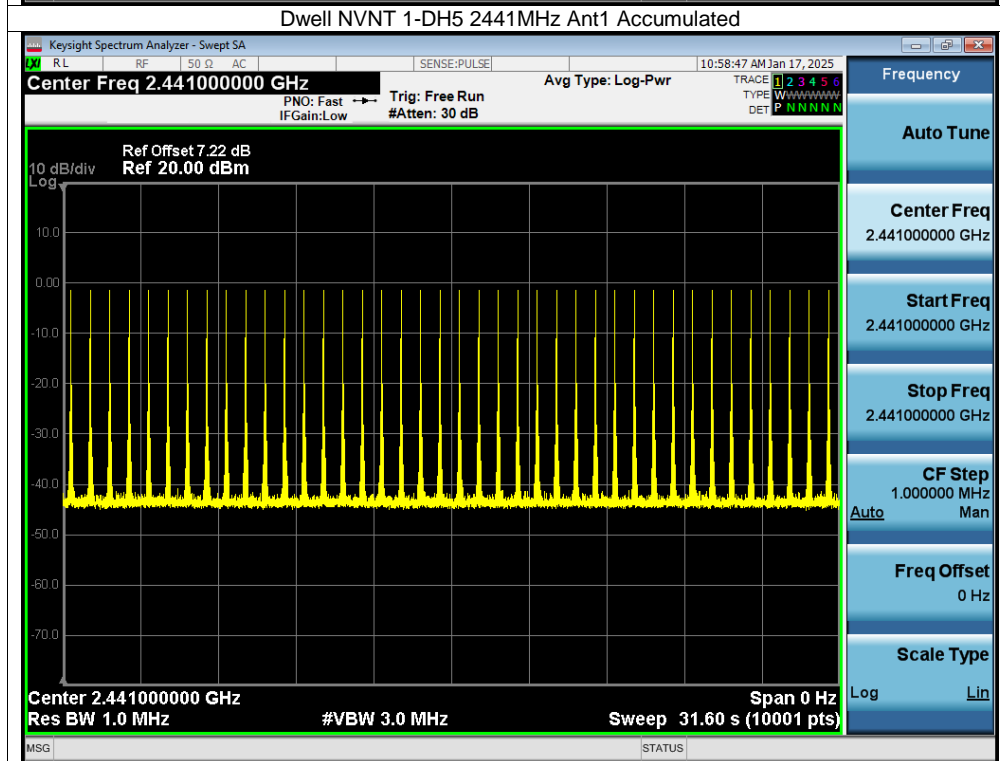
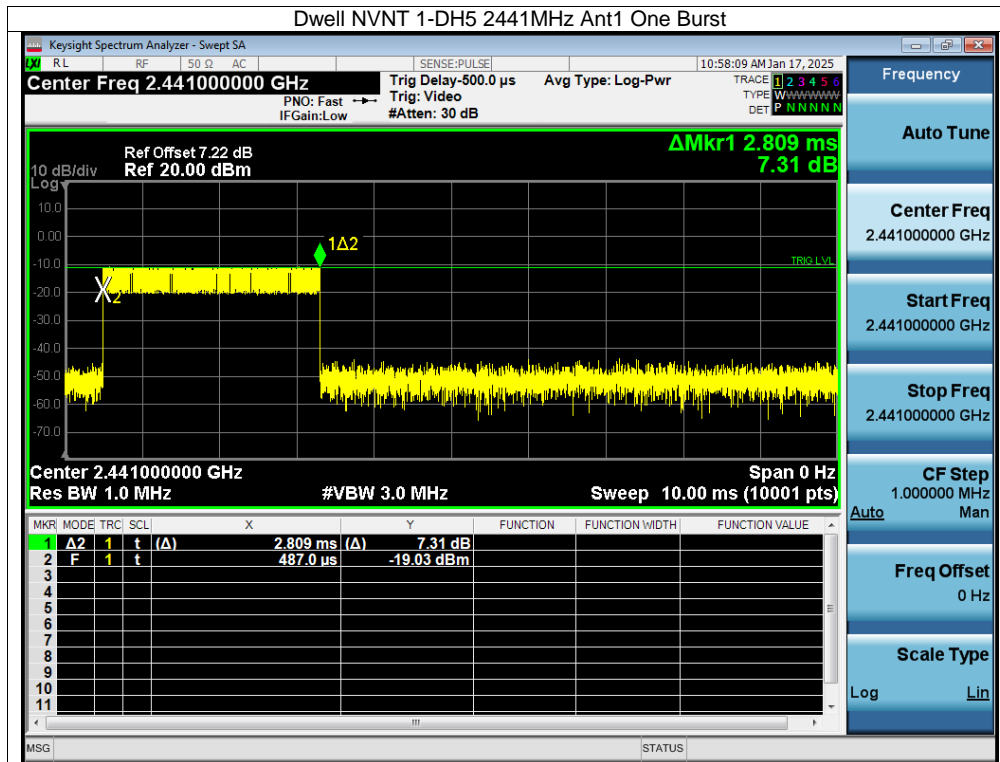

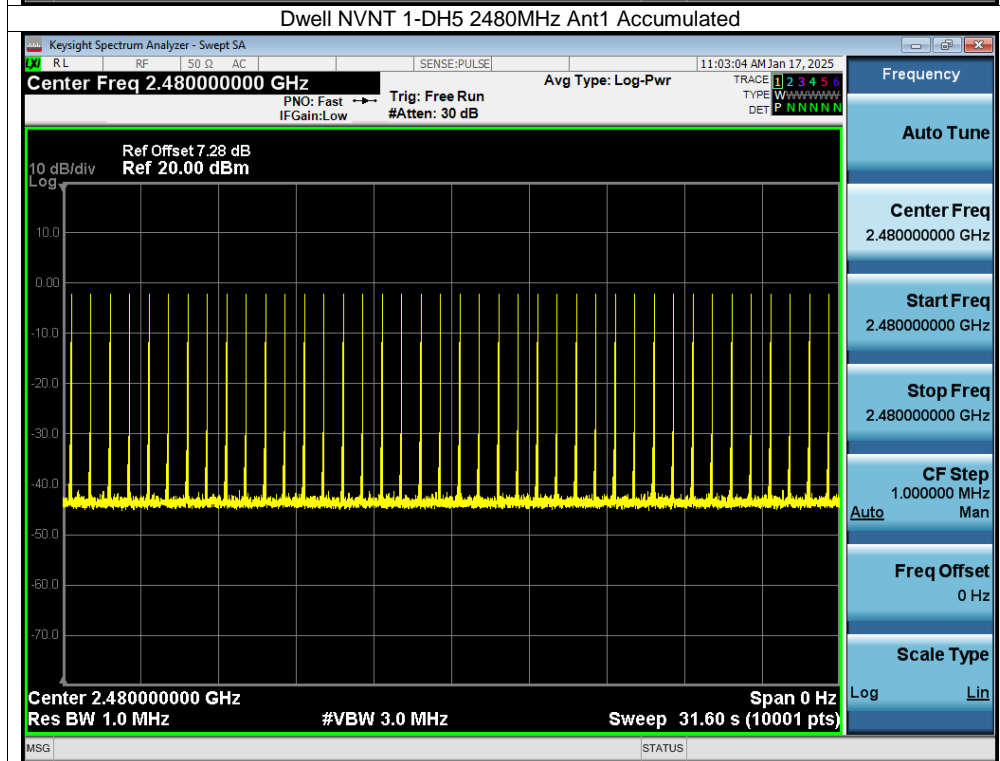
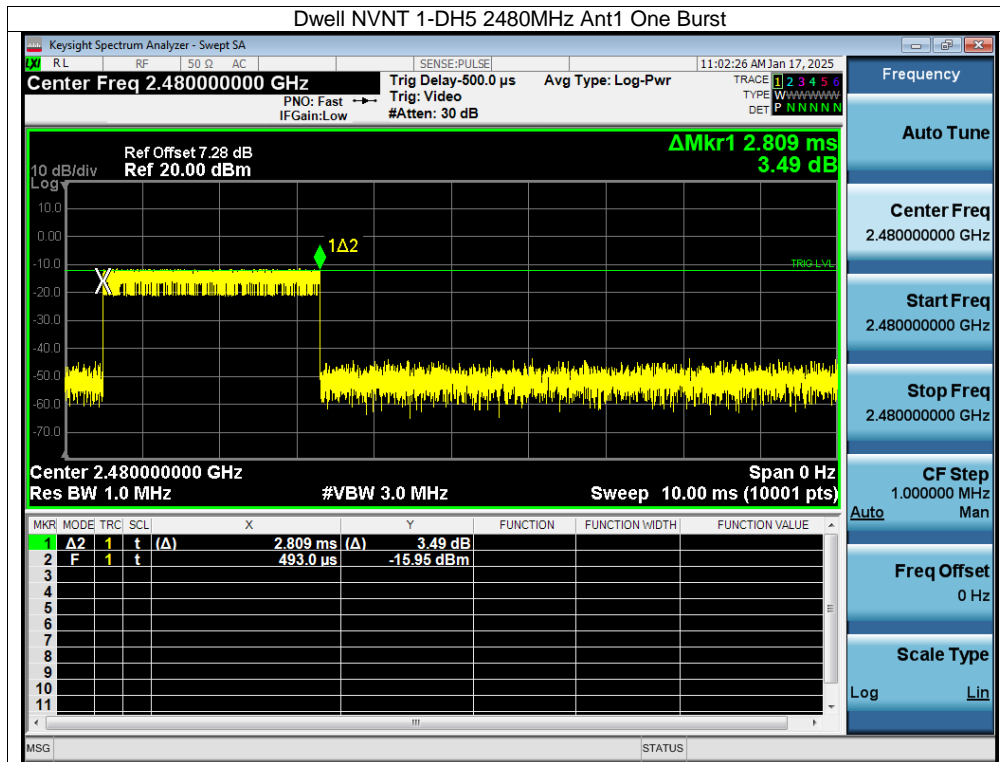

Band Edge

Condition	Mode	Frequency (MHz)	Antenna	Hopping Mode	Max Value (dBc)	Limit (dBc)	Verdict
NVNT	1-DH5	2402	Ant1	No-Hopping	-49.426	-20	Pass
NVNT	1-DH5	2480	Ant1	No-Hopping	-48.995	-20	Pass

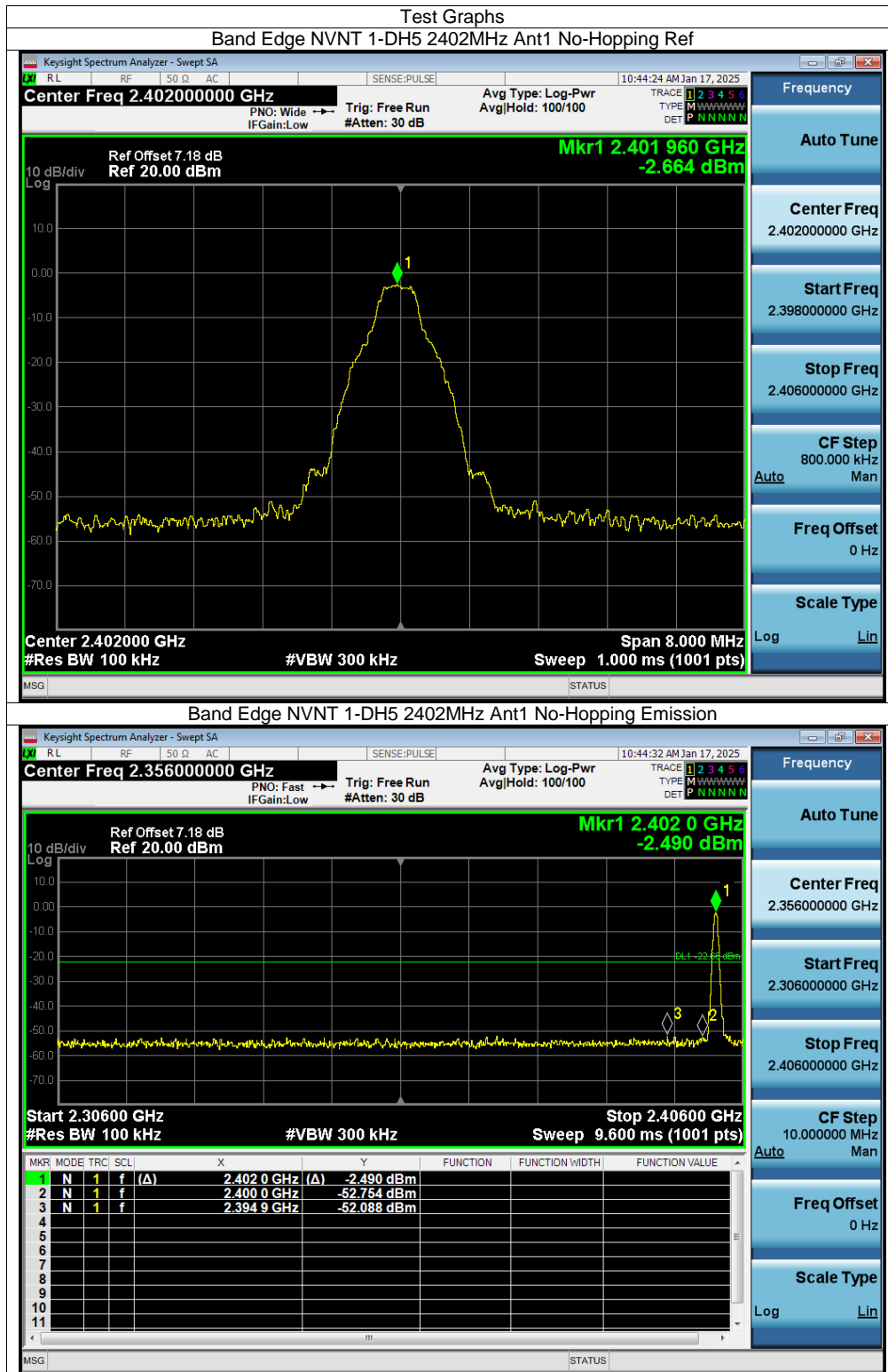

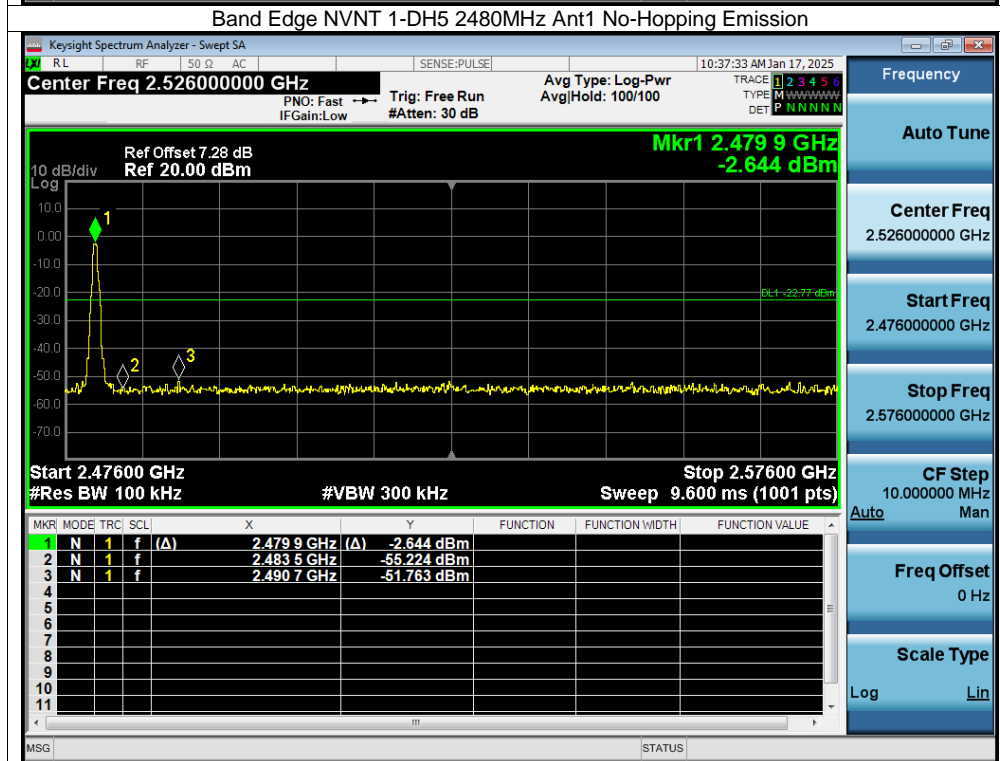
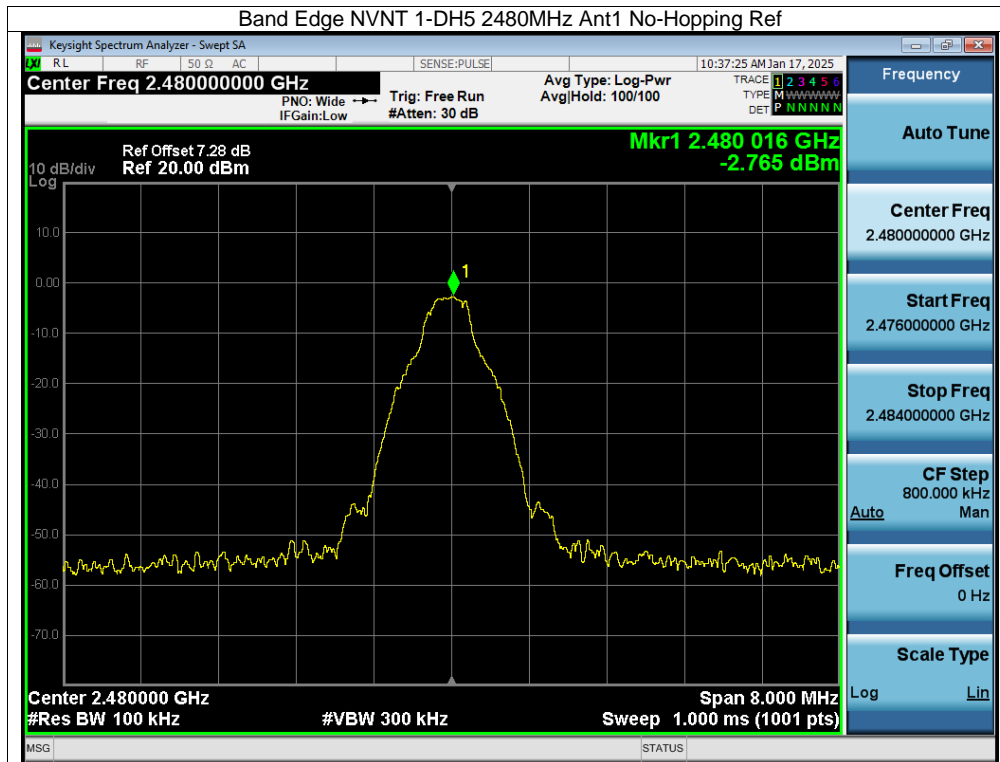

Band Edge(Hopping)

Condition	Mode	Frequency (MHz)	Antenna	Hopping Mode	Max Value (dBc)	Limit (dBc)	Verdict
NVNT	1-DH5	2402	Ant1	Hopping	-44.645	-20	Pass
NVNT	1-DH5	2480	Ant1	Hopping	-43.611	-20	Pass

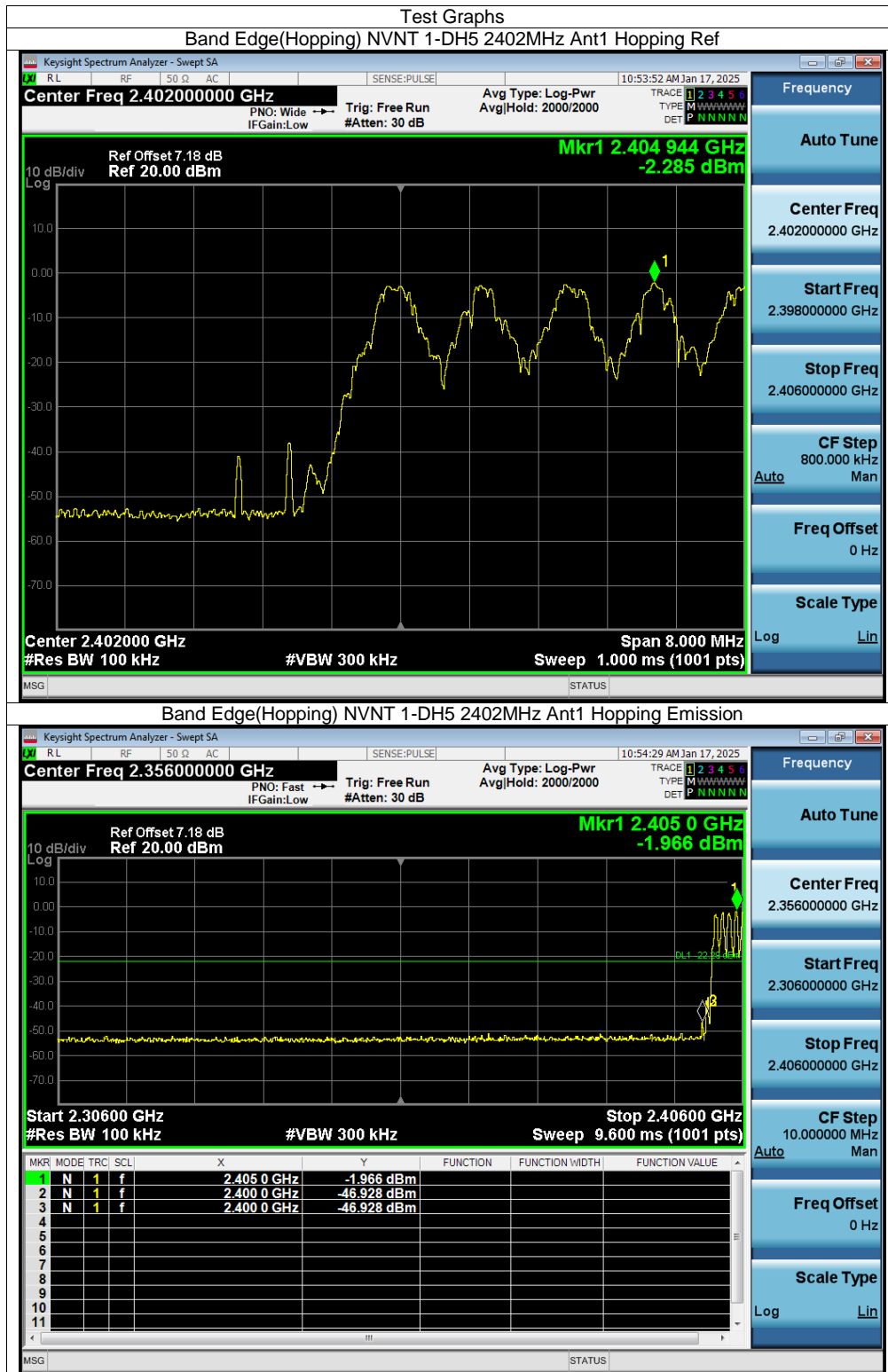

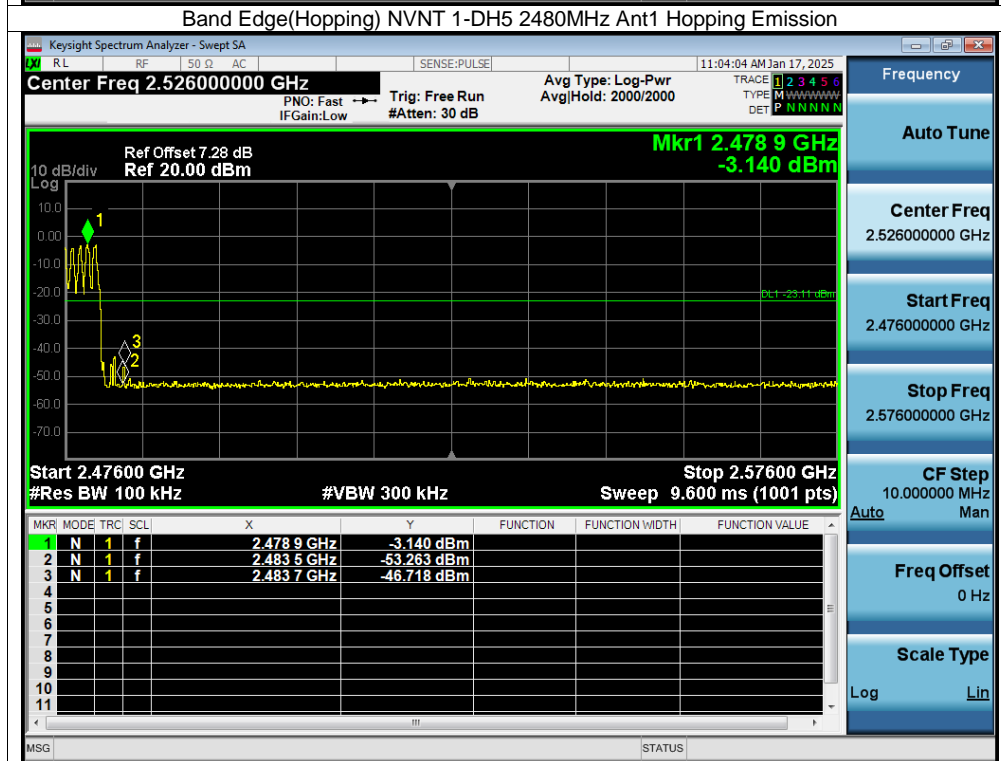
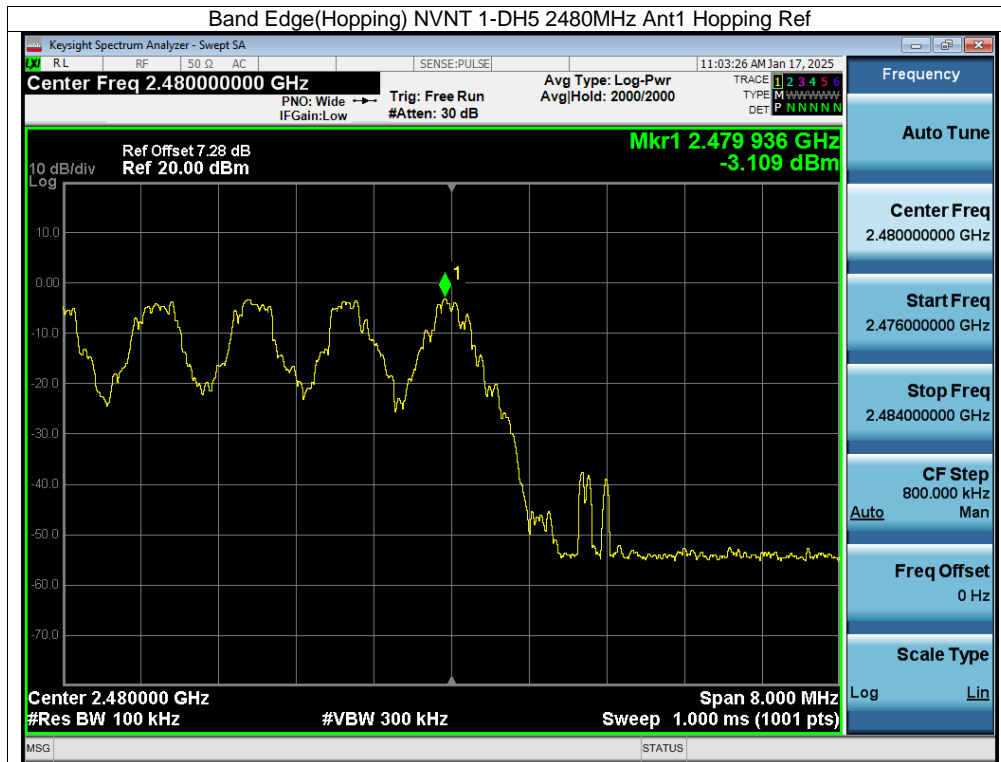

Conducted RF Spurious Emission

Condition	Mode	Frequency (MHz)	Antenna	Max Value (dBc)	Limit (dBc)	Verdict
NVNT	1-DH5	2402	Ant1	-35.45	-20	Pass
NVNT	1-DH5	2441	Ant1	-32.43	-20	Pass
NVNT	1-DH5	2480	Ant1	-34.81	-20	Pass

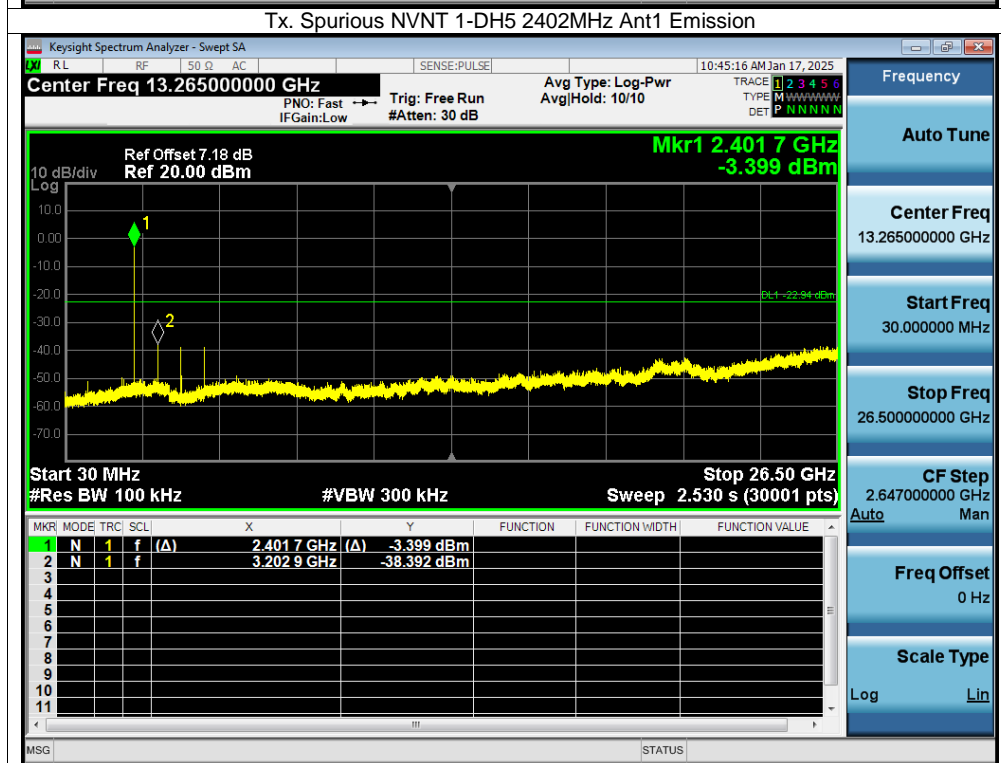
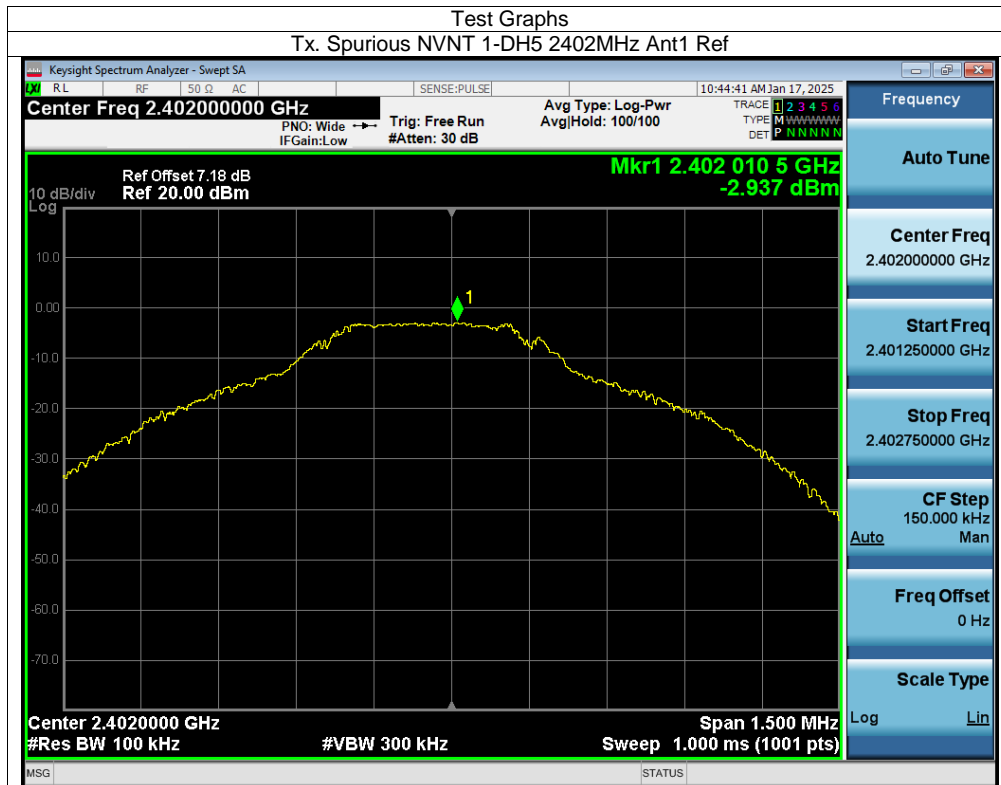

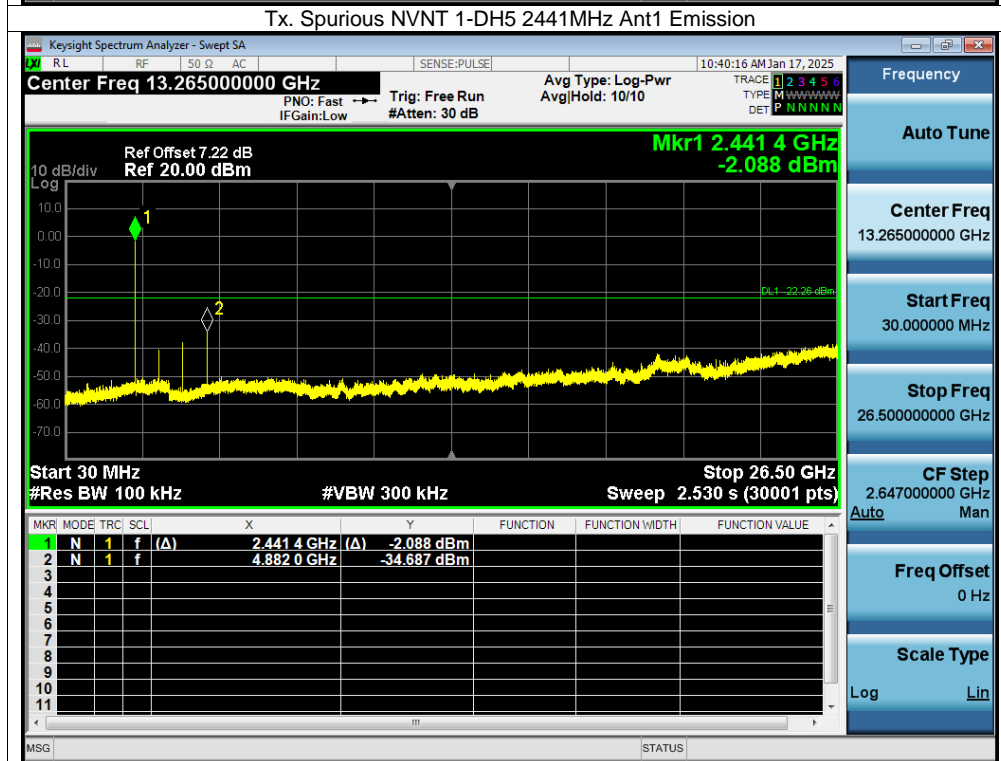
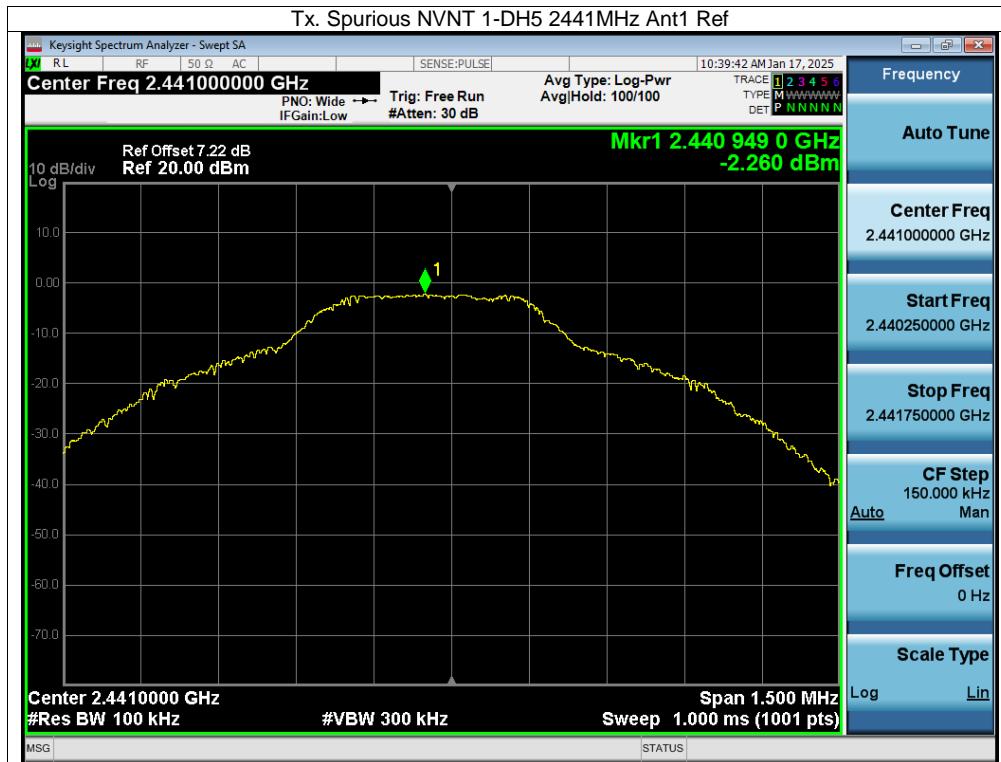

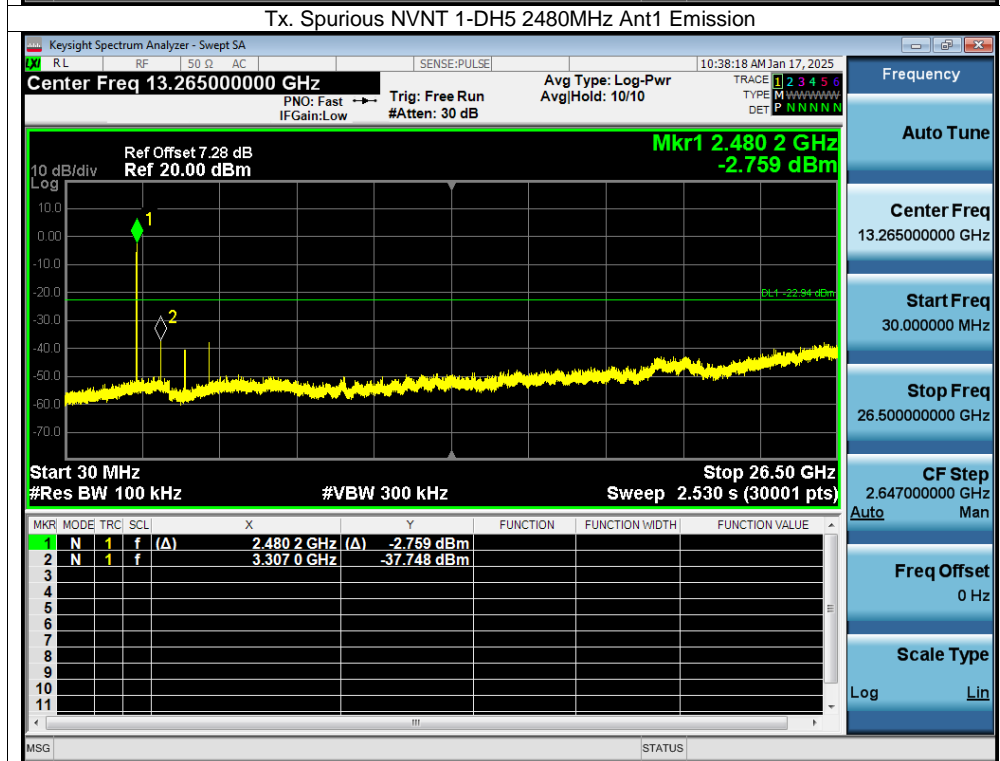
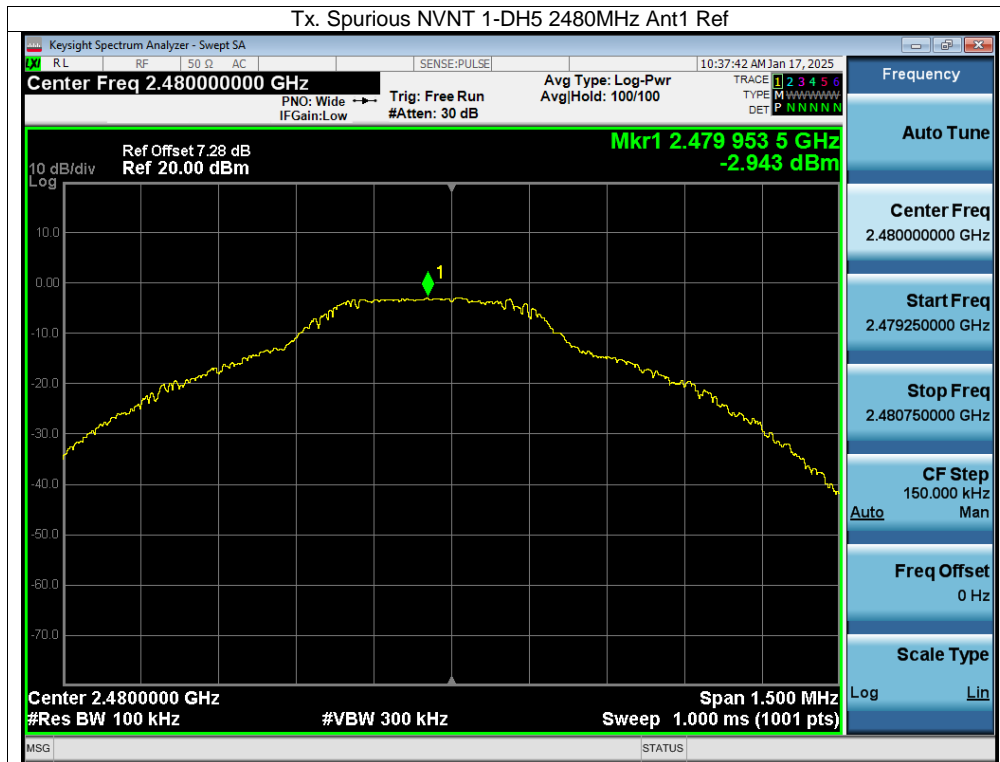

END OF REPORT