



# FCC TEST REPORT

## FCC ID:2A6L4-CP29

**Report Number**..... : ZKT-2501151416E-1

Date of Test..... Jan. 15, 2024 to Feb. 27, 2024

Date of issue..... Feb. 27, 2024

Total number of pages..... 61

Test Result..... : PASS

**Testing Laboratory**..... : Shenzhen ZKT Technology Co., Ltd.

Address ..... : 1/F, No. 101, Building B, No. 6, Tangwei Community Industrial Avenue, Fuhai Street, Bao'an District, Shenzhen, China

**Applicant's name** ..... : Water Monsters LLC

Address ..... : 2309 Trelawney Road, Virginia Beach, VA 23455, United States

**Manufacturer's name** ..... : Hangzhou Chitai Electronic Co., LTD.

Address ..... : Room 902, Floor 9, Building 29, No.535 Shunfeng Road, Donghu Street, Yuhang District, Hangzhou, China 311106

**Test specification:**

Standard..... : FCC CFR Title 47 Part 15 Subpart C Section 15.247  
ANSI C63.10:2013

Test procedure..... : /

Non-standard test method ..... : N/A

**Test Report Form No**..... : TRF-EL-110\_V0

**Test Report Form(s) Originator**..... : ZKT Testing

**Master TRF** ..... : Dated: 2020-01-06

This device described above has been tested by ZKT, and the test results show that the equipment under test (EUT) is in compliance with the FCC requirements. And it is applicable only to the tested sample identified in the report.

This report shall not be reproduced except in full, without the written approval of ZKT, this document may be altered or revised by ZKT, personal only, and shall be noted in the revision of the document.

**Product name**..... : Pace Clock

Trademark ..... : Swimmerd

Model/Type reference..... : CP29  
CP27, CP28, CP30, CP31, CP50, CP99, CP100

Ratings..... : Input: DC 12V, 3A, 36W



**Testing procedure and testing location:**

**Testing Laboratory**.....: **Shenzhen ZKT Technology Co., Ltd.**

**Address**.....: 1/F, No. 101, Building B, No. 6, Tangwei Community Industrial Avenue, Fuhai Street, Bao'an District, Shenzhen, China

**Tested by (name + signature)**.....: Jim.Liu

**Reviewer (name + signature)**.....: Jackson.Fang

**Approved (name + signature)**.....: Lake Xie





Table of Contents

	Page
<b>1. VERSION</b> .....	<b>5</b>
<b>2. SUMMARY OF TEST RESULTS</b> .....	<b>6</b>
2.1 TEST FACILITY .....	7
2.2 MEASUREMENT UNCERTAINTY .....	7
<b>3. GENERAL INFORMATION</b> .....	<b>8</b>
3.1 GENERAL DESCRIPTION OF EUT .....	8
3.2 DESCRIPTION OF TEST MODES .....	9
3.3 BLOCK DIGRAM SHOWING THE CONFIGURATION OF SYSTEM TESTED .....	10
3.4 DESCRIPTION OF SUPPORT UNITS(CONDUCTED MODE) .....	10
3.5EQUIPMENTS LIST FOR ALL TEST ITEMS .....	11
<b>4. EMC EMISSION TEST</b> .....	<b>13</b>
4.1 CONDUCTED EMISSION MEASUREMENT .....	13
4.1.1 POWER LINE CONDUCTED EMISSION Limits .....	13
4.1.2 TEST PROCEDURE .....	13
4.1.3 DEVIATION FROM TEST STANDARD .....	13
4.1.4 TEST SETUP .....	14
4.1.5 EUT OPERATING CONDITIONS .....	14
4.2.1 RADIATED EMISSION LIMITS .....	17
4.2.2 TEST PROCEDURE .....	18
4.2.3 DEVIATION FROM TEST STANDARD .....	18
4.2.4 TEST SETUP .....	18
4.2.5 EUT OPERATING CONDITIONS .....	19
4.2.6 TEST RESULTS .....	19
<b>5.RADIATED BAND EMISSIONMEASUREMENT</b> .....	<b>30</b>
5.1 TEST REQUIREMENT: .....	30
5.2 TEST PROCEDURE .....	30
5.3 DEVIATION FROM TEST STANDARD .....	30
5.4 TEST SETUP .....	31
5.5 EUT OPERATING CONDITIONS .....	31
5.6 TEST RESULT .....	32
<b>6.POWER SPECTRAL DENSITY TEST</b> .....	<b>34</b>
6.1 APPLIED PROCEDURES / LIMIT .....	34
6.2 TEST PROCEDURE .....	34
6.3 DEVIATION FROM STANDARD .....	34
6.4 TEST SETUP .....	34
6.5 EUT OPERATION CONDITIONS .....	34
6.6 TEST RESULT .....	35



- 7. CHANNEL BANDWIDTH OCCUPY BANDWIDTH .....43**
  - 7.1 APPLIED PROCEDURES / LIMIT ..... 43
  - 7.2 TEST PROCEDURE ..... 43
  - 7.3 DEVIATION FROM STANDARD ..... 43
  - 7.4 TEST SETUP .....43
  - 7.5 EUT OPERATION CONDITIONS ..... 43
  - 7.6 TEST RESULT .....44
- 8.PEAK OUTPUT POWER TEST ..... 47**
  - 8.1 APPLIED PROCEDURES/LIMIT ..... 47
  - 8.2 TEST PROCEDURE ..... 47
  - 8.3 DEVIATION FROM STANDARD ..... 47
  - 8.4 TEST SETUP .....47
  - 8.5 EUT OPERATION CONDITIONS ..... 47
  - 8.6 TEST RESULT .....48
- 9. CONDUCTED BAND EDGE AND SPURIOUS EMISSION ..... 49**
  - 9.1 APPLICABLE STANDARD .....49
  - 9.2 TEST PROCEDURE ..... 49
  - 9.3 DEVIATION FROM STANDARD ..... 49
  - 9.4 TEST SETUP .....49
  - 9.5 EUT OPERATION CONDITIONS ..... 49
  - 9.6 TEST RESULTS ..... 49
- 10. DUTY CYCLE .....56**
  - 10.1 APPLIED PROCEDURES / LIMIT ..... 56
  - 10.2 DEVIATION FROM STANDARD ..... 56
  - 10.3 TEST SETUP ..... 56
- 11. ANTENNA REQUIREMENT ..... 60**
- 12. TEST SETUP PHOTO ..... 61**
- 13. EUT CONSTRUCTIONAL DETAILS ..... 61**



**1. VERSION**

ReportNo.	Version	Description	Approved
ZKT-2501151416E-1	Rev.01	Initial issue of report	Feb. 27, 2024



## 2. SUMMARY OF TEST RESULTS

Test procedures according to the technical standards:

FCC Part15 (15.247) , Subpart C			
Standard Section	Test Item	Result	Remark
FCC part 15.203/15.247 (c)	Antenna requirement	PASS	
FCC part 15.207	AC Power Line Conducted Emission	PASS	
FCC part 15.247 (b)(3)	Conducted Peak Output Power	PASS	
FCC part 15.247 (a)(2)	-6dB Channel Bandwidth	PASS	
FCC part 15.247 (e)	Power Spectral Density	PASS	
FCC part 15.247(d)	Band Edge	PASS	
FCC part 15.205/15.209	Spurious Emission	PASS	

NOTE:

(1)" N/A" denotes test is not applicable in this Test Report



## 2.1 TEST FACILITY

Shenzhen ZKT Technology Co., Ltd.  
Add. : 1/F, No. 101, Building B, No. 6, Tangwei Community Industrial Avenue, Fuhai Street, Bao'an District, Shenzhen, China

FCC Test Firm Registration Number: 692225  
Designation Number: CN1299  
IC Registered No.: 27033  
CAB identifier: CN0110

## 2.2 MEASUREMENT UNCERTAINTY

The reported uncertainty of measurement  $y \pm U$  · where expanded uncertainty U is based on a standard uncertainty multiplied by a coverage factor of  $k=2$  · providing a level of confidence of approximately 95 % .

No.	Item	Uncertainty
1	3m chamber Radiated spurious emission(9KHz-30MHz)	U=4.5dB
2	3m chamber Radiated spurious emission(30MHz-1GHz)	U=4.8dB
3	3m chamber Radiated spurious emission(1GHz-6GHz)	U=4.9dB
4	3m chamber Radiated spurious emission(6GHz-40GHz)	U=5.0dB
5	Conducted disturbance	U=3.2dB
6	RF Band Edge	U=1.68dB
7	RF power conducted	U=1.86dB
8	RF conducted Spurious Emission	U=2.2dB
9	RF Occupied Bandwidth	U=1.8MHz
10	RF Power Spectral Density	U=1.75dB
11	humidity uncertainty	U=5.3%
12	Temperature uncertainty	U=0.59°C



### 3. GENERAL INFORMATION

#### 3.1 GENERAL DESCRIPTION OF EUT

Product Name:	Pace Clock
Model No.:	CP29 CP27, CP28, CP30, CP31, CP50, CP99, CP100
Model Different.:	All the model are the same circuit and RF module, except for model name.
Serial No.:	N/A
Sample ID	ZKT-2501151416E-1
Sample(s) Status:	Engineer sample
Channel numbers:	802.11b/802.11g /802.11n(HT20):11 802.11n(HT40):7
Channel separation:	5MHz
Modulation technology:	802.11b: Direct Sequence Spread Spectrum(DSSS) 802.11g/802.11n(H20/H40): Orthogonal Frequency Division Multiplexing(OFDM)
Frequency range:	20M: 2412MHz-2462MHz 40M: 2422MHz-2452MHz
Antenna Type and Antenna gain:	802.11b/g/n20/n40: PBC Antenna Antenna gain: -0.58 dBi
Power Supply:	Input: DC 12V, 3A, 36W
AC/DC Adapter:	Input: AC 100-240V, 50/60Hz, 2A Output: 12V  , 3A
AC/DC Adapter Mode:	NT-2400700D1





Operation Frequency each of channel							
Channel	Frequency	Chann el	Frequency	Chann el	Frequency	Chann el	Frequency
1	2412MHz	4	2427MHz	7	2442MHz	10	2457MHz
2	2417MHz	5	2432MHz	8	2447MHz	11	2462MHz
3	2422MHz	6	2437MHz	9	2452MHz	X	

Note:

In section 15.31(m), regards to the operating frequency range over 10 MHz, the Lowest frequency, the middle frequency, and the highest frequency of channel were selected to perform the test, and the selected channel see below:

Test channel	Frequency (MHz)	
	802.11b/802.11g/802.11n(HT20)	802.11n(HT40)
Lowest channel	2412MHz	2422MHz
Middle channel	2437MHz	2437MHz
Highest channel	2462MHz	2452MHz

### 3.2 DESCRIPTION OF TEST MODES

Transmitting mode	Keep the EUT in continuously transmitting mode
Remark: During the test, the test voltage was tuned from 85% to 115% of the nominal rated supply voltage, and found that the worst case was under the nominal rated supply condition. So the report just shows that condition's data.	

We have verified the construction and function in typical operation. All the test modes were carried out with the EUT in transmitting operation, which was shown in this test report and defined as follows:				
Pre-scan all kind of data rate in lowest channel, and found the follow list which it was worst case.				
Mode	802.11b	802.11g	802.11n(HT20)	802.11n(HT40)
Data rate	1Mbps	6Mbps	6.5Mbps	13Mbps

Test Software	Dbgmon (CMD) Test Tool
Powerlevelsetup	<17dBm



### 3.3 BLOCK DIGRAM SHOWING THE CONFIGURATION OF SYSTEM TESTED

Conducted Emission



Radiated Emission

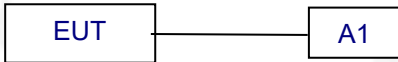

Conducted Spurious

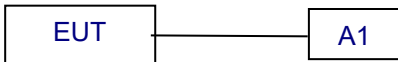

### 3.4 DESCRIPTION OF SUPPORT UNITS(CONDUCTED MODE)

The EUT has been tested as an independent unit together with other necessary accessories or support units. The following support units or accessories were used to form a representative test configuration during the tests.

Item	Equipment	Mfr/Brand	Model/Type No.	Series No.	Note
E-1	Pace Clock	N/A	CP29	N/A	EUT
A1	AC/DC Adapter	N/A	NT-2400700D1	N/A	EUT

Item	Shielded Type	Ferrite Core	Length	Note

Note:

- (1) The support equipment was authorized by Declaration of Confirmation.
- (2) For detachable type I/O cable should be specified the length in cm in 『Length』 column.



### 3.5EQUIPMENTS LIST FOR ALL TEST ITEMS

#### Conduction Emissions Test

Item	Kind of Equipment	Manufacturer	Type No.	Serial No.	Firmware Version	Last calibration	Calibrated until
1	LISN	R&S	ENV216	101471	N/A	Sep. 30, 2024	Sep. 29, 2025
2	LISN	CYBERTEK	EM5040A	E1850400149	N/A	Sep. 30, 2024	Sep. 29, 2025
3	Test Cable	N/A	C-01	N/A	N/A	Sep. 30, 2024	Sep. 29, 2025
4	EMI Test Receiver	R&S	ESCI3	101393	4.42 SP3	Sep. 29, 2024	Sep. 28, 2025
5	EMC Software	Frad	EZ-EMC	Ver.EMC-CON 3A1.1	N/A	\	\

#### Radiation Emissions & Radiation Spurious Emissions Test

Item	Equipment	Manufacturer	Type No.	Serial No.	Firmware Version	Last calibration	Calibrated until
1	Spectrum Analyzer (9kHz-26.5GHz)	KEYSIGHT	N9020A	MY55370835	A.17.05	Sep. 29, 2024	Sep. 28, 2025
2	Spectrum Analyzer (10kHz-39.9GHz)	R&S	FSV40-N	100363	1.71 SP2	Sep. 30, 2024	Sep. 29, 2025
3	EMI Test Receiver (9kHz-7GHz)	R&S	ESCI7	100969	4.32	Sep. 29, 2024	Sep. 28, 2025
4	Bilog Antenna (30MHz-1500MHz)	Schwarzbeck	VULB9168	00877	N/A	Sep. 30, 2024	Sep. 29, 2025
5	Horn Antenna (1GHz-18GHz)	Agilent	AH-118	071145	N/A	Sep. 30, 2024	Sep. 29, 2025
6	Horn Antenna (15GHz-40GHz)	A.H.System	SAS-574	588	N/A	Sep. 30, 2024	Sep. 29, 2025
7	Loop Antenna	TESEQ	HLA6121	58357	N/A	Oct. 11, 2024	Oct. 10, 2025
8	Amplifier (30-1000MHz)	EM Electronics	EM330 Amplifier	60747	N/A	Sep. 29, 2024	Sep. 28, 2025
9	Amplifier (1GHz-26.5GHz)	HuiPu	8449B	3008A00315	N/A	Sep. 29, 2024	Sep. 28, 2025
10	Amplifier (500MHz-40GHz)	QuanJuDa	DLE-161	097	N/A	Sep. 30, 2024	Sep. 29, 2025
11	Test Cable	N/A	R-01	N/A	N/A	Sep. 30, 2024	Sep. 29, 2025
12	Test Cable	N/A	R-02	N/A	N/A	Sep. 30, 2024	Sep. 29, 2025
13	Test Cable	N/A	R-03	N/A	N/A	Sep. 30, 2024	Sep. 29, 2025
14	D.C. Power Supply	LongWei	TPR-6405D	N/A	N/A	Sep. 30, 2024	Sep. 29, 2025
15	EMC Software	Frad	EZ-EMC	Ver.EMC-CO N 3A1.1	N/A	\	\
16	Turntable	MF	MF-7802BS	N/A	N/A	\	\
17	Antenna tower	MF	MF-7802BS	N/A	N/A	\	\



## RF Conducted Test

Item	Equipment	Manufacturer	Type No.	Serial No.	Firmware Version	Last calibration	Calibrated until
1	Spectrum Analyzer (9kHz-26.5GHz)	KEYSIGHT	N9020A	MY55370835	A.17.05	Sep. 29, 2024	Sep. 28, 2025
2	Spectrum Analyzer (10kHz-39.9GHz)	R&S	FSV40-N	100363	1.71 SP2	Sep. 30, 2024	Sep. 29, 2025
3	Test Cable	N/A	RF-01	N/A	N/A	Sep. 30, 2024	Sep. 29, 2025
4	Test Cable	N/A	RF-02	N/A	N/A	Sep. 30, 2024	Sep. 29, 2025
5	Test Cable	N/A	RF-03	N/A	N/A	Sep. 30, 2024	Sep. 29, 2025
6	ESG Signal Generator	Agilent	E4421B	N/A	B.03.84	Sep. 29, 2024	Sep. 28, 2025
7	Signal Generator	Agilent	N5182A	N/A	A.01.87	Sep. 29, 2024	Sep. 28, 2025
8	Magnetic Field Probe Tester	Narda	ELT-400	0-0344/M-1752	N/A	Nov. 16, 2024	Nov. 15, 2025
9	Van der Hoofden measuring head	Schwarzbeck Mess-elektronik	VDHH 9502	9502-039	N/A	Sep. 30, 2024	Sep. 29, 2025
10	Wideband Radio Communication Test	R&S	CMW500	106504	V 3.7.22	Sep. 30, 2024	Sep. 29, 2025
11	Power Meter	KEYSIGHT	N1912A P	N/A	A.05.00	Sep. 30, 2024	Sep. 29, 2025
12	MWRF Power Meter Test system	MW	MW100-RF CB	N/A	N/A	Sep. 29, 2024	Sep. 28, 2025
13	D.C. Power Supply	LongWei	TPR-6405 D	N/A	N/A	Sep. 29, 2024	Sep. 28, 2025
14	RF Software	MW	MTS8310	V2.0.0.0	N/A	\	\



#### 4. EMC EMISSION TEST

##### 4.1 CONDUCTED EMISSION MEASUREMENT

Test Requirement:	FCC Part15 C Section 15.207
Test Method:	ANSI C63.10:2013
Test Frequency Range:	150KHz to 30MHz
Receiver setup:	RBW=9KHz, VBW=30KHz, Sweep time=auto

##### 4.1.1 POWER LINE CONDUCTED EMISSION Limits

FREQUENCY (MHz)	Limit (dBuV)		Standard
	Quasi-peak	Average	
0.15 -0.5	66 - 56 *	56 - 46 *	FCC
0.50 -5.0	56.00	46.00	FCC
5.0 -30.0	60.00	50.00	FCC

Note:

(1) \*Decreases with the logarithm of the frequency.

##### 4.1.2 TEST PROCEDURE

- a. The EUT was placed 0.8 meters from the horizontal ground plane with EUT being connected to the power mains through a line impedance stabilization network (LISN). All other support equipments powered from additional LISN(s). The LISN provide 50 Ohm/ 50uH of coupling impedance for the measuring instrument.
- b. Interconnecting cables that hang closer than 40 cm to the ground plane shall be folded back and forth in the center forming a bundle 30 to 40 cm long.
- c. I/O cables that are not connected to a peripheral shall be bundled in the center. The end of the cable may be terminated, if required, using the correct terminating impedance. The overall length shall not exceed 1 m.
- d. LISN at least 80 cm from nearest part of EUT chassis.
- e. For the actual test configuration, please refer to the related Item –EUT Test Photos.

##### 4.1.3 DEVIATION FROM TEST STANDARD

No deviation



#### 4.1.4 TEST SETUP

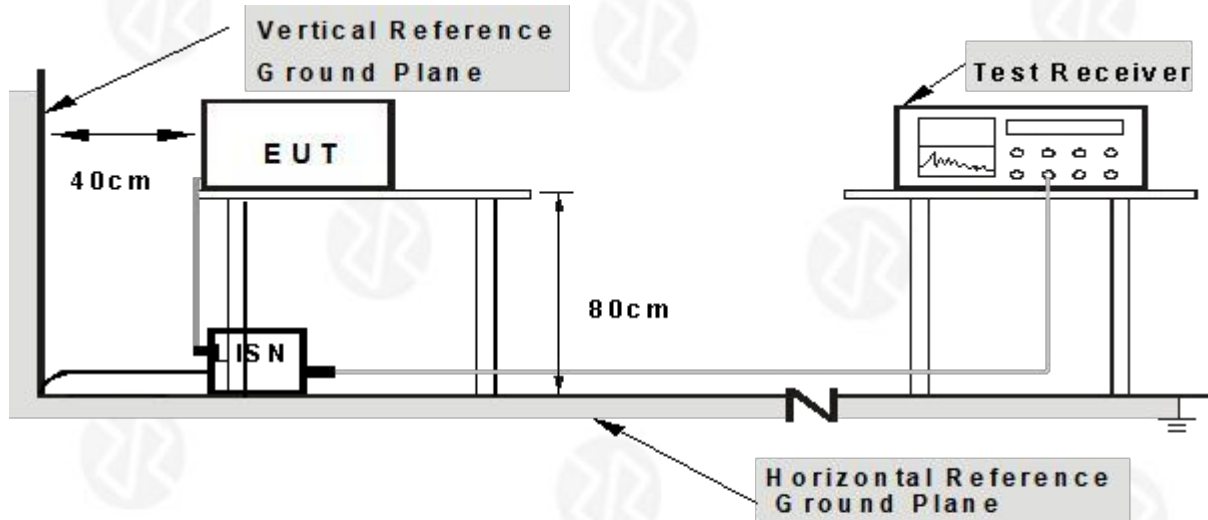

- Note: 1. Support units were connected to second LISN.**  
**2. Both of LISNs (AMN) are 80 cm from EUT and at least 80 cm from other units and other metal planes**

#### 4.1.5 EUT OPERATING CONDITIONS

The EUT was configured for testing in a typical fashion (as a customer would normally use it). The EUT has been programmed to continuously transmit during test. This operating condition was tested and used to collect the included data.

We pretest AC 120V and AC 230V, the worst voltage was AC 120V and the data recording in the report.



4.1.6 Test Result

Temperature:	26°C	Relative Humidity:	54%
Pressure:	101 kPa	Polarization:	L
Test Voltage:	AC 120V/60Hz		

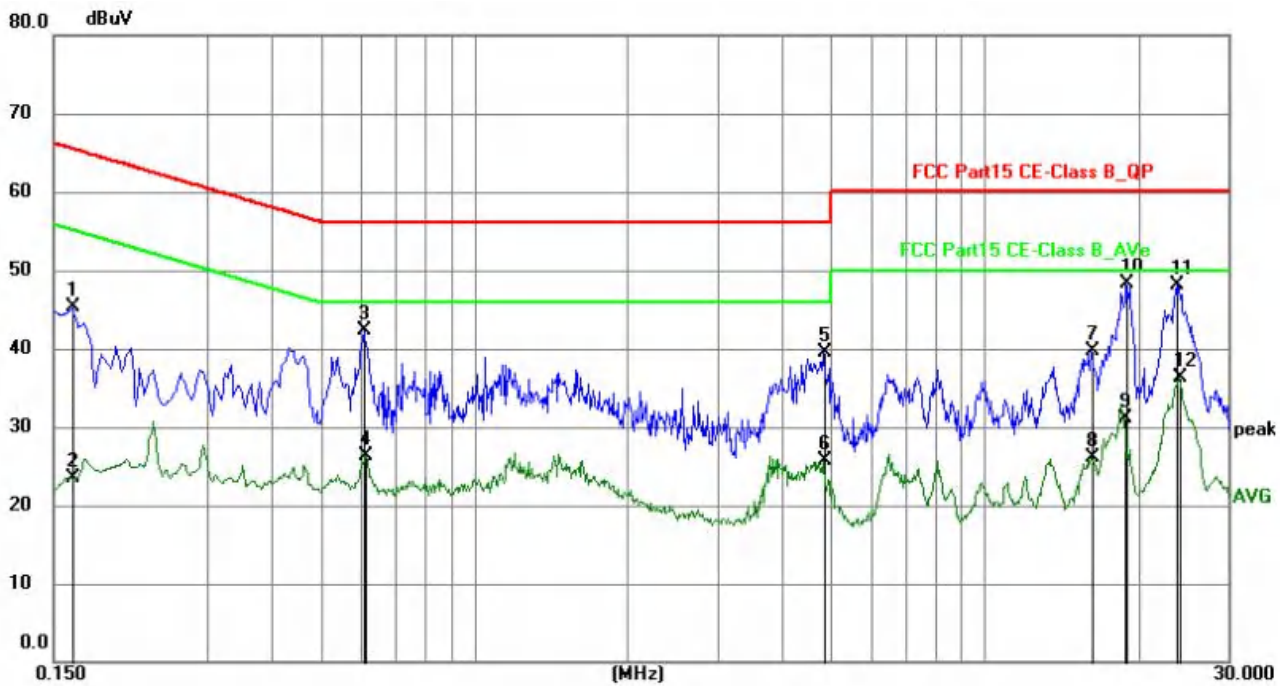

No.	Frequency (MHz)	Reading (dBuV)	Factor (dB)	Level (dBuV)	Limit (dBuV)	Margin (dB)	Detector	P/F	Remark
1	0.1635	24.33	20.89	45.22	65.28	-20.06	QP	P	
2	0.1641	2.54	20.89	23.43	55.25	-31.82	AVG	P	
3	0.6089	21.43	20.87	42.30	56.00	-13.70	QP	P	
4	0.6134	5.47	20.87	26.34	46.00	-19.66	AVG	P	
5	4.8480	18.17	21.24	39.41	56.00	-16.59	QP	P	
6	4.8480	4.51	21.24	25.75	46.00	-20.25	AVG	P	
7	16.1790	16.53	23.11	39.64	60.00	-20.36	QP	P	
8	16.1790	3.09	23.11	26.20	50.00	-23.80	AVG	P	
9	18.7260	7.64	23.55	31.19	50.00	-18.81	AVG	P	
10	18.9420	24.68	23.60	48.28	60.00	-11.72	QP	P	
11	23.8380	23.79	24.37	48.16	60.00	-11.84	QP	P	
12	24.0540	11.80	24.41	36.21	50.00	-13.79	AVG	P	

Notes:

1. An initial pre-scan was performed on the line and neutral lines with peak detector.
2. Quasi-Peak and Average measurement were performed at the frequencies with maximized peak emission.
3. Measurement Level = Reading level + Correct Factor
4. The test data shows only the worst case 802.11g 2437MHz



Temperature:	26°C	Relative Humidity:	54%
Pressure:	101 kPa	Polarization:	N
Test Voltage:	AC 120V/60Hz		

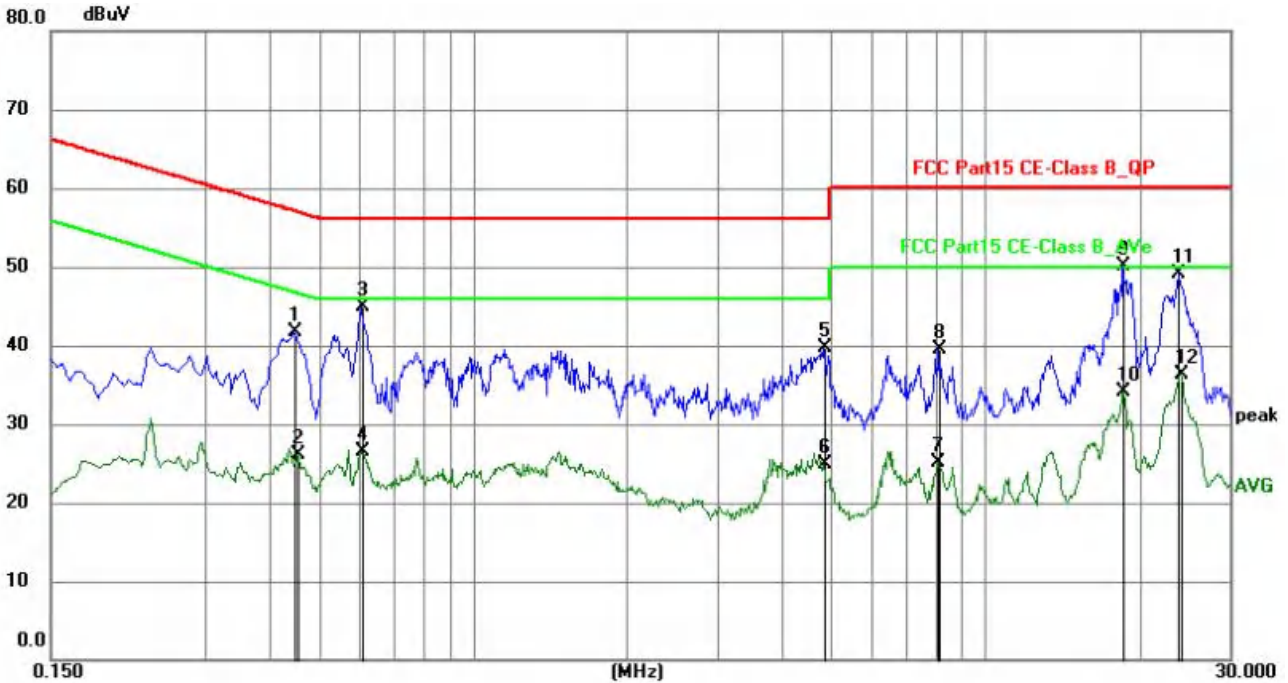

No.	Frequency (MHz)	Reading (dBuV)	Factor (dB)	Level (dBuV)	Limit (dBuV)	Margin (dB)	Detector	P/F	Remark
1	0.4470	20.83	20.90	41.73	56.93	-15.20	QP	P	
2	0.4560	5.14	20.89	26.03	46.77	-20.74	AVG	P	
3	0.6044	23.98	20.83	44.81	56.00	-11.19	QP	P	
4	0.6044	5.76	20.83	26.59	46.00	-19.41	AVG	P	
5	4.8480	18.47	21.18	39.65	56.00	-16.35	QP	P	
6	4.8480	3.71	21.18	24.89	46.00	-21.11	AVG	P	
7	8.0925	3.45	21.65	25.10	50.00	-24.90	AVG	P	
8	8.1420	17.84	21.66	39.50	60.00	-20.50	QP	P	
9	18.5505	26.62	23.46	50.08	60.00	-9.92	QP	P	
10	18.5505	10.63	23.46	34.09	50.00	-15.91	AVG	P	
11	23.7930	24.82	24.32	49.14	60.00	-10.86	QP	P	
12	24.0450	11.88	24.36	36.24	50.00	-13.76	AVG	P	

Notes:

1. An initial pre-scan was performed on the line and neutral lines with peak detector.
2. Quasi-Peak and Average measurement were performed at the frequencies with maximized peak emission.
3. Measurement Level = Reading level + Correct Factor
4. The test data shows only the worst case 802.11g 2437MHz





#### 4.2 RADIATED EMISSION MEASUREMENT

Test Requirement:	FCC Part15 C Section 15.209				
Test Method:	ANSI C63.10:2013				
Test Frequency Range:	9kHz to 25GHz				
Test site:	Measurement Distance: 3m				
Receiver setup:	Frequency	Detector	RBW	VBW	Value
	9KHz-150KHz	Quasi-peak	200Hz	600Hz	Quasi-peak
	150KHz-30MHz	Quasi-peak	9KHz	30KHz	Quasi-peak
	30MHz-1GHz	Quasi-peak	100KHz	300KHz	Quasi-peak
	Above 1GHz	Peak	1MHz	3MHz	Peak
Peak		1MHz	10Hz	Average	

#### 4.2.1 RADIATED EMISSION LIMITS

Frequencies (MHz)	Field Strength (micorvolts/meter)	Measurement Distance (meters)
0.009~0.490	2400/F(KHz)	300
0.490~1.705	24000/F(KHz)	30
1.705~30.0	30	30
30~88	100	3
88~216	150	3
216~960	200	3
Above 960	500	3

#### LIMITS OF RADIATED EMISSION MEASUREMENT

FREQUENCY (MHz)	Limit (dBuV/m) (at 3M)	
	PEAK	AVERAGE
Above 1000	74	54

Notes:

- (1) The limit for radiated test was performed according to FCC PART 15C.
- (2) The tighter limit applies at the band edges.
- (3) Emission level (dBuV/m)=20log Emission level (uV/m).



#### 4.2.2 TEST PROCEDURE

Below 1GHz test procedure as below:

- a. The EUT was placed on the top of a rotating table 0.8 meters above the ground at a 3 meter semi-anechoic chamber. The table was rotated 360 degrees to determine the position of the highest radiation.
- b. The EUT was set 3 meters away from the interference-receiving antenna, which was mounted on the top of a variable-height antenna tower.
- c. The antenna height is varied from one meter to four meters above the ground to determine the maximum value of the field strength. Both horizontal and vertical polarizations of the antenna are set to make the measurement.
- d. For each suspected emission, the EUT was arranged to its worst case and then the antenna was tuned to heights from 1 meter to 4 meters (for the test frequency of below 30MHz, the antenna was tuned to heights 1 meter) and the rotatable table was turned from 0 degrees to 360 degrees to find the maximum reading.
- e. The test-receiver system was set to Peak Detect Function and Specified Bandwidth with Maximum Hold Mode.
- f. If the emission level of the EUT in peak mode was 10dB lower than the limit specified, then testing could be stopped and the peak values of the EUT would be reported. Otherwise the emissions that did not have 10dB margin would be re-tested one by one using peak, quasi-peak or average method as specified and then reported in a data sheet.

Above 1GHz test procedure as below:

- g. Different from above is the test site, change from Semi-Anechoic Chamber to fully Anechoic Chamber and change from table 0.8 meter to 1.5 meter (Above 18GHz the distance is 1 meter and table is 1.5 meter).
- h. Test the EUT in the lowest channel, the middle channel, the Highest channel

Note:

Both horizontal and vertical antenna polarities were tested and performed pretest to three orthogonal axis. The worst case emissions were reported

#### 4.2.3 DEVIATION FROM TEST STANDARD

No deviation

#### 4.2.4 TEST SETUP

(A) Radiated Emission Test-Up Frequency Below 30MHz

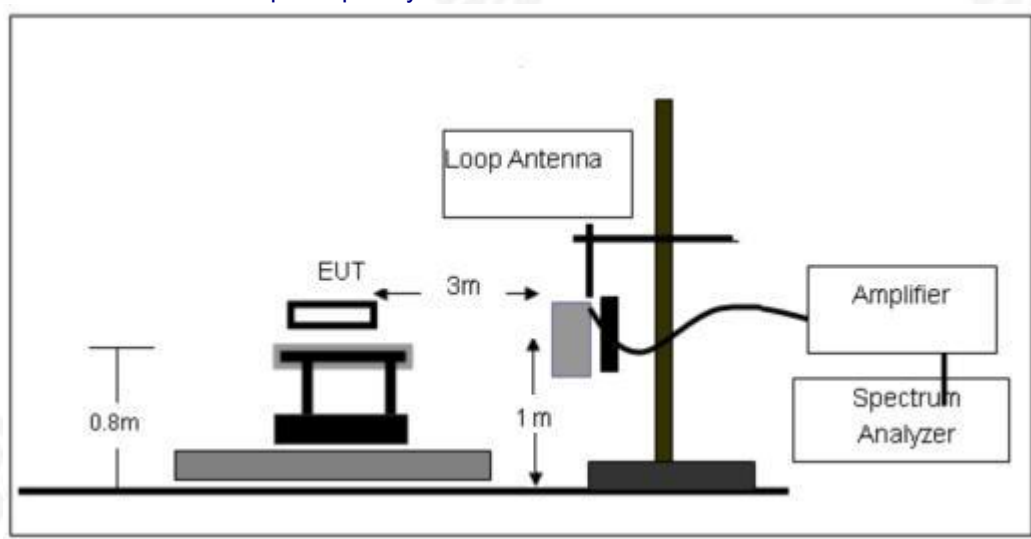



(B) Radiated Emission Test-Up Frequency 30MHz~1GHz

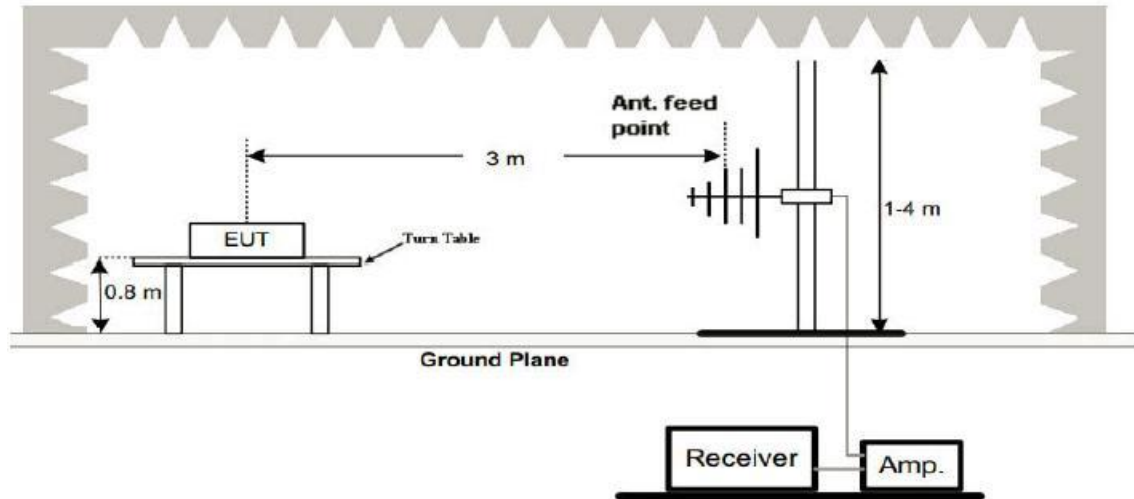

(C) Radiated Emission Test-Up Frequency Above 1GHz

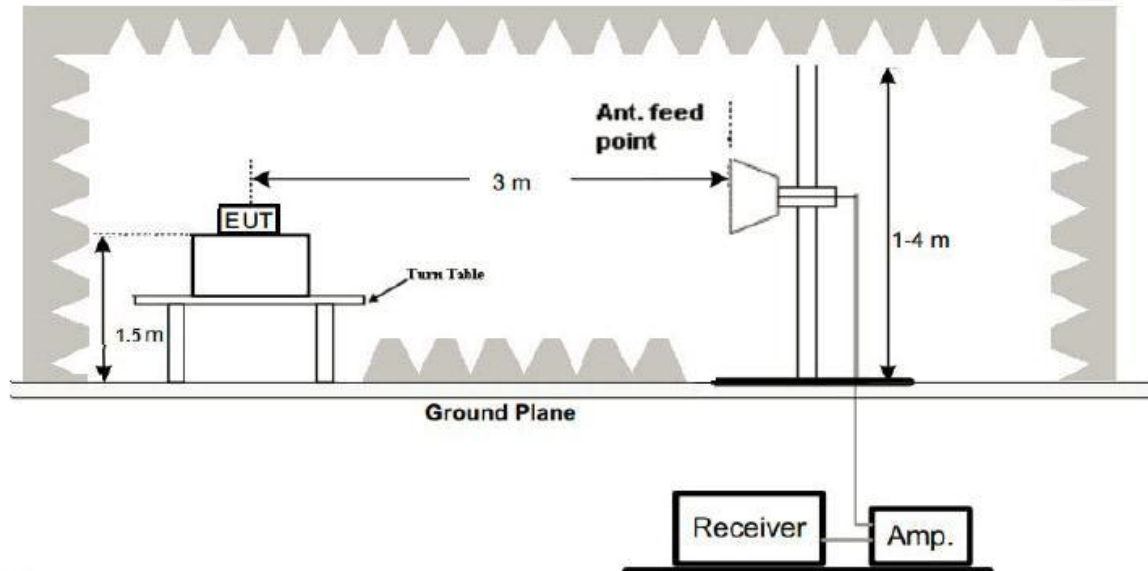

#### 4.2.5 EUT OPERATING CONDITIONS

The EUT tested system was configured as the statements of 2.4 Unless otherwise a special operating condition is specified in the follows during the testing.

#### 4.2.6 TEST RESULTS

Between 9KHz – 30MHz

The emission from 9 kHz to 30MHz was pre-tested and found the result was 20dB lower than the limit, and according to 15.31(o) & RSS-Gen 6.13, the test result no need to reported.



Between 30MHz – 1GHz

Temperature:	26°C	Relative Humidity:	54%
Pressure:	101 kPa	Polarization:	Horizontal
Test Voltage:	AC 120V/60Hz	Test Mode	802.11g 2437MHz

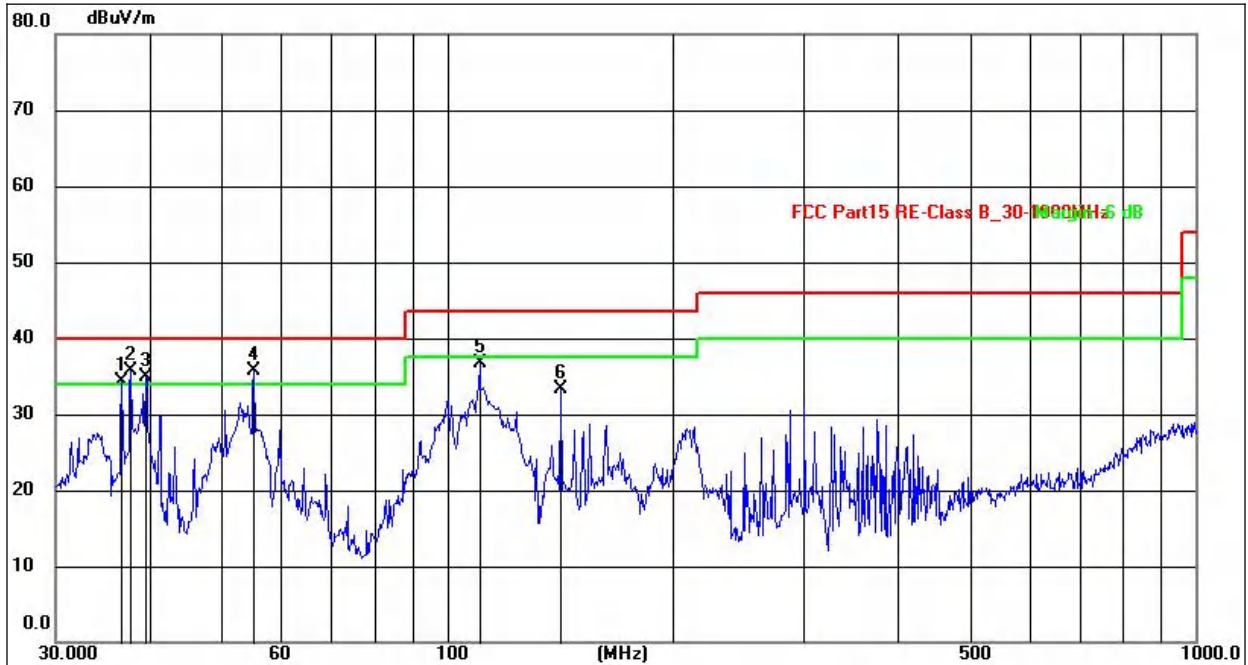

No.	Frequency (MHz)	Reading (dBuV)	Factor (dB/m)	Level (dBuV/m)	Limit (dBuV/m)	Margin (dB)	Detector
1	36.7661	51.66	-17.34	34.32	40.00	-5.68	QP
2	37.8121	52.90	-17.19	35.71	40.00	-4.29	QP
3	39.5756	51.91	-16.93	34.98	40.00	-5.02	QP
4	55.2207	53.45	-17.82	35.63	40.00	-4.37	QP
5	110.5686	58.07	-21.30	36.77	43.50	-6.73	QP
6	141.8262	54.18	-20.86	33.32	43.50	-10.18	QP

## Remarks:

1. Final Level = Receiver Read level + Antenna Factor + Cable Loss – Preamplifier Factor
2. The emission levels of other frequencies are very lower than the limit and not show in test report.
3. The test data shows only the worst case 802.11g 2437MHz



Temperature:	26°C	Relative Humidity:	54%
Pressure:	101kPa	Polarization:	Vertical
Test Voltage:	AC 120V/60Hz	Test Mode	802.11g 2437MHz

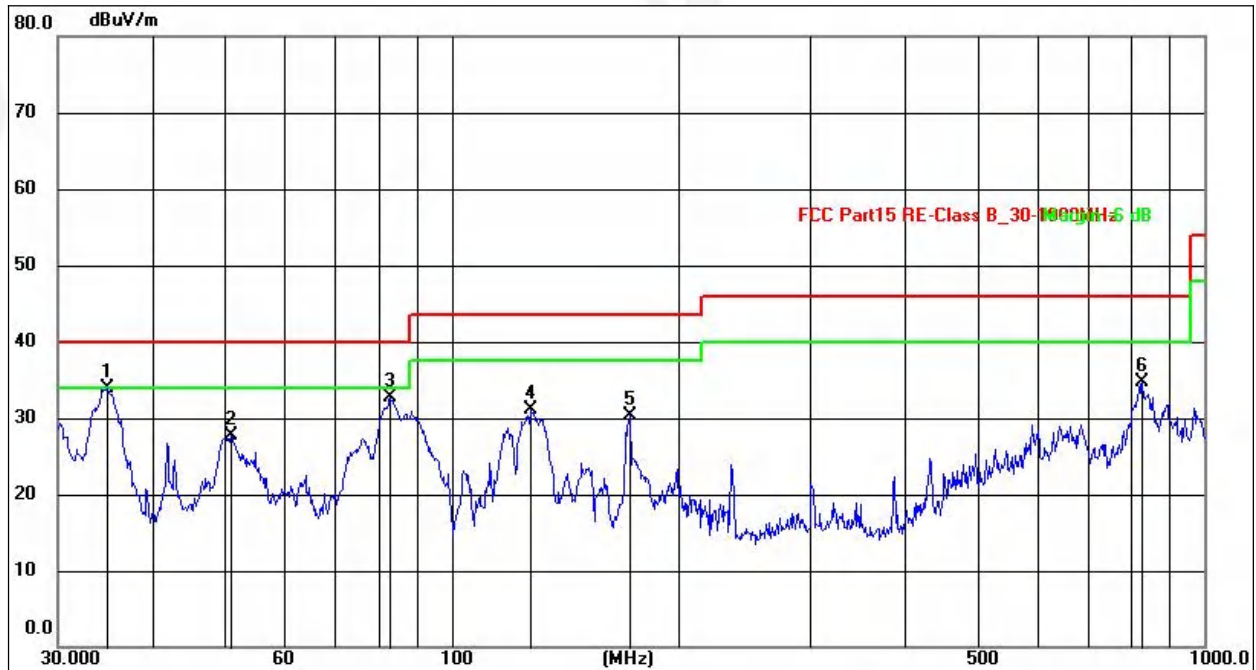

No.	Frequency (MHz)	Reading (dBuV)	Factor (dB/m)	Level (dBuV/m)	Limit (dBuV/m)	Margin (dB)	Detector
1	34.8821	51.43	-17.62	33.81	40.00	-6.19	QP
2	50.9417	45.11	-17.38	27.73	40.00	-12.27	QP
3	82.9384	54.37	-21.76	32.61	40.00	-7.39	QP
4	127.2176	52.39	-21.21	31.18	43.50	-12.32	QP
5	172.5987	50.35	-19.97	30.38	43.50	-13.12	QP
6	827.4932	37.54	-2.80	34.74	46.00	-11.26	QP

## Remarks:

1. Final Level = Receiver Read level + Antenna Factor + Cable Loss – Preamplifier Factor
2. The emission levels of other frequencies are very lower than the limit and not show in test report.
3. The test data shows only the worst case 802.11g 2437MHz



1GHz~25GHz

802.11b

Polar (H/V)	Frequency	Meter Reading	Pre-amplifier	Cable Loss	Antenna Factor	Emission Level	Limits	Margin	Detect or Type
	(MHz)	(dBuV)	(dB)	(dB)	(dB)	(dBuV/m)	(dBuV/m)	(dB)	
Low Channel:2412MHz									
V	4824.00	51.77	30.55	5.77	24.66	51.65	74.00	-22.35	PK
V	4824.00	43.05	30.55	5.77	24.66	42.93	54.00	-11.07	AV
V	7236.00	53.73	30.33	6.32	24.55	54.27	74.00	-19.73	PK
V	7236.00	43.32	30.33	6.32	24.55	43.86	54.00	-10.14	AV
V	9648.00	52.54	30.85	7.45	24.69	53.83	74.00	-20.17	PK
V	9648.00	43.50	30.85	7.45	24.69	44.79	54.00	-9.21	AV
V	12060.00	54.74	31.02	8.99	25.57	58.28	74.00	-15.72	PK
V	12060.00	43.87	31.02	8.99	25.57	47.41	54.00	-6.59	AV
H	4824.00	53.14	30.55	5.77	24.66	53.02	74.00	-20.98	PK
H	4824.00	43.40	30.55	5.77	24.66	43.28	54.00	-10.72	AV
H	7236.00	54.85	30.33	6.32	24.55	55.39	74.00	-18.61	PK
H	7236.00	43.42	30.33	6.32	24.55	43.96	54.00	-10.04	AV
H	9648.00	51.44	30.85	7.45	24.69	52.73	74.00	-21.27	PK
H	9648.00	43.33	30.85	7.45	24.69	44.62	54.00	-9.38	AV
H	12060.00	52.91	31.02	8.99	25.57	56.45	74.00	-17.55	PK
H	12060.00	43.52	31.02	8.99	25.57	47.06	54.00	-6.94	AV

Polar (H/V)	Frequency	Meter Reading	Pre-amplifier	Cable Loss	Antenna Factor	Emission Level	Limits	Margin	Detect or Type
	(MHz)	(dBuV)	(dB)	(dB)	(dB)	(dBuV/m)	(dBuV/m)	(dB)	
Middle Channel:2437MHz									
V	4874.00	54.64	30.55	5.77	24.66	54.52	74.00	-19.48	PK
V	4874.00	43.47	30.55	5.77	24.66	43.35	54.00	-10.65	AV
V	7311.00	51.92	30.33	6.32	24.55	52.46	74.00	-21.54	PK
V	7311.00	43.70	30.33	6.32	24.55	44.24	54.00	-9.76	AV
V	9748.00	51.70	30.85	7.45	24.69	52.99	74.00	-21.01	PK
V	9748.00	43.25	30.85	7.45	24.69	44.54	54.00	-9.46	AV
V	12185.00	52.72	31.02	8.99	25.57	56.26	74.00	-17.74	PK
V	12185.00	43.04	31.02	8.99	25.57	46.58	54.00	-7.42	AV
H	4874.00	52.32	30.55	5.77	24.66	52.20	74.00	-21.80	PK
H	4874.00	43.12	30.55	5.77	24.66	43.00	54.00	-11.00	AV
H	7311.00	54.60	30.33	6.32	24.55	55.14	74.00	-18.86	PK
H	7311.00	43.62	30.33	6.32	24.55	44.16	54.00	-9.84	AV
H	9748.00	52.70	30.85	7.45	24.69	53.99	74.00	-20.01	PK
H	9748.00	43.20	30.85	7.45	24.69	44.49	54.00	-9.51	AV
H	12185.00	54.70	31.02	8.99	25.57	58.24	74.00	-15.76	PK
H	12185.00	43.82	31.02	8.99	25.57	47.36	54.00	-6.64	AV



Polar (H/V)	Frequency	Meter Reading	Pre-ampli fier	Cable Loss	Antenna Factor	Emission Level	Limits	Margin	Detect or Type
	(MHz)	(dBuV)	(dB)	(dB)	(dB)	(dBuV/m)	(dBuV/ m)	(dB)	
High Channel:2462MHz									
V	4924.00	51.70	30.55	5.77	24.66	51.58	74.00	-22.42	PK
V	4924.00	43.59	30.55	5.77	24.66	43.47	54.00	-10.53	AV
V	7386.00	50.70	30.33	6.32	24.55	51.24	74.00	-22.76	PK
V	7386.00	43.17	30.33	6.32	24.55	43.71	54.00	-10.29	AV
V	9848.00	52.09	30.85	7.45	24.69	53.38	74.00	-20.62	PK
V	9848.00	43.38	30.85	7.45	24.69	44.67	54.00	-9.33	AV
V	12310.00	50.90	31.02	8.99	25.57	54.44	74.00	-19.56	PK
V	12310.00	43.56	31.02	8.99	25.57	47.10	54.00	-6.90	AV
H	4924.00	53.13	30.55	5.77	24.66	53.01	74.00	-20.99	PK
H	4924.00	43.30	30.55	5.77	24.66	43.18	54.00	-10.82	AV
H	7386.00	52.44	30.33	6.32	24.55	52.98	74.00	-21.02	PK
H	7386.00	43.30	30.33	6.32	24.55	43.84	54.00	-10.16	AV
H	9848.00	54.73	30.85	7.45	24.69	56.02	74.00	-17.98	PK
H	9848.00	43.03	30.85	7.45	24.69	44.32	54.00	-9.68	AV
H	12310.00	54.69	31.02	8.99	25.57	58.23	74.00	-15.77	PK
H	12310.00	43.20	31.02	8.99	25.57	46.74	54.00	-7.26	AV

## Remark:

1. Emission Level = Meter Reading + Antenna Factor + Cable Loss – Pre-amplifier,  
Margin= Emission Level - Limit
2. If peak below the average limit, the average emission was no test.
3. The amplitude of spurious emissions which are attenuated by more than 20dB below the permissible value has no need to be reported.



802.11g

Polar (H/V)	Frequency	Meter Reading	Pre-amplifier	Cable Loss	Antenna Factor	Emission Level	Limits	Margin	Detect or Type
	(MHz)	(dBuV)	(dB)	(dB)	(dB)	(dBuV/m)	(dBuV/m)	(dB)	
Low Channel:2412MHz									
V	4824.00	52.90	30.55	5.77	24.66	52.78	74.00	-21.22	PK
V	4824.00	43.82	30.55	5.77	24.66	43.70	54.00	-10.30	AV
V	7236.00	51.71	30.33	6.32	24.55	52.25	74.00	-21.75	PK
V	7236.00	43.03	30.33	6.32	24.55	43.57	54.00	-10.43	AV
V	9648.00	53.47	30.85	7.45	24.69	54.76	74.00	-19.24	PK
V	9648.00	43.34	30.85	7.45	24.69	44.63	54.00	-9.37	AV
V	12060.00	50.88	31.02	8.99	25.57	54.42	74.00	-19.58	PK
V	12060.00	43.51	31.02	8.99	25.57	47.05	54.00	-6.95	AV
H	4824.00	51.56	30.55	5.77	24.66	51.44	74.00	-22.56	PK
H	4824.00	43.96	30.55	5.77	24.66	43.84	54.00	-10.16	AV
H	7236.00	51.10	30.33	6.32	24.55	51.64	74.00	-22.36	PK
H	7236.00	43.17	30.33	6.32	24.55	43.71	54.00	-10.29	AV
H	9648.00	52.70	30.85	7.45	24.69	53.99	74.00	-20.01	PK
H	9648.00	43.57	30.85	7.45	24.69	44.86	54.00	-9.14	AV
H	12060.00	51.49	31.02	8.99	25.57	55.03	74.00	-18.97	PK
H	12060.00	43.80	31.02	8.99	25.57	47.34	54.00	-6.66	AV

Polar (H/V)	Frequency	Meter Reading	Pre-amplifier	Cable Loss	Antenna Factor	Emission Level	Limits	Margin	Detect or Type
	(MHz)	(dBuV)	(dB)	(dB)	(dB)	(dBuV/m)	(dBuV/m)	(dB)	
Middle Channel:2437MHz									
V	4874.00	53.67	30.55	5.77	24.66	53.55	74.00	-20.45	PK
V	4874.00	43.78	30.55	5.77	24.66	43.66	54.00	-10.34	AV
V	7311.00	53.36	30.33	6.32	24.55	53.90	74.00	-20.10	PK
V	7311.00	43.16	30.33	6.32	24.55	43.70	54.00	-10.30	AV
V	9748.00	53.16	30.85	7.45	24.69	54.45	74.00	-19.55	PK
V	9748.00	43.79	30.85	7.45	24.69	45.08	54.00	-8.92	AV
V	12185.00	52.48	31.02	8.99	25.57	56.02	74.00	-17.98	PK
V	12185.00	43.52	31.02	8.99	25.57	47.06	54.00	-6.94	AV
H	4874.00	50.34	30.55	5.77	24.66	50.22	74.00	-23.78	PK
H	4874.00	43.03	30.55	5.77	24.66	42.91	54.00	-11.09	AV
H	7311.00	51.11	30.33	6.32	24.55	51.65	74.00	-22.35	PK
H	7311.00	43.13	30.33	6.32	24.55	43.67	54.00	-10.33	AV
H	9748.00	54.10	30.85	7.45	24.69	55.39	74.00	-18.61	PK
H	9748.00	43.94	30.85	7.45	24.69	45.23	54.00	-8.77	AV
H	12185.00	50.69	31.02	8.99	25.57	54.23	74.00	-19.77	PK
H	12185.00	43.06	31.02	8.99	25.57	46.60	54.00	-7.40	AV





Polar (H/V)	Frequency	Meter Reading	Pre-ampl ifier	Cable Loss	Antenna Factor	Emission Level	Limits	Margin	Detect or Type
	(MHz)	(dBuV)	(dB)	(dB)	(dB)	(dBuV/m)	(dBuV/ m)	(dB)	
High Channel:2462MHz									
V	4924.00	53.97	30.55	5.77	24.66	53.85	74.00	-20.15	PK
V	4924.00	43.18	30.55	5.77	24.66	43.06	54.00	-10.94	AV
V	7386.00	50.79	30.33	6.32	24.55	51.33	74.00	-22.67	PK
V	7386.00	43.05	30.33	6.32	24.55	43.59	54.00	-10.41	AV
V	9848.00	53.67	30.85	7.45	24.69	54.96	74.00	-19.04	PK
V	9848.00	43.37	30.85	7.45	24.69	44.66	54.00	-9.34	AV
V	12310.00	50.53	31.02	8.99	25.57	54.07	74.00	-19.93	PK
V	12310.00	43.50	31.02	8.99	25.57	47.04	54.00	-6.96	AV
H	4924.00	51.80	30.55	5.77	24.66	51.68	74.00	-22.32	PK
H	4924.00	43.41	30.55	5.77	24.66	43.29	54.00	-10.71	AV
H	7386.00	51.97	30.33	6.32	24.55	52.51	74.00	-21.49	PK
H	7386.00	43.64	30.33	6.32	24.55	44.18	54.00	-9.82	AV
H	9848.00	51.42	30.85	7.45	24.69	52.71	74.00	-21.29	PK
H	9848.00	43.09	30.85	7.45	24.69	44.38	54.00	-9.62	AV
H	12310.00	50.95	31.02	8.99	25.57	54.49	74.00	-19.51	PK
H	12310.00	43.20	31.02	8.99	25.57	46.74	54.00	-7.26	AV

## Remark:

1. Emission Level = Meter Reading + Antenna Factor + Cable Loss – Pre-amplifier,  
Margin= Emission Level - Limit
2. If peak below the average limit, the average emission was no test.
3. The amplitude of spurious emissions which are attenuated by more than 20dB below the permissible value has no need to be reported.



## 802.11n20

Polar (H/V)	Frequency	Meter Reading	Pre-ampl ifier	Cable Loss	Antenna Factor	Emission Level	Limits	Margin	Detect or Type
	(MHz)	(dBuV)	(dB)	(dB)	(dB)	(dBuV/m)	(dBuV/ m)	(dB)	
Low Channel:2412MHz									
V	4824.00	51.50	30.55	5.77	24.66	51.38	74.00	-22.62	PK
V	4824.00	43.44	30.55	5.77	24.66	43.32	54.00	-10.68	AV
V	7236.00	50.61	30.33	6.32	24.55	51.15	74.00	-22.85	PK
V	7236.00	44.00	30.33	6.32	24.55	44.54	54.00	-9.46	AV
V	9648.00	51.16	30.85	7.45	24.69	52.45	74.00	-21.55	PK
V	9648.00	43.59	30.85	7.45	24.69	44.88	54.00	-9.12	AV
V	12060.00	50.20	31.02	8.99	25.57	53.74	74.00	-20.26	PK
V	12060.00	43.90	31.02	8.99	25.57	47.44	54.00	-6.56	AV
H	4824.00	54.69	30.55	5.77	24.66	54.57	74.00	-19.43	PK
H	4824.00	43.51	30.55	5.77	24.66	43.39	54.00	-10.61	AV
H	7236.00	50.28	30.33	6.32	24.55	50.82	74.00	-23.18	PK
H	7236.00	43.08	30.33	6.32	24.55	43.62	54.00	-10.38	AV
H	9648.00	53.72	30.85	7.45	24.69	55.01	74.00	-18.99	PK
H	9648.00	43.60	30.85	7.45	24.69	44.89	54.00	-9.11	AV
H	12060.00	52.91	31.02	8.99	25.57	56.45	74.00	-17.55	PK
H	12060.00	43.25	31.02	8.99	25.57	46.79	54.00	-7.21	AV

Polar (H/V)	Frequency	Meter Reading	Pre-ampl ifier	Cable Loss	Antenna Factor	Emission Level	Limits	Margin	Detect or Type
	(MHz)	(dBuV)	(dB)	(dB)	(dB)	(dBuV/m)	(dBuV/ m)	(dB)	
Middle Channel:2437MHz									
V	4874.00	51.76	30.55	5.77	24.66	51.64	74.00	-22.36	PK
V	4874.00	43.85	30.55	5.77	24.66	43.73	54.00	-10.27	AV
V	7311.00	54.40	30.33	6.32	24.55	54.94	74.00	-19.06	PK
V	7311.00	43.68	30.33	6.32	24.55	44.22	54.00	-9.78	AV
V	9748.00	50.02	30.85	7.45	24.69	51.31	74.00	-22.69	PK
V	9748.00	43.62	30.85	7.45	24.69	44.91	54.00	-9.09	AV
V	12185.00	53.94	31.02	8.99	25.57	57.48	74.00	-16.52	PK
V	12185.00	43.37	31.02	8.99	25.57	46.91	54.00	-7.09	AV
H	4874.00	53.93	30.55	5.77	24.66	53.81	74.00	-20.19	PK
H	4874.00	43.90	30.55	5.77	24.66	43.78	54.00	-10.22	AV
H	7311.00	50.03	30.33	6.32	24.55	50.57	74.00	-23.43	PK
H	7311.00	43.07	30.33	6.32	24.55	43.61	54.00	-10.39	AV
H	9748.00	53.20	30.85	7.45	24.69	54.49	74.00	-19.51	PK
H	9748.00	43.98	30.85	7.45	24.69	45.27	54.00	-8.73	AV
H	12185.00	51.12	31.02	8.99	25.57	54.66	74.00	-19.34	PK
H	12185.00	43.92	31.02	8.99	25.57	47.46	54.00	-6.54	AV



Polar (H/V)	Frequency	Meter Reading	Pre-ampl ifier	Cable Loss	Antenna Factor	Emission Level	Limits	Margin	Detect or Type
	(MHz)	(dBuV)	(dB)	(dB)	(dB)	(dBuV/m)	(dBuV/ m)	(dB)	
High Channel:2462MHz									
V	4924.00	50.37	30.55	5.77	24.66	50.25	74.00	-23.75	PK
V	4924.00	43.47	30.55	5.77	24.66	43.35	54.00	-10.65	AV
V	7386.00	51.44	30.33	6.32	24.55	51.98	74.00	-22.02	PK
V	7386.00	43.52	30.33	6.32	24.55	44.06	54.00	-9.94	AV
V	9848.00	50.67	30.85	7.45	24.69	51.96	74.00	-22.04	PK
V	9848.00	43.52	30.85	7.45	24.69	44.81	54.00	-9.19	AV
V	12310.00	51.95	31.02	8.99	25.57	55.49	74.00	-18.51	PK
V	12310.00	43.72	31.02	8.99	25.57	47.26	54.00	-6.74	AV
H	4924.00	52.55	30.55	5.77	24.66	52.43	74.00	-21.57	PK
H	4924.00	43.73	30.55	5.77	24.66	43.61	54.00	-10.39	AV
H	7386.00	51.26	30.33	6.32	24.55	51.80	74.00	-22.20	PK
H	7386.00	43.44	30.33	6.32	24.55	43.98	54.00	-10.02	AV
H	9848.00	51.76	30.85	7.45	24.69	53.05	74.00	-20.95	PK
H	9848.00	43.15	30.85	7.45	24.69	44.44	54.00	-9.56	AV
H	12310.00	53.96	31.02	8.99	25.57	57.50	74.00	-16.50	PK
H	12310.00	43.51	31.02	8.99	25.57	47.05	54.00	-6.95	AV

## Remark:

1. Emission Level = Meter Reading + Antenna Factor + Cable Loss – Pre-amplifier,

Margin= Emission Level - Limit

2. If peak below the average limit, the average emission was no test.

3. The amplitude of spurious emissions which are attenuated by more than 20dB below the permissible value has no need to be reported.



802.11n40

Polar (H/V)	Frequency	Meter Reading	Pre-amplifier	Cable Loss	Antenna Factor	Emission Level	Limits	Margin	Detect or Type
	(MHz)	(dBuV)	(dB)	(dB)	(dB)	(dBuV/m)	(dBuV/m)	(dB)	
Low Channel:2422MHz									
V	4844.00	53.92	30.55	5.77	24.66	53.80	74.00	-20.20	PK
V	4844.00	43.07	30.55	5.77	24.66	42.95	54.00	-11.05	AV
V	7266.00	54.02	30.33	6.32	24.55	54.56	74.00	-19.44	PK
V	7266.00	43.90	30.33	6.32	24.55	44.44	54.00	-9.56	AV
V	9688.00	54.34	30.85	7.45	24.69	55.63	74.00	-18.37	PK
V	9688.00	43.46	30.85	7.45	24.69	44.75	54.00	-9.25	AV
V	12110.00	51.34	31.02	8.99	25.57	54.88	74.00	-19.12	PK
V	12110.00	43.47	31.02	8.99	25.57	47.01	54.00	-6.99	AV
H	4844.00	53.46	30.55	5.77	24.66	53.34	74.00	-20.66	PK
H	4844.00	43.39	30.55	5.77	24.66	43.27	54.00	-10.73	AV
H	7266.00	52.83	30.33	6.32	24.55	53.37	74.00	-20.63	PK
H	7266.00	43.75	30.33	6.32	24.55	44.29	54.00	-9.71	AV
H	9688.00	52.92	30.85	7.45	24.69	54.21	74.00	-19.79	PK
H	9688.00	43.80	30.85	7.45	24.69	45.09	54.00	-8.91	AV
H	12110.00	54.48	31.02	8.99	25.57	58.02	74.00	-15.98	PK
H	12110.00	43.71	31.02	8.99	25.57	47.25	54.00	-6.75	AV

Polar (H/V)	Frequency	Meter Reading	Pre-amplifier	Cable Loss	Antenna Factor	Emission Level	Limits	Margin	Detect or Type
	(MHz)	(dBuV)	(dB)	(dB)	(dB)	(dBuV/m)	(dBuV/m)	(dB)	
Middle Channel:2437MHz									
V	4874.00	53.16	30.55	5.77	24.66	53.04	74.00	-20.96	PK
V	4874.00	43.89	30.55	5.77	24.66	43.77	54.00	-10.23	AV
V	7311.00	50.62	30.33	6.32	24.55	51.16	74.00	-22.84	PK
V	7311.00	43.26	30.33	6.32	24.55	43.80	54.00	-10.20	AV
V	9748.00	54.95	30.85	7.45	24.69	56.24	74.00	-17.76	PK
V	9748.00	43.46	30.85	7.45	24.69	44.75	54.00	-9.25	AV
V	12185.00	54.20	31.02	8.99	25.57	57.74	74.00	-16.26	PK
V	12185.00	43.72	31.02	8.99	25.57	47.26	54.00	-6.74	AV
H	4874.00	53.53	30.55	5.77	24.66	53.41	74.00	-20.59	PK
H	4874.00	43.52	30.55	5.77	24.66	43.40	54.00	-10.60	AV
H	7311.00	54.35	30.33	6.32	24.55	54.89	74.00	-19.11	PK
H	7311.00	43.52	30.33	6.32	24.55	44.06	54.00	-9.94	AV
H	9748.00	54.00	30.85	7.45	24.69	55.29	74.00	-18.71	PK
H	9748.00	43.12	30.85	7.45	24.69	44.41	54.00	-9.59	AV
H	12185.00	54.58	31.02	8.99	25.57	58.12	74.00	-15.88	PK
H	12185.00	43.04	31.02	8.99	25.57	46.58	54.00	-7.42	AV



Polar (H/V)	Frequency	Meter Reading	Pre-amp lifier	Cable Loss	Antenna Factor	Emission Level	Limits	Margin	Detect or Type
	(MHz)	(dBuV)	(dB)	(dB)	(dB)	(dBuV/m)	(dBuV/ m)	(dB)	
High Channel:2452MHz									
V	4904.00	50.71	30.55	5.77	24.66	50.59	74.00	-23.41	PK
V	4904.00	43.47	30.55	5.77	24.66	43.35	54.00	-10.65	AV
V	7356.00	50.57	30.33	6.32	24.55	51.11	74.00	-22.89	PK
V	7356.00	43.88	30.33	6.32	24.55	44.42	54.00	-9.58	AV
V	9808.00	52.17	30.85	7.45	24.69	53.46	74.00	-20.54	PK
V	9808.00	43.04	30.85	7.45	24.69	44.33	54.00	-9.67	AV
V	12260.00	50.62	31.02	8.99	25.57	54.16	74.00	-19.84	PK
V	12260.00	43.69	31.02	8.99	25.57	47.23	54.00	-6.77	AV
H	4904.00	52.32	30.55	5.77	24.66	52.20	74.00	-21.80	PK
H	4904.00	43.82	30.55	5.77	24.66	43.70	54.00	-10.30	AV
H	7356.00	51.25	30.33	6.32	24.55	51.79	74.00	-22.21	PK
H	7356.00	43.59	30.33	6.32	24.55	44.13	54.00	-9.87	AV
H	9808.00	50.86	30.85	7.45	24.69	52.15	74.00	-21.85	PK
H	9808.00	43.74	30.85	7.45	24.69	45.03	54.00	-8.97	AV
H	12260.00	54.42	31.02	8.99	25.57	57.96	74.00	-16.04	PK
H	12260.00	43.35	31.02	8.99	25.57	46.89	54.00	-7.11	AV

## Remark:

1. Emission Level = Meter Reading + Antenna Factor + Cable Loss – Pre-amplifier,  
Margin= Emission Level - Limit
2. If peak below the average limit, the average emission was no test.
3. The amplitude of spurious emissions which are attenuated by more than 20dB below the permissible value has no need to be reported.



## 5. RADIATED BAND EMISSION MEASUREMENT

### 5.1 TEST REQUIREMENT:

Test Requirement:	FCC Part 15 C Section 15.209 and 15.205				
Test Method:	ANSI C63.10: 2013				
Test Frequency Range:	All of the restrict bands were tested, only the worst band's (2310MHz to 2500MHz) data was showed.				
Test site:	Measurement Distance: 3m				
Receiver setup:	Frequency	Detector	RBW	VBW	Value
	Above 1GHz	Peak	1MHz	3MHz	Peak
		Average	1MHz	3MHz	Average

### LIMITS OF RADIATED EMISSION MEASUREMENT (Above 1000MHz)

FREQUENCY (MHz)	Class B (dBuV/m) (at 3M)	
	PEAK	AVERAGE
Above 1000	74	54

Notes:

- (1) The limit for radiated test was performed according to FCC PART 15C.
- (2) The tighter limit applies at the band edges.
- (3) Emission level (dBuV/m) = 20log Emission level (uV/m).

### 5.2 TEST PROCEDURE

Above 1GHz test procedure as below:

- a. 1. The EUT was placed on the top of a rotating table 1.5 meters above the ground at a 3 meter camber. The table was rotated 360 degrees to determine the position of the highest radiation.
- b. The EUT was set 3 meters away from the interference-receiving antenna, which was mounted on the top of a variable-height antenna tower.
- c. The antenna height is varied from one meter to four meters above the ground to determine the maximum value of the field strength. Both horizontal and vertical polarizations of the antenna are set to make the measurement.
- d. For each suspected emission, the EUT was arranged to its worst case and then the antenna was tuned to heights from 1 meter to 4 meters and the rota table was turned from 0 degrees to 360 degrees to find the maximum reading.
- e. The test-receiver system was set to Peak Detect Function and Specified Bandwidth with Maximum Hold Mode.
- f. If the emission level of the EUT in peak mode was 10dB lower than the limit specified, then testing could be stopped and the peak values of the EUT would be reported. Otherwise the emissions that did not have 10dB margin would be re-tested one by one using peak, quasi-peak or average method as specified and then reported in a data sheet.
- g. Test the EUT in the lowest channel, the highest channel

Note:

Both horizontal and vertical antenna polarities were tested and performed pretest to three orthogonal axis. The worst case emissions were reported

### 5.3 DEVIATION FROM TEST STANDARD

No deviation



## 5.4 TEST SETUP

### Radiated Emission Test-Up Frequency Above 1GHz

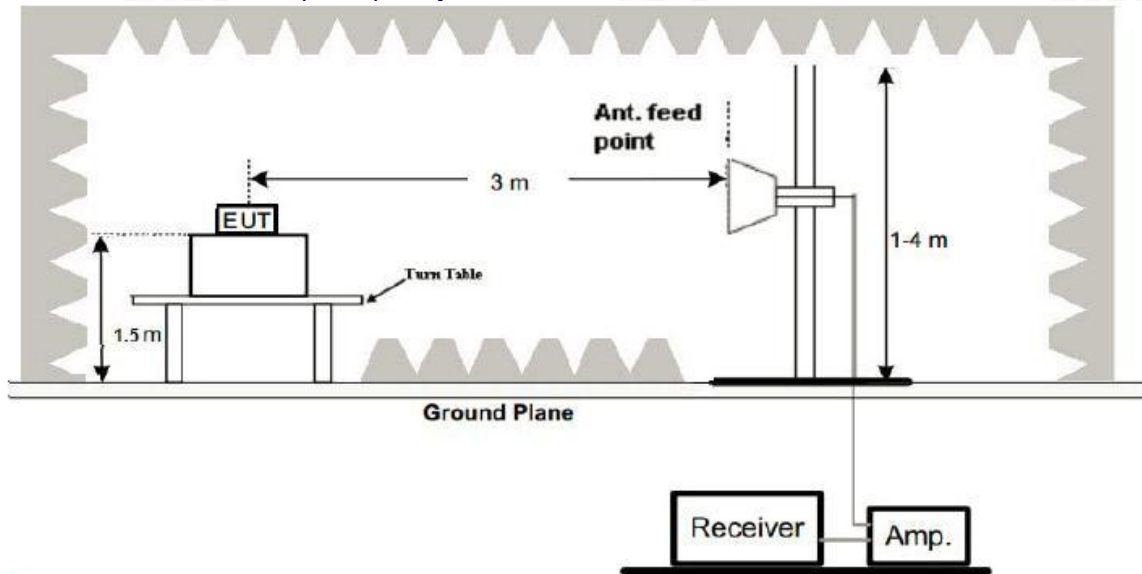

## 5.5 EUT OPERATING CONDITIONS

The EUT tested system was configured as the statements of 2.3 Unless otherwise a special operating condition is specified in the follows during the testing.



5.6 TEST RESULT

	Polar (H/V)	Frequenc y (MHz)	Meter Reading (dBUV)	Pre-amplifier (dB)	Cable Loss (dB)	Antenna Factor (dB/m)	Emission level (dBUV/m )	Limit (dBUV/ m)	Detec tor Type	Result
802.11b	LowChannel 2412MHz									
	H	2390.00	54.72	30.22	4.85	23.98	53.33	74.00	PK	PASS
	H	2390.00	44.49	30.22	4.85	23.98	43.10	54.00	AV	PASS
	H	2400.00	53.10	30.22	4.85	23.98	51.71	74.00	PK	PASS
	H	2400.00	44.37	30.22	4.85	23.98	42.98	54.00	AV	PASS
	V	2390.00	53.59	30.22	4.85	23.98	52.20	74.00	PK	PASS
	V	2390.00	44.70	30.22	4.85	23.98	43.31	54.00	AV	PASS
	V	2400.00	54.02	30.22	4.85	23.98	52.63	74.00	PK	PASS
	V	2400.00	44.63	30.22	4.85	23.98	43.24	54.00	AV	PASS
	HighChannel 2462MHz									
	H	2483.50	54.42	30.22	4.85	23.98	53.03	74.00	PK	PASS
	H	2483.50	44.85	30.22	4.85	23.98	43.46	54.00	AV	PASS
	H	2500.00	54.59	30.22	4.85	23.98	53.20	74.00	PK	PASS
	H	2500.00	44.14	30.22	4.85	23.98	42.75	54.00	AV	PASS
	V	2483.50	53.75	30.22	4.85	23.98	52.36	74.00	PK	PASS
	V	2483.50	44.05	30.22	4.85	23.98	42.66	54.00	AV	PASS
V	2500.00	54.05	30.22	4.85	23.98	52.66	74.00	PK	PASS	
V	2500.00	44.50	30.22	4.85	23.98	43.11	54.00	AV	PASS	
802.11g	LowChannel 2412MHz									
	H	2390.00	54.65	30.22	4.85	23.98	53.26	74.00	PK	PASS
	H	2390.00	44.38	30.22	4.85	23.98	42.99	54.00	AV	PASS
	H	2400.00	54.75	30.22	4.85	23.98	53.36	74.00	PK	PASS
	H	2400.00	44.81	30.22	4.85	23.98	43.42	54.00	AV	PASS
	V	2390.00	54.15	30.22	4.85	23.98	52.76	74.00	PK	PASS
	V	2390.00	44.10	30.22	4.85	23.98	42.71	54.00	AV	PASS
	V	2400.00	53.01	30.22	4.85	23.98	51.62	74.00	PK	PASS
	V	2400.00	44.66	30.22	4.85	23.98	43.27	54.00	AV	PASS
	High Channel 2462MHz									
	H	2483.50	53.67	30.22	4.85	23.98	52.28	74.00	PK	PASS
	H	2483.50	44.73	30.22	4.85	23.98	43.34	54.00	AV	PASS
	H	2500.00	53.30	30.22	4.85	23.98	51.91	74.00	PK	PASS
	H	2500.00	44.90	30.22	4.85	23.98	43.51	54.00	AV	PASS
	V	2483.50	54.85	30.22	4.85	23.98	53.46	74.00	PK	PASS
	V	2483.50	44.13	30.22	4.85	23.98	42.74	54.00	AV	PASS
V	2500.00	54.44	30.22	4.85	23.98	53.05	74.00	PK	PASS	
V	2500.00	44.03	30.22	4.85	23.98	42.64	54.00	AV	PASS	
Remark:										
1. Emission Level = Meter Reading + Antenna Factor + Cable Loss – Pre-amplifier, Margin= Emission Level - Limit										





		LowChannel 2412MHz									
		H	2390.00	54.64	30.22	4.85	23.98	53.25	74.00	PK	PASS
802.11n20	H	2390.00	44.31	30.22	4.85	23.98	42.92	54.00	AV	PASS	
	H	2400.00	53.58	30.22	4.85	23.98	52.19	74.00	PK	PASS	
	H	2400.00	44.93	30.22	4.85	23.98	43.54	54.00	AV	PASS	
	V	2390.00	54.10	30.22	4.85	23.98	52.71	74.00	PK	PASS	
	V	2390.00	44.07	30.22	4.85	23.98	42.68	54.00	AV	PASS	
	V	2400.00	54.93	30.22	4.85	23.98	53.54	74.00	PK	PASS	
	V	2400.00	44.11	30.22	4.85	23.98	42.72	54.00	AV	PASS	
	High Channel 2462MHz										
	H	2483.50	53.86	30.22	4.85	23.98	52.47	74.00	PK	PASS	
	H	2483.50	44.73	30.22	4.85	23.98	43.34	54.00	AV	PASS	
	H	2500.00	53.38	30.22	4.85	23.98	51.99	74.00	PK	PASS	
	H	2500.00	44.06	30.22	4.85	23.98	42.67	54.00	AV	PASS	
	V	2483.50	54.84	30.22	4.85	23.98	53.45	74.00	PK	PASS	
	V	2483.50	44.98	30.22	4.85	23.98	43.59	54.00	AV	PASS	
V	2500.00	54.05	30.22	4.85	23.98	52.66	74.00	PK	PASS		
V	2500.00	44.94	30.22	4.85	23.98	43.55	54.00	AV	PASS		
802.11n40		LowChannel 2422MHz									
		H	2390.00	53.87	30.22	4.85	23.98	52.48	74.00	PK	PASS
		H	2390.00	44.54	30.22	4.85	23.98	43.15	54.00	AV	PASS
		H	2400.00	53.52	30.22	4.85	23.98	52.13	74.00	PK	PASS
		H	2400.00	44.43	30.22	4.85	23.98	43.04	54.00	AV	PASS
		V	2390.00	53.97	30.22	4.85	23.98	52.58	74.00	PK	PASS
		V	2390.00	44.16	30.22	4.85	23.98	42.77	54.00	AV	PASS
		V	2400.00	53.71	30.22	4.85	23.98	52.32	74.00	PK	PASS
		V	2400.00	44.64	30.22	4.85	23.98	43.25	54.00	AV	PASS
		High Channel 2452MHz									
		H	2483.50	54.12	30.22	4.85	23.98	52.73	74.00	PK	PASS
		H	2483.50	44.86	30.22	4.85	23.98	43.47	54.00	AV	PASS
		H	2500.00	54.47	30.22	4.85	23.98	53.08	74.00	PK	PASS
		H	2500.00	44.38	30.22	4.85	23.98	42.99	54.00	AV	PASS
V	2483.50	53.29	30.22	4.85	23.98	51.90	74.00	PK	PASS		
V	2483.50	44.46	30.22	4.85	23.98	43.07	54.00	AV	PASS		
V	2500.00	54.33	30.22	4.85	23.98	52.94	74.00	PK	PASS		
V	2500.00	44.15	30.22	4.85	23.98	42.76	54.00	AV	PASS		
Remark:											
1. Emission Level = Meter Reading + Antenna Factor + Cable Loss – Pre-amplifier, Margin= Emission Level - Limit											



## 6. POWER SPECTRAL DENSITY TEST

Test Requirement:	FCC Part15 C Section 15.247 (e)
Test Method:	ANSI C63.10:2013 and KDB558074 D01DTS Meas Guidancev05r02

### 6.1 APPLIED PROCEDURES / LIMIT

FCC Part15 (15.247) , Subpart C				
Section	Test Item	Limit	Frequency Range (MHz)	Result
15.247	Power Spectral Density	8dBm/3kHz	2400-2483.5	PASS

### 6.2 TEST PROCEDURE

1. Set analyzer center frequency to DTS channel center frequency.
2. Set the span to 1.5 times the DTS bandwidth.
3. Set the RBW to:  $3 \text{ kHz} \leq \text{RBW} \leq 100 \text{ kHz}$ .
4. Set the VBW  $\geq 3 \times \text{RBW}$ .
5. Detector = peak.
6. Sweep time = auto couple.
7. Trace mode = max hold.
8. Allow trace to fully stabilize.
9. Use the peak marker function to determine the maximum amplitude level within the RBW.
10. If measured value exceeds limit, reduce RBW (no less than 3 kHz) and repeat.

### 6.3 DEVIATION FROM STANDARD

No deviation.

### 6.4 TEST SETUP



### 6.5 EUT OPERATION CONDITIONS

The EUT tested system was configured as the statements of 2.1 Unless otherwise a special operating condition is specified in the follows during the testing.



6.6 TEST RESULT

Temperature:	26°C	Relative Humidity:	54%
Pressure:	101kPa	Test Voltage :	AC 120V/60Hz
Test Mode :	TX b Mode		

Frequency	Power Spectral Density (dBm/3kHz)	Limit (dBm/3kHz)	Result
2412 MHz	-19.108	8	PASS
2437 MHz	-18.463	8	PASS
2462 MHz	-17.383	8	PASS

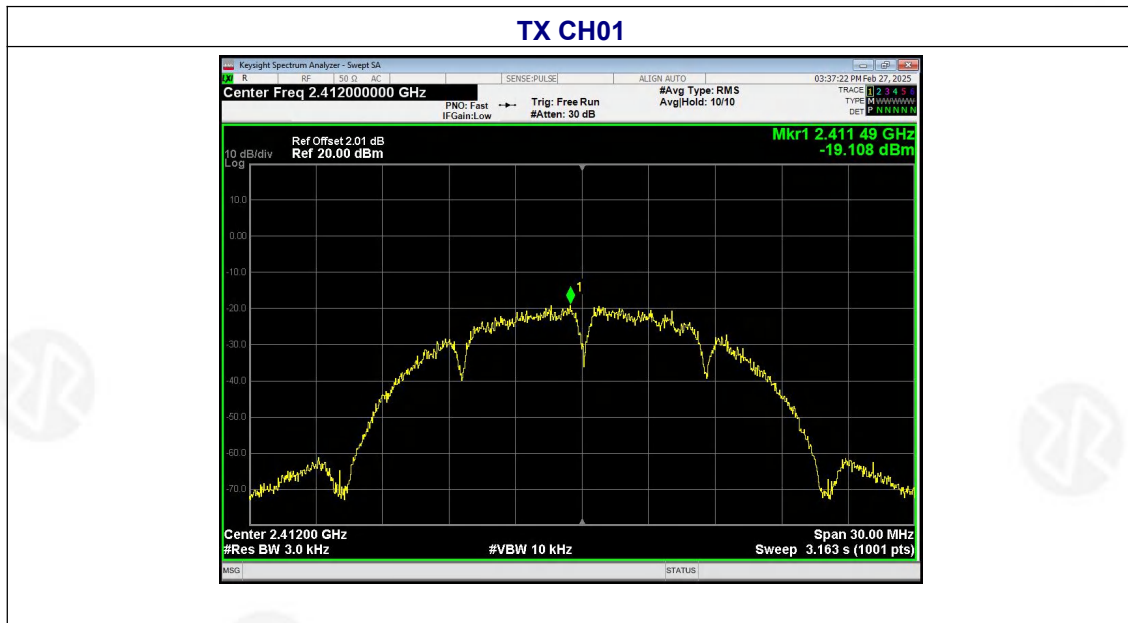



### TX CH06



### TX CH11





Temperature:	26°C	Relative Humidity:	54%
Pressure:	101kPa	Test Voltage:	AC 120V/60Hz
Test Mode :	TX g Mode		

Frequency	Power Spectral Density (dBm/3kHz)	Limit (dBm/3kHz)	Result
2412 MHz	-15.221	8	PASS
2437 MHz	-15.683	8	PASS
2462 MHz	-15.078	8	PASS

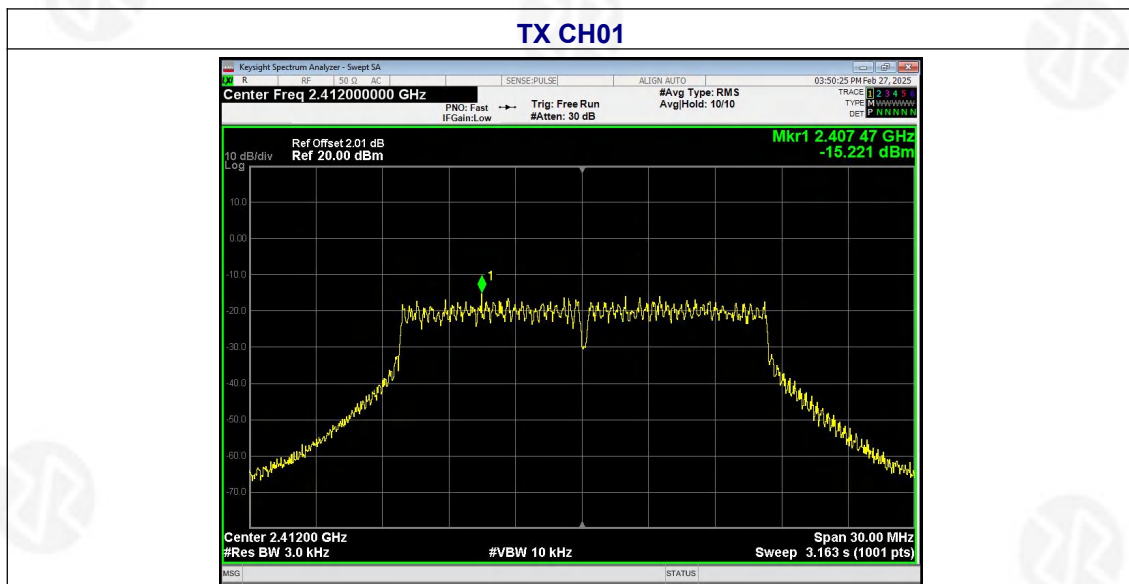



### TX CH06

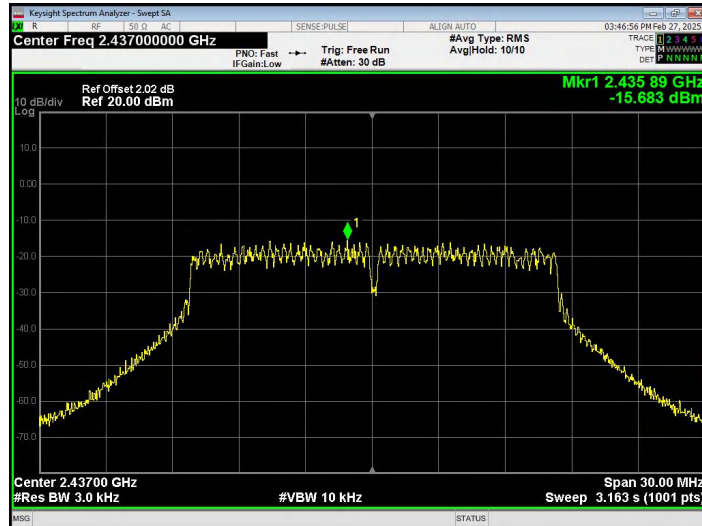

### TX CH11

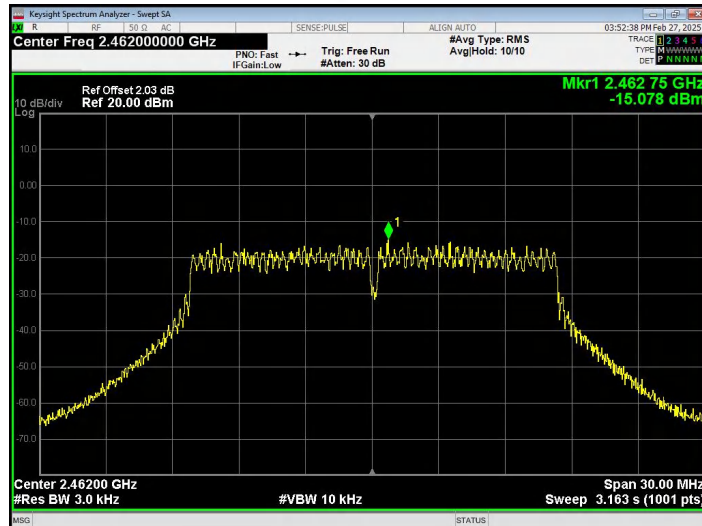



Temperature:	26°C	Relative Humidity:	54%
Pressure:	101kPa	Test Voltage:	AC 120V/60Hz
Test Mode :	TX n Mode(20M)		

Frequency	Power Spectral Density (dBm/3kHz)	Limit (dBm/3kHz)	Result
2412 MHz	-14.884	8	PASS
2437 MHz	-16.108	8	PASS
2462 MHz	-16.477	8	PASS

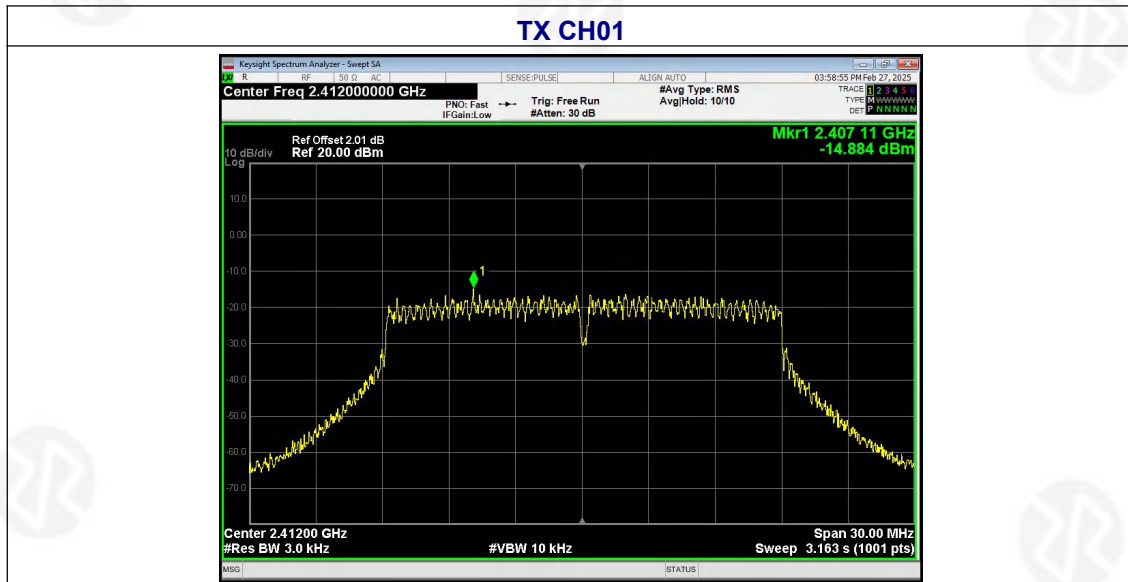



### TX CH06

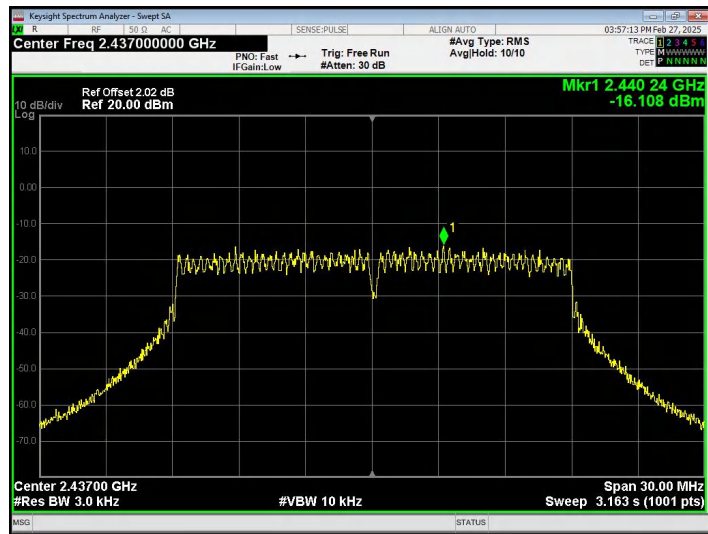

### TX CH11

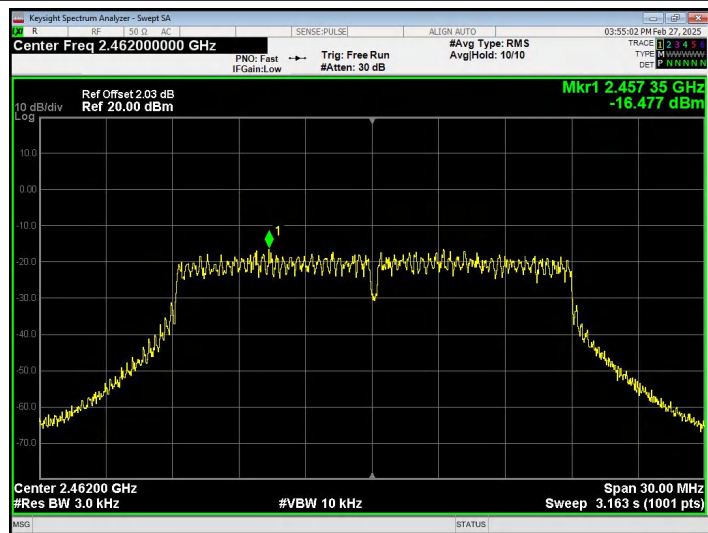





Temperature:	26°C	Relative Humidity:	54%
Pressure:	101kPa	Test Voltage:	AC 120V/60Hz
Test Mode :	TX n Mode(40M)		

Frequency	Power Spectral Density (dBm/3kHz)	Limit (dBm/3kHz)	Result
2422 MHz	-16.268	8	PASS
2437 MHz	-16.166	8	PASS
2452 MHz	-16.017	8	PASS

**TX CH03**

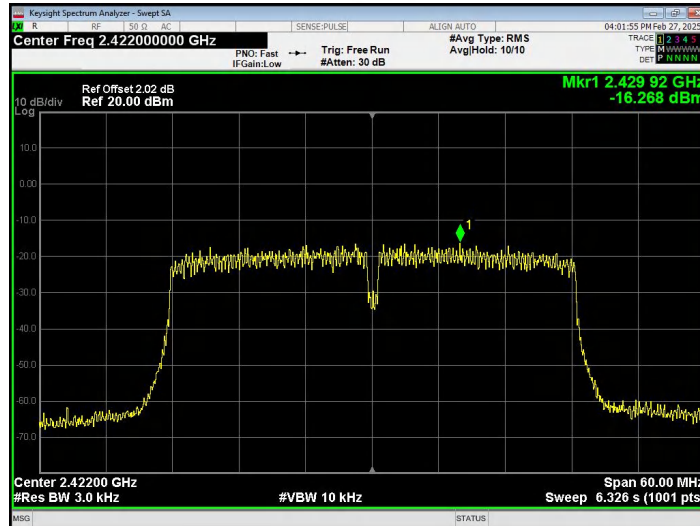



### TX CH06

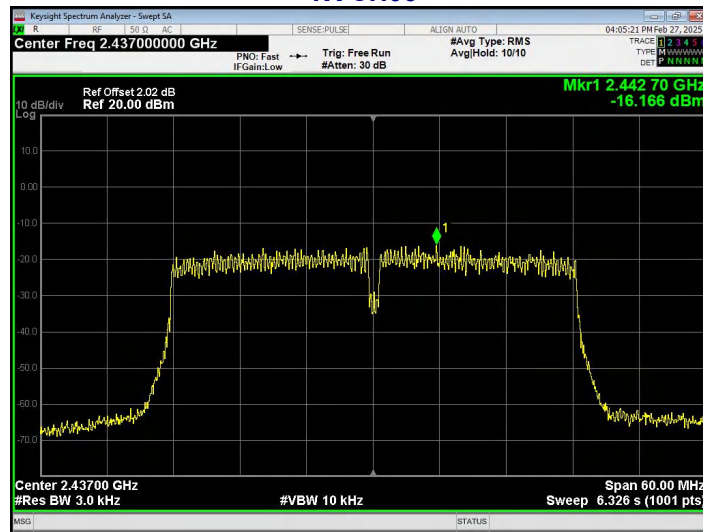

### TX CH09

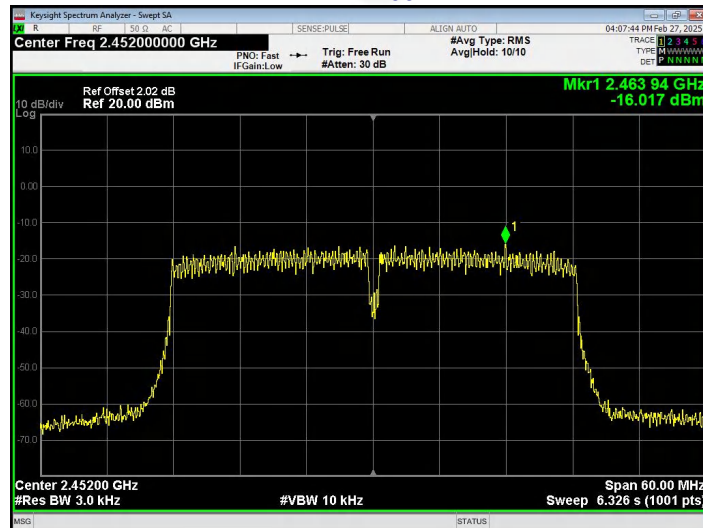



## 7. CHANNEL BANDWIDTH OCCUPY BANDWIDTH

Test Requirement:	FCC Part15 C Section 15.247 (a)(2)
Test Method:	ANSI C63.10:2013 and KDB558074 D01DTS Meas Guidancev05r02

### 7.1 APPLIED PROCEDURES / LIMIT

FCC Part15 (15.247) , Subpart C				
Section	Test Item	Limit	Frequency Range (MHz)	Result
15.247(a)(2)	Bandwidth	$\geq 500\text{KHz}$ (6dB bandwidth)	2400-2483.5	PASS

### 7.2 TEST PROCEDURE

1. Set RBW = 100 kHz.
2. Set the video bandwidth (VBW)  $\geq 3 \times \text{RBW}$ .
3. Detector = Peak.
4. Trace mode = max hold.
5. Sweep = auto couple.
6. Allow the trace to stabilize.
7. Measure the maximum width of the emission that is constrained by the frequencies associated with the two outermost amplitude points (upper and lower frequencies) that are attenuated by 6 dB relative to the maximum level measured in the fundamental emission.

### 7.3 DEVIATION FROM STANDARD

No deviation.

### 7.4 TEST SETUP



### 7.5 EUT OPERATION CONDITIONS

The EUT tested system was configured as the statements of 2.4 Unless otherwise a special operating condition is specified in the follows during the testing.



## 7.6 TEST RESULT

Temperature:	26°C	Relative Humidity:	54%
Pressure:	101kPa	Test Voltage :	AC 120V/60Hz
Test Mode :	TX b Mode		

Test CH	-6dB Occupy Bandwidth (MHz)					Result
	802.11b	802.11g	802.11n(HT20)	802.11n(HT40)	Limit(KHz)	
Lowest	9.566	16.327	17.321	35.099	>500	Pass
Middle	9.53	16.318	17.16	35.057		
Highest	10.02	16.325	17.299	35.097		



Test plot as follows:

Lowest channel

802.11b

802.11g

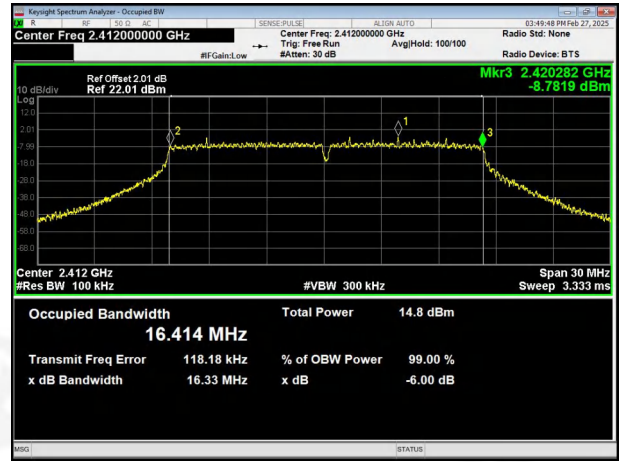

Middle channel

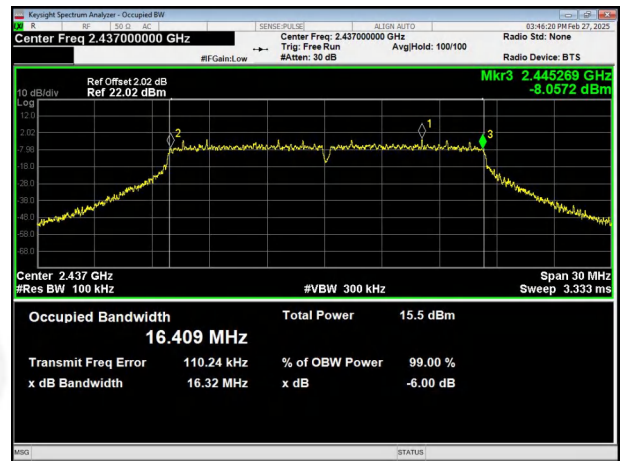
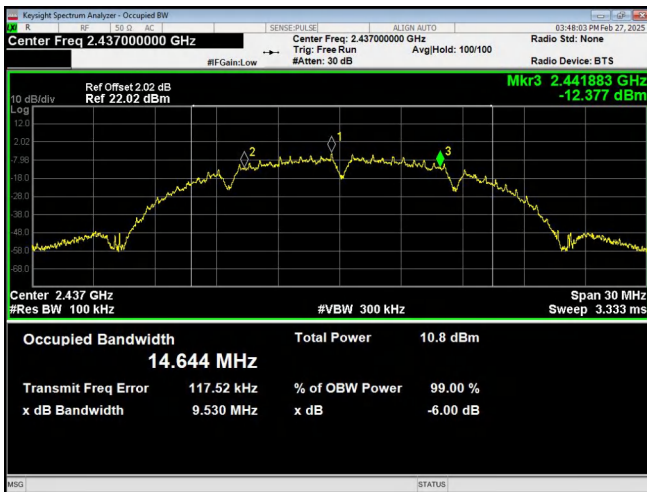

Highest channel

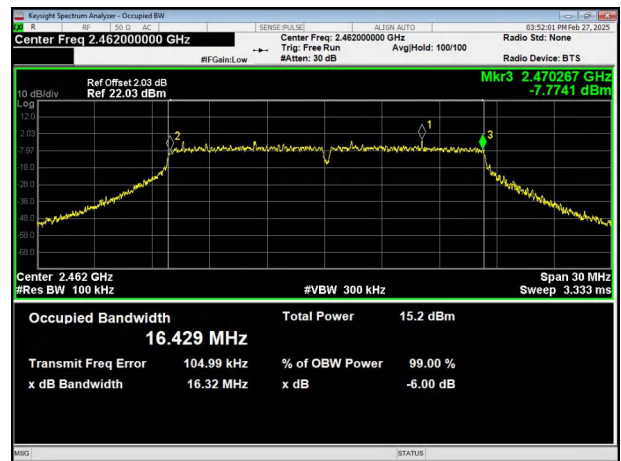
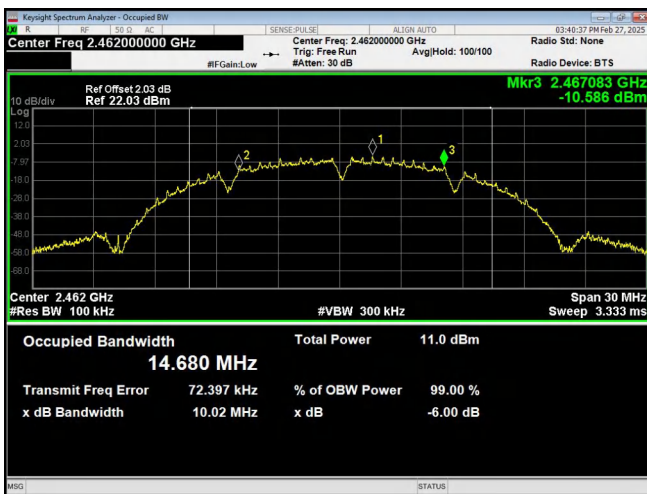



### Lowest channel

802.11n20

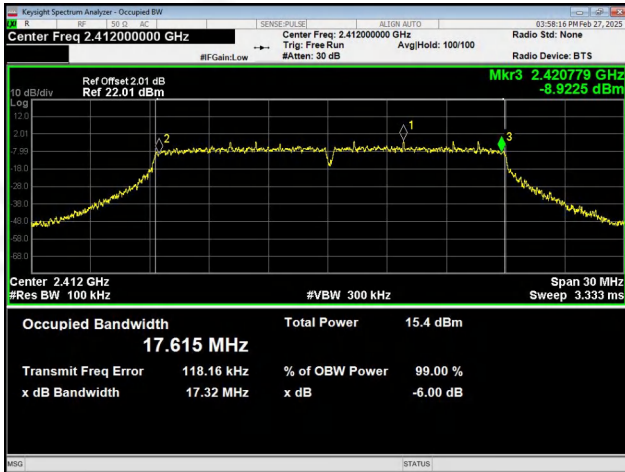

802.11n40

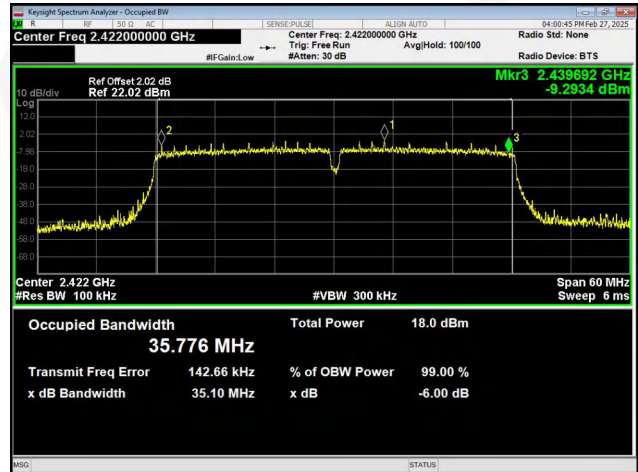

### Middle channel

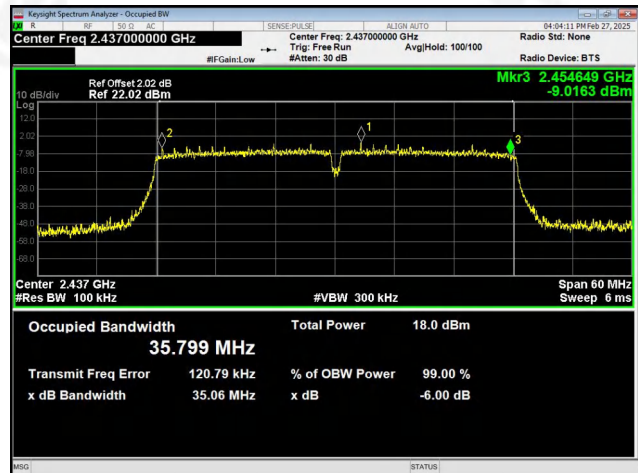
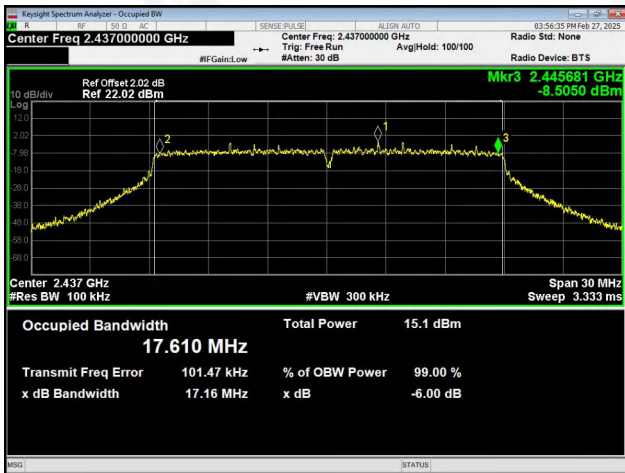

### Highest channel

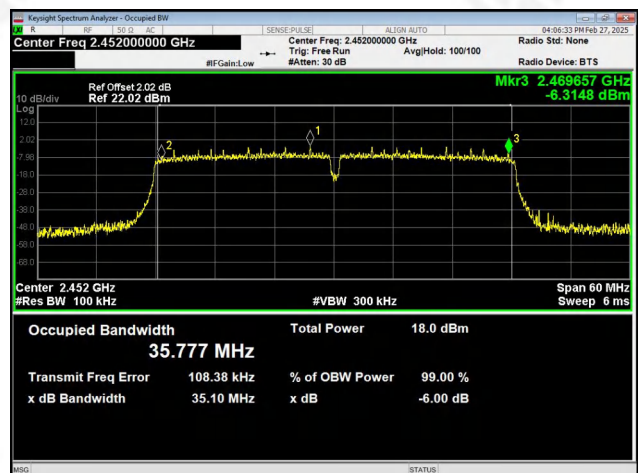
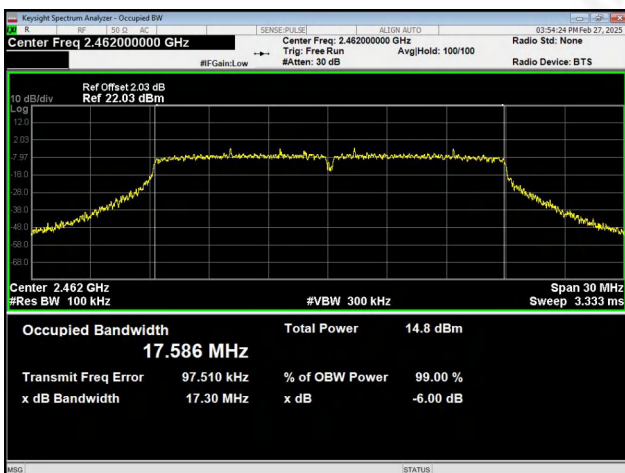



### 8. PEAK OUTPUT POWER TEST

Test Requirement:	FCC Part15 C Section 15.247 (b)(3)
Test Method:	ANSI C63.10:2013 and KDB558074 D01DTS Meas Guidancev05r02

#### 8.1 APPLIED PROCEDURES/LIMIT

FCC Part15 (15.247) , Subpart C				
Section	Test Item	Limit	Frequency Range (MHz)	Result
15.247(b)(3)	Peak Output Power	1 watt or 30dBm	2400-2483.5	PASS

#### 8.2 TEST PROCEDURE

- a. The EUT was directly connected to the Power meter

#### 8.3 DEVIATION FROM STANDARD

No deviation.

#### 8.4 TEST SETUP



#### 8.5 EUT OPERATION CONDITIONS

The EUT tested system was configured as the statements of 2.4 Unless otherwise a special operating condition is specified in the follows during the testing.



## 8.6 TEST RESULT

Temperature:	26°C	Relative Humidity:	54%
Pressure:	101kPa	Test Voltage :	AC 120V/60Hz

Test CH	Peak Output Power (dBm)				Limit(dBm)	Result
	802.11b	802.11g	802.11n20	802.11n40		
Lowest	5.561	8.971	8.989	9.326	30.00	Pass
Middle	5.788	9.397	8.635	9.811		
Highest	6.112	9.139	8.789	9.512		





## 9. CONDUCTED BAND EDGE AND SPURIOUS EMISSION

Test Requirement:	FCC Part15 C Section 15.247 (d)
Test Method:	ANSI C63.10:2013 and KDB558074 D01DTS Meas Guidancev05r02

### 9.1 APPLICABLE STANDARD

in any 100 kHz bandwidth outside the frequency bands in which the spread spectrum intentional radiator is operating, the radio frequency power that is produced by the intentional radiator shall be at least 20dB below that in the 100kHz bandwidth within the band that contains the highest level of the desired power, In addition, radiated emissions which fall in the restricted bands, as defined in§15.205(a), must also comply with the radiated emission limits specified in15.209(a).

### 9.2 TEST PROCEDURE

Using the following spectrum analyzer setting:

- A) Set the RBW = 100KHz.
- B) Set the VBW = 300KHz.
- C) Sweep time = auto couple.
- D) Detector function = peak.
- E) Trace mode = max hold.
- F) Allow trace to fully stabilize.

### 9.3 DEVIATION FROM STANDARD

No deviation.

### 9.4 TEST SETUP

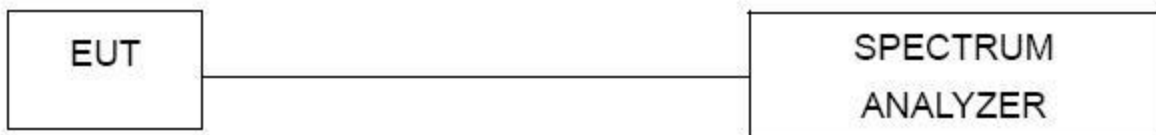

### 9.5 EUT OPERATION CONDITIONS

The EUT tested system was configured as the statements of 2.4 Unless otherwise a special operating condition is specified in the follows during the testing.

### 9.6 TEST RESULTS



Test plot as follows:

Test mode: 802.11b

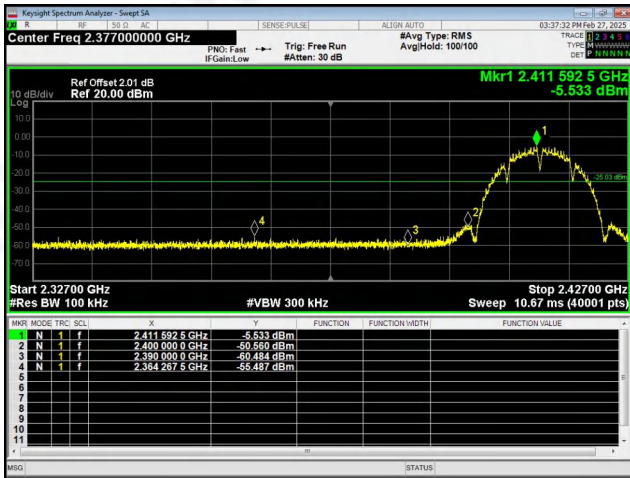

Lowest channel

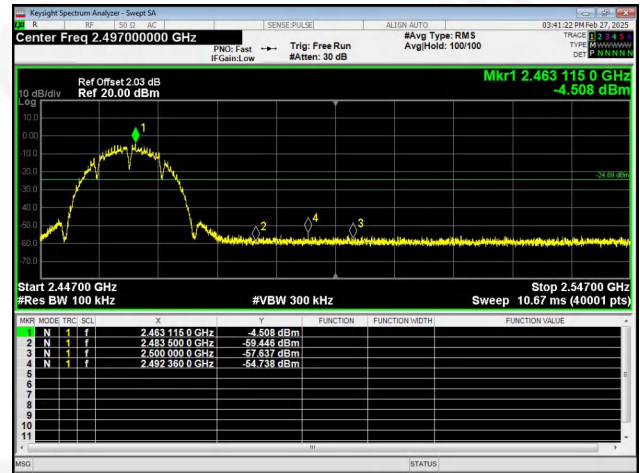

Highest channel

Test mode: 802.11g

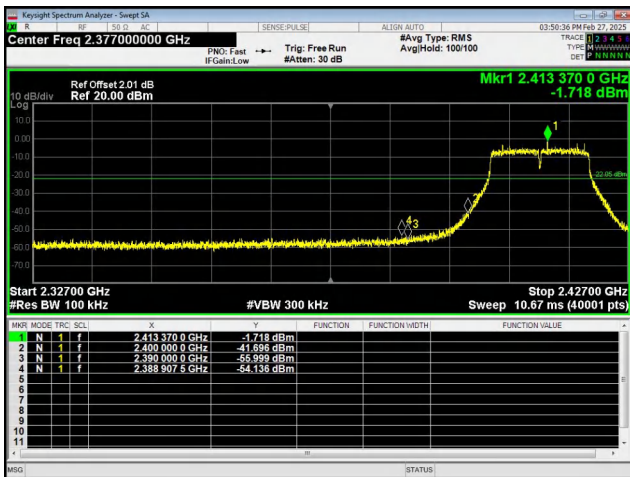

Lowest channel

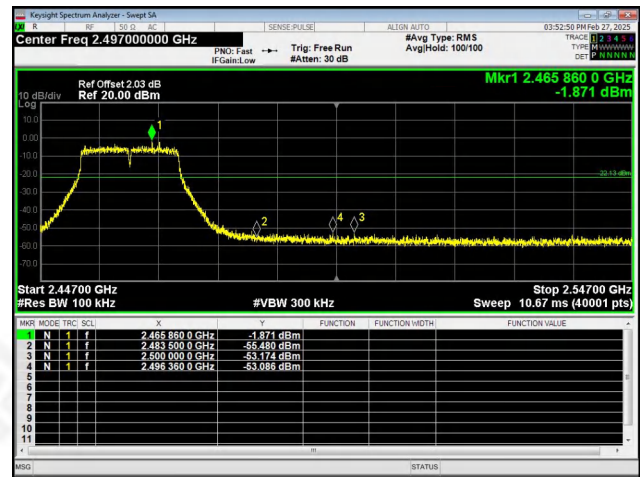

Highest channel



Test mode: 802.11n(HT20)

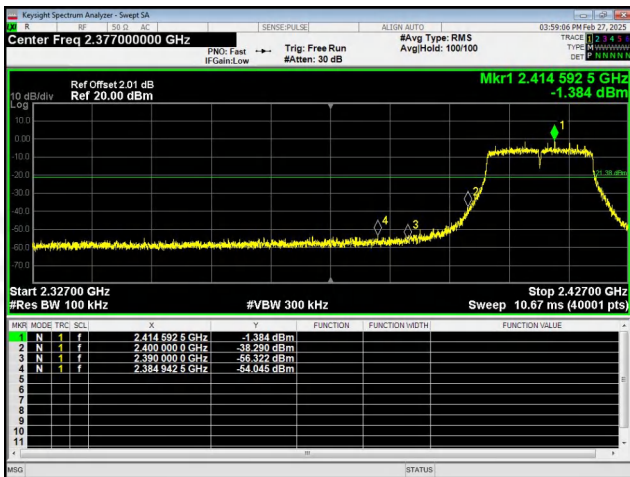

Lowest channel

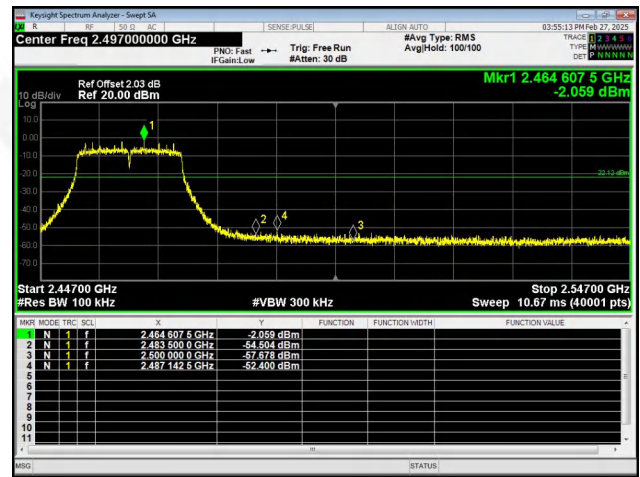

Highest channel

Test mode: 802.11n(HT40)

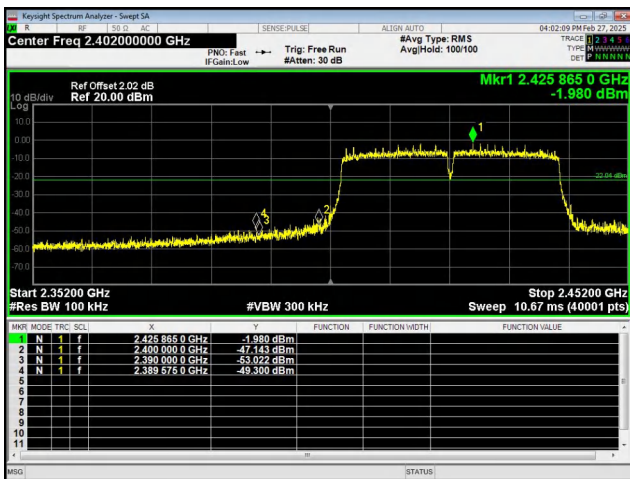

Lowest channel

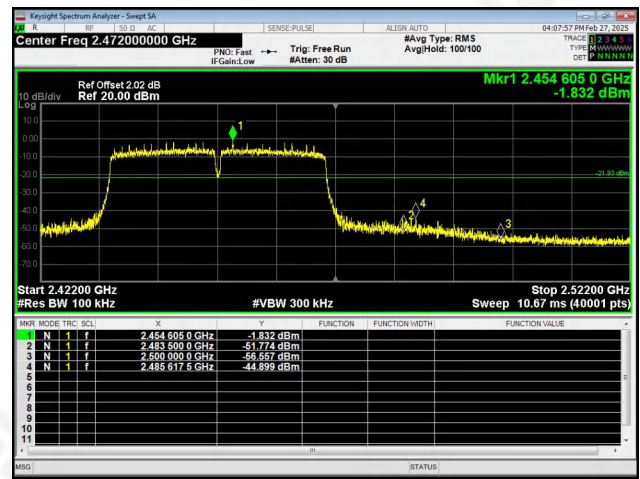

Highest channel



Test plot as follows:

802.11b  
Lowest channel

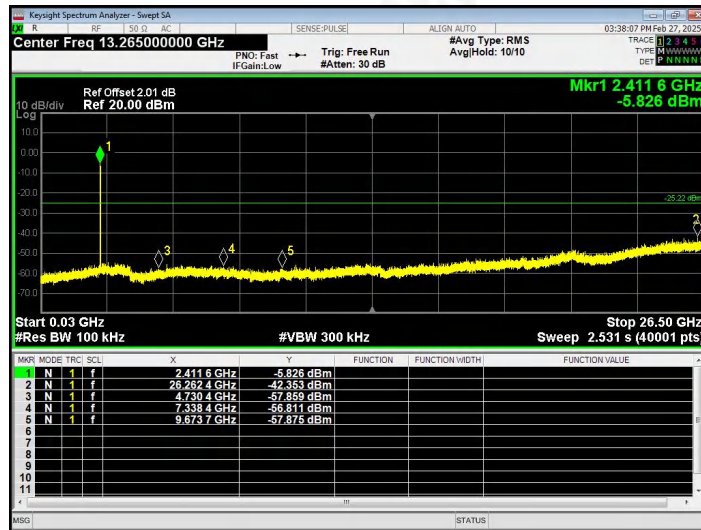

Middle channel

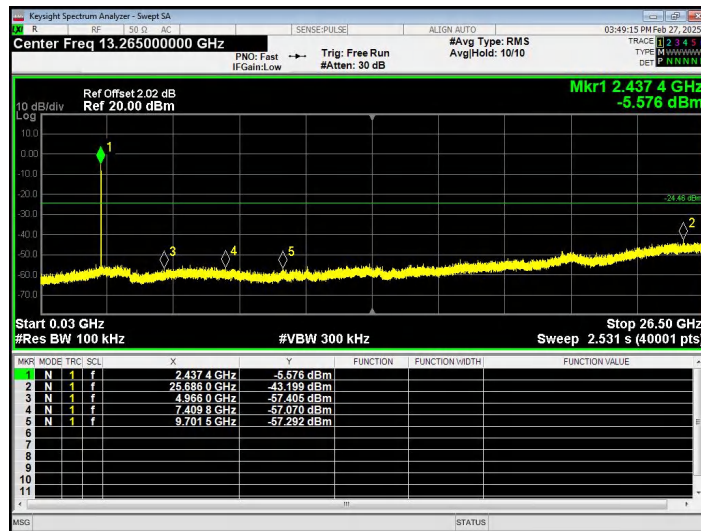

Highest channel

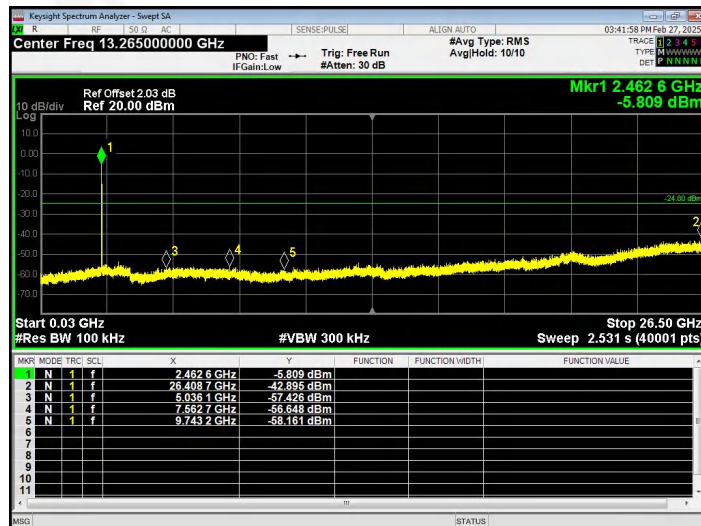



802.11g  
Lowest channel

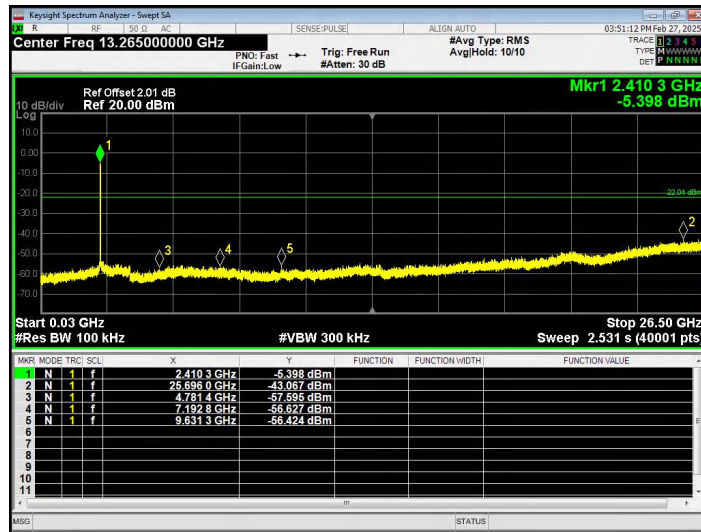

Middle channel

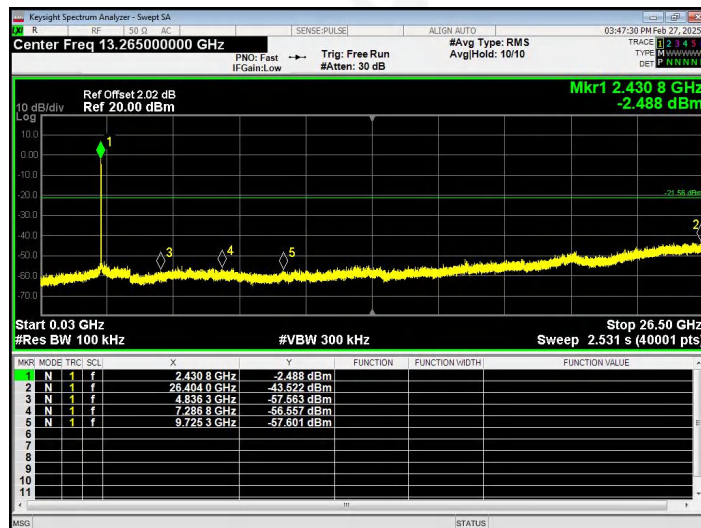

Highest channel

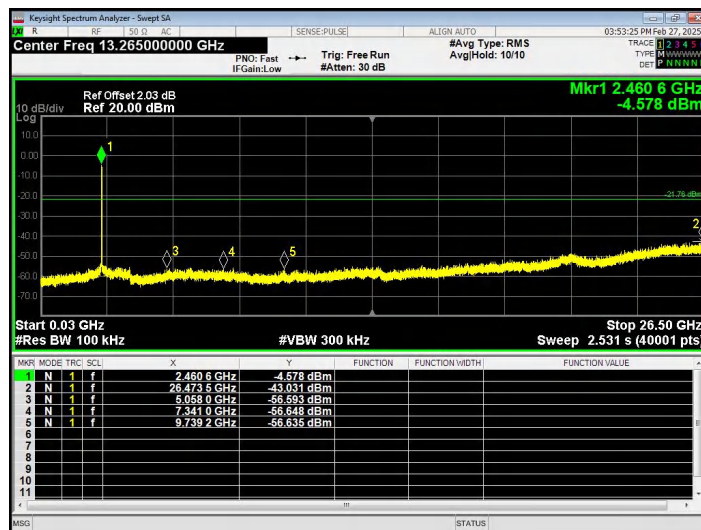



802.11n(HT20)

Lowest channel

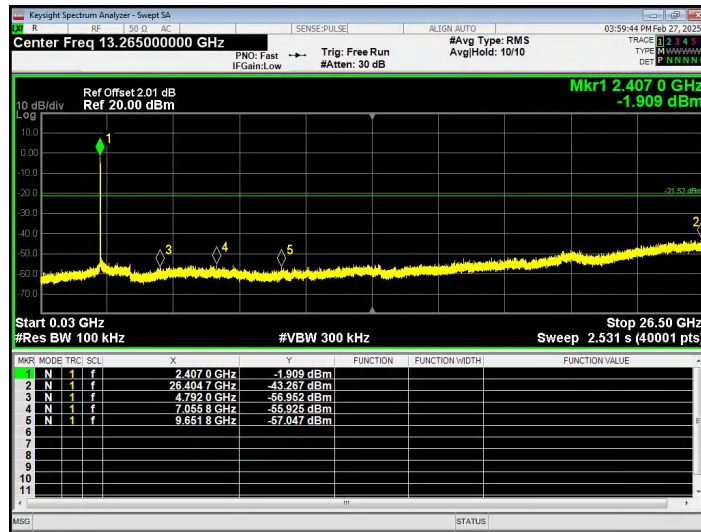

Middle channel

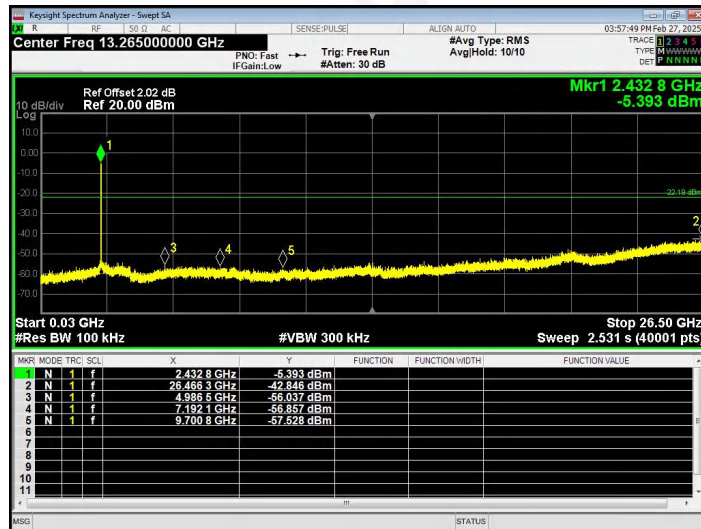

Highest channel

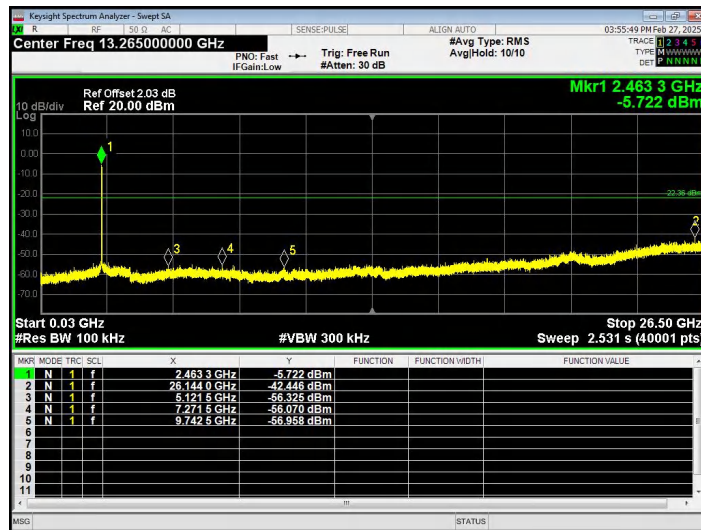



802.11n(HT40)  
Lowest channel

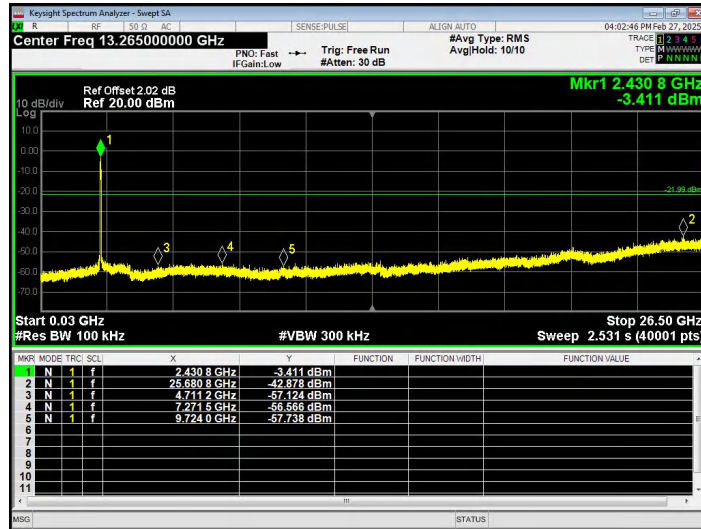

Middle channel

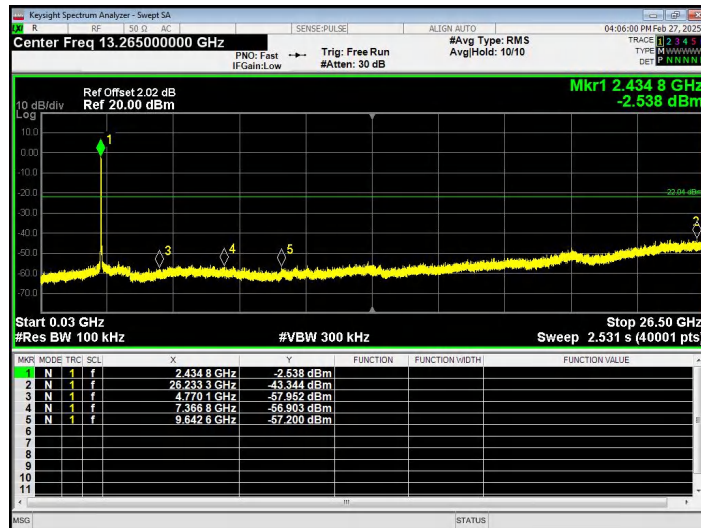

Highest channel

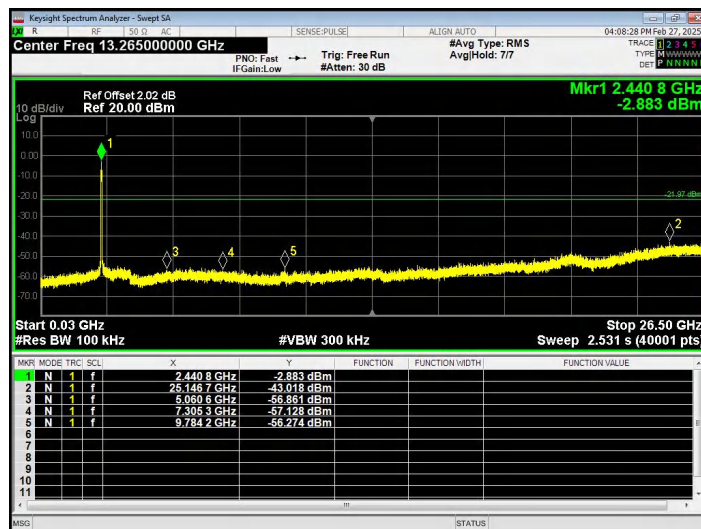



## 10. DUTY CYCLE

Test Method:	ANSI C63.10:2013
--------------	------------------

### 10.1 APPLIED PROCEDURES / LIMIT

Measurements of duty cycle and transmission duration shall be performed using one of the following techniques:

- a) A diode detector and an oscilloscope that together have a sufficiently short response time to permit accurate measurements of the ON and OFF times of the transmitted signal.
- b) The zero-span mode on a spectrum analyzer or EMI receiver if the response time and spacing between bins on the sweep are sufficient to permit accurate measurements of the ON and OFF times of the transmitted signal:
  - 1) Set the center frequency of the instrument to the center frequency of the transmission.
  - 2) Set  $RBW \geq OBW$  if possible; otherwise, set RBW to the largest available value.
  - 3) Set  $VBW \geq RBW$ . Set detector = peak or average.
  - 4) The zero-span measurement method shall not be used unless both RBW and VBW are  $> 50/T$  and the number of sweep points across duration  $T$  exceeds 100. (For example, if VBW and/or RBW are limited to 3 MHz, then the zero-span method of measuring the duty cycle shall not be used if  $T \leq 16.7 \mu s$ .)

### 10.2 DEVIATION FROM STANDARD

No deviation.

### 10.3 TEST SETUP







### 10.4 TEST RESULTS

Mode	Frequency (MHz)	Duty Cycle (%)	Duty Cycle Correction Factor (dB)	Result
802.11b	2412	99.12	0.04	Pass
802.11g	2412	94.25	0.26	Pass
802.11n20	2412	93.84	0.27	Pass
802.11n40	2422	88.24	0.54	Pass

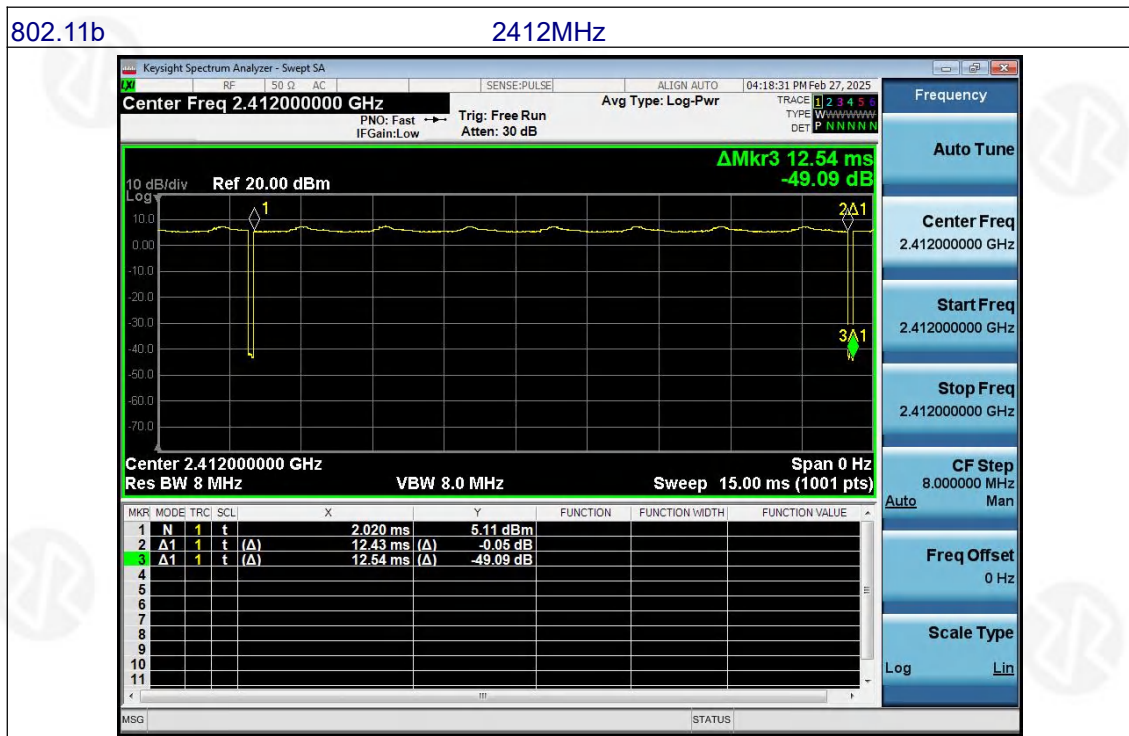



802.11g

2412MHz

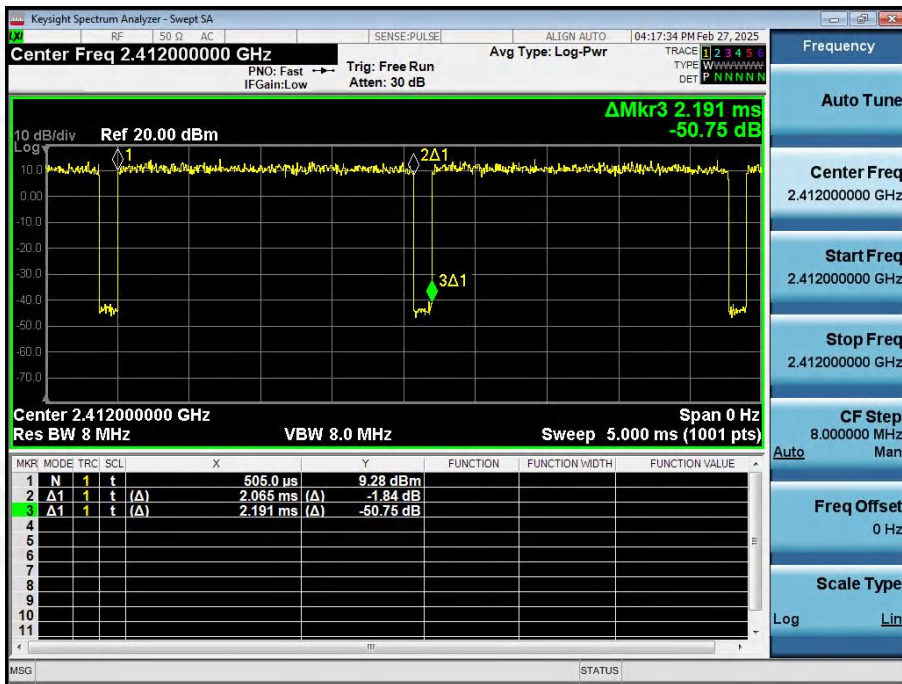

802.11n20

2412MHz

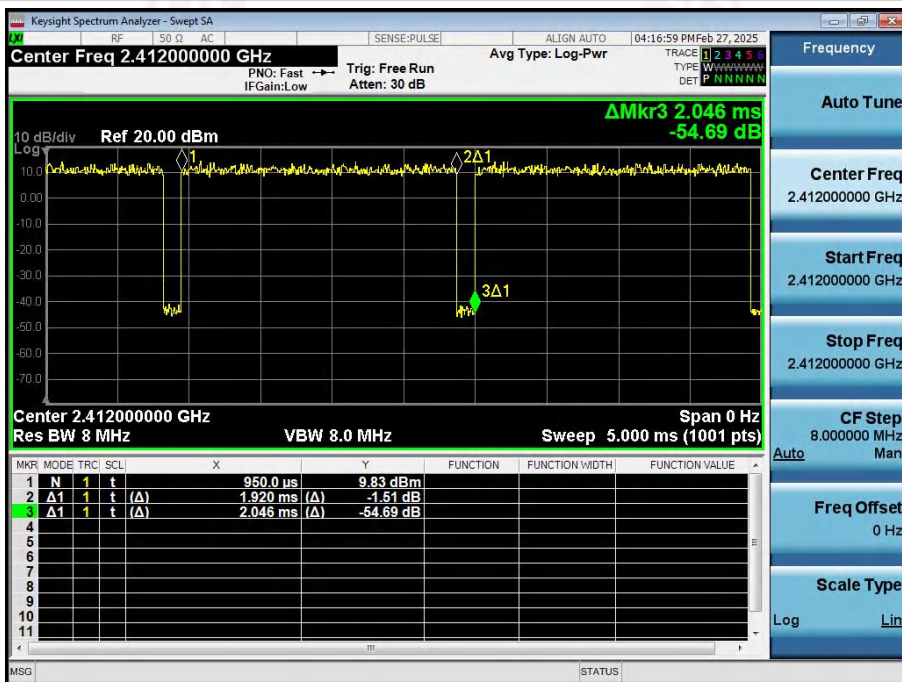



802.11n40

2422MHz

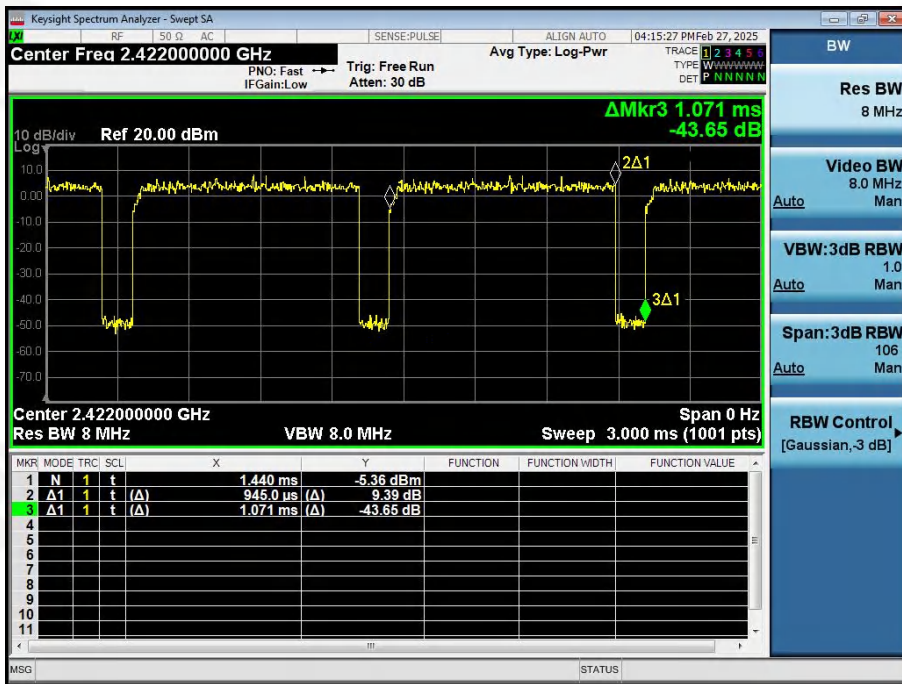

Note: All channel have been tested, and the report only reflects the worst case data.

Duty Cycle= Ton /Total\*100%

Duty Cycle Correction Factor = 10log (1/Duty Cycle)



## 11. ANTENNA REQUIREMENT

Standard requirement:	FCC Part15 C Section 15.203 /247(c)
15.203 requirement: An intentional radiator shall be designed to ensure that no antenna other than that furnished by the responsible party shall be used with the device. The use of a permanently attached antenna or of an antenna that uses a unique coupling to the intentional radiator, the manufacturer may design the unit so that a broken antenna can be replaced by the user, but the use of a standard antenna jack or electrical connector is prohibited.	
15.247(c) (1)(i) requirement: (i) Systems operating in the 2400-2483.5 MHz band that is used exclusively for fixed. Point-to-point operations may employ transmitting antennas with directional gain greater than 6dBi provided the maximum conducted output power of the intentional radiator is reduced by 1 dB for every 3 dB that the directional gain of the antenna exceeds 6dBi. A transmitter can only be sold or operated with antennas with which it was approved.	
EUT Antenna:	
The antenna is PBC Antenna, the best case gain of the antenna is -0.58 dBi, reference to the appendix II for details	



## 12. TEST SETUP PHOTO

Reference to the appendix I for details.

## 13. EUT CONSTRUCTIONAL DETAILS

Reference to the appendix II for details.

\*\*\*\*\* END OF REPORT \*\*\*\*\*