

1. Product parameters

型 号	OYT-2400DW
主要技术指标 Main Technical Specifications	
频率范围 Frequency Range (MHz)	2400-2500
频带宽度 Bandwidth (MHz)	100
增益 Gain (dBi)	2
最大功率 Max Input power (W)	5
电缆长度 Line Length (mm)	
接口形式 Connector Type	RP SMA male
Model	

2. Product specification



单位: mm 比例: 1:1

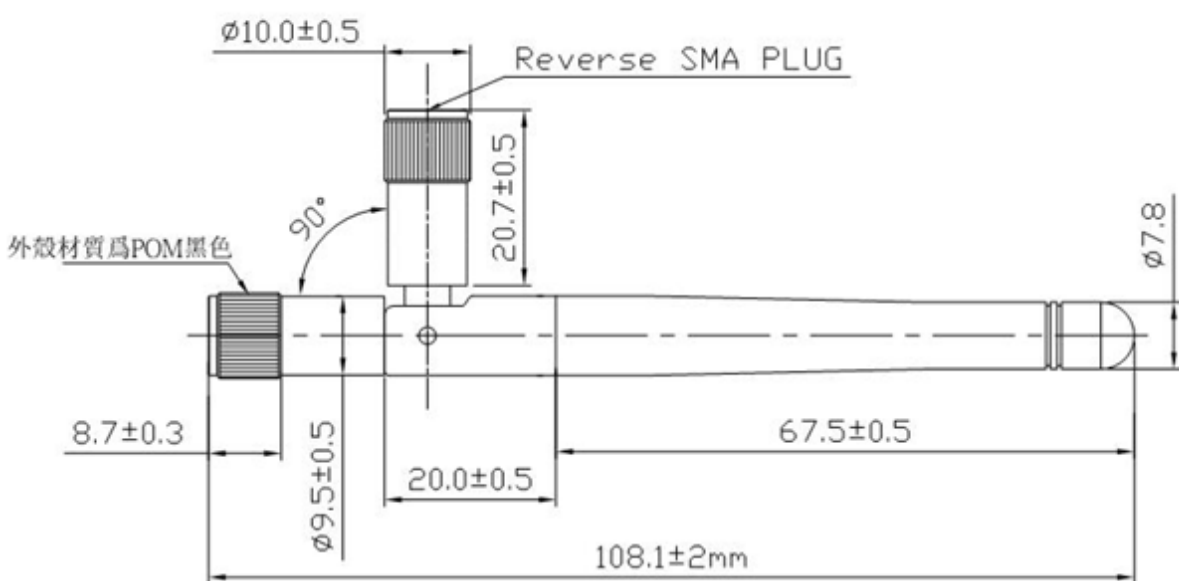

3. Radiation Pattern

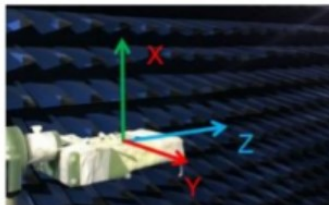
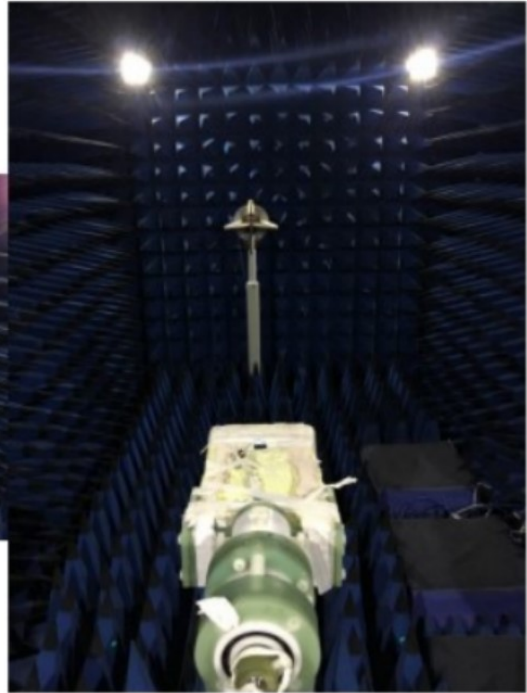
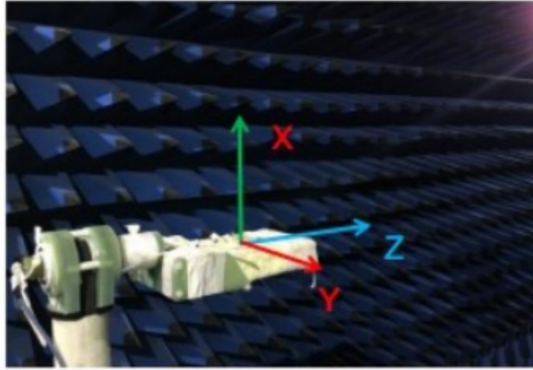

2400 MHz
ANT

H面: XY
E1面: XZ
E2面: YZ

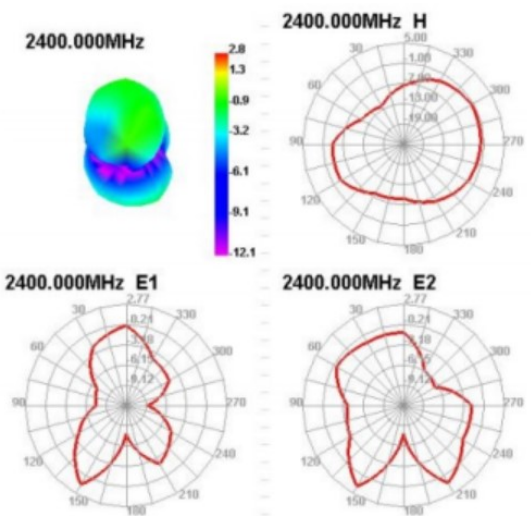

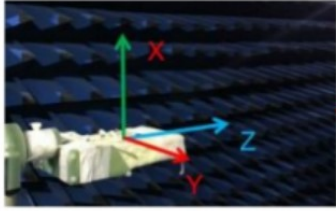

H面: XY
E1面: XZ
E2面: YZ

2450 MHz
ANT

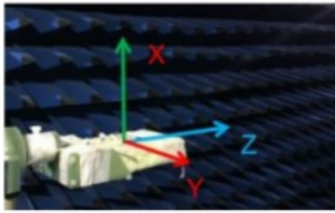
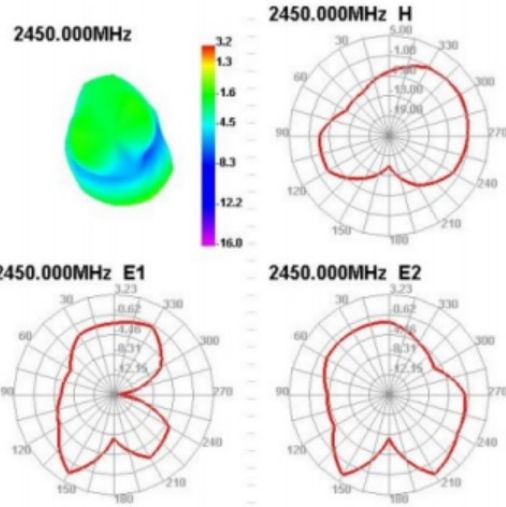

H面: XY
E1面: XZ
E2面: YZ

2500 MHz
ANT

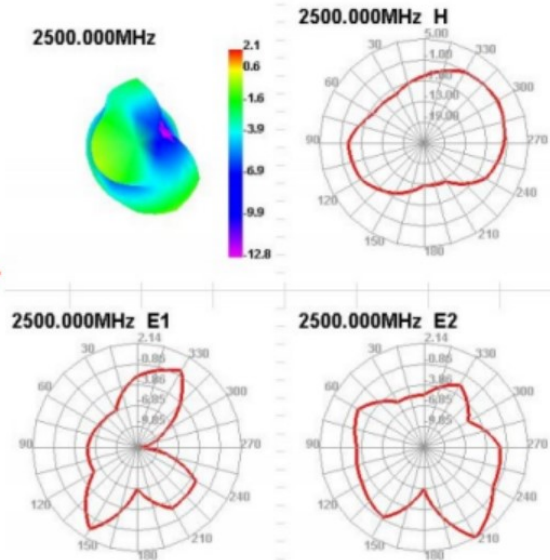

Frequency (MHz)	ANT	
	Efficiency (%)	Peak Gain (dBi)
2400	43.1	1.77
2410	44.98	1.33
2420	43.57	1.17
2430	44.18	1.34
2440	44.55	1.56
2450	45.83	2.00
2460	46.48	1.69
2470	46.31	1.42
2480	45.7	1.03
2490	44.19	1.29
2500	41.61	1.14