

**THERMAL PRINTER**

**USER'S MANUAL**

# Product list

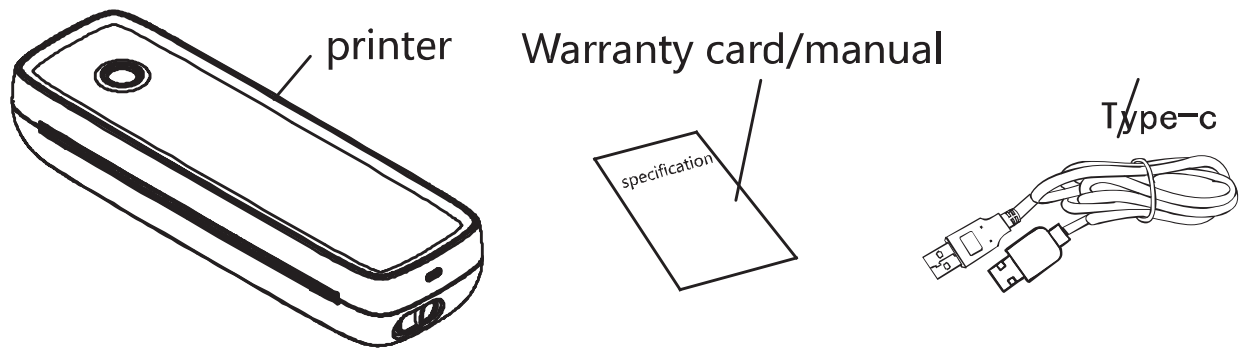

# Product introduction

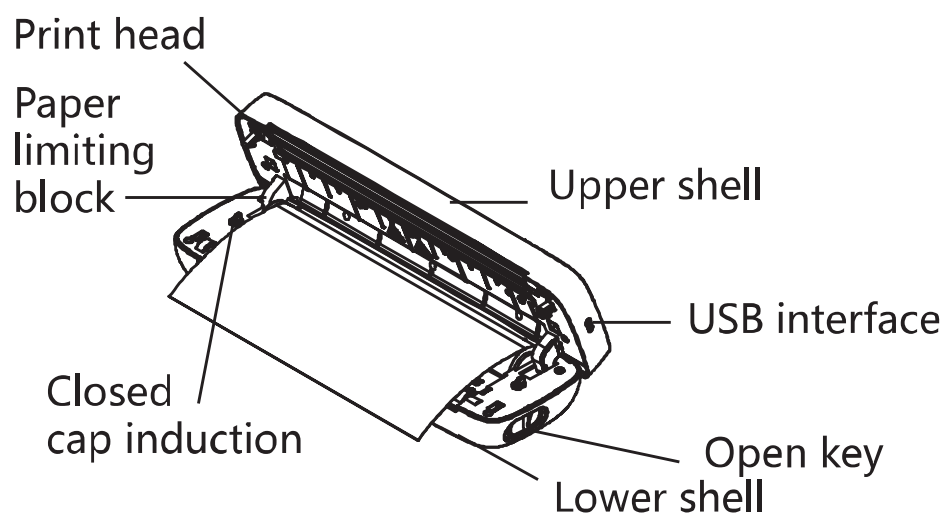

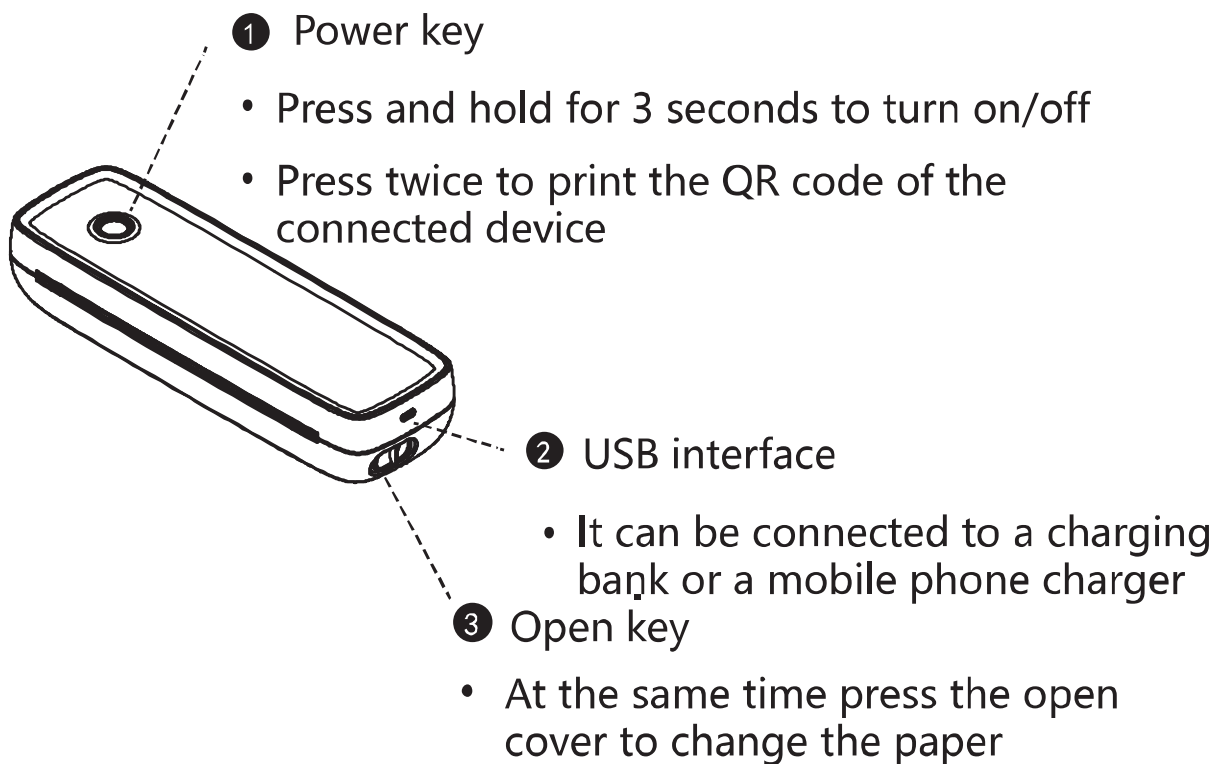

### Power indicator status

Green on: Normal print status/Fully charged

Red light on: charging in/out of paper/overheated/open cover

Blinking red: The battery is low. Please charge it in time

Blue on: The Bluetooth is connected

Blinking blue: The Bluetooth configuration is incorrect

# Download Driver

Please download the printer driver on the official website at: <http://www.ayprt.com/>

## Install the driver

a. Install the driver for windows

1. Turn on the printer, The printer connects to the computer via USB,

Find the 'A80 Windows driver' file and open it



2. Click the Install button and wait for installation

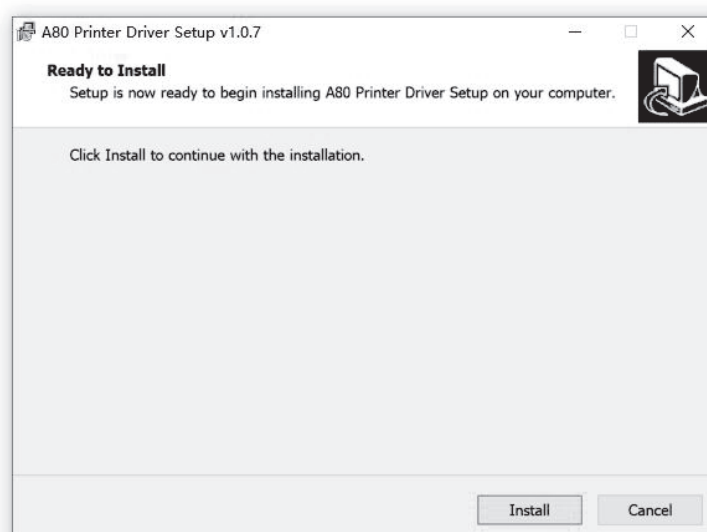

3. After the installation is successful, click Finish to exit the interface
- b. Install the driver for MAC

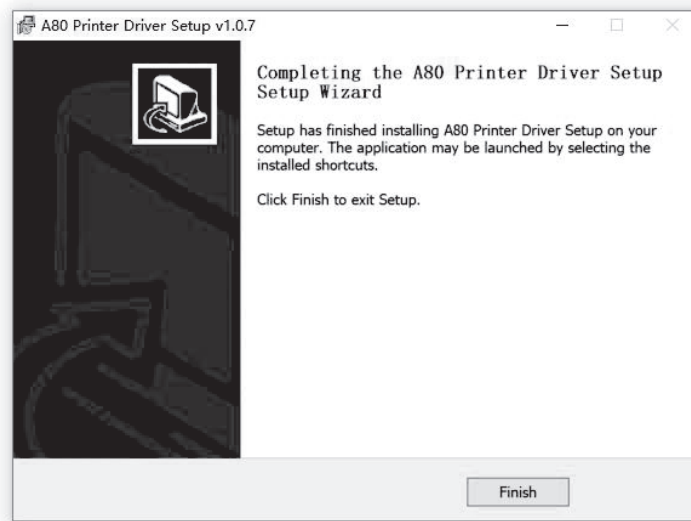

1. Turn on the printer, The printer connects to the computer via USB,  
Find the 'A80 printer driver' file and open it

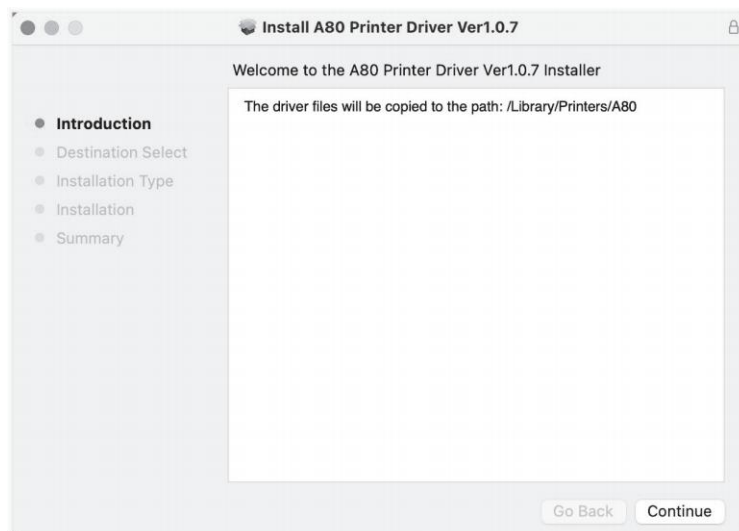

2. Click on "open" and continue to install the printer. Follow the installation steps until you see " The installation was successful"

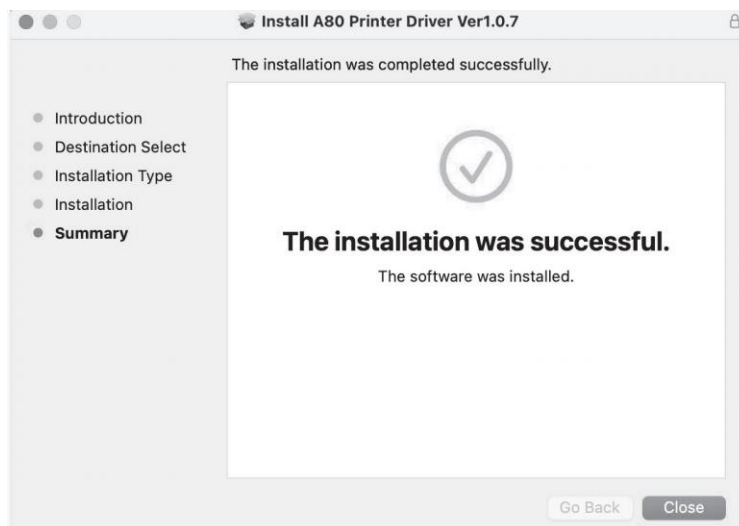
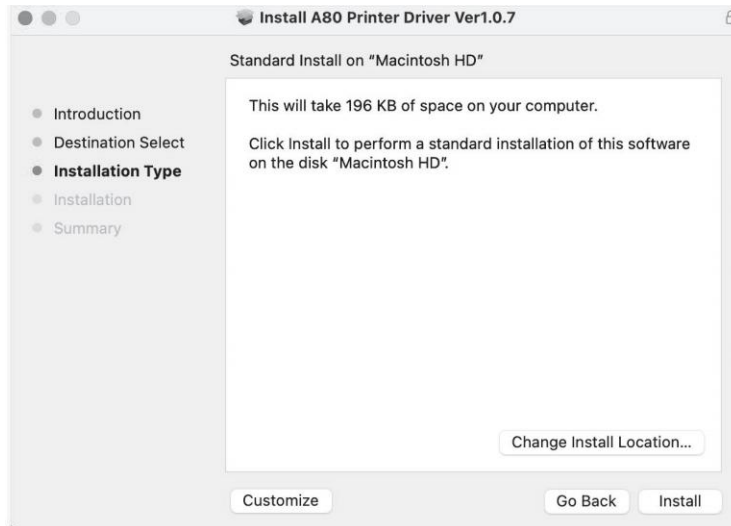

3. Follow the default mode

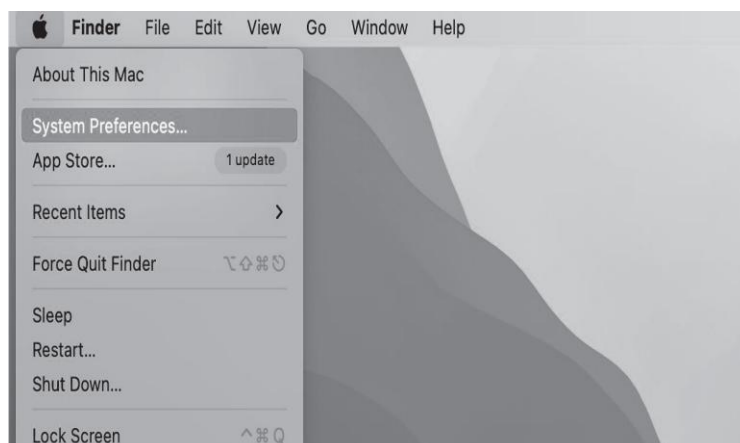

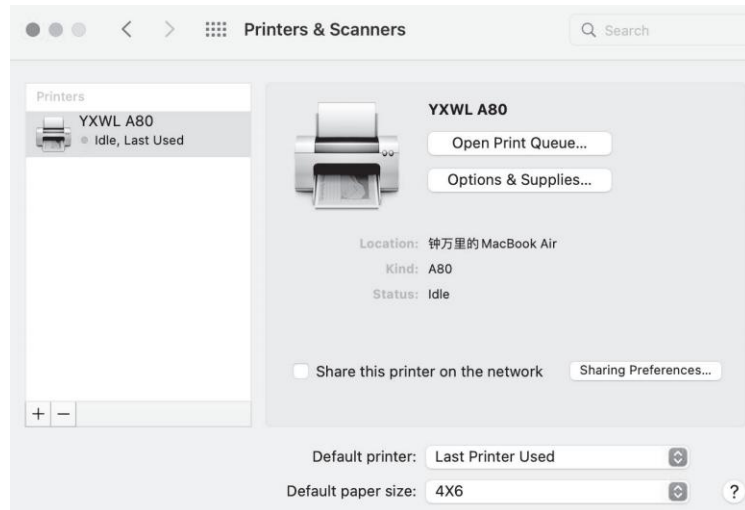
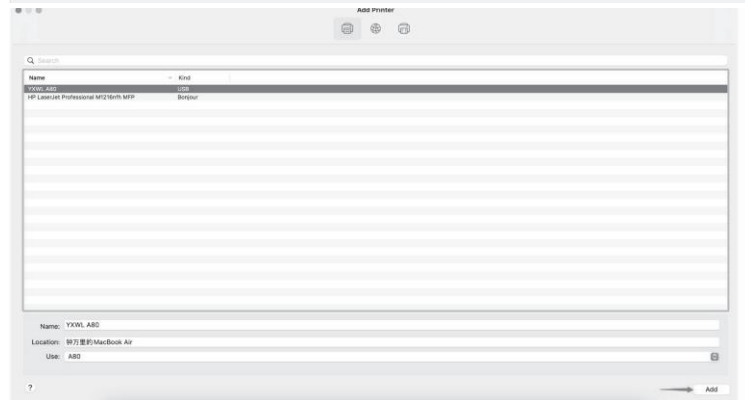
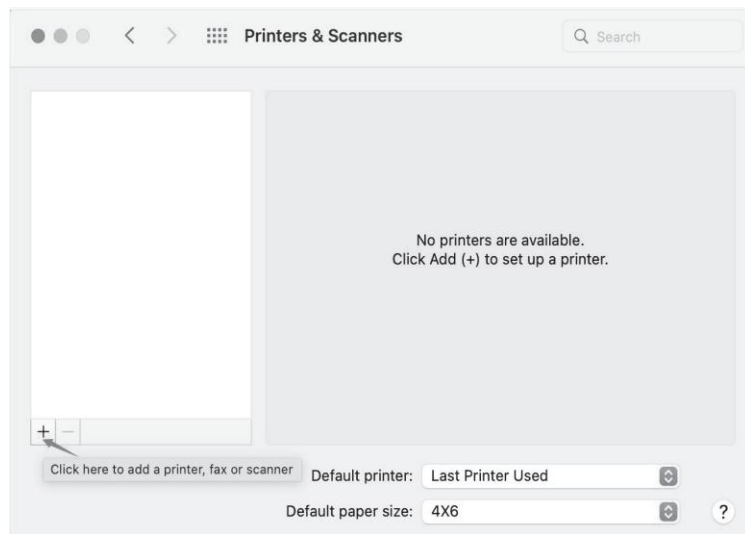
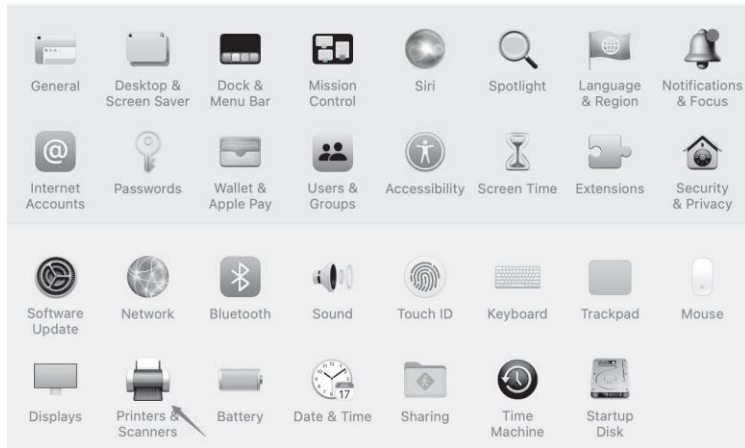

# Paper installation guide

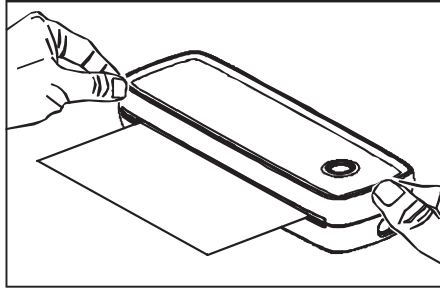

Open cover

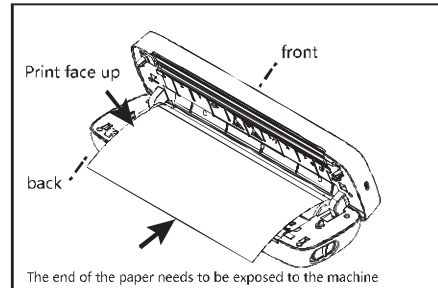

Lay down paper

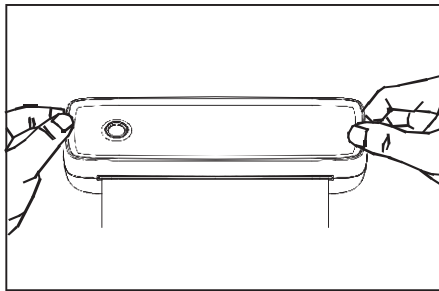

Closing cap

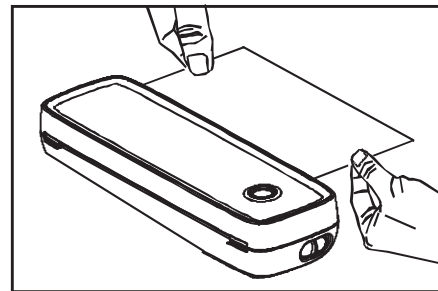

Back feed

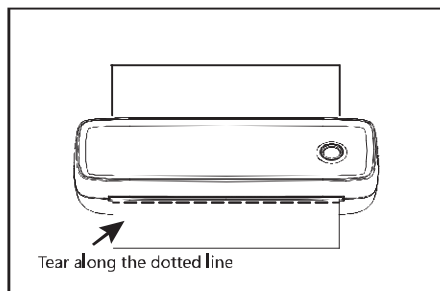

Tear apart

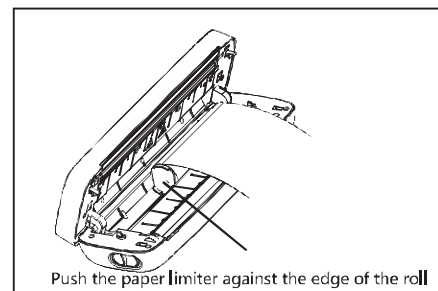

Paper limiter is used



# Charging instructions

- 5V=2A input charge, it is recommended to use mobile phone charger to charge
- It is recommended to charge the first time after purchase
- Charge once every three months, otherwise it is easy to cause lithium battery Long time natural loss, and can not charge the phenomenon

Tips: Working environment :0°C-40°C ambient temperature, relative humidity 30%-85%RH Use in (non-condensing) environment

Warning: In a residential environment, running this device may cause radio interference  
The factory standard of this product does not include a power adapter. If you use a power adapter to charge, you should purchase one  
CCC certified 5V/2A power adapter that meets the standards

This is a professional product. Please use the original battery. If you replace the original battery or use the wrong one Model batteries may explode. Dispose of used batteries according to the instructions

Please do not touch the print head directly to avoid damage, especially do not touch the print head immediately after printing, in case of overheating and scalding

## Cleaning print head

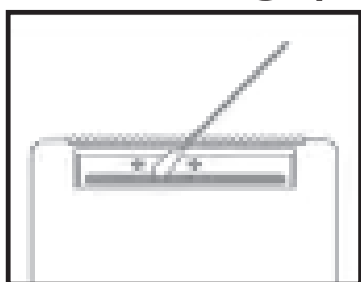

- ① Please shut down the printer, open the paper cover and take out the paper roll
- ② Dip cotton cloth or cotton swabs into it. On the medical alcohol, along the printing
- ③ head center to around the direction of gently wipe

After cleaning the print head, do not use the printer immediately. Please wait 1' 2 minutes until the alcohol has completely evaporated.

# Safety and precautions

- ① There is a built-in lithium battery, please do not use it in the environment with temperature higher than 40 °C; keep away from fire and other heat sources, and do not place it in the hot sun, such as closed car;
- ② Children should be charged and used under the supervision of adults. After full charge, please make sure to pull out the charging line in time to prevent overheating, short circuit or fire;
- ③ Do not put the product in fire or water to avoid battery short circuit or fire or burn;
- ④ The operating temperature range is 0 °C to 40 °C, please do not exceed the recommended temperature range;
- ⑤ If you suspect that there is a problem with the battery, please contact the after-sales service center for assistance.

Note: Consumers should purchase a power adapter for charging. A power adapter that has obtained the CCC certification and meets the standards.

Warning: In a residential environment, running this device may cause radio interference.

- ⚠ Please do not touch the print head directly to avoid damage, especially do not touch the print head immediately after printing, in case of overheating and scalding.

# Product specification

project	specification
Product model	
Printing mode	Row heat sensitive
Printing speed	10 mm/s(max)
Effective print width	300DPI : 2496 dots (11.8 dots/mm)
Points/point density	200DPI : 1664 dots (8 dots/mm)
Input power.	5V $\equiv$ 2A
Machine size (WxLxH)	290mm*90mm*60mm
Weight (single machine (bare))	756g
Paper type	Label paper Heat sensitive paper
Instruction format	YPL
battery	7.4V
Graphic printing	support
Man-machine interface	Key LED indicator drive
Communication interface	USB
	BT2.0 & BT4.0
Operating temperature (C)	0°C ~ +40°C
Working humidity	30% ~ 85% RH (no condensation)
Storage temperature (C)	-20°C ~ +60°C
Storage humidity	10% ~ 90% RH (no condensation)

# Product warranty card

Machine type:

Production date:

Shelf life:

Product serial number:

User information:

User name	
gender	<input type="radio"/> female <input type="radio"/> male
Mobile phone	
QQ and wechat Want Want	
Mailing address	
Dealer name	
Reasons for repair:	

- (1) Before repair, please contact the after-sales remote solution, and listen to the after-sales personnel to send back for repair
- (2) We do not accept collect express delivery back to the machine

# Warranty service policy

1. General warranty: 1 year warranty for the whole machine (excluding the print head), print head Warranty 30km or 3 months, whichever comes first. Note: Poor quality labels were used Paper and electronic face paper, will make the print head life greatly reduced, print head Sand, iron wire and other hard objects scratched and the phenomenon of broken print needle, print head surface Visible scratches, above: broken needle phenomenon due to improper operation caused by broken needles, are not Within the warranty.

2. Warranty period: The printer cannot be used normally due to repeated maintenance of quality problems And must print development technicians determine that the machine itself, we give Replacement processing; No replacement for any problem outside the warranty period.

3. Warranty content: For general after-sales problems, our after-sales personnel will pass after-sales service Service hotline, after-sales QQ, Ali Wangwang and other network tools for remote debugging services, For the product itself, the mechanism parts of the problem, need to return to the site repair.

4. If the customer has returned or replaced the product within 7 days of purchase and does not affect the secondary sales, it is allowed Apply for return and exchange service, in which the logistics costs incurred by return shall be borne by the customer. At the same time, for the damage and loss caused by customers in the logistics process, we Not taking responsibility.

5. The user is responsible for sending the product to our after-sales service department or our company authorized repair Site warranty service.

6. Our company has the right to the final interpretation of this warranty.

## FCC WARNING

This device complies with part 15 of the FCC Rules. Operation is subject to the following two conditions: (1) this device may not cause harmful interference, and (2) this device must accept any interference received, including interference that may cause undesired operation.

Any changes or modifications not expressly approved by the party responsible for compliance could void the user's authority to operate the equipment.

NOTE: This equipment has been tested and found to comply with the limits for a Class B digital device, pursuant to Part 15 of the FCC Rules. These limits are designed to provide reasonable protection against harmful interference in a residential installation. This equipment generates, uses and can radiate radio frequency energy and, if not installed and used in accordance with the instructions, may cause harmful interference to radio communications.

However, there is no guarantee that interference will not occur in a particular installation.

If this equipment does cause harmful interference to radio or television reception, which can be determined by turning the equipment off and on, the user is encouraged to try to correct the interference by one or more of the following measures:

- Reorient or relocate the receiving antenna.
- Increase the separation between the equipment and receiver.
- Connect the equipment into an outlet on a circuit different from that to which the receiver is connected.
- Consult the dealer or an experienced radio/TV technician for help.

To maintain compliance with FCC's RF Exposure guidelines, This equipment should be installed and operated with minimum distance between 20cm the radiator your body: Use only the supplied antenna.