

Description: FPC 2.4G antenna

Series: Internal Antenna

PART NUMBER: W3921XXXXX

**Features:**

- 2400-2500MHz FPC dipole
- Efficiency >50%
- Gain +1dBi
- 100mm cable length and U.FL compatible connector as standard setup, P/N W3921B0100
- Custom configurations upon request

**Applications:**

- Bluetooth, Zigbee, WiFi, BLE
- ISM 2.4GHz band radios
- Set top boxes,
- Security
- Transportation

All dimensions are in mm / inches

Issue: 2235

In the effort to improve our products, we reserve the right to make changes judged to be necessary.

CONFIDENTIAL AND PROPRIETARY INFORMATION

This document contains confidential and proprietary information of Pulse Electronics, Inc. (Pulse) and is protected by copyright, trade secret and other state and federal laws. Its receipt or possession does not convey any rights to reproduce, disclose its contents, or to manufacture, use or sell anything it may describe. Reproduction, disclosure or use without specific written authorization of Pulse is strictly forbidden.

For more information:

Pulse Worldwide Headquarters  
15255 Innovation Drive #100  
San Diego, CA 92128  
USA  
Tel:1-858-674-8100

Pulse/Larsen Antennas  
18110 SE 34<sup>th</sup> St Bldg 2 Suite 250  
Vancouver, WA 98683  
USA  
Tel: 1-360-944-7551

Europe Headquarters  
Pulse GmbH & Do, KG  
Zeppelinstrasse 15  
Herrenberg, Germany  
Tel: 49 7032 7806 0

Pulse (Suzhou) Wireless Products Co, Inc.  
99 Huo Ju Road(#29 Bldg,4<sup>th</sup> Phase  
Suzhou New District  
Jiangsu Province, Suzhou 215009 PR China  
Tel: 86 512 6807 9998



Description: FPC 2.4G antenna

Series: Internal Antenna

PART NUMBER: W3921XXXXX

**This document covers all product variants of the following product family:**

W3921B0039	39mm 1.13mm OD cable	U.FL compatible connector
W3921B0050	50mm 1.13mm OD cable	U.FL compatible connector
W3921B0100	100mm 1.13mm OD cable	U.FL compatible connector
W3921T0150	150mm 0.81mm OD cable	W.FL compatible connector
W3921B0150	150mm 1.13mm OD cable	U.FL compatible connector
W3921B0120	120mm 1.13mm OD cable	U.FL compatible connector
W3921B0200	200mm 1.13mm OD cable	U.FL compatible connector

Description: FPC 2.4G antenna

Series: Internal Antenna

PART NUMBER: W3921XXXXX

**ELECTRICAL SPECIFICATIONS**

Frequency	2400-2500MHz
Nominal Impedance	50Ω
VSWR	< 2
Gain	1dBi +/- 1 dB
Efficiency	50%
Radiation Pattern	Omni
Polarization	Linear
Power withstanding	2 W

***(\*) All RF parameters measured on 2mm thick PC plate***

Description: FPC 2.4G antenna

Series: Internal Antenna

PART NUMBER: W3921XXXXX

**MECHANICAL SPECIFICATIONS**

PCB type	Flexible
Radiator size	33[1.3] x 7.7[0.3] mm[inch]
Adhesive	3M467
Total thickness (Radiator + adhesive)	0.15[0.006] mm[inch]
Weight	about 0.37 g
Cable type	OD 1.13mm/0.81mm coaxial cable
Cable length	Optional mm[inch]
Connector	U.FL/W.FL compatible

**ENVIRONMENTAL SPECIFICATIONS**

Operating temperature	-40/+85° C
-----------------------	------------

Description: FPC 2.4G antenna

Series: Internal Antenna

PART NUMBER: W3921XXXXX

## MECHANICAL DRAWING

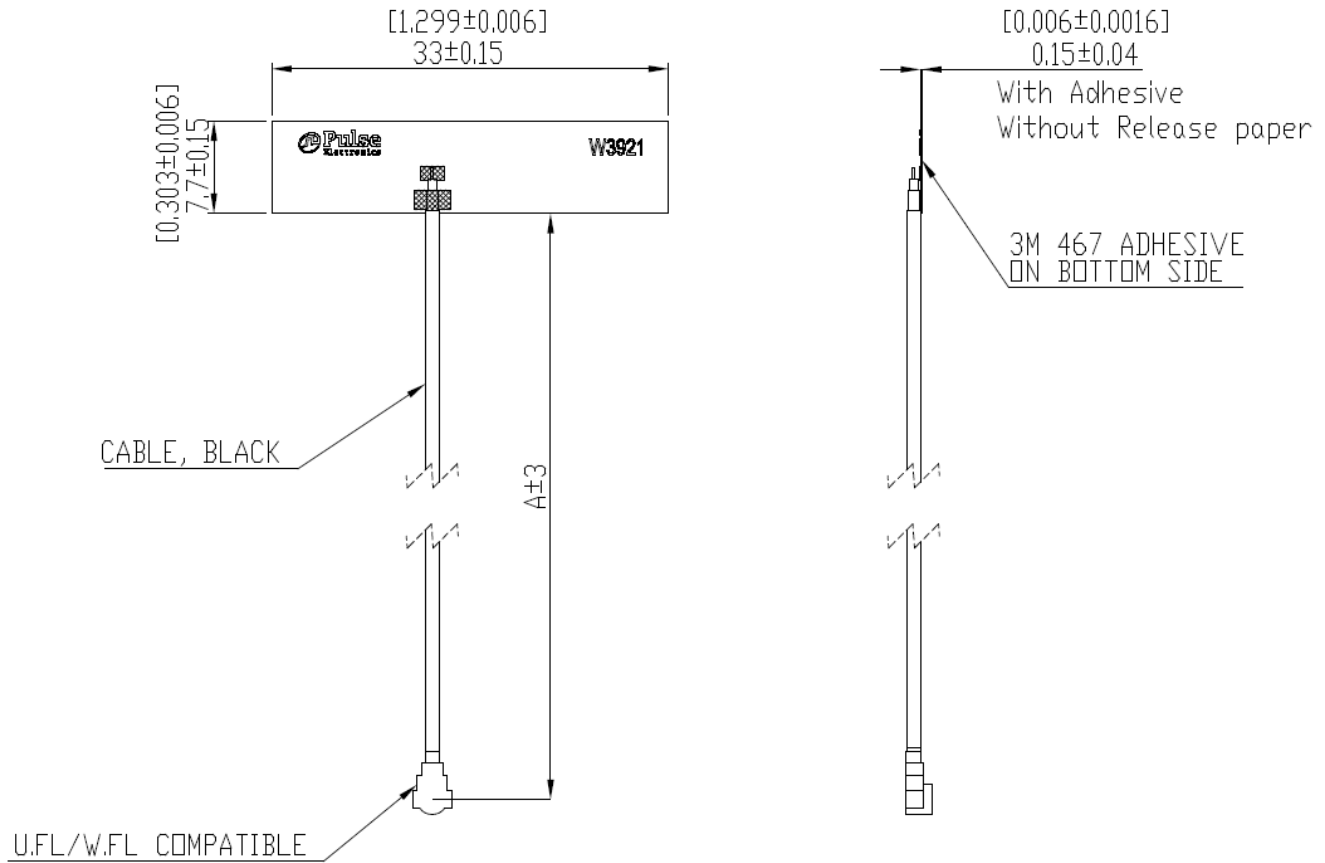

ITEM	PROJECT	A LENGTH	CABLE P/N	Cable Diameter	CONNECTOR
1	W3921B0050	50	055-2248.001	1.13mm	U.FL COMPATIBLE
2	W3921B0100	100	055-2248.002	1.13mm	U.FL COMPATIBLE
3	W3921T0150	150	055-2248.003	0.81mm	W.FL COMPATIBLE
4	W3921B0039	39	055-2248.004	1.13mm	U.FL COMPATIBLE
5	W3921B0150	150	055-2248.005	1.13mm	U.FL COMPATIBLE
6	W3921B0200	200	055-2248.006	1.13mm	U.FL COMPATIBLE
7	W3921B0120	120	055-2248.007	1.13mm	U.FL COMPATIBLE

Issue: 2235

In the effort to improve our products, we reserve the right to make changes judged to be necessary.

CONFIDENTIAL AND PROPRIETARY INFORMATION

This document contains confidential and proprietary information of Pulse Electronics, Inc. (Pulse) and is protected by copyright, trade secret and other state and federal laws. Its receipt or possession does not convey any rights to reproduce, disclose its contents, or to manufacture, use or sell anything it may describe. Reproduction, disclosure or use without specific written authorization of Pulse is strictly forbidden.

Description: FPC 2.4G antenna

Series: Internal Antenna

PART NUMBER: W3921XXXXX

## CHARTS

(\* All RF parameters measured on 2mm thick PC plate

### Return Loss

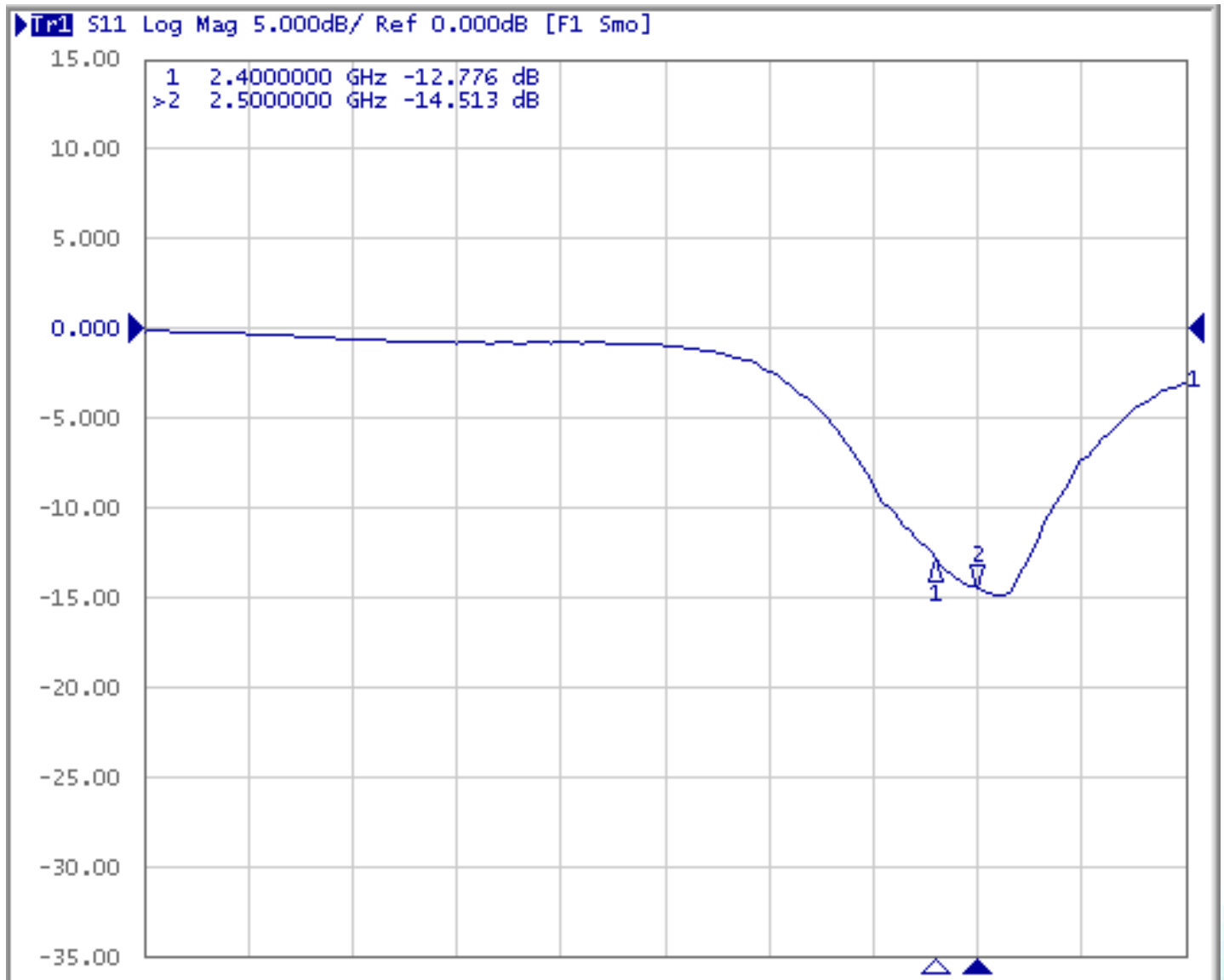

Issue: 2235

In the effort to improve our products, we reserve the right to make changes judged to be necessary.

CONFIDENTIAL AND PROPRIETARY INFORMATION

This document contains confidential and proprietary information of Pulse Electronics, Inc. (Pulse) and is protected by copyright, trade secret and other state and federal laws. Its receipt or possession does not convey any rights to reproduce, disclose its contents, or to manufacture, use or sell anything it may describe. Reproduction, disclosure or use without specific written authorization of Pulse is strictly forbidden.

Description: FPC 2.4G antenna

Series: Internal Antenna

PART NUMBER: W3921XXXXX

## CHARTS

(\*) All RF parameters measured on 2mm thick PC plate

### VSWR

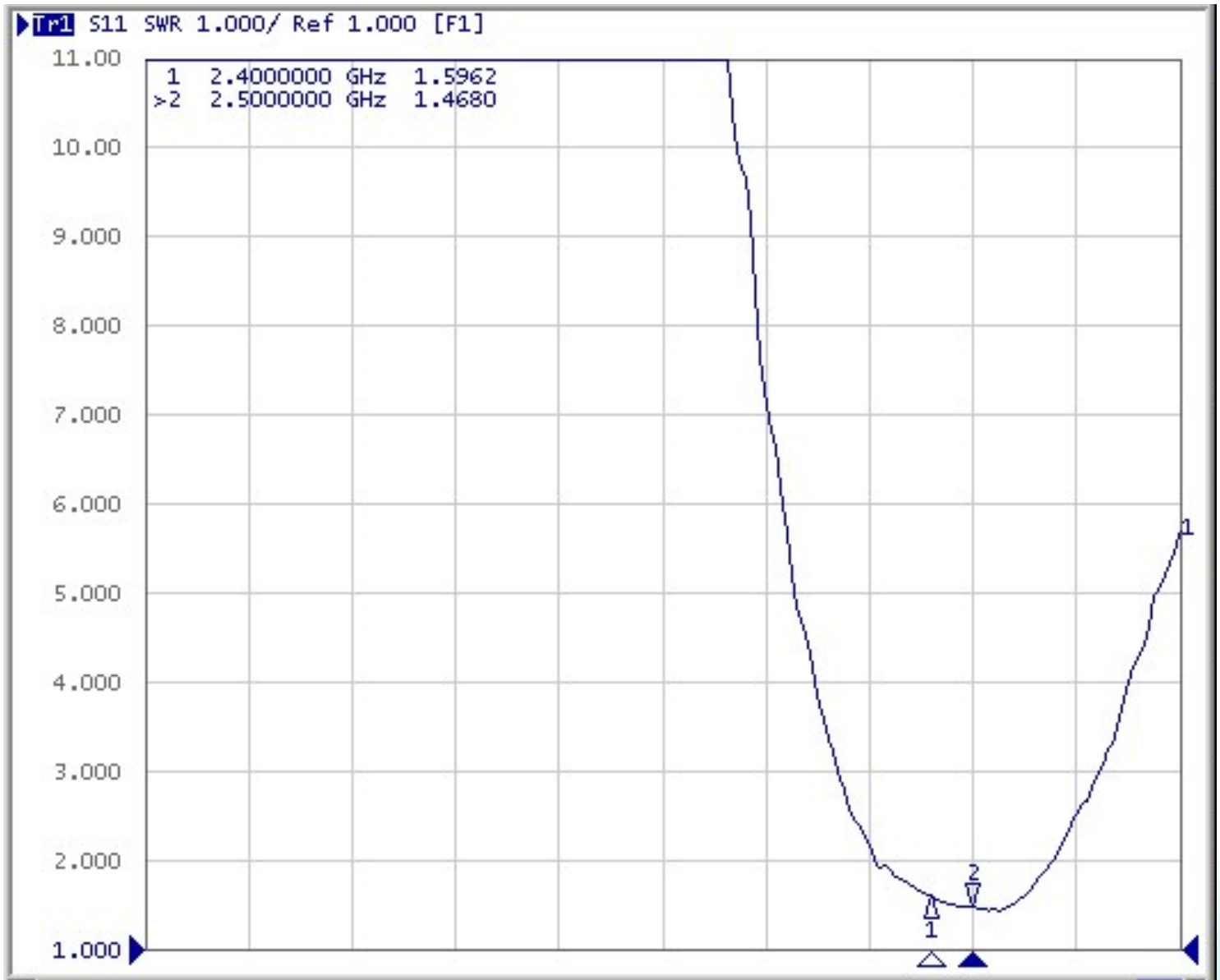

Issue: 2235

In the effort to improve our products, we reserve the right to make changes judged to be necessary.

CONFIDENTIAL AND PROPRIETARY INFORMATION

This document contains confidential and proprietary information of Pulse Electronics, Inc. (Pulse) and is protected by copyright, trade secret and other state and federal laws. Its receipt or possession does not convey any rights to reproduce, disclose its contents, or to manufacture, use or sell anything it may describe. Reproduction, disclosure or use without specific written authorization of Pulse is strictly forbidden.

Description: FPC 2.4G antenna

Series: Internal Antenna

PART NUMBER: W3921XXXXX

## CHARTS

(\* All RF parameters measured on 2mm thick PC plate  
Efficiency(%) & Gain (dBi)

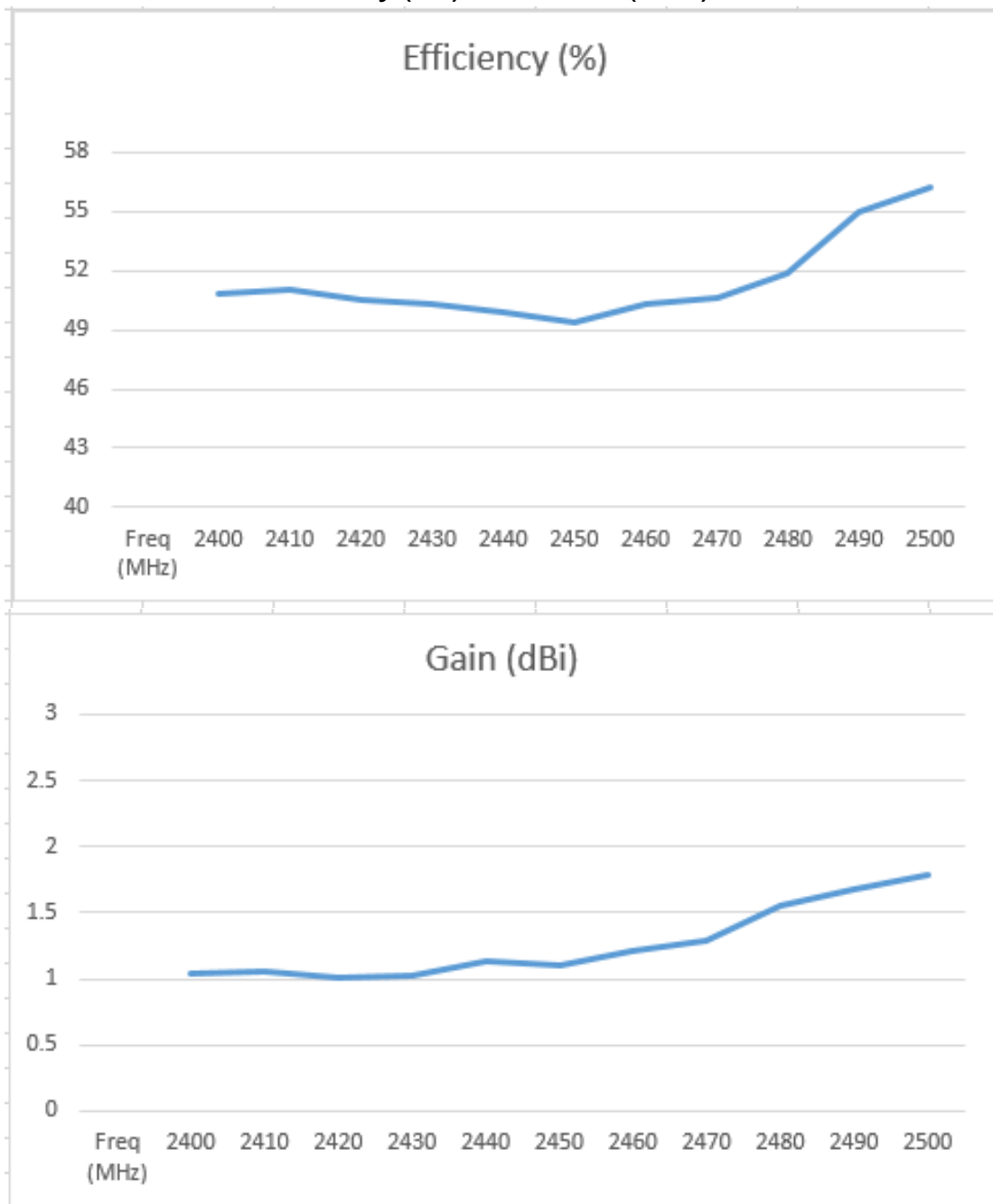

Issue: 2235

In the effort to improve our products, we reserve the right to make changes judged to be necessary.

CONFIDENTIAL AND PROPRIETARY INFORMATION

This document contains confidential and proprietary information of Pulse Electronics, Inc. (Pulse) and is protected by copyright, trade secret and other state and federal laws. Its receipt or possession does not convey any rights to reproduce, disclose its contents, or to manufacture, use or sell anything it may describe. Reproduction, disclosure or use without specific written authorization of Pulse is strictly forbidden.



Description: FPC 2.4G antenna

Series: Internal Antenna

PART NUMBER: W3921XXXXX

## CHARTS

Typical free space radiation pattern  
WIFI 2.4GHz

**(\*) All RF parameters measured on 2mm thick PC plate**

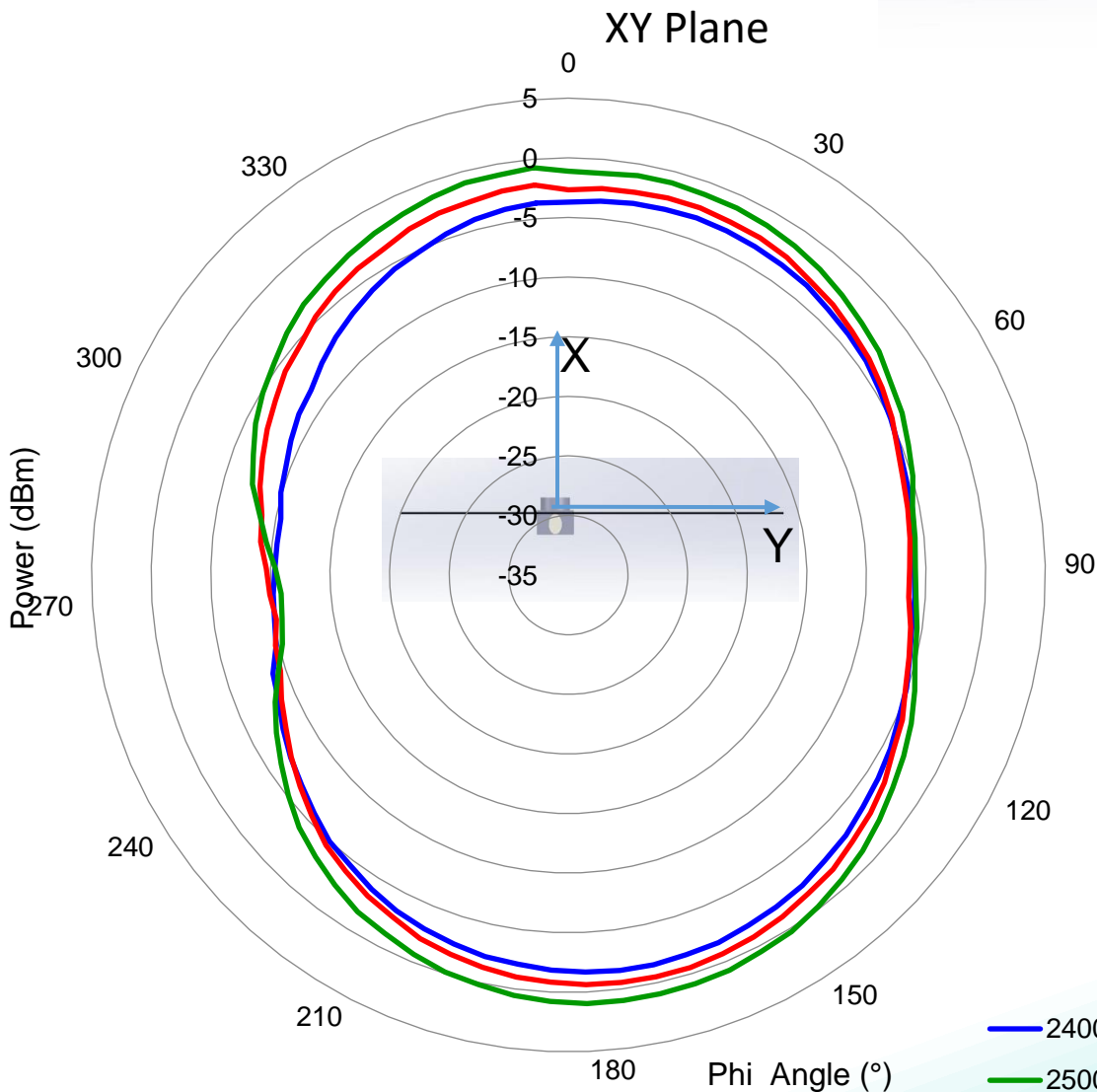
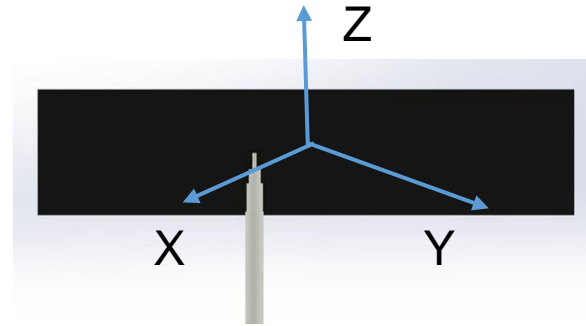

Issue: 2235

In the effort to improve our products, we reserve the right to make changes judged to be necessary.

CONFIDENTIAL AND PROPRIETARY INFORMATION

This document contains confidential and proprietary information of Pulse Electronics, Inc. (Pulse) and is protected by copyright, trade secret and other state and federal laws. Its receipt or possession does not convey any rights to reproduce, disclose its contents, or to manufacture, use or sell anything it may describe. Reproduction, disclosure or use without specific written authorization of Pulse is strictly forbidden.

Description: FPC 2.4G antenna

Series: Internal Antenna

PART NUMBER: W3921XXXXX

## CHARTS

Typical free space radiation pattern  
WIFI 2.4GHz

**(\*) All RF parameters measured on  
2mm thick PC plate**

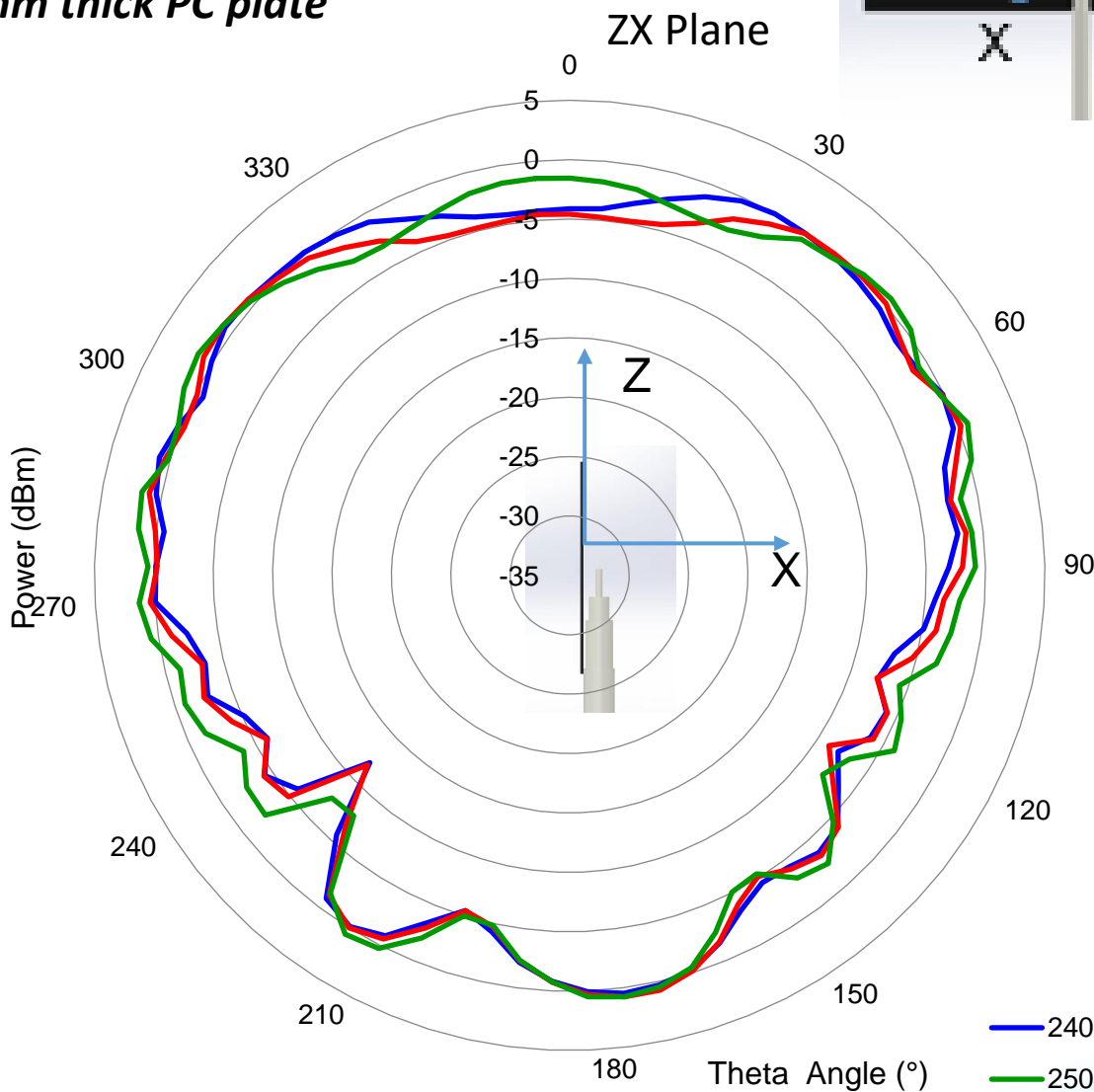
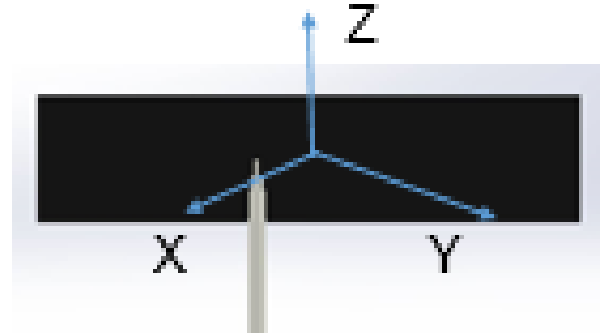

2400MHz  
Avg (dBi) = -2.49  
Peak (dBi) = 0.92  
Avg -3 (deg) = 85

2450MHz  
Avg (dBi) = -2.57  
Peak (dBi) = 1.05  
Avg -3 (deg) = 85

2500MHz  
Avg (dBi) = -1.77  
Peak (dBi) = 1.68  
Avg -3 (deg) = 77.5

Issue: 2235

In the effort to improve our products, we reserve the right to make changes judged to be necessary.

CONFIDENTIAL AND PROPRIETARY INFORMATION

This document contains confidential and proprietary information of Pulse Electronics, Inc. (Pulse) and is protected by copyright, trade secret and other state and federal laws. Its receipt or possession does not convey any rights to reproduce, disclose its contents, or to manufacture, use or sell anything it may describe. Reproduction, disclosure or use without specific written authorization of Pulse is strictly forbidden.

Description: FPC 2.4G antenna

Series: Internal Antenna

PART NUMBER: W3921XXXXX

CHARTS

Typical free space radiation pattern  
WIFI 2.4GHz

(\* All RF parameters measured on  
2mm thick PC plate

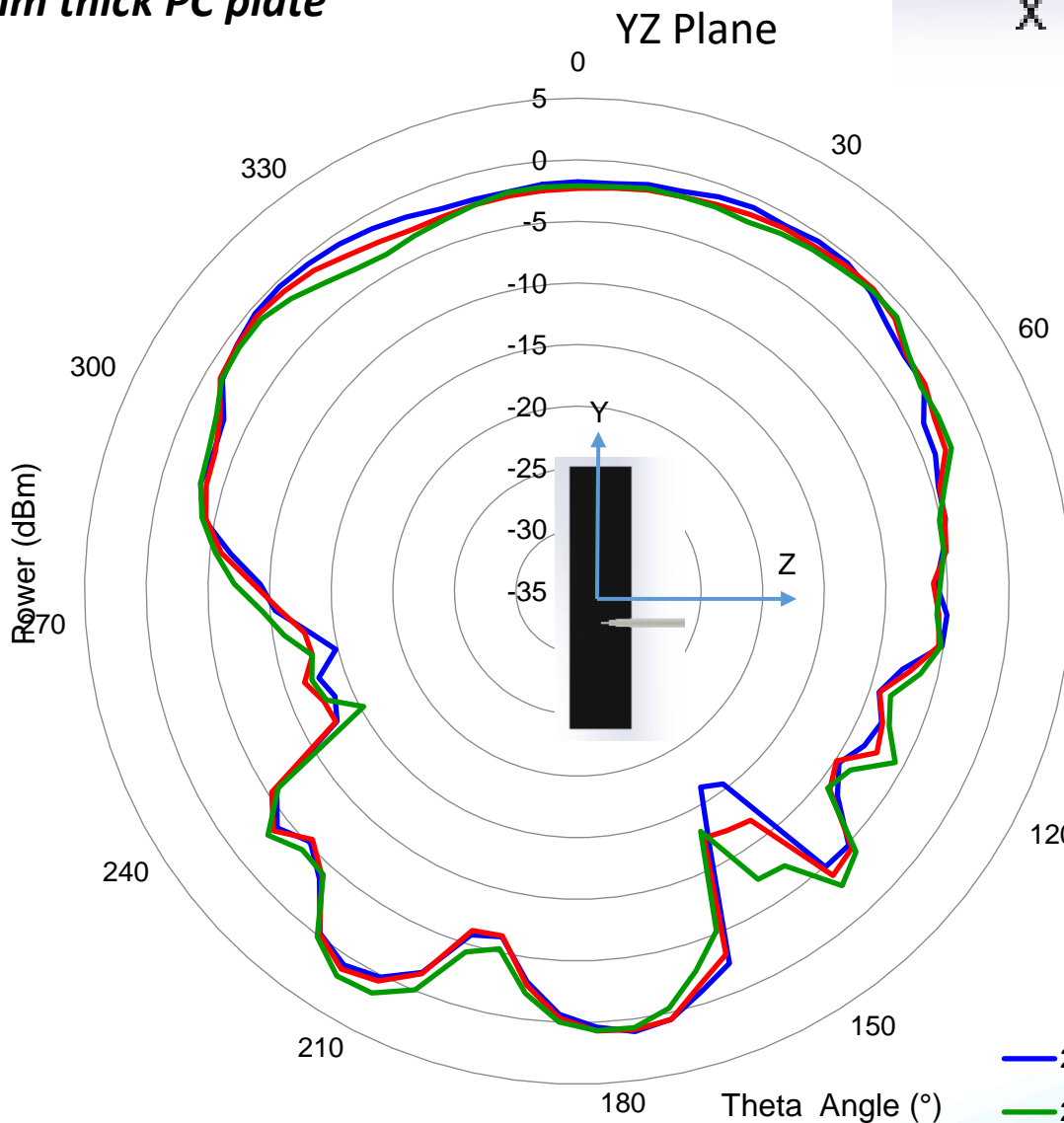
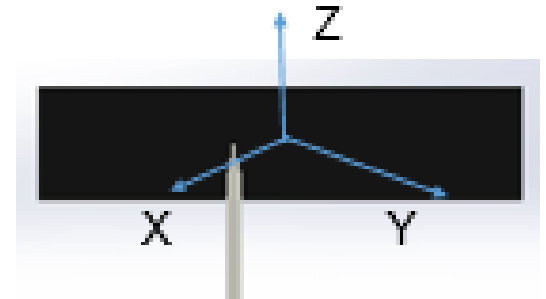

2400MHz  
Avg (dBi) = -4.38  
Peak (dBi) = 1.02  
Avg -3 (deg) = 70

2450MHz  
Avg (dBi) = -4.30  
Peak (dBi) = 1.17  
Avg -3 (deg) = 50

2500MHz  
Avg (dBi) = -4.08  
Peak (dBi) = 1.83  
Avg -3 (deg) = 27.5

— 2400MHz — 2450MHz  
— 2500MHz

Issue: 2235

In the effort to improve our products, we reserve the right to make changes judged to be necessary.

CONFIDENTIAL AND PROPRIETARY INFORMATION

This document contains confidential and proprietary information of Pulse Electronics, Inc. (Pulse) and is protected by copyright, trade secret and other state and federal laws. Its receipt or possession does not convey any rights to reproduce, disclose its contents, or to manufacture, use or sell anything it may describe. Reproduction, disclosure or use without specific written authorization of Pulse is strictly forbidden.

Description: FPC 2.4G antenna

Series: Internal Antenna

PART NUMBER: W3921XXXXX

**PACKAGING**

10PCS/PE bag

10 PE bag/foam bag

50 foam bag/ carton box

Total 5000PCS/Carton box



Issue: 2235

In the effort to improve our products, we reserve the right to make changes judged to be necessary.

CONFIDENTIAL AND PROPRIETARY INFORMATION

This document contains confidential and proprietary information of Pulse Electronics, Inc. (Pulse) and is protected by copyright, trade secret and other state and federal laws. Its receipt or possession does not convey any rights to reproduce, disclose its contents, or to manufacture, use or sell anything it may describe. Reproduction, disclosure or use without specific written authorization of Pulse is strictly forbidden.