

TEST REPORT

Client Information:

Applicant: AUO Display Plus Corporation
Applicant add.: No. 1, Gongye E. 3rd Rd., East Dist., Hsinchu Science Park, Hsinchu City 30075, Taiwan
Manufacturer: AUO Display Plus Corporation
Manufacturer add.: No. 1, Gongye E. 3rd Rd., East Dist., Hsinchu Science Park, Hsinchu City 30075, Taiwan

Product Information:

Product Name: All-in-One WorkStation
Model No.: GA27QTA01.X(x can be 0-9 which represents sales area code.)
Brand Name: AUO Display Plus
FCC ID: 2A639GA27QTA01

Applicable standards: FCC CFR Title 47 Part 15 Subpart E Section 15.407

Prepared By:

Dongguan Yaxu (AiT) Technology Limited

No.22, Jinqianling 3rd Street, Jitigang, Huangjiang, Dongguan,
Guangdong, China
Tel.: +86-769-8202 0499 Fax.: +86-769-8202 0495

Date of Receipt: 2023.04.23

Date of Test: 2023.04.23~2023.05.24

Date of Issue: 2023.05.24

Test Result: Pass

This device described above has been tested by Dongguan Yaxu (AiT) Technology Limited and the test results show that the equipment under test (EUT) is in compliance with the FCC requirements. And it is applicable only to the tested sample identified in the report.

Note: This report shall not be reproduced except in full, without the written approval of Dongguan Yaxu (AiT) Technology Limited, this document may be altered or revised by Dongguan Yaxu (AiT) Technology Limited, personal only, and shall be noted in the revision of the document. This test report must not be used by the client to claim product endorsement.

Reviewed by: 
Simba Huang

Approved by: 
Seal.chen

1 Contents

	Page
COVER PAGE	
1 CONTENTS	2
2 TEST SUMMARY	4
2.1 Statement of the Measurement Uncertainty	4
2.2 Measurement Uncertainty	4
3 TEST FACILITY	5
3.1 Deviation from standard	5
3.2 Abnormalities from standard conditions	5
3.3 Test Location	5
4 GENERAL INFORMATION	6
4.1 Test frequencies	7
4.2 EUT Peripheral List	7
4.3 Test Peripheral List	7
4.4 TEST METHODOLOGY	8
4.5 Description of Test Modes	8
5 EQUIPMENT USED DURING TEST	9
5.1 TEST METHODOLOGY	10
5.2 Description of Test Modes	10
6 SYSTEM TEST CONFIGURATION	11
6.1 Justification	11
6.2 EUT Exercise Software	11
6.3 Test Setup	11
6.4 Procedure	11
7 SYSTEM TEST CONFIGURATION	13
7.1 Standard requirement:	13
7.2 Limit:	13
8 DFS DETECTION THRESHOLD VALUES	14
9 DFS TEST SIGNALS	15
10 TEST RESULT	20
11 TEST SETUP PHOTOGRAPHS OF EUT	23
12 EXTERNAL PHOTOGRAPHS OF EUT	23
13 INTERNAL PHOTOGRAPHS OF EUT	23



Revision History

Revision	Issue Date	Revisions	Revised By
000	2023.05.24	Initial Issue	Seal Chen

2 Test Summary

Applied Standard: FCC CFR 47 PART 15.407			
Requirement	Operational Mode		RESULTS
	Master	Client	
Non-Occupancy Period	Yes	Yes	Pass
DFS Detection Threshold	Yes	Not required	Not required
Channel Availability Check Time	Yes	Not required	Not required
Channel Closing Transmission Time	Yes	Yes	Pass
Channel Move Time	Yes	Yes	Pass
U-NII Detection Bandwidth	Yes	Not required	Not required

2.1 Statement of the Measurement Uncertainty

The data and results referenced in this document are true and accurate. The reader is cautioned that there may be errors within the calibration limits of the equipment and facilities. The measurement uncertainty was calculated for all measurements listed in this test report acc. To CISPR 16 – 4 “Specification for radio disturbance and immunity measuring apparatus and methods – Part 4: Uncertainty in EMC Measurements” and is documented in the AiT quality system acc. To DIN EN ISO/IEC 17025. Furthermore, component and process variability of devices similar to that tested may result in additional deviation. The manufacturer has the sole responsibility of continued compliance of the device.

2.2 Measurement Uncertainty

No.	Item	Uncertainty
1	DFS Threshold (radiated)	±1.50dB
2	DFS Threshold (conducted)	±1.45dB
3	Temperature	±0.5°C
4	Humidity	±2%

(1). This uncertainty represents an expanded uncertainty expressed at approximately the 95% confidence level using a coverage factor of k=2.

3 Test Facility

The test facility is recognized, certified or accredited by the following organizations:

.CNAS- Registration No: L6177

Dongguan Yaxu (AiT) technology Limited is accredited to ISO/IEC 17025:2017 general Requirements for the competence of testing and calibration laboratories (CNAS-CL01 Accreditation Criteria for the competence of testing and calibration laboratories) on April 18, 2022

FCC-Registration No.: 703111 Designation Number: CN1313

Dongguan Yaxu (AiT) technology Limited has been registered and fully described in a report filed with the (FCC) Federal Communications Commission. The acceptance letter from the FCC is maintained in our files.

IC —Registration No.: 6819A CAB identifier: CN0122

The 3m Semi-anechoic chamber of Dongguan Yaxu (AiT) technology Limited has been registered by Certification and Engineering Bureau of Industry Canada for radio equipment testing with Registration No.: 6819A

A2LA-Lab Cert. No.: 6317.01

Dongguan Yaxu (AiT) technology Limited has been accredited by A2LA for technical competence in the field of electrical testing, and proved to be in compliance with ISO/IEC 17025: 2017 General Requirements for the Competence of Testing and Calibration Laboratories and any additional program requirements in the identified field of testing.

3.1 Deviation from standard

None

3.2 Abnormalities from standard conditions

None

3.3 Test Location

Dongguan Yaxu (AiT) Technology Limited

Address: No.22, Jinqianling 3rd Street, Jitigang, Huangjiang, Dongguan, Guangdong, China

Tel.: +86-769-8202 0499

Fax.: +86-769-8202 0495

4 General Information

EUT Name:	All-in-One WorkStation			
Model No:	GA27QTA01.X(x can be 0-9 which represents sales area code.)			
Serial Model:	N/A			
Test sample(s) ID:	AIT23042306-1			
Sample(s) Status:	Engineer sample			
Operation frequency:	Band	Mode	Frequency Range(MHz)	Number of channels
	U-NII Band II-B	IEEE 802.11a	5500-5700	2
		IEEE 802.11n/ac/ax20MHz	5500-5700	2
		IEEE 802.11n/ac/ax 40MHz	5510-5670	2
		IEEE 802.11ac/ax 80MHz	5530-5610	2
	U-NII Band II-A	IEEE 802.11a	5260-5320	4
		IEEE 802.11n/ac/ax 20MHz	5260-5320	4
		IEEE 802.11n/ac/ax 40MHz	5270-5310	2
IEEE 802.11ac/ax 80MHz		5290	1	
Modulation Technology:	OFDM			
Modulation Type	IEEE 802.11a/n/ac/ax: OFDM(64QAM, 16QAM, QPSK, BPSK)			
Antenna Type:	FPC antenna			
Antenna gain:	Antenna 0 : 0.94dBi,Antenna 1 : 1.33dBi for 5150~5350MHz; Antenna 0 : 2.35dBi,Antenna 1 : 1.39dBi for 5360~5720MHz;			
Hardware version.:	N/A.			
Software version.:	N/A.			
Power supply:	DC 19.5V, 9.23A by Adapter			
Difference Description	N/A.			

Note:

For a more detailed features description, please refer to the manufacturer’s specifications or the User’s Manual.

4.1 Test frequencies

EUT channels and frequencies list:

Channel list for 802.11a/n(HT20)/ax(HE20)							
Channel	Frequency	Channel	Frequency	Channel	Frequency	Channel	Frequency
36	5180MHz	40	5200MHz	44	5220MHz	48	5240MHz
52	5260MHz	56	5280MHz	60	5300MHz	64	5320MHz
100	5500MHz	140	5700MHz				

Channel list for 802.11n(HT40)/ax(HE40)							
Channel	Frequency	Channel	Frequency	Channel	Frequency	Channel	Frequency
38	5190MHz	46	5230MHz	54	5270MHz	62	5310MHz
102	5510MHz	134	5670MHz				

Channel list for 802.11ac(HT80)/ax(HE80)							
Channel	Frequency	Channel	Frequency	Channel	Frequency	Channel	Frequency
42	5210MHz	58	5290MHz	106	--	122	--
106	5530MHz	122	5610MHz				

4.2 EUT Peripheral List

No.	Equipment	Manufacturer	EMC Compliance	Model No.	Serial No.	Power Cord	Signal Cord
1	Adapter	N/A	N/A	N/A	N/A	N/A	N/A

4.3 Test Peripheral List

No.	Equipment	Manufacturer	EMC Compliance	Model No.	Serial No.	Power Cord	Signal Cord
1	PC	N/A	N/A	N/A	N/A	N/A	N/A

4.4 TEST METHODOLOGY

This report has been prepared to demonstrate compliance with the requirements for Dynamic Frequency Selection (DFS) as stated in FCC CFR 47 PART 15E(15.407). Testing was performed in accordance with the measurement procedure described in FCC KDB 905462 D02 v02

4.5 Description of Test Modes

The EUT has been tested under operating condition.

Worst-Case data rates were utilized from preliminary testing of the Chipset, worst-case data rates used during the testing are as follows:

IEEE 802.11ac VHT80 Mode: MCS0, OFDM.

5 Equipment Used during Test

No	Test Equipment	Manufacturer	Model No	Serial No	Cal. Date	Cal. Due Date
1	Spectrum Analyzer	R&S	FSV40	101470	2022.09.02	2023.09.01
2	EMI Measuring Receiver	R&S	ESR	101160	2022.09.02	2023.09.01
3	Low Noise Pre Amplifier	HP	HP8447E	AiT-F01319	2022.09.02	2023.09.01
4	Low Noise Pre Amplifier	Tsj	MLA-0120-A02 -34	2648A04738	2022.09.02	2023.09.01
5	Passive Loop	ETS	6512	00165355	2020.09.05	2022.09.04
6	TRILOG Super Broadband test Antenna	SCHWARZBECK	VULB9160	9160-3206	2021.08.29	2024.08.28
7	Broadband Horn Antenna	SCHWARZBECK	BBHA9120D	452	2021.08.29	2024.08.28
8	SHF-EHF Horn Antenna 15-40GHz	SCHWARZBECK	BBHA9170	BBHA9170367 d	2020.11.24	2023.11.23
9	EMI Test Receiver	R&S	ESCI	100124	2022.09.02	2023.09.01
10	LISN	Kyoritsu	KNW-242	8-837-4	2022.09.02	2023.09.01
11	LISN	R&S	ESH3-Z2	0357.8810.54- 101161-S2	2022.09.02	2023.09.01
12	Pro.Temp&Humi.chamber	MENTEK	MHP-150-1C	MAA08112501	2022.09.02	2023.09.01
13	RF Automatic Test system	MW	MW100-RFCB	21033016	2022.09.02	2023.09.01
14	Signal Generator	Agilent	N5182A	MY50143009	2022.09.02	2023.09.01
15	Wideband Radio communication tester	R&S	CMW500	1201.0002K50	2022.09.02	2023.09.01
16	RF Automatic Test system	MW	MW100-RFCB	21033016	2022.09.02	2023.09.01
17	DC power supply	ZHAOXIN	RXN-305D-2	28070002559	N/A	N/A
18	RE Software	EZ	EZ-EMC_RE	Ver.AIT-03A	N/A	N/A
19	CE Software	EZ	EZ-EMC_CE	Ver.AIT-03A	N/A	N/A
20	RF Software	MW	MTS 8310	2.0.0.0	N/A	N/A
21	temporary antenna connector(Note)	NTS	R001	N/A	N/A	N/A

Note: The temporary antenna connector is soldered on the PCB board in order to perform conducted tests and this temporary antenna connector is listed in the equipment list.

5.1 TEST METHODOLOGY

This report has been prepared to demonstrate compliance with the requirements for Dynamic Frequency Selection (DFS) as stated in FCC CFR 47 PART 15E(15.407). Testing was performed in accordance with the measurement procedure described in FCC KDB 905462 D02 v02

5.2 Description of Test Modes

The EUT has been tested under operating condition.

Worst-Case data rates were utilized from preliminary testing of the Chipset, worst-case data rates used during the testing are as follows:

IEEE 802.11ac VHT80 Mode: MCS0, OFDM.

6 SYSTEM TEST CONFIGURATION

6.1 Justification

1. Connect FCC approved Master AP to a network, via wired Ethernet, that allows connection to an FTP server.
2. Associate the EUT with the Master AP.
3. Launch the FTP application on the EUT.
4. Connect to the FTP server application to the FTP server hosting the file
5. Initiate an FTP download of the file from the host.
6. Monitor the channel loading during transfer.
7. Reduce the maximum allowed data rate for the Master AP, using the AP's GUI interface.
8. Repeat steps 4-6 until the channel loading is as close to 20 % as possible.
9. Record the data rate setting on the Master AP and the channel loading.
10. While the system is performing an FTP transfer using the settings from item 8 above, perform the Channel Closing Transmission Time and Channel Move Time Measurements as required by KDB905462 D02 v02 using a conducted test.

6.2 EUT Exercise Software

The system is configured to test under continuous transmission conditions and change the test channel by means of instruction codes.

6.3 Test Setup

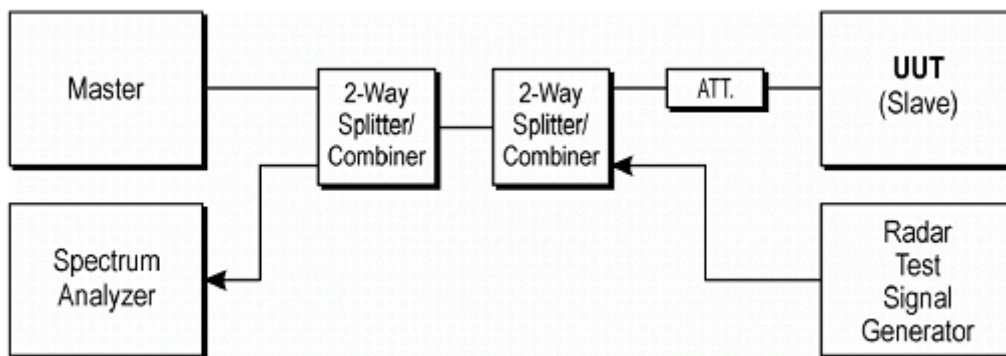

6.4 Procedure

The KDB905462 D02 v02 describes a conducted test setup. Each one channel selected between bands 2, band 3 is chosen for the testing.

1. The radar pulse generator is setup to provide a pulse at the frequency that the Master and Client are operating. A Type 0 radar pulse with a 1 μ s pulse width and a 1428 μ s PRI is used for the testing.

2. The vector signal generator is adjusted to provide the radar burst (18 pulses) at a level of approximately -62 dBm at the antenna of the Master device.
3. The Client Device (EUT) is set up per the diagram in Figure 3-1 and communications between the Master device and the Client is established.
4. The MPEG file specified by the FCC ("6½ Magic Hours") is streamed from the "file computer" through the Master to the Slave Device and played in full motion video using Media Player Classic Ver.6.4.8.6 in order to properly load the network.
5. The spectrum analyzer is set to record about 15 sec window to any transmissions occurring up to and after 10 sec.
6. The system is again setup and the monitoring time is shortened in order to capture the Channel Closing Transmission Time. This time is measured to insure that the Client ceases transmission within 200 ms and the aggregate of emissions occurring after 200 ms up to 10 sec do not exceed 60 ms.

(Note: the channel may be different since the Master and Client have changed channels due to the detection of the initial radar pulse.)

7. After the initial radar burst the channel is monitored for 30 minutes to insure no transmissions or beacons occur. A second monitoring setup is used to verify that the Master and Client have both moved to different channels.

7 SYSTEM TEST CONFIGURATION

7.1 Standard requirement:

KDB905462 D02 v02 (04/08/2016) the following are the requirements for Client Devices:

1) A Client Device will not transmit before having received appropriate control signals from a Master Device.

2) A Client Device will stop all its transmissions whenever instructed by a Master Device to which it is associated and will meet the Channel Move Time and Channel Closing Transmission Time requirements.

The Client Device will not resume any transmissions until it has again received control signals from a Master Device.

3) If a Client Device is performing In-Service Monitoring and detects a Radar Waveform above the DFS Detection Threshold, it will inform the Master Device. This is equivalent to the Master Device detecting the Radar Waveform and d) through f) of section 5.1.1(KDB905462 D02 v02) apply.

4) Irrespective of Client Device or Master Device detection the Channel Move Time and Channel Closing Transmission Time requirements remain the same.

7.2 Limit:

Parameter	Value
Non-occupancy period	Minimum 30 minutes
Channel Availability Check Time	60 seconds
Channel Move Time	10 seconds See Note 1.
Channel Closing Transmission Time	200 milliseconds + an Aggregate of 60 milliseconds over Remaining 10 second period. See Notes 1 and 2.
U-NII Detection Bandwidth	Minimum 100 % of the U-NII 99 % transmission power bandwidth. See Note 3.

Note 1: Channel Move Time and the Channel Closing Transmission Time should be performed with Radar Type 0. The measurement timing begins at the end of the Radar Type 0 burst.

Note 2: The Channel Closing Transmission Time is comprised of 200 milliseconds starting at the beginning of the Channel Move Time plus any additional intermittent control signals required to facilitate a Channel move (an aggregate of 60 milliseconds) during the remainder of the 10 second period. The aggregate duration of control signals will not count quiet periods in between transmissions.

Note 3: During the U-NII Detection Bandwidth detection test, radar type 0 should be used. For each frequency step the minimum percentage of detection is 90 percent. Measurements are performed with no data traffic.

8 DFS DETECTION THRESHOLD VALUES

The DFS detection thresholds are defined for Master devices and Client Devices with In-service monitoring. These detection thresholds are listed in the following table.

Maximum Transmit Power	Value (See Notes 1 and 2)
EIRP \geq 200 milliwatt	-64 dBm
EIRP < 200 milliwatt and Power spectral < 10 dBm/MHz	-62 dBm
EIRP < 200 milliwatt that do not meet the power spectral density requirement	-64 dBm

Note 1: This is the level at the input of the receiver assuming a 0 dBi receive antenna.

Calibration:

The EUT is slave equipment with a max gain is 2.01dBi; running flow should reach more than 50%.

For a detection threshold level of -62dBm and the master (Brand: Samsung), Model: S2LF812265, FCC ID: A3LWEA453E) antenna gain is 3.0 dBi, required detection threshold is -59.00 dBm (= -62 + 3.0)

Maximum transmit power is less than 200 milliwatt in this report, so detection threshold level is -62dBm.

Note 2: Throughout these test procedures an additional 1 dB has been added to the amplitude of the test transmission waveforms to account for variations in measurement equipment. This will ensure that the test signal is at or above the detection threshold level to trigger a DFS response.

Note 3: EIRP is based on the highest antenna. For MIMO devices refer to KDB Publication 662911 D01.

9 DFS TEST SIGNALS

As the EUT is a Client Device with no Radar Detection only one type radar pulse is required for the testing. Radar Pulse type 0 was used in the evaluation of the Client device for the purpose of measuring the Channel Move Time and the Channel Closing Transmission Time.

Table 5 – Short Pulse Radar Test Waveforms

Radar Type	Pulse Width (µsec)	PRI (µsec)	Number of Pulses	Minimum Percentage of Successful Detection	Minimum Number of Trials
0	1	1428	18	See Note 1	See Note 1
1	1	Test A: 15 unique PRI values randomly selected from the list of 23 PRI values in Table 5a	Roundup $\left\{ \begin{matrix} \left(\frac{1}{360} \right) \cdot \\ \left(\frac{19 \cdot 10^6}{PRI_{\mu sec}} \right) \end{matrix} \right\}$	60%	30
		Test B: 15 unique PRI values randomly selected within the range of 518-3066 µsec, with a minimum increment of 1 µsec, excluding PRI values selected in Test A			
2	1-5	150-230	23-29	60%	30
3	6-10	200-500	16-18	60%	30
4	11-20	200-500	12-16	60%	30
Aggregate (Radar Types 1-4)				80%	120
Note 1: Short Pulse Radar Type 0 should be used for the detection bandwidth test, channel move time, and channel closing time tests.					

A minimum of 30 unique waveforms are required for each of the Short Pulse Radar Types 2 through 4. If more than 30 waveforms are used for Short Pulse Radar Types 2 through 4, then each additional waveform must also be unique and not repeated from the previous waveforms. If more than 30 waveforms are used for Short Pulse Radar Type 1, then each additional waveform is generated with Test B and must also be unique and not repeated from the previous waveforms in Tests A or B.

Table 6 – Long Pulse Radar Test Waveform

Radar Type	Pulse Width (µsec)	Chirp Width (MHz)	PRI (µsec)	Number of Pulses per Burst	Number of Bursts	Minimum Percentage of Successful Detection	Minimum Number of Trials
5	50-100	5-20	1000-2000	1-3	8-20	80%	30

The parameters for this waveform are randomly chosen. Thirty unique waveforms are required for the Long Pulse Radar Type waveforms. If more than 30 waveforms are used for the Long Pulse Radar Type waveforms, then each additional waveform must also be unique and not repeated from the previous waveforms.

Table 7 – Frequency Hopping Radar Test Waveform

Radar Type	Pulse Width (μsec)	PRI (μsec)	Pulses per Hop	Hopping Rate (kHz)	Hopping Sequence Length (msec)	Minimum Percentage of Successful Detection	Minimum Number of Trials
6	1	333	9	0.333	300	70%	30

Table 5a - Pulse Repetition Intervals Values for Test A

Pulse Repetition Frequency Number	Pulse Repetition Frequency (Pulses Per Second)	Pulse Repetition Interval (Microseconds)
1	1930.5	518
2	1858.7	538
3	1792.1	558
4	1730.1	578
5	1672.2	598
6	1618.1	618
7	1567.4	638
8	1519.8	658
9	1474.9	678
10	1432.7	698
11	1392.8	718
12	1355	738
13	1319.3	758
14	1285.3	778
15	1253.1	798
16	1222.5	818
17	1193.3	838
18	1165.6	858
19	1139	878
20	1113.6	898
21	1089.3	918
22	1066.1	938
23	326.2	3066

Manufacturer’s Statement Regarding Uniform Channel Spreading

The end product implements an automatic channel selection feature at startup such that operation commences on channels distributed across the entire set of allowed 5GHz channels. This feature will ensure uniform spreading is achieved while avoiding non-allowed channels due to prior radar events.

TEST AND MEASUREMENT SYSTEM

System Overview

The measurement system is based on a conducted test method. The short pulse and long pulse signal generating system utilizes the NTIA software and the same

manufacturer / model Vector Signal Generator as the NTIA. The hopping signal generating system utilizes the simulated hopping method.

The software selects waveform parameters from within the bounds of the signal type on a random basis using uniform distribution. The short pulse types 2, 3 and 4, and the long pulse type 5 parameters are randomized at run-time. The hopping type 6 pulse parameters are fixed while the hopping sequence is based on the August 2005 NTIA Hopping Frequency List, with the initial starting point randomized at run-time.

The signal monitoring equipment consists of a spectrum analyzer with the capacity to display 8192 bins on the horizontal axis. A time-domain resolution of 2 msec / bin is achievable with a 16 second sweep time, meeting the 10 second short pulse reporting criteria. The aggregate ON time is calculated by multiplying the number of bins above a threshold during a particular observation period by the dwell time per bin, with the analyzer set to peak detection and max hold. A time-domain resolution of 3 msec / bin is achievable with a 24 second sweep time, meeting the 22 second long pulse reporting criteria and allowing a minimum of 10 seconds after the end of the long pulse waveform.

Frequency Hopping Signal Generation

The hopping burst generator is a High Speed Digital I/O card plugged into the control computer. This card utilizes an independent hardware clock reference therefore the output pulse timing is unaffected by host computer operating system latency times.

The software selects the hopping sequence as a 100-length segment of the August 2005 NTIA hopping frequency list. This list contains 274 unique pseudorandom sequences. Each such sequence contains 475 frequencies ordered on a random without replacement basis. Each successive trial uses a contiguous 100-length segment from within each successive 475-length sequence in the list. The initial starting point within the list is randomized at run-time such that the first 100-length segment is entirely contained within the first 475-length sequence. The starting point of each successive trial is incremented by 475.

Each frequency in the 100-length segment is compared to the boundaries of the EUT Detection Bandwidth and the software creates a hopping burst pattern in accordance with Section 7.4.1.3 Method #2 Simulated Frequency Hopping Radar Waveform Generating Subsystem of FCC 06-96 APPENDIX. The frequency of the signal generator is incremented in 1 MHz steps from FL to FH for each successive trial. This incremental sequence is repeated as required to generate a minimum of 30 total trials and to maintain a uniform frequency distribution over the entire Detection Bandwidth.

Conducted Method System Block Diagram

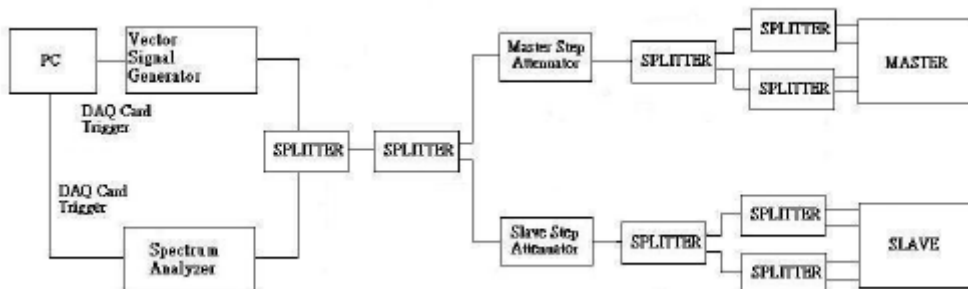

Measurement System Frequency Reference

Lock the signal generator and the spectrum analyzer to the same reference source as follows: Connect the 10 MHz OUT (SWITCHED) on the spectrum analyzer to the 10 MHz IN on the signal generator and

set the spectrum analyzer 10 MHz Out to On.

System Calibration

Connect the spectrum analyzer to the test system in place of the master device. Set the signal generator to CW mode. Adjust the amplitude of the signal generator to yield a measured level of -62 dBm on the spectrum analyzer.

Without changing any of the instrument settings, reconnect the spectrum analyzer to the Common port of the Spectrum Analyzer Combiner/Divider and connect a 50 ohm load to the Master Device port of the test system.

Measure the amplitude and calculate the difference from -62 dBm. Adjust the Reference Level Offset of the spectrum analyzer to this difference. Confirm that the signal is displayed at -62 dBm. Readjust the RBW and VBW to 3 MHz, set the span to 10 MHz, and confirm that the signal is still displayed at -62 dBm.

The spectrum analyzer displays the level of the signal generator as received at the antenna ports of the Master Device. The interference detection threshold may be varied from the calibrated value of -62 dBm and the spectrum analyzer will still indicate the level as received by the Master Device.

Set the signal generator to produce a radar waveform, trigger a burst manually and measure the level on the spectrum analyzer. Readjust the amplitude of the signal generator as required so that the peak level of the waveform is at a displayed level equal to the required or desired interference detection threshold. Separate signal generator amplitude settings are determined as required for each radar type.

Interference Detection Threshold Adjustment

Download the applicable radar waveforms to the signal generator. Select the radar waveform, trigger a burst manually and measure the amplitude on the spectrum analyzer. Readjust the amplitude of the signal generator as required so that the peak level of the waveform is at a displayed level equal to the required or desired interference detection threshold. Separate signal generator amplitude settings are determined as required for each radar type.

Adjustment Of Displayed Traffic Level

Establish a link between the Master and Slave, adjusting the Link Step Attenuator as needed to provide a suitable received level at the Master and Slave devices. Stream the video test file to generate WLAN traffic. Confirm that the WLAN traffic level, as displayed on the spectrum analyzer, is at lower amplitude than the radar detection threshold. Confirm that the displayed traffic is from the Master Device. For Master Device testing confirm that the displayed traffic does not include Slave Device traffic. For Slave Device testing confirm that the displayed traffic does not include Master Device traffic.

If a different setting of the Master Step Attenuator is required to meet the above conditions, perform a new System Calibration for the new Master Step Attenuator setting.

Test Setup

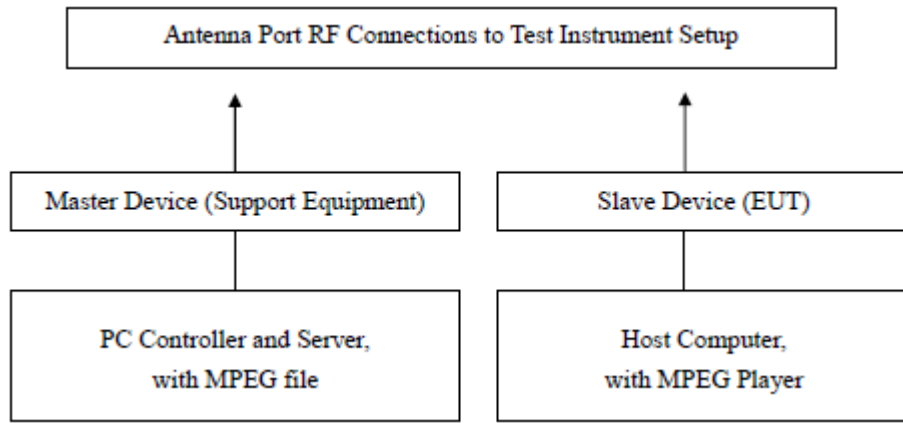

10 TEST RESULT

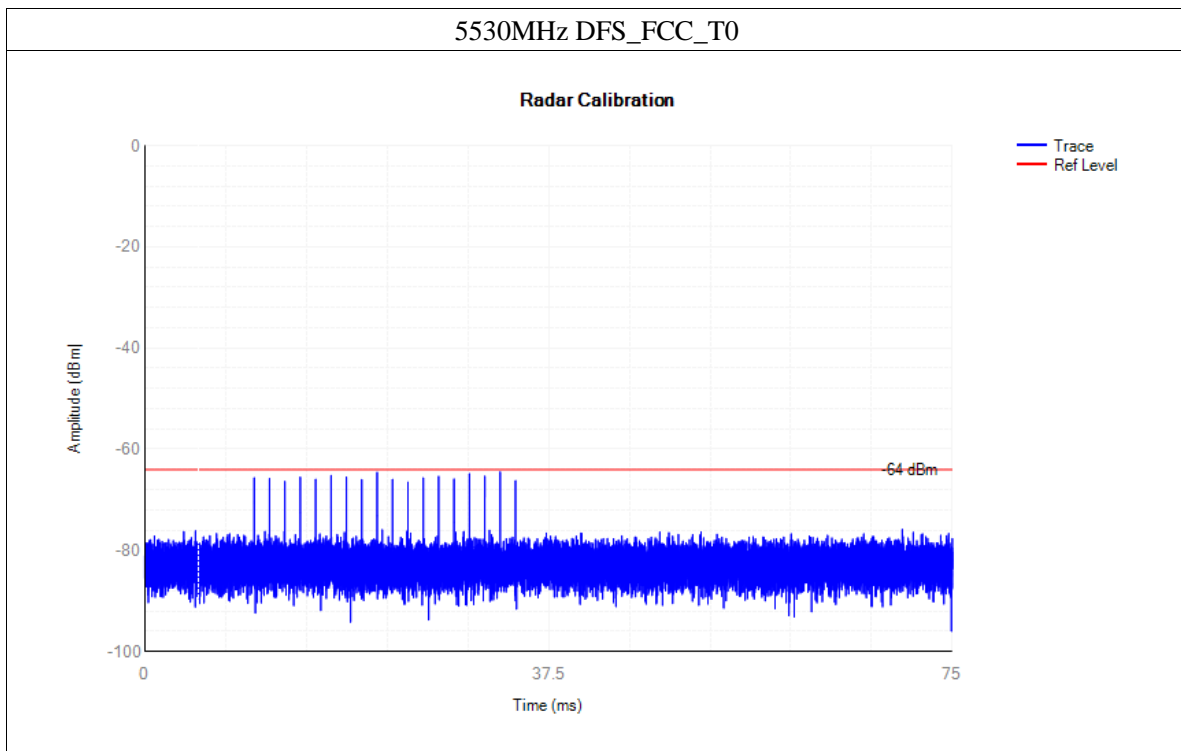
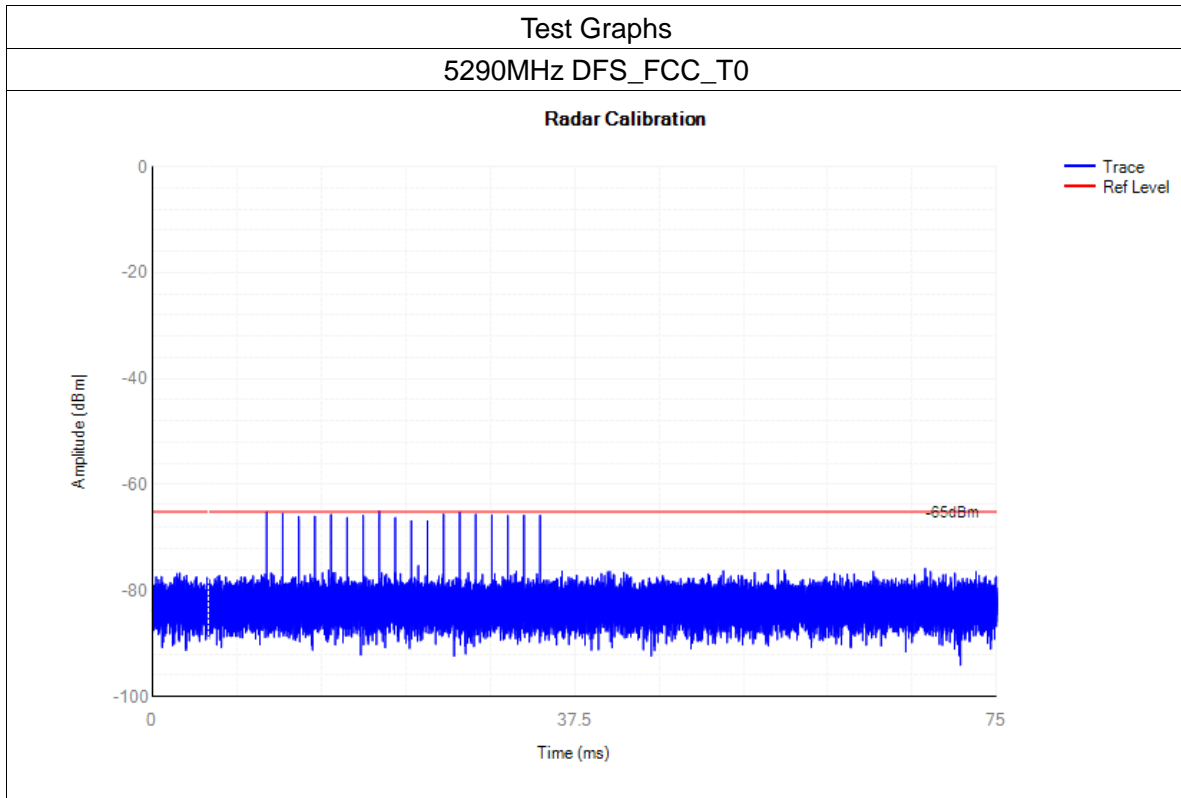

Shutdown Time

Mode	Frequency (MHz)	Channel Move Time (s)	Limit Channel Move Time (s)	Close Transmission Time (s)	Limit Close Transmission Time (s)	Close Transmission Time after 200ms(s)	Limit Close Transmission Time after 200ms (s)	Verdict
ac80	5290	0.4400	10	0.0403	0.26	0.0004	0.06	Pass
ac80	5530	0.6497	10	0.0592	0.26	0.0028	0.06	Pass

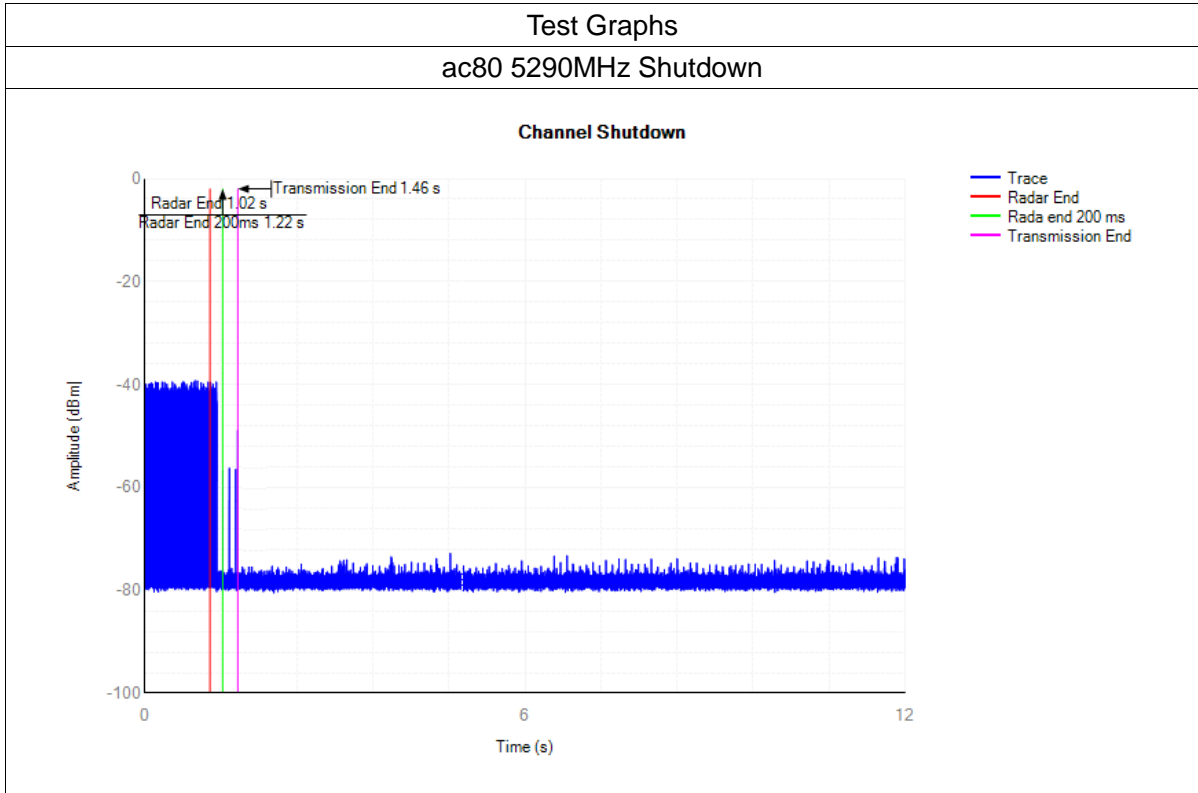

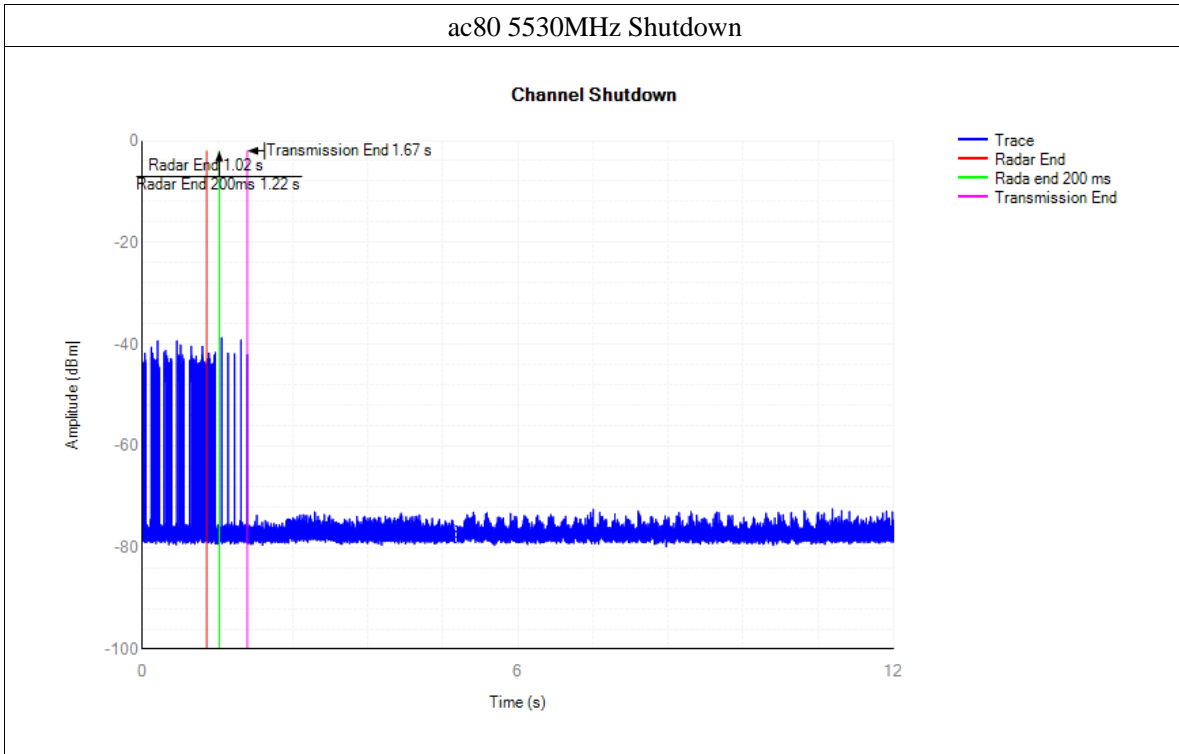

11 Test Setup Photographs of EUT

Please refer to separated files for Test Setup Photos of the EUT.

12 External Photographs of EUT

Please refer to separated files for External Photos of the EUT.

13 Internal Photographs of EUT

Please refer to separated files for Internal Photos of the EUT.

-----End-----