

# FCC Radio Test Report

## FCC ID: 2A5CV-RH-088-F

The report concerns: **Original Grant**

Report Reference No.....: 24EFSS11090 02491

Date Sample(s) Received.....: 2024-12-17

Date of Tested.....: From 2024-12-17 to 2025-01-15

Date of issue.....: 2025-01-20

Testing Laboratory .....: DongGuanShuoXin Electronic Technology Co., Ltd.

Address .....: Zone A, 1F, No. 6, XinGang Road YuanGang Street,  
XinAn District, ChangAn Town, DongGuan City,  
GuangDong, China

Applicant's name .....: Huizhou Ronghui Technology Co., Ltd

Address for .....: Liboshui No.1 Industrial Zone, Shiwan Town, Boluo  
County, Huizhou City, Guangdong Province, China

Equipment.....: Wireless Controller for RH-088-F

Trade Mark .....: /

Model .....: RH-088-F

Ratings .....: I/P: 5Vdc, 500mA  
3.7Vdc, 600mAh (Battery power)

**Test Engineer:**

Jelena OuYang

**Responsible Engineer :**

Leo Chen

**Authorized Signatory:**

Smile Wang

**Table of Contents**

**Page**

<b>1 TEST REPORT DECLARE</b>	<b>5</b>
<b>2 SUMMARY OF TEST RESULTS</b>	<b>6</b>
2.1 MEASUREMENT UNCERTAINTY	7
<b>3 GENERAL INFORMATION</b>	<b>8</b>
3.1 GENERAL DESCRIPTION OF EUT	8
3.2 DESCRIPTION OF TEST MODES	10
3.3 PARAMETERS OF TEST SOFTWARE	11
3.4 BLOCKDIAGRAMSHOWINGTHECONFIGURATIONOFSYSTEMTESTED	11
3.5 SUPPORT UNITS	11
3.6 TEST ENVIRONMENT CONDITIONS	12
<b>4 AC POWER LINE CONDUCTED EMISSIONS TEST</b>	<b>13</b>
4.1 LIMIT	13
4.2 TEST PROCEDURE	13
4.3 MEASUREMENT INSTRUMENTS LIST	13
4.4 TESTSETUP	14
4.5 EUT OPERATING CONDITIONS	14
4.6 TEST RESULTS	15
<b>5 RADIATED EMISSION TEST</b>	<b>17</b>
5.1 LIMIT	17
5.2 TEST PROCEDURE AND SETTING	18
5.3 MEASUREMENT INSTRUMENTS LIST	19
5.4 TESTSETUP	19
5.5 EUT OPERATING CONDITIONS	20
5.6 TEST RESULTS - 9 KHZ TO 30MHZ	21
5.7 TEST RESULTS- 30 MHZ TO 1000MHZ	22
5.8 TEST RESULTS - ABOVE 1000MHZ (BAND EDGE)	24
5.9 TEST RESULTS - ABOVE 1000MHZ (HARMONIC)	32
<b>6 NUMBER OF HOPPING FREQUENCY</b>	<b>44</b>
6.1 LIMIT	44
6.2 TEST PROCEDURE AND SETTING	44
6.3 MEASUREMENT INSTRUMENTS LIST	44
6.4 TEST SETUP	44

<b>Table of Contents</b>	<b>Page</b>
<b>6.5 EUT OPERATION CONDITIONS</b>	<b>44</b>
<b>6.6 TEST RESULTS</b>	<b>45</b>
<b>7 AVERAGE TIME OF OCCUPANCY</b>	<b>46</b>
<b>7.1 LIMIT</b>	<b>46</b>
<b>7.2 TEST PROCEDURE AND SETTING</b>	<b>46</b>
<b>7.3 MEASUREMENT INSTRUMENTS LIST</b>	<b>46</b>
<b>7.4 TEST SETUP</b>	<b>46</b>
<b>7.5 EUT OPERATION CONDITIONS</b>	<b>46</b>
<b>7.6 TEST RESULTS</b>	<b>47</b>
<b>8 HOPPING CHANNEL SEPARATION MEASUREMENT</b>	<b>49</b>
<b>8.1 LIMIT</b>	<b>49</b>
<b>8.2 TEST PROCEDURE AND SETTING</b>	<b>49</b>
<b>8.3 MEASUREMENT INSTRUMENTS LIST</b>	<b>49</b>
<b>8.4 TEST SETUP</b>	<b>49</b>
<b>8.5 EUT OPERATION CONDITIONS</b>	<b>49</b>
<b>8.6 TEST RESULTS</b>	<b>50</b>
<b>9 BANDWIDTH TEST</b>	<b>52</b>
<b>9.1 LIMIT</b>	<b>52</b>
<b>9.2 TEST PROCEDURE AND SETTING</b>	<b>52</b>
<b>9.3 MEASUREMENT INSTRUMENTS LIST</b>	<b>52</b>
<b>9.4 TEST SETUP</b>	<b>52</b>
<b>9.5 EUT OPERATION CONDITIONS</b>	<b>52</b>
<b>9.6 TEST RESULTS</b>	<b>53</b>
<b>10 MAXIMUM OUTPUT POWER</b>	<b>55</b>
<b>10.1 LIMIT</b>	<b>55</b>
<b>10.2 TEST PROCEDURE AND SETTING</b>	<b>55</b>
<b>10.3 MEASUREMENT INSTRUMENTS LIST</b>	<b>55</b>
<b>10.4 TEST SETUP</b>	<b>55</b>
<b>10.5 EUT OPERATION CONDITIONS</b>	<b>55</b>
<b>10.6 TEST RESULTS</b>	<b>56</b>
<b>11 CONDUCTED SPURIOUS EMISSION</b>	<b>59</b>
<b>11.1 LIMIT</b>	<b>59</b>
<b>11.2 TEST PROCEDURE AND SETTING</b>	<b>59</b>
<b>11.3 MEASUREMENT INSTRUMENTS LIST</b>	<b>59</b>

**Table of Contents**

**Page**

<b>11.4 TEST SETUP</b>	<b>59</b>
<b>11.5 EUT OPERATION CONDITIONS</b>	<b>59</b>
<b>11.6 TEST RESULTS</b>	<b>60</b>

**1TEST REPORT DECLARE**

Applicant	Huizhou Ronghui Technology Co., Ltd
Address	Liboshui No.1 Industrial Zone, Shiwan Town, Boluo County, Huizhou City, Guangdong Province, China
Manufacturer	Huizhou Ronghui Technology Co., Ltd
Address	Liboshui No.1 Industrial Zone, Shiwan Town, Boluo County, Huizhou City, Guangdong Province, China
Factory	Huizhou Ronghui Technology Co., Ltd
Address	Liboshui No.1 Industrial Zone, Shiwan Town, Boluo County, Huizhou City, Guangdong Province, China
Equipment	Wireless Controller for RH-088-F
Model No.	RH-088-F
Trade Mark	/
Standard	FCC Part15, Subpart C (15.247) ANSI C63.10-2013

**We Declare:**

The equipment described above is tested by DongGuanShuoXin Electronic Technology Co., Ltd(ATT). and in the configuration tested the equipment complied with the standards specified above. The test results are contained in this test report and DongGuanShuoXin Electronic Technology Co., Ltd.(ATT) is assumed of full responsibility for the accuracy and completeness of these tests.

ATT is not responsible for the sampling stage, so the results only apply to the sample as received.

ATT's reports apply only to the specific samples tested under conditions. It is manufacture's responsibility to ensure that additional production units of this model are manufactured with the identical electrical and mechanical components. ATT shall have no liability for any declarations, inferences or generalizations drawn by the client or others from ATT issued reports.

## 2SUMMARY OF TEST RESULTS

The EUT have been tested according to the applicable standards as referenced below:

Standard(s) Section	Test Item	Judgment	Remark
15.207	AC Power Line Conducted Emissions	PASS	-----
15.247(d) 15.205(a) 15.209(a)	Radiated Emission	PASS	-----
15.247(a)(1)(iii)	Number of Hopping Frequency	PASS	-----
15.247(a)(1)(iii)	Average Time Of Occupancy	PASS	-----
15.247(a)(1)	Hopping Channel Separation	PASS	-----
15.247(a)(1)	Bandwidth	PASS	-----
15.247(a)(1)	Maximum Output Power	PASS	-----
15.247(d)	Conducted Spurious Emission	PASS	-----
15.203	Antenna Requirement	PASS	Note(2)

Note:

- (1) "N/A" denotes test is not applicable in this test report
- (2) The device what use a permanently attached antenna were considered sufficient to comply with the provisions of 15.203.

**2.1 MEASUREMENT UNCERTAINTY**

Test Item	Uncertainty
Uncertainty for Conduction emission test (9kHz-150kHz)	3.7 dB
Uncertainty for Conduction emission test (150kHz-30MHz)	3.3 dB
Uncertainty for Radiation Emission test (30MHz-200MHz)	4.60 dB (Polarize: V)
	4.60 dB (Polarize: H)
Uncertainty for Radiation Emission test (200MHz-1GHz)	6.10 dB (Polarize: V)
	5.08 dB (Polarize: H)
Uncertainty for Radiation Emission test (1GHz-6GHz)	5.01 dB (Polarize: V)
	5.01 dB (Polarize: H)
Uncertainty for Radiation Emission test (6GHz-18GHz)	5.26 dB (Polarize: V)
	5.26 dB (Polarize: H)
Uncertainty for Radiation Emission test (18GHz-40GHz)	5.06 dB (Polarize: V)
	5.06 dB (Polarize: H)
Uncertainty for radio frequency	±0.048kHz
Uncertainty for conducted RF Power	±0.32dB

**Note:**

This uncertainty represents an expanded uncertainty expressed at approximately the 95% confidence level using a coverage factor of k=2.

**Test Facility:**

The Test site used by DongGuanShuoXin Electronic Technology Co., Ltd. to collect test data is located on the Zone A, 1F, No. 6, XinGang Road YuanGang Street, XinAn District, ChangAn Town, DongGuan City, GuangDong, China

The test facility is recognized, certified, or accredited by the following organizations:

Item	Registration No.	Expiration Date
CNAS	L3098	2030-08-27
A2LA	4893.01	2026-06-30
Innovation, Science and Economic Development Canada (ISED)	11033A CAB identifier:CN0083	2026-06-30
Federal Communications Commission (FCC)	171688 Designation No.:CN1235	2026-06-30

### 3 GENERAL INFORMATION

#### 3.1 GENERAL DESCRIPTION OF EUT

Equipment	Wireless Controller for RH-088-F	
Brand Name	/	
Test Model	RH-088-F	
Series Model	N/A	
Model Difference(s)	N/A	
Hardware Version	1.0	
Software Version	1.0	
PowerSource	USB	
Power Rating	DC 5V	
Operation Frequency	2402 MHz ~ 2480 MHz	
Modulation Technology	GFSK, $\pi/4$ -DQPSK, 8-DPSK	
Bit Rate of Transmitter	1Mbps /2Mbps /3Mbps	
Antenna Information	Antenna Type:PCB	Maximum Peak Gain:0dBi
Max. Output Power	1Mbps: 2.800dBm (0.001905W) 2Mbps: 3.449dBm (0.002213W) 3Mbps: 3.603dBm (0.002292W)	

Note:

1. For a more detailed features description, please refer to the manufacturer's specifications or the user's manual.



2. Channel List:

Channel	Frequency (MHz)	Channel	Frequency (MHz)	Channel	Frequency (MHz)
00	2402	27	2429	54	2456
01	2403	28	2430	55	2457
02	2404	29	2431	56	2458
03	2405	30	2432	57	2459
04	2406	31	2433	58	2460
05	2407	32	2434	59	2461
06	2408	33	2435	60	2462
07	2409	34	2436	61	2463
08	2410	35	2437	62	2464
09	2411	36	2438	63	2465
10	2412	37	2439	64	2466
11	2413	38	2440	65	2467
12	2414	39	2441	66	2468
13	2415	40	2442	67	2469
14	2416	41	2443	68	2470
15	2417	42	2444	69	2471
16	2418	43	2445	70	2472
17	2419	44	2446	71	2473
18	2420	45	2447	72	2474
19	2421	46	2448	73	2475
20	2422	47	2449	74	2476
21	2423	48	2450	75	2477
22	2424	49	2451	76	2478
23	2425	50	2452	77	2479
24	2426	51	2453	78	2480
25	2427	52	2454		
26	2428	53	2455		

### 3.2 DESCRIPTION OF TEST MODES

The test system was pre-tested based on the consideration of all possible combinations of EUT operation mode.

Pretest Mode	Description
Mode 1	TX Mode <b>NOTE (1)</b>
Mode 2	TX Mode Channel 01_3Mbps

Following mode(s) was (were) found to be the worst case(s) and selected for the final test.

<b>AC power line conducted emissions test</b>	
Final Test Mode	Description
Mode 2	TX Mode Channel 01_3Mbps

<b>Radiated emissions test - Below 1GHz</b>	
Final Test Mode	Description
Mode 2	TX Mode Channel 01_3Mbps

<b>Radiated emissions test - Above 1GHz</b>	
Final Test Mode	Description
Mode 1	TX Mode <b>NOTE (1)</b>

<b>Conducted test</b>	
Final Test Mode	Description
Mode 1	TX Mode <b>NOTE (1)</b>

Note:

- (1) The measurements are performed at the high, middle, low available channels.
- (2) The measurements for Hopping Channel Separation, Bandwidth and Maximum Output Power were tested during 1Mbps, 2Mbps and 3Mbps, the worst case are 1Mbps and 3Mbps, only worst case was documented.

### 3.3PARAMETERS OF TEST SOFTWARE

During testing, channel & power controlling software provided by the customer was used to control the operating channel as well as the output power level. The RF output power selection is for the setting of RF output power expected by the customer and is going to be fixed on the firmware of the final end product power parameters of FHSS

Test Software	BT_Tool.exe		
Frequency (MHz)	2402	2441	2480
Parameters(1Mbps)	Default	Default	Default
Parameters(3Mbps)	Default	Default	Default

### 3.4BLOCKDIAGRAMSHOWINGTHECONFIGURATIONOFSYSTEMTESTED

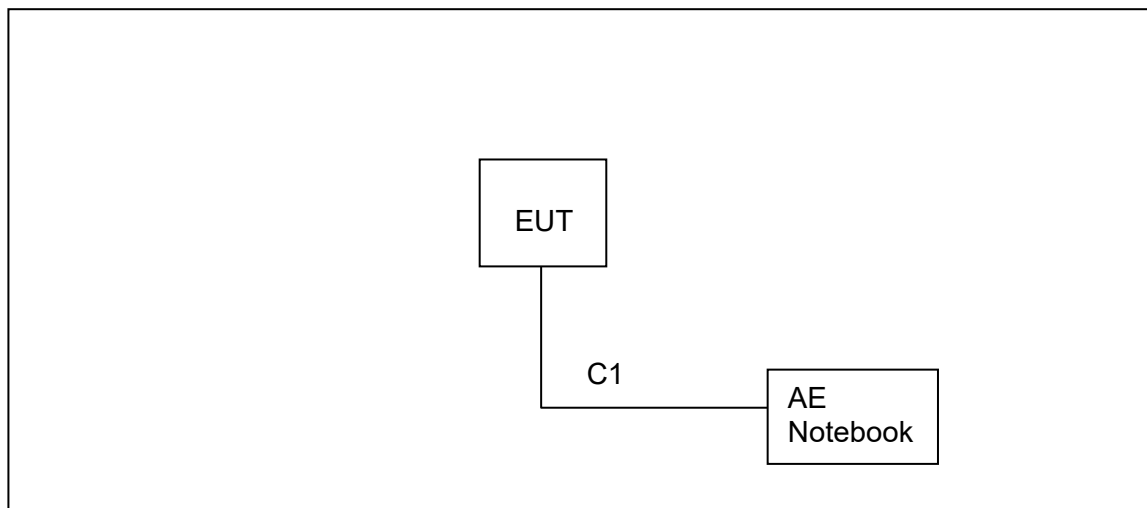

### 3.5SUPPORT UNITS

Item	Equipment	Brand	Model No.	Series No.
AE	Notebook	Lenovo	/	/

Item	Cable Type	Shielded Type	Ferrite Core	Length
C1	DC Cable	NO	NO	0.8m

**3.6 TEST ENVIRONMENT CONDITIONS**

Test Item	Temperature	Humidity	Test Voltage
AC Power Line Conducted Emissions	25.4°C	54%	DC 5V (AC 120V/60Hz)
Radiated Emissions-9K-30MHz	25.0°C	60%	DC 5V
Radiated Emissions-30 MHz to 1GHz	24.6°C	53%	DC 5V
Radiated Emissions-Above 1000 MHz	24.2°C	59%	DC 5V
Number of Hopping Frequency	24.6°C	48%	DC 5V
Average Time Of Occupancy	24.6°C	48%	DC 5V
Hopping Channel Separation	24.6°C	48%	DC 5V
Bandwidth	24.6°C	48%	DC 5V
Maximum Output Power	24.6°C	48%	DC 5V
Conducted Spurious Emission	24.6°C	48%	DC 5V

## 4AC POWER LINE CONDUCTED EMISSIONS TEST

### 4.1LIMIT

Frequency of Emission (MHz)	Limit (dB $\mu$ V)	
	Quasi-peak	Average
0.15 - 0.50	66 to 56*	56 to 46*
0.50 - 5.0	56	46
5.0 - 30.0	60	50

Note:

- (1) The tighter limit applies at the band edges.
- (2) The limit of " \* " marked band means the limitation decreases linearly with the logarithm of the frequency in the range.

The following table is the setting of the receiver

Receiver Parameters	Setting
Attenuation	10 dB
Start Frequency	0.15 MHz
Stop Frequency	30 MHz
IF Bandwidth	9 kHz

### 4.2TEST PROCEDURE

- a. The EUT was placed 0.8 meters from the horizontal ground plane with EUT being connected to the power mains through a line impedance stabilization network (LISN). All other support equipment powered from additional LISN(s). The LISN provide 50 Ohm/ 50uH of coupling impedance for the measuring instrument.
- b. Interconnecting cables that hang closer than 40 cm to the groundplane shall be folded back and forth in the center forming a bundle 30 to 40 cm long.
- c. I/O cables that are not connected to a peripheral shall be bundled in the center. The end of the cable may be terminated, if required, using the correct terminating impedance. The overall length shall not exceed 1 m.
- d. LISN at least 80 cm from nearest part of EUT chassis.

### 4.3MEASUREMENT INSTRUMENTS LIST

Item	Kind of Equipment	Manufacturer	Type No.	Serial No.	Calibrated until
1	Pulse Limiter	MTS-systemtechnik	MTS-IMP-136	261115-010-0024	11/17/2025
2	EMI Test Receiver	R&S	ESCI	101308	06/05/2025
3	LISN	AFJ	LS16	16011103219	06/05/2025
4	LISN	Schwarzbeck	NSLK 8127	8127-432	06/05/2025
5	Measurement Software	Farad	EZ-EMC (Ver.ATT-03A)	N/A	N/A

#### 4.4 TEST SETUP

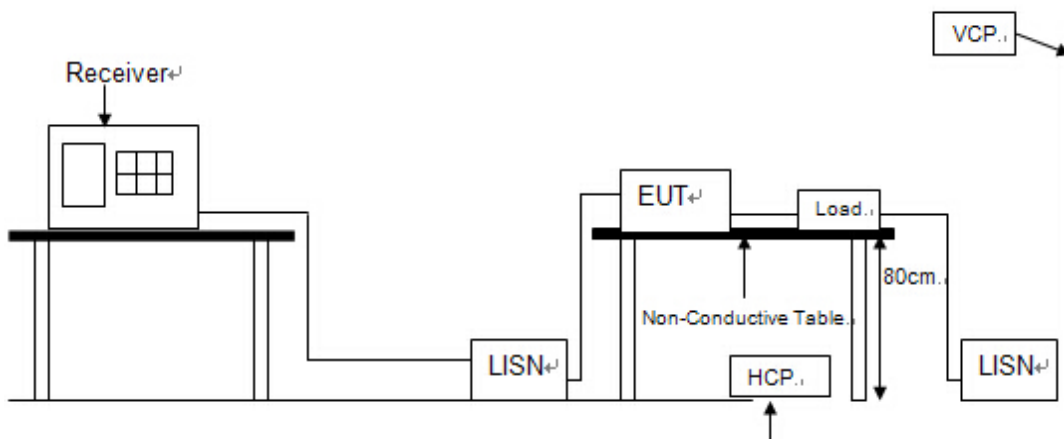

#### 4.5 EUT OPERATING CONDITIONS

The EUT was configured for testing in a typical function (as a customer would normally use it), EUT was programmed to be in continuously transmitting data or hopping on mode.

### 4.6 TEST RESULTS

Test Mode: TX Mode Channel 01 \_3Mbps

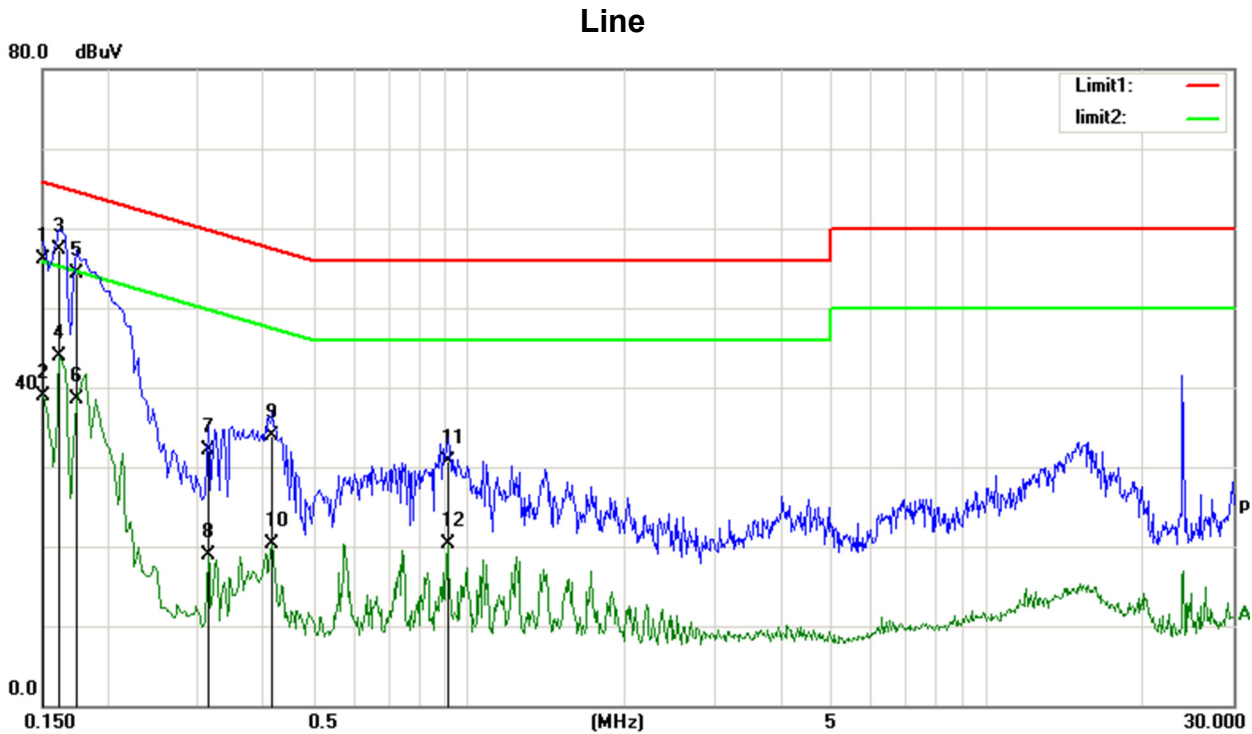

No.	Frequency (MHz)	Reading (dBuV)	Correct Factor(dB)	Result (dBuV)	Limit (dBuV)	Margin (dB)	Remark
1	0.1500	45.31	10.88	56.19	65.99	-9.80	QP
2	0.1500	28.12	10.88	39.00	55.99	-16.99	AVG
3	0.1620	46.57	10.74	57.31	65.36	-8.05	QP
4	0.1620	33.12	10.74	43.86	55.36	-11.50	AVG
5	0.1739	43.53	10.68	54.21	64.77	-10.56	QP
6	0.1739	27.82	10.68	38.50	54.77	-16.27	AVG
7	0.3140	21.54	10.51	32.05	59.86	-27.81	QP
8	0.3140	8.39	10.51	18.90	49.86	-30.96	AVG
9	0.4179	23.07	10.82	33.89	57.49	-23.60	QP
10	0.4179	9.55	10.82	20.37	47.49	-27.12	AVG
11	0.9100	20.05	10.69	30.74	56.00	-25.26	QP
12	0.9100	9.53	10.69	20.22	46.00	-25.78	AVG

**Remarks:**

(1) Measurement Value = Reading Level + Correct Factor.

(2) Margin Level = Measurement Value - Limit Value.

Test Mode: TX Mode Channel 01 \_3Mbps

## Neutral

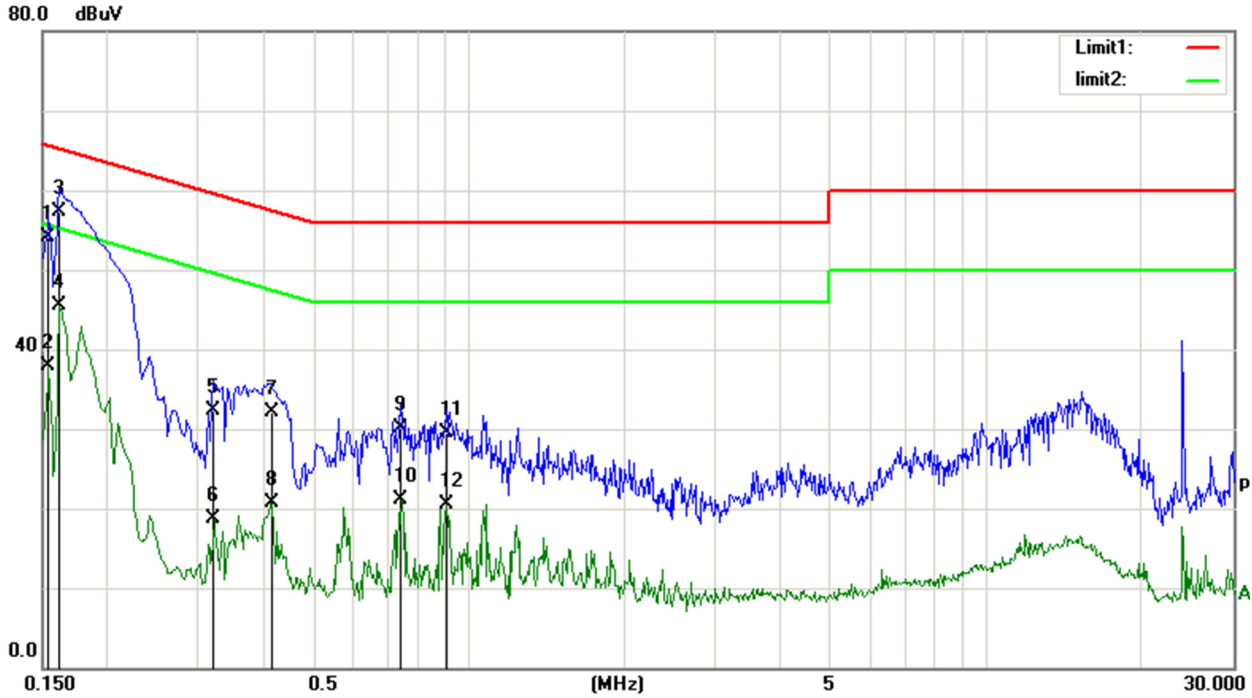

No.	Frequency (MHz)	Reading (dBuV)	Correct Factor(dB)	Result (dBuV)	Limit (dBuV)	Margin (dB)	Remark
1	0.1539	43.20	10.83	54.03	65.78	-11.75	QP
2	0.1539	27.07	10.83	37.90	55.78	-17.88	AVG
3	0.1620	46.57	10.74	57.31	65.36	-8.05	QP
4	0.1620	34.72	10.74	45.46	55.36	-9.90	AVG
5	0.3200	21.86	10.54	32.40	59.70	-27.30	QP
6	0.3200	8.21	10.54	18.75	49.70	-30.95	AVG
7	0.4180	21.29	10.82	32.11	57.49	-25.38	QP
8	0.4180	9.88	10.82	20.70	47.49	-26.79	AVG
9	0.7380	19.28	10.73	30.01	56.00	-25.99	QP
10	0.7380	10.36	10.73	21.09	46.00	-24.91	AVG
11	0.9060	18.72	10.69	29.41	56.00	-26.59	QP
12	0.9060	9.72	10.69	20.41	46.00	-25.59	AVG

**Remarks:**

- (1) Measurement Value = Reading Level + Correct Factor.
- (2) Margin Level = Measurement Value - Limit Value.



## 5 RADIATED EMISSION TEST

### 5.1 LIMIT

In case the emission fall within the restricted band specified on 15.205(a) & RSS-Gen 8.10, then the 15.209(a) & RSS-Gen 8.9 limit in the table below has to be followed.

#### LIMITS OF RADIATED EMISSION MEASUREMENT (9 kHz-1000MHz)

Frequency (MHz)	Field Strength (microvolts/meter)	Measurement Distance (meters)
0.009-0.490	2400/F(kHz)	300
0.490-1.705	24000/F(kHz)	30
1.705-30.0	30	30
30-88	100	3
88-216	150	3
216-960	200	3
Above 960	500	3

#### LIMITS OF RADIATED EMISSION MEASUREMENT (9 kHz-30 MHz)

Frequency (MHz)	Magnetic field strength (H-Field) ( $\mu$ A/m)	Measurement Distance (meters)
0.009-0.490	6.37/F(kHz)	300
0.490-1.705	6.37/F(kHz)	30
1.705-30.0	0.08	30

#### LIMITS OF RADIATED EMISSION MEASUREMENT (30 MHz-1000MHz)

Frequency (MHz)	Field Strength ( $\mu$ V/m at 3m)
30-88	100
88-216	150
216-960	200
Above 960	500

#### LIMITS OF RADIATED EMISSION MEASUREMENT (Above 1000MHz)

Frequency (MHz)	(dBuV/m at 3 m)	
	Peak	Average
Above 1000	74	54

**Note:**

- (1) The limit for radiated test was performed according to FCC PART 15C and RSS-247.
- (2) The tighter limit applies at the band edges.
- (3) Emission level (dBuV/m)=20log Emission level (uV/m).

### 5.2 TEST PROCEDURE AND SETTING

- a. The measuring distance of 3 m shall be used for measurements. The EUT was placed on the top of a rotating table 0.8 meter above the ground at a 3 meter semi-anechoic chamber. The table was rotated 360 degrees to determine the position of the highest radiation.(below 1GHz)
- b. The measuring distance of 3 m shall be used for measurements. The EUT was placed on the top of a rotating table 1.5 meter above the ground at a 3 meter semi-anechoic chamber. The table was rotated 360 degrees to determine the position of the highest radiation.(above 1GHz)
- c. The height of the equipment or of the substitution antenna shall be 0.8m or 1.5m; the height of the test antenna shall vary between 1 m to 4 m. Both horizontal and vertical polarizations of the antenna are set to make the measurement.
- d. For each suspected emission, the EUT was arranged to its worst case and then the antenna was tuned to heights find the maximum reading (used Bore sight function).
- e. The receiver system was set to peak and average detect function and specified bandwidth with maximum hold mode when the test frequency is above 1GHz.
- f. The initial step in collecting radiated emission data is a receiver peak detector mode pre-scanning the measurement frequency range. Significant peaks are then marked and then Quasi Peak detector mode re-measured.
- g. All readings are Peak unless otherwise stated QP in column of Note. Peak denotes that the Peak reading compliance with the QP Limits and then QP Mode measurement didn't perform. (below 1GHz)
- h. All readings are Peak Mode value unless otherwise stated AVG in column of Note. If the Peak Mode Measured value compliance with the Peak Limits and lower than AVG Limits, the EUT shall be deemed to meet both Peak & AVG Limits and then only Peak Mode was measured, but AVG Mode didn't perform. (above 1GHz)
- i. The test result is calculated as the following:
  - (1) Result = Reading + Correct Factor
  - (2) Correct Factor = Antenna Factor + Cable Loss – Amplifier Gain + Attenuator
  - (3) Margin = Result - Limit

Spectrum Parameter	Setting
Attenuation	Auto
Start Frequency	1000 MHz
Stop Frequency	10th carrier harmonic
RBW / VBW (Emission in restricted band)	RBW 1MHz VBW 3MHz peak detector for Pk value RMS detector for AV value

Receiver Parameter	Setting
Attenuation	Auto
Start ~ Stop Frequency	9 kHz~90 kHz for PK/AVG detector
Start ~ Stop Frequency	90 kHz~110 kHz for QP detector
Start ~ Stop Frequency	110 kHz~490 kHz for PK/AVG detector
Start ~ Stop Frequency	490 kHz~30 MHz for QP detector
Start ~ Stop Frequency	30MHz~1000MHz for QP detector

**5.3 MEASUREMENT INSTRUMENTS LIST**

Item	Equipment	Manufacturer	Model No.	Serial No.	Calibrated until
1	EMI Test Receiver	R&S	ESCI	101307	06/05/2025
2	Spectrum Analyzer	Agilent	E4407B	US40240708	11/17/2025
3	Loop antenna	SCHWARZBECK K	FMZB1519	1519-062	01/14/2025
4	Broadband antenna	SCHWARZBECK	VULB9168	VULB9168-192	03/29/2025
5	HORN ANTENNA	SCHWARZBECK	BBHA9120D	9120D 1065	03/29/2025
6	Preamplifier Amplifier	HP	8447F	3113A05680	11/17/2025
7	PRE-AMPLIFIER	EMEC	EM01G26G	980136	03/29/2025
8	RF Cable	R&S	Test Cable 4	4	11/17/2025
9	RF Cable	R&S	Test Cable 5	5	11/17/2025
10	RF Cable	R&S	Test Cable 9	9	04/17/2025
11	RF Cable	R&S	Test Cable 10	10	04/17/2025
12	Measurement Software	Farad	EZ-EMC (Ver.ATT-03A)	N/A	N/A

**5.4 TEST SETUP**

**9 kHz-30 MHz**

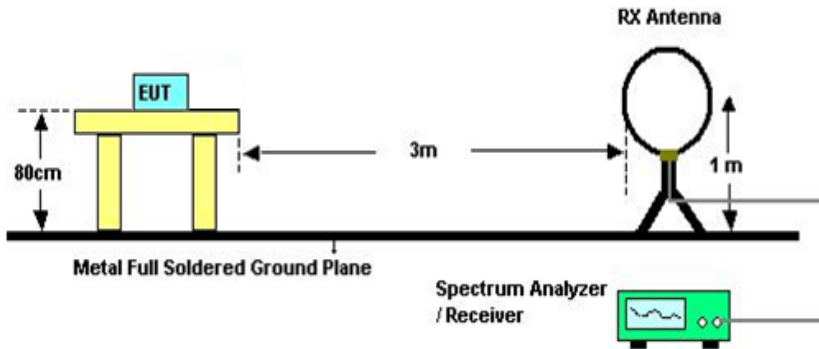

**30 MHz to 1 GHz**

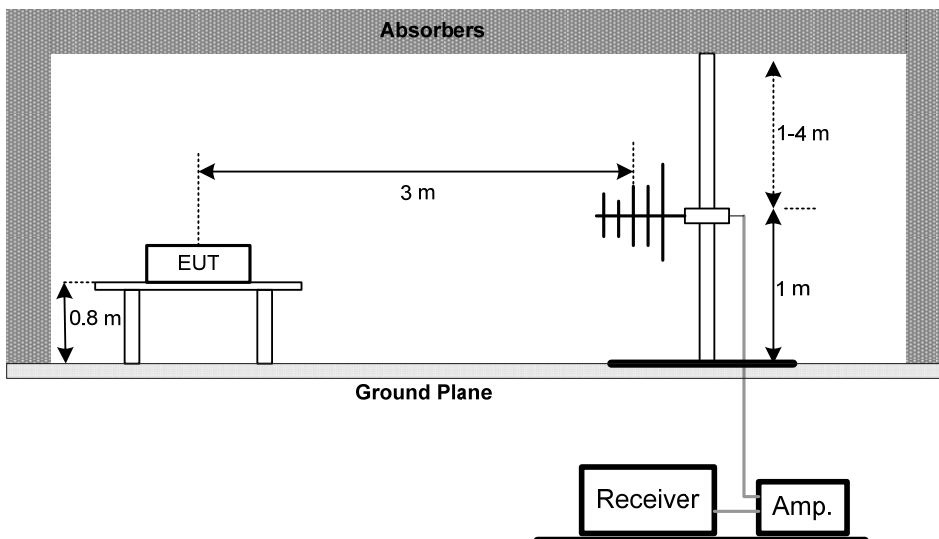

**Above 1 GHz**

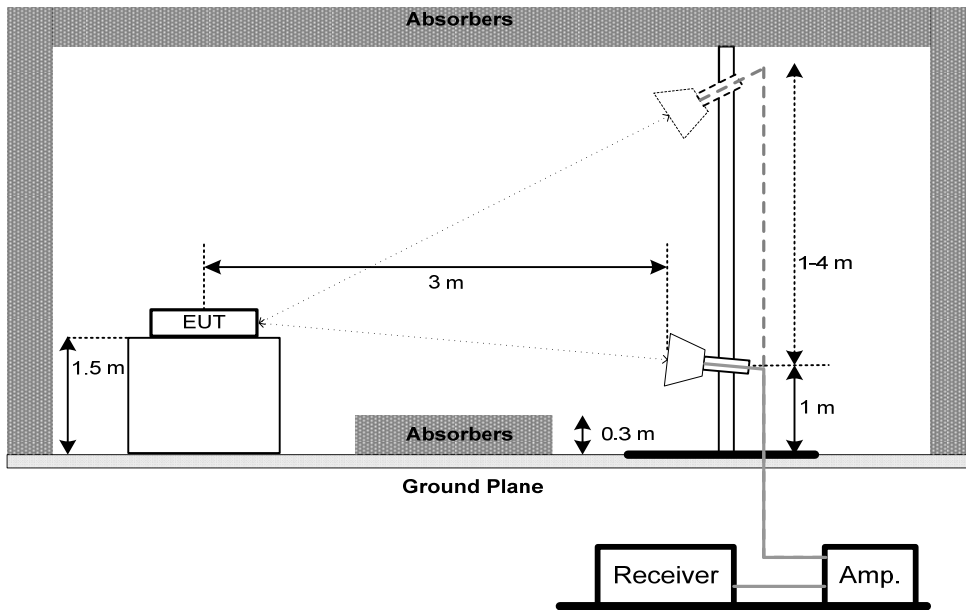

**5.5 EUT OPERATING CONDITIONS**

The EUT was programmed to be in continuously transmitting mode.

**5.6 TEST RESULTS - 9 kHz TO 30MHz**

Test Mode:	TX Mode Channel 01 _3Mbps
------------	---------------------------

Freq.	Reading	Limit	Margin	State
(MHz)	(dBuV/m)	(dBuV/m)	(dB)	P/F
--	--	--	--	P
--	--	--	--	P

**Note:**

The amplitude of spurious emissions which are attenuated by more than 20dB below the permissible value has no need to be reported.

Distance extrapolation factor =  $20 \log (\text{specific distance}/\text{test distance})(\text{dB})$ ;

Limit line = specific limits(dBuv) + distance extrapolation factor

## 5.7 TEST RESULTS- 30 MHz TO 1000MHz

Test Mode: TX Mode Channel 01 \_3Mbps

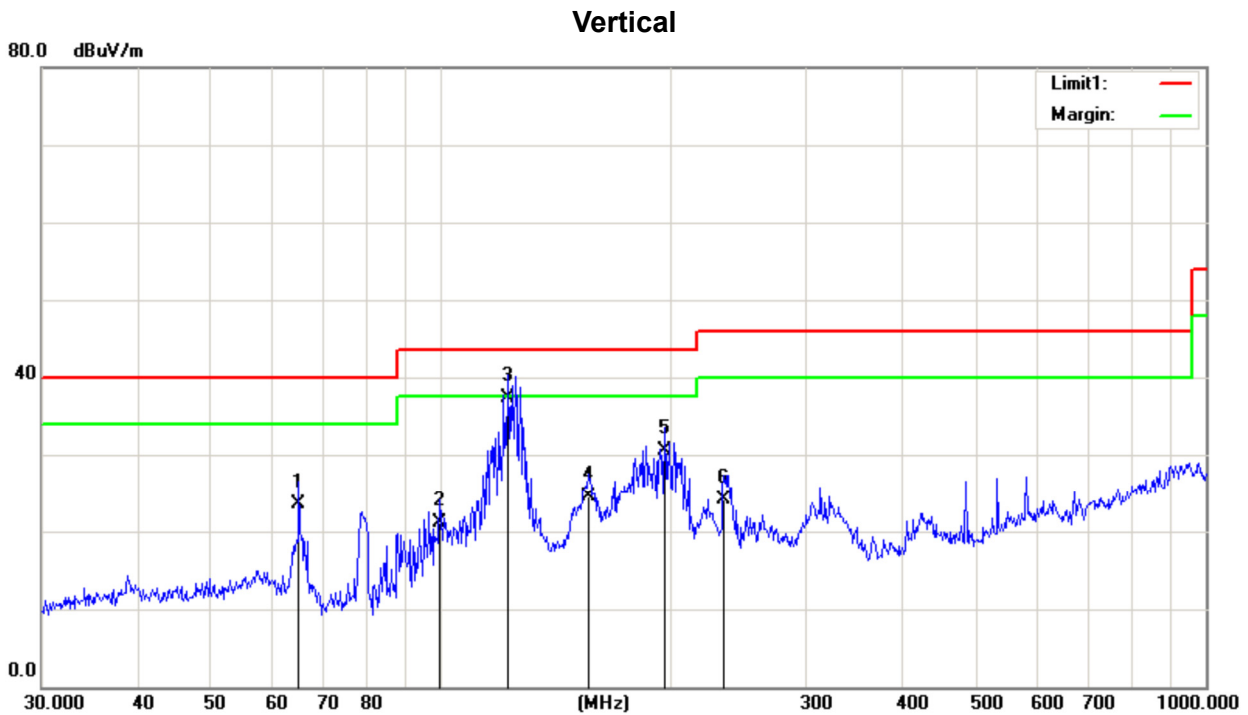

No.	Mk.	Freq.	Reading Level	Correct Factor	Measurement	Limit	Over	Antenna Height	Table Degree	
		MHz	dBuV	dB	dBuV/m	dB/m	dB	cm	degree	Comment
1		65.1145	38.62	-15.05	23.57	40.00	-16.43	QP	200	59
2		99.5279	37.27	-16.25	21.02	43.50	-22.48	QP	100	36
3	*	122.4038	50.80	-13.46	37.34	43.50	-6.16	QP	100	222
4		155.9096	35.59	-11.10	24.49	43.50	-19.01	QP	300	102
5		195.8220	43.78	-13.23	30.55	43.50	-12.95	QP	100	359
6		234.1682	36.64	-12.61	24.03	46.00	-21.97	QP	100	0

Test Mode: TX Mode Channel 01 \_3Mbps

### Horizontal

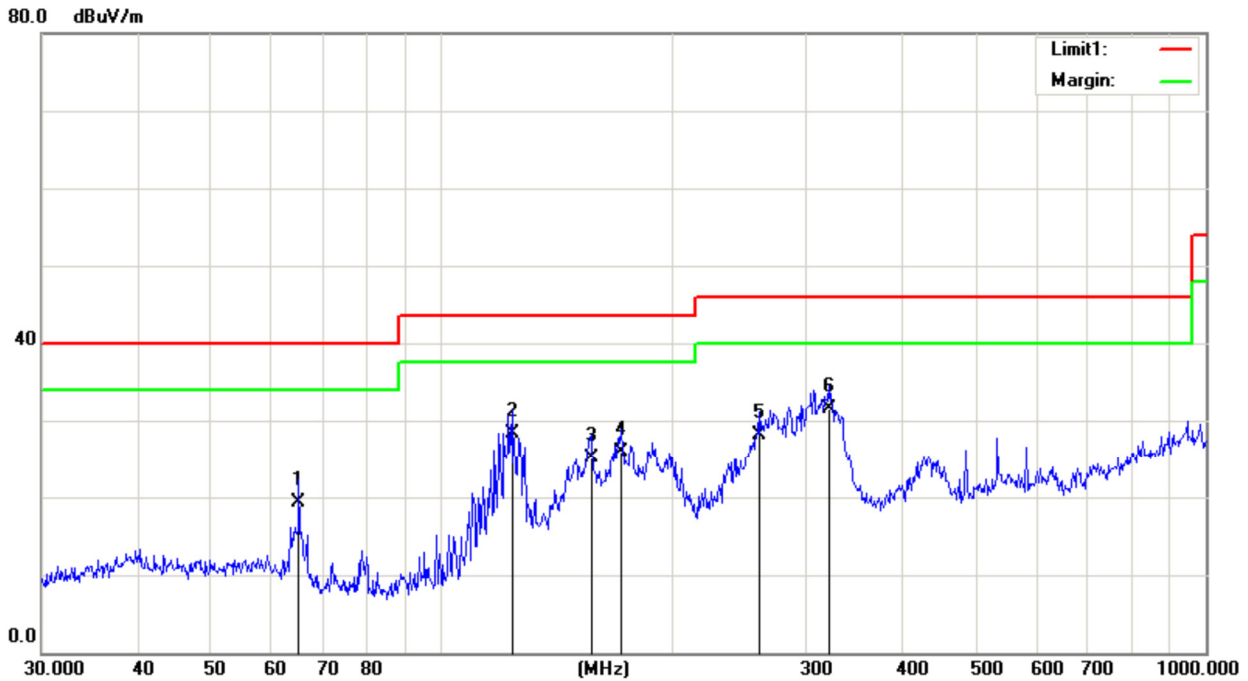

No.	Mk.	Freq.	Reading Level	Correct Factor	Measurement	Limit	Over	Antenna Height	Table Degree	
		MHz	dBuV	dB	dBuV/m	dB/m	dB	cm	degree	Comment
1		65.1145	34.45	-15.05	19.40	40.00	-20.60	300	65	
2		123.6985	41.75	-13.53	28.22	43.50	-15.28	100	109	
3		157.0072	36.57	-11.46	25.11	43.50	-18.39	100	325	
4		171.9946	37.90	-12.06	25.84	43.50	-17.66	100	55	
5		260.1444	39.91	-11.78	28.13	46.00	-17.87	200	69	
6	*	321.0608	40.51	-9.02	31.49	46.00	-14.51	100	45	

## 5.8TEST RESULTS - ABOVE 1000MHz(BAND EDGE)

Test Mode: TX 2402 MHz\_CH00\_1Mbps

### Vertical

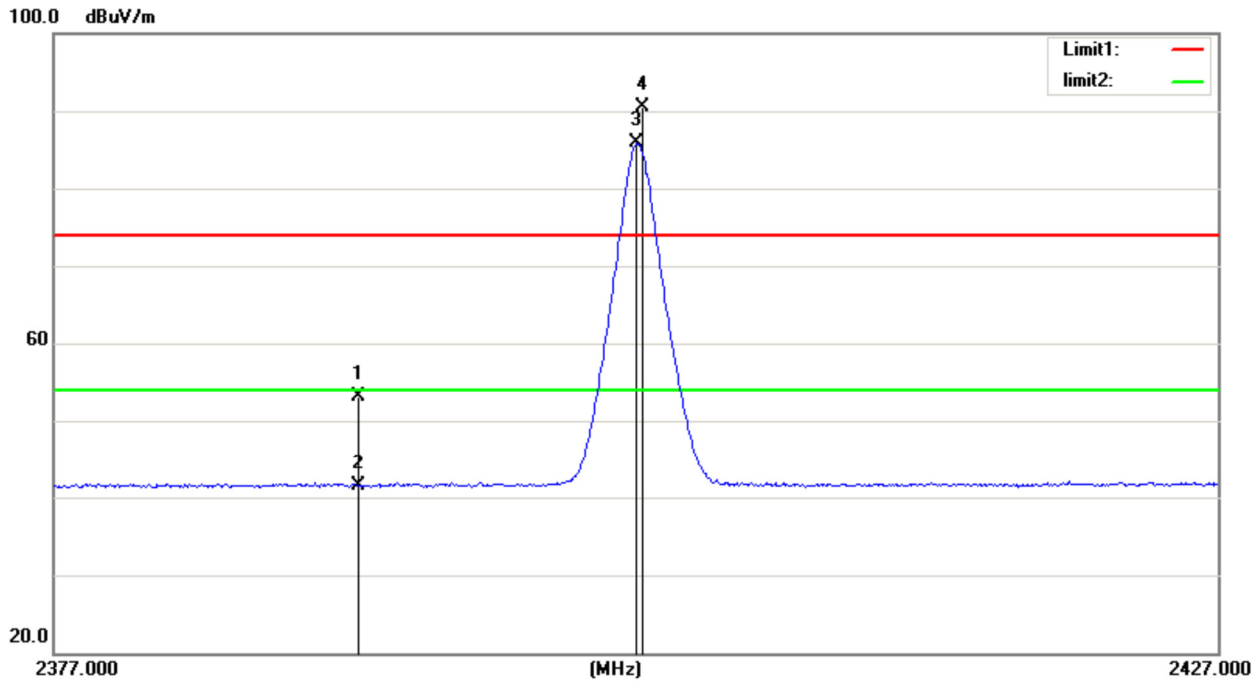

No.	Mk.	Freq. MHz	Reading Level dBuV	Correct Factor dB	Measure- ment dBuV/m	Limit dB/m	Over dB	Detector	Antenna Height cm	Table Degree	Comment
1		2390.000	22.99	30.14	53.13	74.00	-20.87	peak	150	273	
2		2390.000	11.39	30.14	41.53	54.00	-12.47	AVG	150	273	
3	*	2401.950	55.69	30.15	85.84	54.00	31.84	AVG	150	273	No Limit
4	X	2402.200	60.38	30.15	90.53	74.00	16.53	peak	150	273	No Limit



Test Mode: TX 2402 MHz\_CH00\_1Mbps

### Horizontal

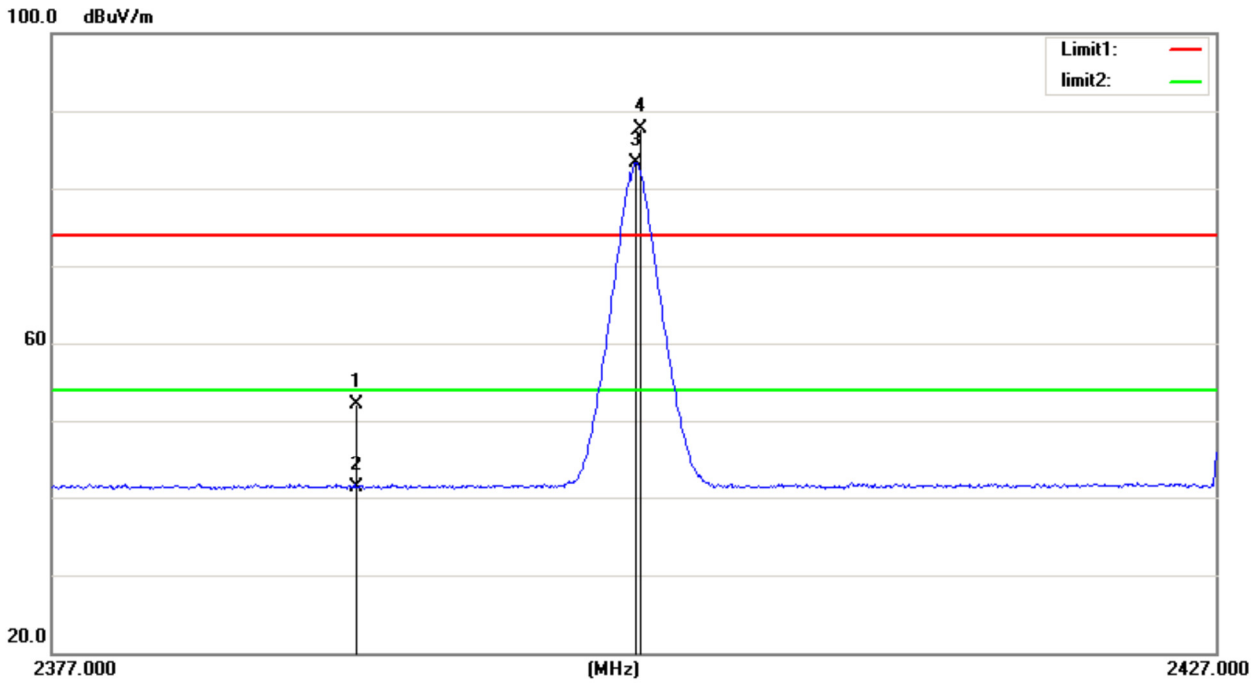

No.	Mk.	Freq.	Reading Level	Correct Factor	Measurement	Limit	Over	Antenna Height	Table Degree	
		MHz	dBuV	dB	dBuV/m	dB/m	dB	cm	degree	Comment
1		2390.000	22.01	30.14	52.15	74.00	-21.85	150	245	peak
2		2390.000	11.26	30.14	41.40	54.00	-12.60	150	245	AVG
3	*	2402.000	53.16	30.15	83.31	54.00	29.31	150	245	AVG No Limit
4	X	2402.200	57.61	30.15	87.76	74.00	13.76	150	245	peak No Limit

Test Mode: TX 2480 MHz\_CH78\_1Mbps

### Vertical

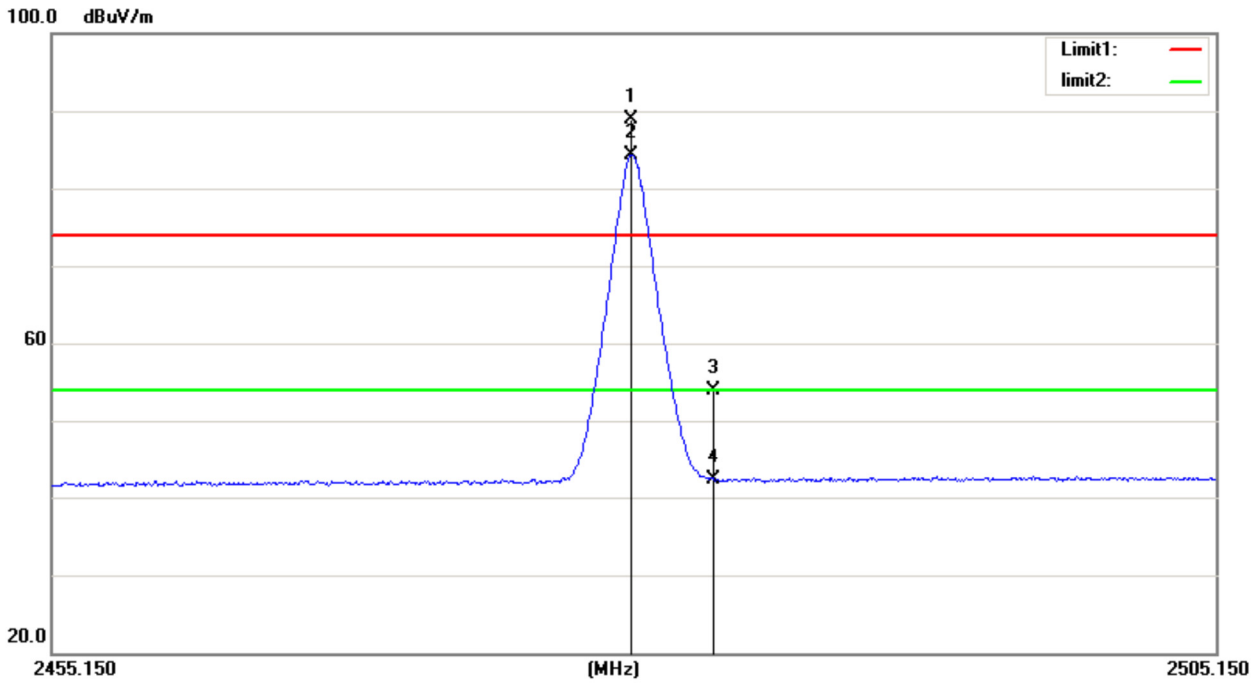

No.	Mk.	Freq.	Reading Level	Correct Factor	Measurement	Limit	Over	Antenna Height	Table Degree	Comment	
		MHz	dBuV	dB	dBuV/m	dB/m	dB	cm	degree		
1	X	2479.950	58.22	30.67	88.89	74.00	14.89	peak	150	2	No Limit
2	*	2479.950	53.64	30.67	84.31	54.00	30.31	AVG	150	2	No Limit
3		2483.500	23.25	30.71	53.96	74.00	-20.04	peak	150	2	
4		2483.500	11.61	30.71	42.32	54.00	-11.68	AVG	150	2	

Test Mode: TX 2480 MHz\_CH78\_1Mbps

### Horizontal

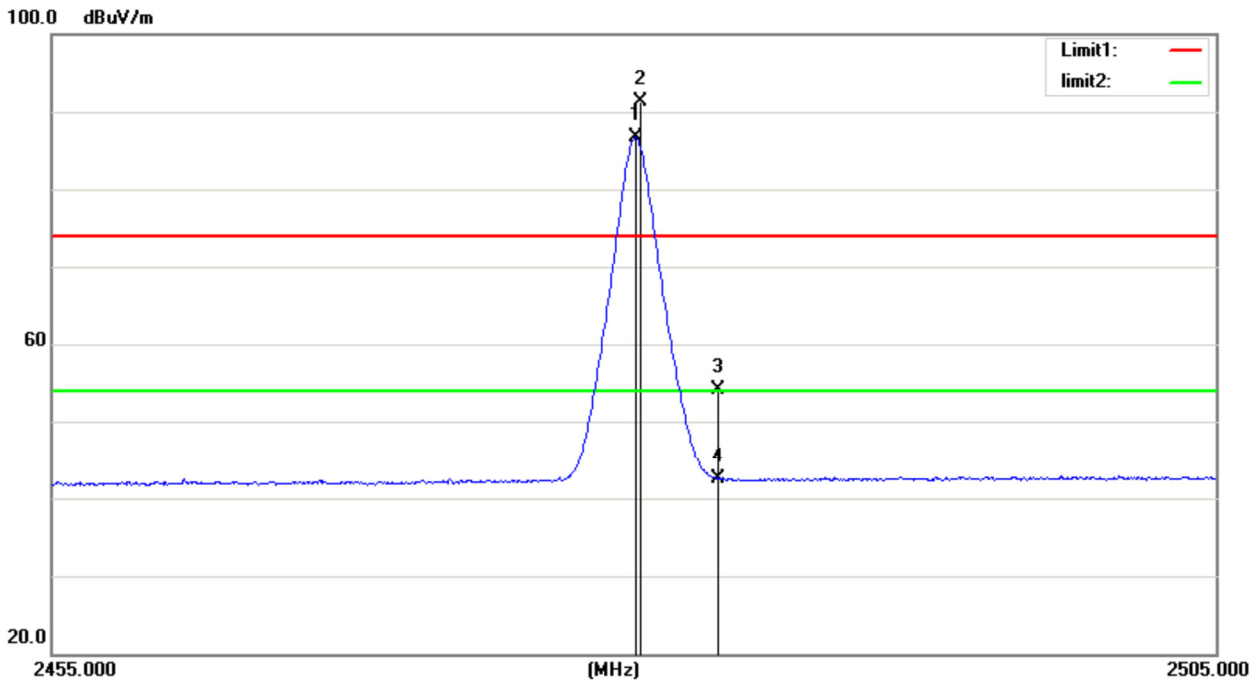

No.	Mk.	Freq.	Reading Level	Correct Factor	Measurement	Limit	Over	Antenna Height	Table Degree	Comment	
		MHz	dBuV	dB	dBuV/m	dB/m	dB	cm	degree		
1	*	2480.000	55.97	30.67	86.64	54.00	32.64	AVG	150	12	No Limit
2	X	2480.200	60.68	30.67	91.35	74.00	17.35	peak	150	12	No Limit
3		2483.500	23.40	30.71	54.11	74.00	-19.89	peak	150	12	
4		2483.500	11.89	30.71	42.60	54.00	-11.40	AVG	150	12	

Test Mode: TX 2402 MHz\_CH00\_3Mbps

### Vertical

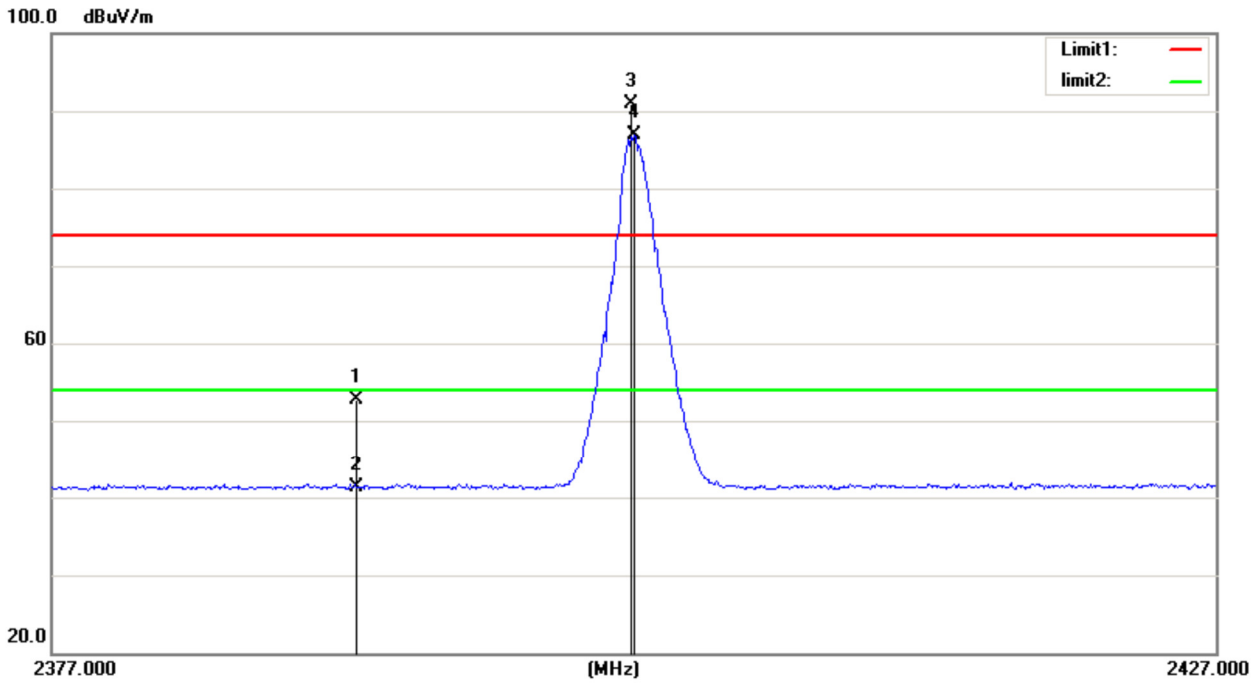

No.	Mk.	Freq.	Reading Level	Correct Factor	Measurement	Limit	Over	Antenna Height	Table Degree		
		MHz	dBuV	dB	dBuV/m	dB/m	dB	cm	degree	Comment	
1		2390.000	22.48	30.14	52.62	74.00	-21.38	peak	150	280	
2		2390.000	11.25	30.14	41.39	54.00	-12.61	AVG	150	280	
3	X	2401.800	60.83	30.15	90.98	74.00	16.98	peak	150	280	No Limit
4	*	2401.950	56.66	30.15	86.81	54.00	32.81	AVG	150	280	No Limit

Test Mode: TX 2402 MHz\_CH00\_3Mbps

### Horizontal

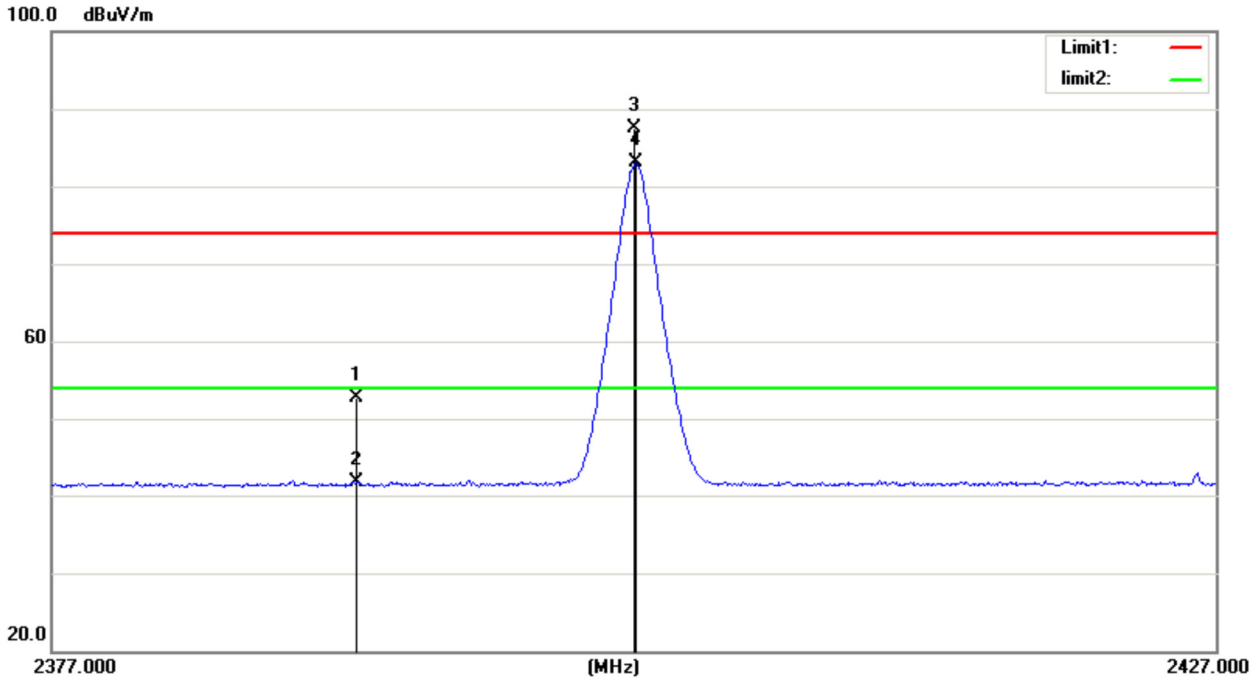

No.	Mk.	Freq. MHz	Reading Level dBuV	Correct Factor dB	Measure- ment dBuV/m	Limit dB/m	Over dB	Detector	Antenna Height cm	Table Degree	Comment
1		2390.000	22.55	30.14	52.69	74.00	-21.31	peak	150	254	
2		2390.000	11.50	30.14	41.64	54.00	-12.36	AVG	150	254	
3	X	2401.900	57.41	30.15	87.56	74.00	13.56	peak	150	254	No Limit
4	*	2402.000	52.96	30.15	83.11	54.00	29.11	AVG	150	254	No Limit

Test Mode: TX 2480 MHz\_CH78\_3Mbps

### Vertical

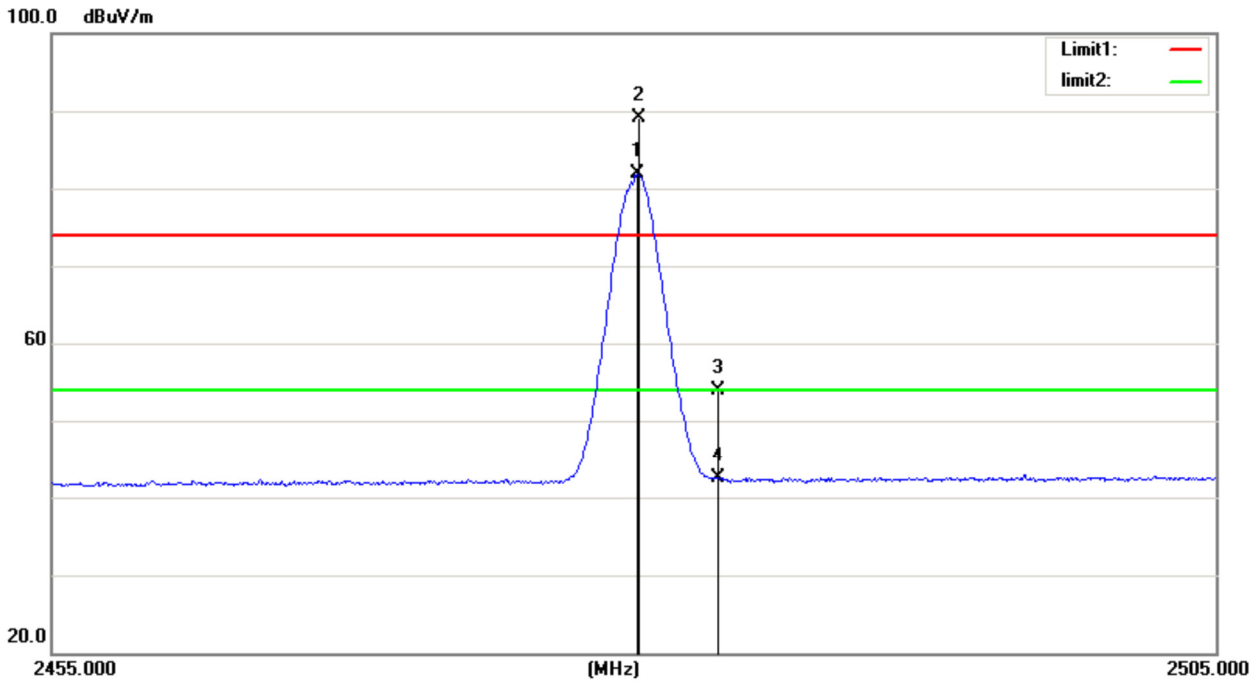

No.	Mk.	Freq.	Reading Level	Correct Factor	Measurement	Limit	Over	Antenna Height	Table Degree	Comment	
		MHz	dBuV	dB	dBuV/m	dB/m	dB	cm	degree		
1	*	2480.050	51.16	30.67	81.83	54.00	27.83	AVG	150	5	No Limit
2	X	2480.150	58.47	30.67	89.14	74.00	15.14	peak	150	5	No Limit
3		2483.500	23.19	30.71	53.90	74.00	-20.10	peak	150	5	
4		2483.500	11.87	30.71	42.58	54.00	-11.42	AVG	150	5	

Test Mode: TX 2480 MHz\_CH78\_3Mbps

### Horizontal

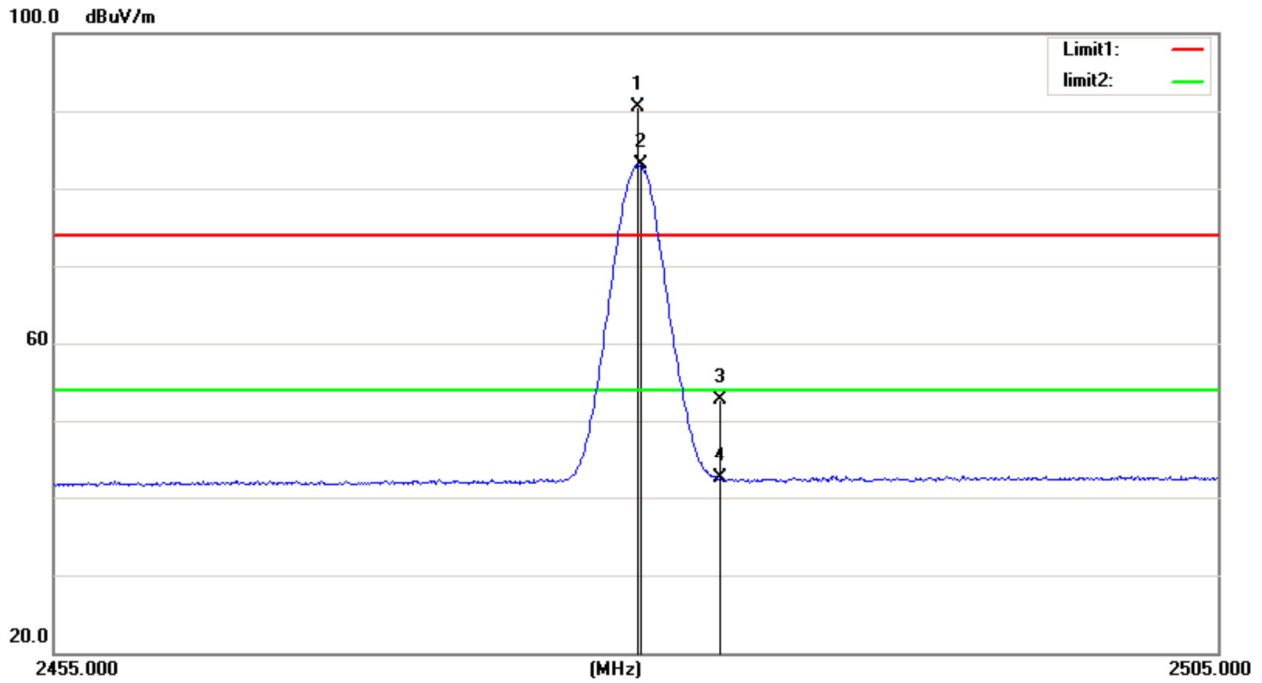

No.	Mk.	Freq.	Reading Level	Correct Factor	Measurement	Limit	Over	Antenna Height	Table Degree	Comment	
		MHz	dBuV	dB	dBuV/m	dB/m	dB	cm	degree		
1	X	2479.950	59.75	30.67	90.42	74.00	16.42	peak	150	6	No Limit
2	*	2480.100	52.41	30.67	83.08	54.00	29.08	AVG	150	6	No Limit
3		2483.500	22.01	30.71	52.72	74.00	-21.28	peak	150	6	
4		2483.500	11.73	30.71	42.44	54.00	-11.56	AVG	150	6	

## 5.9 TEST RESULTS - ABOVE 1000MHz(HARMONIC)

Test Mode: TX 2402 MHz\_CH00\_1Mbps

### Vertical

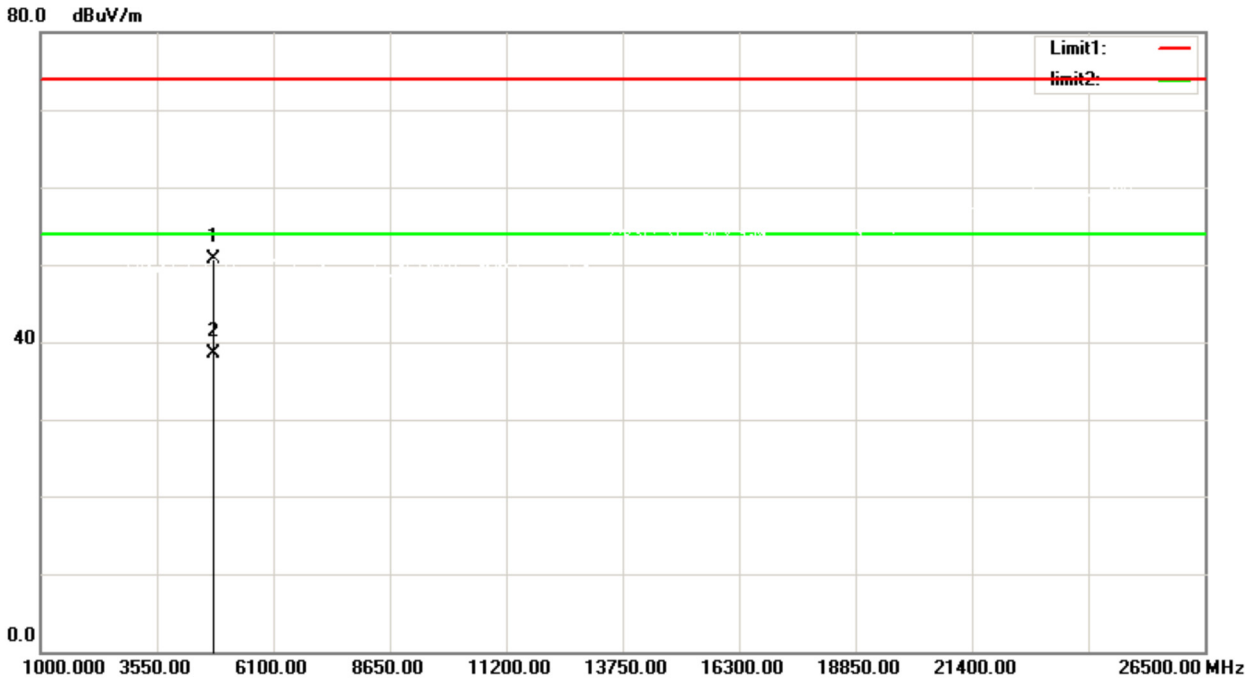

No.	Mk.	Freq.	Reading Level	Correct Factor	Measurement	Limit	Over	Antenna Height	Table Degree	
		MHz	dBuV	dB	dBuV/m	dB/m	dB	cm	degree	Comment
1		4804.000	52.55	-1.90	50.65	74.00	-23.35	peak	150	25
2	*	4804.000	40.44	-1.90	38.54	54.00	-15.46	AVG	150	25



Test Mode: TX 2402 MHz\_CH00\_1Mbps

### Horizontal

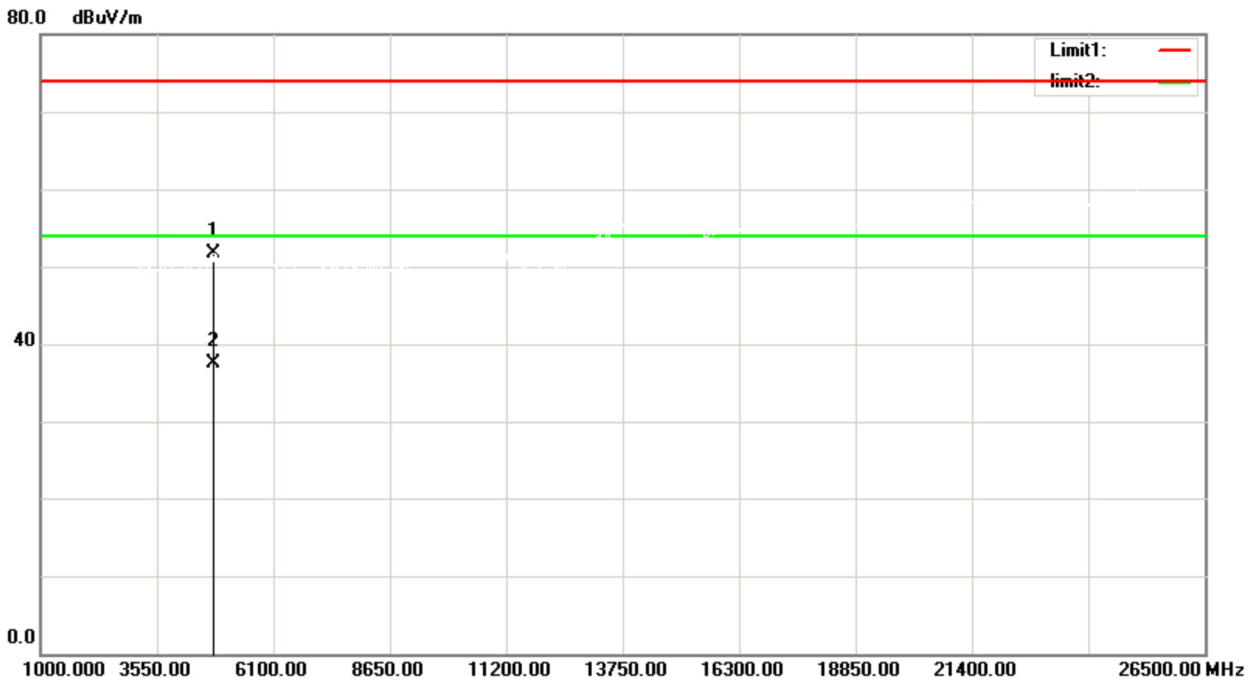

No.	Mk.	Freq.	Reading Level	Correct Factor	Measurement	Limit	Over	Antenna Height	Table Degree	
		MHz	dBuV	dB	dBuV/m	dB/m	dB	cm	degree	Comment
1		4804.000	53.55	-1.90	51.65	74.00	-22.35	peak	150	11
2	*	4804.000	39.45	-1.90	37.55	54.00	-16.45	AVG	150	11

Test Mode: TX 2441 MHz\_CH39\_1Mbps

### Vertical

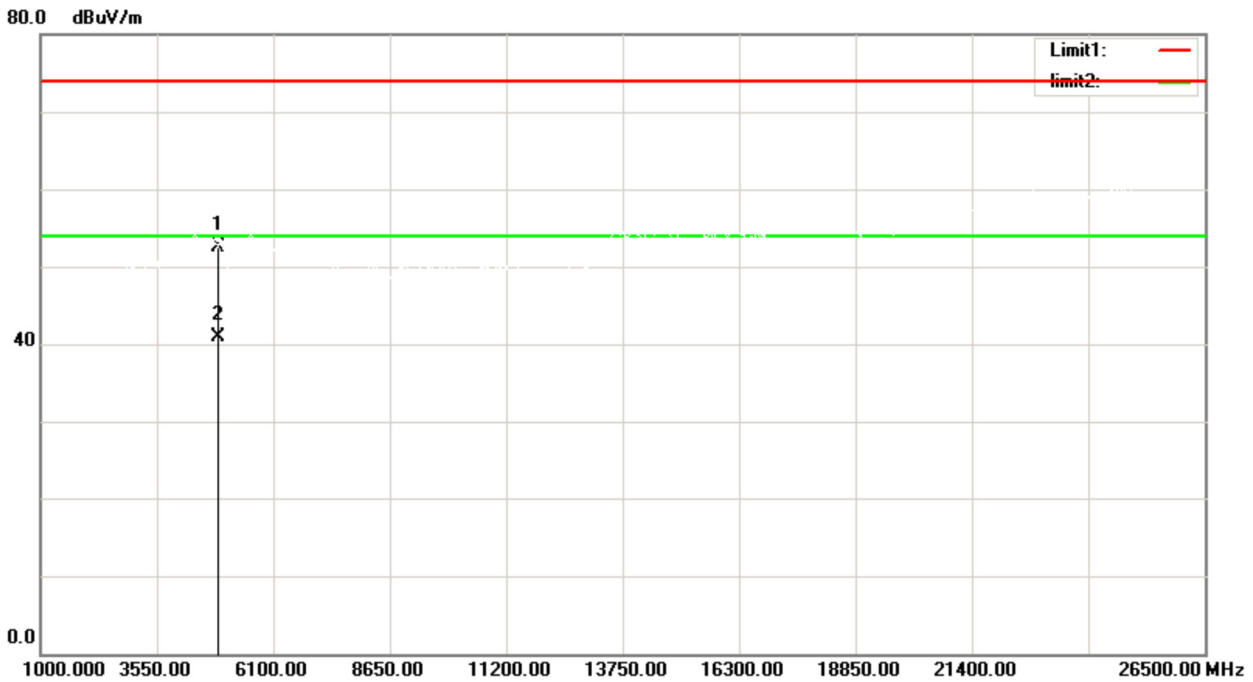

No.	Mk.	Freq. MHz	Reading Level dBuV	Correct Factor dB	Measure- ment dBuV/m	Limit dB/m	Over dB	Detector	Antenna Height cm	Table Degree	Comment
1		4884.000	54.75	-2.15	52.60	74.00	-21.40	peak	150	41	
2	*	4884.000	43.00	-2.15	40.85	54.00	-13.15	AVG	150	41	

Test Mode: TX 2441 MHz\_CH39\_1Mbps

### Horizontal

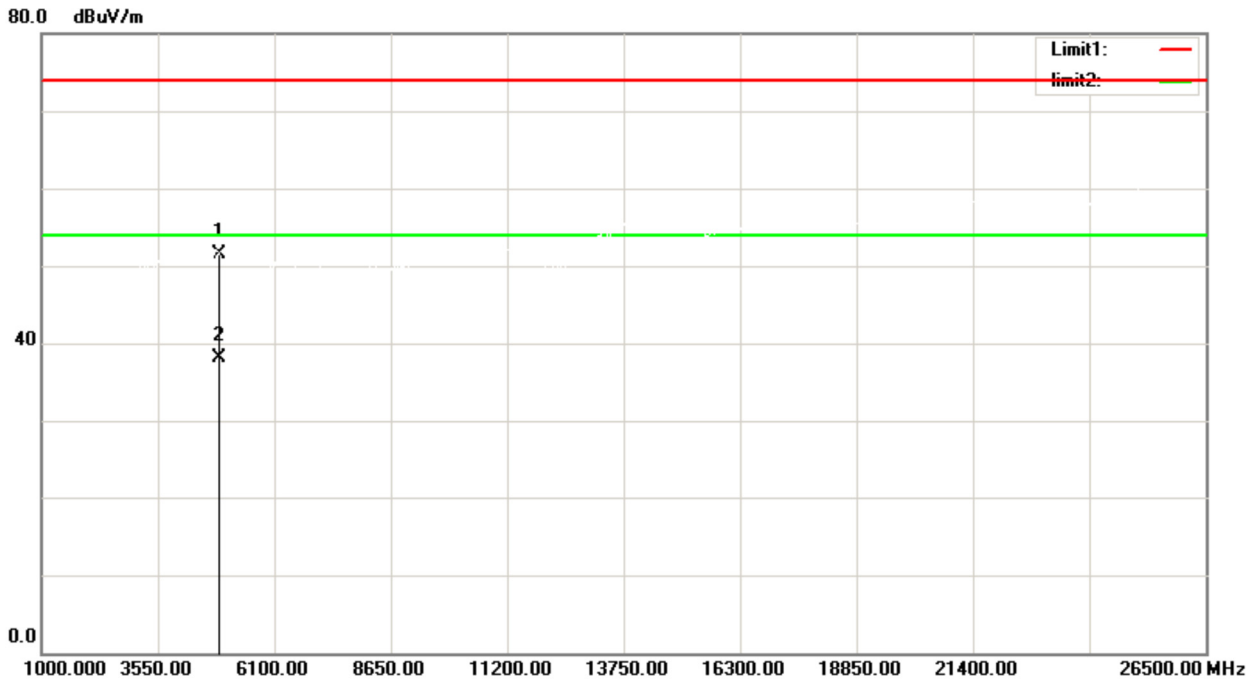

No. Mk.	Freq. MHz	Reading Level dBuV	Correct Factor dB	Measure- ment dBuV/m	Limit dB/m	Over dB	Detector	Antenna Height cm	Table Degree	Comment
1	4884.000	53.75	-2.15	51.60	74.00	-22.40	peak	150	0	
2 *	4884.000	40.26	-2.15	38.11	54.00	-15.89	AVG	150	0	

Test Mode: TX 2480 MHz\_CH78\_1Mbps

### Vertical

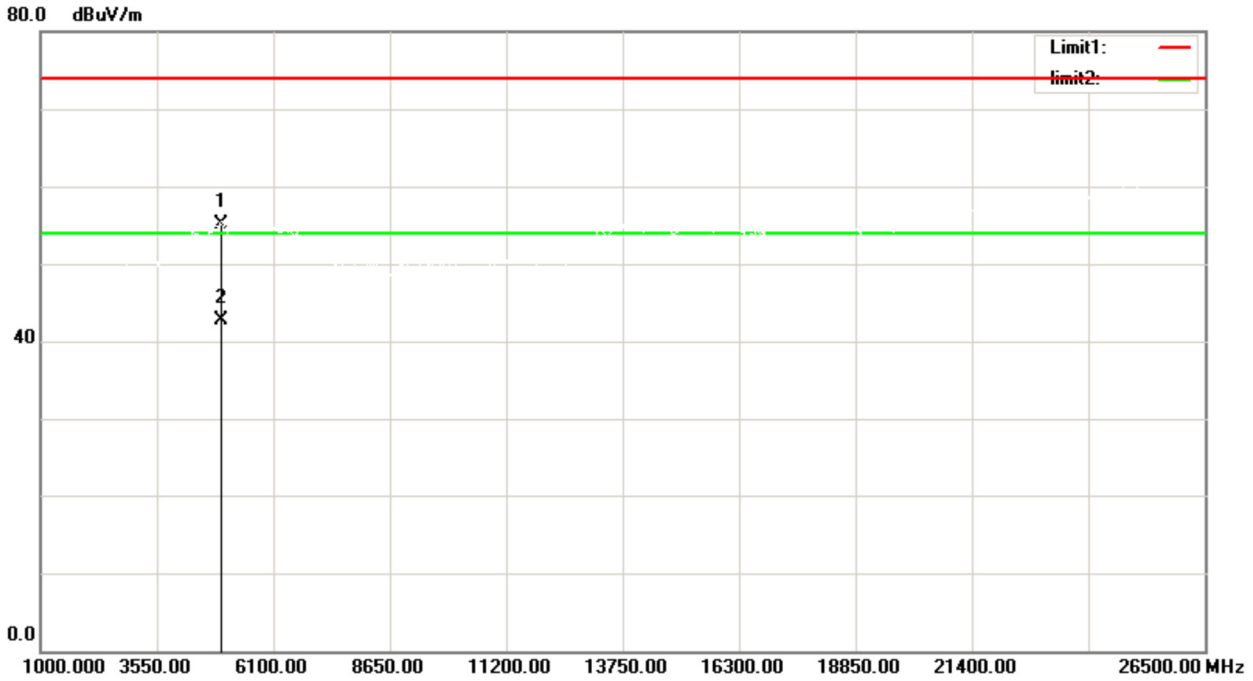

No.	Mk.	Freq.	Reading Level	Correct Factor	Measurement	Limit	Over	Antenna Height	Table Degree	Comment
		MHz	dBuV	dB	dBuV/m	dB/m	dB	cm	degree	
1		4960.000	56.87	-1.76	55.11	74.00	-18.89	peak	150	8
2	*	4960.000	44.45	-1.76	42.69	54.00	-11.31	AVG	150	8

Test Mode: TX 2480 MHz\_CH78\_1Mbps

### Horizontal

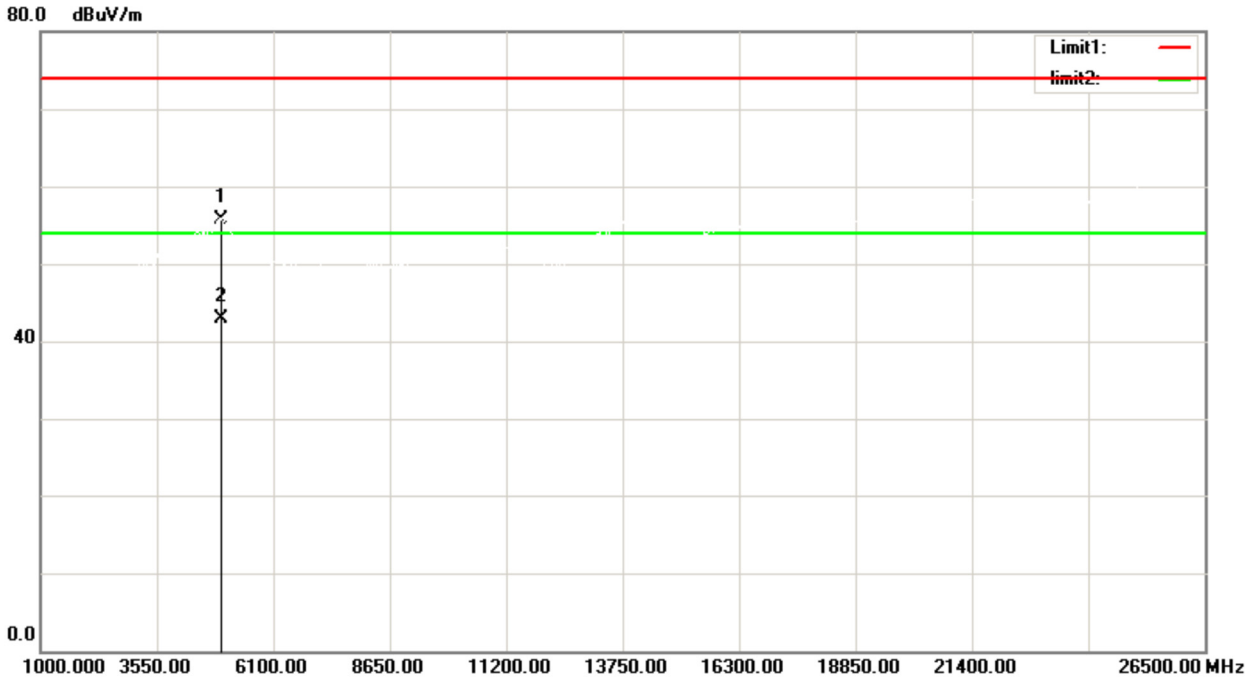

No.	Mk.	Freq.	Reading Level	Correct Factor	Measurement	Limit	Over	Antenna Height	Table Degree	
		MHz	dBuV	dB	dBuV/m	dB/m	dB	cm	degree	Comment
1		4960.000	57.37	-1.76	55.61	74.00	-18.39	peak	150	296
2	*	4960.000	44.63	-1.76	42.87	54.00	-11.13	AVG	150	296

Test Mode: TX 2402 MHz\_CH00\_3Mbps

### Vertical

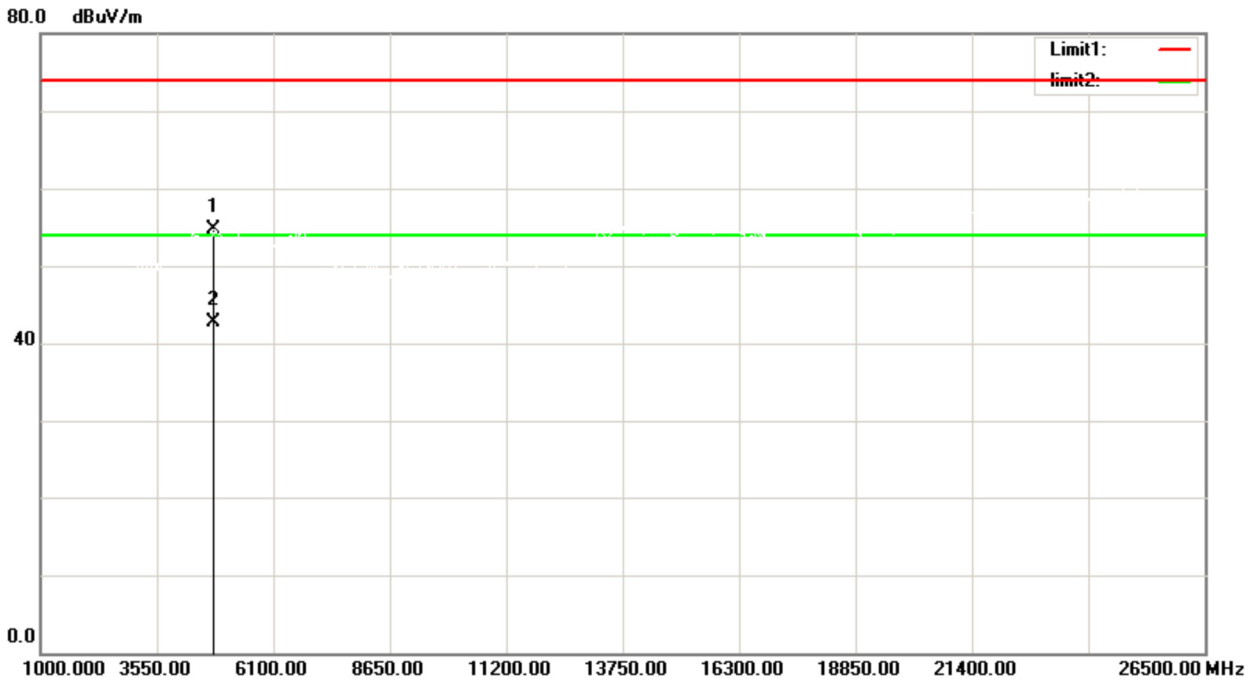

No.	Mk.	Freq.	Reading Level	Correct Factor	Measurement	Limit	Over	Antenna Height	Table Degree	
		MHz	dBuV	dB	dBuV/m	dB/m	dB	cm	degree	Comment
1		4804.000	56.55	-1.90	54.65	74.00	-19.35	peak	150	58
2	*	4804.000	44.56	-1.90	42.66	54.00	-11.34	AVG	150	58

Test Mode: TX 2402 MHz\_CH00\_3Mbps

### Horizontal

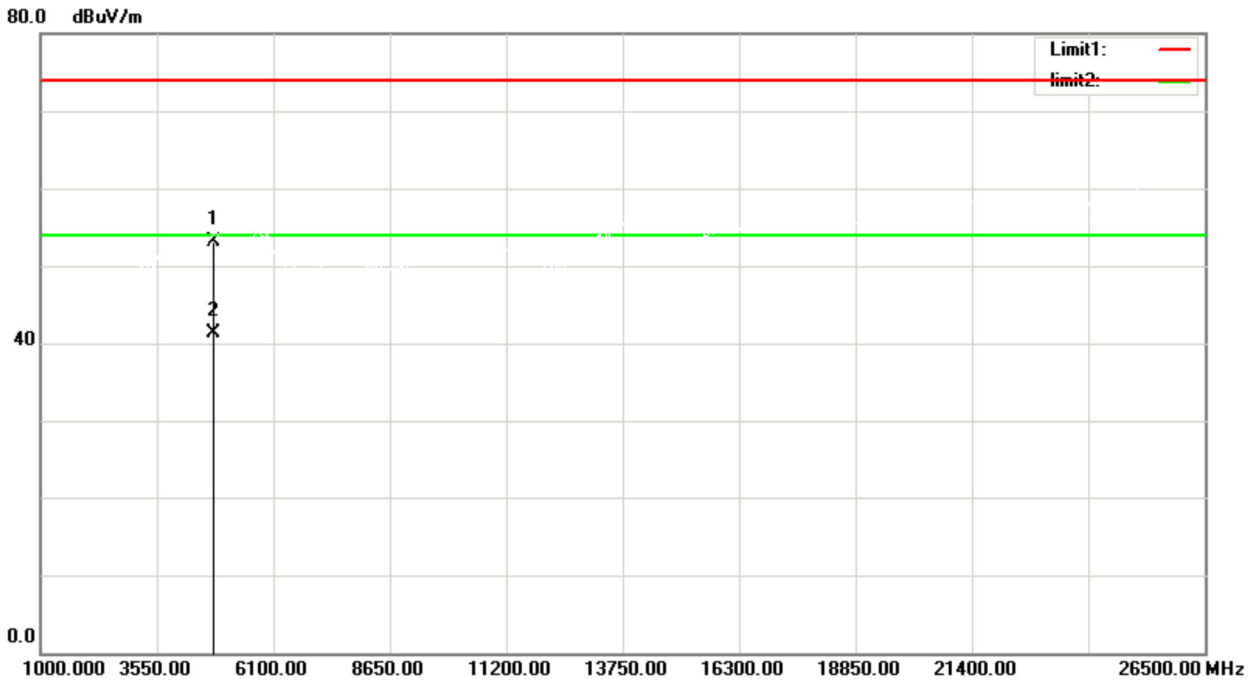

No.	Mk.	Freq.	Reading Level	Correct Factor	Measurement	Limit	Over	Antenna Height	Table Degree	
		MHz	dBuV	dB	dBuV/m	dB/m	dB	cm	degree	Comment
1		4804.000	55.01	-1.90	53.11	74.00	-20.89	150	32	peak
2	*	4804.000	43.23	-1.90	41.33	54.00	-12.67	150	32	AVG

Test Mode: TX 2441 MHz\_CH39\_3Mbps

### Vertical

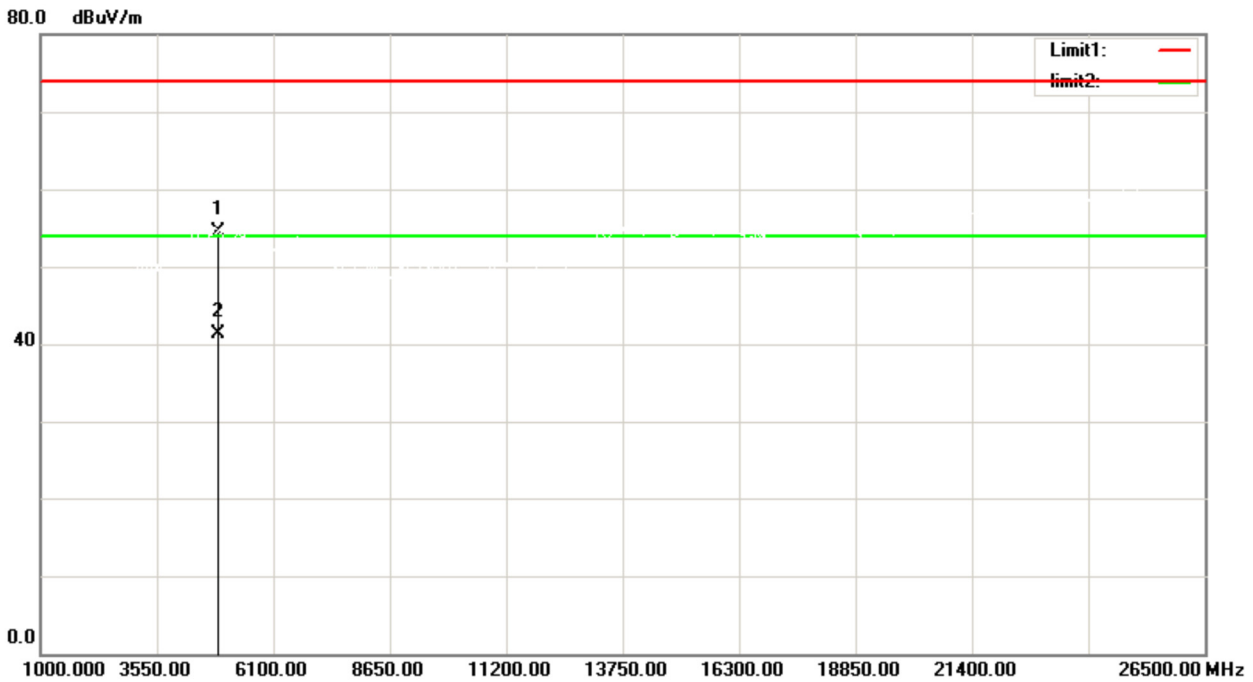

No. Mk.	Freq. MHz	Reading Level dBuV	Correct Factor dB	Measure- ment dBuV/m	Limit dB/m	Over dB	Detector	Antenna Height cm	Table Degree	Comment
1	4884.000	56.75	-2.15	54.60	74.00	-19.40	peak	150	23	
2 *	4884.000	43.43	-2.15	41.28	54.00	-12.72	AVG	150	23	



Test Mode: TX 2441 MHz\_CH39\_3Mbps

### Horizontal

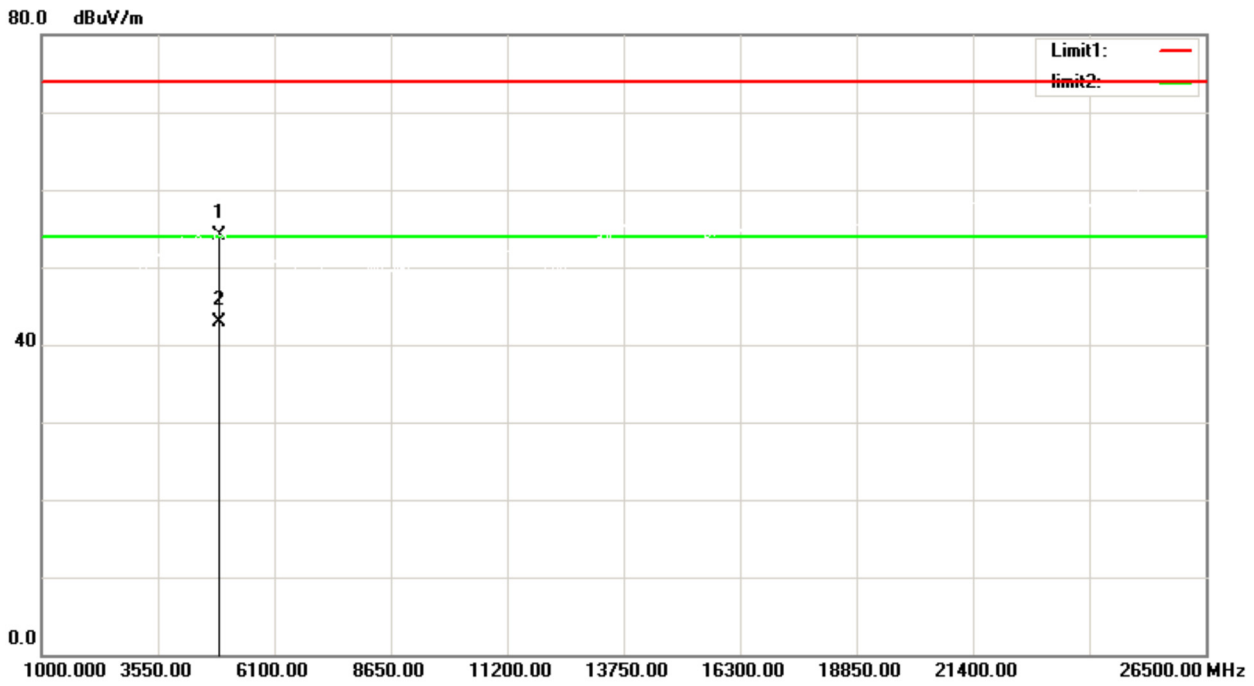

No.	Mk.	Freq.	Reading Level	Correct Factor	Measurement	Limit	Over	Antenna Height	Table Degree	
		MHz	dBuV	dB	dBuV/m	dB/m	dB	cm	degree	Comment
1		4884.000	56.25	-2.15	54.10	74.00	-19.90	peak	150	9
2	*	4884.000	44.96	-2.15	42.81	54.00	-11.19	AVG	150	9

Test Mode: TX 2480 MHz\_CH78\_3Mbps

### Vertical

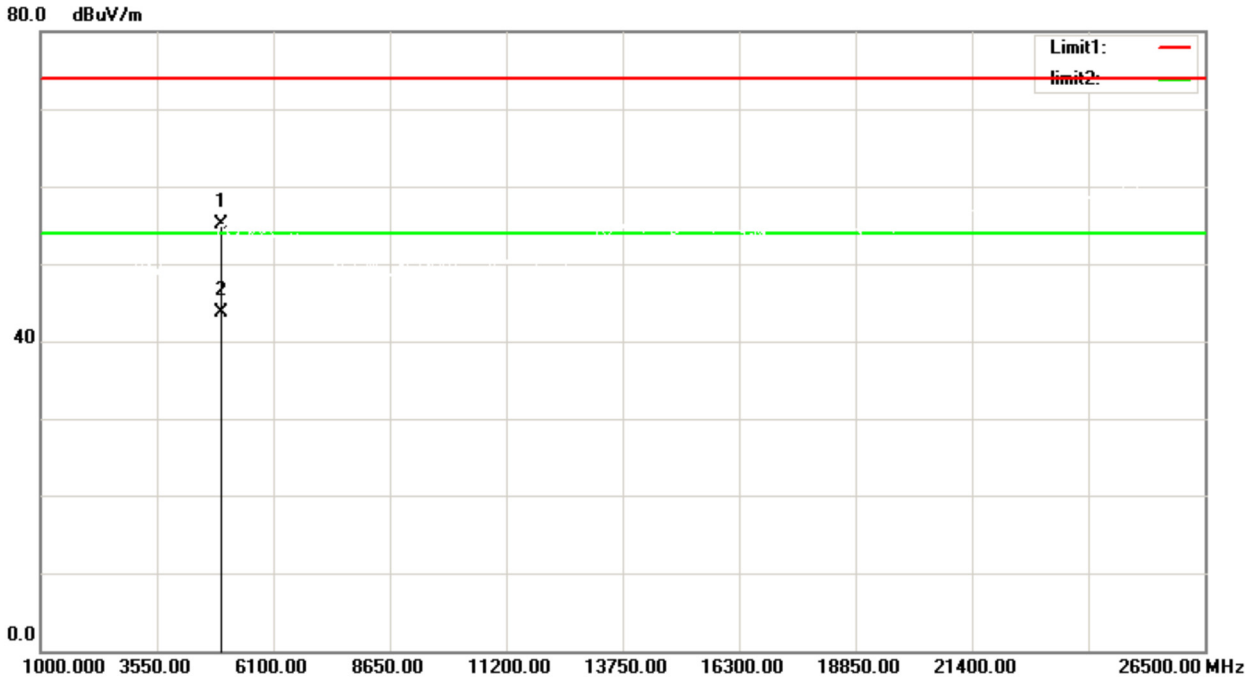

No.	Mk.	Freq.	Reading Level	Correct Factor	Measurement	Limit	Over	Antenna Height	Table Degree	
		MHz	dBuV	dB	dBuV/m	dB/m	dB	cm	degree	Comment
1		4960.000	56.87	-1.76	55.11	74.00	-18.89	peak	150	39
2	*	4960.000	45.42	-1.76	43.66	54.00	-10.34	AVG	150	39