



## Shenzhen Huaxia Testing Technology Co., Ltd.

1F., Block A of Tongsheng Technology Building, Huahui Road, Dalang Street, Longhua District, Shenzhen, China

Telephone: +86-755-26648640  
Fax: +86-755-26648637  
Website: [www.cqa-cert.com](http://www.cqa-cert.com)

Report Template Version: V05  
Report Template Revision Date: 2021-11-03



中国认可  
国际互认  
检测  
TESTING  
CNAS L5785

# Test Report

**Report No.:** CQASZ20230601151E-01  
**Applicant:** Wearable Devices LTD  
**Address of Applicant:** Ha'Tnufa St 5, Yokneam Ilit 2066736  
**Equipment Under Test (EUT):**  
**Product:** Mudra Band  
**Model No.:** 2  
**Test Model No.:** 2  
**Brand Name:** Mudra  
**FCC ID:** 2A5CU-MB  
**Standards:** 47 CFR Part 15, Subpart C  
**Date of Receipt:** 2023-06-27  
**Date of Test:** 2023-06-27 to 2023-07-06  
**Date of Issue:** 2023-07-28  
**Test Result:** **PASS\***

\*In the configuration tested, the EUT complied with the standards specified above.

**Tested By:**           Lewis Zhou            
( Lewis Zhou )

**Reviewed By:**           Timo Lei            
( Timo Lei )

**Approved By:**           Jack Ai            
( Jack Ai )



## 1 Version

### Revision History Of Report

Report No.	Version	Description	Issue Date
CQASZ20230601151E-01	Rev.01	Initial report	2023-07-28

## 2 Test Summary

Test Item	Test Requirement	Test method	Result
Antenna Requirement	47 CFR Part 15, Subpart C Section 15.203/15.247 (c)	ANSI C63.10 2013	PASS
AC Power Line Conducted Emission	47 CFR Part 15, Subpart C Section 15.207	ANSI C63.10 2013	PASS
Conducted Peak Output Power	47 CFR Part 15, Subpart C Section 15.247 (b)(1)	ANSI C63.10 2013	PASS
6dB Occupied Bandwidth	47 CFR Part 15, Subpart C Section 15.247 (a)(2)	ANSI C63.10 2013	PASS
Power Spectral Density	47 CFR Part 15, Subpart C Section 15.247 (e)	ANSI C63.10 2013	PASS
Band-edge for RF Conducted Emissions	47 CFR Part 15, Subpart C Section 15.247(d)	ANSI C63.10 2013	PASS
RF Conducted Spurious Emissions	47 CFR Part 15, Subpart C Section 15.247(d)	ANSI C63.10 2013	PASS
Radiated Spurious Emissions	47 CFR Part 15, Subpart C Section 15.205/15.209	ANSI C63.10 2013	PASS
Restricted bands around fundamental frequency (Radiated Emission)	47 CFR Part 15, Subpart C Section 15.205/15.209	ANSI C63.10 2013	PASS

### 3 Contents

	Page
<b>1 VERSION</b> .....	<b>2</b>
<b>2 TEST SUMMARY</b> .....	<b>3</b>
<b>3 CONTENTS</b> .....	<b>4</b>
<b>4 GENERAL INFORMATION</b> .....	<b>5</b>
4.1 CLIENT INFORMATION .....	5
4.2 GENERAL DESCRIPTION OF EUT .....	5
4.3 ADDITIONAL INSTRUCTIONS .....	7
4.4 TEST ENVIRONMENT .....	8
4.5 DESCRIPTION OF SUPPORT UNITS .....	8
4.6 STATEMENT OF THE MEASUREMENT UNCERTAINTY .....	9
4.7 TEST LOCATION .....	10
4.8 TEST FACILITY .....	10
4.9 DEVIATION FROM STANDARDS .....	10
4.10 OTHER INFORMATION REQUESTED BY THE CUSTOMER .....	10
4.11 EQUIPMENT LIST .....	11
<b>5 TEST RESULTS AND MEASUREMENT DATA</b> .....	<b>12</b>
5.1 ANTENNA REQUIREMENT .....	12
5.2 CONDUCTED EMISSIONS .....	13
5.3 CONDUCTED PEAK OUTPUT POWER .....	17
5.4 6dB OCCUPY BANDWIDTH .....	21
5.5 POWER SPECTRAL DENSITY .....	25
5.6 BAND-EDGE FOR RF CONDUCTED EMISSIONS .....	29
5.7 SPURIOUS RF CONDUCTED EMISSIONS .....	32
5.8 RADIATED SPURIOUS EMISSION & RESTRICTED BANDS .....	42
5.8.1 <i>Spurious Emissions</i> .....	42
<b>6 PHOTOGRAPHS - EUT TEST SETUP</b> .....	<b>49</b>
6.1 RADIATED SPURIOUS EMISSION .....	49
6.2 CONDUCTED EMISSIONS TEST SETUP .....	50
<b>7 PHOTOGRAPHS - EUT CONSTRUCTIONAL DETAILS</b> .....	<b>51</b>

## 4 General Information

### 4.1 Client Information

Applicant:	Wearable Devices LTD
Address of Applicant:	Ha'Tnufa St 5, Yokneam Ilit 2066736
Manufacturer:	Wearable Devices LTD
Address of Manufacturer:	Ha'Tnufa St 5, Yokneam Ilit 2066736

### 4.2 General Description of EUT

Product Name:	Mudra Band
Model No.:	2
Test Model No.:	2
Trade Mark:	Mudra
Software Version:	6.0.7
Hardware Version:	2.01
Operation Frequency:	2402MHz~2480MHz
Bluetooth Version:	V5.3
Modulation Type:	GFSK
Transfer Rate:	1Mbps, 2Mbps
Number of Channel:	40
Product Type:	<input type="checkbox"/> Mobile <input checked="" type="checkbox"/> Portable
Test Software of EUT:	J-Link RTT Viewer V7.88h
Antenna Type:	Chip antenna
Antenna Gain:	0dBi
EUT Power Supply:	Li-ion battery: DC 3.8V 35mAh, Charge by DC 5V for adapter
Simultaneous Transmission	<input type="checkbox"/> Simultaneous TX is supported and evaluated in this report. <input checked="" type="checkbox"/> Simultaneous TX is not supported.

Operation Frequency each of channel							
Channel	Frequency	Channel	Frequency	Channel	Frequency	Channel	Frequency
0	2402MHz	10	2422MHz	20	2442MHz	30	2462MHz
1	2404MHz	11	2424MHz	21	2444MHz	31	2464MHz
2	2406MHz	12	2426MHz	22	2446MHz	32	2466MHz
3	2408MHz	13	2428MHz	23	2448MHz	33	2468MHz
4	2410MHz	14	2430MHz	24	2450MHz	34	2470MHz
5	2412MHz	15	2432MHz	25	2452MHz	35	2472MHz
6	2414MHz	16	2434MHz	26	2454MHz	36	2474MHz
7	2416MHz	17	2436MHz	27	2456MHz	37	2476MHz
8	2418MHz	18	2438MHz	28	2458MHz	38	2478MHz
9	2420MHz	19	2440MHz	29	2460MHz	39	2480MHz

Note:

In section 15.31(m), regards to the operating frequency range over 10 MHz, the lowest frequency, the middle frequency, and the highest frequency of channel were selected to perform the test, and the selected channel see below:

Channel	Frequency
The lowest channel (CH0)	2402MHz
The middle channel (CH19)	2440MHz
The highest channel (CH39)	2480MHz

### 4.3 Additional Instructions

EUT Test Software Settings:		
Mode:	<input checked="" type="checkbox"/> Special software is used. <input type="checkbox"/> Through engineering command into the engineering mode. engineering command: <code>***#3646633#**</code>	
EUT Power level:	Class2 (Power level is built-in set parameters and cannot be changed and selected)	
Use test software to set the lowest frequency, the middle frequency and the highest frequency keep transmitting of the EUT.		
Mode	Channel	Frequency(MHz)
GFSK	CH0	2402
	CH19	2440
	CH39	2480

#### Run Software:



#### 4.4 Test Environment

Operating Environment:	
Temperature:	24.5°C
Humidity:	59% RH
Atmospheric Pressure:	1009mbar
Test Mode:	Use test software to set the lowest frequency, the middle frequency and the highest frequency keep transmitting of the EUT.

#### 4.5 Description of Support Units

The EUT has been tested with associated equipment below.

1) Support equipment

Description	Manufacturer	Model No.	Certification	Supplied by
/	/	/	/	/

2) Cable

Cable No.	Description	Manufacturer	Cable Type/Length	Supplied by
/	/	/	/	/



## 4.6 Statement of the measurement uncertainty

The data and results referenced in this document are true and accurate.

The reader is cautioned that there may be errors within the calibration limits of the equipment and facilities.

The measurement uncertainty was calculated for all measurements listed in this test report acc. to CISPR 16 - 4 „Specification for radio disturbance and immunity measuring apparatus and methods – Part 4: Uncertainty in EMC Measurements“ and is documented in the **Shenzhen Huaxia Testing Technology Co., Ltd.** quality system acc. to DIN EN ISO/IEC 17025.

Furthermore, component and process variability of devices similar to that tested may result in additional deviation. The manufacturer has the sole responsibility of continued compliance of the device.

Hereafter the best measurement capability for CQA laboratory is reported:

No.	Item	Uncertainty
1	Radiated Emission (Below 1GHz)	5.12dB
2	Radiated Emission (Above 1GHz)	4.60dB
3	Conducted Disturbance (0.15~30MHz)	3.34dB
4	Radio Frequency	$3 \times 10^{-8}$
5	Duty cycle	0.6 %
6	Occupied Bandwidth	1.1%
7	RF conducted power	0.86dB
8	RF power density	0.74
9	Conducted Spurious emissions	0.86dB
10	Temperature test	0.8°C
11	Humidity test	2.0%
12	Supply voltages	0.5 %
13	Frequency Error	5.5 Hz

## 4.7 Test Location

All tests were performed at:

Shenzhen Huaxia Testing Technology Co., Ltd.

1F., Block A of Tongsheng Technology Building, Huahui Road, Dalang Street, Longhua District, Shenzhen, China

## 4.8 Test Facility

- **A2LA (Certificate No. 4742.01)**

Shenzhen Huaxia Testing Technology Co., Ltd., Shenzhen EMC Laboratory is accredited by the American Association for Laboratory Accreditation(A2LA). Certificate No. 4742.01.

- **FCC Registration No.: 522263**

Shenzhen Huaxia Testing Technology Co., Ltd., Shenzhen EMC Laboratory has been registered and fully described in a report filed with the (FCC) Federal Communications Commission. The acceptance letter from the FCC is maintained in our files. Registration No.:522263

## 4.9 Deviation from Standards

None.

## 4.10 Other Information Requested by the Customer

None.

## 4.11 Equipment List

Test Equipment	Manufacturer	Model No.	Instrument No.	Calibration Date	Calibration Due Date
EMI Test Receiver	R&S	ESR7	CQA-005	2022/09/09	2023/09/08
Spectrum analyzer	R&S	FSU26	CQA-038	2022/09/09	2023/09/08
Spectrum analyzer	R&S	FSU40	CQA-075	2022/09/09	2023/09/08
Preamplifier	MITEQ	AFS4-00010300-18-10P-4	CQA-035	2022/09/09	2023/09/08
Preamplifier	MITEQ	AMF-6D-02001800-29-20P	CQA-036	2022/09/09	2023/09/08
Preamplifier	EMCI	EMC184055SE	CQA-089	2022/09/09	2023/09/08
Loop antenna	Schwarzbeck	FMZB1516	CQA-060	2021/09/16	2024/09/15
Bilog Antenna	R&S	HL562	CQA-011	2021/09/16	2024/09/15
Horn Antenna	R&S	HF906	CQA-012	2021/09/16	2024/09/15
Horn Antenna	Schwarzbeck	BBHA 9170	CQA-088	2021/09/16	2024/09/15
Coaxial Cable (Above 1GHz)	CQA	N/A	C007	2022/09/09	2023/09/08
Coaxial Cable (Below 1GHz)	CQA	N/A	C013	2022/09/09	2023/09/08
RF cable(9KHz~40GHz)	CQA	RF-01	CQA-079	2022/09/09	2023/09/08
Antenna Connector	CQA	RFC-01	CQA-080	2022/09/09	2023/09/08
Power Sensor	KEYSIGHT	U2021XA	CQA-30	2022/09/09	2023/09/08
N1918A Power Analysis Manager Power Panel	Agilent	N1918A	CQA-074	2022/09/09	2023/09/08
Power meter	R&S	NRVD	CQA-029	2022/09/09	2023/09/08
Power divider	MIDWEST	PWD-2533-02-SMA-79	CQA-067	2022/09/09	2023/09/08
EMI Test Receiver	R&S	ESR7	CQA-005	2022/09/09	2023/09/08
LISN	R&S	ENV216	CQA-003	2022/09/09	2023/09/08
Coaxial cable	CQA	N/A	CQA-C009	2022/09/09	2023/09/08
DC power	KEYSIGHT	E3631A	CQA-028	2022/09/09	2023/09/08

Note:

The temporary antenna connector is soldered on the pcb board in order to perform conducted tests and this temporary antenna connector is listed in the equipment list.

## 5 Test results and Measurement Data

### 5.1 Antenna Requirement

<b>Standard requirement:</b>	47 CFR Part 15C Section 15.203 /247(c)
<p>15.203 requirement: An intentional radiator shall be designed to ensure that no antenna other than that furnished by the responsible party shall be used with the device. The use of a permanently attached antenna or of an antenna that uses a unique coupling to the intentional radiator, the manufacturer may design the unit so that a broken antenna can be replaced by the user, but the use of a standard antenna jack or electrical connector is prohibited.</p> <p>15.247(b) (4) requirement: The conducted output power limit specified in paragraph (b) of this section is based on the use of antennas with directional gains that do not exceed 6 dBi. Except as shown in paragraph (c) of this section, if transmitting antennas of directional gain greater than 6 dBi are used, the conducted output power from the intentional radiator shall be reduced below the stated values in paragraphs (b)(1), (b)(2), and (b)(3) of this section, as appropriate, by the amount in dB that the directional gain of the antenna exceeds 6 dBi.</p>	
<b>EUT Antenna:</b>	
<p>The antenna is Chip antenna. The connection/connection type between the antenna to the EUT's antenna port is: permanently attachment This is either permanently attachment or a unique coupling that satisfies the requirement.</p>	

## 5.2 Conducted Emissions

Test Requirement:	47 CFR Part 15C Section 15.207		
Test Method:	ANSI C63.10: 2013		
Test Frequency Range:	150kHz to 30MHz		
Limit:	Frequency range (MHz)	Limit (dBuV)	
		Quasi-peak	Average
	0.15-0.5	66 to 56*	56 to 46*
	0.5-5	56	46
	5-30	60	50
	* Decreases with the logarithm of the frequency.		
Test Procedure:	<ol style="list-style-type: none"> <li>1) The mains terminal disturbance voltage test was conducted in a shielded room.</li> <li>2) The EUT was connected to AC power source through a LISN 1 (Line Impedance Stabilization Network) which provides a 50Ω/50μH + 5Ω linear impedance. The power cables of all other units of the EUT were connected to a second LISN 2, which was bonded to the ground reference plane in the same way as the LISN 1 for the unit being measured. A multiple socket outlet strip was used to connect multiple power cables to a single LISN provided the rating of the LISN was not exceeded.</li> <li>3) The tabletop EUT was placed upon a non-metallic table 0.8m above the ground reference plane. And for floor-standing arrangement, the EUT was placed on the horizontal ground reference plane,</li> <li>4) The test was performed with a vertical ground reference plane. The rear of the EUT shall be 0.4 m from the vertical ground reference plane. The vertical ground reference plane was bonded to the horizontal ground reference plane. The LISN 1 was placed 0.8 m from the boundary of the unit under test and bonded to a ground reference plane for LISNs mounted on top of the ground reference plane. This distance was between the closest points of the LISN 1 and the EUT. All other units of the EUT and associated equipment was at least 0.8 m from the LISN 2.</li> <li>5) In order to find the maximum emission, the relative positions of equipment and all of the interface cables must be changed according to ANSI C63.10: 2013 on conducted measurement.</li> </ol>		

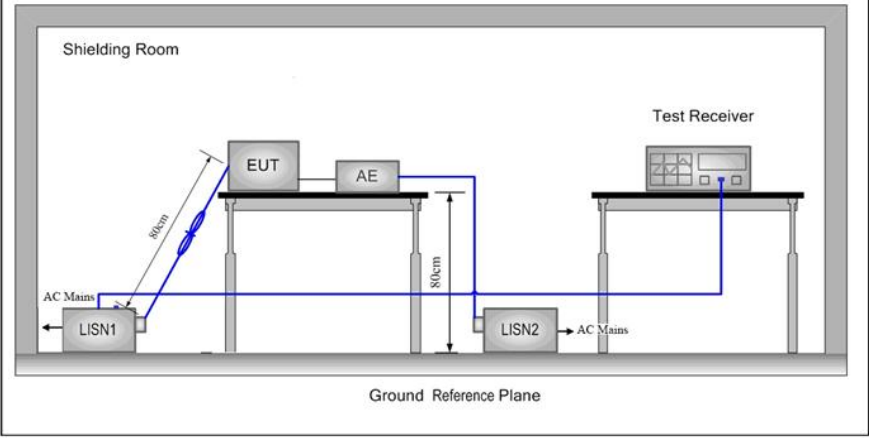
<p>Test Setup:</p>	
<p>Test Mode:</p>	<p>Charging mode</p>
<p>Test Voltage:</p>	<p>AC 120V/60Hz</p>
<p>Test Results:</p>	<p>Pass</p>

Measurement Data

Live line:

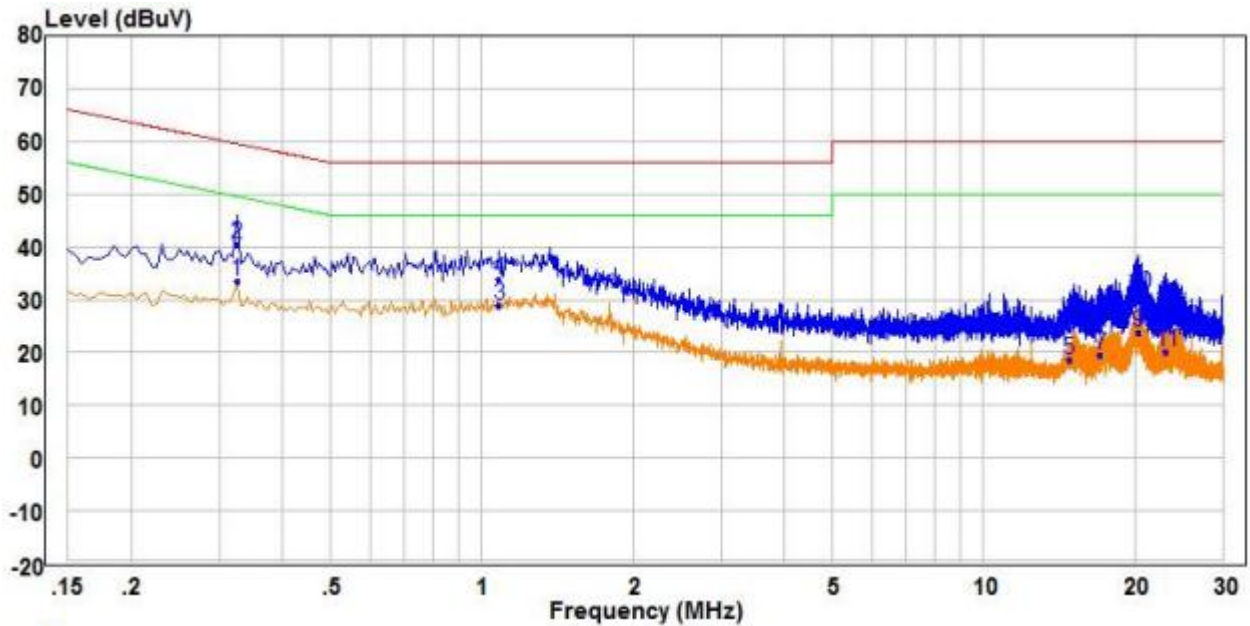

		Read		Limit	Over				
	Freq	Level	Factor	Level	Line	Limit	Remark	Pol/Phase	
	MHz	dBuV	dB	dBuV	dBuV	dB			
1	PP	0.325	24.11	9.49	33.60	49.58	-15.98	Average	Line
2	QP	0.325	31.14	9.49	40.63	59.58	-18.95	QP	Line
3		1.085	19.44	9.52	28.96	46.00	-17.04	Average	Line
4		1.085	24.29	9.52	33.81	56.00	-22.19	QP	Line
5		14.790	8.84	9.88	18.72	50.00	-31.28	Average	Line
6		14.790	14.64	9.88	24.52	60.00	-35.48	QP	Line
7		17.130	9.52	9.98	19.50	50.00	-30.50	Average	Line
8		17.130	15.75	9.98	25.73	60.00	-34.27	QP	Line
9		20.305	13.77	10.09	23.86	50.00	-26.14	Average	Line
10		20.305	20.94	10.09	31.03	60.00	-28.97	QP	Line
11		23.095	9.93	10.06	19.99	50.00	-30.01	Average	Line
12		23.095	17.66	10.06	27.72	60.00	-32.28	QP	Line

Remark:

1. The following Quasi-Peak and Average measurements were performed on the EUT:
2. Final Test Level = Receiver Reading + LISN Factor + Cable Loss.
3. If the Peak value under Average limit, the Average value is not recorded in the report.

Neutral line:

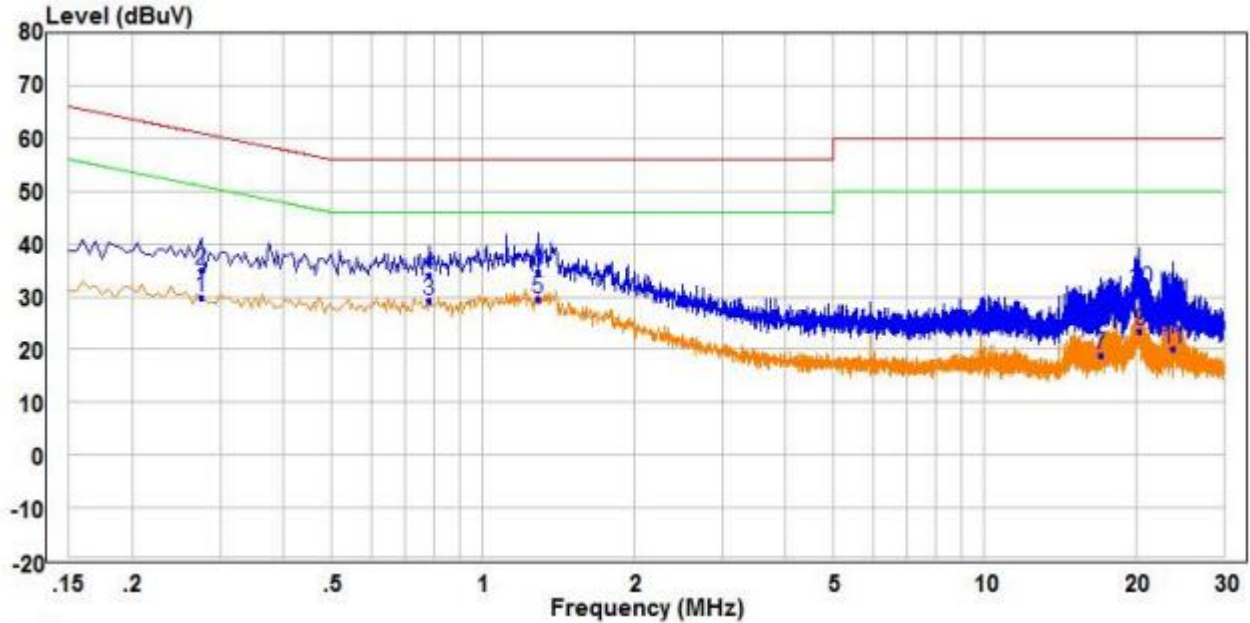

	Read Freq	Read Level	Factor	Limit Level	Over Limit	Remark	Pol/Phase
	MHz	dBuV	dB	dBuV	dBuV	dB	
1	0.275	20.37	9.51	29.88	50.97	-21.09	Average Neutral
2	0.275	25.43	9.51	34.94	60.97	-26.03	QP Neutral
3	0.780	19.33	9.85	29.18	46.00	-16.82	Average Neutral
4	0.780	24.12	9.85	33.97	56.00	-22.03	QP Neutral
5 PP	1.290	19.85	9.71	29.56	46.00	-16.44	Average Neutral
6 QP	1.290	24.92	9.71	34.63	56.00	-21.37	QP Neutral
7	17.035	9.21	9.77	18.98	50.00	-31.02	Average Neutral
8	17.035	15.44	9.77	25.21	60.00	-34.79	QP Neutral
9	20.395	13.52	9.86	23.38	50.00	-26.62	Average Neutral
10	20.395	21.64	9.86	31.50	60.00	-28.50	QP Neutral
11	23.765	10.03	9.99	20.02	50.00	-29.98	Average Neutral
12	23.765	17.27	9.99	27.26	60.00	-32.74	QP Neutral

Remark:

1. The following Quasi-Peak and Average measurements were performed on the EUT:
2. Final Test Level = Receiver Reading + LISN Factor + Cable Loss.
3. If the Peak value under Average limit, the Average value is not recorded in the report.

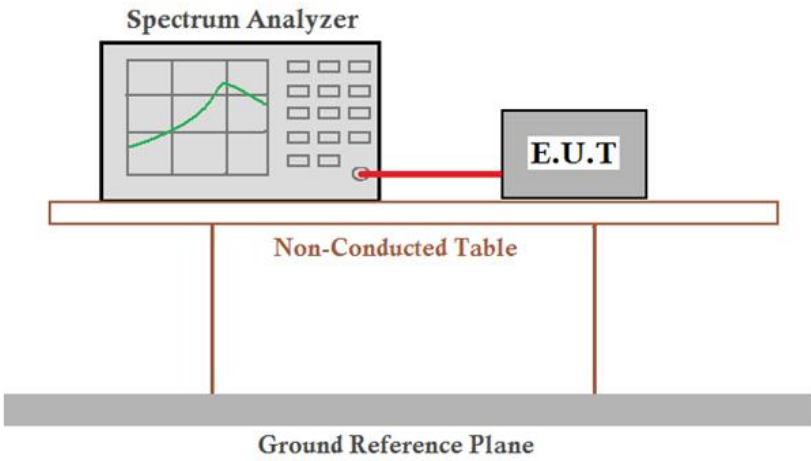

### 5.3 Conducted Peak Output Power

Test Requirement:	47 CFR Part 15C Section 15.247 (b)(1)
Test Method:	ANSI C63.10 2013
Test Setup:	 <p style="text-align: center;"><i>Remark: Offset=Cable loss+ attenuation factor.</i></p>
Limit:	30dBm
Test Mode:	Transmitting with GFSK modulation.
Test Results:	Pass

#### Measurement Data

GFSK mode (1Mbps)			
Test channel	Peak Output Power (dBm)	Limit (dBm)	Result
Lowest	0.63	30.00	Pass
Middle	1.49	30.00	Pass
Highest	1.65	30.00	Pass
GFSK mode (2Mbps)			
Test channel	Peak Output Power (dBm)	Limit (dBm)	Result
Lowest	0.37	30.00	Pass
Middle	1.26	30.00	Pass
Highest	1.25	30.00	Pass

BLE 1M Ant1 2402

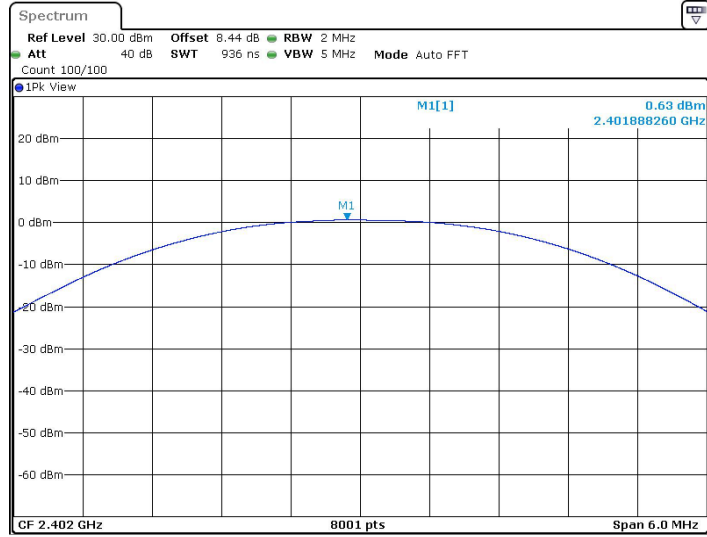

Date: 3 JUL 2023 11:07:26

BLE 1M Ant1 2440

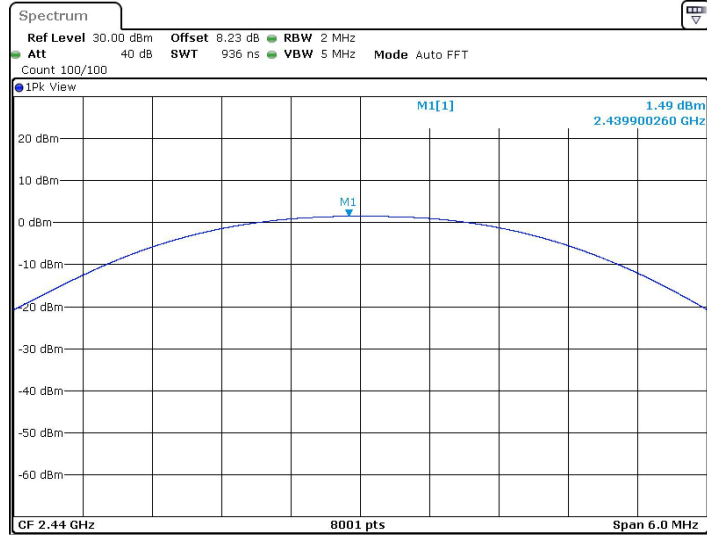

Date: 3 JUL 2023 11:12:15

BLE 1M Ant1 2480

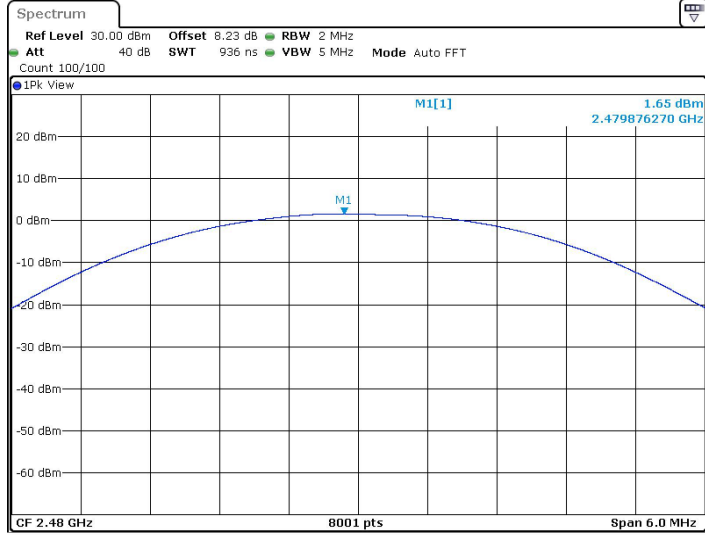

Date: 3 JUL 2023 11:52:09

BLE 2M Ant1 2402

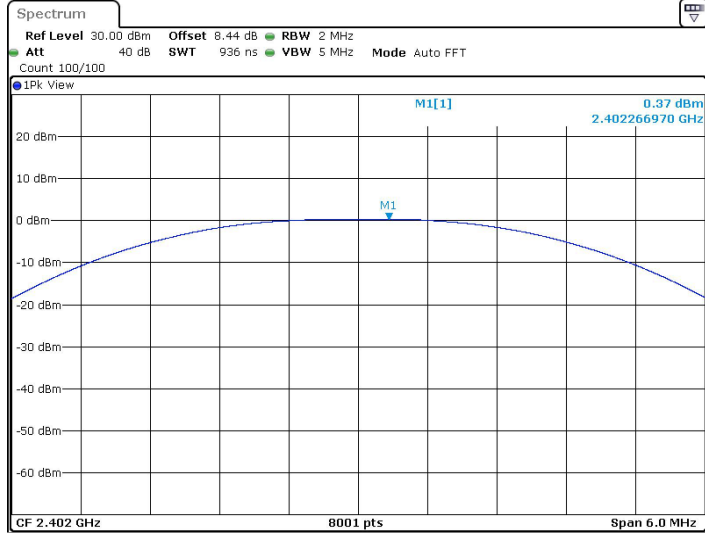

Date: 3 JUL 2023 11:55:21

BLE 2M Ant1 2440

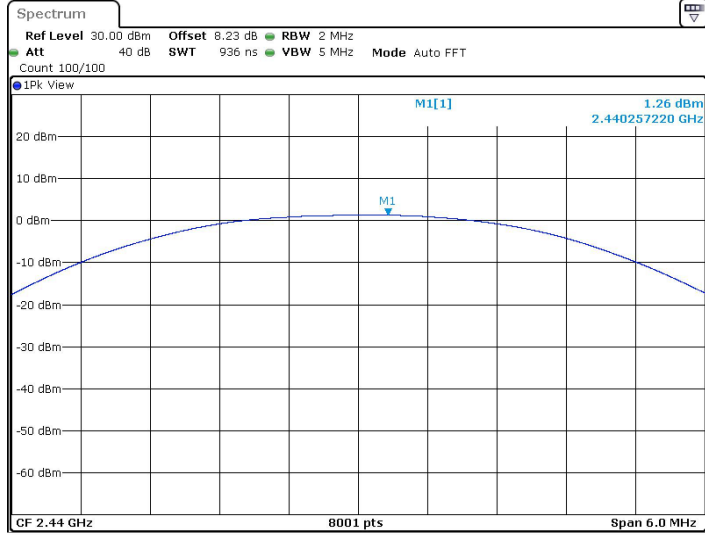

Date: 3 JUL 2023 11:59:02

BLE 2M Ant1 2480

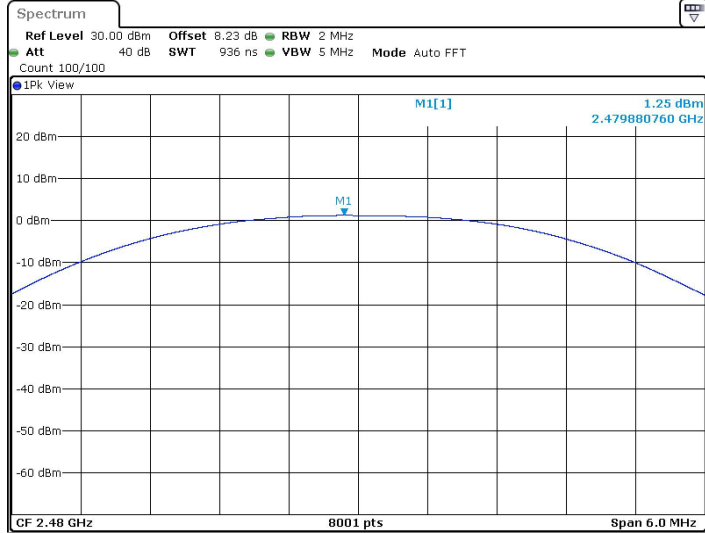

Date: 3 JUL 2023 12:01:32

## 5.4 6dB Occupy Bandwidth

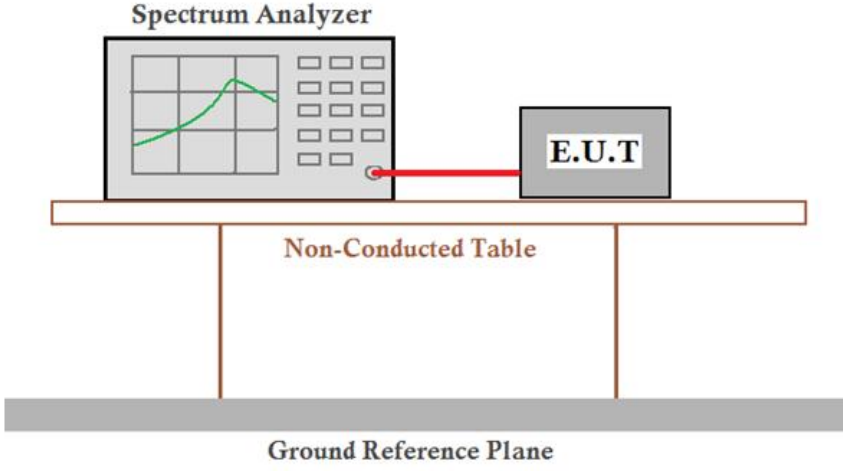
Test Requirement:	47 CFR Part 15C Section 15.247 (a)(2)
Test Method:	ANSI C63.10 2013
Test Setup:	 <p style="text-align: center;"><i>Remark: Offset=Cable loss+ attenuation factor.</i></p>
Limit:	≥ 500 kHz
Instruments Used:	Refer to section 4.11 for details.
Test Results:	Pass

### Measurement Data

GFSK mode (1Mbps)			
Test channel	6dB Occupy Bandwidth (MHz)	Limit (kHz)	Result
Lowest	0.66	≥500	Pass
Middle	0.66	≥500	Pass
Highest	0.66	≥500	Pass
GFSK mode (2Mbps)			
Test channel	6dB Occupy Bandwidth (MHz)	Limit (kHz)	Result
Lowest	1.14	≥500	Pass
Middle	1.14	≥500	Pass
Highest	1.14	≥500	Pass

BLE 1M Ant1 2402

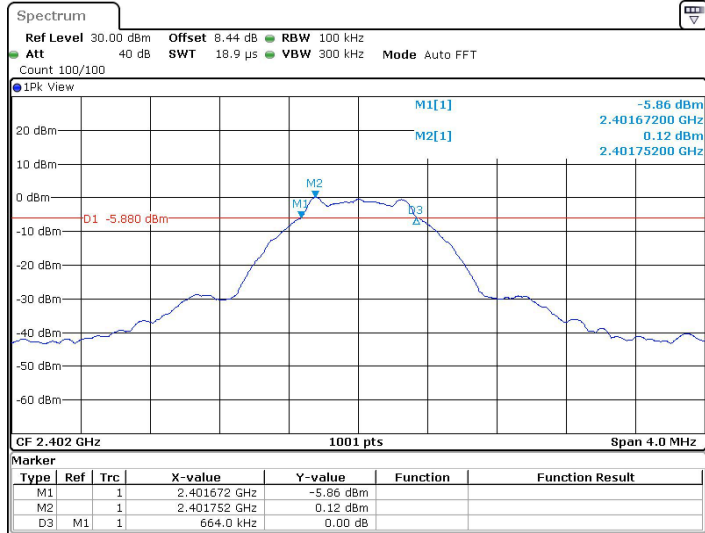

Date: 3 JUL 2023 11:07:12

BLE 1M Ant1 2440

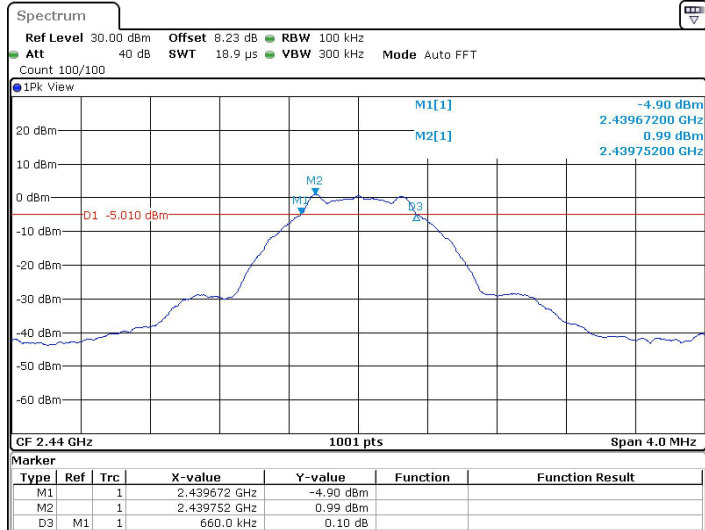

Date: 3 JUL 2023 11:12:01

BLE 1M Ant1 2480

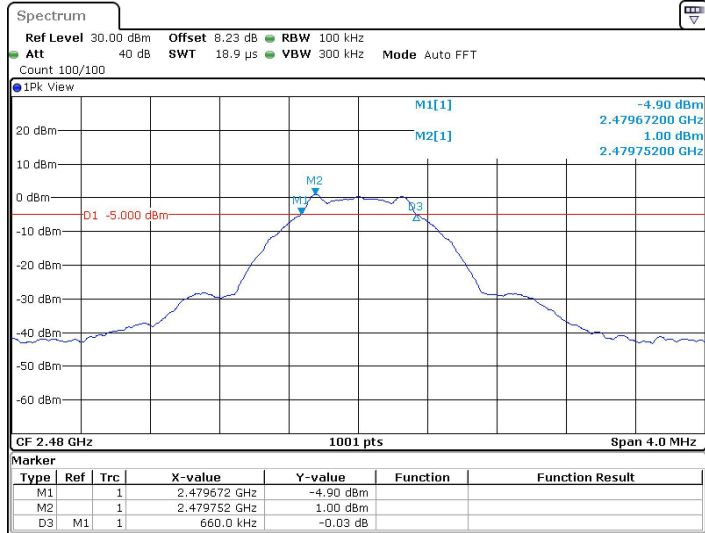

Date: 3 JUL 2023 11:51:55

BLE 2M Ant1 2402

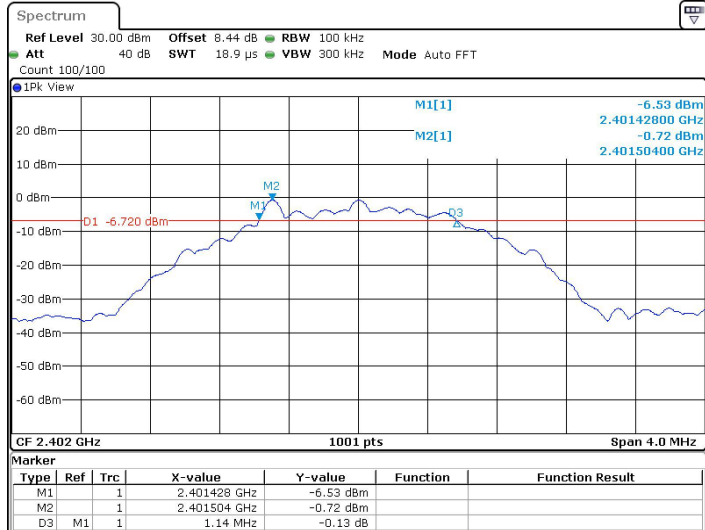

Date: 3 JUL 2023 11:55:08

BLE 2M Ant1 2440

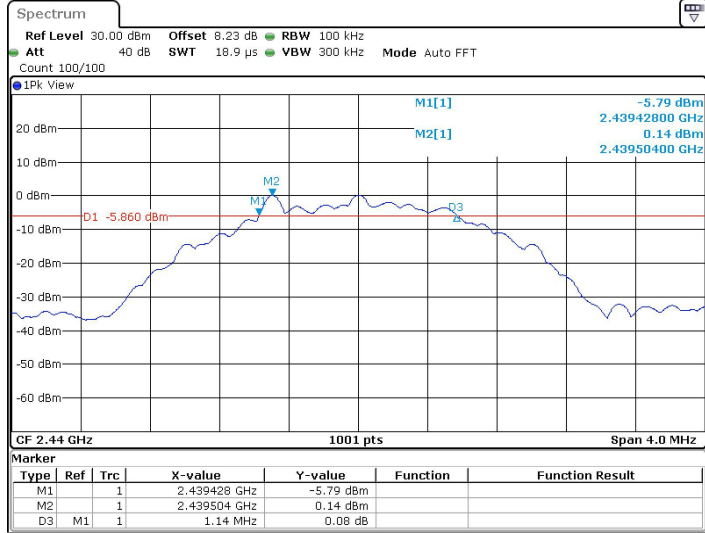

Date: 3 JUL 2023 11:58:48

BLE 2M Ant1 2480

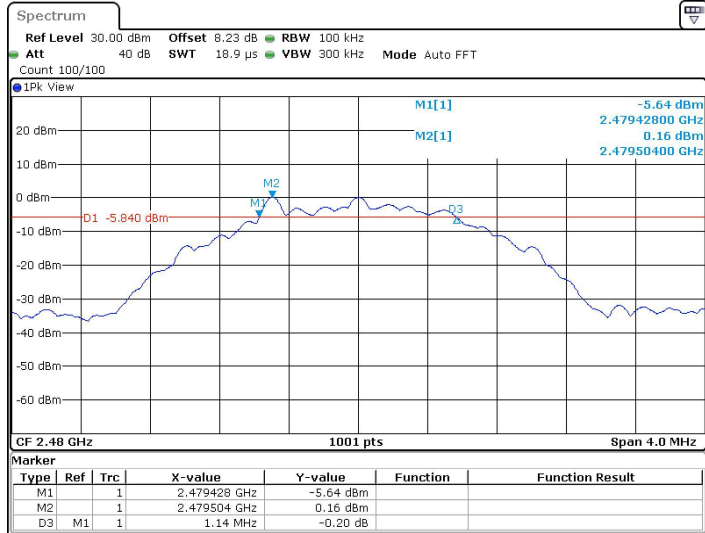

Date: 3 JUL 2023 12:01:18

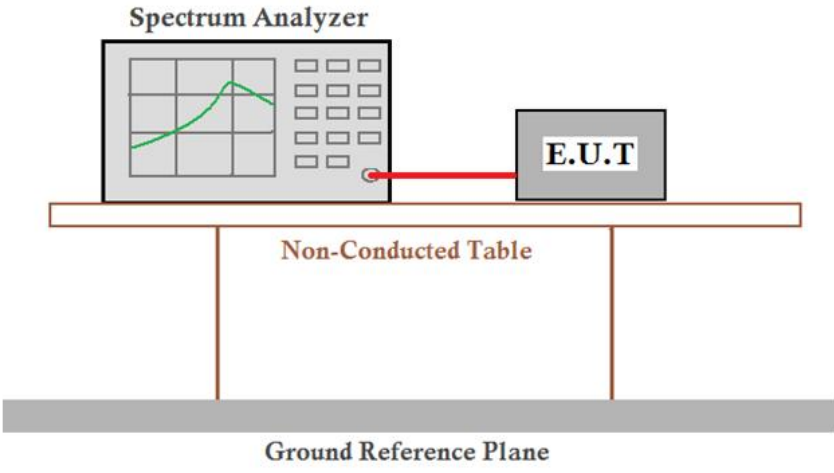

## 5.5 Power Spectral Density

Test Requirement:	47 CFR Part 15C Section 15.247 (e)
Test Method:	ANSI C63.10 2013
Test Setup:	 <p style="text-align: center;"><i>Remark: Offset=Cable loss+ attenuation factor.</i></p>
Limit:	≤8.00dBm/3kHz
Test Mode:	Transmitting with GFSK modulation.
Test Results:	Pass

### Measurement Data

GFSK mode (1Mbps)			
Test channel	Power Spectral Density (dBm/3kHz)	Limit (dBm/3kHz)	Result
Lowest	-15.31	≤8.00	Pass
Middle	-14.42	≤8.00	Pass
Highest	-14.55	≤8.00	Pass
GFSK mode (2Mbps)			
Test channel	Power Spectral Density (dBm/3kHz)	Limit (dBm/3kHz)	Result
Lowest	-18.76	≤8.00	Pass
Middle	-17.82	≤8.00	Pass
Highest	-18.02	≤8.00	Pass

Test plot as follows:

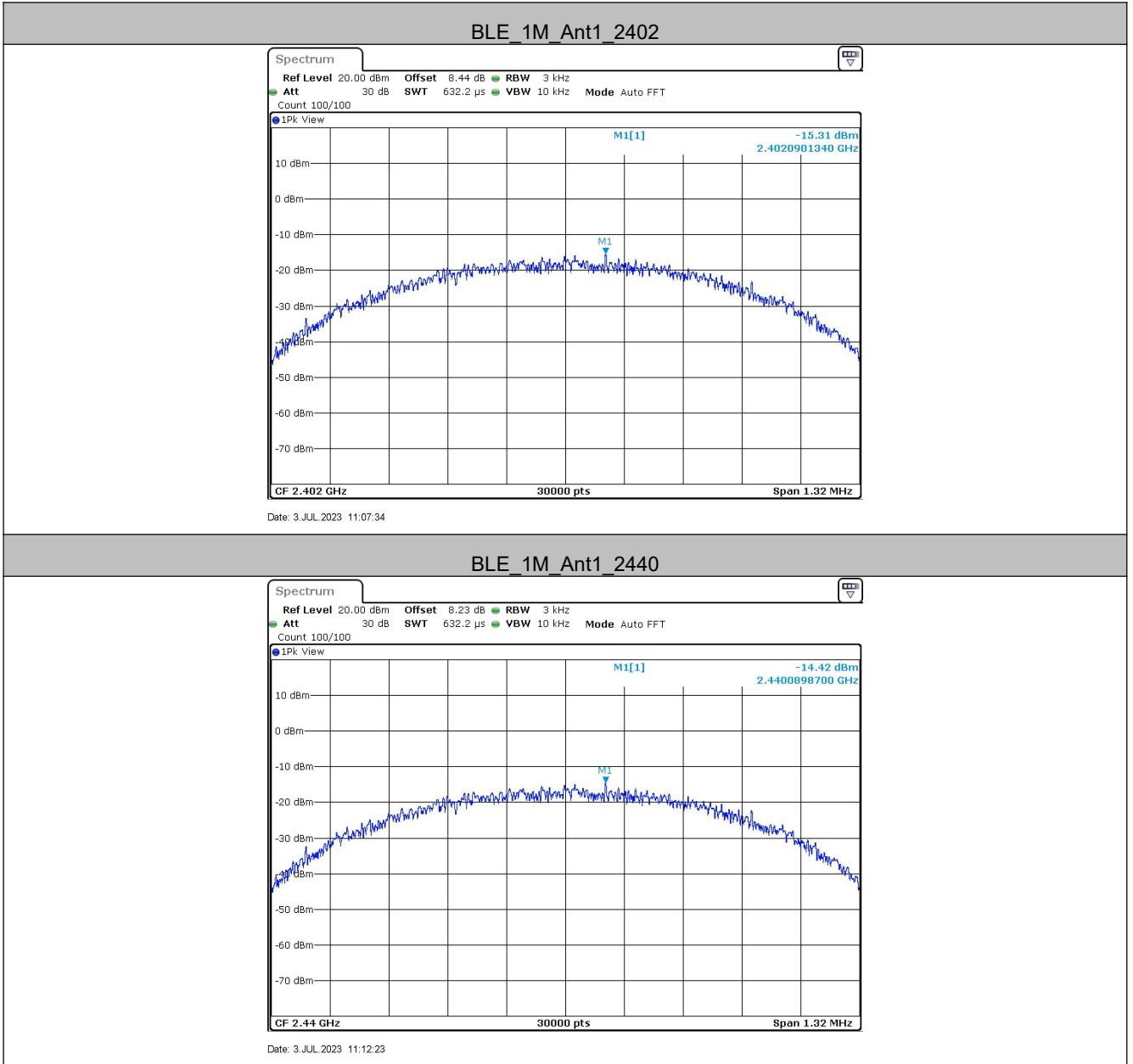

BLE 1M Ant1 2480

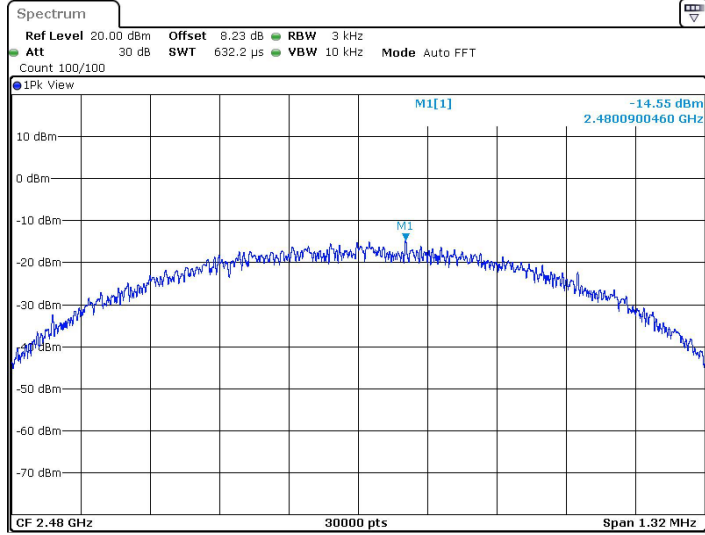

Date: 3 JUL 2023 11:52:16

BLE 2M Ant1 2402

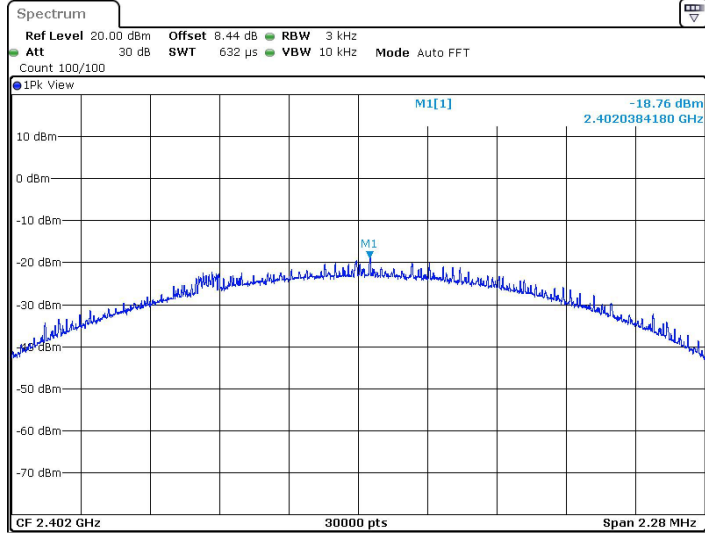

Date: 3 JUL 2023 11:55:29

BLE 2M Ant1 2440

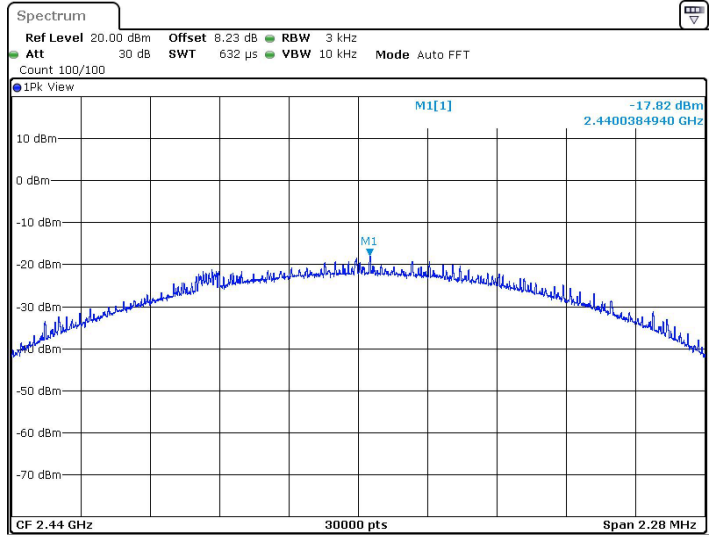

Date: 3 JUL 2023 11:59:09

BLE 2M Ant1 2480

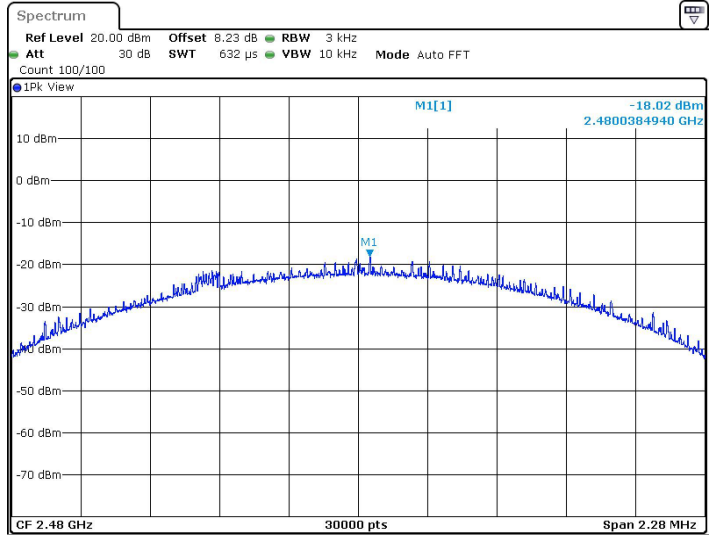

Date: 3 JUL 2023 12:01:39

## 5.6 Band-edge for RF Conducted Emissions

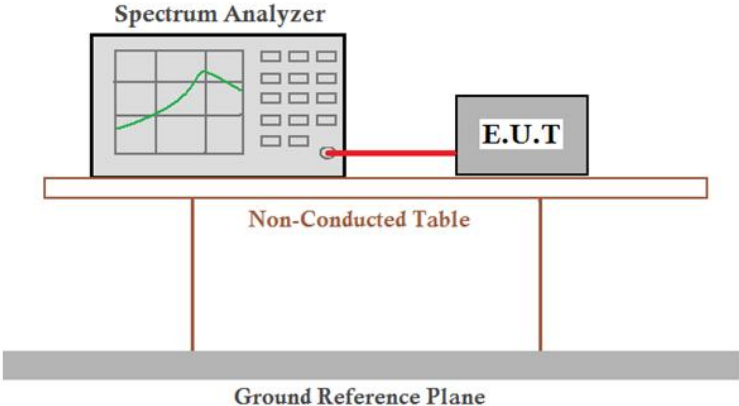
Test Requirement:	47 CFR Part 15C Section 15.247 (d)
Test Method:	ANSI C63.10 2013
Test Setup:	 <p>Remark: <math>Offset = \text{Cable loss} + \text{attenuation factor}</math>.</p>
Limit:	In any 100 kHz bandwidth outside the frequency band in which the spread spectrum intentional radiator is operating, the radio frequency power that is produced by the intentional radiator shall be at least 20 dB below that in the 100 kHz bandwidth within the band that contains the highest level of the desired power, based on either an RF conducted or a radiated measurement. If the transmitter complies with the conducted power limits based on the use of RMS averaging over a time interval, as permitted under paragraph (b)(3) of this section, the attenuation required under this paragraph shall be 30 dB instead of 20 dB.
Test Mode:	Transmitting with GFSK modulation.
Test Results:	Pass

TestMode	ChName	Freq(MHz)	RefLevel[dBm]	Result[dBm]	Limit[dBm]	Verdict
BLE_1M	Low	2402	0.04	-50.24	$\leq -19.96$	PASS
	High	2480	1.00	-49.22	$\leq -19$	PASS
BLE_2M	Low	2402	-0.66	-37.57	$\leq -20.66$	PASS
	High	2480	0.19	-49.18	$\leq -19.81$	PASS

Test plot as follows:

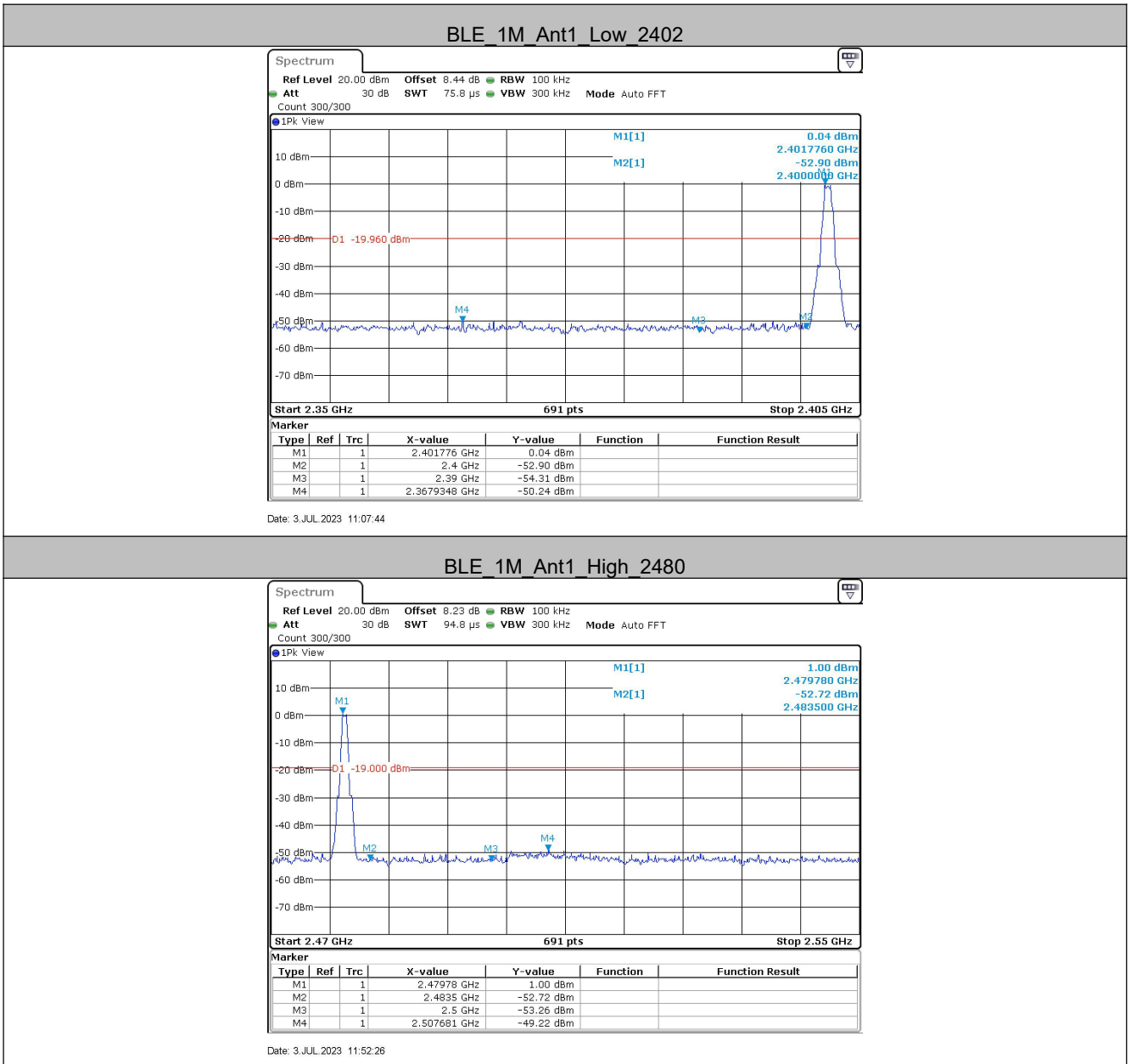

BLE 2M Ant1 Low 2402

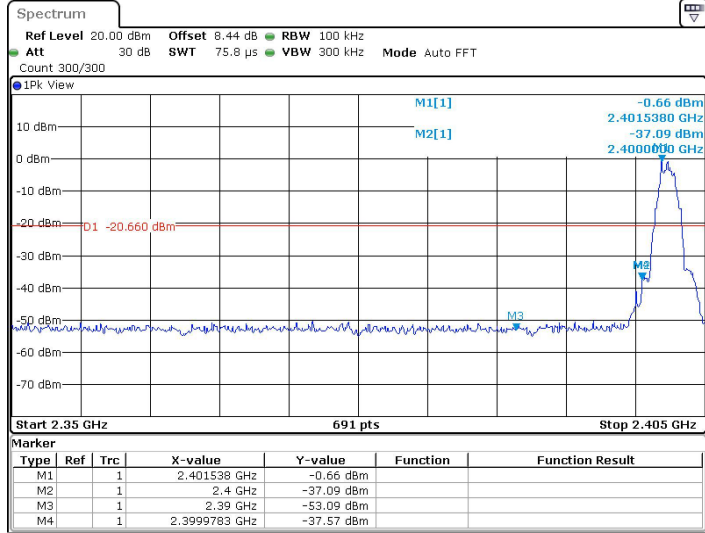

Date: 3 JUL 2023 11:55:39

BLE 2M Ant1 High 2480

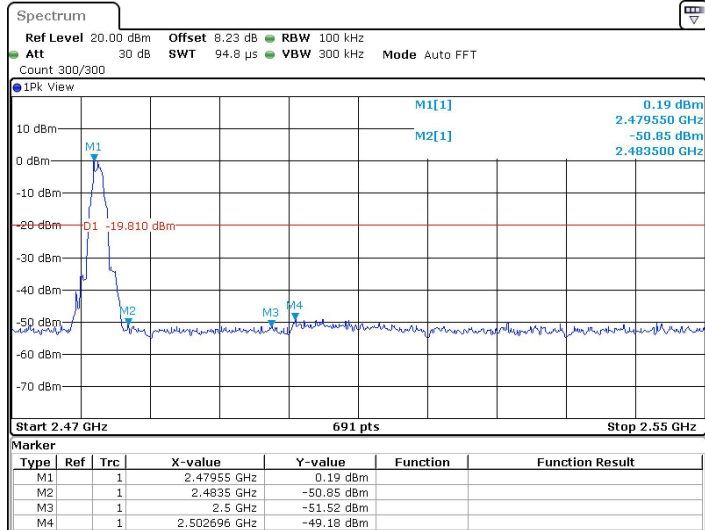

Date: 3 JUL 2023 12:01:49

## 5.7 Spurious RF Conducted Emissions

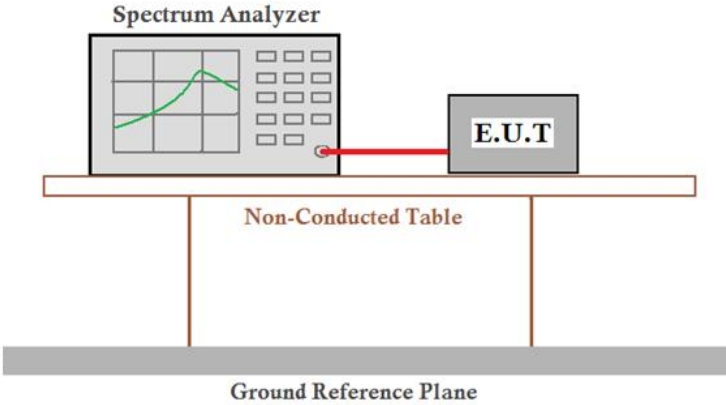
Test Requirement:	47 CFR Part 15C Section 15.247 (d)
Test Method:	ANSI C63.10 2013
Test Setup:	 <p style="text-align: center;"><i>Remark: Offset=Cable loss+ attenuation factor.</i></p>
Limit:	In any 100 kHz bandwidth outside the frequency band in which the spread spectrum intentional radiator is operating, the radio frequency power that is produced by the intentional radiator shall be at least 20 dB below that in the 100 kHz bandwidth within the band that contains the highest level of the desired power, based on either an RF conducted or a radiated measurement.
Test Mode:	Transmitting with GFSK modulation.
Test Results:	Pass



Test plot as follows:

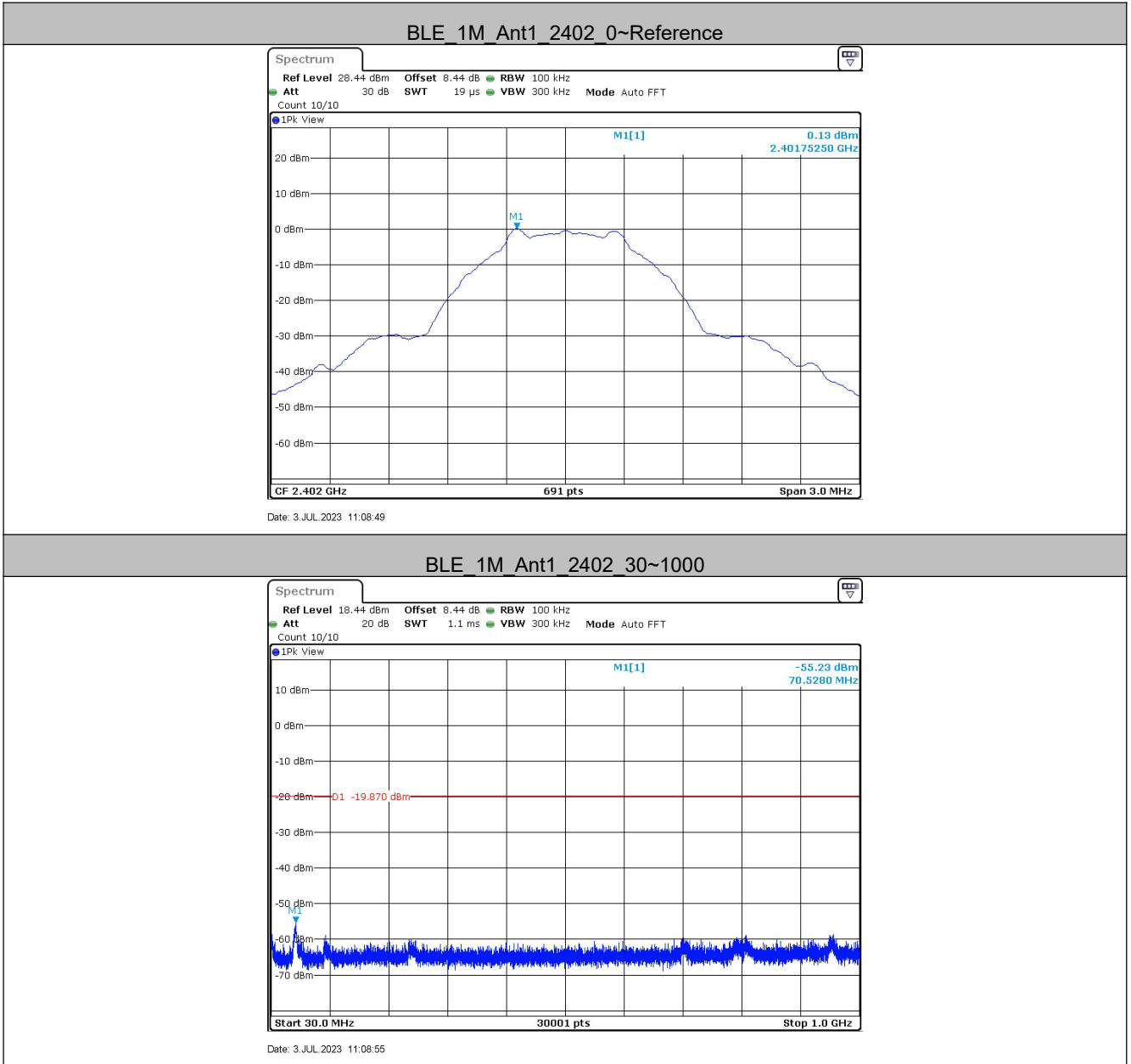

BLE 1M Ant1 2402 1000~26500

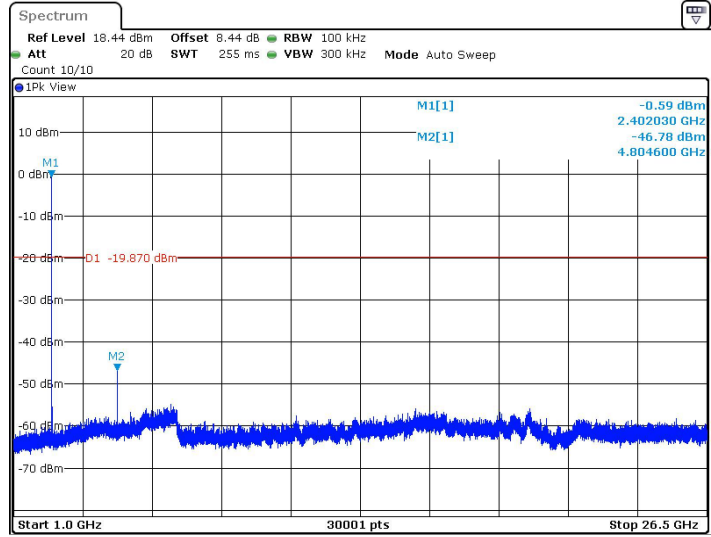

Date: 3 JUL 2023 11:09:17

BLE 1M Ant1 2440 0~Reference

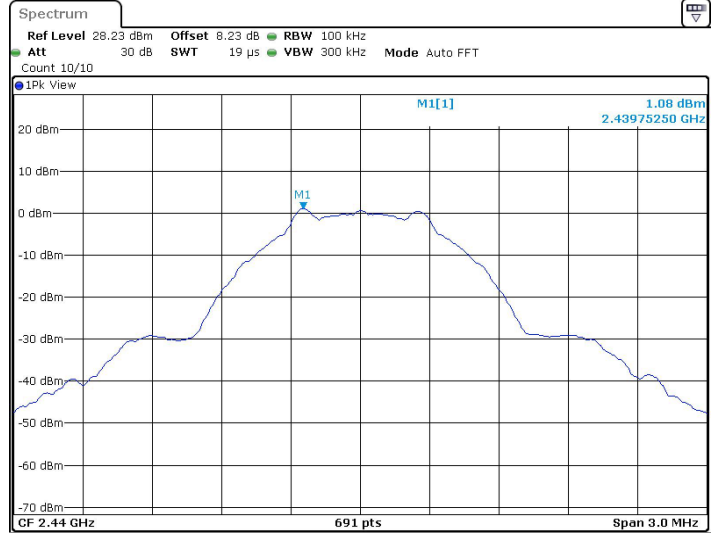

Date: 3 JUL 2023 11:12:31

BLE 1M Ant1\_2440 30~1000

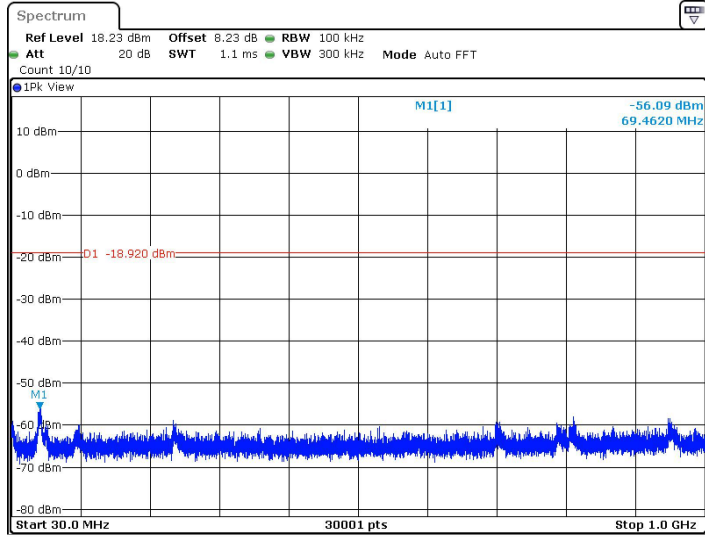

Date: 3 JUL 2023 11:12:38

BLE 1M Ant1\_2440 1000~26500

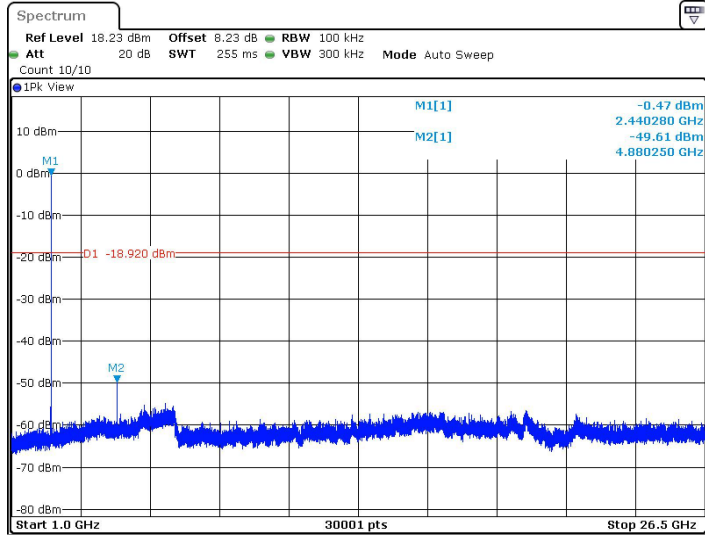

Date: 3 JUL 2023 11:13:00