

Tested Products.

- Antenna 1: integrated antenna.
- Frequency = 2.402GHz.
- Frequency = 2.441GHz.
- Frequency = 2.480GHz.

Antenna Layout

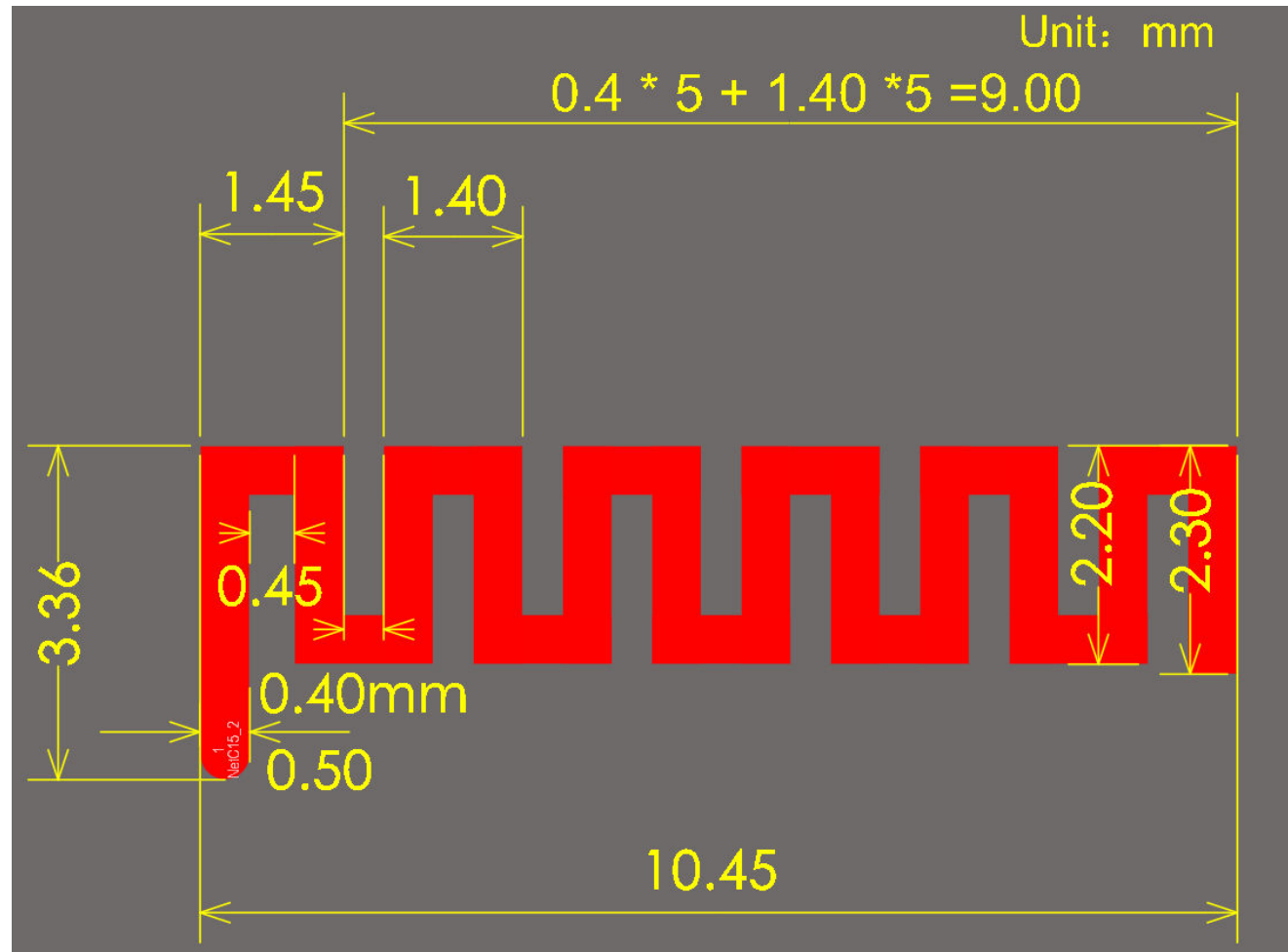

Coordinate System Reference: Antenna 1.

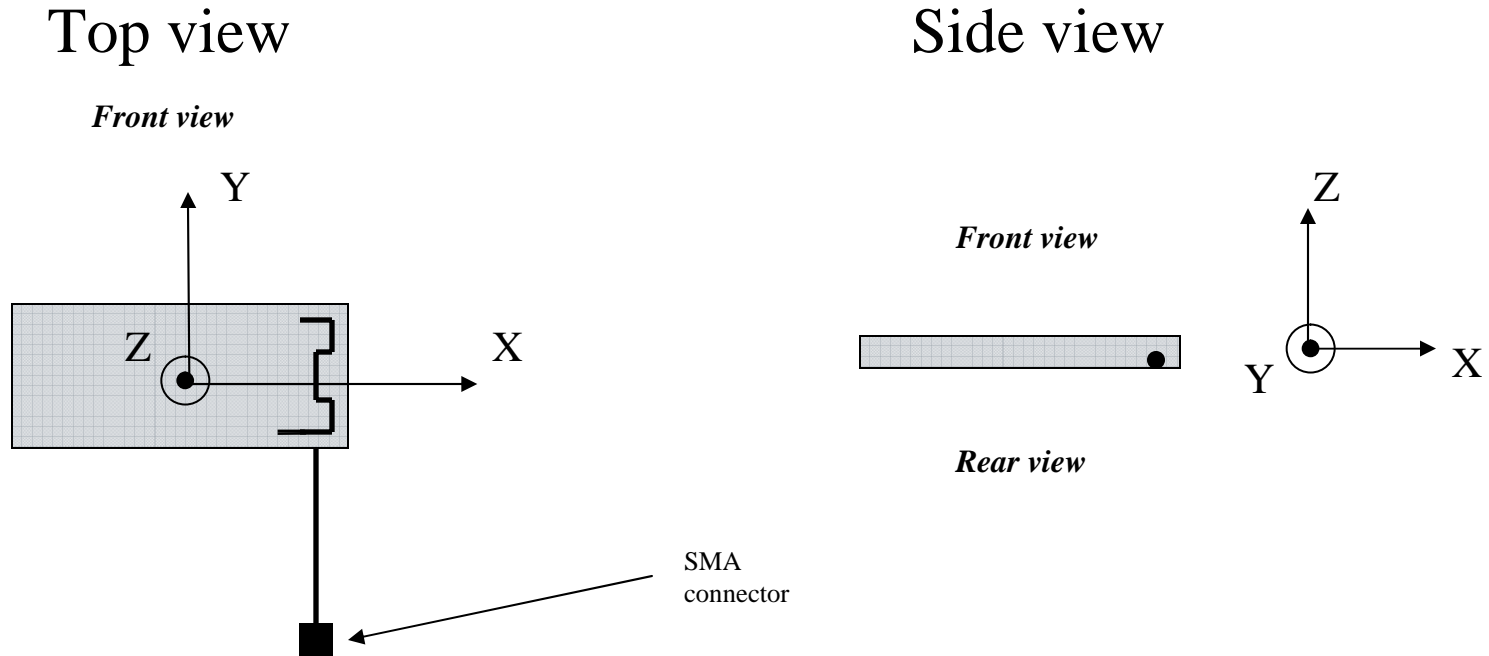

Radiation pattern: Antenna 1. XZ Plane at $f = 2.402\text{GHz}$

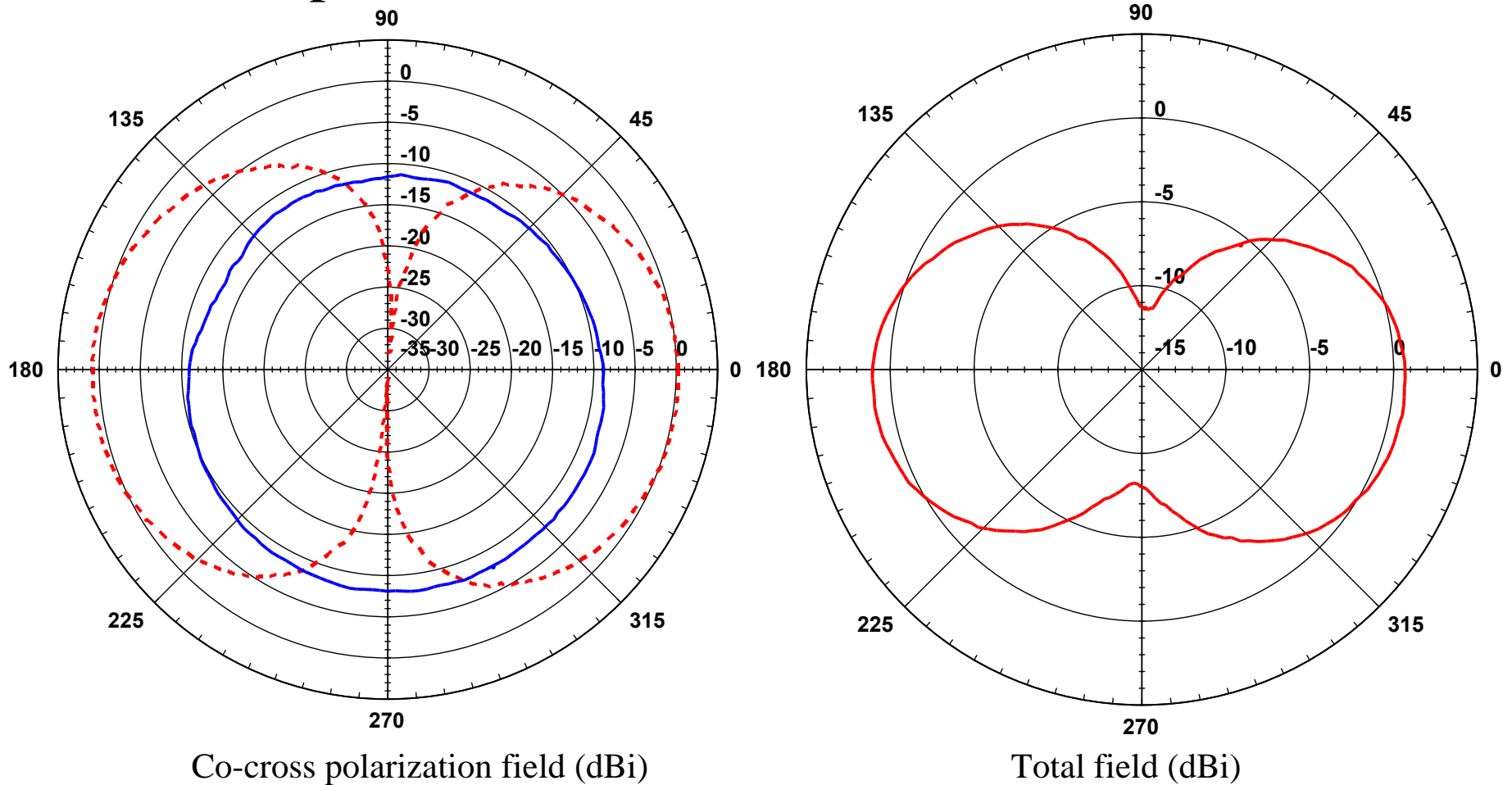

Solid line: vertical polarization
Dash line: horizontal polarization

Radiation pattern: Antenna 1. YZ Plane at $f = 2.402\text{GHz}$

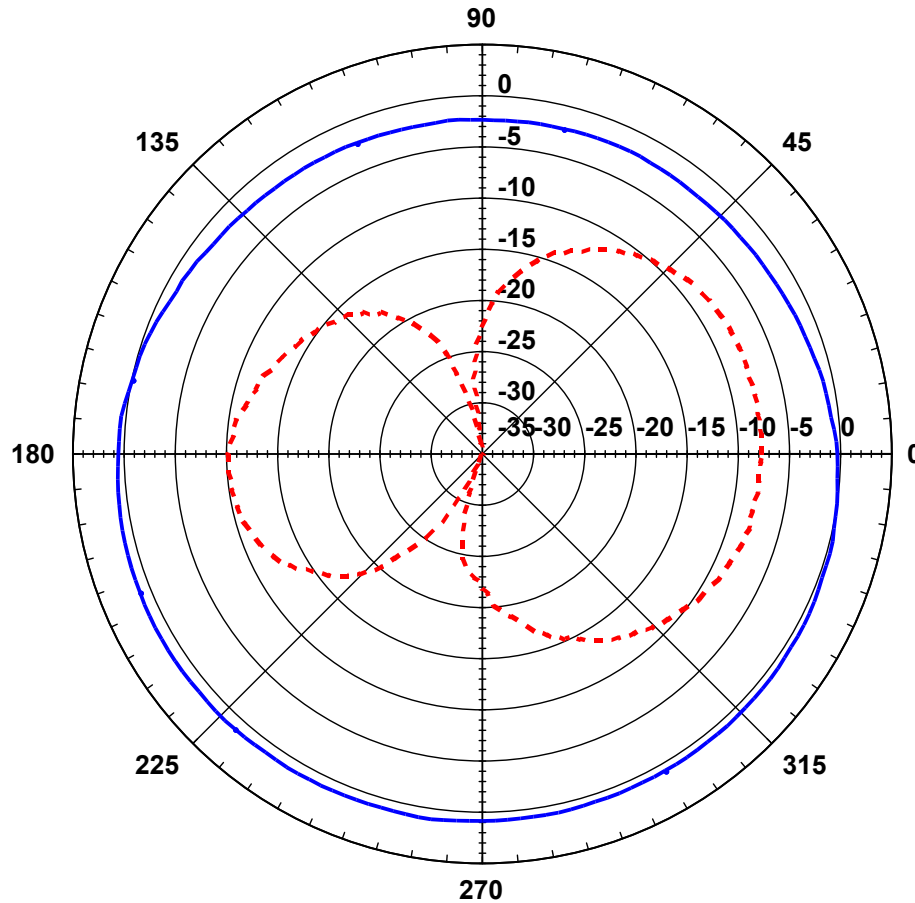

Co-cross polarization field (dBi)

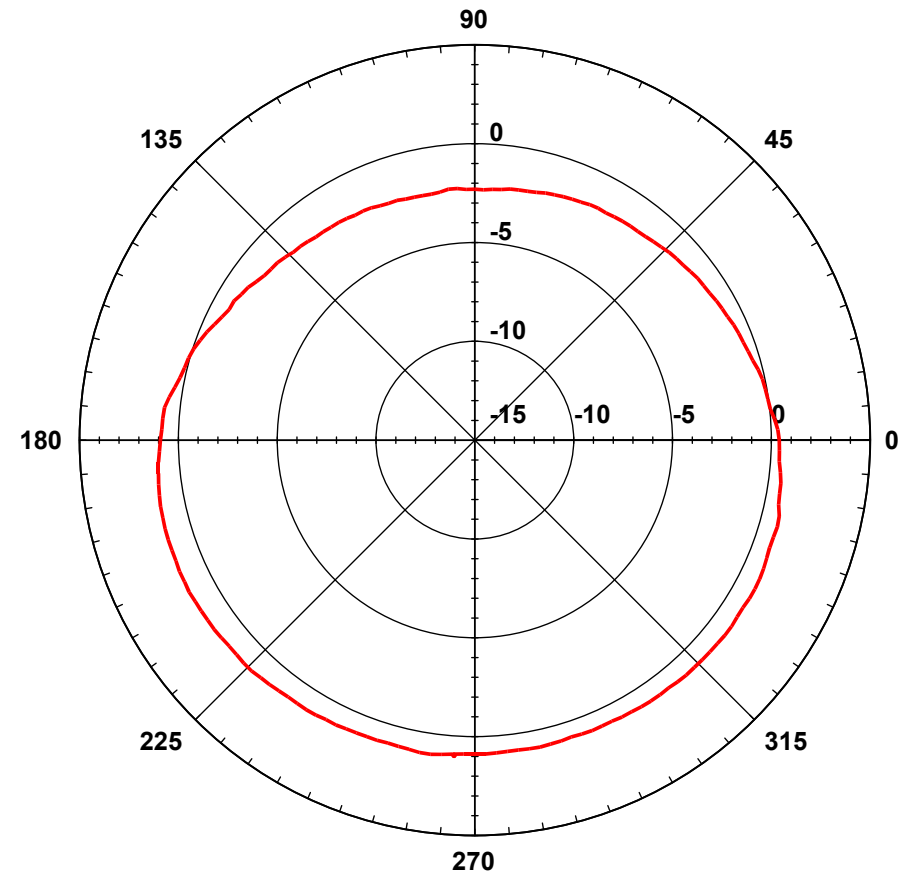

Total field (dBi)

Solid line: vertical polarization
Dash line: horizontal polarization

Radiation pattern: Antenna 1. XY Plane at $f = 2.402\text{GHz}$

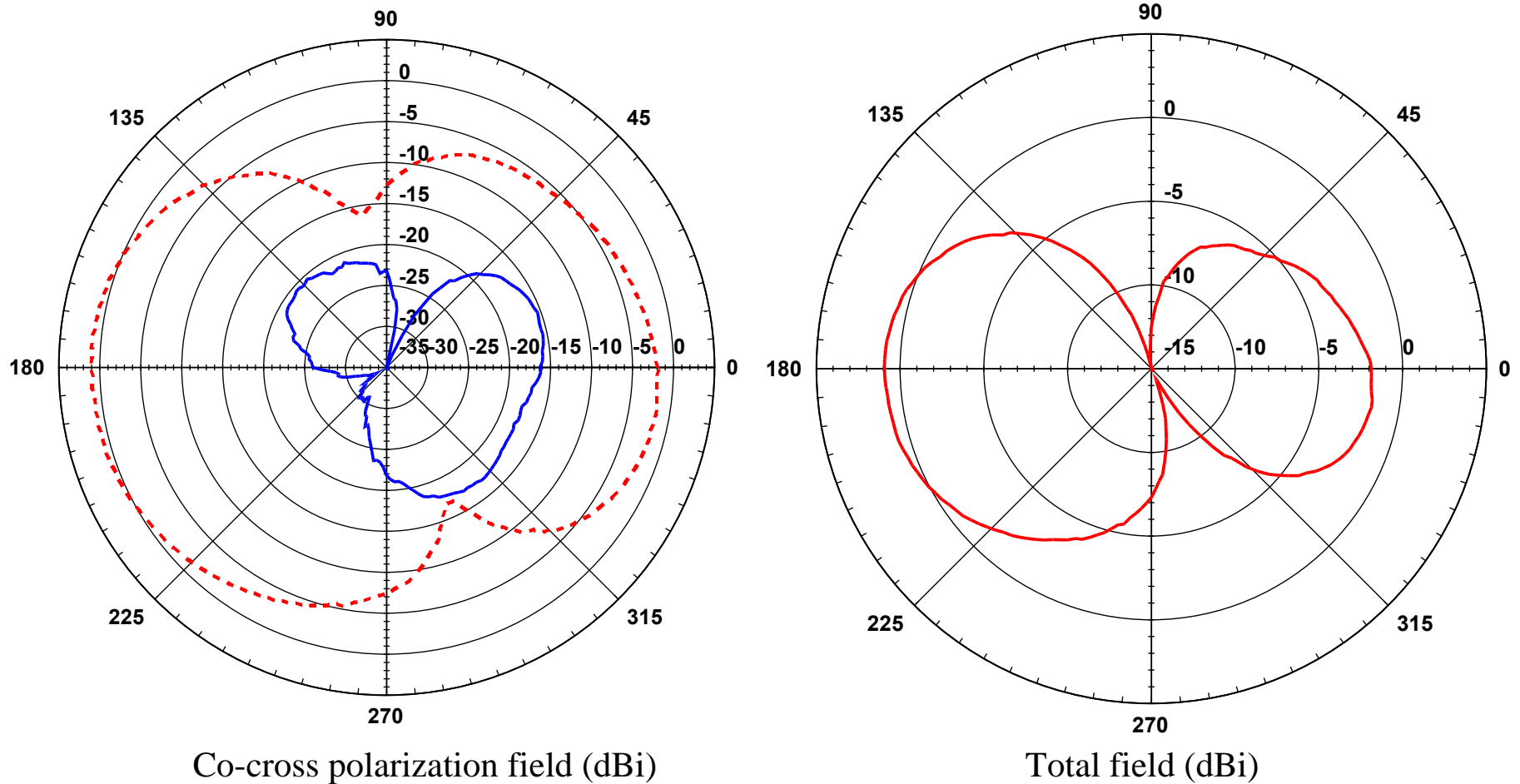

Solid line: vertical polarization
Dash line: horizontal polarization

Radiation pattern: Antenna 1. XZ Plane at $f = 2.441\text{GHz}$

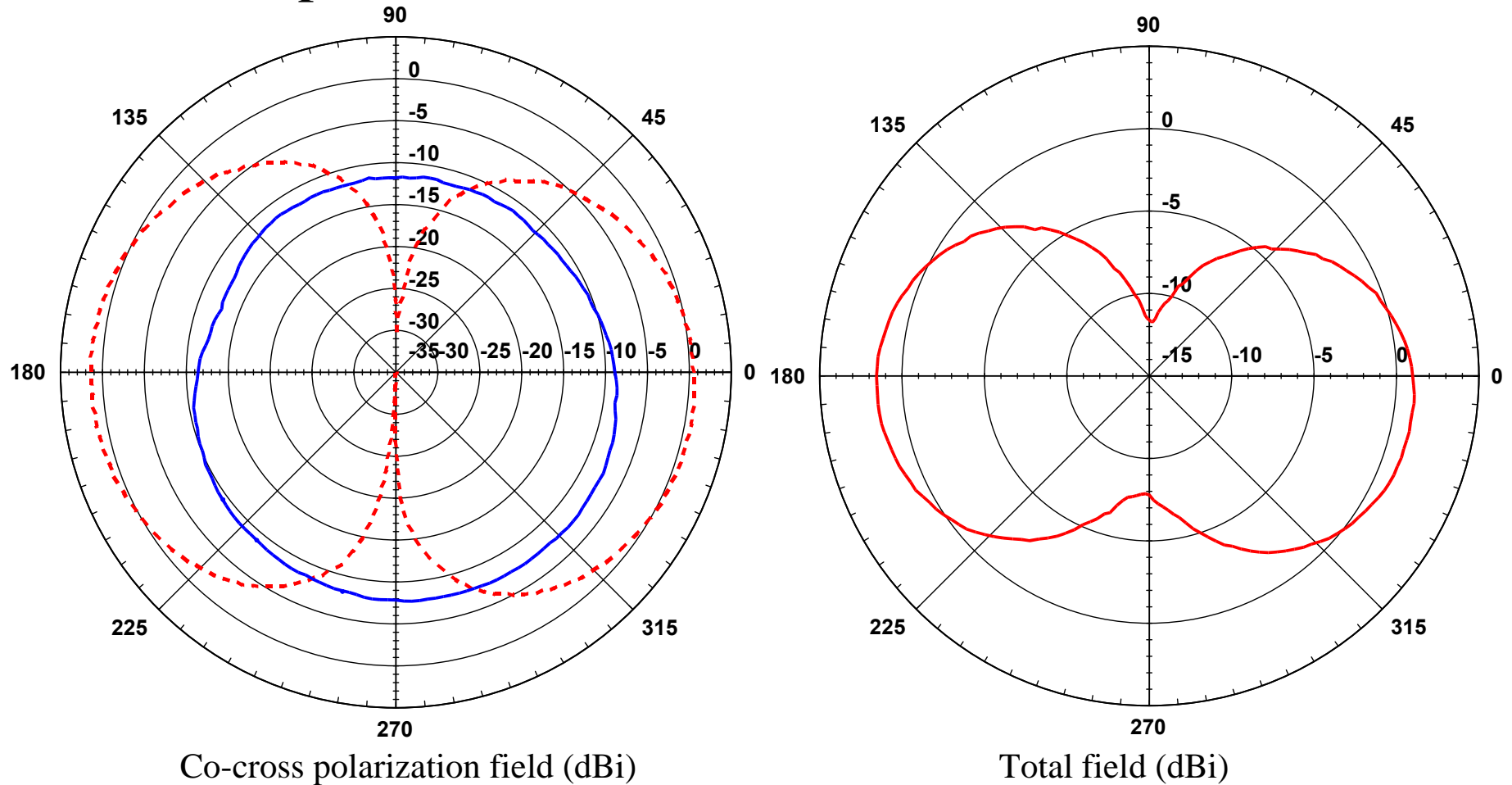

Solid line: vertical polarization
Dash line: horizontal polarization

Radiation pattern: Antenna 1. YZ Plane at $f = 2.441\text{GHz}$

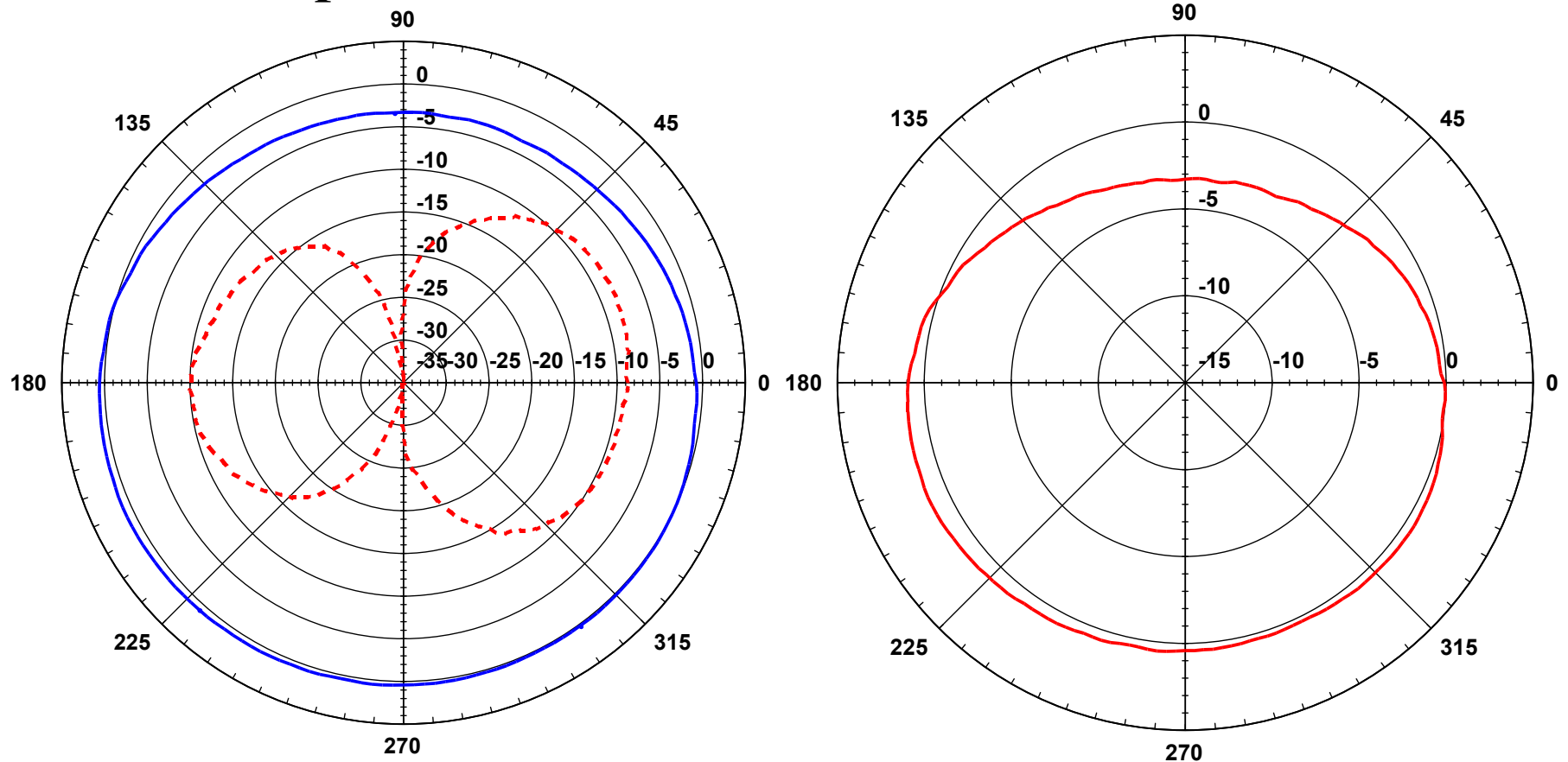

Co-cross polarization field (dBi)

Total field (dBi)

Solid line: vertical polarization
Dash line: horizontal polarization

Radiation pattern: Antenna 1. XY Plane at $f = 2.441\text{GHz}$

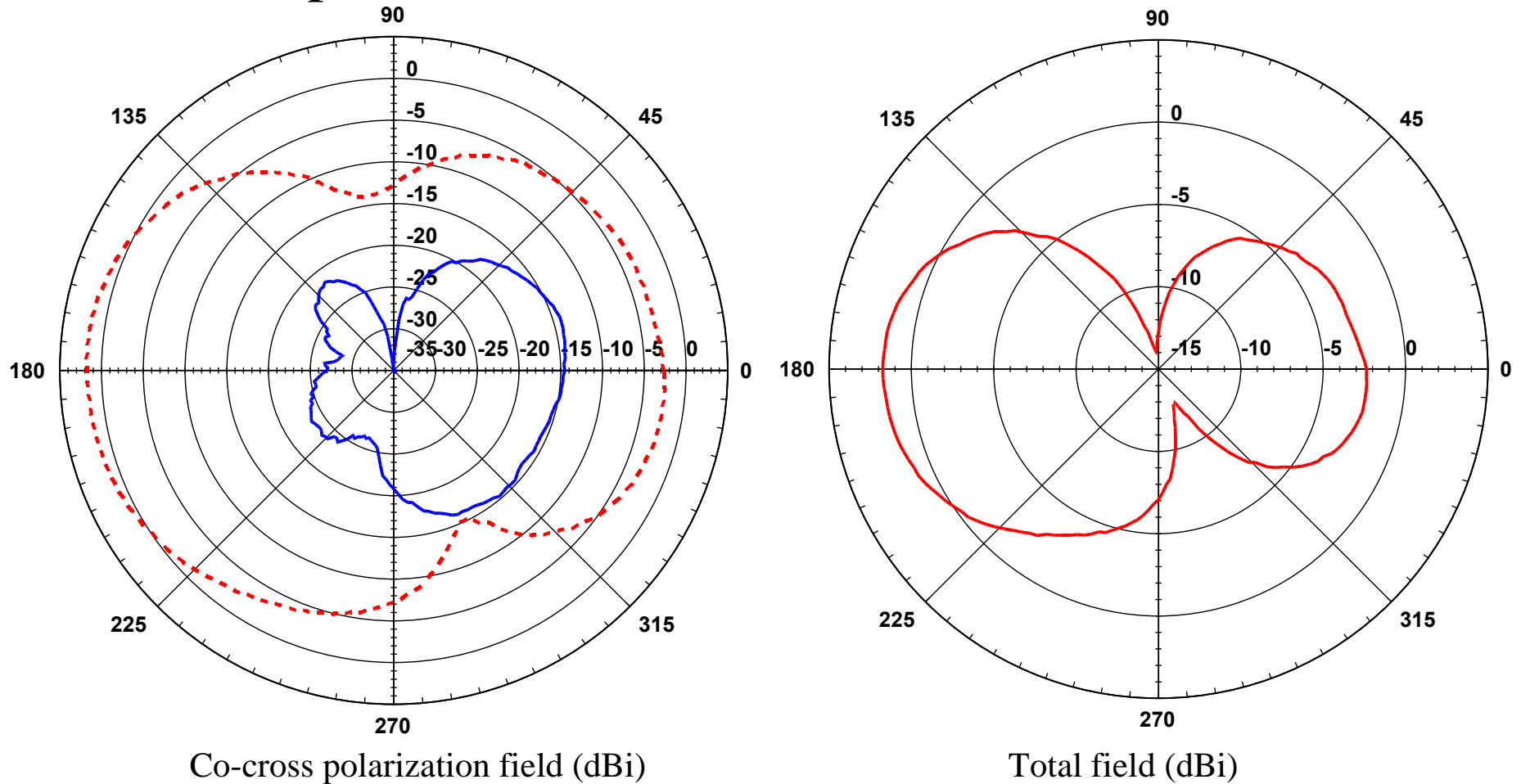

Solid line: vertical polarization
Dash line: horizontal polarization

Radiation pattern: Antenna 1. XZ Plane at $f = 2.480\text{GHz}$

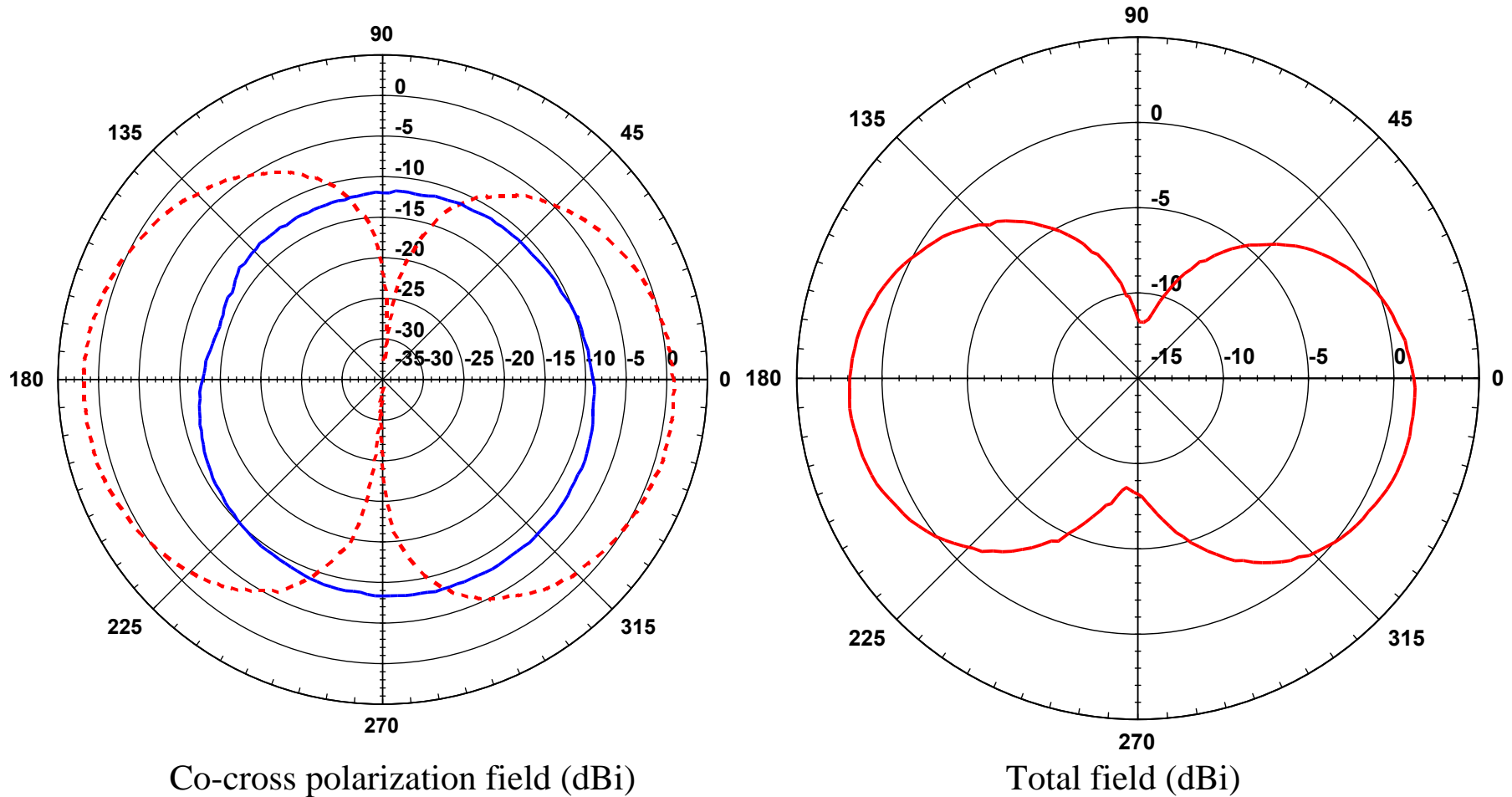

Solid line: vertical polarization
Dash line: horizontal polarization

Radiation pattern: Antenna 1. YZ Plane at $f = 2.480\text{GHz}$

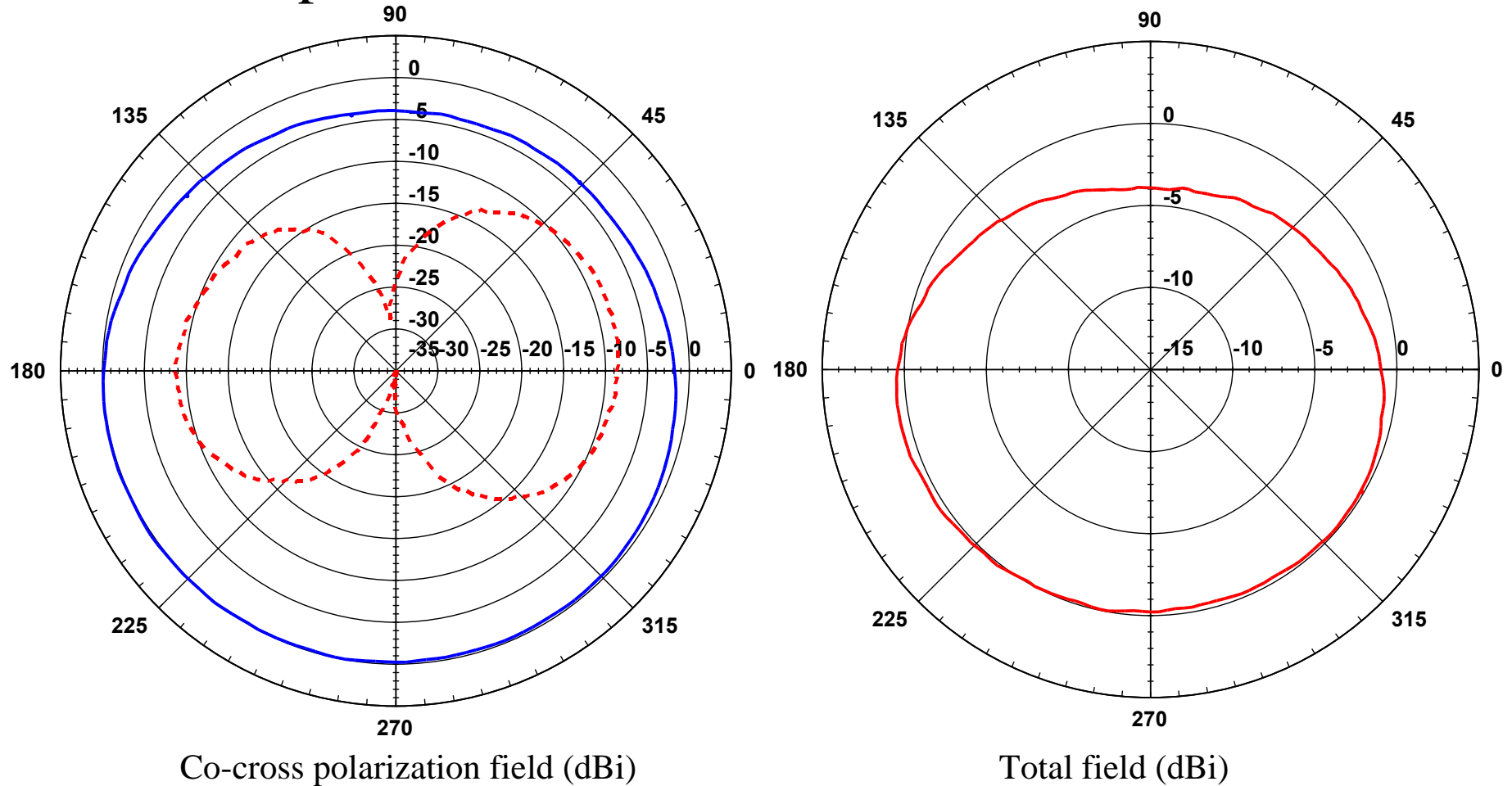

Solid line: vertical polarization
Dash line: horizontal polarization

Radiation pattern: Antenna 1. XY Plane at $f = 2.480\text{GHz}$

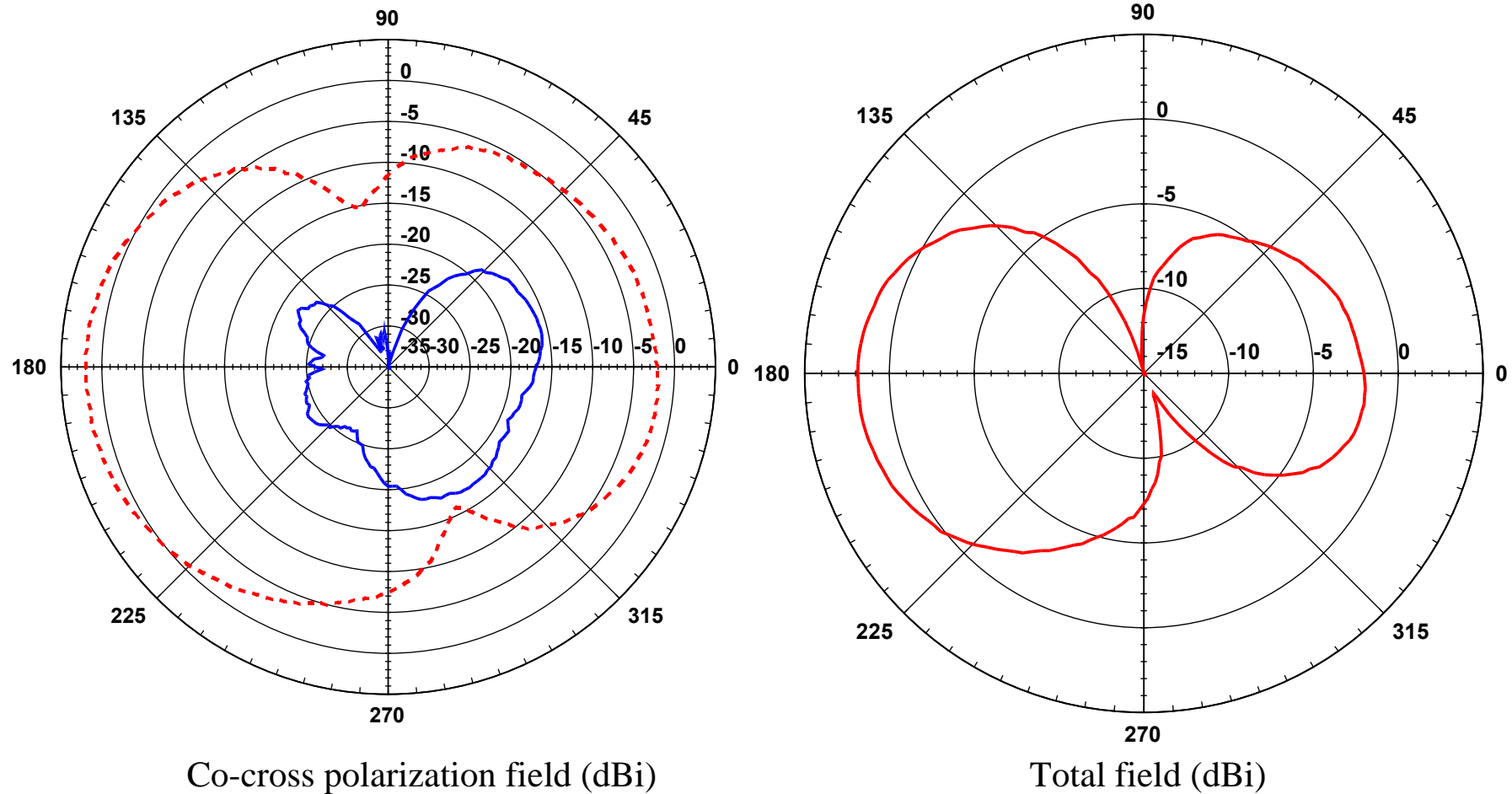

Solid line: vertical polarization
Dash line: horizontal polarization

Return Loss: Antenna 1

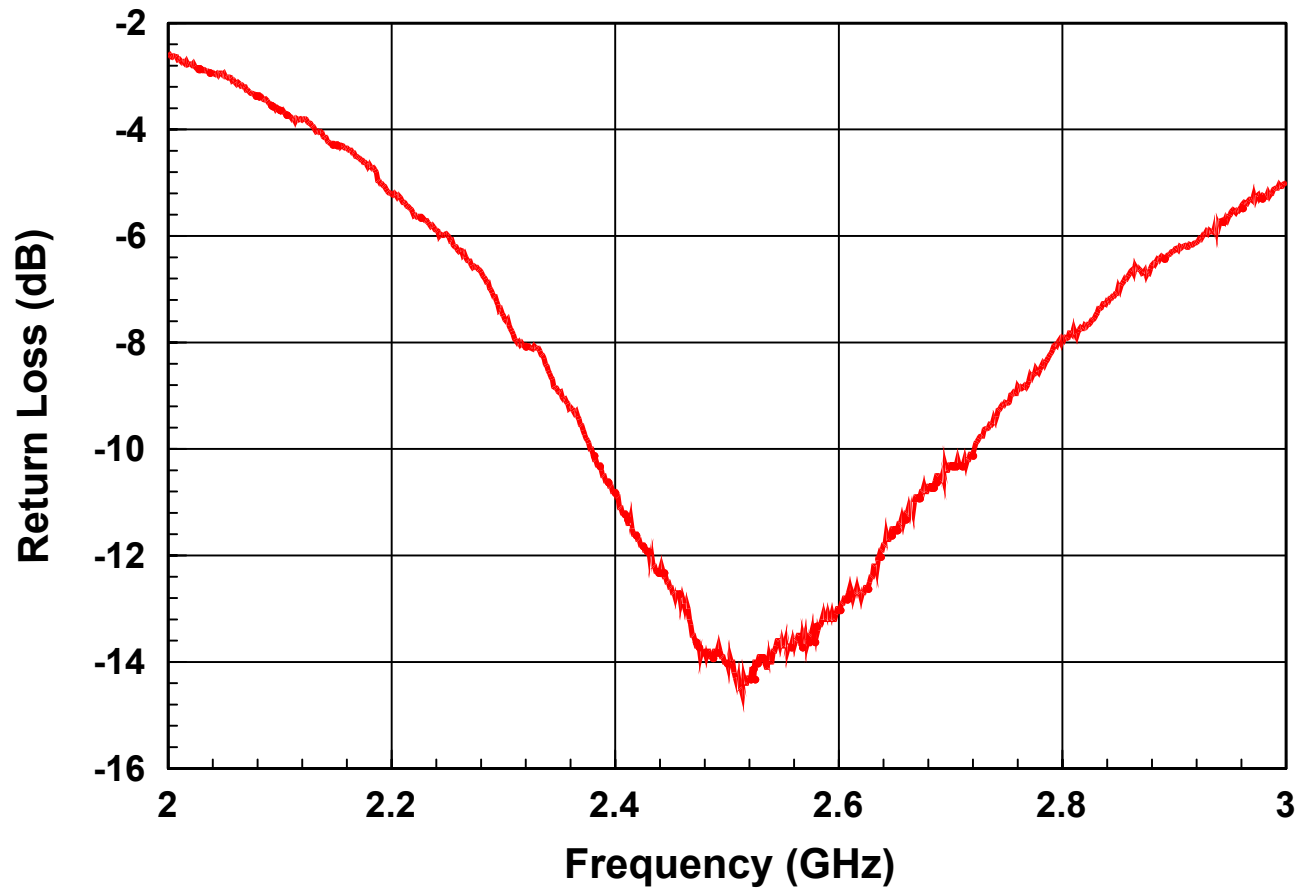

BW(-10dB) 🕒 13.48%

Measurements summary

	Frequency (GHz)	Plane	Return Loss (dB)	Polarization	Gain max. (dBi)	θ for Gain max.	ϕ for Gain max.
Antenna 1							
	2.402	XZ	-10.90	Vertical	-7.8	290	
	2.402	XZ	-10.90	Horizontal	0.786	182	
	2.402	YZ	-10.90	Vertical	1.21	226	
	2.402	YZ	-10.90	Horizontal	-7.75	10	
	2.402	XY	-10.90	Vertical	-15.4		20
	2.402	XY	-10.90	Horizontal	0.93		180
	2.441	XZ	-12.20	Vertical	-7.36	318	
	2.441	XZ	-12.20	Horizontal	1.32	180	
	2.441	YZ	-12.20	Vertical	0.981	204	
	2.441	YZ	-12.20	Horizontal	-8.23	24	
	2.441	XY	-12.20	Vertical	-14.1		-14
	2.441	XY	-12.20	Horizontal	1.74		180
	2.48	XZ	-13.80	Vertical	-7.95	312	
	2.48	XZ	-13.80	Horizontal	1.81	186	
	2.48	YZ	-13.80	Vertical	0.204	214	
	2.48	YZ	-13.80	Horizontal	-8.38	8	
	2.48	XY	-13.80	Vertical	-15.8		12
	2.48	XY	-13.80	Horizontal	1.87		180