

FCC Test Report

Report No. : 1813C50044712503

Applicant : YABER TECHNOLOGIES CO.,LIMITED

Address : Room 406,4 Floor,B Building,BanTian
International Center,HuanCheng South
Road,BanTian Street, LongGang
District,Shenzhen, 518000, China

Product Name : Projector

Report Date : Mar. 28, 2025

Shenzhen Anbotek Compliance Laboratory Limited

Shenzhen Anbotek Compliance Laboratory Limited

Address: Sogood Industrial Zone Laboratory & 1/F. of Building D, Sogood Science and Technology Park,
Sanwei Community, Hangcheng Subdistrict, Bao'an District, Shenzhen, Guangdong, China
Tel:(86)0755-26066440 Email:service@anbotek.com



Hotline
400-003-0500

www.anbotek.com



Contents

1. General Information	6
1.1. Client Information	6
1.2. Description of Device (EUT)	6
1.3. Auxiliary Equipment Used During Test.....	7
1.4. Operation channel list.....	7
1.5. Description of Test Modes.....	7
1.6. Measurement Uncertainty	8
1.7. Test Summary	8
1.8. Description of Test Facility	9
1.9. Disclaimer.....	9
1.10. Test Equipment List.....	10
2. Antenna requirement	12
2.1. Conclusion.....	12
3. Conducted Emission at AC power line	13
3.1. EUT Operation	13
3.2. Test Setup	13
3.3. Test Data	14
4. 6dB Bandwidth	16
4.1. EUT Operation	16
4.2. Test Setup	17
4.3. Test Data	17
5. Maximum Conducted Output Power.....	18
5.1. EUT Operation	18
5.2. Test Setup	18
5.3. Test Data	18
6. Power Spectral Density	19
6.1. EUT Operation	19
6.2. Test Setup	19
6.3. Test Data	19
7. Emissions in non-restricted frequency bands.....	20
7.1. EUT Operation	20
7.2. Test Setup	20
7.3. Test Data	20
8. Band edge emissions (Radiated)	21
8.1. EUT Operation	21
8.2. Test Setup	22
8.3. Test Data	23
9. Emissions in frequency bands (below 1GHz).....	29
9.1. EUT Operation	29
9.2. Test Setup	30
9.3. Test Data	31
10. Emissions in frequency bands (above 1GHz)	33

10.1. EUT Operation33
10.2. Test Setup34
10.3. Test Data35
APPENDIX I -- TEST SETUP PHOTOGRAPH38
APPENDIX II -- EXTERNAL PHOTOGRAPH38
APPENDIX III -- INTERNAL PHOTOGRAPH.....38

Shenzhen Anbotek Compliance Laboratory Limited

Address: Sogood Industrial Zone Laboratory & 1/F. of Building D, Sogood Science and Technology Park,
Sanwei Community, Hangcheng Subdistrict, Bao'an District, Shenzhen, Guangdong, China
Tel:(86)0755-26066440 Email:service@anbotek.com

 Hotline
400-003-0500
www.anbotek.com

Shenzhen Anbotek

TEST REPORT

Applicant : YABER TECHNOLOGIES CO.,LIMITED
Manufacturer : YABER TECHNOLOGIES CO.,LIMITED
Product Name : Projector
Model No. : L2 Plus, G1, G1 Pro, G1s, G2, G2 Pro, G2s, K12 Pro, K12s, K13, K13s, K13 Pro, P65, P65 Pro, P65s, A1, A1 Pro, A1s, A2, A2 Pro, A2s, A3, A3 Pro, A3s, L2, L2 Pro, L2s, L3, L3 Pro, L3s, P61 Pro, P61s, S28 Pro, S28s, X8s, X9 Pro, X10, X10 Pro, X10s, X11, X11 Pro, X11s, TP1, TP1 Pro, TP1s, TP2, TP2 Pro, TP2s, A1, A1 Pro, A1s, A2, A2 Pro, A2s, A3, A3 Pro, A3s
Trade Mark : Yaber
Rating(s) : Input: 100-240V~, 50/60Hz, 110W

Test Standard(s) : **47 CFR Part 15.247**
ANSI C63.10-2020
KDB 558074 D01 15.247 Meas Guidance v05r02
KDB 662911 D01 Multiple Transmitter Output v02r01

The device described above is tested by Shenzhen Anbotek Compliance Laboratory Limited to determine the maximum emission levels emanating from the device and the severe levels of the device can endure and its performance criterion. The measurement results are contained in this test report and Shenzhen Anbotek Compliance Laboratory Limited is assumed full of responsibility for the accuracy and completeness of these measurements. Also, this report shows that the EUT (Equipment Under Test) is technically compliant with above listed standard(s) requirements.

This report applies to above tested sample only and shall not be reproduced in part without written approval of Shenzhen Anbotek Compliance Laboratory Limited.

Date of Receipt: Feb. 12, 2025

Date of Test: Feb. 12, 2025 to Mar. 28, 2025

Prepared By: Lene Chen
(Lene Chen)

Approved & Authorized Signer: Hugo Chen
(Hugo Chen)

Shenzhen Anbotek Compliance Laboratory Limited

Revision History

Report Version	Description	Issued Date
R00	Original Issue.	Mar. 28, 2025

Shenzhen Anbotek Compliance Laboratory Limited

1. General Information

1.1. Client Information

Applicant	:	YABER TECHNOLOGIES CO.,LIMITED
Address	:	Room 406,4 Floor,B Building,BanTian International Center,HuanCheng South Road,BanTian Street, LongGang District,Shenzhen, 518000, China
Manufacturer	:	YABER TECHNOLOGIES CO.,LIMITED
Address	:	Room 406,4 Floor,B Building,BanTian International Center,HuanCheng South Road,BanTian Street, LongGang District,Shenzhen, 518000, China
Factory	:	YABER TECHNOLOGIES CO.,LIMITED
Address	:	Room 406,4 Floor,B Building,BanTian International Center,HuanCheng South Road,BanTian Street, LongGang District,Shenzhen, 518000, China

1.2. Description of Device (EUT)

Product Name	:	Projector
Model No.	:	L2 Plus, G1, G1 Pro, G1s, G2, G2 Pro, G2s, K12 Pro, K12s, K13, K13s, K13 Pro, P65, P65 Pro, P65s, A1, A1 Pro, A1s, A2, A2 Pro, A2s, A3, A3 Pro, A3s, L2, L2 Pro, L2s, L3, L3 Pro, L3s, P61 Pro, P61s, S28 Pro, S28s, X8s, X9 Pro, X10, X10 Pro, X10s, X11, X11 Pro, X11s, TP1, TP1 Pro, TP1s, TP2, TP2 Pro, TP2s, A1, A1 Pro, A1s, A2, A2 Pro, A2s, A3, A3 Pro, A3s (Note: All samples are the same except the model name, so we prepare "L2 Plus" for test only.)
Trade Mark	:	Yaber
Test Power Supply	:	AC 120V/60Hz
Test Sample No.	:	1-2-1(Normal Sample), 1-2-2(Engineering Sample)
Adapter	:	N/A
RF Specification		
Operation Frequency	:	802.11b/g/n(HT20)/ax(HEW20): 2412MHz to 2462MHz; 802.11n(HT40)/ax(HEW40): 2422MHz to 2452MHz
Number of Channel	:	802.11b/g/n(HT20)/ax(HEW20): 11 Channels; 802.11n(HT40)/ax(HEW40): 7 Channels
Modulation Type	:	802.11b: DSSS(CCK, DQPSK, DBPSK); 802.11g: OFDM(BPSK, QPSK, 16QAM, 64QAM); 802.11n(HT20 and HT40): OFDM (BPSK, QPSK, 16QAM, 64QAM) 802.11ax(HEW20 and HEW40): OFDMA(BPSK, QPSK, 16QAM, 64QAM, 256QAM, 1024QAM)
Antenna Type	:	ANT1: FPC Antenna ANT2: FPC Antenna
Antenna Gain(Peak)	:	ANT1: 3.34dBi ANT2: 5.68dBi
Directional antenna gain	:	7.68dBi
<p>Remark: (1) All of the RF specification are provided by customer. (2) For a more detailed features description, please refer to the manufacturer's specifications or the User's Manual. (3) Only 802.11n and 802.11ax mode support MIMO. (4) Directional antenna gain=$10 \cdot \log_{10}(10^{ANT1/10} + 10^{ANT2/10})$</p>		

1.3. Auxiliary Equipment Used During Test

Title	Manufacturer	Model No.	Serial No.
/	/	/	/

1.4. Operation channel list

Operation Band:

Channel	Frequency (MHz)	Channel	Frequency (MHz)	Channel	Frequency (MHz)
1	2412	5	2432	9	2452
2	2417	6	2437	10	2457
3	2422	7	2442	11	2462
4	2427	8	2447	/	/

1.5. Description of Test Modes

Pretest Modes	Descriptions
TM1	Keep the EUT in 802.11b transmitting mode.
TM2	Keep the EUT in 802.11g transmitting mode.
TM3	Keep the EUT in 802.11n(HT20) transmitting mode.
TM4	Keep the EUT in 802.11n(HT40) transmitting mode.
TM5	Keep the EUT in 802.11ax(HEW20) transmitting mode.
TM6	Keep the EUT in 802.11ax(HEW40) transmitting mode.

Note: 802.11ax mode only support full resource unit size.

1.6. Measurement Uncertainty

Parameter	Uncertainty
Conducted emissions (AMN 150kHz~30MHz)	3.2dB
Occupied Bandwidth	925Hz
Conducted Output Power	0.76dB
Power Spectral Density	0.76dB
Conducted Spurious Emission	1.24dB
Radiated spurious emissions (above 1GHz)	1G-6GHz: 4.64dB; 6G-18GHz: 4.82dB 18G-40GHz: 5.62dB
Radiated emissions (Below 30MHz)	3.26dB
Radiated spurious emissions (30MHz~1GHz)	Horizontal: 3.70dB; Vertical: 4.42dB
The measurement uncertainty and decision risk evaluated according to AB/WI-RF-F-032. This uncertainty represents an expanded uncertainty expressed at approximately the 95% confidence level using a coverage factor of k=2.	

1.7. Test Summary

Test Items	Test Modes	Status
Antenna requirement	/	P
Conducted Emission at AC power line	Mode1,2,3,4,5,6	P
6dB Bandwidth	Mode1,2,3,4,5,6	P
Maximum Conducted Output Power	Mode1,2,3,4,5,6	P
Power Spectral Density	Mode1,2,3,4,5,6	P
Emissions in non-restricted frequency bands	Mode1,2,3,4,5,6	P
Band edge emissions (Radiated)	Mode1,2,3,4,5,6	P
Emissions in frequency bands (below 1GHz)	Mode1,2,3,4,5,6	P
Emissions in frequency bands (above 1GHz)	Mode1,2,3,4,5,6	P
Note: P: Pass N: N/A, not applicable		

Shenzhen Anbotek Compliance Laboratory Limited

1.8. Description of Test Facility

The test facility is recognized, certified, or accredited by the following organizations:

FCC-Registration No.:434132

Shenzhen Anbotek Compliance Laboratory Limited, EMC Laboratory has been registered and fully described in a report filed with the (FCC) Federal Communications Commission. The acceptance letter from the FCC is maintained in our files. Registration No. 434132.

ISED-Registration No.: 8058A

Shenzhen Anbotek Compliance Laboratory Limited, EMC Laboratory has been registered and fully described in a report filed with the (ISED) Innovation, Science and Economic Development Canada. The acceptance letter from the ISED is maintained in our files. Registration 8058A.

Test Location

Shenzhen Anbotek Compliance Laboratory Limited.
Sogood Industrial Zone Laboratory & 1/F. of Building D, Sogood Science and Technology Park, Sanwei Community, Hangcheng Subdistrict, Bao'an District, Shenzhen, Guangdong, China.

1.9. Disclaimer

1. The test report is invalid if not marked with the signatures of the persons responsible for preparing and approving the test report.
2. The test report is invalid if there is any evidence and/or falsification.
3. The results documented in this report apply only to the tested sample, under the conditions and modes of operation as described herein.
4. This document may not be altered or revised in any way unless done so by Anbotek and all revisions are duly noted in the revisions section.
5. Content of the test report, in part or in full, cannot be used for publicity and/or promotional purposes without prior written approval from the laboratory.
6. The authenticity of the information provided by the customer is the responsibility of the customer and the laboratory is not responsible for its authenticity.

The laboratory is only responsible for the data released by the laboratory, except for the part provided by the applicant.

1.10. Test Equipment List

Conducted Emission at AC power line						
Item	Equipment	Manufacturer	Model No.	Serial No.	Last Cal.	Cal.Due Date
1	L.I.S.N. Artificial Mains Network	Rohde & Schwarz	ENV216	100055	2024-09-09	2025-09-08
2	Three Phase V-type Artificial Power Network	CYBERTEK	EM5040DT	E215040D T001	2025-01-13	2026-01-12
3	Software Name EZ-EMC	Farad Technology	ANB-03A	N/A	/	/
4	EMI Test Receiver(CE2#)	Rohde & Schwarz	ESPI3	100926	2024-09-09	2025-09-08

Emissions in non-restricted frequency bands 6dB Bandwidth Maximum Conducted Output Power Power Spectral Density						
Item	Equipment	Manufacturer	Model No.	Serial No.	Last Cal.	Cal.Due Date
1	Constant Temperature Humidity Chamber	ZHONGJIAN	ZJ-KHWS80B	N/A	2024-10-14	2025-10-13
2	DC Power Supply	IVYTECH	IV3605	1804D360 510	2024-09-09	2025-09-08
3	Spectrum Analyzer	Rohde & Schwarz	FSV40-N	102150	2024-05-06	2025-05-05
4	MXA Spectrum Analysis	KEYSIGHT	N9020A	MY505318 23	2024-09-09	2025-09-08
5	Oscilloscope	Tektronix	MDO3012	C020298	2024-10-10	2025-10-09
6	MXG RF Vector Signal Generator	Agilent	N5182A	MY474206 47	2025-01-14	2026-01-13
7	Power Divider	EMEC	03-3182878	/	2024-05-06	2025-05-05

Shenzhen Anbotek Compliance Laboratory Limited

Band edge emissions (Radiated)						
Emissions in frequency bands (above 1GHz)						
Item	Equipment	Manufacturer	Model No.	Serial No.	Last Cal.	Cal.Due Date
1	EMI Test Receiver(RE2/3#)	Rohde & Schwarz	ESR26	101481	2025-01-14	2026-01-13
2	EMI Preamplifier	SKET Electronic	LNPA-0118G-45	SKET-PA-002	2025-01-13	2026-01-12
3	Double Ridged Horn Antenna	SCHWARZBECK	BBHA 9120D	02555	2022-10-16	2025-10-15
4	EMI Test Software EZ-EMC	SHURPLE	N/A	N/A	/	/
5	Horn Antenna	A-INFO	LB-180400-KF	J2110606 28	2024-01-22	2027-01-21
6	Spectrum Analyzer	Rohde & Schwarz	FSV40-N	102150	2024-05-06	2025-05-05
7	Amplifier	Talent Microwave	TLLA18G40 G-50-30	23022802	2024-05-07	2025-05-06
					2025-02-24	2026-02-23

Emissions in frequency bands (below 1GHz)						
Item	Equipment	Manufacturer	Model No.	Serial No.	Last Cal.	Cal.Due Date
1	EMI Test Receiver(RE2/3#)	Rohde & Schwarz	ESR26	101481	2025-01-14	2026-01-13
2	Pre-amplifier	SONOMA	310N	186860	2025-01-14	2026-01-13
3	Bilog Broadband Antenna	Schwarzbeck	VULB9163	345	2022-10-23	2025-10-22
4	Loop Antenna (9K-30M)	Schwarzbeck	FMZB1519 B	00053	2024-09-12	2025-09-11
5	EMI Test Software EZ-EMC	SHURPLE	N/A	N/A	/	/

Shenzhen Anbotek Compliance Laboratory Limited

2. Antenna requirement

Test Requirement:	Refer to 47 CFR Part 15.203, an intentional radiator shall be designed to ensure that no antenna other than that furnished by the responsible party shall be used with the device. The use of a permanently attached antenna or of an antenna that uses a unique coupling to the intentional radiator shall be considered sufficient to comply with the provisions of this section.
-------------------	---

2.1. Conclusion

The antenna is a FPC Antenna which permanently attached, and the best case gain of the antenna is 3.34dBi for ANT1 and 5.68dBi for ANT2 .It complies with the standard requirement.
--

3. Conducted Emission at AC power line

Test Requirement:	Refer to 47 CFR 15.207(a), Except as shown in paragraphs (b) and (c) of this section, for an intentional radiator that is designed to be connected to the public utility (AC) power line, the radio frequency voltage that is conducted back onto the AC power line on any frequency or frequencies, within the band 150 kHz to 30 MHz, shall not exceed the limits in the following table, as measured using a 50 μ H/50 ohms line impedance stabilization network (LISN).		
Test Limit:	Frequency of emission (MHz)	Conducted limit (dB μ V)	
		Quasi-peak	Average
	0.15-0.5	66 to 56*	56 to 46*
	0.5-5	56	46
	5-30	60	50
	*Decreases with the logarithm of the frequency.		
Test Method:	ANSI C63.10-2020 section 6.2		
Procedure:	Refer to ANSI C63.10-2020 section 6.2, standard test method for ac power-line conducted emissions from unlicensed wireless devices		

3.1. EUT Operation

Operating Environment:	
Test mode:	<ol style="list-style-type: none"> 1: 802.11b mode: Keep the EUT in 802.11b transmitting mode. 2: 802.11g mode: Keep the EUT in 802.11g transmitting mode. 3: 802.11n(HT20) mode: Keep the EUT in 802.11n(HT20) transmitting mode. 4: 802.11n(HT40) mode: Keep the EUT in 802.11n(HT40) transmitting mode. 5: 802.11ax(HEW20): Keep the EUT in 802.11ax(HEW20) transmitting mode. 6: 802.11ax(HEW40): Keep the EUT in 802.11ax(HEW40) transmitting mode.

3.2. Test Setup

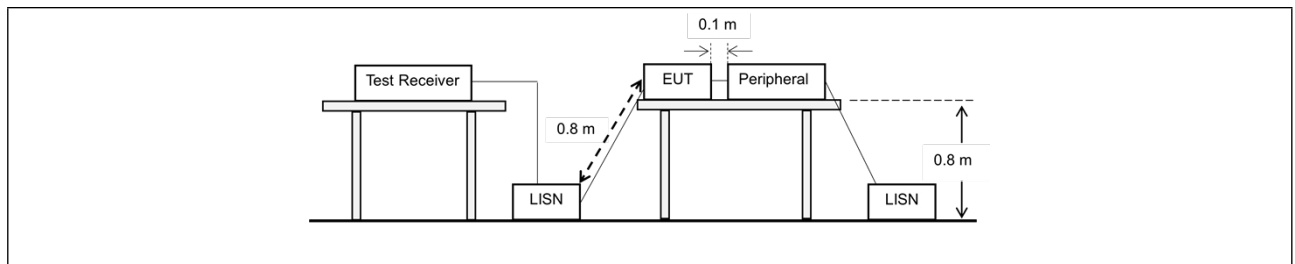

3.3. Test Data

Temperature:	23 °C	Humidity:	54 %	Atmospheric Pressure:	101 kPa
--------------	-------	-----------	------	-----------------------	---------

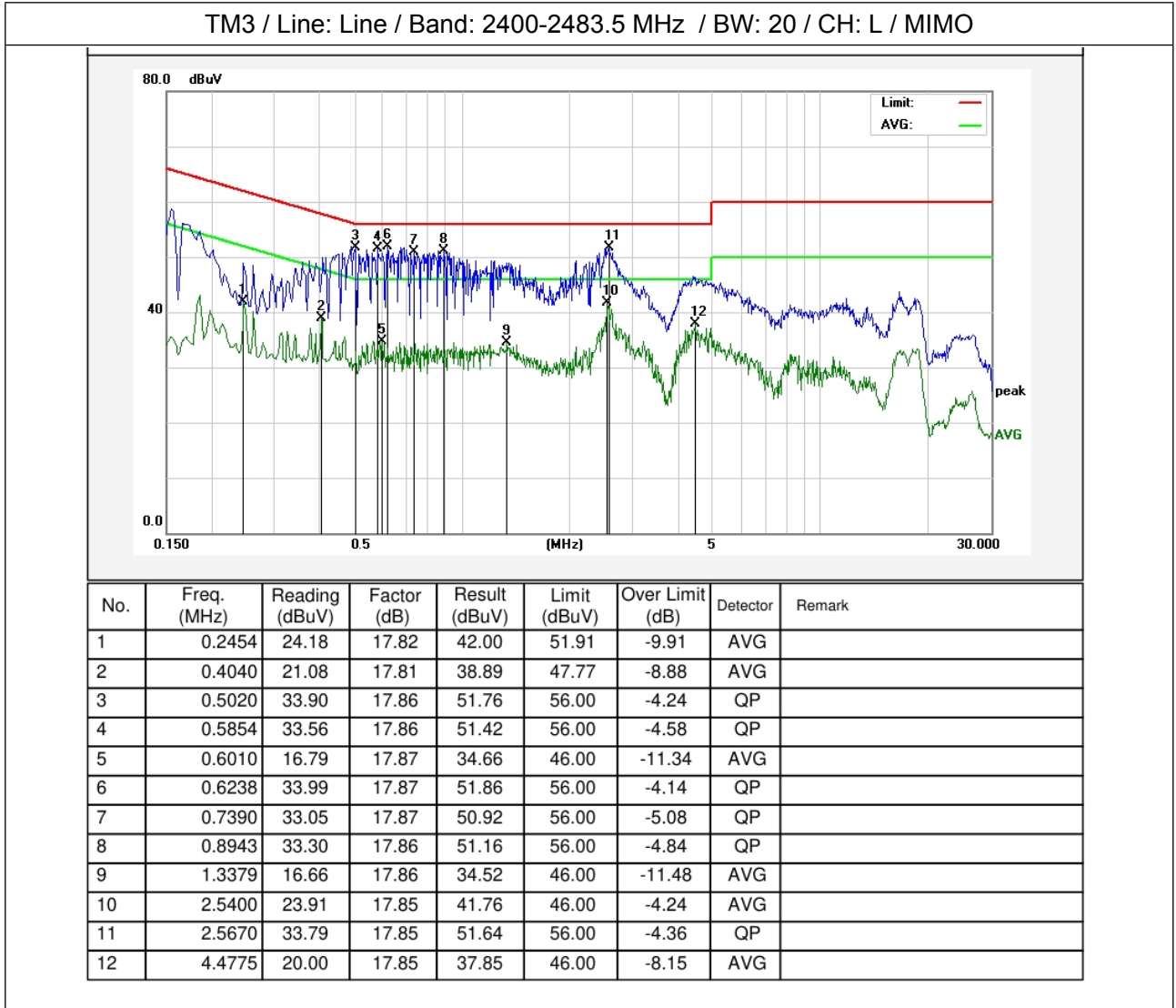

Shenzhen Anbotek Compliance Laboratory Limited

Temperature:	23 °C	Humidity:	54 %	Atmospheric Pressure:	101 kPa
--------------	-------	-----------	------	-----------------------	---------

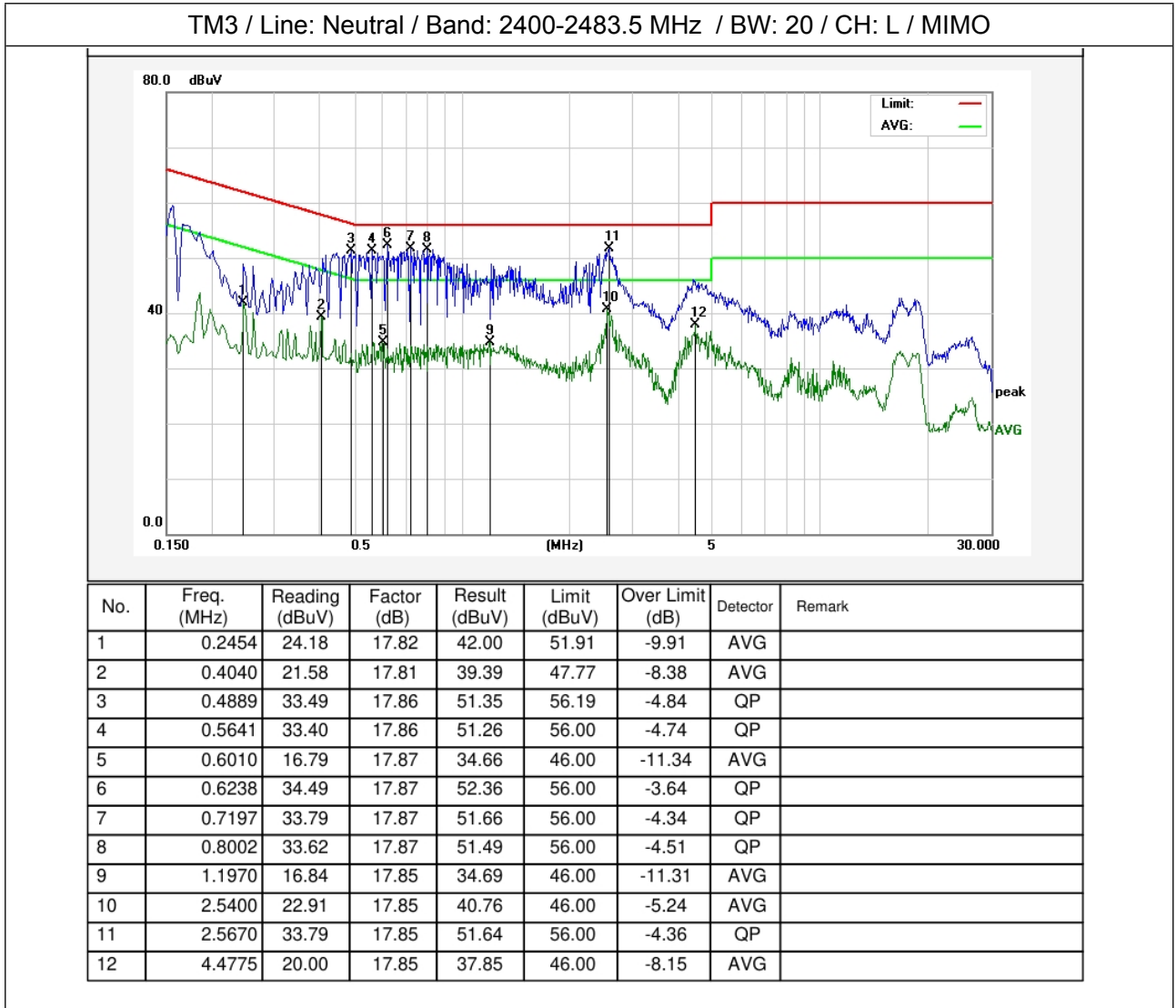

Note: Only record the worst data in the report.

Shenzhen Anbotek Compliance Laboratory Limited

4. 6dB Bandwidth

Test Requirement:	47 CFR 15.247(a)(2)
Test Limit:	Refer to 47 CFR 15.247(a)(2), Systems using digital modulation techniques may operate in the 902-928 MHz, and 2400-2483.5 MHz bands. The minimum 6 dB bandwidth shall be at least 500 kHz.
Test Method:	ANSI C63.10-2020, section 11.8 KDB 558074 D01 15.247 Meas Guidance v05r02
Procedure:	<p>11.8.1 Option 1 The steps for the first option are as follows: a) Set RBW = shall be in the range of 1% to 5% of the OBW but not less than 100 kHz. b) Set the VBW $\geq [3 \times \text{RBW}]$. c) Detector = peak. d) Trace mode = max-hold. e) Sweep = No faster than coupled (auto) time. f) Allow the trace to stabilize. g) Measure the maximum width of the emission by placing two markers, one at the lowest frequency and the other at the highest frequency of the envelope of the spectral display, such that each marker is at or slightly below the “-6 dB down amplitude”. If a marker is below this “-6 dB down amplitude” value, then it shall be as close as possible to this value.</p> <p>11.8.2 Option 2 The automatic bandwidth measurement capability of an instrument may be employed using the X dB bandwidth mode with X set to 6 dB, if the functionality described in 11.8.1 (i.e., RBW = 100 kHz, VBW $\geq 3 \times \text{RBW}$, and peak detector with maximum hold) is implemented by the instrumentation function. When using this capability, care shall be taken so that the bandwidth measurement is not influenced by any intermediate power nulls in the fundamental emission that might be ≥ 6 dB.</p>

4.1. EUT Operation

Operating Environment:	
Test mode:	<ol style="list-style-type: none"> 1: 802.11b mode: Keep the EUT in 802.11b transmitting mode. 2: 802.11g mode: Keep the EUT in 802.11g transmitting mode. 3: 802.11n(HT20) mode: Keep the EUT in 802.11n(HT20) transmitting mode. 4: 802.11n(HT40) mode: Keep the EUT in 802.11n(HT40) transmitting mode. 5: 802.11ax(HEW20): Keep the EUT in 802.11ax(HEW20) transmitting mode. 6: 802.11ax(HEW40): Keep the EUT in 802.11ax(HEW40) transmitting mode.

4.2. Test Setup

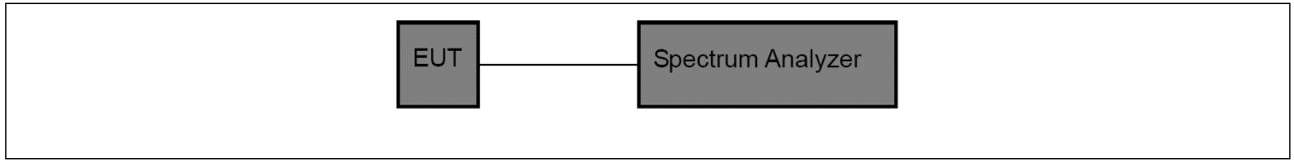

4.3. Test Data

Temperature:	20.5 °C	Humidity:	45 %	Atmospheric Pressure:	101 kPa
--------------	---------	-----------	------	-----------------------	---------

Please Refer to Appendix for Details.

5. Maximum Conducted Output Power

Test Requirement:	47 CFR 15.247(b)(3)
Test Limit:	Refer to 47 CFR 15.247(b)(3), For systems using digital modulation in the 902-928 MHz, 2400-2483.5 MHz, and 5725-5850 MHz bands: 1 Watt. As an alternative to a peak power measurement, compliance with the one Watt limit can be based on a measurement of the maximum conducted output power. Maximum Conducted Output Power is defined as the total transmit power delivered to all antennas and antenna elements averaged across all symbols in the signaling alphabet when the transmitter is operating at its maximum power control level. Power must be summed across all antennas and antenna elements. The average must not include any time intervals during which the transmitter is off or is transmitting at a reduced power level. If multiple modes of operation are possible (e.g., alternative modulation methods), the maximum conducted output power is the highest total transmit power occurring in any mode.
Test Method:	ANSI C63.10-2020, section 11.9.2 KDB 558074 D01 15.247 Meas Guidance v05r02
Procedure:	ANSI C63.10-2020, section 11.9.2 Maximum conducted (average) output power

5.1. EUT Operation

Operating Environment:	
Test mode:	<ol style="list-style-type: none"> 1: 802.11b mode: Keep the EUT in 802.11b transmitting mode. 2: 802.11g mode: Keep the EUT in 802.11g transmitting mode. 3: 802.11n(HT20) mode: Keep the EUT in 802.11n(HT20) transmitting mode. 4: 802.11n(HT40) mode: Keep the EUT in 802.11n(HT40) transmitting mode. 5: 802.11ax(HEW20): Keep the EUT in 802.11ax(HEW20) transmitting mode. 6: 802.11ax(HEW40): Keep the EUT in 802.11ax(HEW40) transmitting mode.

5.2. Test Setup

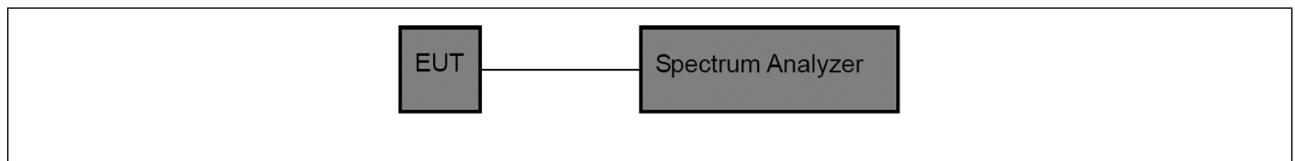

5.3. Test Data

Temperature:	20.5 °C	Humidity:	45 %	Atmospheric Pressure:	101 kPa
--------------	---------	-----------	------	-----------------------	---------

Please Refer to Appendix for Details.

6. Power Spectral Density

Test Requirement:	47 CFR 15.247(e)
Test Limit:	Refer to 47 CFR 15.247(e), For digitally modulated systems, the power spectral density conducted from the intentional radiator to the antenna shall not be greater than 8 dBm in any 3 kHz band during any time interval of continuous transmission. This power spectral density shall be determined in accordance with the provisions of paragraph (b) of this section. The same method of determining the conducted output power shall be used to determine the power spectral density.
Test Method:	ANSI C63.10-2020, section 11.10 KDB 558074 D01 15.247 Meas Guidance v05r02
Procedure:	ANSI C63.10-2020, section 11.10, Maximum power spectral density level in the fundamental emission

6.1. EUT Operation

Operating Environment:	
Test mode:	<ol style="list-style-type: none"> 1: 802.11b mode: Keep the EUT in 802.11b transmitting mode. 2: 802.11g mode: Keep the EUT in 802.11g transmitting mode. 3: 802.11n(HT20) mode: Keep the EUT in 802.11n(HT20) transmitting mode. 4: 802.11n(HT40) mode: Keep the EUT in 802.11n(HT40) transmitting mode. 5: 802.11ax(HEW20): Keep the EUT in 802.11ax(HEW20) transmitting mode. 6: 802.11ax(HEW40): Keep the EUT in 802.11ax(HEW40) transmitting mode.

6.2. Test Setup

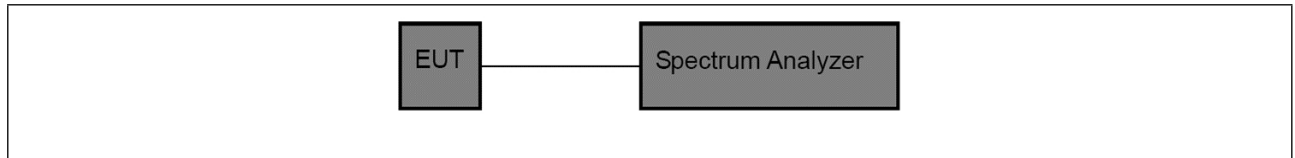

6.3. Test Data

Temperature:	20.5 °C	Humidity:	45 %	Atmospheric Pressure:	101 kPa
--------------	---------	-----------	------	-----------------------	---------

Please Refer to Appendix for Details.

7. Emissions in non-restricted frequency bands

Test Requirement:	47 CFR 15.247(d), 15.209, 15.205
Test Limit:	Refer to 47 CFR 15.247(d), In any 100 kHz bandwidth outside the frequency band in which the spread spectrum or digitally modulated intentional radiator is operating, the radio frequency power that is produced by the intentional radiator shall be at least 20 dB below that in the 100 kHz bandwidth within the band that contains the highest level of the desired power, based on either an RF conducted or a radiated measurement, provided the transmitter demonstrates compliance with the peak conducted power limits. If the transmitter complies with the conducted power limits based on the use of RMS averaging over a time interval, as permitted under paragraph (b)(3) of this section, the attenuation required under this paragraph shall be 30 dB instead of 20 dB. Attenuation below the general limits specified in § 15.209(a) is not required.
Test Method:	ANSI C63.10-2020 section 11.11 KDB 558074 D01 15.247 Meas Guidance v05r02
Procedure:	ANSI C63.10-2020 Section 11.11.1, Section 11.11.2, Section 11.11.3

7.1. EUT Operation

Operating Environment:	
Test mode:	<ol style="list-style-type: none"> 1: 802.11b mode: Keep the EUT in 802.11b transmitting mode. 2: 802.11g mode: Keep the EUT in 802.11g transmitting mode. 3: 802.11n(HT20) mode: Keep the EUT in 802.11n(HT20) transmitting mode. 4: 802.11n(HT40) mode: Keep the EUT in 802.11n(HT40) transmitting mode. 5: 802.11ax(HEW20): Keep the EUT in 802.11ax(HEW20) transmitting mode. 6: 802.11ax(HEW40): Keep the EUT in 802.11ax(HEW40) transmitting mode.

7.2. Test Setup

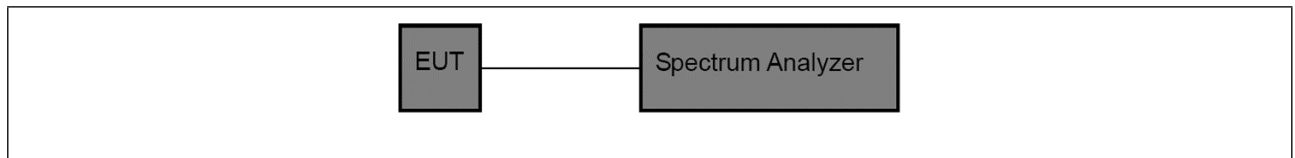

7.3. Test Data

Temperature:	20.5 °C	Humidity:	45 %	Atmospheric Pressure:	101 kPa
--------------	---------	-----------	------	-----------------------	---------

Please Refer to Appendix for Details.

8. Band edge emissions (Radiated)

Test Requirement:	Refer to 47 CFR 15.247(d), In addition, radiated emissions which fall in the restricted bands, as defined in § 15.205(a), must also comply with the radiated emission limits specified in § 15.209(a)(see § 15.205(c)).		
Test Limit:	Frequency (MHz)	Field strength (microvolts/meter)	Measurement distance (meters)
	0.009-0.490	2400/F(kHz)	300
	0.490-1.705	24000/F(kHz)	30
	1.705-30.0	30	30
	30-88	100 **	3
	88-216	150 **	3
	216-960	200 **	3
	Above 960	500	3
Test Limit:	<p>** Except as provided in paragraph (g), fundamental emissions from intentional radiators operating under this section shall not be located in the frequency bands 54-72 MHz, 76-88 MHz, 174-216 MHz or 470-806 MHz. However, operation within these frequency bands is permitted under other sections of this part, e.g., §§ 15.231 and 15.241.</p> <p>In the emission table above, the tighter limit applies at the band edges. The emission limits shown in the above table are based on measurements employing a CISPR quasi-peak detector except for the frequency bands 9–90 kHz, 110–490 kHz and above 1000 MHz. Radiated emission limits in these three bands are based on measurements employing an average detector.</p>		
Test Method:	ANSI C63.10-2020 section 6.10 KDB 558074 D01 15.247 Meas Guidance v05r02		
Procedure:	ANSI C63.10-2020 section 6.10.5.2		

8.1. EUT Operation

Operating Environment:	
Test mode:	<ol style="list-style-type: none"> 1: 802.11b mode: Keep the EUT in 802.11b transmitting mode. 2: 802.11g mode: Keep the EUT in 802.11g transmitting mode. 3: 802.11n(HT20) mode: Keep the EUT in 802.11n(HT20) transmitting mode. 4: 802.11n(HT40) mode: Keep the EUT in 802.11n(HT40) transmitting mode. 5: 802.11ax(HEW20): Keep the EUT in 802.11ax(HEW20) transmitting mode. 6: 802.11ax(HEW40): Keep the EUT in 802.11ax(HEW40) transmitting mode.

8.2. Test Setup

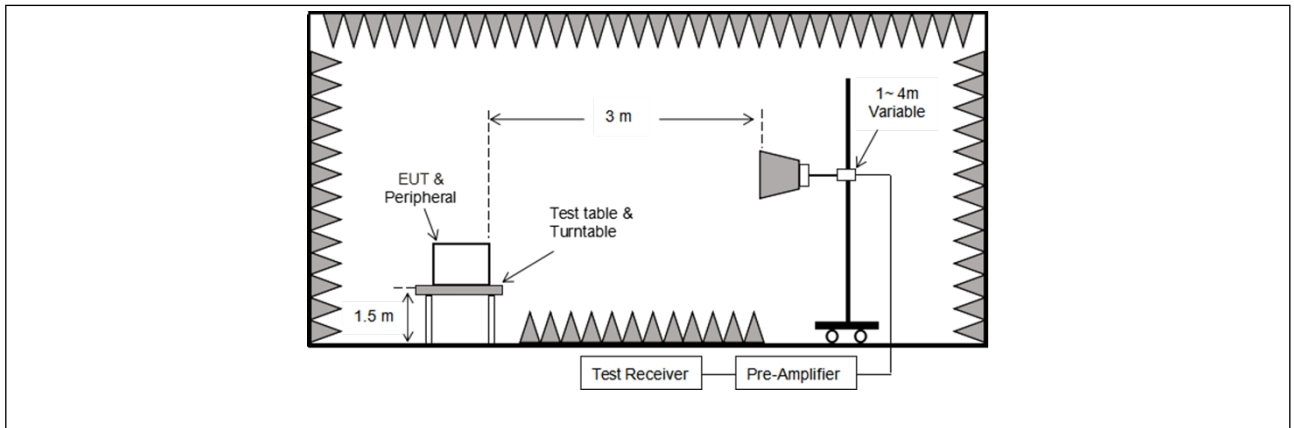

8.3. Test Data

Temperature:	20.5 °C	Humidity:	45 %	Atmospheric Pressure:	101 kPa
--------------	---------	-----------	------	-----------------------	---------

TM1 / CH: L						
Peak value:						
Frequency (MHz)	Reading (dBuV)	Factor (dB/m)	Result (dBuV/m)	Limit Line (dBuV/m)	Over Limit (dB)	Polarization
2310.00	38.97	9.58	48.55	74.00	-25.45	Horizontal
2390.00	41.02	9.73	50.75	74.00	-23.25	Horizontal
2310.00	40.40	9.58	49.98	74.00	-24.02	Vertical
2390.00	46.73	9.73	56.46	74.00	-17.54	Vertical
Average value:						
Frequency (MHz)	Reading (dBuV)	Factor (dB/m)	Result (dBuV/m)	Limit Line (dBuV/m)	Over Limit (dB)	Polarization
2310.00	29.64	9.58	39.22	54.00	-14.78	Horizontal
2390.00	36.90	9.73	46.63	54.00	-7.37	Horizontal
2310.00	30.64	9.58	40.22	54.00	-13.78	Vertical
2390.00	39.28	9.73	49.01	54.00	-4.99	Vertical

TM1 / CH: H						
Peak value:						
Frequency (MHz)	Reading (dBuV)	Factor (dB/m)	Result (dBuV/m)	Limit Line (dBuV/m)	Over Limit (dB)	Polarization
2483.50	46.71	9.91	56.62	74.00	-17.38	Horizontal
2500.00	41.08	9.94	51.02	74.00	-22.98	Horizontal
2483.50	47.07	9.91	56.98	74.00	-17.02	Vertical
2500.00	40.80	9.94	50.74	74.00	-23.26	Vertical
Average value:						
Frequency (MHz)	Reading (dBuV)	Factor (dB/m)	Result (dBuV/m)	Limit Line (dBuV/m)	Over Limit (dB)	Polarization
2483.50	38.15	9.91	48.06	54.00	-5.94	Horizontal
2500.00	30.15	9.94	40.09	54.00	-13.91	Horizontal
2483.50	39.95	9.91	49.86	54.00	-4.14	Vertical
2500.00	30.36	9.94	40.30	54.00	-13.70	Vertical

Remark:

1. Result=Reading + Factor
2. During the test, all antenna chains has been tested, and only worst case (ANT1) data is listed in the report.

TM2 / CH: L						
Peak value:						
Frequency (MHz)	Reading (dBuV)	Factor (dB/m)	Result (dBuV/m)	Limit Line (dBuV/m)	Over Limit (dB)	Polarization
2310.00	37.57	9.58	47.15	74.00	-26.85	Horizontal
2390.00	41.52	9.73	51.25	74.00	-22.75	Horizontal
2310.00	40.20	9.58	49.78	74.00	-24.22	Vertical
2390.00	44.14	9.73	53.87	74.00	-20.13	Vertical
Average value:						
Frequency (MHz)	Reading (dBuV)	Factor (dB/m)	Result (dBuV/m)	Limit Line (dBuV/m)	Over Limit (dB)	Polarization
2310.00	30.42	9.58	40.00	54.00	-14.00	Horizontal
2390.00	37.18	9.73	46.91	54.00	-7.09	Horizontal
2310.00	31.05	9.58	40.63	54.00	-13.37	Vertical
2390.00	36.52	9.73	46.25	54.00	-7.75	Vertical

TM2 / CH: H						
Peak value:						
Frequency (MHz)	Reading (dBuV)	Factor (dB/m)	Result (dBuV/m)	Limit Line (dBuV/m)	Over Limit (dB)	Polarization
2483.50	46.75	9.91	56.66	74.00	-17.34	Horizontal
2500.00	41.18	9.94	51.12	74.00	-22.88	Horizontal
2483.50	46.91	9.91	56.82	74.00	-17.18	Vertical
2500.00	40.75	9.94	50.69	74.00	-23.31	Vertical
Average value:						
Frequency (MHz)	Reading (dBuV)	Factor (dB/m)	Result (dBuV/m)	Limit Line (dBuV/m)	Over Limit (dB)	Polarization
2483.50	36.32	9.91	46.23	54.00	-7.77	Horizontal
2500.00	29.25	9.94	39.19	54.00	-14.81	Horizontal
2483.50	38.90	9.91	48.81	54.00	-5.19	Vertical
2500.00	29.89	9.94	39.83	54.00	-14.17	Vertical

Remark:

1. Result=Reading + Factor
2. During the test, all antenna chains has been tested, and only worst case (ANT1) data is listed in the report.

TM3 / CH: L						
Peak value:						
Frequency (MHz)	Reading (dBuV)	Factor (dB/m)	Result (dBuV/m)	Limit Line (dBuV/m)	Over Limit (dB)	Polarization
2310.00	35.57	9.58	45.15	74.00	-28.85	Horizontal
2390.00	39.52	9.73	49.25	74.00	-24.75	Horizontal
2310.00	39.20	9.58	48.78	74.00	-25.22	Vertical
2390.00	42.14	9.73	51.87	74.00	-22.13	Vertical
Average value:						
Frequency (MHz)	Reading (dBuV)	Factor (dB/m)	Result (dBuV/m)	Limit Line (dBuV/m)	Over Limit (dB)	Polarization
2310.00	29.10	9.58	38.68	54.00	-15.32	Horizontal
2390.00	34.55	9.73	44.28	54.00	-9.72	Horizontal
2310.00	28.66	9.58	38.24	54.00	-15.76	Vertical
2390.00	34.52	9.73	44.25	54.00	-9.75	Vertical

TM3 / CH: H						
Peak value:						
Frequency (MHz)	Reading (dBuV)	Factor (dB/m)	Result (dBuV/m)	Limit Line (dBuV/m)	Over Limit (dB)	Polarization
2483.50	44.48	9.91	54.39	74.00	-19.61	Horizontal
2500.00	39.08	9.94	49.02	74.00	-24.98	Horizontal
2483.50	46.07	9.91	55.98	74.00	-18.02	Vertical
2500.00	40.80	9.94	50.74	74.00	-23.26	Vertical
Average value:						
Frequency (MHz)	Reading (dBuV)	Factor (dB/m)	Result (dBuV/m)	Limit Line (dBuV/m)	Over Limit (dB)	Polarization
2483.50	34.30	9.91	44.21	54.00	-9.79	Horizontal
2500.00	29.40	9.94	39.34	54.00	-14.66	Horizontal
2483.50	35.72	9.91	45.63	54.00	-8.37	Vertical
2500.00	30.03	9.94	39.97	54.00	-14.03	Vertical

Remark:

1. Result=Reading + Factor
2. During the test, SISO and MIMO modes have been tested, and only worst case (MIMO) data is listed in the report.

TM4 / CH: L						
Peak value:						
Frequency (MHz)	Reading (dBuV)	Factor (dB/m)	Result (dBuV/m)	Limit Line (dBuV/m)	Over Limit (dB)	Polarization
2310.00	38.04	9.58	47.62	74.00	-26.38	Horizontal
2390.00	42.52	9.73	52.25	74.00	-21.75	Horizontal
2310.00	41.20	9.58	50.78	74.00	-23.22	Vertical
2390.00	44.35	9.73	54.08	74.00	-19.92	Vertical
Average value:						
Frequency (MHz)	Reading (dBuV)	Factor (dB/m)	Result (dBuV/m)	Limit Line (dBuV/m)	Over Limit (dB)	Polarization
2310.00	30.02	9.58	39.60	54.00	-14.40	Horizontal
2390.00	35.21	9.73	44.94	54.00	-9.06	Horizontal
2310.00	29.86	9.58	39.44	54.00	-14.56	Vertical
2390.00	33.92	9.73	43.65	54.00	-10.35	Vertical

TM4 / CH: H						
Peak value:						
Frequency (MHz)	Reading (dBuV)	Factor (dB/m)	Result (dBuV/m)	Limit Line (dBuV/m)	Over Limit (dB)	Polarization
2483.50	44.39	9.91	54.30	74.00	-19.70	Horizontal
2500.00	39.76	9.94	49.70	74.00	-24.30	Horizontal
2483.50	46.20	9.91	56.11	74.00	-17.89	Vertical
2500.00	41.30	9.94	51.24	74.00	-22.76	Vertical
Average value:						
Frequency (MHz)	Reading (dBuV)	Factor (dB/m)	Result (dBuV/m)	Limit Line (dBuV/m)	Over Limit (dB)	Polarization
2483.50	34.00	9.91	43.91	54.00	-10.09	Horizontal
2500.00	31.40	9.94	41.34	54.00	-12.66	Horizontal
2483.50	35.72	9.91	45.63	54.00	-8.37	Vertical
2500.00	31.03	9.94	40.97	54.00	-13.03	Vertical

Remark:

1. Result=Reading + Factor
2. During the test, SISO and MIMO modes have been tested, and only worst case (MIMO) data is listed in the report.

TM5 / CH: L						
Peak value:						
Frequency (MHz)	Reading (dBuV)	Factor (dB/m)	Result (dBuV/m)	Limit Line (dBuV/m)	Over Limit (dB)	Polarization
2310.00	35.87	9.58	45.45	74.00	-28.55	Horizontal
2390.00	39.96	9.73	49.69	74.00	-24.31	Horizontal
2310.00	39.80	9.58	49.38	74.00	-24.62	Vertical
2390.00	42.85	9.73	52.58	74.00	-21.42	Vertical
Average value:						
Frequency (MHz)	Reading (dBuV)	Factor (dB/m)	Result (dBuV/m)	Limit Line (dBuV/m)	Over Limit (dB)	Polarization
2310.00	29.66	9.58	39.24	54.00	-14.76	Horizontal
2390.00	35.16	9.73	44.89	54.00	-9.11	Horizontal
2310.00	29.08	9.58	38.66	54.00	-15.34	Vertical
2390.00	34.80	9.73	44.53	54.00	-9.47	Vertical

TM5 / CH: H						
Peak value:						
Frequency (MHz)	Reading (dBuV)	Factor (dB/m)	Result (dBuV/m)	Limit Line (dBuV/m)	Over Limit (dB)	Polarization
2483.50	44.68	9.91	54.59	74.00	-19.41	Horizontal
2500.00	39.47	9.94	49.41	74.00	-24.59	Horizontal
2483.50	46.27	9.91	56.18	74.00	-17.82	Vertical
2500.00	41.22	9.94	51.16	74.00	-22.84	Vertical
Average value:						
Frequency (MHz)	Reading (dBuV)	Factor (dB/m)	Result (dBuV/m)	Limit Line (dBuV/m)	Over Limit (dB)	Polarization
2483.50	34.62	9.91	44.53	54.00	-9.47	Horizontal
2500.00	29.80	9.94	39.74	54.00	-14.26	Horizontal
2483.50	36.16	9.91	46.07	54.00	-7.93	Vertical
2500.00	30.33	9.94	40.27	54.00	-13.73	Vertical

Remark:

1. Result=Reading + Factor
2. During the test, SISO and MIMO modes have been tested, and only worst case (MIMO) data is listed in the report.

TM6 / CH: L						
Peak value:						
Frequency (MHz)	Reading (dBuV)	Factor (dB/m)	Result (dBuV/m)	Limit Line (dBuV/m)	Over Limit (dB)	Polarization
2310.00	38.34	9.58	47.92	74.00	-26.08	Horizontal
2390.00	42.96	9.73	52.69	74.00	-21.31	Horizontal
2310.00	41.80	9.58	51.38	74.00	-22.62	Vertical
2390.00	45.06	9.73	54.79	74.00	-19.21	Vertical
Average value:						
Frequency (MHz)	Reading (dBuV)	Factor (dB/m)	Result (dBuV/m)	Limit Line (dBuV/m)	Over Limit (dB)	Polarization
2310.00	30.58	9.58	40.16	54.00	-13.84	Horizontal
2390.00	35.65	9.73	45.38	54.00	-8.62	Horizontal
2310.00	30.28	9.58	39.86	54.00	-14.14	Vertical
2390.00	34.20	9.73	43.93	54.00	-10.07	Vertical

TM6 / CH: H						
Peak value:						
Frequency (MHz)	Reading (dBuV)	Factor (dB/m)	Result (dBuV/m)	Limit Line (dBuV/m)	Over Limit (dB)	Polarization
2483.50	44.59	9.91	54.50	74.00	-19.50	Horizontal
2500.00	40.15	9.94	50.09	74.00	-23.91	Horizontal
2483.50	46.40	9.91	56.31	74.00	-17.69	Vertical
2500.00	41.72	9.94	51.66	74.00	-22.34	Vertical
Average value:						
Frequency (MHz)	Reading (dBuV)	Factor (dB/m)	Result (dBuV/m)	Limit Line (dBuV/m)	Over Limit (dB)	Polarization
2483.50	34.32	9.91	44.23	54.00	-9.77	Horizontal
2500.00	31.80	9.94	41.74	54.00	-12.26	Horizontal
2483.50	36.16	9.91	46.07	54.00	-7.93	Vertical
2500.00	31.33	9.94	41.27	54.00	-12.73	Vertical

Remark:

1. Result=Reading + Factor
2. During the test, SISO and MIMO modes have been tested, and only worst case (MIMO) data is listed in the report.

9. Emissions in frequency bands (below 1GHz)

Test Requirement:	Refer to 47 CFR 15.247(d), In addition, radiated emissions which fall in the restricted bands, as defined in § 15.205(a), must also comply with the radiated emission limits specified in § 15.209(a)(see § 15.205(c)).		
Test Limit:	Frequency (MHz)	Field strength (microvolts/meter)	Measurement distance (meters)
	0.009-0.490	2400/F(kHz)	300
	0.490-1.705	24000/F(kHz)	30
	1.705-30.0	30	30
	30-88	100 **	3
	88-216	150 **	3
	216-960	200 **	3
	Above 960	500	3
	<p>** Except as provided in paragraph (g), fundamental emissions from intentional radiators operating under this section shall not be located in the frequency bands 54-72 MHz, 76-88 MHz, 174-216 MHz or 470-806 MHz. However, operation within these frequency bands is permitted under other sections of this part, e.g., §§ 15.231 and 15.241.</p> <p>In the emission table above, the tighter limit applies at the band edges. The emission limits shown in the above table are based on measurements employing a CISPR quasi-peak detector except for the frequency bands 9–90 kHz, 110–490 kHz and above 1000 MHz. Radiated emission limits in these three bands are based on measurements employing an average detector.</p>		
Test Method:	ANSI C63.10-2020 section 6.6.4 KDB 558074 D01 15.247 Meas Guidance v05r02		
Procedure:	ANSI C63.10-2020 section 6.6.4		

9.1. EUT Operation

Operating Environment:	
Test mode:	<ol style="list-style-type: none"> 1: 802.11b mode: Keep the EUT in 802.11b transmitting mode. 2: 802.11g mode: Keep the EUT in 802.11g transmitting mode. 3: 802.11n(HT20) mode: Keep the EUT in 802.11n(HT20) transmitting mode. 4: 802.11n(HT40) mode: Keep the EUT in 802.11n(HT40) transmitting mode. 5: 802.11ax(HEW20): Keep the EUT in 802.11ax(HEW20) transmitting mode. 6: 802.11ax(HEW40): Keep the EUT in 802.11ax(HEW40) transmitting mode.

9.2. Test Setup

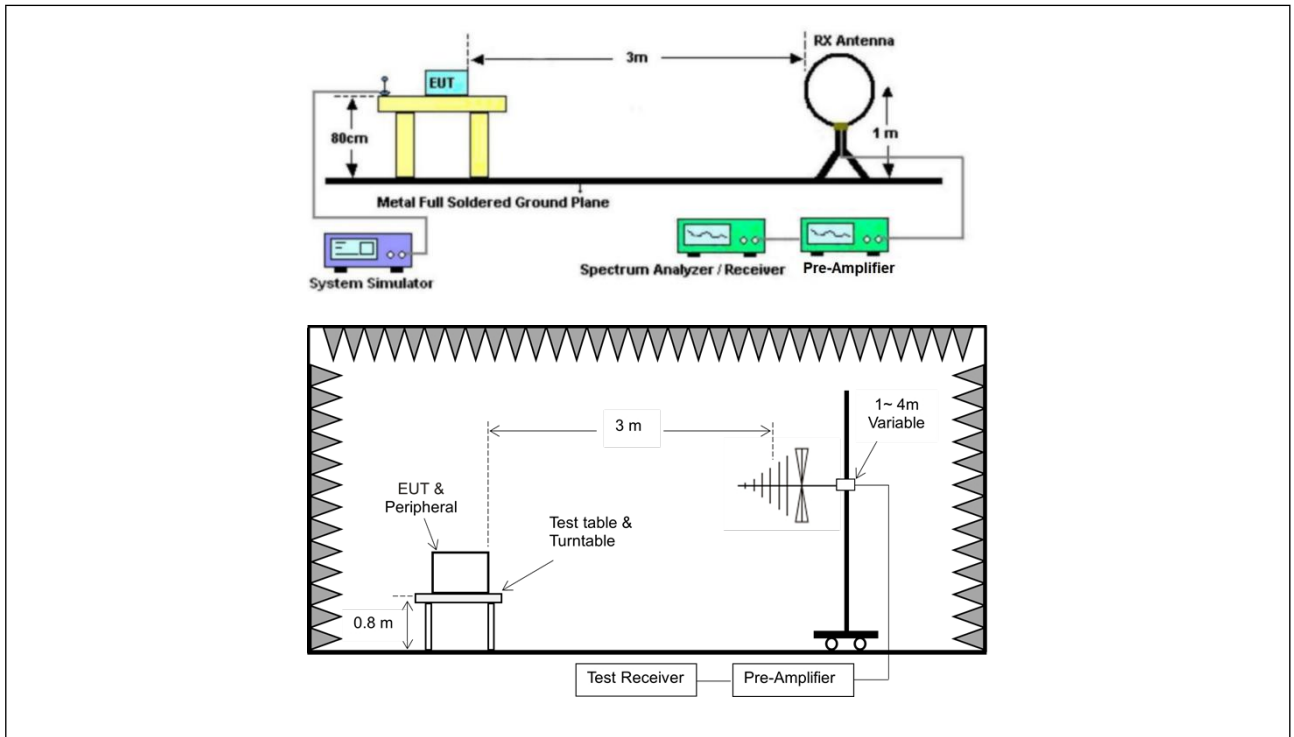

9.3. Test Data

The test results of 9kHz-30MHz was attenuated more than 20dB below the permissible limits, so the results don't record in the report.

Temperature:	26.5 °C	Humidity:	51 %	Atmospheric Pressure:	101 kPa
--------------	---------	-----------	------	-----------------------	---------

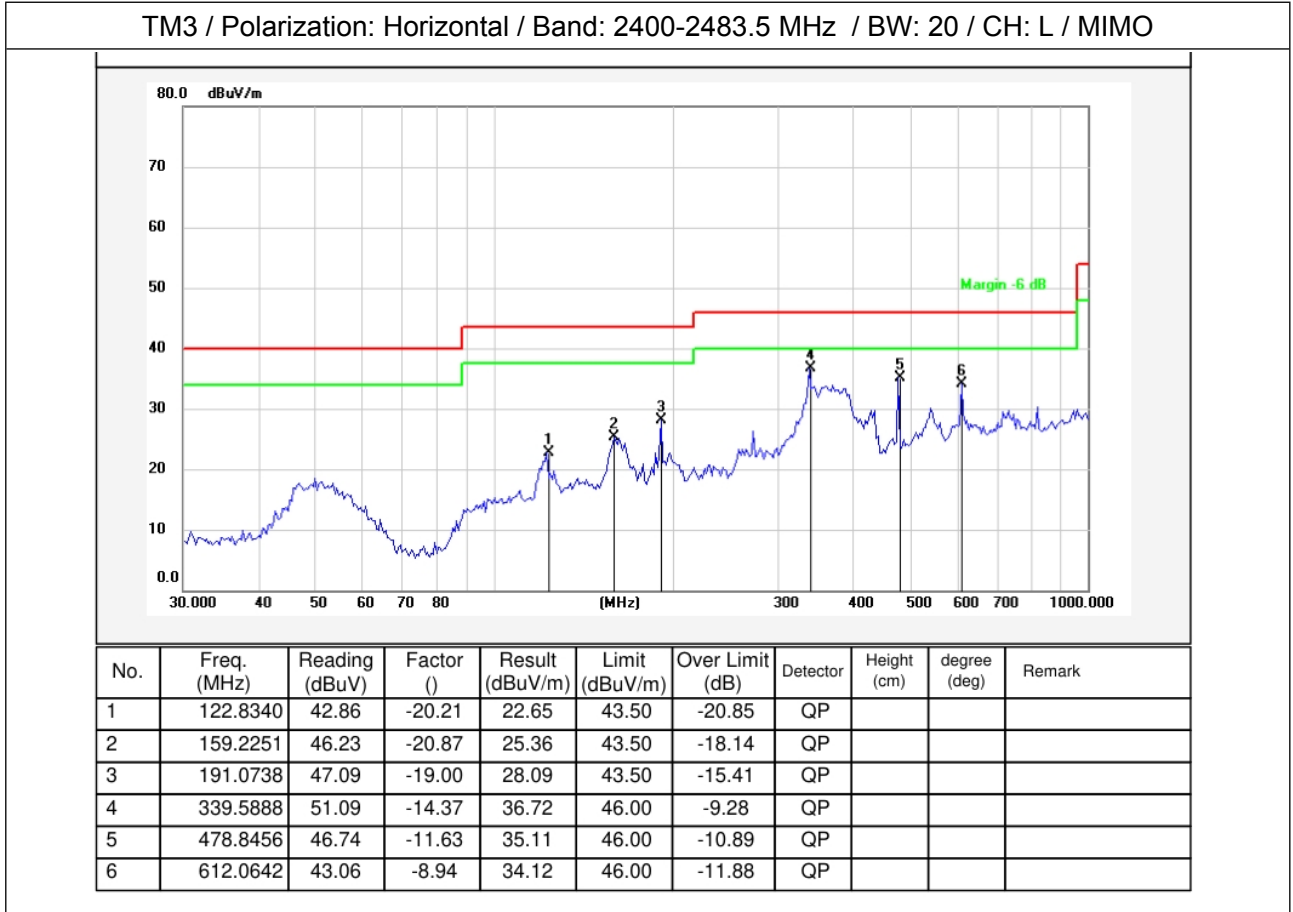

Temperature:	26.5 °C	Humidity:	51 %	Atmospheric Pressure:	101 kPa
--------------	---------	-----------	------	-----------------------	---------

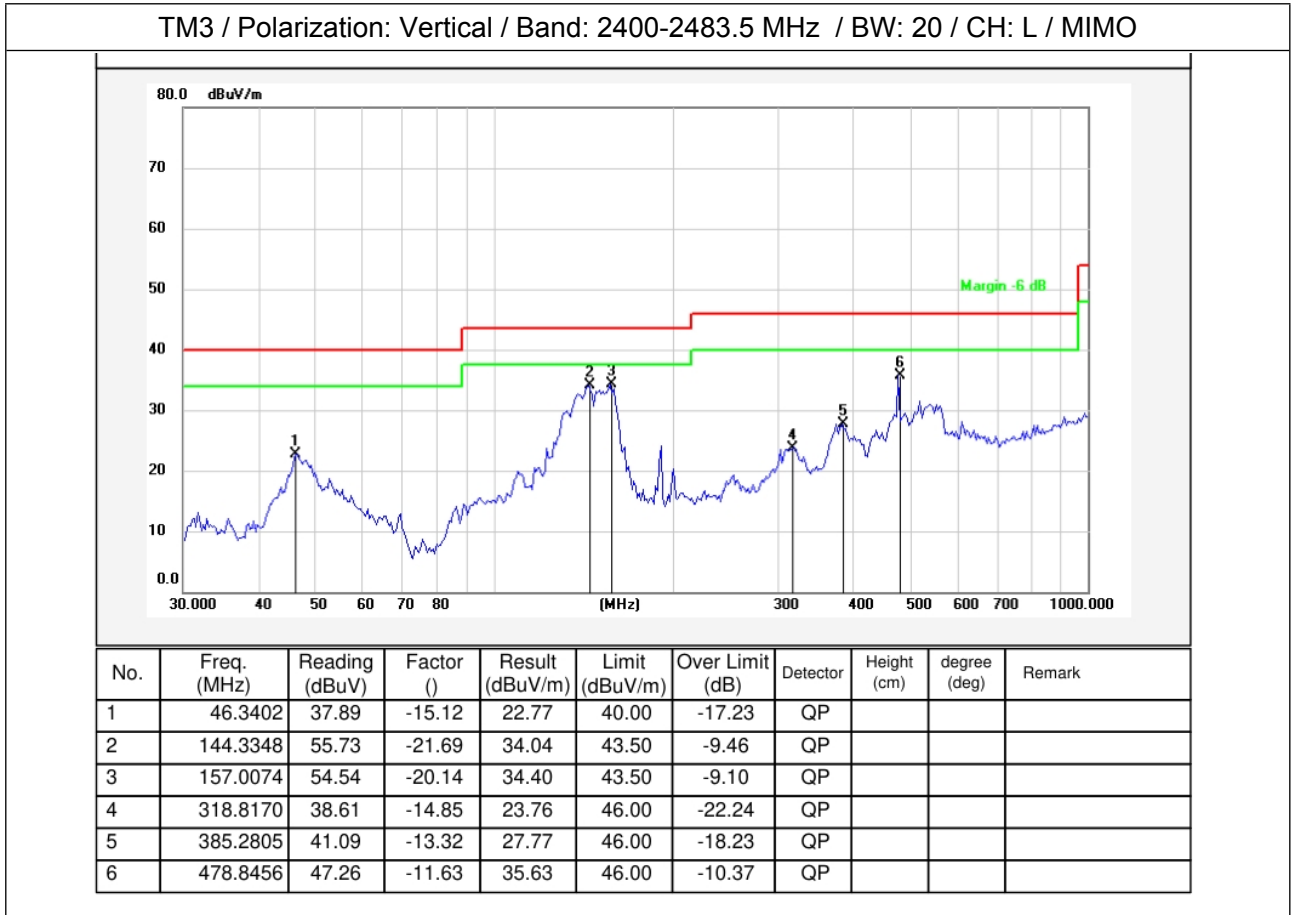

Note: Only record the worst data in the report.

Shenzhen Anbotek Compliance Laboratory Limited

10. Emissions in frequency bands (above 1GHz)

Test Requirement:	In addition, radiated emissions which fall in the restricted bands, as defined in § 15.205(a), must also comply with the radiated emission limits specified in § 15.209(a)(see § 15.205(c)).		
Test Limit:	Frequency (MHz)	Field strength (microvolts/meter)	Measurement distance (meters)
	0.009-0.490	2400/F(kHz)	300
	0.490-1.705	24000/F(kHz)	30
	1.705-30.0	30	30
	30-88	100 **	3
	88-216	150 **	3
	216-960	200 **	3
	Above 960	500	3
	** Except as provided in paragraph (g), fundamental emissions from intentional radiators operating under this section shall not be located in the frequency bands 54-72 MHz, 76-88 MHz, 174-216 MHz or 470-806 MHz. However, operation within these frequency bands is permitted under other sections of this part, e.g., §§ 15.231 and 15.241. In the emission table above, the tighter limit applies at the band edges. The emission limits shown in the above table are based on measurements employing a CISPR quasi-peak detector except for the frequency bands 9–90 kHz, 110–490 kHz and above 1000 MHz. Radiated emission limits in these three bands are based on measurements employing an average detector.		
Test Method:	ANSI C63.10-2020 section 6.6.4 KDB 558074 D01 15.247 Meas Guidance v05r02		
Procedure:	ANSI C63.10-2020 section 6.6.4		

10.1. EUT Operation

Operating Environment:	
Test mode:	<ol style="list-style-type: none"> 1: 802.11b mode: Keep the EUT in 802.11b transmitting mode. 2: 802.11g mode: Keep the EUT in 802.11g transmitting mode. 3: 802.11n(HT20) mode: Keep the EUT in 802.11n(HT20) transmitting mode. 4: 802.11n(HT40) mode: Keep the EUT in 802.11n(HT40) transmitting mode. 5: 802.11ax(HEW20): Keep the EUT in 802.11ax(HEW20) transmitting mode. 6: 802.11ax(HEW40): Keep the EUT in 802.11ax(HEW40) transmitting mode.

10.2. Test Setup

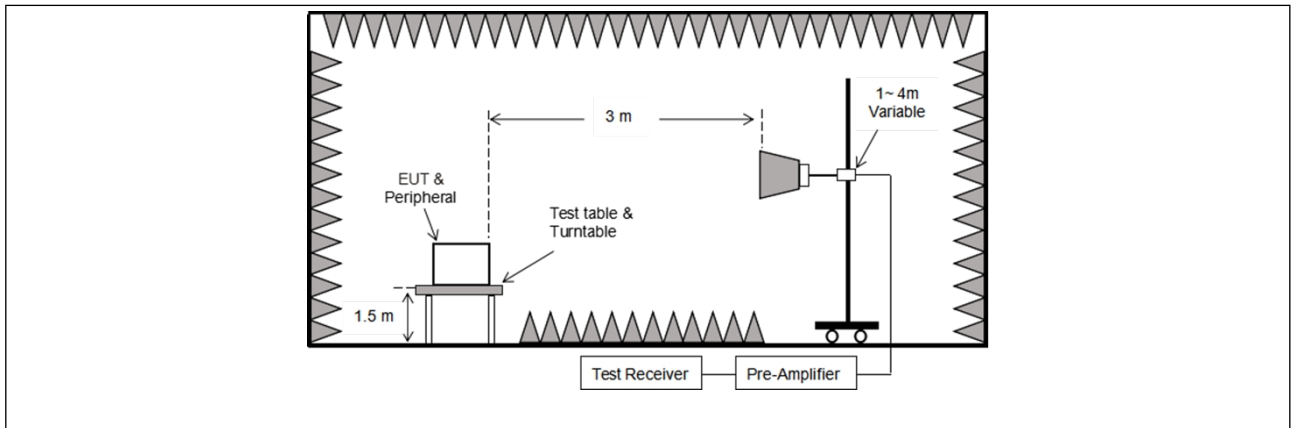

Shenzhen Anbotek Compliance Laboratory Limited

10.3. Test Data

Temperature:	20.5 °C	Humidity:	45 %	Atmospheric Pressure:	101 kPa
--------------	---------	-----------	------	-----------------------	---------

TM3 / CH: L						
Peak value:						
Frequency (MHz)	Reading (dBuV)	Factor (dB/m)	Result (dBuV/m)	Limit (dBuV/m)	Over Limit (dB)	polarization
4824.00	30.33	15.31	45.64	74.00	-28.36	Vertical
7236.00	30.75	18.06	48.81	74.00	-25.19	Vertical
9648.00	32.35	23.77	56.12	74.00	-17.88	Vertical
12060.00	*			74.00		Vertical
14472.00	*			74.00		Vertical
4824.00	30.74	15.31	46.05	74.00	-27.95	Horizontal
7236.00	30.68	18.06	48.74	74.00	-25.26	Horizontal
9648.00	28.60	23.77	52.37	74.00	-21.63	Horizontal
12060.00	*			74.00		Horizontal
14472.00	*			74.00		Horizontal
Average value:						
Frequency (MHz)	Reading (dBuV)	Factor (dB/m)	Result (dBuV/m)	Limit (dBuV/m)	Over Limit (dB)	polarization
4824.00	21.42	15.31	36.73	54.00	-17.27	Vertical
7236.00	21.62	18.06	39.68	54.00	-14.32	Vertical
9648.00	22.60	23.77	46.37	54.00	-7.63	Vertical
12060.00	*			54.00		Vertical
14472.00	*			54.00		Vertical
4824.00	21.29	15.31	36.60	54.00	-17.40	Horizontal
7236.00	21.26	18.06	39.32	54.00	-14.68	Horizontal
9648.00	19.57	23.77	43.34	54.00	-10.66	Horizontal
12060.00	*			54.00		Horizontal
14472.00	*			54.00		Horizontal

Shenzhen Anbotek Compliance Laboratory Limited

TM3 / CH: M						
Peak value:						
Frequency (MHz)	Reading (dBuV)	Factor (dB/m)	Result (dBuV/m)	Limit (dBuV/m)	Over Limit (dB)	polarization
4874.00	31.70	15.41	47.11	74.00	-26.89	Vertical
7311.00	30.94	18.01	48.95	74.00	-25.05	Vertical
9748.00	32.67	23.79	56.46	74.00	-17.54	Vertical
12185.00	*			74.00		Vertical
14622.00	*			74.00		Vertical
4874.00	31.73	15.41	47.14	74.00	-26.86	Horizontal
7311.00	33.25	18.01	51.26	74.00	-22.74	Horizontal
9748.00	32.04	23.79	55.83	74.00	-18.17	Horizontal
12185.00	*			74.00		Horizontal
14622.00	*			74.00		Horizontal
Average value:						
Frequency (MHz)	Reading (dBuV)	Factor (dB/m)	Result (dBuV/m)	Limit (dBuV/m)	Over Limit (dB)	polarization
4874.00	22.40	15.41	37.81	54.00	-16.19	Vertical
7311.00	20.84	18.01	38.85	54.00	-15.15	Vertical
9748.00	23.37	23.79	47.16	54.00	-6.84	Vertical
12185.00	*			54.00		Vertical
14622.00	*			54.00		Vertical
4874.00	21.63	15.41	37.04	54.00	-16.96	Horizontal
7311.00	22.65	18.01	40.66	54.00	-13.34	Horizontal
9748.00	21.94	23.79	45.73	54.00	-8.27	Horizontal
12185.00	*			54.00		Horizontal
14622.00	*			54.00		Horizontal

Shenzhen Anbotek Compliance Laboratory Limited

TM3 / CH: H						
Peak value:						
Frequency (MHz)	Reading (dBuV)	Factor (dB/m)	Result (dBuV/m)	Limit (dBuV/m)	Over Limit (dB)	polarization
4924.00	29.87	15.51	45.38	74.00	-28.62	Vertical
7386.00	30.47	17.97	48.44	74.00	-25.56	Vertical
9848.00	32.64	23.82	56.46	74.00	-17.54	Vertical
12310.00	*			74.00		Vertical
14772.00	*			74.00		Vertical
4924.00	28.93	15.51	44.44	74.00	-29.56	Horizontal
7386.00	30.55	17.97	48.52	74.00	-25.48	Horizontal
9848.00	28.49	23.82	52.31	74.00	-21.69	Horizontal
12310.00	*			74.00		Horizontal
14772.00	*			74.00		Horizontal
Average value:						
Frequency (MHz)	Reading (dBuV)	Factor (dB/m)	Result (dBuV/m)	Limit (dBuV/m)	Over Limit (dB)	polarization
4924.00	20.80	15.51	36.31	54.00	-17.69	Vertical
7386.00	21.39	17.97	39.36	54.00	-14.64	Vertical
9848.00	23.15	23.82	46.97	54.00	-7.03	Vertical
12310.00	*			54.00		Vertical
14772.00	*			54.00		Vertical
4924.00	20.30	15.51	35.81	54.00	-18.19	Horizontal
7386.00	20.95	17.97	38.92	54.00	-15.08	Horizontal
9848.00	19.76	23.82	43.58	54.00	-10.42	Horizontal
12310.00	*			54.00		Horizontal
14772.00	*			54.00		Horizontal

Remark:

1. Result =Reading + Factor
2. Test frequency are from 1GHz to 25GHz, “*” means the test results were attenuated more than 20dB below the permissible limits, so the results don't record in the report.
3. Only the worst case(802.11n(HT20)_MIMO) is recorded in the report.

Shenzhen Anbotek Compliance Laboratory Limited

APPENDIX I -- TEST SETUP PHOTOGRAPH

Please refer to separated files Appendix I -- Test Setup Photograph_RF

APPENDIX II -- EXTERNAL PHOTOGRAPH

Please refer to separated files Appendix II -- External Photograph

APPENDIX III -- INTERNAL PHOTOGRAPH

Please refer to separated files Appendix III -- Internal Photograph

----- End of Report -----