



RF TEST REPORT

Applicant Emerson White-Rodgers

FCC ID 2A4JN-ST765470

Product Sensi Touch 2

Brand Sensi

Model 1F96U-42WFB; 1F96U-42WF; ST76; ST76W; ST76U;
ST76WU; 1F96U-42WFBC; 1F96U-42WFC; ST76C;
ST76WC

Report No. R2211A1116-R2V1

Issue Date January 6, 2023

TA Technology (Shanghai) Co., Ltd. tested the above equipment in accordance with the requirements in **FCC CFR47 Part 15C (2022)**. The test results show that the equipment tested is capable of demonstrating compliance with the requirements as documented in this report.

Prepared by: Xu Ying

Approved by: Xu Kai

TA Technology (Shanghai) Co., Ltd.

Building 3, No.145, Jintang Rd, Pudong Shanghai, P.R.China

TEL: +86-021-50791141/2/3

FAX: +86-021-50791141/2/3-8000



TABLE OF CONTENT

1. Test Laboratory	5
1.1. Notes of the test report.....	5
1.2. Test facility	5
1.3. Testing Location.....	5
2. General Description of Equipment under Test.....	6
2.1. Applicant and Manufacturer Information.....	6
2.2. General information.....	6
3. Applied Standards	8
4. Test Configuration	9
5. Test Case Results	10
5.1. Maximum output power	10
5.2. 99% Bandwidth and 6dB Bandwidth	12
5.3. Band Edge	18
5.4. Power Spectral Density.....	22
5.5. Spurious RF Conducted Emissions.....	27
5.6. Unwanted Emission	33
5.7. Conducted Emission	67
6. Main Test Instruments.....	70
ANNEX A: The EUT Appearance	71
ANNEX B: Test Setup Photos	72
ANNEX C: Product Change Description.....	73



Version	Revision description	Issue Date
Rev.0	Initial issue of report.	January 4, 2023
Rev.1	Update information.	January 6, 2023

Note: This revised report (Report No.: R2211A1116-R2V1) supersedes and replaces the previously issued report (Report No.: R2211A1116-R2). Please discard or destroy the previously issued report and dispose of it accordingly.



Summary of measurement results

Number	Test Case	Clause in FCC rules	Verdict
1	Maximum output power	15.247(b)(3)	PASS
2	6 dB bandwidth	15.247(a)(2)	PASS
3	Power spectral density	15.247(e)	PASS
4	Band Edge	15.247(d)	PASS
5	Spurious RF Conducted Emissions	15.247(d)	PASS
6	Unwanted Emissions	15.247(d),15.205,15.209	PASS
7	Conducted Emissions	15.207	PASS

Date of Testing: December 20, 2021~ January 26, 2022
Date of Sample Received: December 17, 2021

Note: All indications of Pass/Fail in this report are opinions expressed by TA Technology (Shanghai) Co., Ltd. based on interpretations and/or observations of test results. Measurement Uncertainties were not taken into account and are published for informational purposes only.

1F96U-42WFB; 1F96U-42WF; ST76; ST76W; ST76U; ST76WU; 1F96U-42WFBC; 1F96U-42WFC; ST76C; ST76WC (Report No.: R2211A1116-R2V1) is a variant model of 1F96U-42WFB; 1F96U-42WF; ST76; ST76W; ST76U; ST76WU; 1F96U-42WFBC; 1F96U-42WFC; ST76C; ST76WC (Report No.: R2112A1148-R2). This report only changes Antenna Gain/ HW Version/ SW Version Information. There is only tested Unwanted Emission (802.11g and Bluetooth LE) for variant in this report, and did not worsen, so they were not recorded in the report. Power of new variant is varied due to measurement uncertainty, and sample tolerance of the acceptance range.

The detailed product change description please refers to the *Difference Declaration Letter*.



1. Test Laboratory

1.1. Notes of the test report

This report shall not be reproduced in full or partial, without the written approval of **TA technology (shanghai) co., Ltd.** The results documented in this report apply only to the tested sample, under the conditions and modes of operation as described herein .Measurement Uncertainties were not taken into account and are published for informational purposes only. This report is written to support regulatory compliance of the applicable standards stated above.

1.2. Test facility

FCC (Designation number: CN1179, Test Firm Registration Number: 446626)

TA Technology (Shanghai) Co., Ltd. has been listed on the US Federal Communications Commission list of test facilities recognized to perform measurements.

A2LA (Certificate Number: 3857.01)

TA Technology (Shanghai) Co., Ltd. has been listed by American Association for Laboratory Accreditation to perform measurement.

1.3. Testing Location

Company: TA Technology (Shanghai) Co., Ltd.
Address: Building 3, No.145, Jintang Rd, Pudong Shanghai, P.R.China
City: Shanghai
Post code: 201201
Country: P. R. China
Contact: Xu Kai
Telephone: +86-021-50791141/2/3
Fax: +86-021-50791141/2/3-8000
Website: <http://www.ta-shanghai.com>
E-mail: xukai@ta-shanghai.com

2. General Description of Equipment under Test

2.1. Applicant and Manufacturer Information

Applicant	Emerson White-Rodgers
Applicant address	8100 West Florissant Ave St. Louis/United States of America
Manufacturer	Emerson White-Rodgers
Manufacturer address	8100 West Florissant Ave St. Louis/United States of America

2.2. General information

EUT Description	
Model	1F96U-42WFB; 1F96U-42WF; ST76; ST76W; ST76U; ST76WU; 1F96U-42WFBC; 1F96U-42WFC; ST76C; ST76WC
Lab internal SN	R2112A1148/S01
Hardware Version	0059-5470 REV.C
Software Version	0170-1581v02_03.hex
Power Supply	External power supply
Antenna Type	PCB Antenna
Antenna Connector	A permanently attached antenna (meet with the standard FCC Part 15.203 requirement)
Antenna Gain	3.19dBi
additional beamforming gain	NA
Operating Frequency Range(s)	802.11b/g/n(HT20): 2412 ~ 2462 MHz Bluetooth LE V5.0: 2402 ~2480 MHz
Modulation Type	802.11b: DSSS 802.11g/n(HT20): OFDM Bluetooth LE: GFSK
Max. Conducted Power	Wi-Fi 2.4G: 16.96dBm Bluetooth LE: -3.80dBm
<p>Note: 1. The EUT is sent from the applicant to TA and the information of the EUT is declared by the applicant.</p> <p>2. The main test model is ST76 in this report.</p>	



Model Difference Table				
Model Number	Description	Color	Channel	Instructions
1F96U-42WFB	Sensi Touch 2	Black	Pro	English
1F96U-42WF	Sensi Touch 2	White	Pro	English
ST76	Sensi Touch 2	Black	Retail	English
ST76W	Sensi Touch 2	White	Retail	English
ST76U	Sensi Touch 2	Black	Utility	English
ST76WU	Sensi Touch 2	White	Utility	English
1F96U-42WFBC	Sensi Touch 2	Black	Pro	French / English
1F96U-42WFC	Sensi Touch 2	White	Pro	French / English
ST76C	Sensi Touch 2	Black	Retail	French / English
ST76WC	Sensi Touch 2	White	Retail	French / English

Note: The customer declares that the models have the same PCB assembly, the only difference is color, package and sale channels.



3. Applied Standards

According to the specifications of the manufacturer, it must comply with the requirements of the following standards:

Test standards:

FCC CFR47 Part 15C (2022) Radio Frequency Devices

ANSI C63.10-2013

Reference standard:

KDB 558074 D01 15.247 Meas Guidance v05r02

4. Test Configuration

Test Mode

The EUT has been associated with peripherals and configuration operated in a manner tended to maximize its emission characteristics in a typical application.

The radiated emission was measured in the following position: EUT stand-up position (Z axis), lie-down position (X, Y axis). The worst emission was found in lie-down position (X axis) and the loop antenna is vertical, the others are vertical and horizontal. and the worst case was recorded.

In order to find the worst case condition, Pre-tests are needed at the presence of different data rate. Preliminary tests have been done on all the configuration for confirming worst case. Data rate below means worst-case rate of each test item.

Worst-case data rates are shown as following table.

Test Mode	Data Rate
Bluetooth(Low Energy)	1Mbps
802.11b	1 Mbps
802.11g	6 Mbps
802.11n HT20	MCS0

5. Test Case Results

5.1. Maximum output power

Ambient condition

Temperature	Relative humidity	Pressure
23°C ~25°C	45%~50%	101.5kPa

Methods of Measurement

During the process of the testing, The EUT was connected to Power meter with a known loss. The EUT is max power transmission with proper modulation.

Test Setup

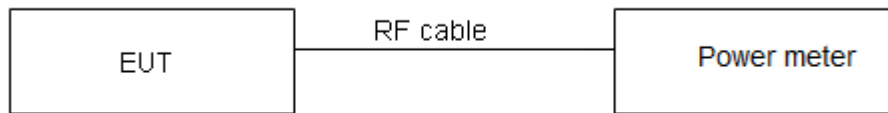

Limits

Rule Part 15.247 (b) (3) specifies that " For systems using digital modulation in the 902–928 MHz, 2400–2483.5 MHz: 1 Watt."

Average Output Power	$\leq 1W$ (30dBm)
----------------------	-------------------

Measurement Uncertainty

The assessed measurement uncertainty to ensure 95% confidence level for the normal distribution is with the coverage factor $k = 2$, $U = 0.44$ dB.

**Test Results**

Test Mode	T _{on} (ms)	T _(on+off) (ms)	Duty cycle	Duty cycle correction Factor(dB)
802.11b	1.00	1.00	1.00	0.00
802.11g	1.00	1.00	1.00	0.00
802.11n HT20	1.00	1.00	1.00	0.00
Bluetooth LE	0.35	1.25	0.280	5.528

Note: when Duty cycle ≥ 0.98 , Duty cycle correction Factor not required.

Test Mode	Carrier frequency (MHz) \ Channel	Average Power Measured (dBm)	Average Power with duty factor (dBm)	Limit (dBm)	Conclusion
802.11b	2412/CH 1	16.96	16.96	30	PASS
	2437/CH 6	14.95	14.95	30	PASS
	2462/CH11	14.68	14.68	30	PASS
802.11g	2412/CH 1	11.08	11.08	30	PASS
	2437/CH 6	14.74	14.74	30	PASS
	2462/CH11	8.10	8.10	30	PASS
802.11n HT20	2412/CH 1	10.99	10.99	30	PASS
	2437/CH 6	13.06	13.06	30	PASS
	2462/CH11	8.00	8.00	30	PASS
Bluetooth (Low Energy)	2402/CH0	-9.36	-3.83	30	PASS
	2440/CH19	-9.33	-3.80	30	PASS
	2480/CH39	-9.36	-3.83	30	PASS

Note: Average Power with duty factor = Average Power Measured +Duty cycle correction factor

5.2. 99% Bandwidth and 6dB Bandwidth

Ambient condition

Temperature	Relative humidity	Pressure
23°C ~25°C	45%~50%	101.5kPa

Method of Measurement

The EUT was connected to the spectrum analyzer through an external attenuator (20dB) and a known loss cable. RBW is set to 100 kHz; VBW is set to 300 kHz on spectrum analyzer. Dector=Peak, Trace mode=max hold.

The EUT was connected to the spectrum analyzer through a known loss cable. The resolution bandwidth (RBW) shall be in the range of 1% to 5% of the actual occupied / x dB bandwidth and the video bandwidth (VBW) shall not be smaller than three times the RBW value.

Test Setup

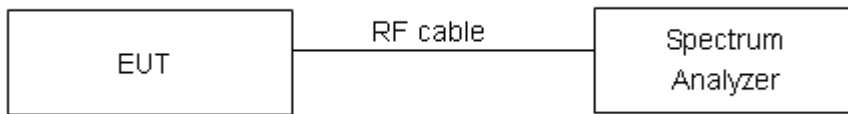

Limits

Rule Part 15.247 (a) (2) specifies that “Systems using digital modulation techniques may operate in the 902–928 MHz, 2400–2483.5 MHz bands. The minimum 6 dB bandwidth shall be at least 500 kHz.”

minimum 6 dB bandwidth	≥ 500 kHz
------------------------	-----------

Measurement Uncertainty

The assessed measurement uncertainty to ensure 95% confidence level for the normal distribution is with the coverage factor $k = 2$, $U = 936$ Hz.

Test Results:

Test Mode	Carrier frequency (MHz)	99% bandwidth (MHz)	Minimum 6 dB bandwidth (MHz)	Limit (kHz)	Conclusion
802.11b	2412	13.985	9.018	500	PASS
	2437	13.938	7.599	500	PASS
	2462	13.957	9.001	500	PASS
802.11g	2412	16.627	16.550	500	PASS
	2437	16.704	16.580	500	PASS
	2462	16.634	16.560	500	PASS
802.11n HT20	2412	17.698	17.780	500	PASS
	2437	17.708	17.720	500	PASS
	2462	17.699	17.780	500	PASS
Bluetooth (Low Energy)	2402	1.198	0.711	500	PASS
	2440	1.329	0.720	500	PASS
	2480	1.339	0.670	500	PASS



99%bandwidth

802.11b, Carrier frequency (MHz): 2412



802.11g, Carrier frequency (MHz): 2412



802.11b, Carrier frequency (MHz): 2437



802.11g, Carrier frequency (MHz): 2437



802.11b, Carrier frequency (MHz):2462



802.11g, Carrier frequency (MHz):2462





802.11n(HT20), Carrier frequency (MHz): 2412



Bluetooth LE Carrier frequency (MHz): 2402

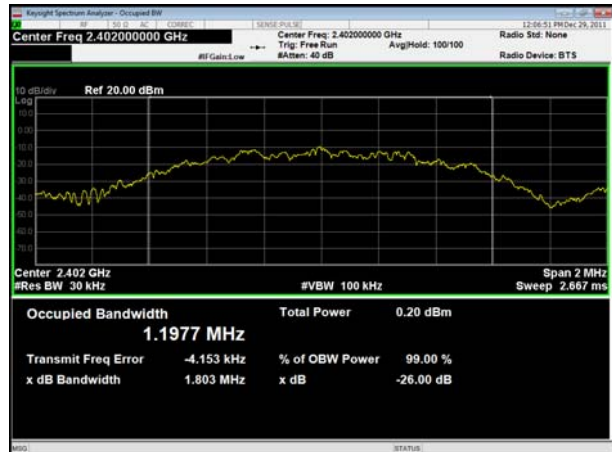

802.11n(HT20), Carrier frequency (MHz): 2437

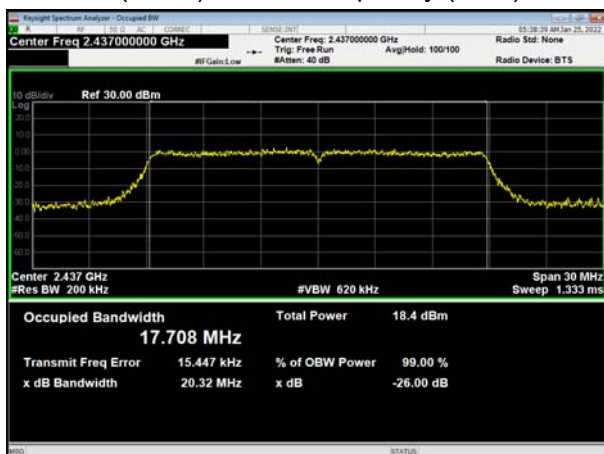

Bluetooth LE Carrier frequency (MHz): 2440



802.11n(HT20), Carrier frequency (MHz):2462



Bluetooth LE Carrier frequency (MHz): 2480





6 dB bandwidth

802.11b, Carrier frequency (MHz): 2412



802.11g, Carrier frequency (MHz): 2412



802.11b, Carrier frequency (MHz): 2437



802.11g, Carrier frequency (MHz): 2437



802.11b, Carrier frequency (MHz): 2462



802.11g, Carrier frequency (MHz): 2462



802.11n(HT20), Carrier frequency (MHz): 2412



Bluetooth LE Carrier frequency (MHz): 2402



802.11n(HT20), Carrier frequency (MHz): 2437



Bluetooth LE Carrier frequency (MHz): 2440



802.11n(HT20), Carrier frequency (MHz):2462



Bluetooth LE Carrier frequency (MHz): 2480



5.3. Band Edge

Ambient condition

Temperature	Relative humidity	Pressure
23°C ~25°C	45%~50%	101.5kPa

Method of Measurement

The EUT was connected to the spectrum analyzer through an external attenuator (20dB) and a known loss cable the band edge of the lowest and highest channels were measured. The peak detector is used and RBW is set to 100 kHz and VBW is set to 300 kHz on spectrum analyzer. Spectrum analyzer plots are included on the following pages.

Test Setup

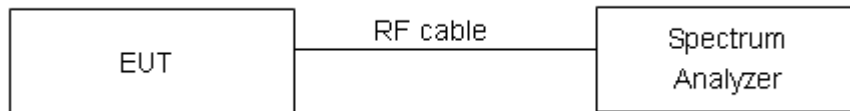

Limits

Rule Part 15.247(d) specifies that “In any 100 kHz bandwidth outside the frequency band in which the spread spectrum or digitally modulated intentional radiator is operating, the radio frequency power that is produced by the intentional radiator shall be at least 20 dB below that in the 100 kHz bandwidth within the band that contains the highest level of the desired power, based on either an RF conducted or a radiated measurement, provided the transmitter demonstrates compliance with the peak conducted power limits.” If the transmitter complies with the conducted power limits based on the use of RMS averaging over a time interval, as permitted under paragraph (b)(3) of this section, the attenuation required under this paragraph shall be 30 dB instead of 20 dB.”

Measurement Uncertainty

The assessed measurement uncertainty to ensure 95% confidence level for the normal distribution is with the coverage factor $k = 1.96$.

Frequency	Uncertainty
2GHz-3GHz	1.407 dB



Test Results: PASS

802.11b, Channel No.: 1

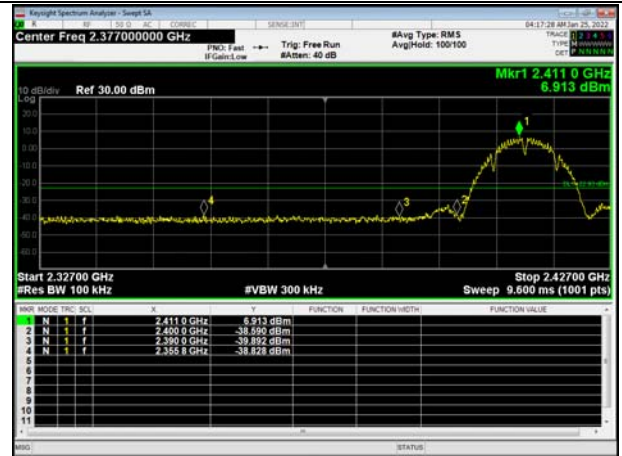

802.11b, Channel No.: 11

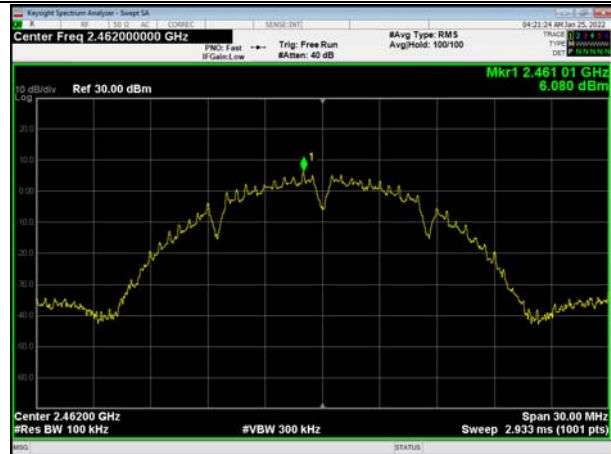

802.11g, Channel No.: 1

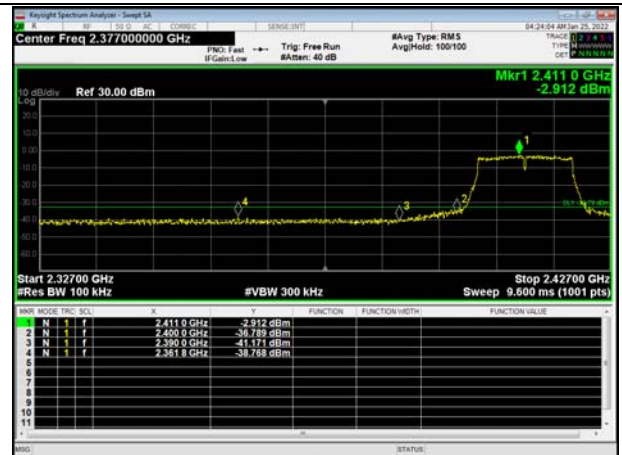



802.11g, Channel No.: 11

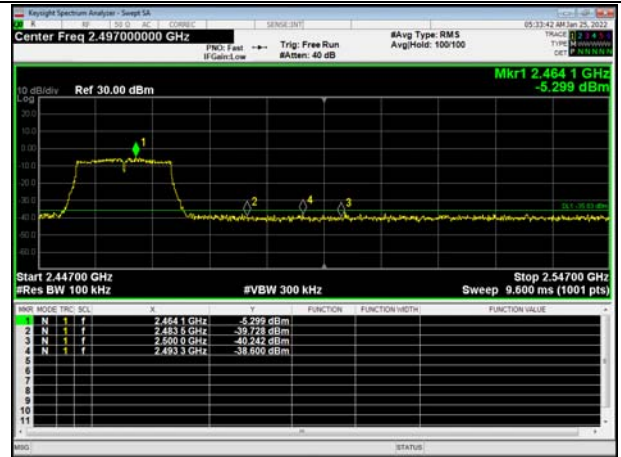

802.11n(HT20), Channel No. 1

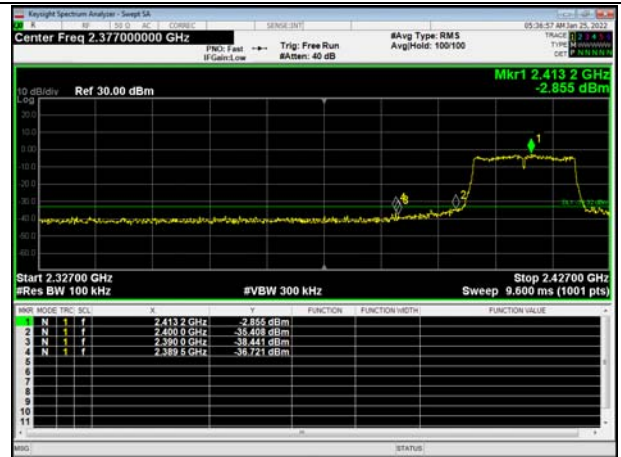

802.11n(HT20), Channel No. 11

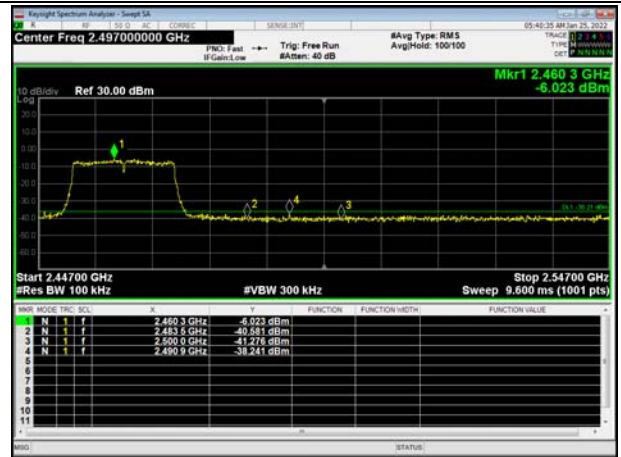
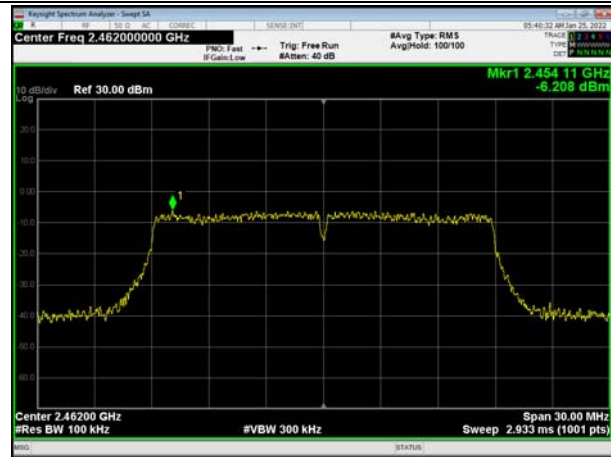



Bluetooth LE, Channel No.: 0

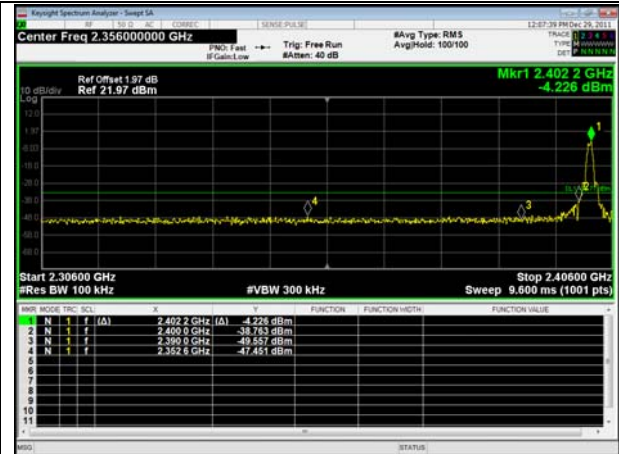
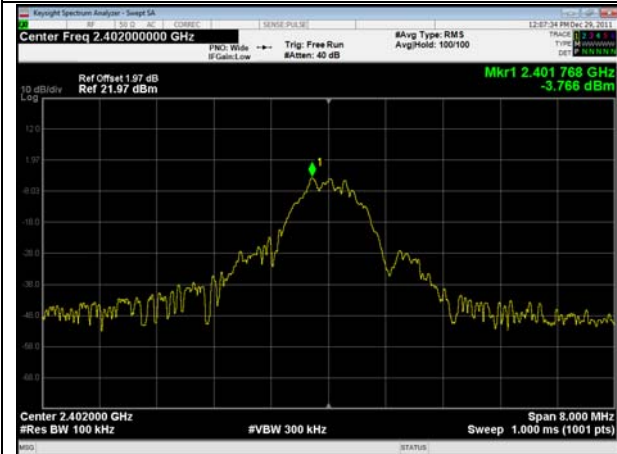

Bluetooth LE, Channel No.: 39

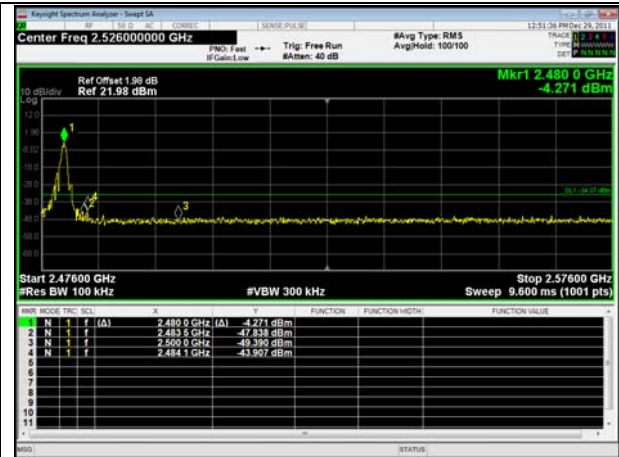
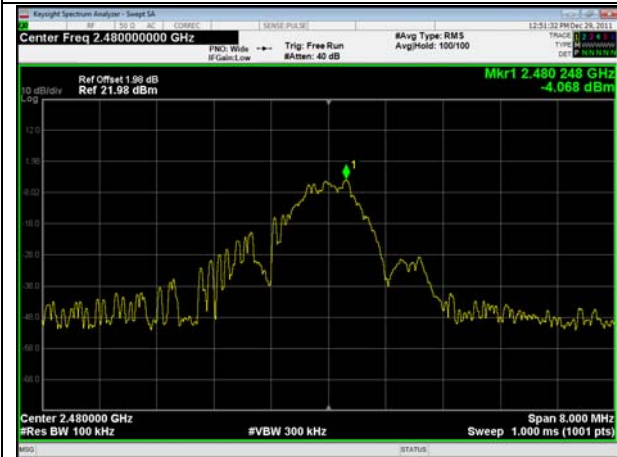

5.4. Power Spectral Density

Ambient condition

Temperature	Relative humidity	Pressure
23°C ~25°C	45%~50%	101.5kPa

Method of Measurement

During the process of the testing, The EUT was connected to Spectrum Analyzer with a known loss. The EUT is max power transmission with proper modulation.

Method AVGPSD-1 was used for this test.

- a) Set instrument center frequency to DTS channel center frequency
- b) Set span to at least 1.5 times the OBW
- c) Set RBW to: $3\text{kHz} \leq \text{RBW} \leq 100\text{kHz}$
- d) Set VBW $\geq [3 \times \text{RBW}]$
- e) Detector=power averaging (rms) or sample detector (when rms not available)
- f) Ensure that the number of measurement points in the sweep $2[2 \times \text{span}/\text{RBWT}]$
- g) Sweep time auto couple
- h) Employ trace averaging (rms) mode over a minimum of 100 traces
- i) Use the peak marker function to determine the maximum amplitude level.
- j) If the measured value exceeds requirement, then reduce RBW (but no less than 3 kHz) and repeat (note that this may require zooming in on the emission of interest and reducing the span to meet the minimum measurement point requirement as the RBW is reduced)

Method AVGPSD-2 was used for this test.

- a) Measure the duty cycle (D)of the transmitter output signal as described in 11.6
- b) Set instrument center frequency to DTS channel center frequency
- c) Set span to at least 1.5 times the OBW
- d) Set RBW to: $3\text{kHz} \leq \text{RBW} \leq 100\text{Kh}$
- e) Set VBW $\geq [3 \times \text{RBW}]$
- f) Detector= power averaging (rms) or sample detector (when rms not available)
- g) Ensure that the number of measurement points in the sweep $2[2 \times \text{span}/\text{RBW}]$
- h) Sweep time =auto couple
- i) Do not use sweep triggering; allow sweep to "free run"
- j) Employ trace averaging (rms) mode over a minimum of 100 traces
- k) Use the peak marker function to determine the maximum amplitude level

l) Add $[10 \log(1/ D)]$, where D is the duty cycle measured in step a), to the measured PSD to compute the average PSD during the actual transmission time

m) If measured value exceeds requirement specified by regulatory agency then reduce RBW (but no less than 3 kHz) and repeat (note that this may require zooming in on the emission of interest and reducing the span to meet the minimum measurement point requirement as the RBW is reduced)

Test setup

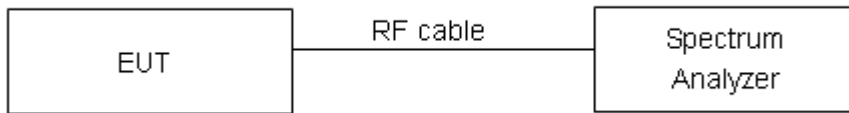

Limits

Rule Part 15.247(e) specifies that” For digitally modulated systems, the power spectral density conducted from the intentional radiator to the antenna shall not be greater than 8 dBm in any 3 kHz band during any time interval of continuous transmission. ”

Limits	$\leq 8 \text{ dBm} / 3\text{kHz}$
--------	------------------------------------

Measurement Uncertainty

The assessed measurement uncertainty to ensure 95% confidence level for the normal distribution is with the coverage factor $k = 2$, $U= 0.75\text{dB}$.

Test Results:

Test Mode	Channel Number	Read Value (dBm / 30kHz)	Power Spectral Density (dBm / 3kHz)	Limit (dBm / 3kHz)	Conclusion
802.11b	1	-5.68	-15.68	8	PASS
	6	-7.10	-17.10	8	PASS
	11	-7.53	-17.53	8	PASS
802.11g	1	-13.23	-23.23	8	PASS
	6	-9.70	-19.70	8	PASS
	11	-16.76	-26.76	8	PASS
802.11n HT20	1	-14.08	-24.08	8	PASS
	6	-11.95	-21.95	8	PASS
	11	-16.78	-26.78	8	PASS

Note: Power Spectral Density =Read Value+Duty cycle correction factor + 10*LOG10(3 kHz / Measured RBW)

Test Mode	Channel Number	Read Value (dBm / 3kHz)	Power Spectral Density (dBm / 3kHz)	Limit (dBm / 3kHz)	Conclusion
Bluetooth (Low Energy)	0	-25.595	-20.07	8	PASS
	19	-26.325	-20.80	8	PASS
	39	-25.399	-19.87	8	PASS

Note: Power Spectral Density =Read Value+Duty cycle correction factor

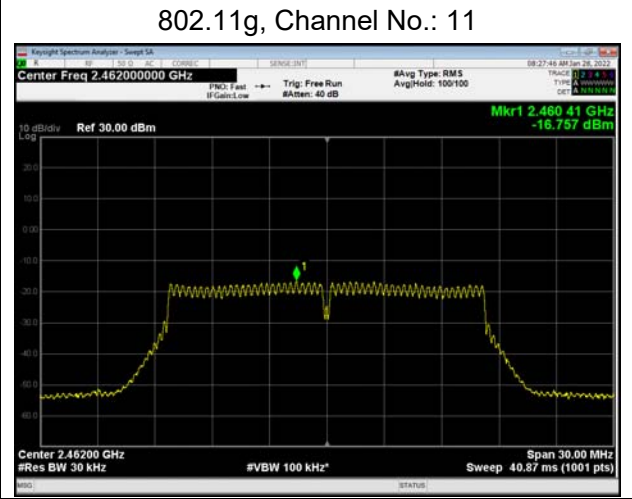
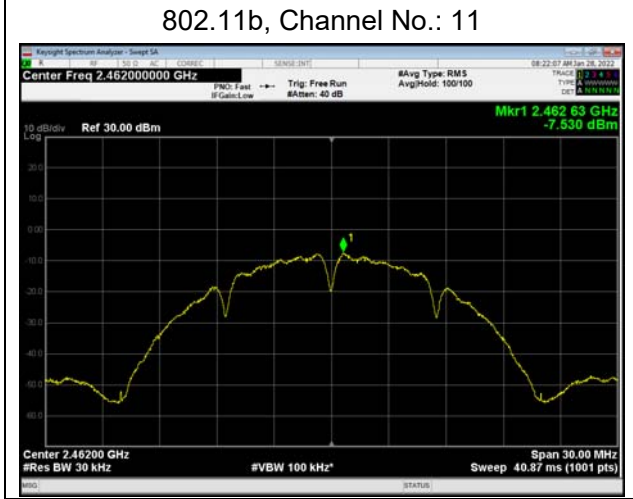
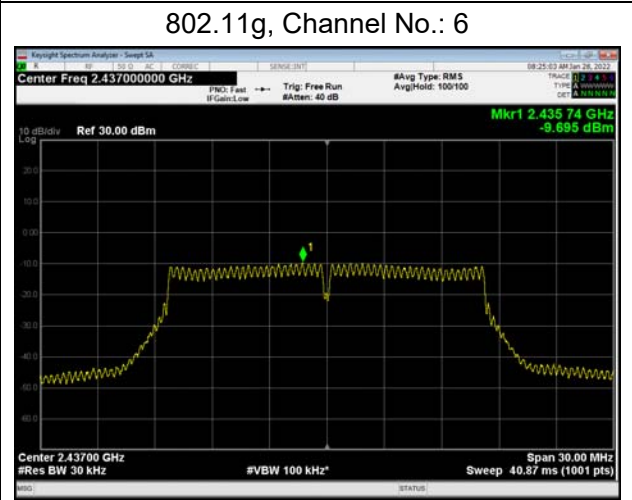
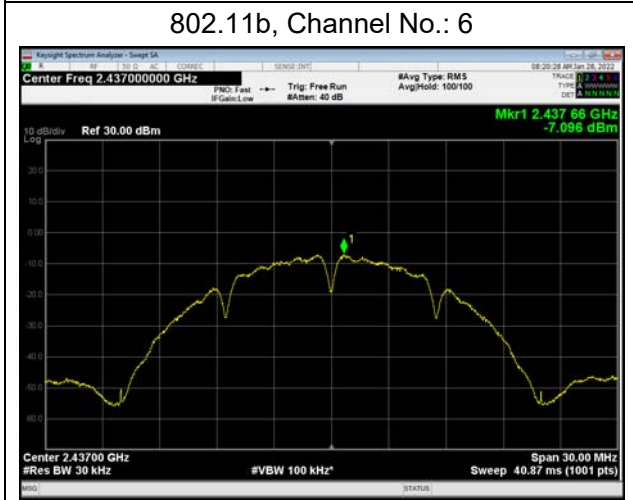
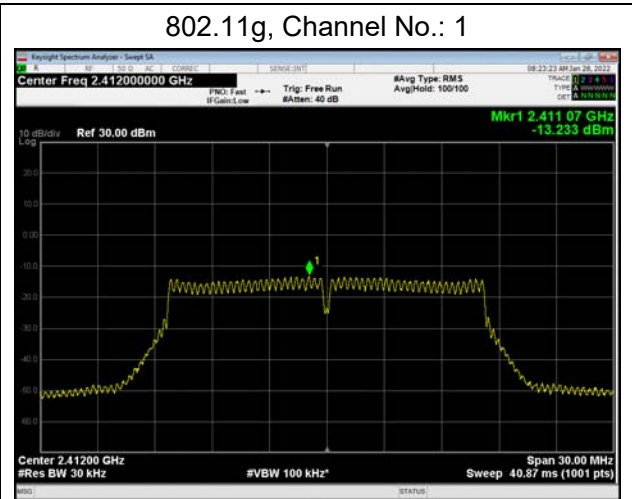
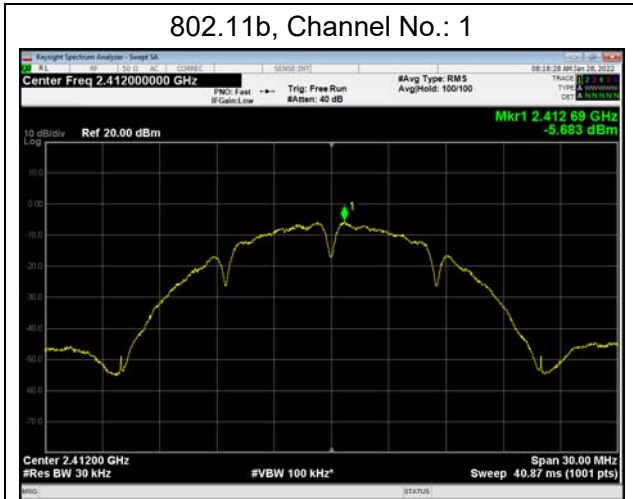



802.11n(HT20), Channel No. 1

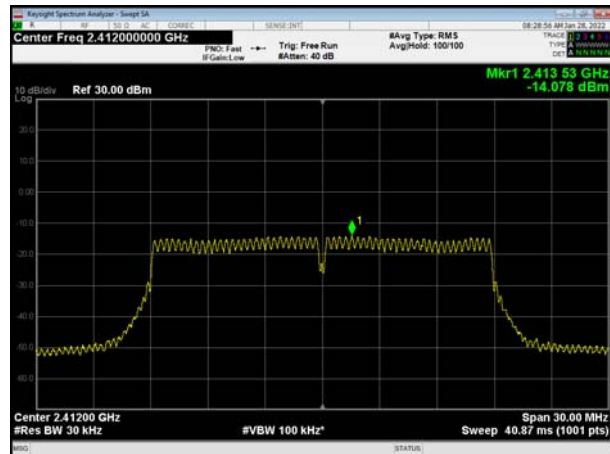

Bluetooth LE (1M), Channel No.: 0

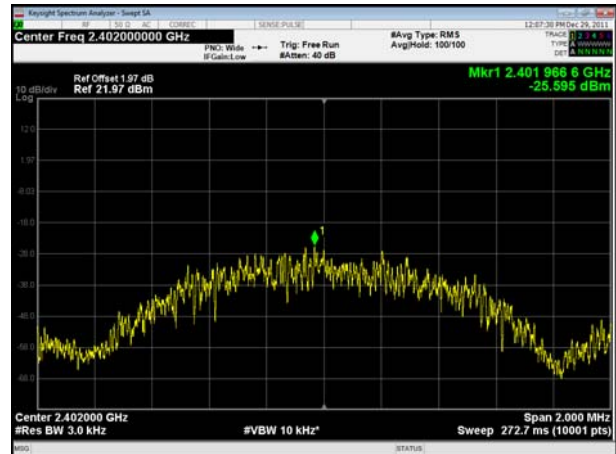

802.11n(HT20), Channel No. 6

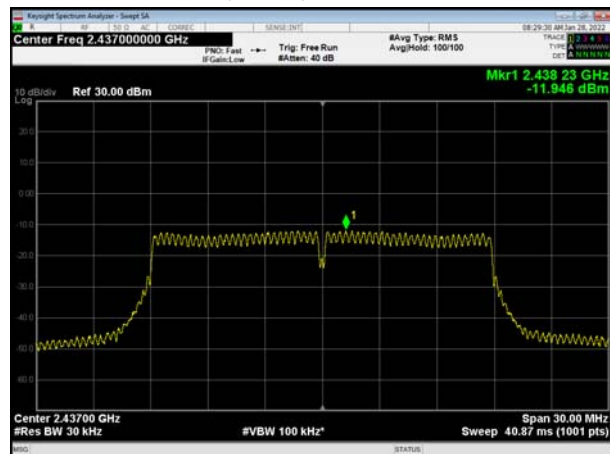

Bluetooth LE (1M), Channel No.: 19

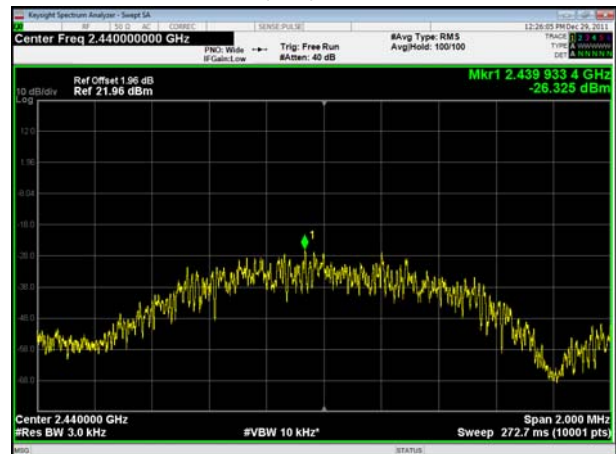

802.11n(HT20), Channel No. 11

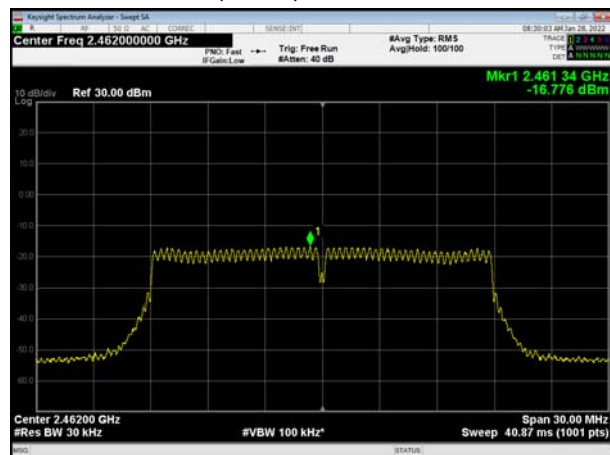

Bluetooth LE (1M), Channel No.: 39

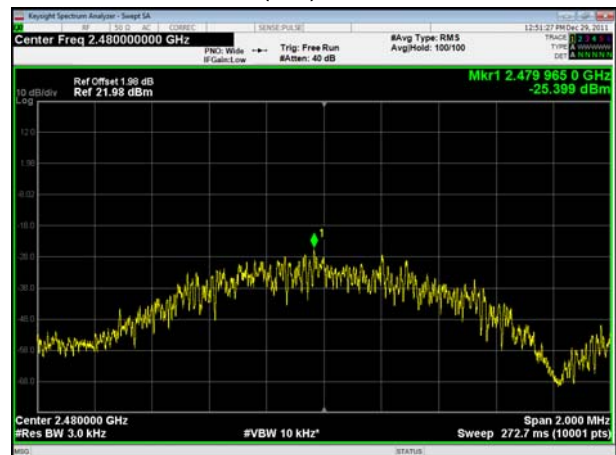

5.5. Spurious RF Conducted Emissions

Ambient condition

Temperature	Relative humidity	Pressure
23°C ~25°C	45%~50%	101.5kPa

Method of Measurement

The EUT was connected to the spectrum analyzer with a known loss. The spectrum analyzer scans from 30MHz to the 10th harmonic of the carrier. The peak detector is used. Set RBW to 100 kHz and VBW to 300 kHz, Sweep is set to ATUO.

The test is in transmitting mode.

Test setup



Limits

Rule Part 15.247(d) pacifies that “In any 100 kHz bandwidth outside the frequency band in which the spread spectrum or digitally modulated intentional radiator is operating, the radio frequency power that is produced by the intentional radiator shall be at least 20 dB below that in the 100 kHz bandwidth within the band that contains the highest level of the desired power, based on either an RF conducted or a radiated measurement, provided the transmitter demonstrates compliance with the peak conducted power limits. If the transmitter complies with the conducted power limits based on the use of RMS averaging over a time interval, as permitted under paragraph (b)(3) of this section, the attenuation required under this paragraph shall be 30 dB instead of 20 dB. ”

Test Mode	Carrier frequency (MHz)	Reference value (dBm)	Limit
802.11b	2412	6.41	-23.59
	2437	5.96	-24.04
	2462	6.29	-23.71
802.11g	2412	-2.66	-32.66
	2437	0.27	-29.73
	2462	-5.61	-35.61
802.11n HT20	2412	-3.33	-33.33
	2437	-0.94	-30.94
	2462	-6.03	-36.03
Bluetooth (Low Energy)	2402	-3.50	-33.50
	2440	-3.62	-33.62
	2480	-3.74	-33.74



Measurement Uncertainty

The assessed measurement uncertainty to ensure 95% confidence level for the normal distribution is with the coverage factor $k = 1.96$.

Frequency	Uncertainty
100kHz-2GHz	0.684 dB
2GHz-26GHz	1.407 dB



Test Results:

802.11b, Channel No.: 1

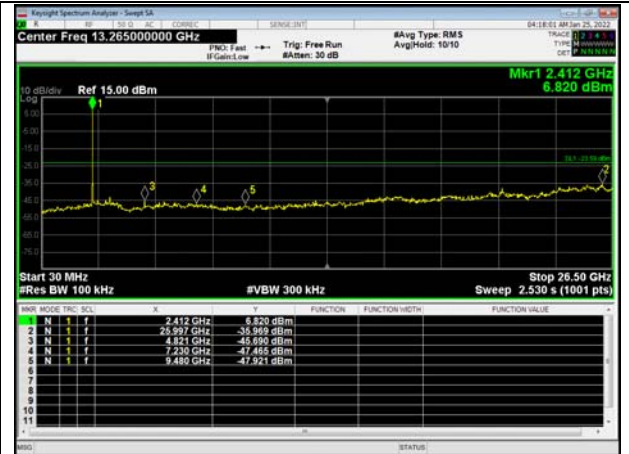

802.11b, Channel No.: 6

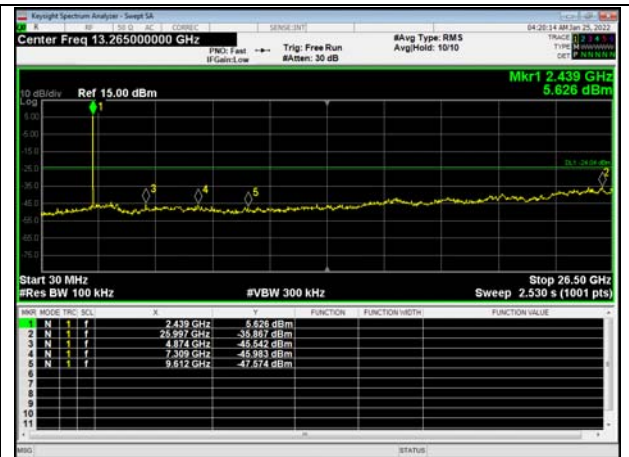
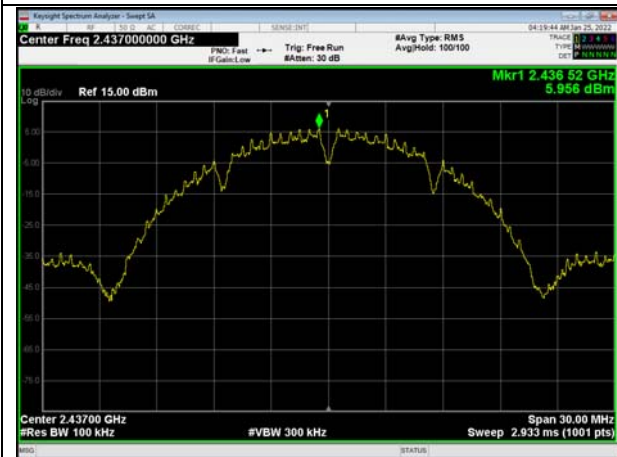

802.11b, Channel No.: 11

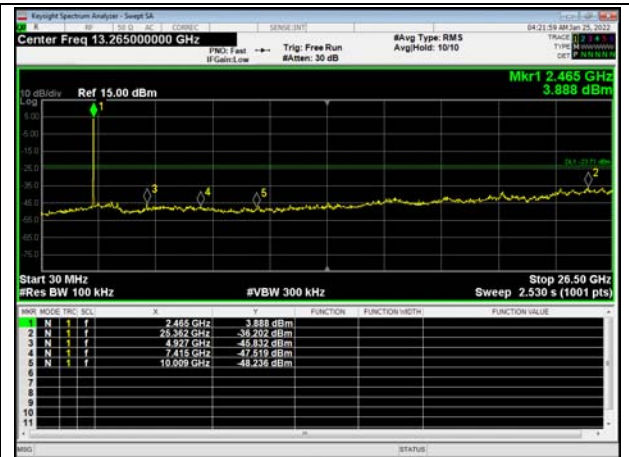



802.11g, Channel No.: 1

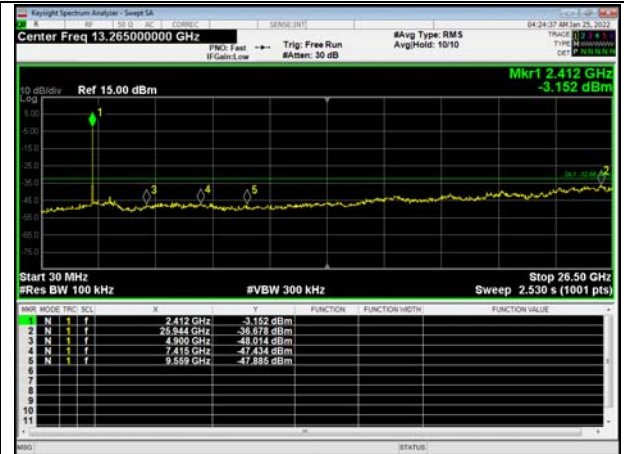
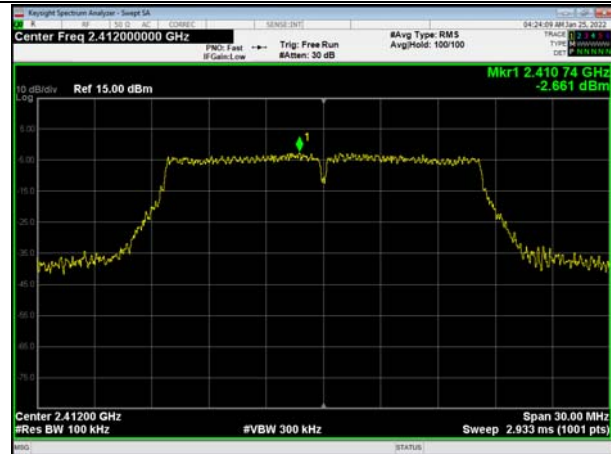

802.11g, Channel No.: 6

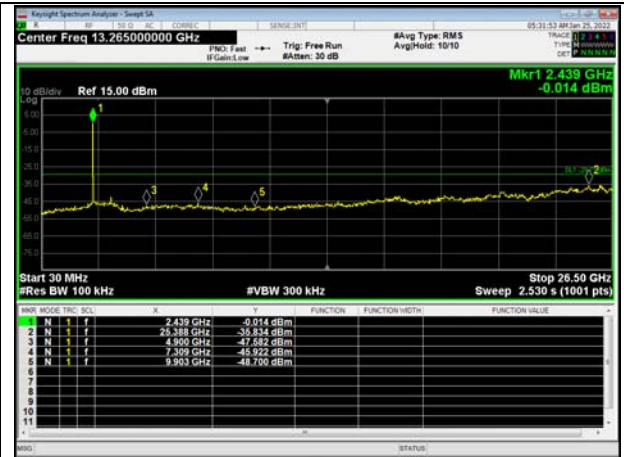

802.11g, Channel No.: 11

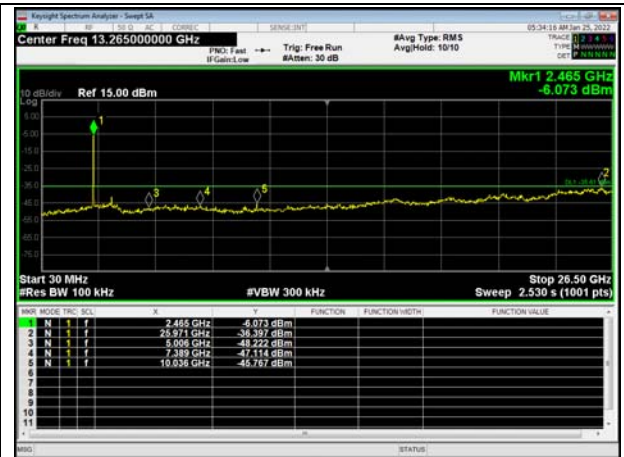



802.11n(HT20), Channel No. 1

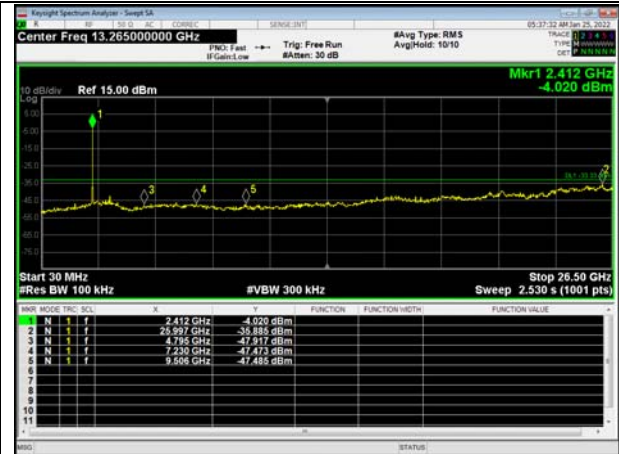

802.11n(HT20), Channel No. 6

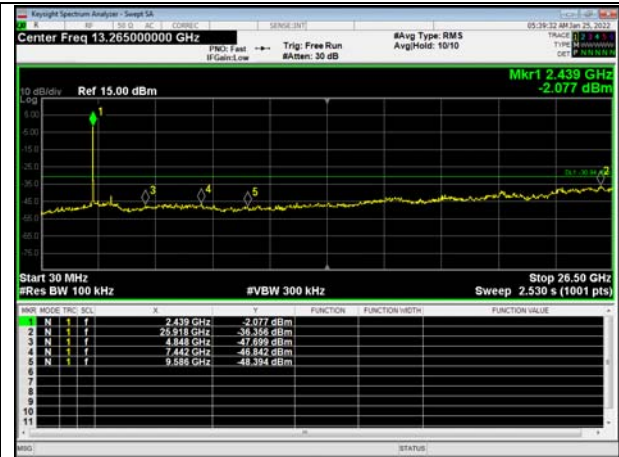

802.11n(HT20), Channel No. 11

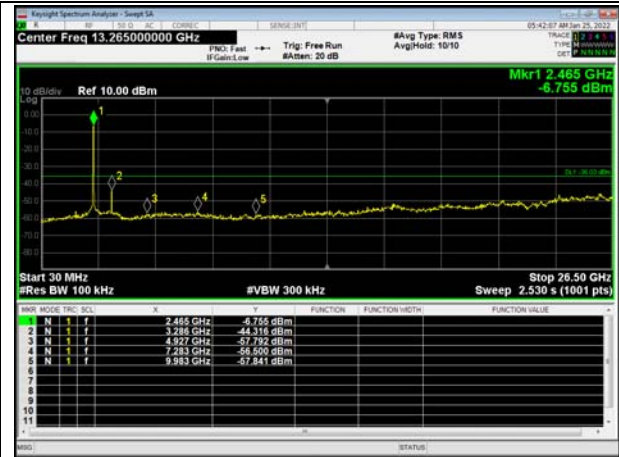



Bluetooth LE, Channel No.: 0

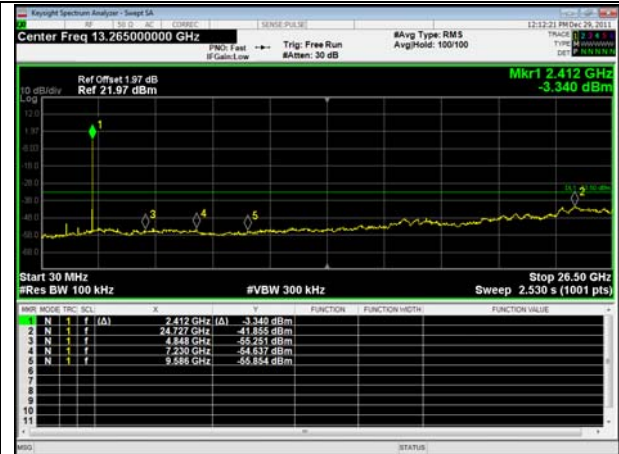

Bluetooth LE, Channel No.: 19

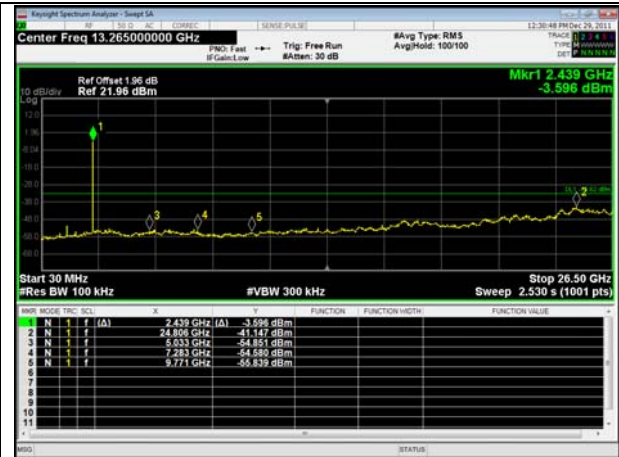

Bluetooth LE, Channel No.: 39

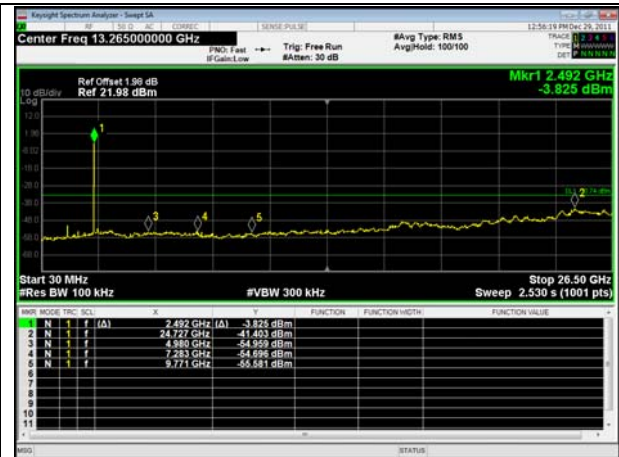
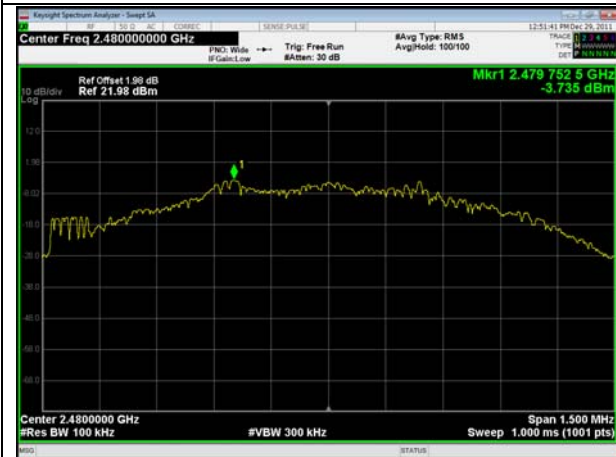

5.6. Unwanted Emission

Ambient condition

Temperature	Relative humidity	Pressure
23°C ~25°C	45%~50%	102.5kPa

Method of Measurement

The test set-up was made in accordance to the general provisions of ANSI C63.10.

The Equipment Under Test (EUT) was set up on a non-conductive table in the semi-anechoic chamber. The test was performed at the distance of 3 m between the EUT and the receiving antenna.

The turntable shall be rotated from 0 to 360 degrees for detecting the maximum of radiated spurious signal level. The measurements shall be repeated with orthogonal polarization of the test antenna. The data of cable loss and antenna factor has been calibrated in full testing frequency range before the testing. Sweep the Restricted Band and the emissions less than 20 dB below the permissible value are reported.

The radiated emissions measurements were made in a typical installation configuration.

Sweep the whole frequency band through the range from 9 kHz to the 10th harmonic of the carrier, and the emissions less than 20 dB below the permissible value are reported.

This method refer to ANSI C63.10.

The procedure for peak unwanted emissions measurements above 1000 MHz is as follows:

Set the spectrum analyzer in the following:

9kHz~150 kHz

RBW=200Hz, VBW=1kHz/ Sweep=AUTO

150 kHz~30MHz

RBW=9KHz, VBW=30KHz,/ Sweep=AUTO

Below 1GHz

RBW=100kHz / VBW=300kHz / Sweep=AUTO

a) Peak emission levels are measured by setting the instrument as follows:

Above 1GHz

PEAK: RBW=1MHz VBW=3MHz/ Sweep=AUTO

b) Average emission levels are measured by setting the instrument as follows:

Above 1GHz

AVERAGE: RBW=1MHz / VBW=3MHz / Sweep=AUTO

c) Detector: The measurements employing a CISPR quasi-peak detector except for the frequency bands 9-90 kHz, 110-490 kHz and above 1000 MHz. Radiated emission limits in these three bands are based on measurements employing an average detector.

d) Averaging type = power (i.e., rms) (As an alternative, the detector and averaging type may be set for linear voltage averaging. Some instruments require linear display mode to use linear voltage



averaging. Log or dB averaging shall not be used.)

e) Sweep time = auto.

f) Perform a trace average of at least 100 traces if the transmission is continuous. If the transmission is not continuous, then the number of traces shall be increased by a factor of $1 / D$, where D is the duty cycle. For example, with 50% duty cycle, at least 200 traces shall be averaged. (If a specific emission is demonstrated to be continuous—i.e., 100% duty cycle—then rather than turning ON and OFF with the transmit cycle, at least 100 traces shall be averaged.)

g) If tests are performed with the EUT transmitting at a duty cycle less than 98%, then a correction factor shall be added to the measurement results prior to comparing with the emission limit, to compute the emission level that would have been measured had the test been performed at 100% duty cycle. The correction factor is computed as follows:

1) If power averaging (rms) mode was used in the preceding step e), then the correction factor is $[10 \log (1 / D)]$, where D is the duty cycle. For example, if the transmit duty cycle was 50%, then 3 dB shall be added to the measured emission levels.

2) If linear voltage averaging mode was used in the preceding step e), then the correction factor is $[20 \log (1 / D)]$, where D is the duty cycle. For example, if the transmit duty cycle was 50%, then 6 dB shall be added to the measured emission levels.

3) If a specific emission is demonstrated to be continuous (100% duty cycle) rather than turning ON and OFF with the transmit cycle, then no duty cycle correction is required for that emission.

The test is in transmitting mode.

Test setup

9KHz ~ 30MHz

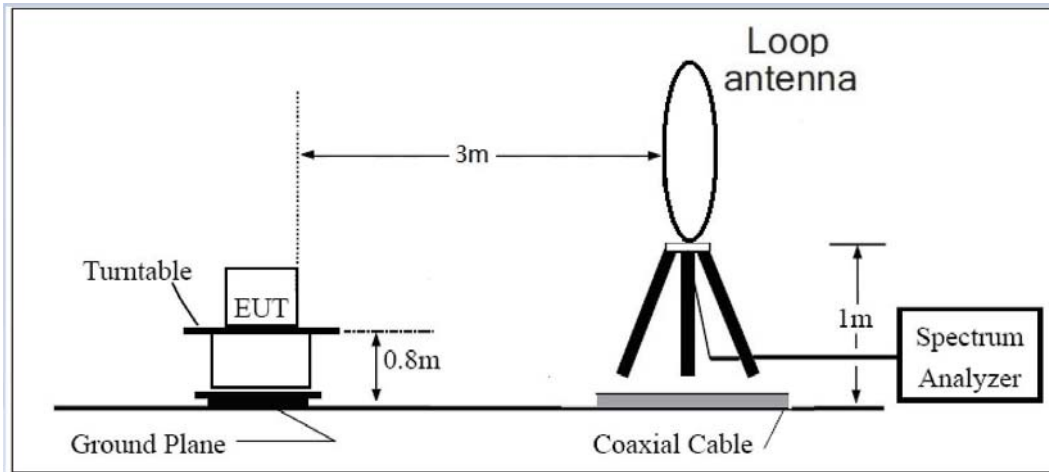

30MHz ~ 1GHz

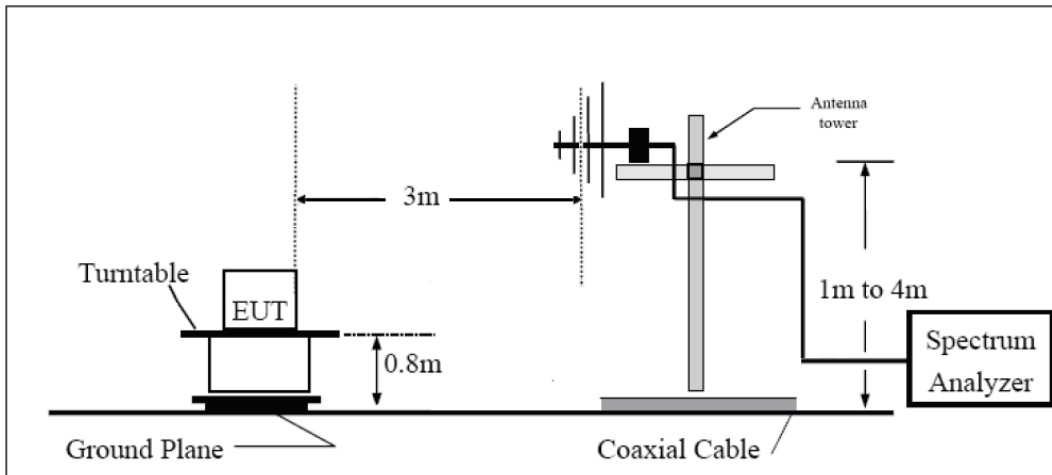

Above 1GHz

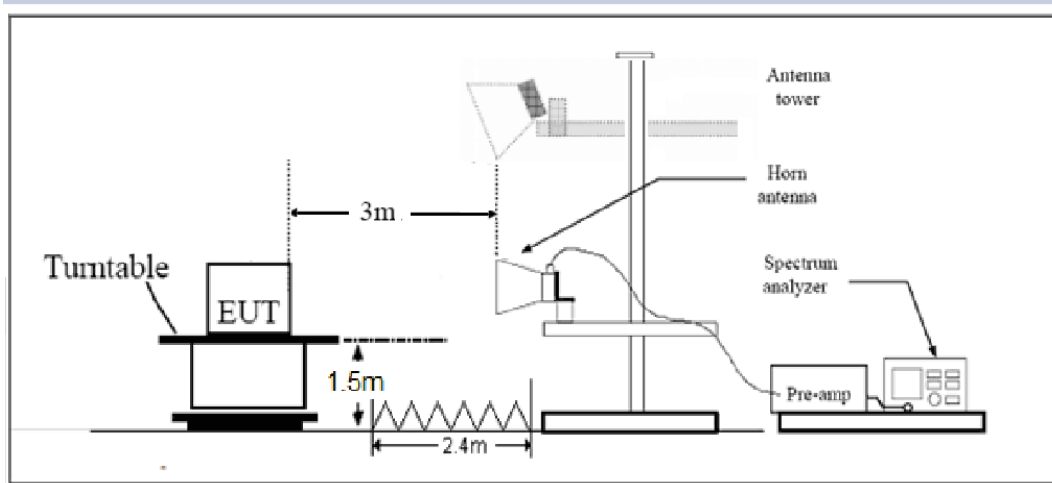

Note: Area side:2.4mX3.6m

**Limits**

Rule Part 15.247(d) specifies that “In addition, radiated emissions which fall in the restricted bands, as defined in § 15.205(a), must also comply with the radiated emission limits specified in § 15.209(a) (see § 15.205(c)).”

Limit in restricted band

Frequency of emission (MHz)	Field strength(uV/m)	Field strength(dBuV/m)
0.009–0.490	2400/F(kHz)	/
0.490–1.705	24000/F(kHz)	/
1.705–30.0	30	/
30-88	100	40
88-216	150	43.5
216-960	200	46
Above960	500	54

§15.35(b)

There is also a limit on the radio frequency emissions, as measured using instrumentation with a peak detector function, corresponding to 20 dB above the maximum permitted average limit.

Peak Limit=74 dBuV/m

Average Limit=54 dBuV/m



Spurious Radiated Emissions are permitted in any of the frequency bands listed below:

MHz	MHz	MHz	GHz
0.090-0.110	16.42-16.423	399.9-410	4.5-5.15
¹ 0.495-0.505	16.69475-16.69525	608-614	5.35-5.46
2.1735-2.1905	16.80425-16.80475	960-1240	7.25-7.75
4.125-4.128	25.5-25.67	1300-1427	8.025-8.5
4.17725-4.17775	37.5-38.25	1435-1626.5	9.0-9.2
4.20725-4.20775	73-74.6	1645.5-1646.5	9.3-9.5
6.215-6.218	74.8-75.2	1660-1710	10.6-12.7
6.26775-6.26825	108-121.94	1718.8-1722.2	13.25-13.4
6.31175-6.31225	123-138	2200-2300	14.47-14.5
8.291-8.294	149.9-150.05	2310-2390	15.35-16.2
8.362-8.366	156.52475-156.52525	2483.5-2500	17.7-21.4
8.37625-8.38675	156.7-156.9	2690-2900	22.01-23.12
8.41425-8.41475	162.0125-167.17	3260-3267	23.6-24.0
12.29-12.293	167.72-173.2	3332-3339	31.2-31.8
12.51975-12.52025	240-285	3345.8-3358	36.43-36.5
12.57675-12.57725	322-335.4	3600-4400	(²)
13.36-13.41			

Measurement Uncertainty

The assessed measurement uncertainty to ensure 95% confidence level for the normal distribution is with the coverage factor $k = 1.96$.

Frequency	Uncertainty
9KHz-30MHz	3.55 dB
30MHz-200MHz	4.17 dB
200MHz-1GHz	4.84 dB
1-18GHz	4.35 dB
18-26.5GHz	5.90 dB
26.5GHz~40GHz	5.92 dB



Test Results:

A font (Level in dB μ V/m) in the test plot = (level in dB μ V/m)

A font (Level in dB V/) in the test plot = (level in dB μ V/m)

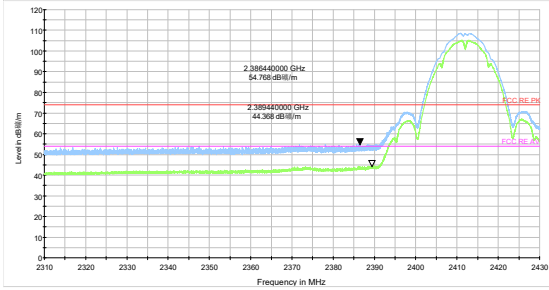

802.11b-Channel 1 Peak+ Average

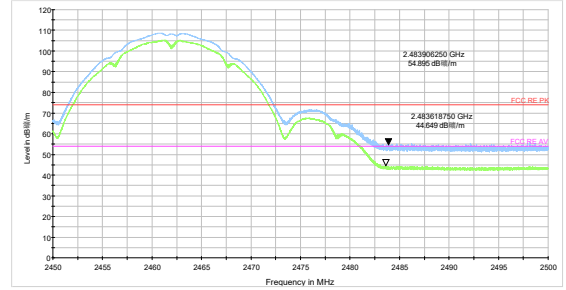

802.11b-Channel 11 Peak+ Average

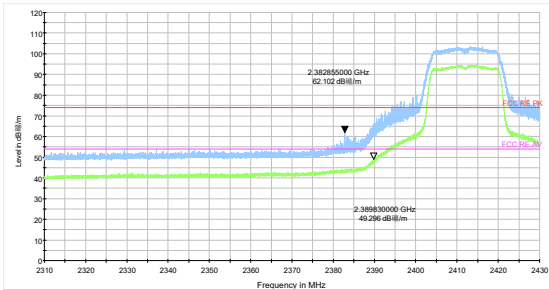

802.11g-Channel 1 Peak+ Average

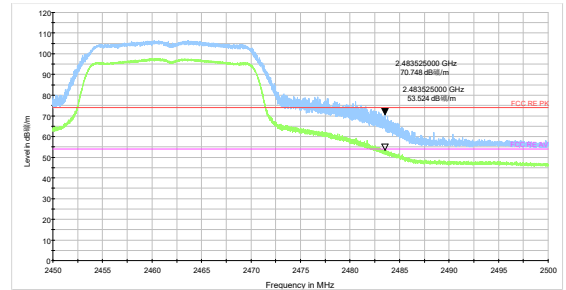

802.11g-Channel 11 Peak+ Average

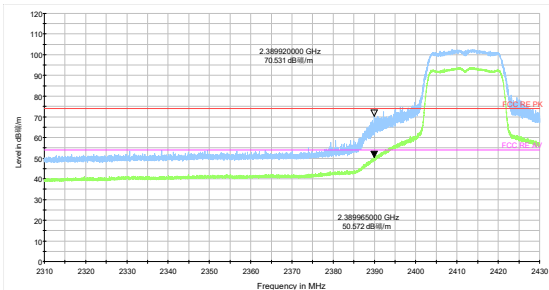

802.11n HT20 -Channel 1 Peak+ Average

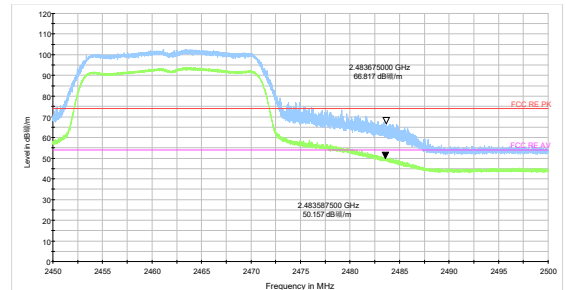

802.11n HT20 -Channel 11 Peak+ Average

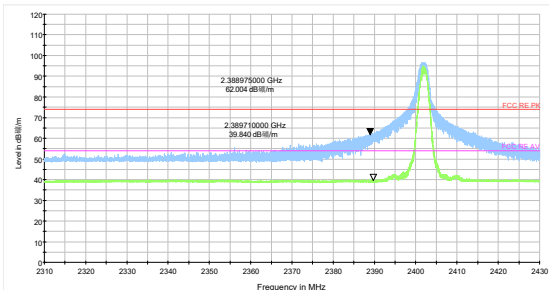

Bluetooth LE Channel 0 Peak+ Average

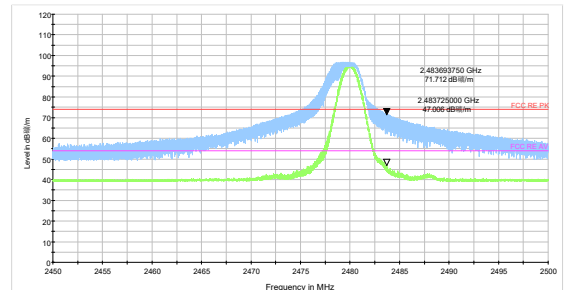

Bluetooth LE Channel 39 Peak+Average

Result of RE

Test result

Sweep the whole frequency band through the range from 9kHz to the 10th harmonic of the carrier, the Emissions in the frequency band 9kHz-30MHz and 18GHz-26.5GHz are more than 20dB below the limit are not reported.

The following graphs display the maximum values of horizontal and vertical by software. For above 1GHz, Blue trace uses the peak detection, Green trace uses the average detection.

During the test, the Radiates Emission from 30MHz to 1GHz was performed in all modes with all channels, 802.11g, Channel 11 are selected as the worst condition. The test data of the worst-case condition was recorded in this report.

A font (Level in dB μ V/)in the test plot =(level in dB μ V/m)

Continuous TX mode:

FCC RE 9K-90KHz AV

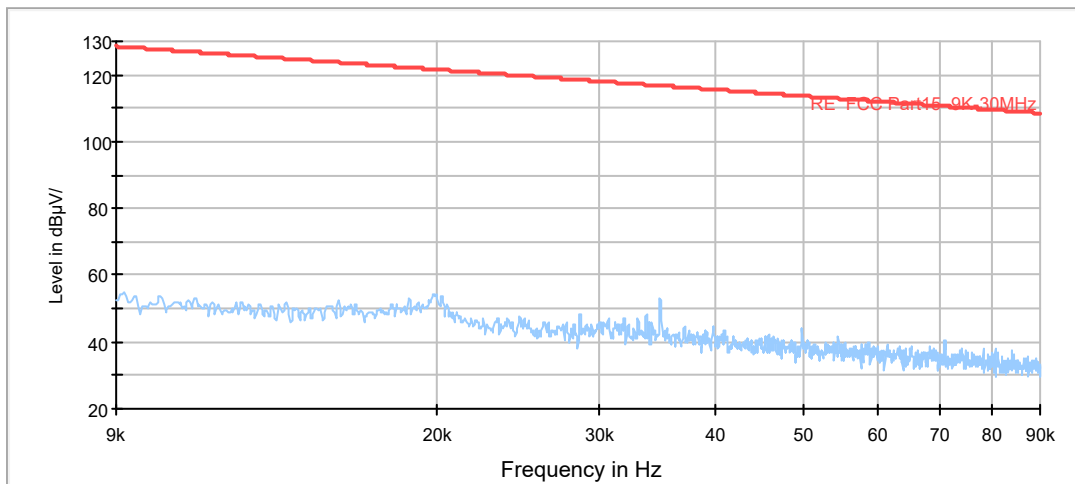

Radiates Emission from 9KHz to 90KHz

FCC RE 90K-110KHz QP

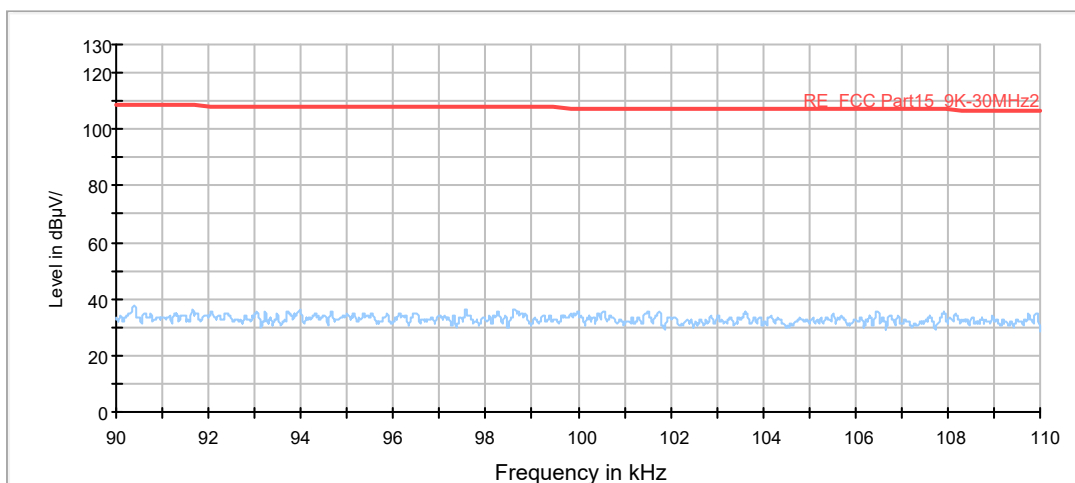

Radiates Emission from 90KHz to 110KHz

FCC RE 110K-490KHz AV

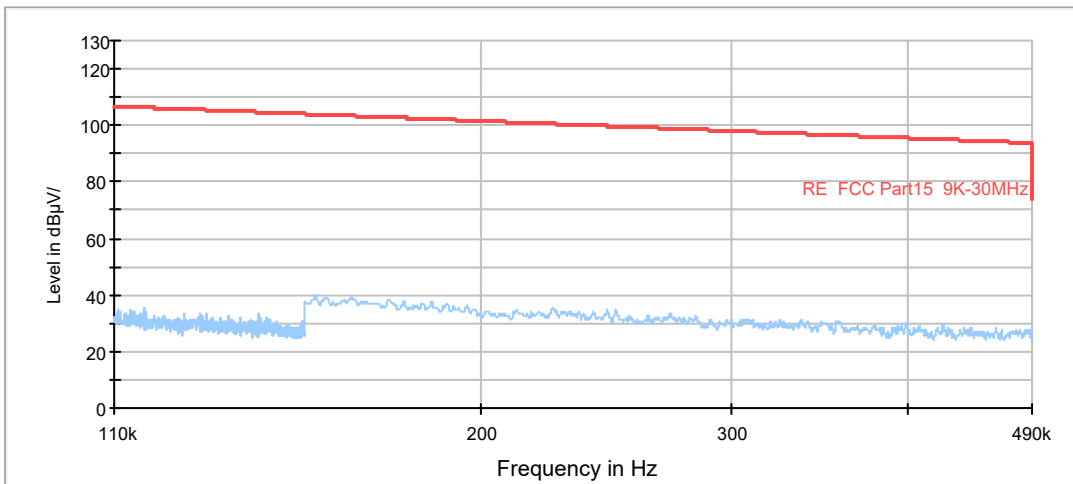

Radiates Emission from 110KHz to 490KHz

FCC RE 490K-30MHz QP

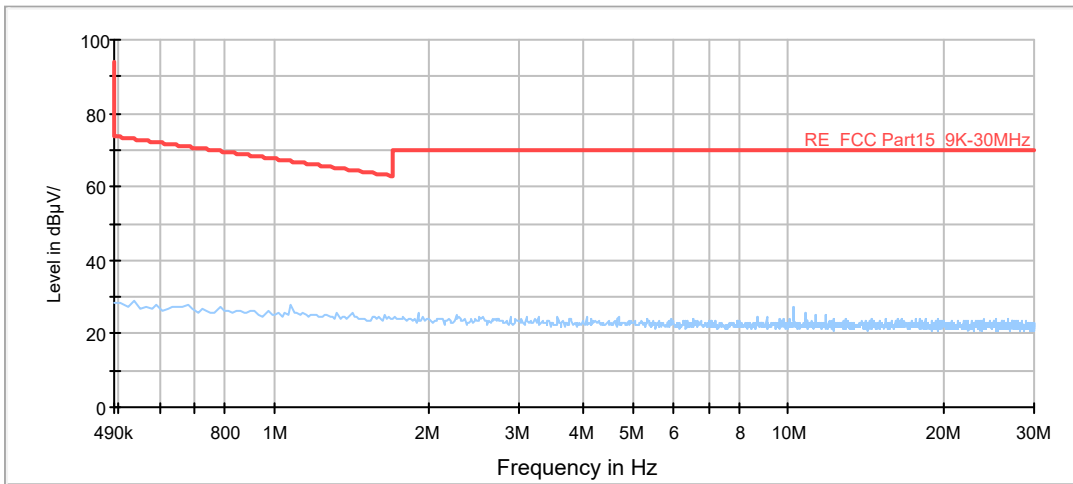

Radiates Emission from 490KHz to 30MHz

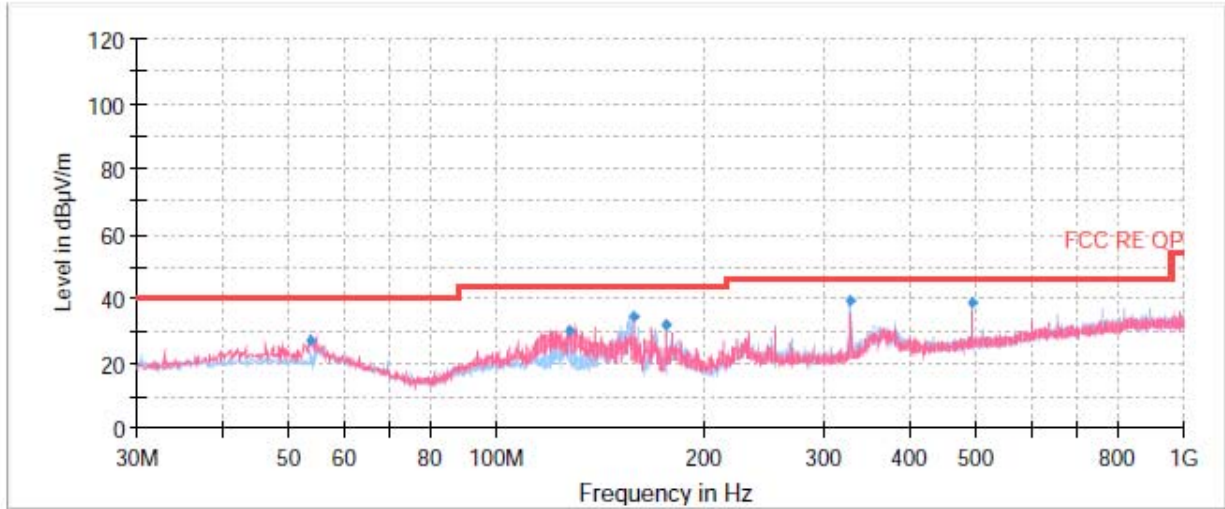

Radiates Emission from 30MHz to 1GHz

Frequency (MHz)	Quasi-Peak (dBuV/m)	Height (cm)	Polarization	Azimuth (deg)	Correct Factor (dB)	Margin (dB)	Limit (dBuV/m)
53.643750	27.06	100.0	V	0.0	13	12.94	40.00
127.477500	29.97	105.0	V	216.0	10	13.53	43.50
158.120000	34.17	190.0	H	260.0	9	9.33	43.50
176.712500	31.91	105.0	V	300.0	10	11.59	43.50
327.708750	39.60	100.0	H	108.0	16	6.40	46.00
491.598750	38.92	192.0	H	114.0	19	7.08	46.00

- Remark: 1. Correction Factor = Antenna factor+ Insertion loss(cable loss+amplifier gain)**
2. Margin = Limit – Quasi-Peak

802.11b CH1

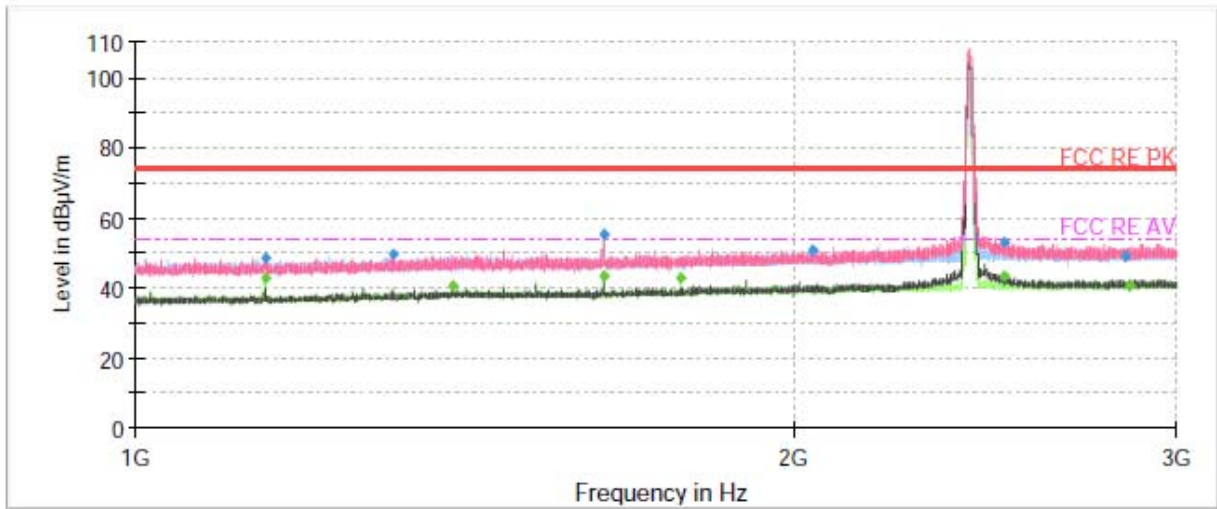

Note: The signal beyond the limit is carrier.
Radiates Emission from 1GHz to 3GHz

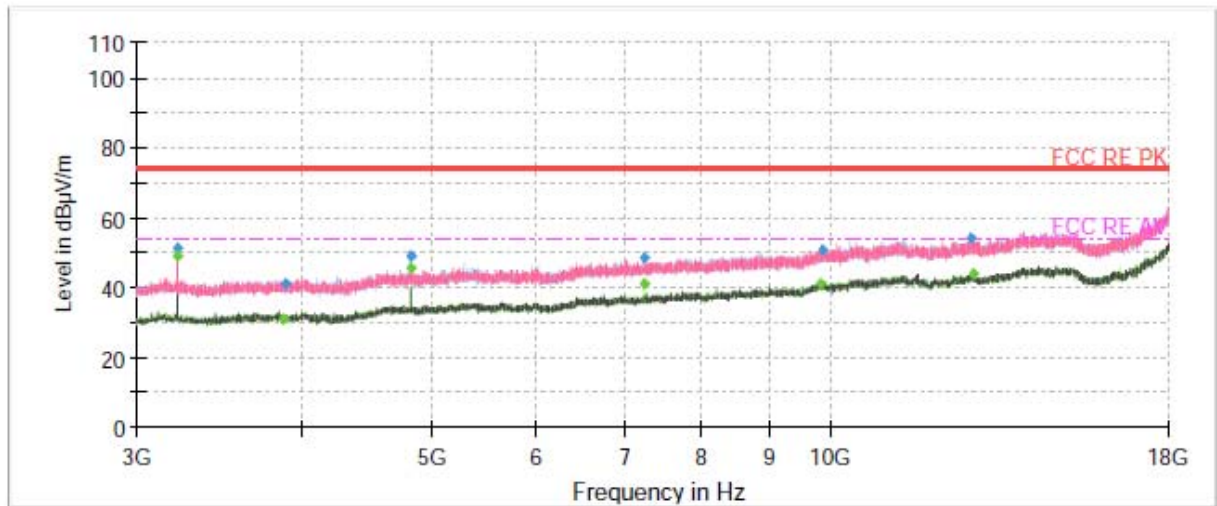

Radiates Emission from 3GHz to 18GHz



Frequency (MHz)	MaxPeak (dB μ V/m)	Average (dB μ V/m)	Limit (dB μ V/m)	Margin (dB)	Height (cm)	Pol	Azimuth (deg)	Corr. (dB/m)
1146.466667	48.59	---	74.00	25.41	200.0	H	186.0	-9
1147.000000	---	42.61	54.00	11.39	100.0	H	178.0	-9
1311.066667	49.75	---	74.00	24.25	100.0	V	32.0	-8
1398.133333	---	40.48	54.00	13.52	200.0	V	262.0	-7
1638.533333	55.21	---	74.00	18.79	200.0	H	309.0	-6
1638.733333	---	43.22	54.00	10.78	100.0	H	328.0	-6
1778.666667	---	42.87	54.00	11.13	100.0	H	241.0	-6
2041.933333	50.98	---	74.00	23.02	200.0	V	224.0	-5
2498.733333	53.29	---	74.00	20.71	200.0	V	55.0	-4
2499.400000	---	43.25	54.00	10.75	200.0	V	95.0	-4
2844.400000	48.94	---	74.00	25.06	200.0	H	98.0	-3
2858.066667	---	40.79	54.00	13.21	100.0	H	355.0	-3
3215.500000	---	48.87	54.00	5.13	200.0	H	38.0	-13

Remark: 1. Correction Factor = Antenna factor+ Insertion loss (cable loss + amplifier gain)

802.11b CH6

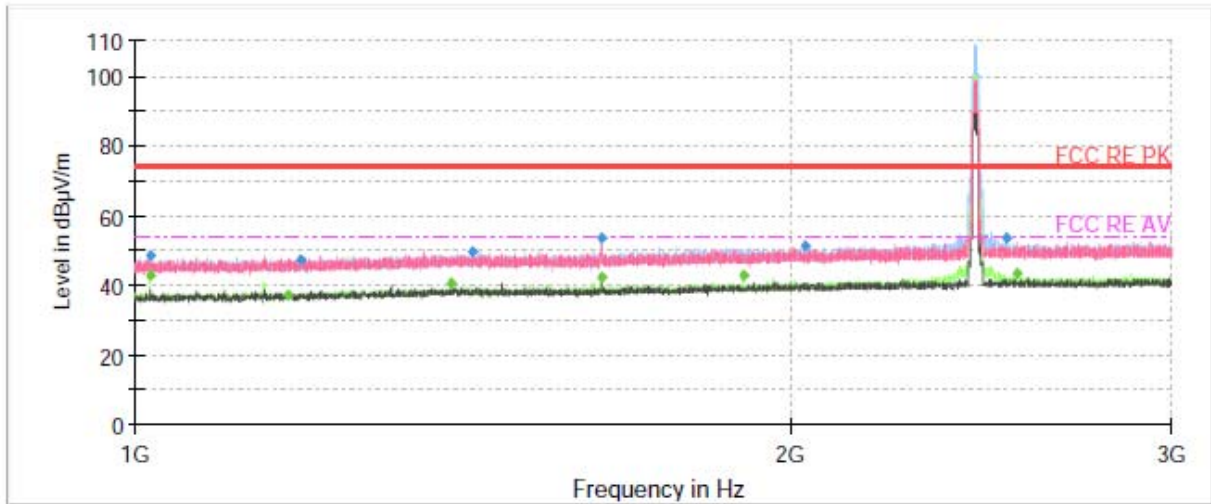

Note: The signal beyond the limit is carrier.
Radiates Emission from 1GHz to 3GHz

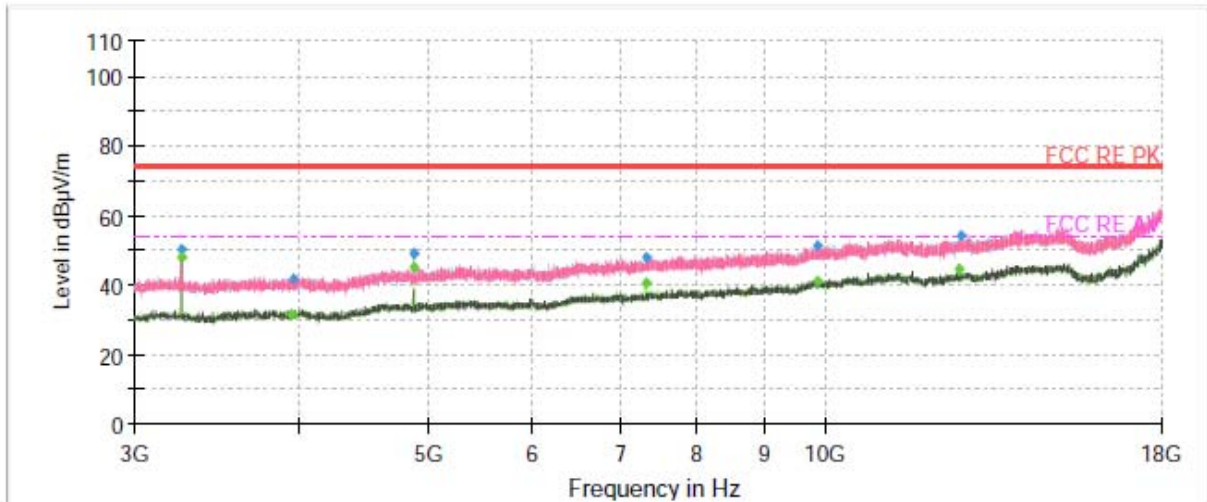

Radiates Emission from 3GHz to 18GHz



Frequency (MHz)	MaxPeak (dB μ V/m)	Average (dB μ V/m)	Limit (dB μ V/m)	Margin (dB)	Height (cm)	Pol	Azimuth (deg)	Corr. (dB/m)
1016.400000	---	42.92	54.00	11.08	200.0	H	22.0	-10
1016.400000	48.69	---	74.00	25.31	200.0	H	22.0	-10
1174.933333	---	37.34	54.00	16.66	200.0	H	45.0	-9
1191.066667	47.51	---	74.00	26.49	100.0	V	228.0	-9
1397.466667	---	40.81	54.00	13.19	200.0	H	295.0	-7
1428.000000	49.66	---	74.00	24.34	100.0	V	16.0	-7
1638.266667	53.85	---	74.00	20.15	200.0	V	174.0	-6
1638.266667	---	42.53	54.00	11.47	200.0	V	174.0	-6
1905.866667	---	43.11	54.00	10.89	100.0	H	268.0	-5
2035.400000	51.18	---	74.00	22.82	100.0	H	359.0	-5
2516.266667	53.45	---	74.00	20.55	100.0	H	69.0	-4
2544.533333	---	43.41	54.00	10.59	200.0	H	5.0	-4
3249.000000	---	48.08	54.00	5.92	200.0	H	39.0	-13

Remark: 1. Correction Factor = Antenna factor+ Insertion loss (cable loss + amplifier gain)

802.11b CH11

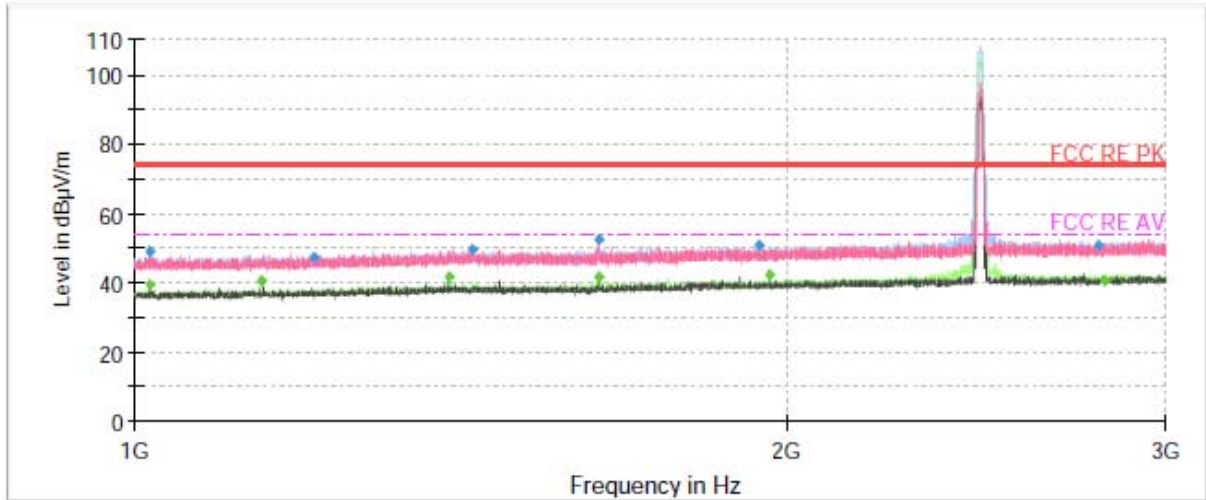

Note: The signal beyond the limit is carrier.
Radiates Emission from 1GHz to 3GHz

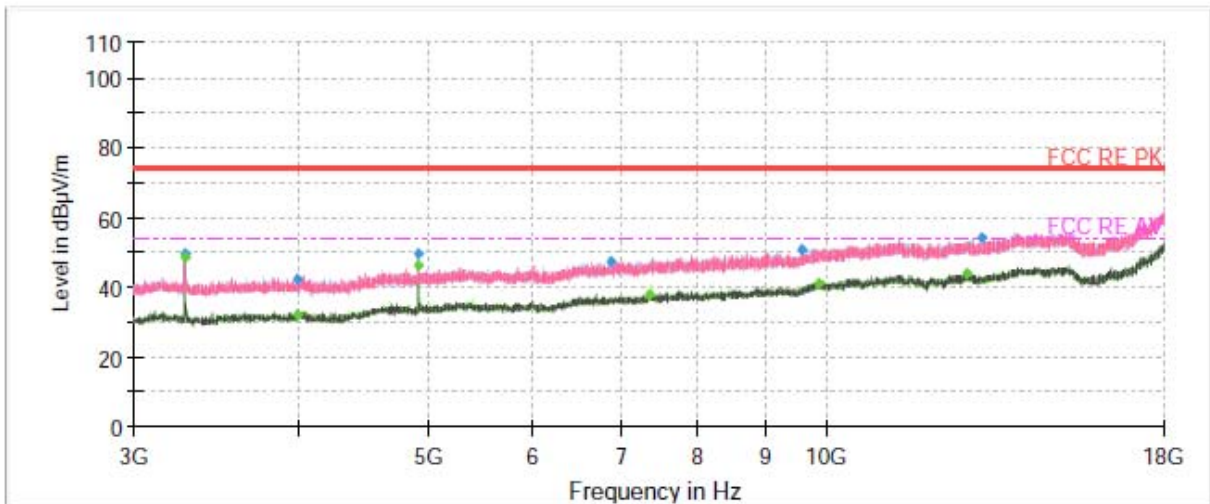

Radiates Emission from 3GHz to 18GHz



Frequency (MHz)	MaxPeak (dB μ V/m)	Average (dB μ V/m)	Limit (dB μ V/m)	Margin (dB)	Height (cm)	Pol	Azimuth (deg)	Corr. (dB/m)
1016.533333	49.13	---	74.00	24.87	200.0	H	0.0	-10
1016.733333	---	39.35	54.00	14.65	200.0	H	30.0	-10
1143.466667	---	40.64	54.00	13.36	200.0	H	20.0	-9
1209.866667	47.27	---	74.00	26.73	100.0	H	339.0	-9
1397.866667	---	41.72	54.00	12.28	100.0	H	237.0	-7
1434.133333	49.81	---	74.00	24.19	100.0	V	151.0	-7
1638.666667	---	41.83	54.00	12.17	200.0	V	0.0	-6
1638.800000	52.61	---	74.00	21.39	200.0	V	0.0	-6
1945.733333	50.64	---	74.00	23.36	200.0	H	8.0	-5
1966.466667	---	42.36	54.00	11.64	100.0	H	146.0	-5
2792.466667	50.68	---	74.00	23.32	100.0	H	352.0	-4
2807.933333	---	40.60	54.00	13.40	100.0	H	316.0	-3
3282.500000	---	48.51	54.00	5.49	100.0	V	18.0	-13

Remark: 1. Correction Factor = Antenna factor+ Insertion loss (cable loss + amplifier gain)

802.11g CH1

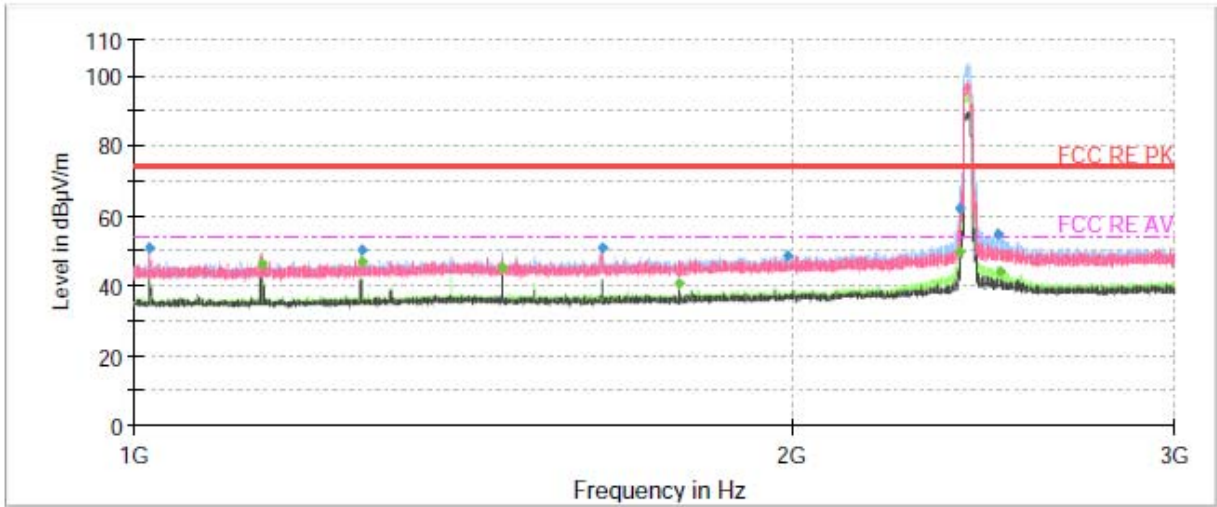

Note: The signal beyond the limit is carrier.
Radiates Emission from 1GHz to 3GHz

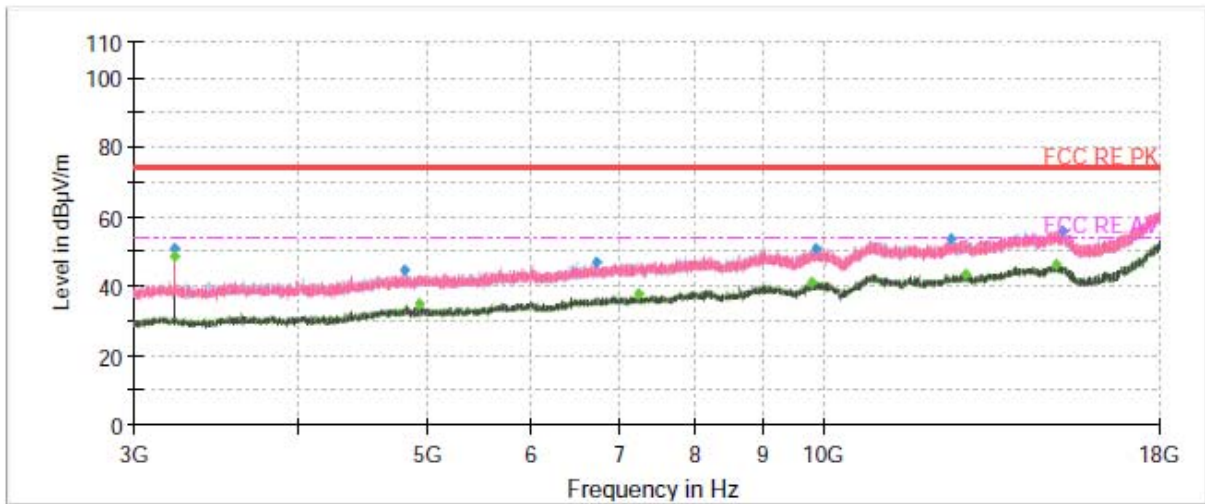

Radiates Emission from 3GHz to 18GHz



Frequency (MHz)	MaxPeak (dB μ V/m)	Average (dB μ V/m)	Limit (dB μ V/m)	Margin (dB)	Height (cm)	Pol	Azimuth (deg)	Corr. (dB/m)
1016.47	50.99	---	74.00	23.01	200.0	V	55.00	-10
1143.93	---	46.14	54.00	7.86	200.0	V	311.00	-9
1270.73	---	46.65	54.00	7.35	100.0	H	323.00	-8
1270.73	50.04	---	74.00	23.96	100.0	H	323.00	-8
1474.60	---	45.33	54.00	8.67	100.0	H	358.00	-7
1638.00	50.92	---	74.00	23.08	200.0	V	217.00	-6
1779.00	---	40.71	54.00	13.29	200.0	V	0.00	-6
1992.33	48.53	---	74.00	25.47	200.0	H	0.00	-5
2388.40	61.95	---	74.00	12.05	100.0	H	120.00	-4
2389.93	---	49.69	54.00	4.31	100.0	H	30.00	-4
2488.93	54.62	---	74.00	19.38	200.0	H	128.00	-4
2496.93	---	43.86	54.00	10.14	100.0	H	105.00	-4
3216.00	---	48.44	54.00	5.56	100.0	H	143.00	-13

Remark: 1. Correction Factor = Antenna factor+ Insertion loss (cable loss + amplifier gain)

802.11g CH6

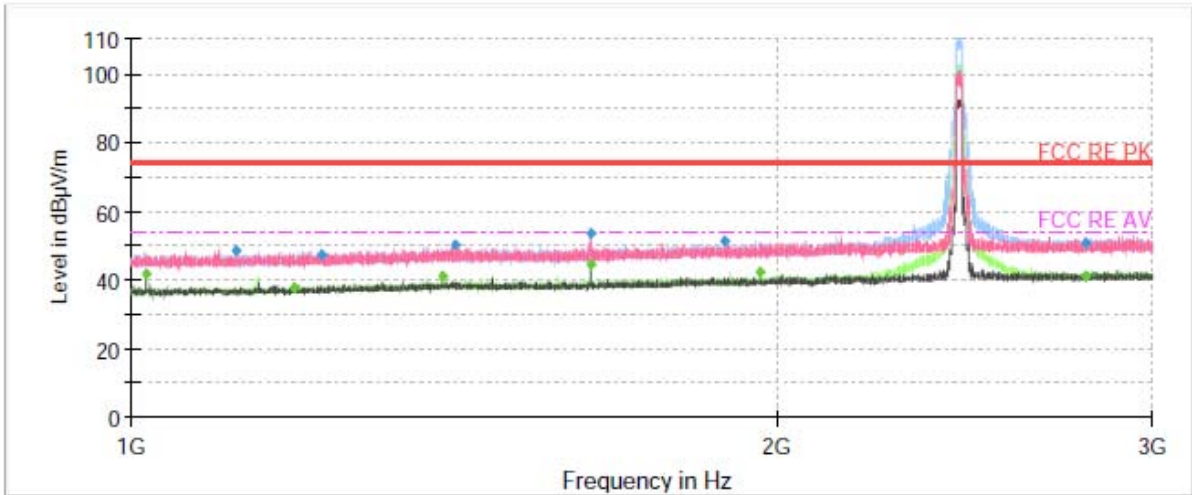

Note: The signal beyond the limit is carrier.
Radiates Emission from 1GHz to 3GHz

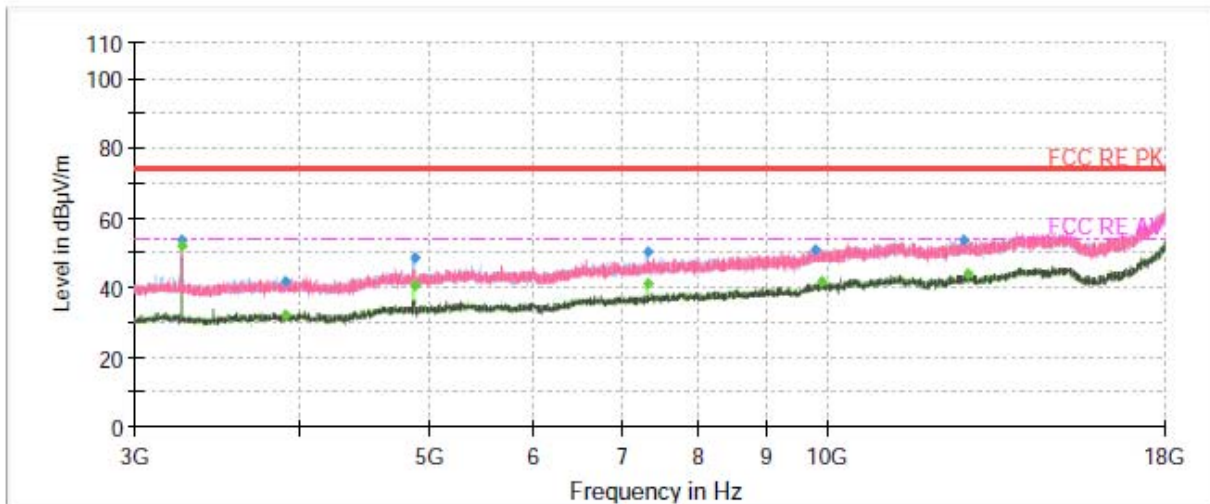

Radiates Emission from 3GHz to 18GHz



Frequency (MHz)	MaxPeak (dB μ V/m)	Average (dB μ V/m)	Limit (dB μ V/m)	Margin (dB)	Height (cm)	Pol	Azimuth (deg)	Corr. (dB/m)
1016.333333	---	41.59	54.00	12.41	200.0	H	35.0	-10
1118.866667	48.45	---	74.00	25.55	200.0	H	4.0	-9
1191.333333	---	37.94	54.00	16.06	100.0	H	342.0	-9
1226.066667	47.66	---	74.00	26.34	200.0	H	2.0	-8
1397.200000	---	41.24	54.00	12.76	100.0	H	210.0	-7
1416.533333	50.09	---	74.00	23.91	200.0	H	4.0	-7
1638.733333	53.57	---	74.00	20.43	200.0	H	239.0	-6
1638.733333	---	44.45	54.00	9.55	200.0	H	239.0	-6
1890.866667	51.34	---	74.00	22.66	100.0	H	0.0	-5
1966.466667	---	42.34	54.00	11.66	100.0	H	284.0	-5
2789.733333	51.03	---	74.00	22.97	100.0	H	357.0	-4
2794.933333	---	41.40	54.00	12.60	100.0	H	309.0	-4
3249.000000	---	51.90	54.00	2.10	200.0	H	40.0	-13

Remark: 1. Correction Factor = Antenna factor+ Insertion loss (cable loss + amplifier gain)

802.11g CH11

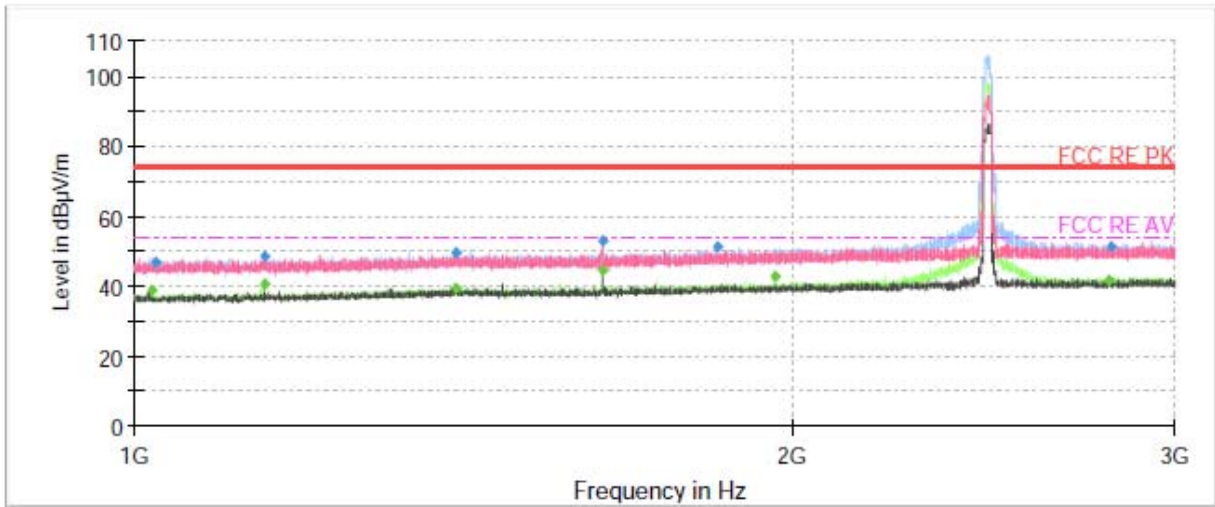

Note: The signal beyond the limit is carrier.
Radiates Emission from 1GHz to 3GHz

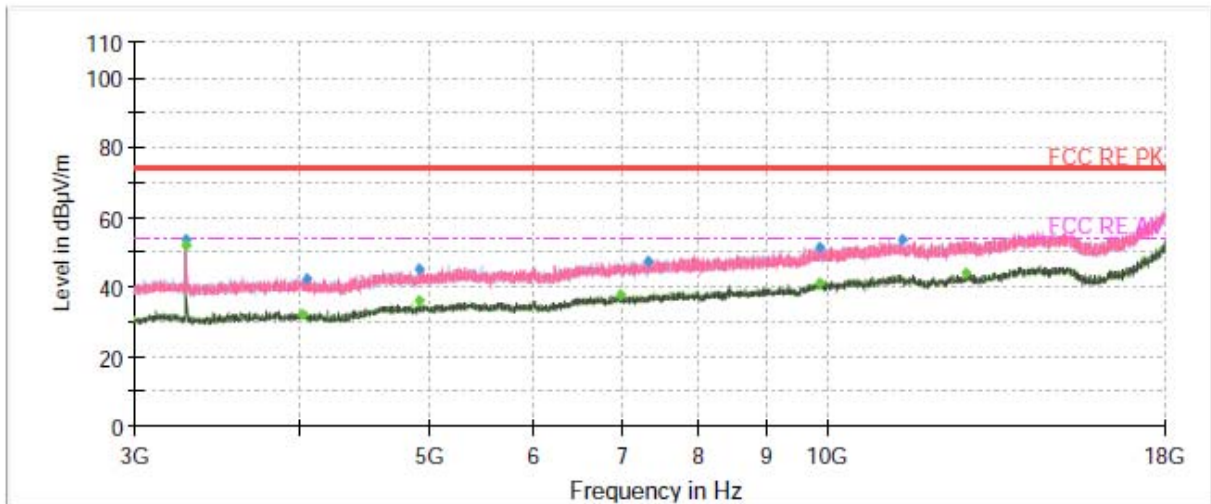

Radiates Emission from 3GHz to 18GHz



Frequency (MHz)	MaxPeak (dB μ V/m)	Average (dB μ V/m)	Limit (dB μ V/m)	Margin (dB)	Height (cm)	Pol	Azimuth (deg)	Corr. (dB/m)
1017.133333	---	38.71	54.00	15.29	200.0	H	21.0	-10
1023.133333	47.03	---	74.00	26.97	200.0	H	0.0	-10
1146.800000	---	40.58	54.00	13.42	100.0	H	291.0	-9
1147.400000	48.41	---	74.00	25.59	200.0	H	13.0	-9
1403.933333	49.69	---	74.00	24.31	200.0	H	21.0	-7
1404.400000	---	39.65	54.00	14.35	100.0	V	3.0	-7
1638.733333	52.93	---	74.00	21.07	200.0	V	348.0	-6
1638.733333	---	44.63	54.00	9.37	200.0	V	348.0	-6
1852.066667	51.11	---	74.00	22.89	100.0	H	166.0	-5
1966.400000	---	42.70	54.00	11.30	100.0	H	153.0	-5
2799.600000	---	41.97	54.00	12.03	100.0	H	266.0	-3
2805.800000	51.58	---	74.00	22.42	200.0	H	229.0	-3
3282.500000	---	51.97	54.00	2.03	200.0	H	39.0	-13

Remark: 1. Correction Factor = Antenna factor+ Insertion loss (cable loss + amplifier gain)

802.11n (HT20) CH1

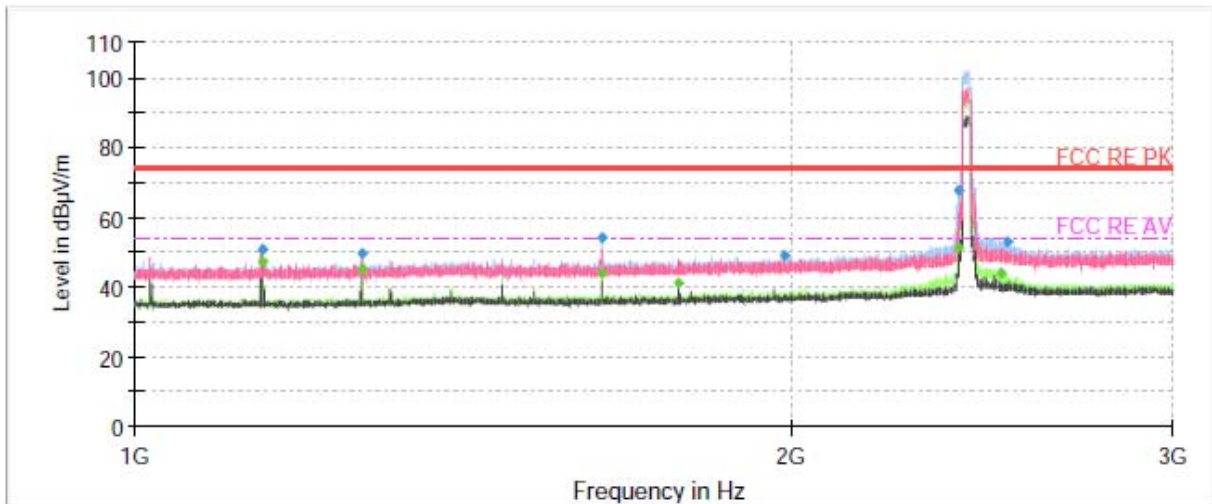

Note: The signal beyond the limit is carrier.
Radiates Emission from 1GHz to 3GHz

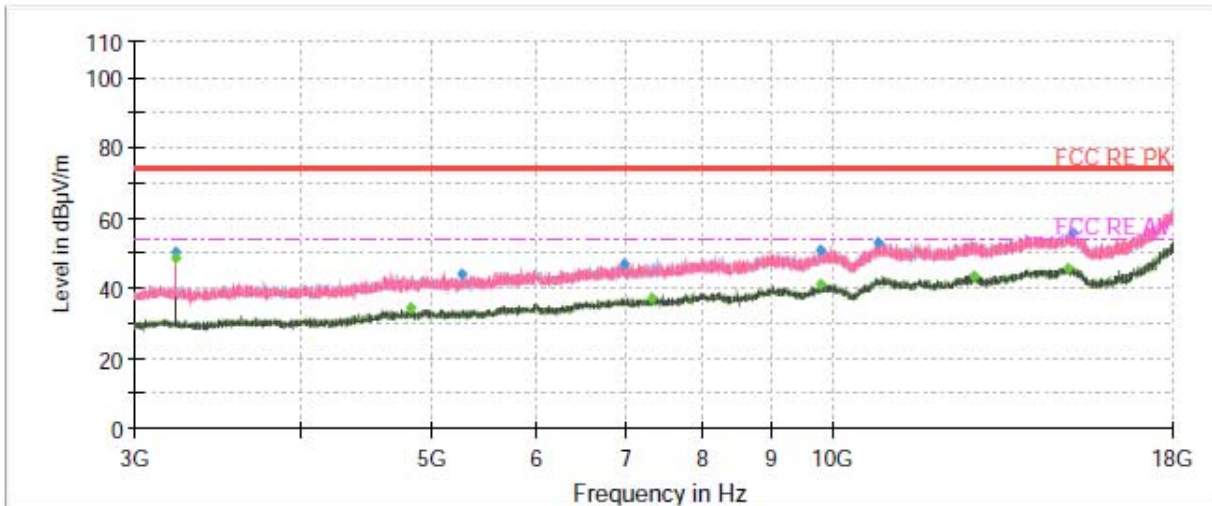

Radiates Emission from 3GHz to 18GHz



Frequency (MHz)	MaxPeak (dB μ V/m)	Average (dB μ V/m)	Limit (dB μ V/m)	Margin (dB)	Height (cm)	Pol	Azimuth (deg)	Corr. (dB/m)
1143.67	---	47.29	54.00	6.71	100.0	V	0.00	-9
1143.73	51.02	---	74.00	22.98	100.0	V	2.00	-9
1270.53	---	45.03	54.00	8.97	100.0	H	332.00	-8
1270.53	49.44	---	74.00	24.56	100.0	H	332.00	-8
1638.53	---	43.97	54.00	10.03	200.0	H	99.00	-6
1638.53	53.93	---	74.00	20.07	200.0	H	99.00	-6
1779.07	---	41.38	54.00	12.62	200.0	V	95.00	-6
1988.07	48.83	---	74.00	25.17	100.0	H	295.00	-5
2389.53	67.52	---	74.00	6.48	100.0	H	73.00	-4
2389.93	---	51.07	54.00	2.93	100.0	H	37.00	-4
2498.20	---	44.01	54.00	9.99	100.0	H	73.00	-4
2518.47	53.27	---	74.00	20.73	100.0	H	103.00	-4
3216.00	---	48.41	54.00	5.59	100.0	H	146.00	-13

Remark: 1. Correction Factor = Antenna factor+ Insertion loss (cable loss + amplifier gain)

802.11n (HT20) CH6

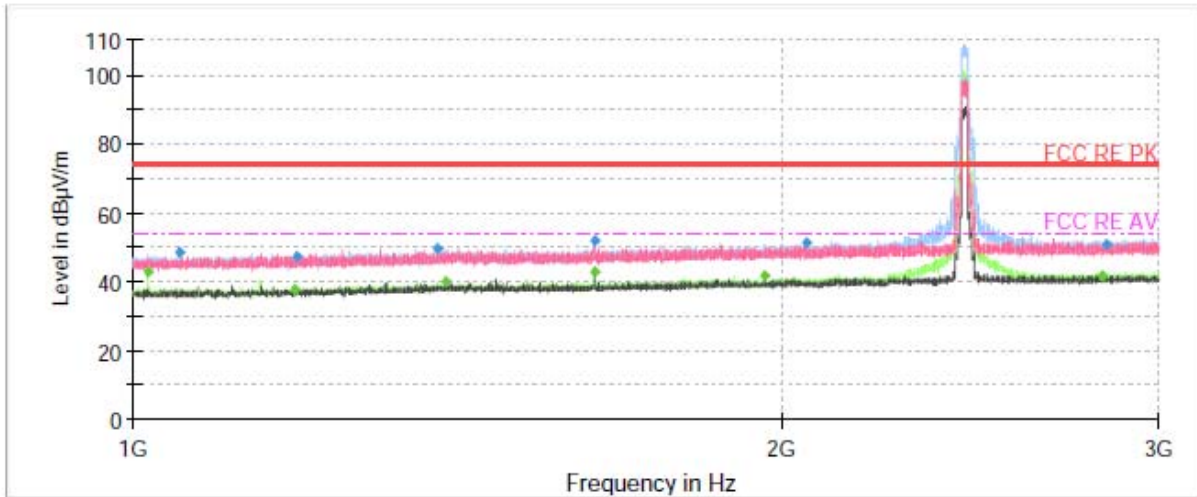

Note: The signal beyond the limit is carrier.
Radiates Emission from 1GHz to 3GHz

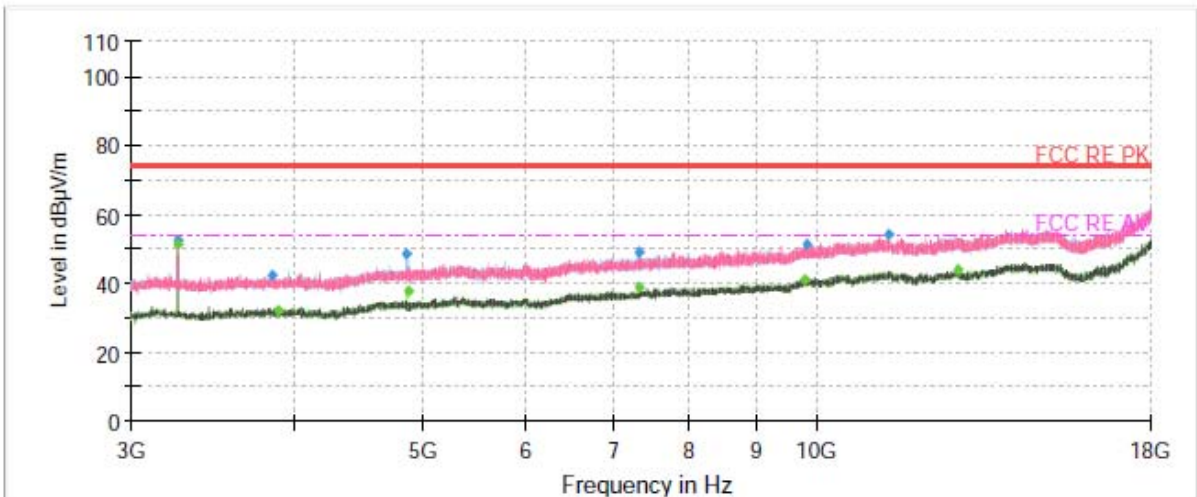

Radiates Emission from 3GHz to 18GHz



Frequency (MHz)	MaxPeak (dB μ V/m)	Average (dB μ V/m)	Limit (dB μ V/m)	Margin (dB)	Height (cm)	Pol	Azimuth (deg)	Corr. (dB/m)
1016.666667	---	42.72	54.00	11.28	200.0	H	7.0	-10
1050.266667	48.29	---	74.00	25.71	100.0	H	242.0	-9
1188.600000	---	37.60	54.00	16.40	100.0	H	190.0	-9
1192.600000	47.18	---	74.00	26.82	200.0	H	1.0	-9
1385.200000	49.69	---	74.00	24.31	100.0	H	346.0	-7
1397.333333	---	40.04	54.00	13.96	200.0	H	251.0	-7
1638.533333	52.10	---	74.00	21.90	100.0	H	254.0	-6
1638.933333	---	42.92	54.00	11.08	200.0	V	288.0	-6
1966.266667	---	41.73	54.00	12.27	100.0	H	150.0	-5
2054.800000	51.07	---	74.00	22.93	100.0	V	95.0	-5
2821.733333	---	41.60	54.00	12.40	200.0	H	2.0	-3
2835.200000	50.55	---	74.00	23.45	200.0	H	174.0	-3
3249.000000	---	51.22	54.00	2.78	200.0	H	35.0	-13

Remark: 1. Correction Factor = Antenna factor+ Insertion loss (cable loss + amplifier gain)

802.11n (HT20) CH11

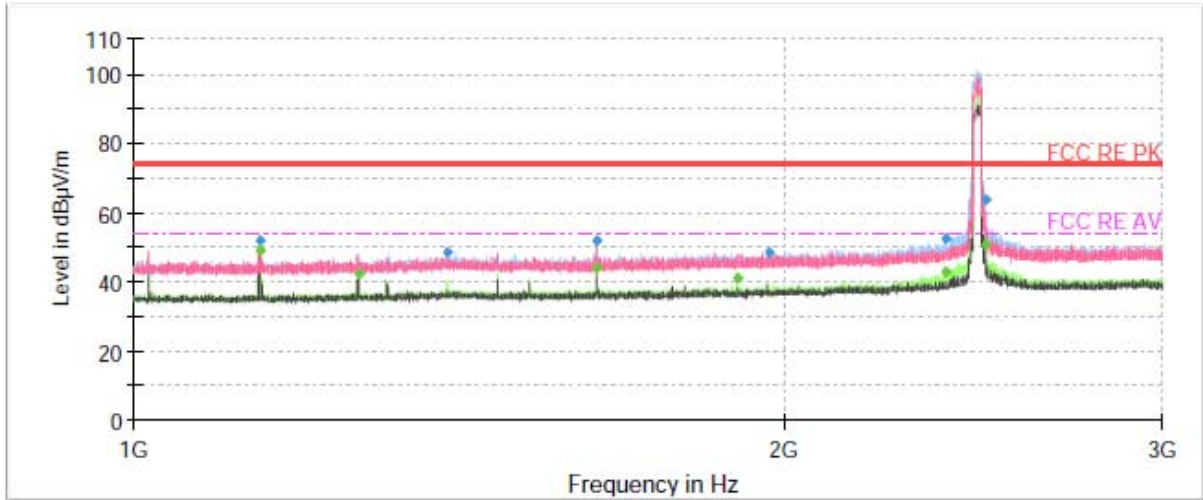

Note: The signal beyond the limit is carrier.
Radiates Emission from 1GHz to 3GHz

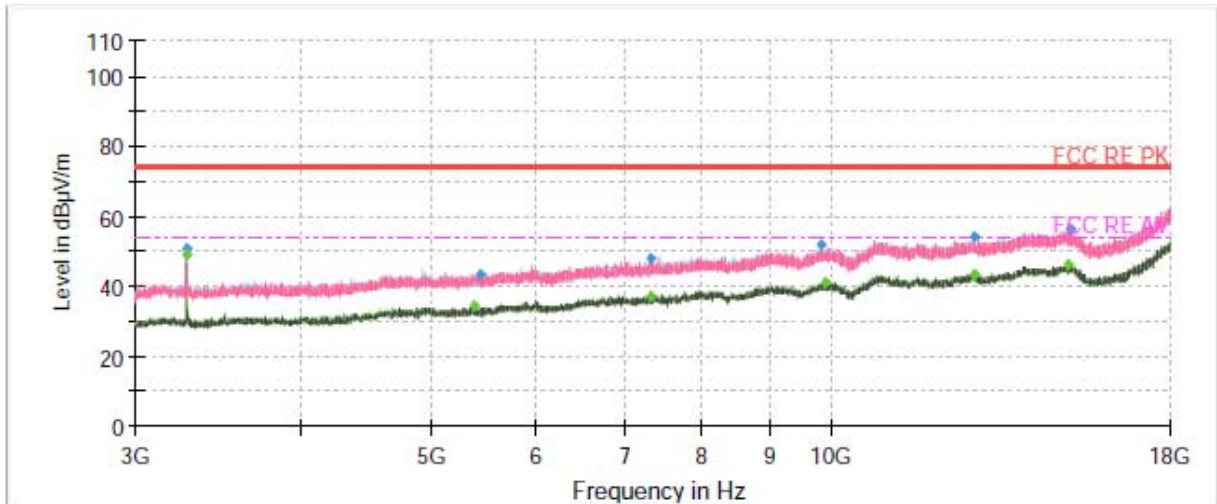

Radiates Emission from 3GHz to 18GHz



Frequency (MHz)	MaxPeak (dB μ V/m)	Average (dB μ V/m)	Limit (dB μ V/m)	Margin (dB)	Height (cm)	Pol	Azimuth (deg)	Corr. (dB/m)
1143.53	52.05	---	74.00	21.95	100.0	V	22.00	-9
1143.53	---	49.05	54.00	4.95	100.0	V	22.00	-9
1270.67	---	42.58	54.00	11.42	100.0	H	191.00	-8
1398.20	48.27	---	74.00	25.73	100.0	H	311.00	-7
1638.93	51.67	---	74.00	22.33	100.0	V	76.00	-6
1638.93	---	44.25	54.00	9.75	100.0	V	76.00	-6
1905.87	---	41.38	54.00	12.62	100.0	H	284.00	-5
1972.00	48.68	---	74.00	25.32	100.0	H	335.00	-5
2380.93	52.58	---	74.00	21.42	100.0	H	74.00	-4
2382.67	---	42.72	54.00	11.28	100.0	H	106.00	-4
2484.07	63.47	---	74.00	10.53	100.0	H	74.00	-4
2484.40	---	50.87	54.00	3.13	100.0	H	74.00	-4
3282.50	---	49.12	54.00	4.88	100.0	H	128.00	-13

Remark: 1. Correction Factor = Antenna factor+ Insertion loss (cable loss + amplifier gain)

Bluetooth LE-Channel 0

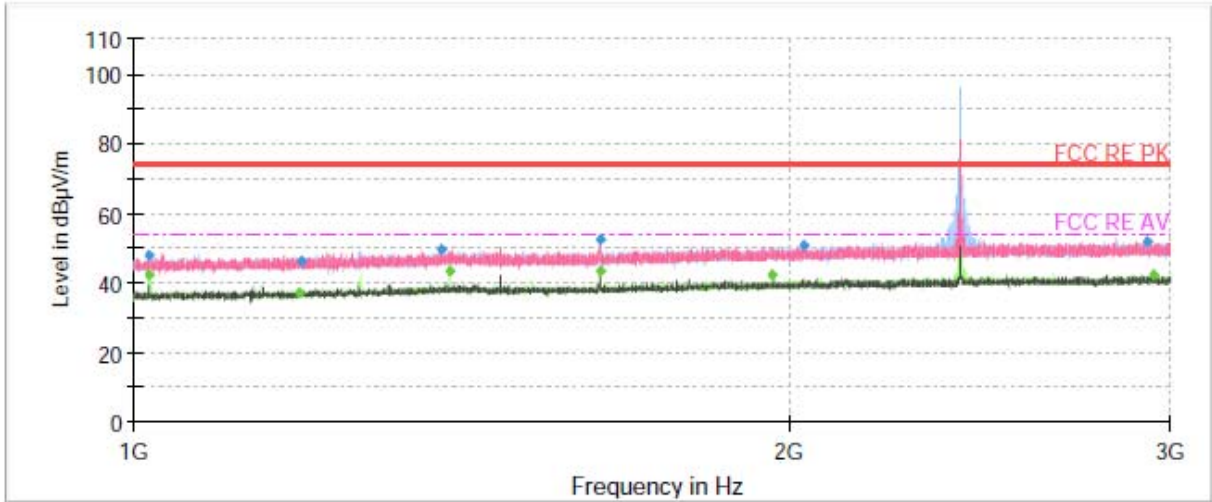

Note: The signal beyond the limit is carrier.
Radiates Emission from 1GHz to 3GHz

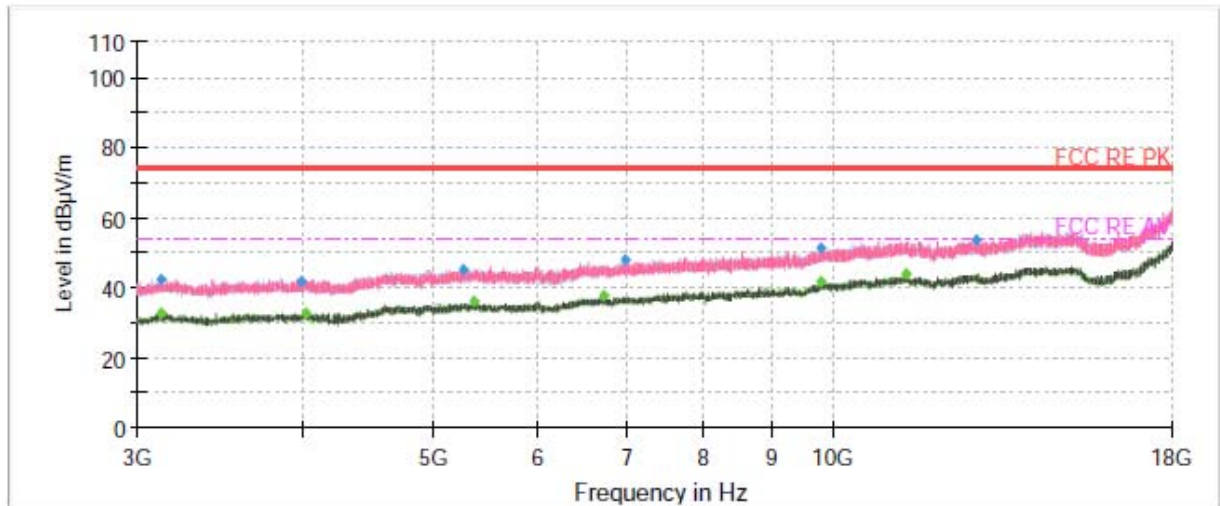

Radiates Emission from 3GHz to 18GHz



Frequency (MHz)	MaxPeak (dB μ V/m)	Average (dB μ V/m)	Limit (dB μ V/m)	Margin (dB)	Height (cm)	Pol	Azimuth (deg)	Corr. (dB/m)
1016.266667	---	42.57	54.00	11.43	200.0	H	5.0	-10
1016.600000	48.15	---	74.00	25.85	100.0	H	23.0	-10
1191.533333	---	37.39	54.00	16.61	100.0	H	0.0	-9
1195.266667	46.53	---	74.00	27.47	100.0	H	144.0	-9
1385.733333	49.91	---	74.00	24.09	200.0	V	299.0	-7
1397.600000	---	43.59	54.00	10.41	100.0	H	274.0	-7
1637.933333	52.50	---	74.00	21.50	200.0	V	10.0	-6
1638.666667	---	43.16	54.00	10.84	200.0	V	0.0	-6
1966.400000	---	42.03	54.00	11.97	100.0	H	274.0	-5
2035.133333	50.59	---	74.00	23.41	100.0	V	214.0	-5
2927.066667	52.11	---	74.00	21.89	200.0	H	358.0	-3
2945.933333	---	42.23	54.00	11.77	200.0	V	171.0	-3

Remark: 1. Correction Factor = Antenna factor+ Insertion loss (cable loss + amplifier gain)

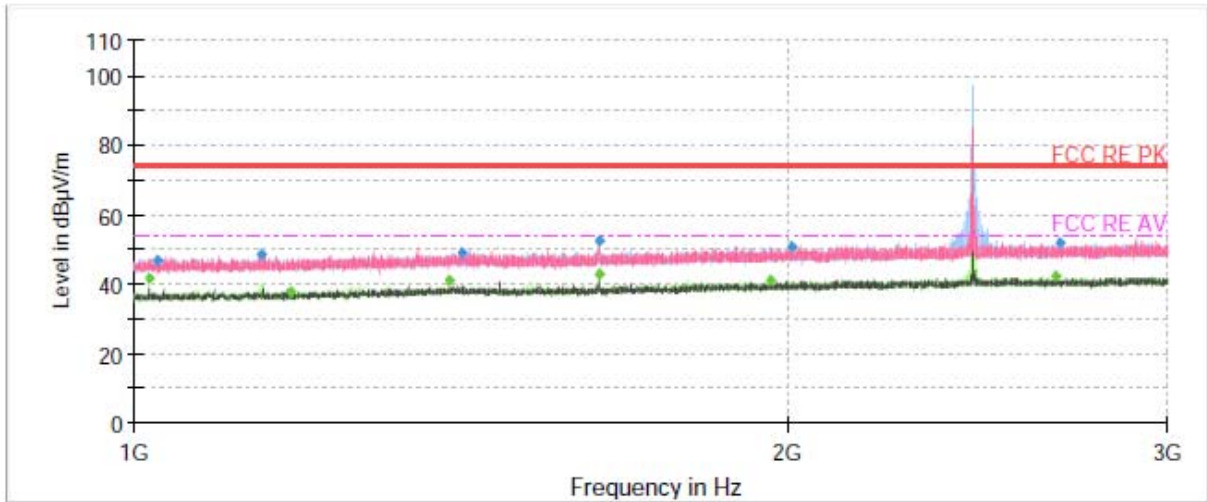
Bluetooth LE-Channel 19

Note: The signal beyond the limit is carrier.
Radiates Emission from 1GHz to 3GHz

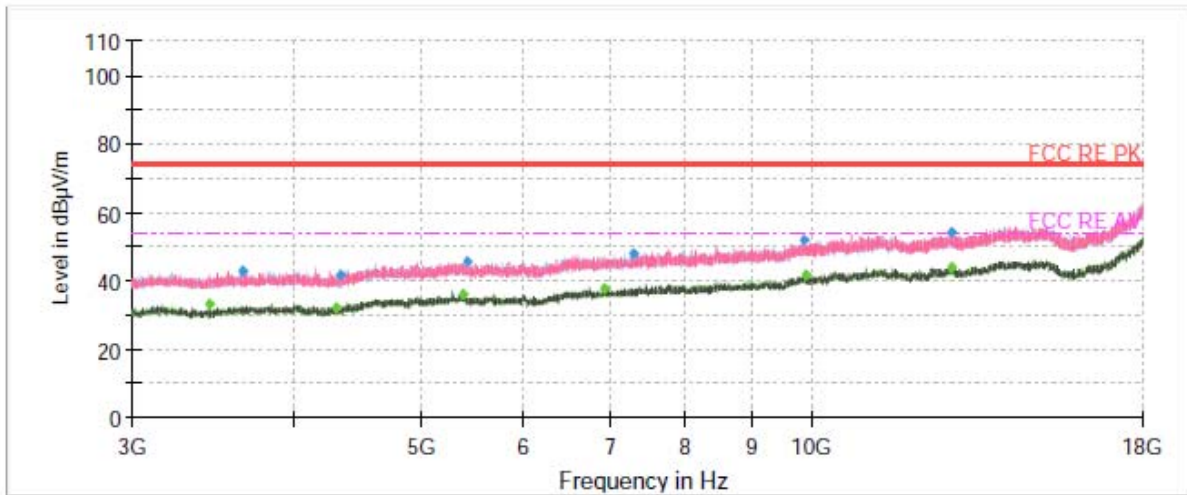

Radiates Emission from 3GHz to 18GHz



Frequency (MHz)	MaxPeak (dB μ V/m)	Average (dB μ V/m)	Limit (dB μ V/m)	Margin (dB)	Height (cm)	Pol	Azimuth (deg)	Corr. (dB/m)
1016.266667	---	41.99	54.00	12.01	100.0	H	358.0	-10
1025.800000	46.74	---	74.00	27.26	200.0	V	117.0	-10
1144.666667	48.55	---	74.00	25.45	200.0	H	120.0	-9
1181.466667	---	37.67	54.00	16.33	100.0	H	298.0	-9
1397.933333	---	41.15	54.00	12.85	100.0	H	273.0	-7
1417.400000	49.27	---	74.00	24.73	200.0	V	357.0	-7
1638.400000	52.42	---	74.00	21.58	100.0	V	0.0	-6
1638.533333	---	43.11	54.00	10.89	100.0	H	117.0	-6
1966.666667	---	41.34	54.00	12.66	100.0	H	222.0	-5
2010.933333	51.00	---	74.00	23.00	100.0	H	348.0	-5
2663.333333	---	42.08	54.00	11.92	100.0	H	333.0	-3
2675.800000	51.68	---	74.00	22.32	100.0	H	0.0	-3

Remark: 1. Correction Factor = Antenna factor+ Insertion loss (cable loss + amplifier gain)

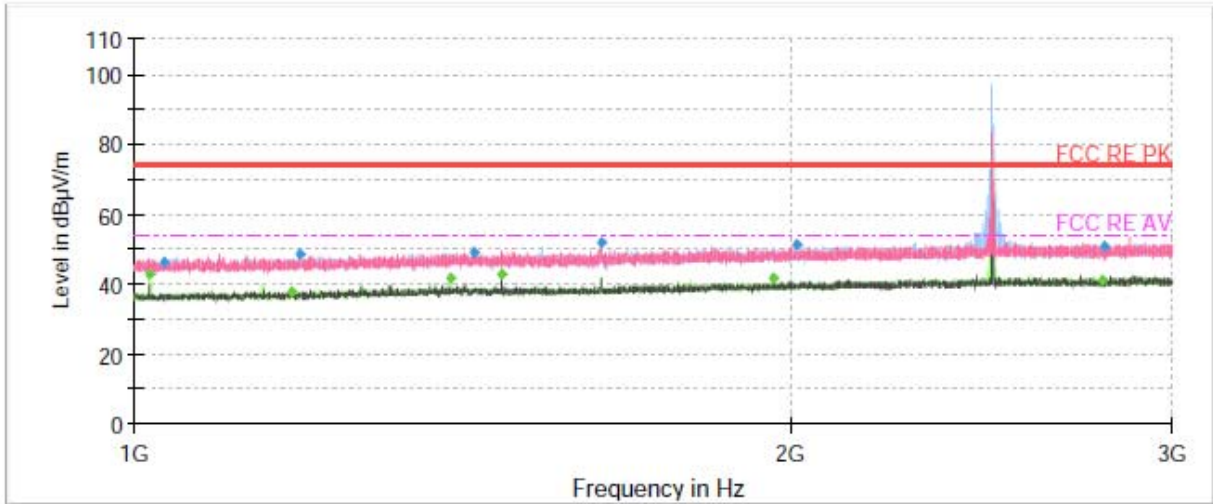
Bluetooth LE-Channel 39

Note: The signal beyond the limit is carrier.
Radiates Emission from 1GHz to 3GHz

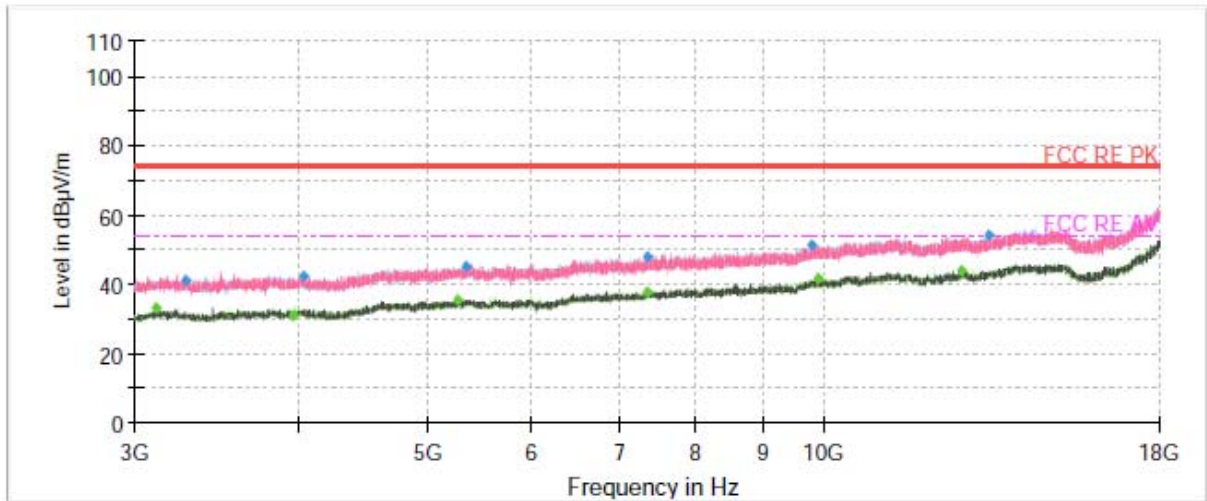

Radiates Emission from 3GHz to 18GHz



Frequency (MHz)	MaxPeak (dB μ V/m)	Average (dB μ V/m)	Limit (dB μ V/m)	Margin (dB)	Height (cm)	Pol	Azimuth (deg)	Corr. (dB/m)
1016.600000	---	42.65	54.00	11.35	200.0	H	39.0	-10
1030.800000	46.53	---	74.00	27.47	100.0	H	195.0	-10
1180.733333	---	37.58	54.00	16.42	200.0	H	282.0	-9
1192.066667	48.61	---	74.00	25.39	200.0	V	0.0	-9
1397.666667	---	41.92	54.00	12.08	100.0	H	36.0	-7
1432.133333	49.27	---	74.00	24.73	100.0	H	289.0	-7
1474.800000	---	42.81	54.00	11.19	100.0	V	269.0	-7
1638.333333	52.11	---	74.00	21.89	200.0	V	9.0	-6
1966.666667	---	41.87	54.00	12.13	100.0	H	157.0	-5
2013.466667	51.18	---	74.00	22.82	100.0	H	208.0	-5
2782.800000	---	41.44	54.00	12.56	200.0	H	51.0	-4
2789.800000	50.54	---	74.00	23.46	100.0	V	100.0	-4

Remark: 1. Correction Factor = Antenna factor+ Insertion loss (cable loss + amplifier gain)



During the test, the Radiates Emission from 18GHz to 26.5GHz was performed in all modes with all channels, 802.11g CH11 are selected as the worst condition. The test data of the worst-case condition was recorded in this report.

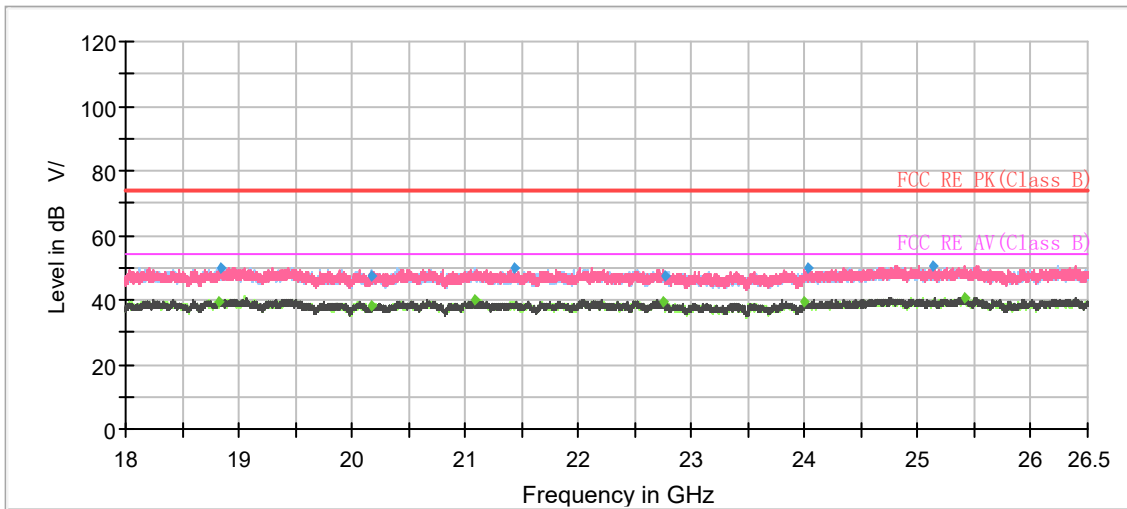

Radiates Emission from 18GHz to 26.5GHz

5.7. Conducted Emission

Ambient condition

Temperature	Relative humidity	Pressure
23°C ~25°C	45%~50%	101.5kPa

Methods of Measurement

The EUT is placed on a non-metallic table of 80cm height above the horizontal metal reference ground plane. During the test, the EUT was operating in its typical mode. The test method is according to ANSI C63.10. Connect the AC power line of the EUT to the L.I.S.N. Use EMI receiver to detect the average and Quasi-peak value. RBW is set to 9 kHz, VBW is set to 30kHz.

The measurement result should include both L line and N line.

The test is in transmitting mode.

Test Setup

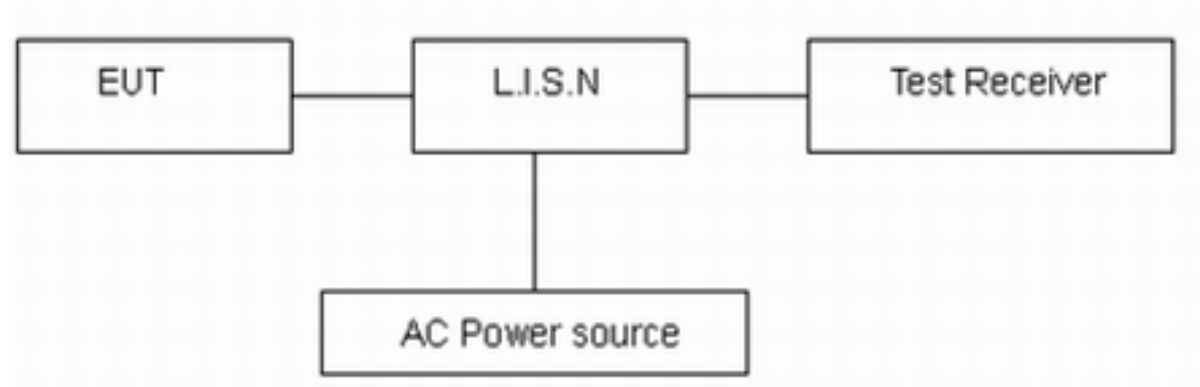

Note: AC Power source is used to change the voltage 110V/60Hz.

Limits

Frequency (MHz)	Conducted Limits(dBμV)	
	Quasi-peak	Average
0.15 - 0.5	66 to 56 *	56 to 46 *
0.5 - 5	56	46
5 - 30	60	50

*: Decreases with the logarithm of the frequency.

Measurement Uncertainty

The assessed measurement uncertainty to ensure 95% confidence level for the normal distribution is with the coverage factor $k = 1.96$, $U = 2.69$ dB.

Test Results:

Following plots, Blue trace uses the peak detection and Green trace uses the average detection. During the test, the Conducted Emission was performed in all modes (WIFI 2.4G /Bluetooth LE) with all channels, 802.11g, Channel 11 are selected as the worst condition. The test data of the worst-case condition was recorded in this report.

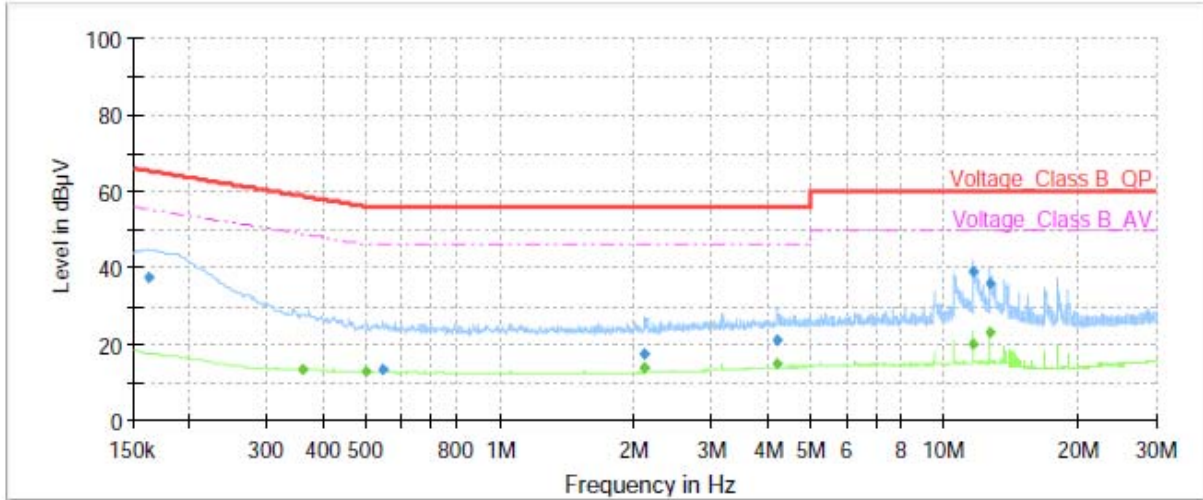

Frequency (MHz)	QuasiPeak (dBµV)	Average (dBµV)	Limit (dBµV)	Margin (dB)	Meas. Time (ms)	Bandwidth (kHz)	Line	Filter	Corr. (dB)
0.16	37.59	---	65.40	27.81	70.0	9.000	L1	ON	21
0.36	---	13.17	48.75	35.58	70.0	9.000	L1	ON	21
0.50	---	12.67	46.00	33.33	70.0	9.000	L1	ON	20
0.54	13.53	---	56.00	42.47	70.0	9.000	L1	ON	20
2.11	17.37	---	56.00	38.63	70.0	9.000	L1	ON	20
2.11	---	13.89	46.00	32.11	70.0	9.000	L1	ON	20
4.21	21.08	---	56.00	34.92	70.0	9.000	L1	ON	19
4.22	---	14.80	46.00	31.20	70.0	9.000	L1	ON	19
11.59	39.13	---	60.00	20.87	70.0	9.000	L1	ON	20
11.59	---	20.11	50.00	29.89	70.0	9.000	L1	ON	20
12.64	---	22.90	50.00	27.10	70.0	9.000	L1	ON	20
12.64	35.80	---	60.00	24.20	70.0	9.000	L1	ON	20

Remark: Correct factor=cable loss + LISN factor

L line Conducted Emission from 150 KHz to 30 MHz

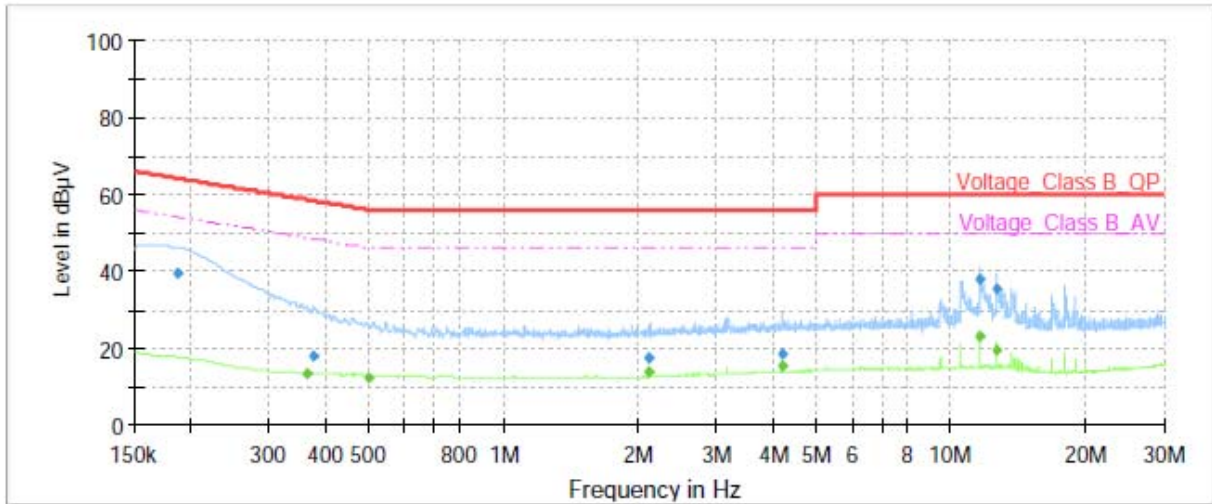

Frequency (MHz)	QuasiPeak (dBµV)	Average (dBµV)	Limit (dBµV)	Margin (dB)	Meas. Time (ms)	Bandwidth (kHz)	Line	Filter	Corr. (dB)
0.19	39.37	---	64.21	24.84	70.0	9.000	N	ON	21
0.36	---	13.50	48.69	35.19	70.0	9.000	N	ON	21
0.38	18.03	---	58.34	40.31	70.0	9.000	N	ON	21
0.50	---	12.46	46.00	33.54	70.0	9.000	N	ON	20
2.11	---	13.95	46.00	32.05	70.0	9.000	N	ON	20
2.11	17.18	---	56.00	38.82	70.0	9.000	N	ON	20
4.21	18.55	---	56.00	37.45	70.0	9.000	N	ON	19
4.21	---	15.29	46.00	30.71	70.0	9.000	N	ON	19
11.58	38.03	---	60.00	21.97	70.0	9.000	N	ON	20
11.58	---	23.14	50.00	26.86	70.0	9.000	N	ON	20
12.64	---	19.74	50.00	30.26	70.0	9.000	N	ON	20
12.64	35.27	---	60.00	24.73	70.0	9.000	N	ON	20

Remark: Correct factor=cable loss + LISN factor

N line Conducted Emission from 150 KHz to 30 MHz



6. Main Test Instruments

Name	Manufacturer	Type	Serial Number	Calibration Date	Expiration Date
Spectrum Analyzer	R&S	FSV40	100816	2021-05-15	2022-05-14
EMI Test Receiver	R&S	ESCI7	100936	2021-12-12	2022-12-11
Loop Antenna	SCHWARZBECK	FMZB1519	1519-047	2020-04-02	2023-04-01
TRILOG Broadband Antenna	SCHWARZBECK	VULB 9163	391	2019-12-16	2022-12-15
Horn Antenna	R&S	HF907	102723	2020-08-11	2023-08-10
Horn Antenna	ETS-Lindgren	3160-09	00102643	2021-10-10	2024-10-09
EMI Test Receiver	R&S	ESR	101667	2021-05-16	2022-05-15
LISN	R&S	ENV216	102191	2020-12-13	2022-12-12
Spectrum Analyzer	KEYSIGHT	N9020A	MY54420163	2021-12-12	2022-12-11
Power Sensor	R&S	NRP18S	101955	2021-05-15	2022-05-14
DC power supply	GWINSTEK	GPS-3030 D	GEP882653	2021-05-15	2022-05-14
Software	R&S	EMC32	10.35.10	/	/

*****END OF REPORT *****



ANNEX A: The EUT Appearance

The EUT Appearance are submitted separately.



ANNEX B: Test Setup Photos

The Test Setup Photos are submitted separately.



ANNEX C: Product Change Description

The Product Change Description are submitted separately.