

FCC PART 15C
Measurement and Test Report
For
SHENZHEN CACGO INTELLIGENT TECHNOLOGY CO.,LTD

FCC ID:2A448-K56PRO

FCC Rule(s)/Methods:	FCC CFR Title 47 Part 15 Subpart C Section 15.247 ANSI C63.10:2013
Product Description:	Smart watch
Trademark	/
Model/Type reference.:	K56PRO
Report No.:	BSL2305318275012F-2
Date of receipt of test item:	Jun. 21, 2023
Date of sampling :	Jun. 21, 2023
Tested Date:	Jun. 21, 2023 to Jul. 03, 2023
Issued Date:	Jul. 03, 2023
Tested By:	Cindy Zheng/ Engineer <i>Cindy zheng</i>
Reviewed By:	Haley Wen/ EMC Manager <i>Haley wen</i>
Approved & Authorized By:	Mike Mo / PSQ Manager <i>Mike Mo</i>
BSL Testing Co.,LTD.	
1/F, Building B, Xinshidai GR Park, Shiyuan Street, Bao'an District, Shenzhen, Shiyuan Street, Bao'an District, Shenzhen, Guangdong, 518052, People' s Republic of China	
Tel: 400-882-9628 Fax: 86- 755-26508703	

	Page
1. VERSION	4
2. TEST SUMMARY	5
2.1 TEST FACILITY	6
2.2 MEASUREMENT UNCERTAINTY	6
3. GENERAL INFORMATION	7
3.1 GENERAL DESCRIPTION OF EUT	7
3.2 Test Setup Configuration	8
3.3 Support Equipment	8
3.4 Test Mode	10
3.5 EQUIPMENTS LIST FOR ALL TEST ITEMS	11
4. EMC EMISSION TEST	13
4.1 Conducted emissions	13
4.1.1 POWER LINE CONDUCTED EMISSION Limits	13
4.1.2 TEST PROCEDURE	13
4.1.3 DEVIATION FROM TEST STANDARD	13
4.1.4 TEST SETUP	14
4.1.5 EUT OPERATING CONDITIONS	14
4.1.6 Test Result	15
4.2 Radiated emissions	17
4.2.1 Radiated Emission Limits	17
4.2.2 TEST PROCEDURE	17
4.2.3 DEVIATION FROM TEST STANDARD	18
4.2.4 TEST SETUP	18
4.2.5 EUT OPERATING CONDITIONS	19
4.2.6 TEST RESULTS	20
5. RADIATED BAND EMISSION MEASUREMENT	29
5.1 Test Requirement:	29
5.2 TEST PROCEDURE	29
5.3 DEVIATION FROM TEST STANDARD	30
5.4 TEST SETUP	30
5.5 EUT OPERATING CONDITIONS	30
5.6 TEST RESULT	31
6. CONDUCTED BAND EDGE AND SPURIOUS EMISSION	34
6.1 Limit	34
6.2 Test Setup	34
6.3 Test procedure	34
6.4 DEVIATION FROM STANDARD	34
6.5 Test Result	35
7. 20DB&99% BANDWIDTH	50
7.1 Test Setup	50
7.2 Limit	50
7.3 Test procedure	50
7.4 DEVIATION FROM STANDARD	50
7.5 Test Result	50
8. MAXIMUM PEAK OUTPUT POWER	56

8.1 Block Diagram Of Test Setup	56
8.2 Limit	56
8.3 Test procedure	56
8.4 DEVIATION FROM STANDARD	56
8.5 Test Result	56
9. HOPPING CHANNEL SEPARATION	57
9.1 Test Setup	57
9.2 Test procedure	57
9.3 DEVIATION FROM STANDARD	57
9.4 Test Result	58
10.NUMBER OF HOPPING FREQUENCY	63
10.1 Test Setup	63
10.2 Test procedure	63
10.3 DEVIATION FROM STANDARD	63
10.4 Test Result	64
11. DWELL TIME	66
11.1 Test Setup	66
11.2 Test procedure	66
11.3 DEVIATION FROM STANDARD	66
11.4 Test Result	67
12. ANTENNA REQUIREMENT	77
13. TEST SETUP PHOTO	78
14. EUT CONSTRUCTIONAL DETAILS	78

1. VERSION

Report No.	Version	Description	Approved
BSL2305318275012F-2	Rev.01	Initial issue of report	Jul. 03, 2023

2. TEST SUMMARY

Test procedures according to the technical standards:

FCC Part15 (15.247) , Subpart C KDB 558074 D01			
Standard Section	Test Item	Result	Remark
15.203/15.247 (c)	Antenna Requirement	PASS	
15.207	AC Power Line Conducted Emission	PASS	
15.247 (b)(1)	Conducted Peak Output Power	PASS	
15.247 (a)(1)	20dB Occupied Bandwidth 99% OCB	PASS	
15.247 (a)(1)	Carrier Frequencies Separation	PASS	
15.247 (a)(1)(iii)	Hopping Channel Number	PASS	
15.247 (a)(1)(iii)	Dwell Time	PASS	
15.205/15.209	Radiated Emission and Restricted Band	PASS	
15.247(d)	Conducted Unwanted emissions and Band Edge	PASS	

NOTE:

(1) " N/A" denotes test is not applicable in this Test Report

2.1 TEST FACILITY

BSL TESTING CO., LTD

Add. : 1/F, Building B, Xinshidai GR Park, Shiyao Street, Bao'an District, Shenzhen, Shiyao Street
Bao'an District, Shenzhen, Guangdong, 518052, People's Republic of China

FCC Test Firm Registration Number: 562200

Designation Number: CN1338

IC Registered No.: 11093A

Designation Number: CN0019

2.2 MEASUREMENT UNCERTAINTY

The reported uncertainty of measurement $y \pm U$, where expanded uncertainty U is based on a standard uncertainty multiplied by a coverage factor of $k=2$, providing a level of confidence of approximately 95%.

No.	Item	Uncertainty
1	Conducted Emission Test	$\pm 1.38\text{dB}$
2	RF power conducted	$\pm 0.16\text{dB}$
3	Spurious emissions conducted	$\pm 0.21\text{dB}$
4	All emissions radiated(<1G)	$\pm 4.68\text{dB}$
5	All emissions radiated(>1G)	$\pm 4.89\text{dB}$
6	Temperature	$\pm 0.5^\circ\text{C}$
7	Humidity	$\pm 2\%$

3. GENERAL INFORMATION**3.1 GENERAL DESCRIPTION OF EUT**

Applicant:	SHENZHEN CACGO INTELLIGENT TECHNOLOGY CO.,LTD
Address of applicant:	Room 4009, 4F, Hasee Industrial park, Beier Road, Bantian, LongGang District,Shenzhen,China
Manufacturer:	SHENZHEN CACGO INTELLIGENT TECHNOLOGY CO.,LTD
Address of manufacturer:	Room 4009, 4F, Hasee Industrial park, Beier Road, Bantian, LongGang District,Shenzhen,China
Product Name:	Smart watch
Model No.:	K56PRO
Model Different.:	N/A
Sample ID	2A448-K56PRO
Sample(s) Status:	Engineer sample
Channel numbers:	79
Operation Frequency:	2402MHz~2480MHz
Modulation technology:	GFSK, $\pi/4$ -DQPSK, 8-DPSK
Antenna Type:	Cable Antenna
Antenna gain:	-0.84dBi
Power supply:	Input: DC 3.7V

Operation Frequency each of channel							
Channel	Frequency	Channel	Frequency	Channel	Frequency	Channel	Frequency
1	2402MHz	21	2422MHz	41	2442MHz	61	2462MHz
2	2403MHz	22	2423MHz	42	2443MHz	62	2463MHz
3	2404MHz	23	2424MHz	43	2444MHz	63	2464MHz
4	2405MHz	24	2425MHz	44	2445MHz	64	2465MHz
5	2406MHz	25	2426MHz	45	2446MHz	65	2466MHz
6	2407MHz	26	2427MHz	46	2447MHz	66	2467MHz
7	2408MHz	27	2428MHz	47	2448MHz	67	2468MHz
8	2409MHz	28	2429MHz	48	2449MHz	68	2469MHz
9	2410MHz	29	2430MHz	49	2450MHz	69	2470MHz
10	2411MHz	30	2431MHz	50	2451MHz	70	2471MHz
11	2412MHz	31	2432MHz	51	2452MHz	71	2472MHz
12	2413MHz	32	2433MHz	52	2453MHz	72	2473MHz
13	2414MHz	33	2434MHz	53	2454MHz	73	2474MHz
14	2415MHz	34	2435MHz	54	2455MHz	74	2475MHz
15	2416MHz	35	2436MHz	55	2456MHz	75	2476MHz
16	2417MHz	36	2437MHz	56	2457MHz	76	2477MHz

17	2418MHz	37	2438MHz	57	2458MHz	77	2478MHz
18	2419MHz	38	2439MHz	58	2459MHz	78	2479MHz
19	2420MHz	39	2440MHz	59	2460MHz	79	2480MHz
20	2421MHz	40	2441MHz	60	2461MHz		

All Bluetooth units participating in the piconet are time and hop-synchronized to the channel.

Example of a 79 hopping sequence in data mode:

35, 27, 6, 44, 14, 61, 74, 32, 1, 11, 23, 2, 55, 65, 29, 3, 9, 52, 78, 58, 40, 25, 0, 7, 18, 26, 76, 60, 47, 50, 2, 5, 16, 37, 70, 63, 66, 54, 20, 13, 4, 8, 15, 21, 26, 10, 73, 77, 67, 69, 43, 24, 57, 39, 46, 72, 48, 33, 17, 31, 75, 19, 41, 62, 68, 28, 51, 66, 30, 56, 34, 59, 71, 22, 49, 64, 38, 45, 36, 53, 42

Each Frequency used equally on the average by each transmitter

Note:

In section 15.31(m), regards to the operating frequency range over 10 MHz, the Lowest frequency, the middle frequency, and the highest frequency of channel were selected to perform the test, and the selected channel see below:

Test channel	Frequency
The lowest channel	2402MHz
The middle channel	2441MHz
The Highest channel	2480MHz

Note:This EUT supports DH1/DH3/DH5/2DH1/2DH3/2DH5/3DH1/3DH3/3DH5, Only DH5/2DH5/3DH5 record in this report

3.2 Test Setup Configuration

Conducted Emission



Radiated Emission

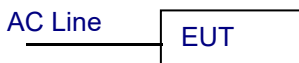

Conducted Spurious

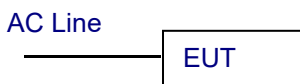

3.3 Support Equipment

The EUT has been tested as an independent unit together with other necessary accessories or support units. The following support units or accessories were used to form a representative test configuration during the tests.

Item	Equipment	Mfr/Brand	Model/Type No.	Series No.	Note
/	ADAPTER	/	ADS-5001000C	/	DC 5V/1A

Item	Shielded Type	Ferrite Core	Length	Note

Note:

- (1) The support equipment was authorized by Declaration of Confirmation.
- (2) For detachable type I/O cable should be specified the length in cm in 『Length』 column.

3.4 Test Mode

Transmitting mode	Keep the EUT in continuously transmitting mode.
Remark: During the test, the test voltage was tuned from 85% to 115% of the nominal rated supply voltage, and found that the worst case was under the nominal rated supply condition. So the report just shows that condition's data.	

Test Software	BT Test Tool
Power level setup	<7dBm

3.5 EQUIPMENTS LIST FOR ALL TEST ITEMS

Radiation Test equipment

Item	Equipment	Manufacturer	Type No.	Serial No.	Last calibration	Calibrated until
1	Communication Tester	Rohde & Schwarz	CMW500	100358 Fireware: 4.43 SP4	Oct. 22, 2022	Oct. 21, 2023
2	Spectrum Analyzer	KEYSIGHT	9020A	MY55370835	Oct. 22, 2022	Oct. 21, 2023
3	Test Receiver	R&S	ESCI7	US47140102 Fireware: 4.42 SP3	Oct. 22, 2022	Oct. 21, 2023
4	Signal Generator	HP	83630B	3844A01028	Oct. 22, 2022	Oct. 21, 2023
5	Signal Generator	IFR	2023A	202307/242	Oct. 22, 2022	Oct. 21, 2023
6	Amplifier	Agilent	8449B	4035A00116	Oct. 22, 2022	Oct. 21, 2023
7	Amplifier	HP	8447E	2945A02770	Oct. 22, 2022	Oct. 21, 2023
8	Broadband Antenna	SCHAFFNER	2774	2774	Feb.28,2022	Feb.27,2025
9	Biconical and log periodic antennas	ELECTRO-METRICS	EM-6917B-1	171	Feb.28,2022	Feb.27,2025
10	Horn Antenna	R&S	HF906	100253	Feb.28,2022	Feb.27,2025
11	Horn Antenna	Schwarzbeck	BBHA9170	00814	Feb.28,2022	Feb.27,2025
12	Horn Antenna	EM	EM-6961	6462	Feb.28,2022	Feb.27,2025
13	3m Semi-Anechoic Chamber	Chengyu Electron	9 (L)*6 (W)* 6 (H)	BSL086	Feb.28,2022	Feb.27,2025
14	Loop Antenna	ZHINAN	ZN30900C	20073	Feb.28,2022	Feb.27,2025
15	power meter	DARE	RPR3006W	15I00041SNO0	Feb.28,2022	Feb.27,2025
16	RF Control Unit	MWRftest	Mw100	-	Feb.28,2022	Feb.27,2025
17	Test software	MWRftest	V8310	-	-	-
18	Turntable	MF	MF-7802BS	N/A	\	\
19	Antenna tower	MF	MF-7802BS	N/A	\	\
20	Signal Generator	Agilent	N5182A	N/A	Oct. 22, 2022	Oct. 21, 2023

Conduction Test equipment

Item	Kind of Equipment	Manufacturer	Type No.	Serial No.	Last calibration	Calibrated until
1	LISN	R&S	ENV216	101471	Oct. 22, 2022	Oct. 21, 2023
2	LISN	CYBERTEK	EM5040A	E1850400149	Oct. 22, 2022	Oct. 21, 2023
3	Test Cable	N/A	C01	N/A	Oct. 18, 2022	Oct. 17, 2023
4	Test Cable	N/A	C02	N/A	Oct. 18, 2022	Oct. 17, 2023
5	EMI Test Receiver	R&S	ESCI3	101393	Oct. 17, 2022	Oct. 16, 2023
6	Absorbing Clamp	DZ	ZN23201	15034	Oct. 17, 2022	Oct. 16, 2023
7	EMC Software	Frad	EZ-EMC	Ver.EMC-CON 3A1.1	\	\

RF Conduction Test equipment

Item	Kind of Equipment	Manufacturer	Type No.	Serial No.	Last calibration	Calibrated until
1	Spectrum Analyzer (9kHz-26.5GHz)	KEYSIGHT	9020A	MY55370835	Oct. 17, 2022	Oct. 16, 2023
2	MWRF Power Meter Test system	MW	MW100-RPCB	N/A	Oct. 17, 2022	Oct. 16, 2023
3	D.C. Power Supply	LongWei	TPR-6405D	N/A	\	\
4	RF Software	MW	MTS8310	V2.0.0.0	\	\

4. EMC EMISSION TEST

4.1 Conducted emissions

Test Requirement:	FCC Part15 C Section 15.207
Test Method:	ANSI C63.10:2013
Test Frequency Range:	150KHz to 30MHz
Receiver setup:	RBW=9KHz, VBW=30KHz, Sweep time=auto

4.1.1 POWER LINE CONDUCTED EMISSION Limits

FREQUENCY (MHz)	Limit (dBuV)		Standard
	Quasi-peak	Average	
0.15 -0.5	66 - 56 *	56 - 46 *	FCC
0.50 -5.0	56.00	46.00	FCC
5.0 -30.0	60.00	50.00	FCC

Note:

(1) *Decreases with the logarithm of the frequency.

4.1.2 TEST PROCEDURE

- a. The EUT was placed 0.8 meters from the horizontal ground plane with EUT being connected to the power mains through a line impedance stabilization network (LISN). All other support equipments powered from additional LISN(s). The LISN provide 50 Ohm/ 50uH of coupling impedance for the measuring instrument.
- b. Interconnecting cables that hang closer than 40 cm to the ground plane shall be folded back and forth in the center forming a bundle 30 to 40 cm long.
- c. I/O cables that are not connected to a peripheral shall be bundled in the center. The end of the cable may be terminated, if required, using the correct terminating impedance. The overall length shall not exceed 1 m.
- d. LISN at least 80 cm from nearest part of EUT chassis.
- e. For the actual test configuration, please refer to the related Item –EUT Test Photos.

4.1.3 DEVIATION FROM TEST STANDARD

No deviation

4.1.4 TEST SETUP

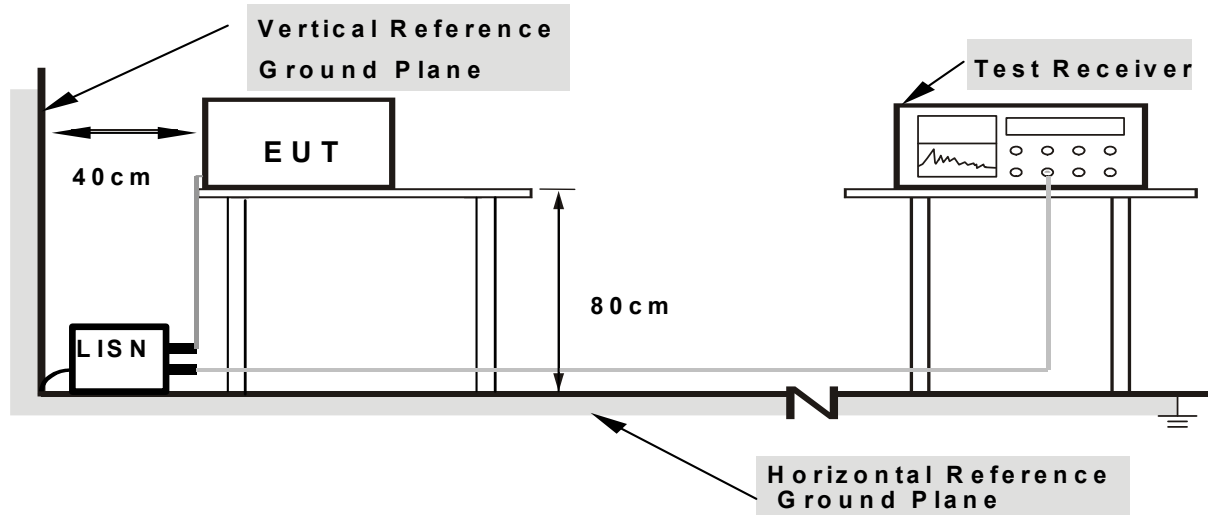

Note: 1.Support units were connected to second LISN.

2.Both of LISNs (AMN) are 80 cm from EUT and at least 80 from other units and other metal planes

4.1.5 EUT OPERATING CONDITIONS

The EUT was configured for testing in a typical fashion (as a customer would normally use it). The EUT has been programmed to continuously transmit during test. This operating condition was tested and used to collect the included data.

We pretest AC 120V and AC 230V, the worst voltage was AC 120V and the data recording in the report.

4.1.6 Test Result (Worst case GFSK 2402MHz)

Temperature:	26°C	Relative Humidity:	54%
Pressure:	101kPa	Phase :	L
Test Voltage :	AC 120V/60Hz		

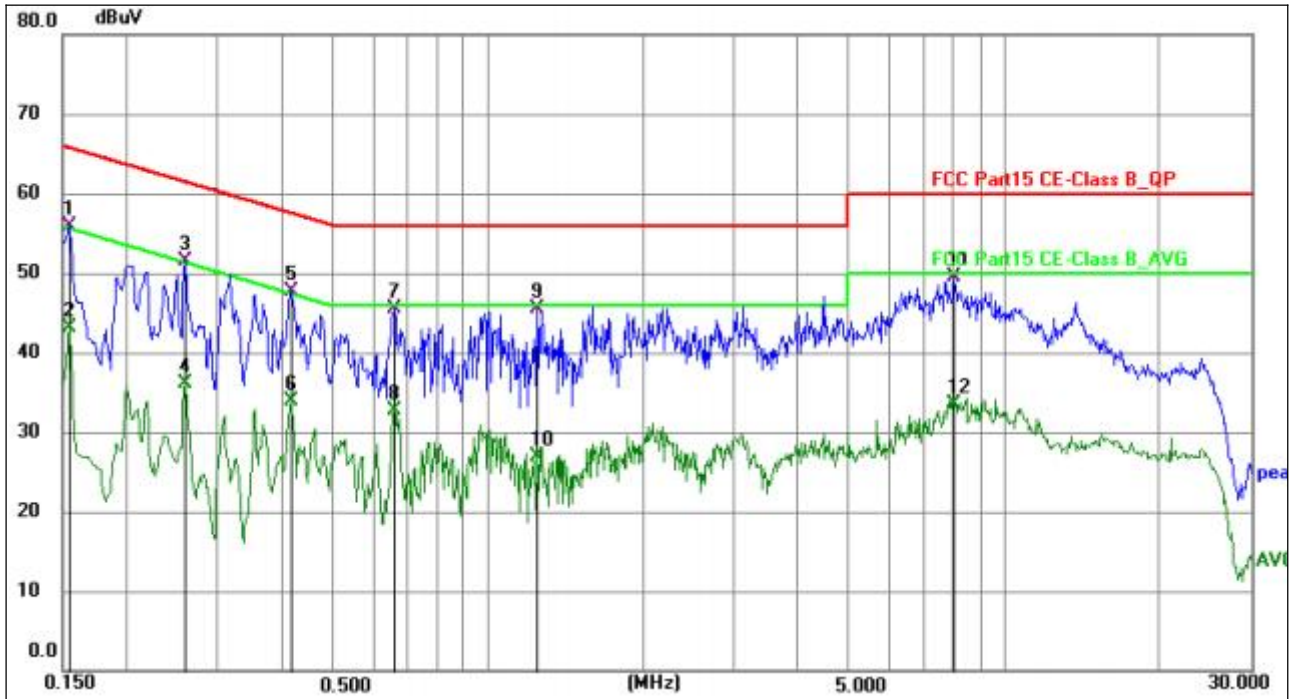

No.	Frequency (MHz)	Reading (dBuV)	Factor (dB)	Level (dBuV)	Limit (dBuV)	Margin (dB)	Detector	P/F	Remark
1	0.1544	46.28	9.53	55.81	65.76	-9.95	QP	P	
2	0.1544	33.57	9.53	43.10	55.76	-12.66	AVG	P	
3	0.2580	41.82	9.69	51.51	61.50	-9.99	QP	P	
4	0.2580	26.46	9.69	36.15	51.50	-15.35	AVG	P	
5 *	0.4153	38.01	9.64	47.65	57.54	-9.89	QP	P	
6	0.4153	24.33	9.64	33.97	47.54	-13.57	AVG	P	
7	0.6582	35.86	9.70	45.56	56.00	-10.44	QP	P	
8	0.6582	23.06	9.70	32.76	46.00	-13.24	AVG	P	
9	1.2479	36.01	9.57	45.58	56.00	-10.42	QP	P	
10	1.2479	17.40	9.57	26.97	46.00	-19.03	AVG	P	
11	8.0022	39.91	9.61	49.52	60.00	-10.48	QP	P	
12	8.0022	23.98	9.61	33.59	50.00	-16.41	AVG	P	

Notes:

- 1.An initial pre-scan was performed on the line and neutral lines with peak detector.
- 2.Quasi-Peak and Average measurement were performed at the frequencies with maximized peak emission.
- 3.Measurement Level = Reading level + Correct Factor

Temperature:	26°C	Relative Humidity:	54%
Pressure:	101kPa	Phase :	N
Test Voltage :	AC 120V/60Hz		

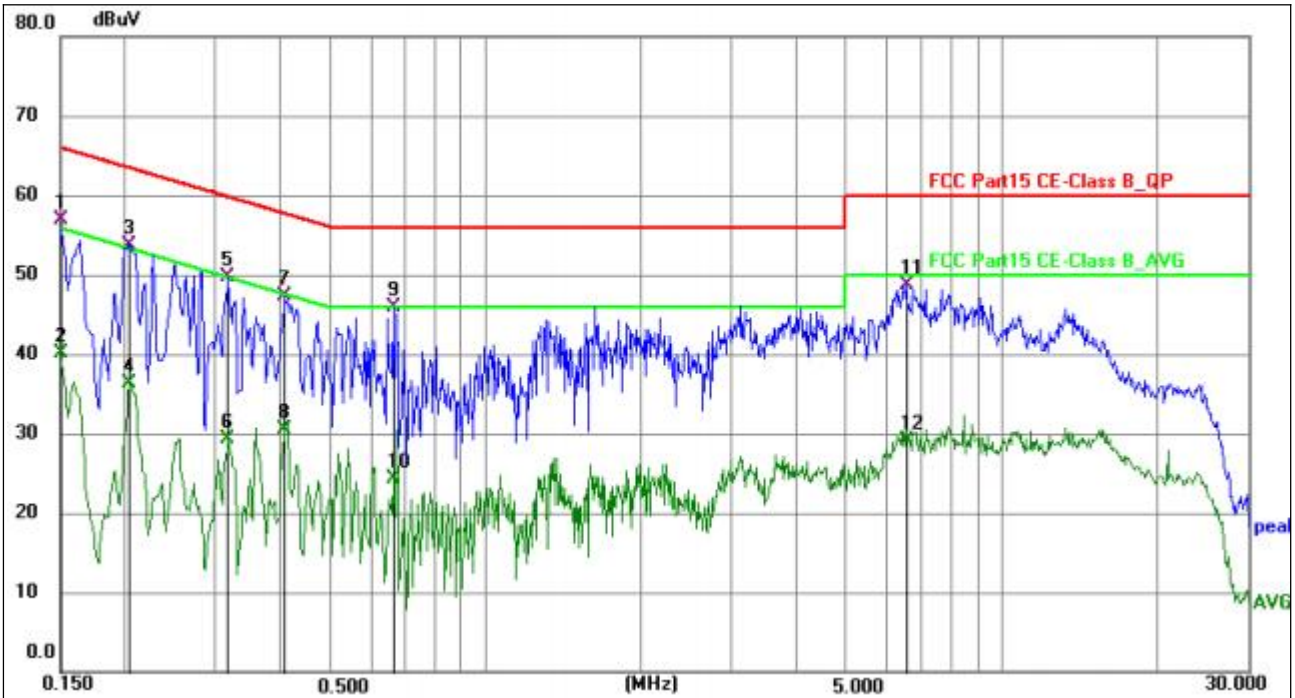

No.	Frequency (MHz)	Reading (dBuV)	Factor (dB)	Level (dBuV)	Limit (dBuV)	Margin (dB)	Detector	P/F	Remark
1 *	0.1500	47.47	9.51	56.98	66.00	-9.02	QP	P	
2	0.1500	30.69	9.51	40.20	56.00	-15.80	AVG	P	
3	0.2038	43.94	9.71	53.65	63.45	-9.80	QP	P	
4	0.2038	26.64	9.71	36.35	53.45	-17.10	AVG	P	
5	0.3165	40.03	9.67	49.70	59.80	-10.10	QP	P	
6	0.3165	19.67	9.67	29.34	49.80	-20.46	AVG	P	
7	0.4062	37.65	9.64	47.29	57.73	-10.44	QP	P	
8	0.4062	20.94	9.64	30.58	47.73	-17.15	AVG	P	
9	0.6630	36.19	9.70	45.89	56.00	-10.11	QP	P	
10	0.6630	14.57	9.70	24.27	46.00	-21.73	AVG	P	
11	6.5308	39.21	9.53	48.74	60.00	-11.26	QP	P	
12	6.5308	19.67	9.53	29.20	50.00	-20.80	AVG	P	

Notes:
 1.An initial pre-scan was performed on the line and neutral lines with peak detector.
 2.Quasi-Peak and Average measurement were performed at the frequencies with maximized peak emission.
 3.Measurement Level = Reading level + Correct Factor

4.2 Radiated emissions

Test Requirement:	FCC Part15 C Section 15.209				
Test Method:	ANSI C63.10:2013				
Test Frequency Range:	9kHz to 25GHz				
Test site:	Measurement Distance: 3m				
Receiver setup:	Frequency	Detector	RBW	VBW	Value
	9KHz-150KHz	Quasi-peak	200Hz	600Hz	Quasi-peak
	150KHz-30MHz	Quasi-peak	9KHz	30KHz	Quasi-peak
	30MHz-1GHz	Quasi-peak	100KHz	300KHz	Quasi-peak
	Above 1GHz	Peak	1MHz	3MHz	Peak
		Peak	1MHz	10Hz	Average

4.2.1 Radiated Emission Limits

Frequencies (MHz)	Field Strength (micровolts/meter)	Measurement Distance (meters)
0.009~0.490	2400/F(KHz)	300
0.490~1.705	24000/F(KHz)	30
1.705~30.0	30	30
30~88	100	3
88~216	150	3
216~960	200	3
Above 960	500	3

LIMITS OF RADIATED EMISSION MEASUREMENT

FREQUENCY (MHz)	Limit (dBuV/m) (at 3M)	
	PEAK	AVERAGE
Above 1000	74	54

Notes:

- (1) The limit for radiated test was performed according to FCC PART 15C.
- (2) The tighter limit applies at the band edges.
- (3) Emission level (dBuV/m)=20log Emission level (uV/m).

4.2.2 TEST PROCEDURE

Below 1GHz test procedure as below:

- a. The EUT was placed on the top of a rotating table 0.1 meters above the ground at a 3 meter semi-anechoic chamber. The table was rotated 360 degrees to determine the position of the highest radiation.
- b. The EUT was set 3 meters away from the interference-receiving antenna, which was mounted on the top of a variable-height antenna tower.
- c. The antenna height is varied from one meter to four meters above the ground to determine the maximum value of the field strength. Both horizontal and vertical polarizations of the antenna are set to make the measurement.

- d. For each suspected emission, the EUT was arranged to its worst case and then the antenna was tuned to heights from 1 meter to 4 meters (for the test frequency of below 30MHz, the antenna was tuned to heights 1 meter) and the rotatable table was turned from 0 degrees to 360 degrees to find the maximum reading.
- e. The test-receiver system was set to Peak Detect Function and Specified Bandwidth with Maximum Hold Mode.
- f. If the emission level of the EUT in peak mode was 10dB lower than the limit specified, then testing could be stopped and the peak values of the EUT would be reported. Otherwise the emissions that did not have 10dB margin would be re-tested one by one using peak, quasi-peak or average method as specified and then reported in a data sheet.

Above 1GHz test procedure as below:

- g. Different between above is the test site, change from Semi- Anechoic Chamber to fully Anechoic Chamber and change form table 0.8 metre to 1.5 metre(Above 18GHz the distance is 1 meter and table is 1.5 metre).
- h. Test the EUT in the lowest channel ,the middle channel ,the Highest channel

Note:

Both horizontal and vertical antenna polarities were tested and performed pretest to three orthogonal axis. The worst case emissions were reported

4.2.3 DEVIATION FROM TEST STANDARD

No deviation

4.2.4 TEST SETUP

(A) Radiated Emission Test-Up Frequency Below 30MHz

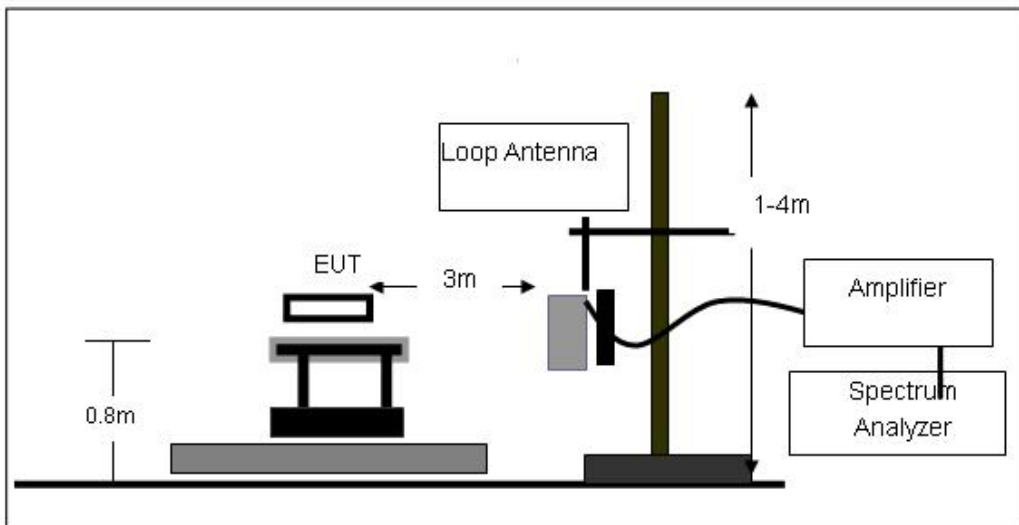

(B) Radiated Emission Test-Up Frequency 30MHz~1GHz

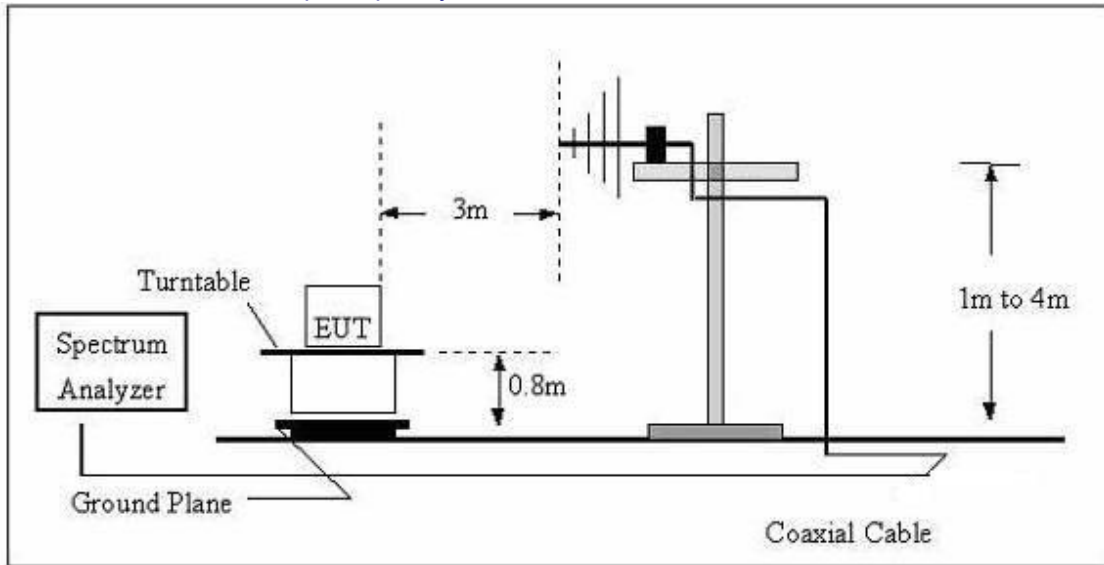

(C) Radiated Emission Test-Up Frequency Above 1GHz

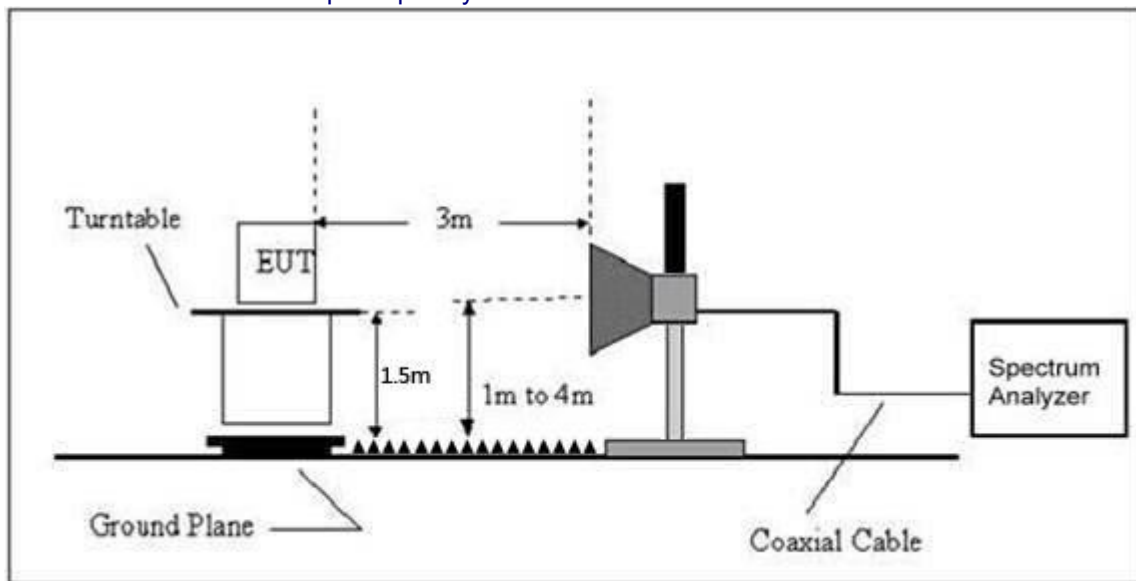

4.2.5 EUT OPERATING CONDITIONS

The EUT tested system was configured as the statements of 2.4 Unless otherwise a special operating condition is specified in the follows during the testing.

4.2.6 TEST RESULTS

Between 9KHz – 30MHz

The emission from 9 kHz to 30MHz was pre-tested and found the result was 20dB lower than the limit, and according to 15.31(o) & RSS-Gen 6.13, the test result no need to reported.

Between 30MHz – 1GHz (Worst case GFSK 2402MHz)

Temperature:	26°C	Relative Humidity:	54%
Pressure:	101 kPa	Polarization:	Horizontal
Test Voltage:	AC 120V/60Hz		

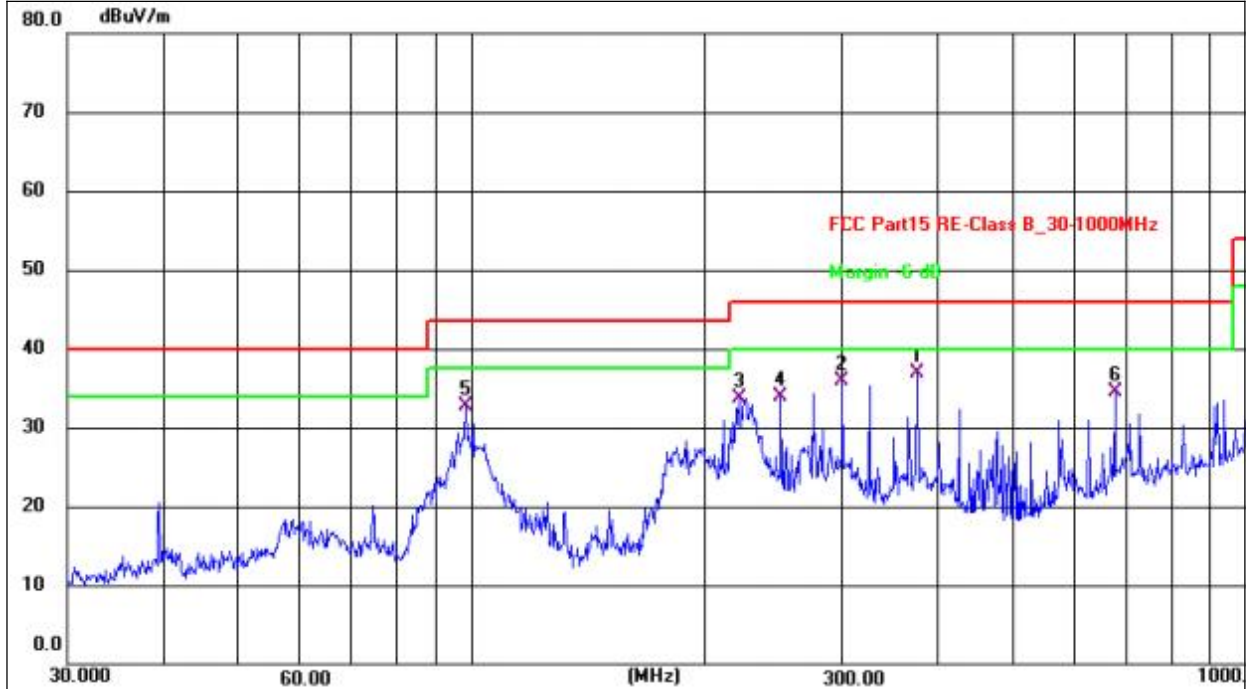

No.	Frequency (MHz)	Reading (dBuV)	Factor (dB/m)	Level (dBuV/m)	Limit (dBuV/m)	Margin (dB)	Detector
1 *	375.9385	51.06	-14.11	36.95	46.00	-9.05	QP
2	300.3672	51.62	-15.63	35.99	46.00	-10.01	QP
3	221.3921	52.93	-19.17	33.76	46.00	-12.24	QP
4	250.3012	51.72	-17.82	33.90	46.00	-12.10	QP
5	98.1418	52.82	-20.03	32.79	43.50	-10.71	QP
6	675.2080	41.63	-7.21	34.42	46.00	-11.58	QP

Temperature:	26°C	Relative Humidity:	54%
Pressure:	101kPa	Polarization:	Vertical
Test Voltage:	AC 120V/60Hz		

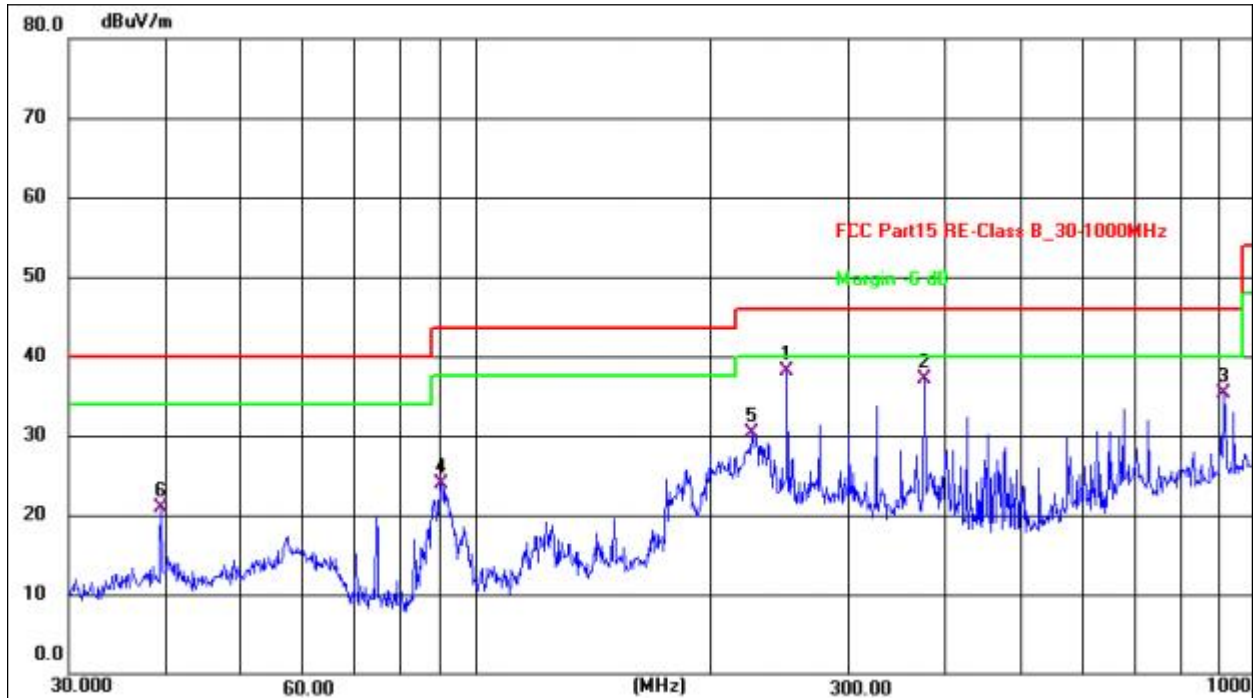

No.	Frequency (MHz)	Reading (dBuV)	Factor (dB/m)	Level (dBuV/m)	Limit (dBuV/m)	Margin (dB)	Detector
1 *	250.3012	55.83	-17.82	38.01	46.00	-7.99	QP
2	375.9385	51.18	-14.11	37.07	46.00	-8.93	QP
3	909.6667	38.63	-3.42	35.21	46.00	-10.79	QP
4	90.2205	44.14	-20.22	23.92	43.50	-19.58	QP
5	225.3080	49.19	-18.96	30.23	46.00	-15.77	QP
6	39.4371	36.62	-15.78	20.84	40.00	-19.16	QP

Remarks:

- 1.Final Level =Receiver Read level + Antenna Factor + Cable Loss
- 2.The emission levels of other frequencies are very lower than the limit and not show in test report.
- 3.The test data shows only the worst case GFSK mode

1GHz~25GHz

GFSK

Polar (H/V)	Frequency	Meter Reading	Pre-ampli fier	Cable Loss	Antenna Factor	Emission Level	Limits	Margin	Detector Type
	(MHz)	(dBuV)	(dB)	(dB)	(dB)	(dBuV/m)	(dBuV/m)	(dB)	
Low Channel:2402MHz									
V	4804.00	50.13	30.55	5.77	24.66	51.89	74.00	-22.11	Pk
V	4804.00	43.14	30.55	5.77	24.66	43.02	54.00	-10.98	AV
V	7206.00	54.84	30.33	6.32	24.55	55.38	74.00	-18.62	Pk
V	7206.00	43.11	30.33	6.32	24.55	43.65	54.00	-10.35	AV
V	9608.00	54.68	30.85	7.45	24.69	55.97	74.00	-18.03	Pk
V	9608.00	43.19	30.85	7.45	24.69	44.48	54.00	-9.52	AV
V	12010.00	54.60	31.02	8.99	25.57	58.14	74.00	-15.86	Pk
V	12010.00	43.99	31.02	8.99	25.57	47.53	54.00	-6.47	AV
H	4804.00	54.98	30.55	5.77	24.66	54.86	74.00	-19.14	Pk
H	4804.00	43.63	30.55	5.77	24.66	43.51	54.00	-10.49	AV
H	7206.00	50.50	30.33	6.32	24.55	51.04	74.00	-22.96	Pk
H	7206.00	43.85	30.33	6.32	24.55	44.39	54.00	-9.61	AV
H	9608.00	52.26	30.85	7.45	24.69	53.55	74.00	-20.45	Pk
H	9608.00	43.56	30.85	7.45	24.69	44.85	54.00	-9.15	AV
H	12010.00	50.09	31.02	8.99	25.57	53.63	74.00	-20.37	Pk
H	12010.00	43.95	31.02	8.99	25.57	47.49	54.00	-6.51	AV

Polar (H/V)	Frequency	Meter Reading	Pre-ampli fier	Cable Loss	Antenna Factor	Emission Level	Limits	Margin	Detector Type
	(MHz)	(dBuV)	(dB)	(dB)	(dB)	(dBuV/m)	(dBuV/m)	(dB)	
Middle Channel:2441MHz									
V	4882.00	53.15	30.55	5.77	24.66	53.03	74.00	-20.97	Pk
V	4882.00	43.51	30.55	5.77	24.66	43.39	54.00	-10.61	AV
V	7323.00	54.27	30.33	6.32	24.55	54.81	74.00	-19.19	Pk
V	7323.00	43.82	30.33	6.32	24.55	44.36	54.00	-9.64	AV
V	9764.00	51.54	30.85	7.45	24.69	52.83	74.00	-21.17	Pk
V	9764.00	43.39	30.85	7.45	24.69	44.68	54.00	-9.32	AV
V	12205.00	52.28	31.02	8.99	25.57	55.82	74.00	-18.18	Pk
V	12205.00	43.36	31.02	8.99	25.57	46.90	54.00	-7.10	AV
H	4882.00	50.31	30.55	5.77	24.66	50.19	74.00	-23.81	Pk
H	4882.00	43.74	30.55	5.77	24.66	43.62	54.00	-10.38	AV
H	7323.00	51.17	30.33	6.32	24.55	51.71	74.00	-22.29	Pk
H	7323.00	43.94	30.33	6.32	24.55	44.48	54.00	-9.52	AV
H	9764.00	50.63	30.85	7.45	24.69	51.92	74.00	-22.08	Pk
H	9764.00	43.83	30.85	7.45	24.69	45.12	54.00	-8.88	AV
H	12205.00	54.69	31.02	8.99	25.57	58.23	74.00	-15.77	Pk
H	12205.00	43.44	31.02	8.99	25.57	46.98	54.00	-7.02	AV

Polar (H/V)	Frequency	Meter Reading	Pre-ampli fier	Cable Loss	Antenna Factor	Emission Level	Limits	Margin	Detector Type
	(MHz)	(dBuV)	(dB)	(dB)	(dB)	(dBuV/m)	(dBuV/m)	(dB)	
High Channel:2480MHz									
V	4960.00	50.17	30.55	5.77	24.66	50.05	74.00	-23.95	Pk
V	4960.00	43.73	30.55	5.77	24.66	43.61	54.00	-10.39	AV
V	7440.00	50.98	30.33	6.32	24.55	51.52	74.00	-22.48	Pk
V	7440.00	43.36	30.33	6.32	24.55	43.90	54.00	-10.10	AV
V	9920.00	52.32	30.85	7.45	24.69	53.61	74.00	-20.39	Pk
V	9920.00	43.17	30.85	7.45	24.69	44.46	54.00	-9.54	AV
V	12400.00	52.74	31.02	8.99	25.57	56.28	74.00	-17.72	Pk
V	12400.00	43.13	31.02	8.99	25.57	46.67	54.00	-7.33	AV
H	4960.00	53.09	30.55	5.77	24.66	52.97	74.00	-21.03	Pk
H	4960.00	43.59	30.55	5.77	24.66	43.47	54.00	-10.53	AV
H	7440.00	51.74	30.33	6.32	24.55	52.28	74.00	-21.72	Pk
H	7440.00	43.51	30.33	6.32	24.55	44.05	54.00	-9.95	AV
H	9920.00	51.66	30.85	7.45	24.69	52.95	74.00	-21.05	Pk
H	9920.00	43.75	30.85	7.45	24.69	45.04	54.00	-8.96	AV
H	12400.00	53.63	31.02	8.99	25.57	57.17	74.00	-16.83	Pk
H	12400.00	43.66	31.02	8.99	25.57	47.20	54.00	-6.80	AV

Remark:

1. Emission Level = Meter Reading + Antenna Factor + Cable Loss – Pre-amplifier,
Margin= Emission Level - Limit
2. If peak below the average limit, the average emission was no test.
3. The amplitude of spurious emissions which are attenuated by more than 20dB below the permissible value has no need to be reported.

$\pi/4$ -DQPSK

Polar (H/V)	Frequency	Meter Reading	Pre-amplifier	Cable Loss	Antenna Factor	Emission Level	Limits	Margin	Detector Type
	(MHz)	(dBuV)	(dB)	(dB)	(dB)	(dBuV/m)	(dBuV/m)	(dB)	
Low Channel:2402MHz									
V	4804.00	51.95	30.55	5.77	24.66	51.83	74.00	-22.17	Pk
V	4804.00	43.82	30.55	5.77	24.66	43.70	54.00	-10.30	AV
V	7206.00	52.54	30.33	6.32	24.55	53.08	74.00	-20.92	Pk
V	7206.00	43.33	30.33	6.32	24.55	43.87	54.00	-10.13	AV
V	9608.00	54.36	30.85	7.45	24.69	55.65	74.00	-18.35	Pk
V	9608.00	43.10	30.85	7.45	24.69	44.39	54.00	-9.61	AV
V	12010.00	54.81	31.02	8.99	25.57	58.35	74.00	-15.65	Pk
V	12010.00	43.26	31.02	8.99	25.57	46.80	54.00	-7.20	AV
H	4804.00	51.63	30.55	5.77	24.66	51.51	74.00	-22.49	Pk
H	4804.00	43.88	30.55	5.77	24.66	43.76	54.00	-10.24	AV
H	7206.00	50.82	30.33	6.32	24.55	51.36	74.00	-22.64	Pk
H	7206.00	43.60	30.33	6.32	24.55	44.14	54.00	-9.86	AV
H	9608.00	51.13	30.85	7.45	24.69	52.42	74.00	-21.58	Pk
H	9608.00	43.30	30.85	7.45	24.69	44.59	54.00	-9.41	AV
H	12010.00	50.22	31.02	8.99	25.57	53.76	74.00	-20.24	Pk
H	12010.00	43.14	31.02	8.99	25.57	46.68	54.00	-7.32	AV

Polar (H/V)	Frequency	Meter Reading	Pre-amplifier	Cable Loss	Antenna Factor	Emission Level	Limits	Margin	Detector Type
	(MHz)	(dBuV)	(dB)	(dB)	(dB)	(dBuV/m)	(dBuV/m)	(dB)	
Middle Channel:2441MHz									
V	4882.00	52.60	30.55	5.77	24.66	52.48	74.00	-21.52	Pk
V	4882.00	43.57	30.55	5.77	24.66	43.45	54.00	-10.55	AV
V	7323.00	50.57	30.33	6.32	24.55	51.11	74.00	-22.89	Pk
V	7323.00	43.72	30.33	6.32	24.55	44.26	54.00	-9.74	AV
V	9764.00	54.07	30.85	7.45	24.69	55.36	74.00	-18.64	Pk
V	9764.00	43.84	30.85	7.45	24.69	45.13	54.00	-8.87	AV
V	12205.00	54.55	31.02	8.99	25.57	58.09	74.00	-15.91	Pk
V	12205.00	43.08	31.02	8.99	25.57	46.62	54.00	-7.38	AV
H	4882.00	53.98	30.55	5.77	24.66	53.86	74.00	-20.14	Pk
H	4882.00	43.80	30.55	5.77	24.66	43.68	54.00	-10.32	AV
H	7323.00	51.46	30.33	6.32	24.55	52.00	74.00	-22.00	Pk
H	7323.00	43.04	30.33	6.32	24.55	43.58	54.00	-10.42	AV
H	9764.00	50.37	30.85	7.45	24.69	51.66	74.00	-22.34	Pk
H	9764.00	43.94	30.85	7.45	24.69	45.23	54.00	-8.77	AV
H	12205.00	53.44	31.02	8.99	25.57	56.98	74.00	-17.02	Pk
H	12205.00	43.22	31.02	8.99	25.57	46.76	54.00	-7.24	AV

Polar (H/V)	Frequency	Meter Reading	Pre-ampli fier	Cable Loss	Antenna Factor	Emission Level	Limits	Margin	Detector Type
	(MHz)	(dBuV)	(dB)	(dB)	(dB)	(dBuV/m)	(dBuV/m)	(dB)	
High Channel:2480MHz									
V	4960.00	53.87	30.55	5.77	24.66	53.75	74.00	-20.25	Pk
V	4960.00	43.42	30.55	5.77	24.66	43.30	54.00	-10.70	AV
V	7440.00	52.03	30.33	6.32	24.55	52.57	74.00	-21.43	Pk
V	7440.00	43.62	30.33	6.32	24.55	44.16	54.00	-9.84	AV
V	9920.00	53.06	30.85	7.45	24.69	54.35	74.00	-19.65	Pk
V	9920.00	43.19	30.85	7.45	24.69	44.48	54.00	-9.52	AV
V	12400.00	52.00	31.02	8.99	25.57	55.54	74.00	-18.46	Pk
V	12400.00	43.16	31.02	8.99	25.57	46.70	54.00	-7.30	AV
H	4960.00	53.84	30.55	5.77	24.66	53.72	74.00	-20.28	Pk
H	4960.00	43.96	30.55	5.77	24.66	43.84	54.00	-10.16	AV
H	7440.00	51.16	30.33	6.32	24.55	51.70	74.00	-22.30	Pk
H	7440.00	43.14	30.33	6.32	24.55	43.68	54.00	-10.32	AV
H	9920.00	51.89	30.85	7.45	24.69	53.18	74.00	-20.82	Pk
H	9920.00	43.10	30.85	7.45	24.69	44.39	54.00	-9.61	AV
H	12400.00	50.90	31.02	8.99	25.57	54.44	74.00	-19.56	Pk
H	12400.00	43.31	31.02	8.99	25.57	46.85	54.00	-7.15	AV

Remark:

1. Emission Level = Meter Reading + Antenna Factor + Cable Loss – Pre-amplifier,
Margin= Emission Level - Limit
2. If peak below the average limit, the average emission was no test.
3. The amplitude of spurious emissions which are attenuated by more than 20dB below the permissible value has no need to be reported.

8-DPSK

Polar (H/V)	Frequency	Meter Reading	Pre-ampli fier	Cable Loss	Antenna Factor	Emission Level	Limits	Margin	Detector Type
	(MHz)	(dBuV)	(dB)	(dB)	(dB)	(dBuV/m)	(dBuV/m)	(dB)	
Low Channel:2402MHz									
V	4804.00	51.89	30.55	5.77	24.66	51.77	74.00	-22.23	Pk
V	4804.00	43.98	30.55	5.77	24.66	43.86	54.00	-10.14	AV
V	7206.00	51.03	30.33	6.32	24.55	51.57	74.00	-22.43	Pk
V	7206.00	43.54	30.33	6.32	24.55	44.08	54.00	-9.92	AV
V	9608.00	52.80	30.85	7.45	24.69	54.09	74.00	-19.91	Pk
V	9608.00	43.75	30.85	7.45	24.69	45.04	54.00	-8.96	AV
V	12010.00	52.66	31.02	8.99	25.57	56.20	74.00	-17.80	Pk
V	12010.00	43.89	31.02	8.99	25.57	47.43	54.00	-6.57	AV
H	4804.00	54.81	30.55	5.77	24.66	54.69	74.00	-19.31	Pk
H	4804.00	43.44	30.55	5.77	24.66	43.32	54.00	-10.68	AV
H	7206.00	51.36	30.33	6.32	24.55	51.90	74.00	-22.10	Pk
H	7206.00	43.95	30.33	6.32	24.55	44.49	54.00	-9.51	AV
H	9608.00	53.83	30.85	7.45	24.69	55.12	74.00	-18.88	Pk
H	9608.00	43.41	30.85	7.45	24.69	44.70	54.00	-9.30	AV
H	12010.00	54.12	31.02	8.99	25.57	57.66	74.00	-16.34	Pk
H	12010.00	43.79	31.02	8.99	25.57	47.33	54.00	-6.67	AV

Polar (H/V)	Frequency	Meter Reading	Pre-ampli fier	Cable Loss	Antenna Factor	Emission Level	Limits	Margin	Detector Type
	(MHz)	(dBuV)	(dB)	(dB)	(dB)	(dBuV/m)	(dBuV/m)	(dB)	
Middle Channel:2441MHz									
V	4882.00	52.36	30.55	5.77	24.66	52.24	74.00	-21.76	Pk
V	4882.00	43.77	30.55	5.77	24.66	43.65	54.00	-10.35	AV
V	7323.00	53.23	30.33	6.32	24.55	53.77	74.00	-20.23	Pk
V	7323.00	43.94	30.33	6.32	24.55	44.48	54.00	-9.52	AV
V	9764.00	54.63	30.85	7.45	24.69	55.92	74.00	-18.08	Pk
V	9764.00	43.72	30.85	7.45	24.69	45.01	54.00	-8.99	AV
V	12205.00	52.25	31.02	8.99	25.57	55.79	74.00	-18.21	Pk
V	12205.00	43.24	31.02	8.99	25.57	46.78	54.00	-7.22	AV
H	4882.00	54.80	30.55	5.77	24.66	54.68	74.00	-19.32	Pk
H	4882.00	43.61	30.55	5.77	24.66	43.49	54.00	-10.51	AV
H	7323.00	54.06	30.33	6.32	24.55	54.60	74.00	-19.40	Pk
H	7323.00	43.49	30.33	6.32	24.55	44.03	54.00	-9.97	AV
H	9764.00	54.67	30.85	7.45	24.69	55.96	74.00	-18.04	Pk
H	9764.00	43.94	30.85	7.45	24.69	45.23	54.00	-8.77	AV
H	12205.00	51.70	31.02	8.99	25.57	55.24	74.00	-18.76	Pk
H	12205.00	43.06	31.02	8.99	25.57	46.60	54.00	-7.40	AV

Polar (H/V)	Frequency	Meter Reading	Pre-ampli fier	Cable Loss	Antenna Factor	Emission Level	Limits	Margin	Detector Type
	(MHz)	(dBuV)	(dB)	(dB)	(dB)	(dBuV/m)	(dBuV/m)	(dB)	
High Channel:2480MHz									
V	4960.00	54.50	30.55	5.77	24.66	54.38	74.00	-19.62	Pk
V	4960.00	43.83	30.55	5.77	24.66	43.71	54.00	-10.29	AV
V	7440.00	52.77	30.33	6.32	24.55	53.31	74.00	-20.69	Pk
V	7440.00	43.49	30.33	6.32	24.55	44.03	54.00	-9.97	AV
V	9920.00	53.99	30.85	7.45	24.69	55.28	74.00	-18.72	Pk
V	9920.00	43.17	30.85	7.45	24.69	44.46	54.00	-9.54	AV
V	12400.00	50.10	31.02	8.99	25.57	53.64	74.00	-20.36	Pk
V	12400.00	43.31	31.02	8.99	25.57	46.85	54.00	-7.15	AV
H	4960.00	52.23	30.55	5.77	24.66	52.11	74.00	-21.89	Pk
H	4960.00	43.15	30.55	5.77	24.66	43.03	54.00	-10.97	AV
H	7440.00	54.01	30.33	6.32	24.55	54.55	74.00	-19.45	Pk
H	7440.00	43.95	30.33	6.32	24.55	44.49	54.00	-9.51	AV
H	9920.00	50.33	30.85	7.45	24.69	51.62	74.00	-22.38	Pk
H	9920.00	43.11	30.85	7.45	24.69	44.40	54.00	-9.60	AV
H	12400.00	54.35	31.02	8.99	25.57	57.89	74.00	-16.11	Pk
H	12400.00	43.39	31.02	8.99	25.57	46.93	54.00	-7.07	AV

Remark:

1. Emission Level = Meter Reading + Antenna Factor + Cable Loss – Pre-amplifier,
Margin= Emission Level - Limit
2. If peak below the average limit, the average emission was no test.
3. The amplitude of spurious emissions which are attenuated by more than 20dB below the permissible value has no need to be reported.

5. RADIATED BAND EMISSION MEASUREMENT

5.1 Test Requirement:

Test Requirement:	FCC Part15 C Section 15.209 and 15.205				
Test Method:	ANSI C63.10: 2013				
Test Frequency Range:	All of the restrict bands were tested, only the worst band's (2310MHz to 2500MHz) data was showed.				
Test site:	Measurement Distance: 3m				
Receiver setup:	Frequency	Detector	RBW	VBW	Value
	Above 1GHz	Peak	1MHz	3MHz	Peak
		Peak	1MHz	10Hz	Average

LIMITS OF RADIATED EMISSION MEASUREMENT (Above 1000MHz)

FREQUENCY (MHz)	Limit (dBuV/m) (at 3M)	
	PEAK	AVERAGE
Above 1000	74	54

Notes:

- (1) The limit for radiated test was performed according to FCC PART 15C.
- (2) The tighter limit applies at the band edges.
- (3) Emission level (dBuV/m)=20log Emission level (uV/m).

Spectrum Parameter	Setting
Attenuation	Auto
Start Frequency	2300MHz
Stop Frequency	2520
RB / VB (emission in restricted band)	1 MHz / 1 MHz for Peak, 1 MHz / 10Hz for Average

5.2 TEST PROCEDURE

Above 1GHz test procedure as below:

- a. 1. The EUT was placed on the top of a rotating table 1.5 meters above the ground at a 3 meter camber. The table was rotated 360 degrees to determine the position of the highest radiation.
- b. The EUT was set 3 meters away from the interference-receiving antenna, which was mounted on the top of a variable-height antenna tower.
- c. The antenna height is varied from one meter to four meters above the ground to determine the maximum value of the field strength. Both horizontal and vertical polarizations of the antenna are set to make the measurement.
- d. For each suspected emission, the EUT was arranged to its worst case and then the antenna was tuned to heights from 1 meter to 4 meters and the rota table was turned from 0 degrees to 360 degrees to find the maximum reading.
- e. The test-receiver system was set to Peak Detect Function and Specified Bandwidth with Maximum Hold Mode.
- f. If the emission level of the EUT in peak mode was 10dB lower than the limit specified, then testing could be stopped and the peak values of the EUT would be reported. Otherwise the emissions that did not have 10dB margin would be re-tested one by one using peak, quasi-peak or average method as specified and then reported in a data sheet.
- g. Test the EUT in the lowest channel,the Highest channel

Note:

Both horizontal and vertical antenna polarities were tested and performed pretest to three orthogonal axis. The worst case emissions were reported

5.3 DEVIATION FROM TEST STANDARD

No deviation

5.4 TEST SETUP

Radiated Emission Test-Up Frequency Above 1GHz

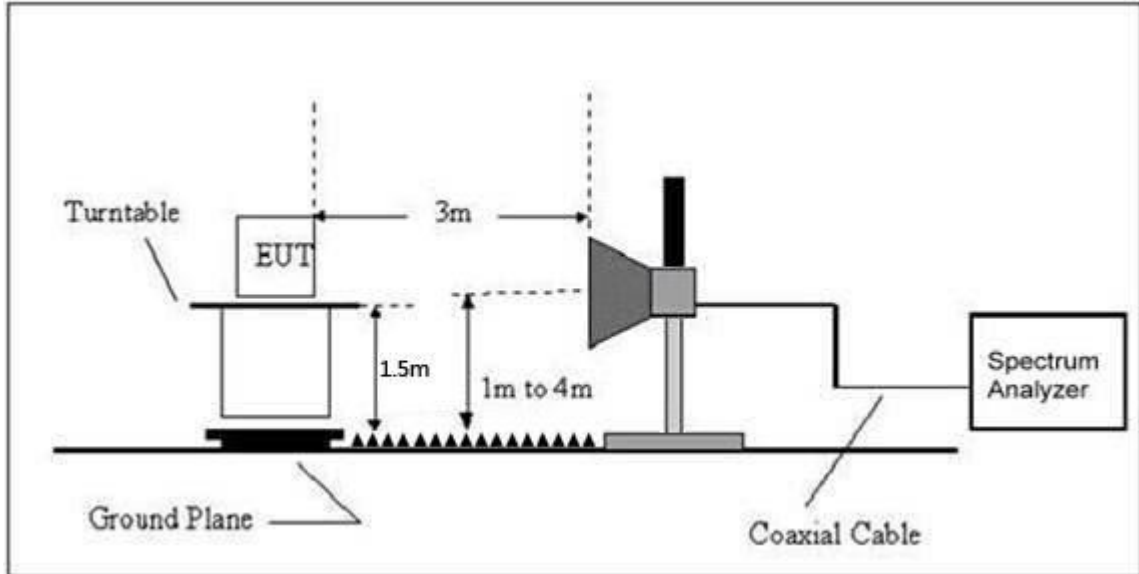

5.5 EUT OPERATING CONDITIONS

The EUT tested system was configured as the statements of 2.3 Unless otherwise a special operating condition is specified in the follows during the testing.

5.6 TEST RESULT

	Polar (H/V)	Frequency (MHz)	Meter Reading (dBuV)	Pre-amplifier (dB)	Cable Loss (dB)	Antenna Factor (dB/m)	Emission level (dBuV/m)	Limit (dBuV/m)	Detector Type	Result
GFSK	Low Channel: 2402MHz									
	H	2390.00	53.44	30.22	4.85	23.98	51.94	74.00	Pk	PASS
	H	2390.00	44.87	30.22	4.85	23.98	43.48	54.00	AV	PASS
	H	2400.00	54.16	30.22	4.85	23.98	52.77	74.00	Pk	PASS
	H	2400.00	44.09	30.22	4.85	23.98	42.70	54.00	AV	PASS
	V	2390.00	53.46	30.22	4.85	23.98	52.07	74.00	Pk	PASS
	V	2390.00	44.09	30.22	4.85	23.98	42.70	54.00	AV	PASS
	V	2400.00	54.87	30.22	4.85	23.98	53.48	74.00	Pk	PASS
	V	2400.00	44.96	30.22	4.85	23.98	43.57	54.00	AV	PASS
	High Channel: 2480MHz									
	H	2483.50	54.88	30.22	4.85	23.98	53.49	74.00	Pk	PASS
	H	2483.50	44.12	30.22	4.85	23.98	42.73	54.00	AV	PASS
	H	2500.00	53.43	30.22	4.85	23.98	52.04	74.00	Pk	PASS
	H	2500.00	44.09	30.22	4.85	23.98	42.70	54.00	AV	PASS
	V	2483.50	54.29	30.22	4.85	23.98	52.90	74.00	Pk	PASS
	V	2483.50	44.52	30.22	4.85	23.98	43.13	54.00	AV	PASS
V	2500.00	54.32	30.22	4.85	23.98	52.93	74.00	Pk	PASS	
V	2500.00	44.94	30.22	4.85	23.98	43.55	54.00	AV	PASS	
$\pi/4$ -DQPSK	Low Channel: 2402MHz									
	H	2390.00	53.75	30.22	4.85	23.98	52.36	74.00	Pk	PASS
	H	2390.00	44.83	30.22	4.85	23.98	43.44	54.00	AV	PASS
	H	2400.00	54.99	30.22	4.85	23.98	53.60	74.00	Pk	PASS
	H	2400.00	44.50	30.22	4.85	23.98	43.11	54.00	AV	PASS
	V	2390.00	53.22	30.22	4.85	23.98	51.83	74.00	Pk	PASS
	V	2390.00	44.62	30.22	4.85	23.98	43.23	54.00	AV	PASS
	V	2400.00	54.91	30.22	4.85	23.98	53.52	74.00	Pk	PASS
	V	2400.00	44.14	30.22	4.85	23.98	42.75	54.00	AV	PASS
	High Channel: 2480MHz									
	H	2483.50	54.77	30.22	4.85	23.98	53.38	74.00	Pk	PASS
	H	2483.50	44.06	30.22	4.85	23.98	42.67	54.00	AV	PASS
	H	2500.00	53.83	30.22	4.85	23.98	52.44	74.00	Pk	PASS
	H	2500.00	44.53	30.22	4.85	23.98	43.14	54.00	AV	PASS
	V	2483.50	53.64	30.22	4.85	23.98	52.25	74.00	Pk	PASS
	V	2483.50	44.54	30.22	4.85	23.98	43.15	54.00	AV	PASS
V	2500.00	53.43	30.22	4.85	23.98	52.04	74.00	Pk	PASS	
V	2500.00	44.79	30.22	4.85	23.98	43.40	54.00	AV	PASS	
8-DPSK	Low Channel: 2402MHz									
	H	2390.00	54.93	30.22	4.85	23.98	53.54	74.00	Pk	PASS
	H	2390.00	44.07	30.22	4.85	23.98	42.68	54.00	AV	PASS
	H	2400.00	53.56	30.22	4.85	23.98	52.17	74.00	Pk	PASS
	H	2400.00	44.99	30.22	4.85	23.98	43.60	54.00	AV	PASS
	V	2390.00	53.66	30.22	4.85	23.98	52.27	74.00	Pk	PASS
	V	2390.00	44.26	30.22	4.85	23.98	42.87	54.00	AV	PASS
	V	2400.00	53.59	30.22	4.85	23.98	52.20	74.00	Pk	PASS
	V	2400.00	44.10	30.22	4.85	23.98	42.71	54.00	AV	PASS
	High Channel: 2480MHz									
	H	2483.50	53.29	30.22	4.85	23.98	51.90	74.00	Pk	PASS
	H	2483.50	44.33	30.22	4.85	23.98	42.94	54.00	AV	PASS
	H	2500.00	54.74	30.22	4.85	23.98	53.35	74.00	Pk	PASS
	H	2500.00	44.20	30.22	4.85	23.98	42.81	54.00	AV	PASS
	V	2483.50	54.60	30.22	4.85	23.98	53.21	74.00	Pk	PASS
	V	2483.50	44.91	30.22	4.85	23.98	43.52	54.00	AV	PASS

	V	2500.00	53.34	30.22	4.85	23.98	51.95	74.00	Pk	PASS
	V	2500.00	44.13	30.22	4.85	23.98	42.74	54.00	AV	PASS

Remark:

1. Emission Level = Meter Reading + Antenna Factor + Cable Loss – Pre-amplifier, Margin= Emission Level - Limit

	Polar (H/V)	Frequency (MHz)	Meter Reading (dBuV)	Pre-amplifier (dB)	Cable Loss (dB)	Antenna Factor (dB/m)	Emission level (dBuV/m)	Limit (dBuV/m)	Detector Type	Result
GFSK	Hopping left edge									
	H	2390.00	53.05	30.22	4.85	23.98	51.89	74.00	Pk	PASS
	H	2390.00	44.36	30.22	4.85	23.98	42.97	54.00	AV	PASS
	H	2400.00	54.42	30.22	4.85	23.98	53.03	74.00	Pk	PASS
	H	2400.00	44.11	30.22	4.85	23.98	42.72	54.00	AV	PASS
	V	2390.00	54.28	30.22	4.85	23.98	52.89	74.00	Pk	PASS
	V	2390.00	44.68	30.22	4.85	23.98	43.29	54.00	AV	PASS
	V	2400.00	53.61	30.22	4.85	23.98	52.22	74.00	Pk	PASS
	V	2400.00	44.65	30.22	4.85	23.98	43.26	54.00	AV	PASS
	Hopping right edge									
	H	2483.50	54.16	30.22	4.85	23.98	52.77	74.00	Pk	PASS
	H	2483.50	44.78	30.22	4.85	23.98	43.39	54.00	AV	PASS
	H	2500.00	53.40	30.22	4.85	23.98	52.01	74.00	Pk	PASS
	H	2500.00	44.46	30.22	4.85	23.98	43.07	54.00	AV	PASS
	V	2483.50	53.44	30.22	4.85	23.98	52.05	74.00	Pk	PASS
	V	2483.50	44.01	30.22	4.85	23.98	42.62	54.00	AV	PASS
V	2500.00	54.88	30.22	4.85	23.98	53.49	74.00	Pk	PASS	
V	2500.00	44.34	30.22	4.85	23.98	42.95	54.00	AV	PASS	
π/4-DQPSK	Hopping left edge									
	H	2390.00	54.56	30.22	4.85	23.98	53.17	74.00	Pk	PASS
	H	2390.00	44.50	30.22	4.85	23.98	43.11	54.00	AV	PASS
	H	2400.00	54.14	30.22	4.85	23.98	52.75	74.00	Pk	PASS
	H	2400.00	44.88	30.22	4.85	23.98	43.49	54.00	AV	PASS
	V	2390.00	54.61	30.22	4.85	23.98	53.22	74.00	Pk	PASS
	V	2390.00	44.34	30.22	4.85	23.98	42.95	54.00	AV	PASS
	V	2400.00	54.89	30.22	4.85	23.98	53.50	74.00	Pk	PASS
	V	2400.00	44.64	30.22	4.85	23.98	43.25	54.00	AV	PASS
	Hopping right edge									
	H	2483.50	53.40	30.22	4.85	23.98	52.01	74.00	Pk	PASS
	H	2483.50	44.56	30.22	4.85	23.98	43.17	54.00	AV	PASS
	H	2500.00	54.14	30.22	4.85	23.98	52.75	74.00	Pk	PASS
	H	2500.00	44.92	30.22	4.85	23.98	43.53	54.00	AV	PASS
	V	2483.50	53.45	30.22	4.85	23.98	52.06	74.00	Pk	PASS
	V	2483.50	44.16	30.22	4.85	23.98	42.77	54.00	AV	PASS
V	2500.00	53.85	30.22	4.85	23.98	52.46	74.00	Pk	PASS	
V	2500.00	44.63	30.22	4.85	23.98	43.24	54.00	AV	PASS	
8-DPSK	Hopping left edge									
	H	2390.00	54.49	30.22	4.85	23.98	53.10	74.00	Pk	PASS
	H	2390.00	44.87	30.22	4.85	23.98	43.48	54.00	AV	PASS
	H	2400.00	54.97	30.22	4.85	23.98	53.58	74.00	Pk	PASS
	H	2400.00	44.46	30.22	4.85	23.98	43.07	54.00	AV	PASS
	V	2390.00	54.69	30.22	4.85	23.98	53.30	74.00	Pk	PASS
	V	2390.00	44.70	30.22	4.85	23.98	43.31	54.00	AV	PASS
	V	2400.00	54.58	30.22	4.85	23.98	53.19	74.00	Pk	PASS
	V	2400.00	44.63	30.22	4.85	23.98	43.24	54.00	AV	PASS
	Hopping right edge									
H	2483.50	54.22	30.22	4.85	23.98	52.83	74.00	Pk	PASS	
H	2483.50	44.06	30.22	4.85	23.98	42.67	54.00	AV	PASS	

	H	2500.00	53.76	30.22	4.85	23.98	52.37	74.00	Pk	PASS
	H	2500.00	44.74	30.22	4.85	23.98	43.35	54.00	AV	PASS
	V	2483.50	53.73	30.22	4.85	23.98	52.34	74.00	Pk	PASS
	V	2483.50	44.49	30.22	4.85	23.98	43.10	54.00	AV	PASS
	V	2500.00	54.30	30.22	4.85	23.98	52.91	74.00	Pk	PASS
	V	2500.00	44.69	30.22	4.85	23.98	43.30	54.00	AV	PASS

Remark:

1. Emission Level = Meter Reading + Antenna Factor + Cable Loss – Pre-amplifier, Margin= Emission Level - Limit

6. CONDUCTED BAND EDGE AND SPURIOUS EMISSION

Test Requirement:	FCC Part15 C Section 15.247 (d)
Test Method:	KDB558074 D0115.247 Meas Guidancev05r02

6.1 Limit

Regulation 15.247 (d), In any 100 kHz bandwidth outside the frequency band in which the spread spectrum or digitally modulated intentional radiator is operating, the radio frequency power that is produced by the intentional radiator shall be at least 20 dB below that in the 100 kHz bandwidth within the band that contains the highest level of the desired power, based on either an RF conducted or a radiated measurement, provided the transmitter demonstrates compliance with the peak conducted power limits. If the transmitter complies with the conducted power limits based on the use of RMS averaging over a time interval, as permitted under paragraph (b)(3) of this section, the attenuation required under this paragraph shall be 30 dB instead of 20 dB. Attenuation below the general limits specified in §15.209(a) is not required. In addition, radiated emissions which fall in the restricted bands, as defined in §15.205(a), must also comply with the radiated emission limits specified in §15.209(a) (see §15.205(c)).

6.2 Test Setup**6.3 Test procedure**

Using the following spectrum analyzer setting:

- A) Set the RBW = 100KHz.
- B) Set the VBW = 300KHz.
- C) Sweep time = auto couple.
- D) Detector function = peak.
- E) Trace mode = max hold.
- F) Allow trace to fully stabilize.

6.4 DEVIATION FROM STANDARD

No deviation.

6.5 Test Result

GFSK mode:

Test channel:	Lowest channel
---------------	----------------

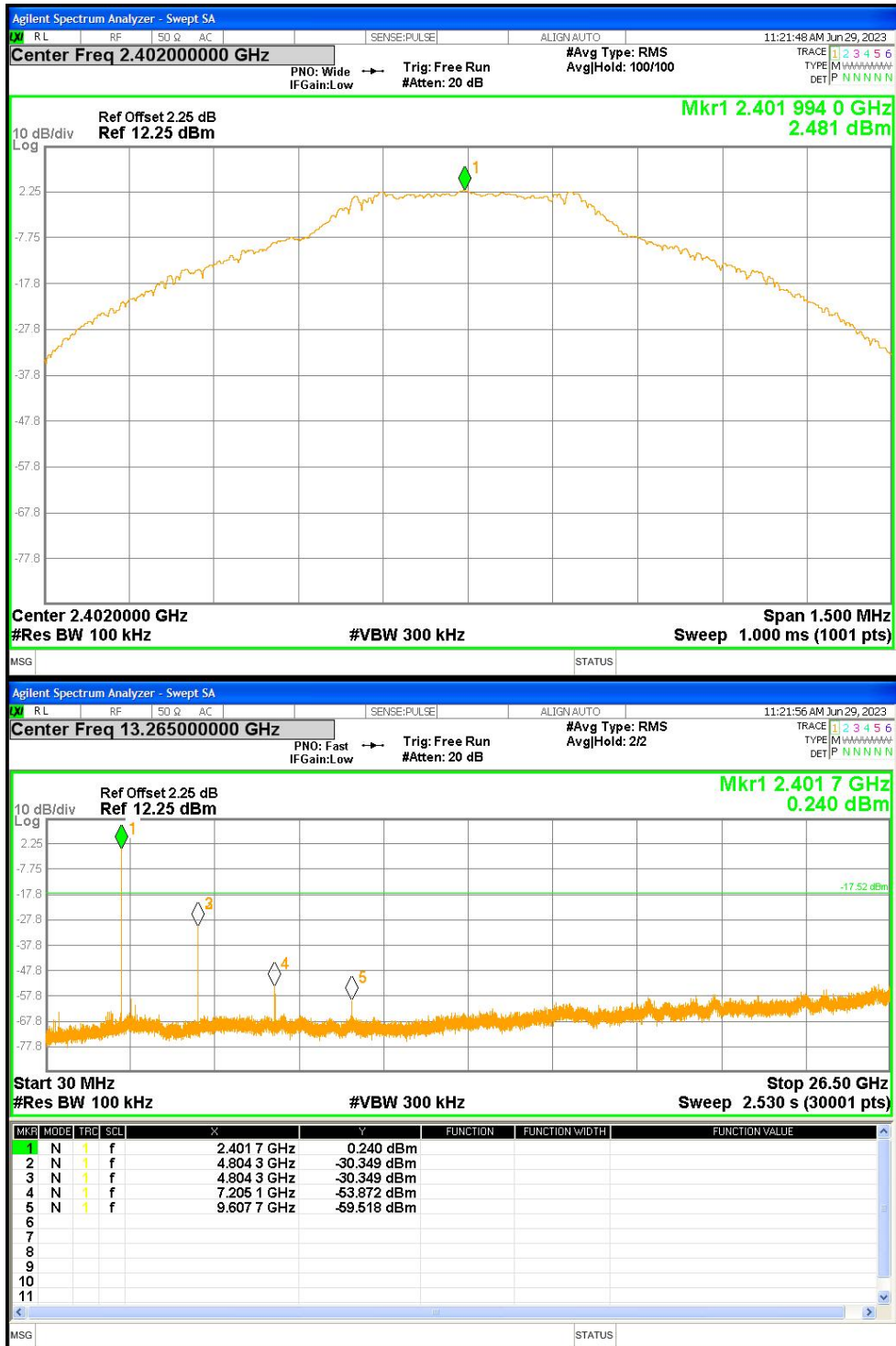

30MHz~26.5GHz

Test channel: Middle channel

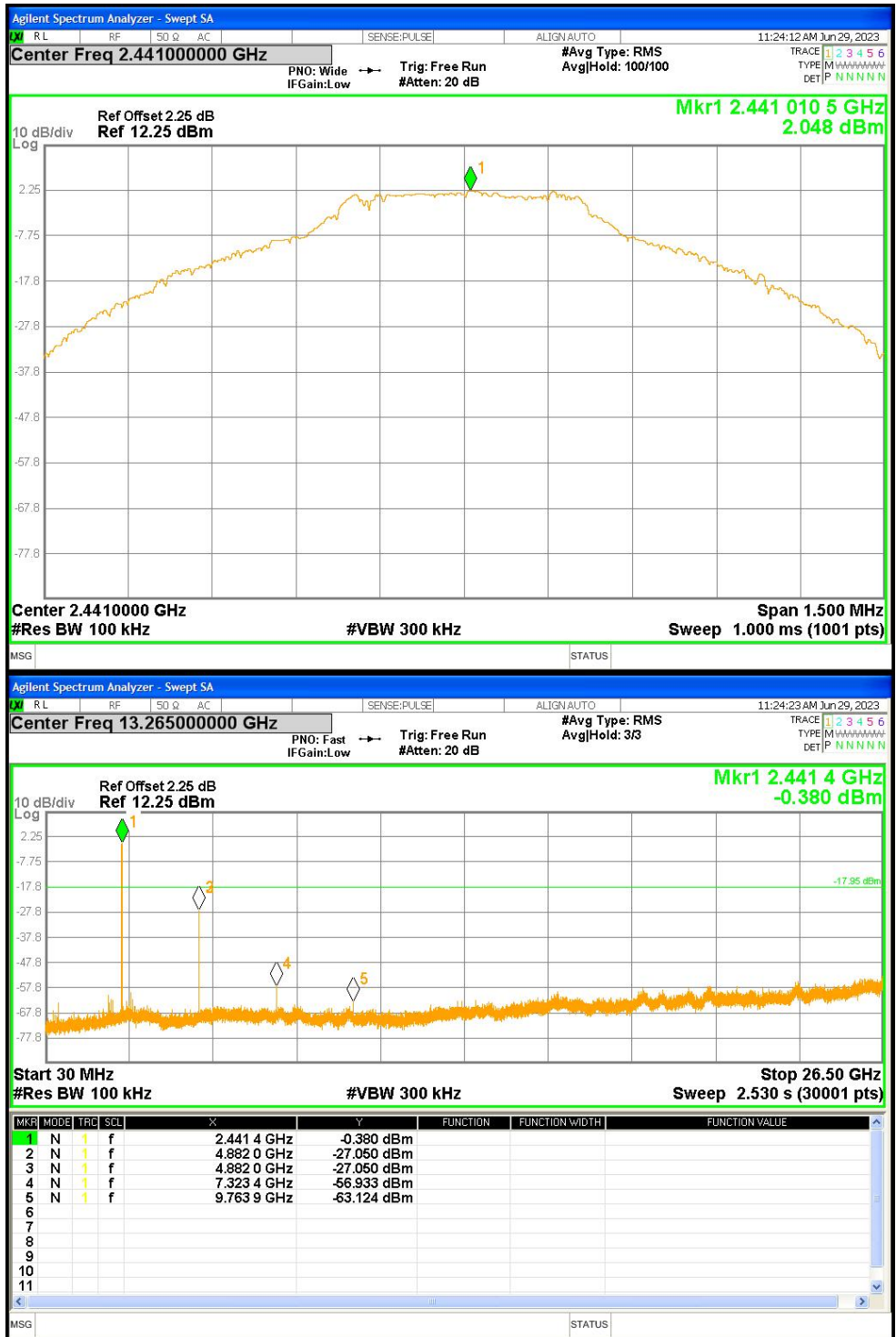

30MHz~26.5GHz

Test channel: Highest channel

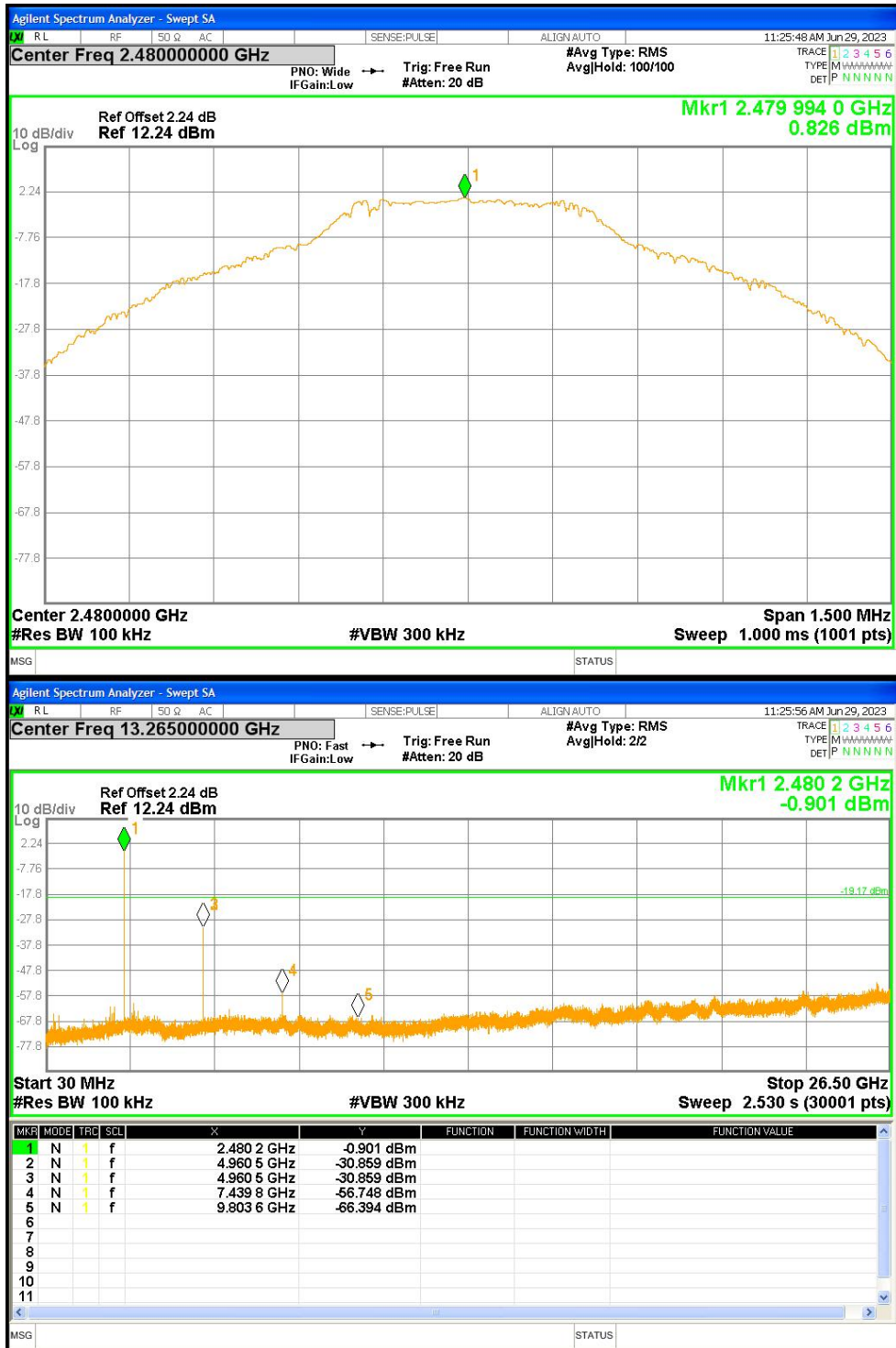

30MHz~26.5GHz

$\pi/4$ -DQPSK mode:

Test channel:	Lowest channel
---------------	----------------

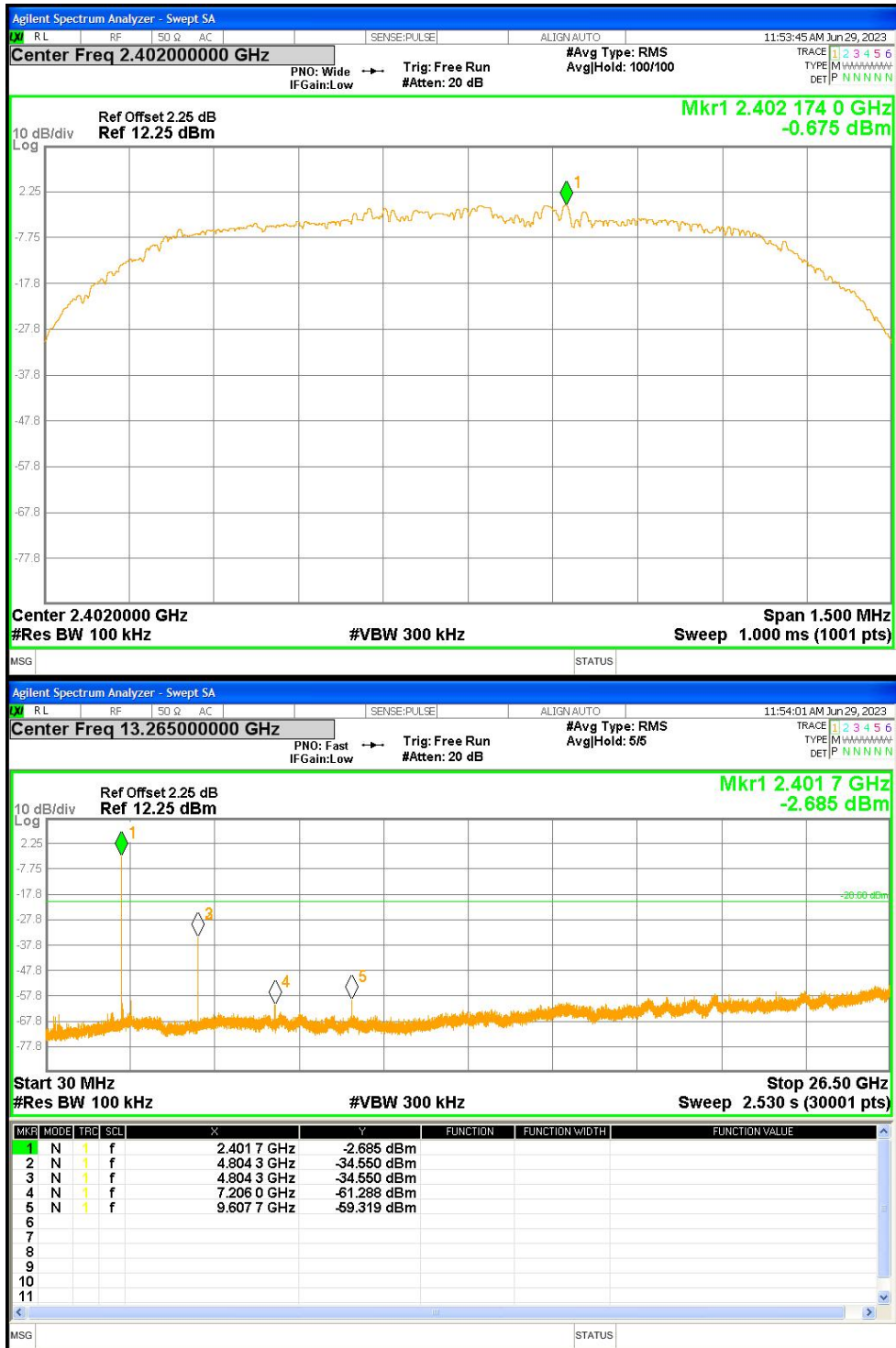

30MHz~26.5GHz

Test channel: Middle channel

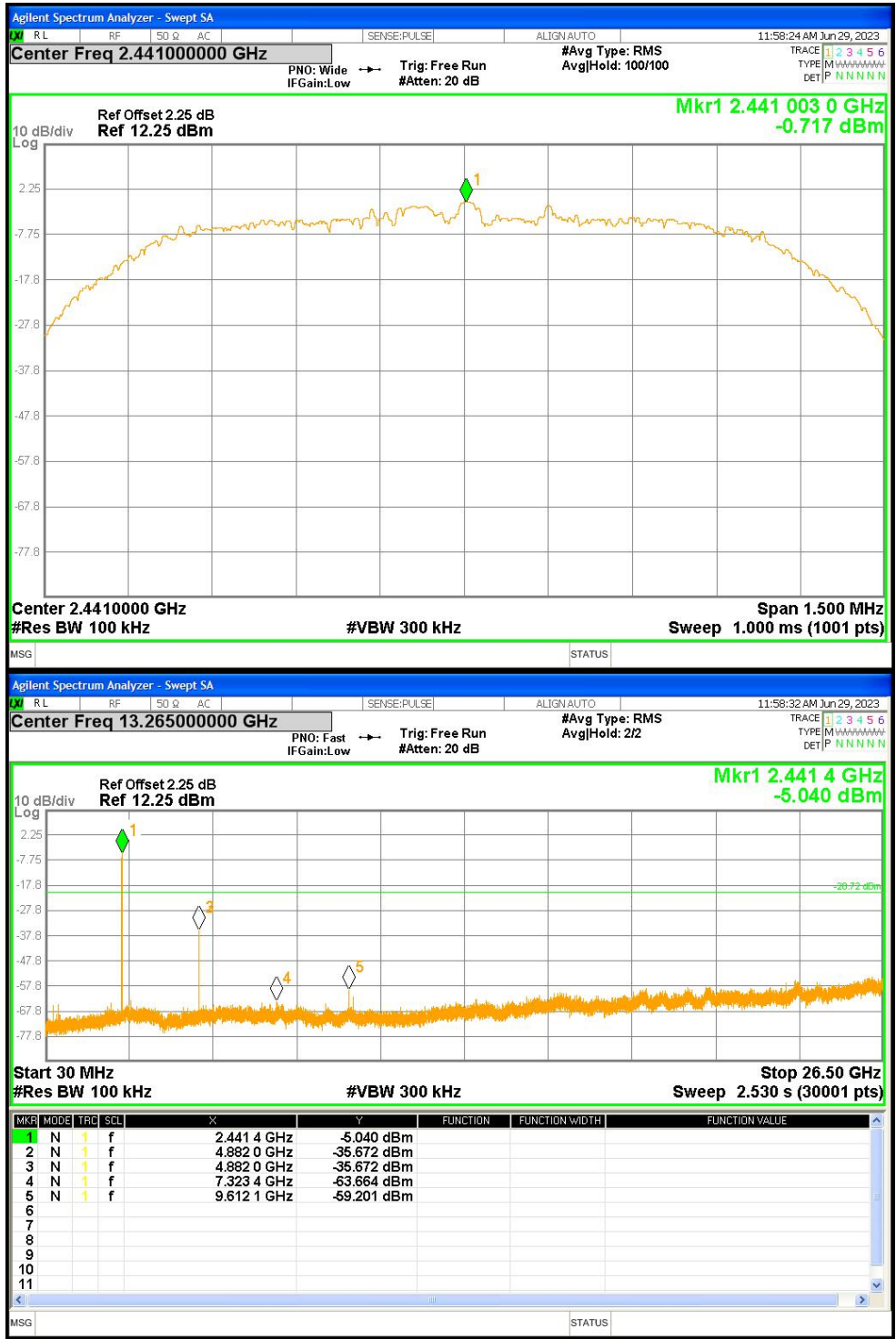

30MHz~26.5GHz

Test channel:	Highest channel
---------------	-----------------

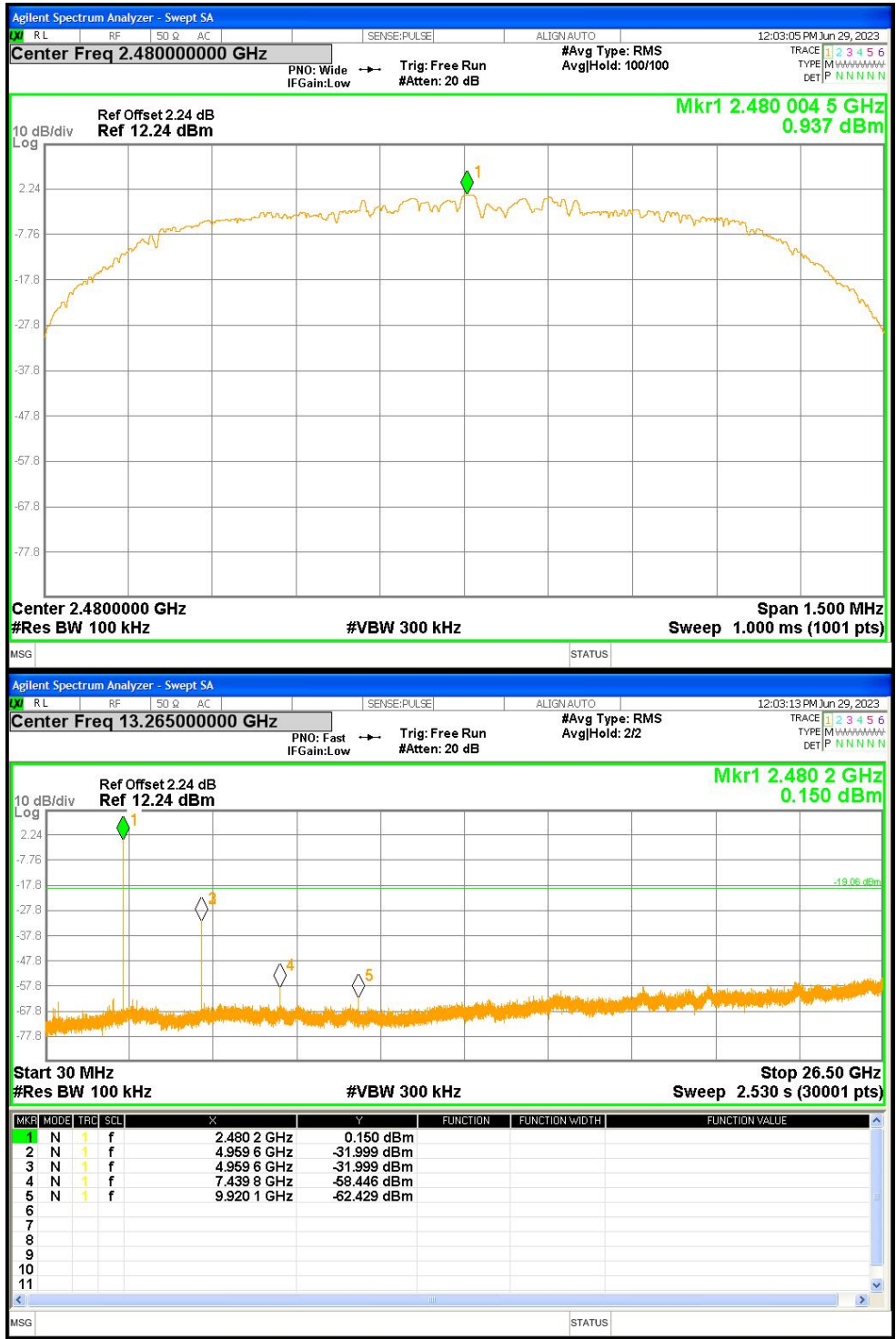

30MHz~26.5GHz

8-DPSK mode:

Test channel:	Lowest channel
---------------	----------------

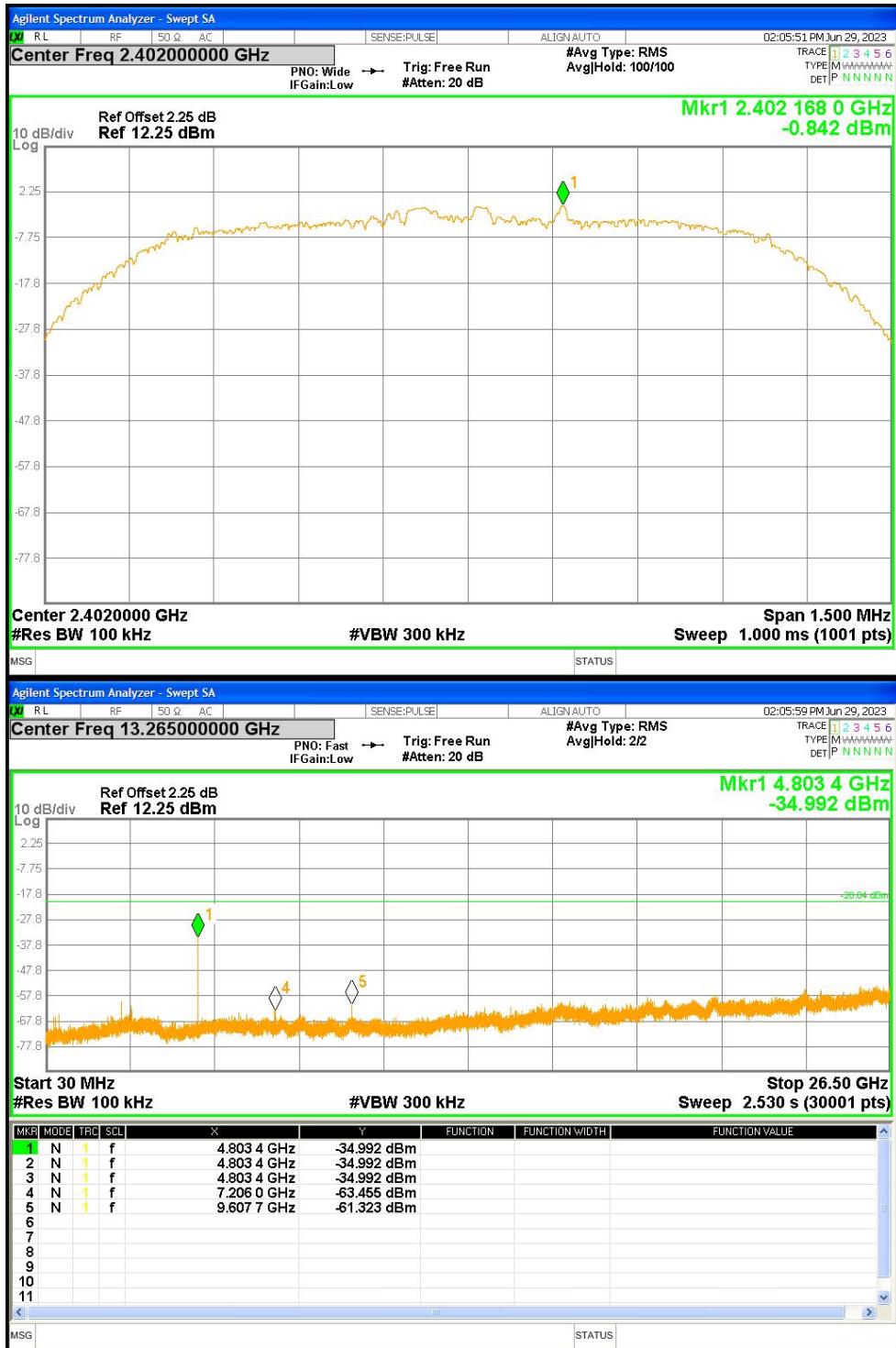

30MHz~26.5GHz

Test channel: Middle channel

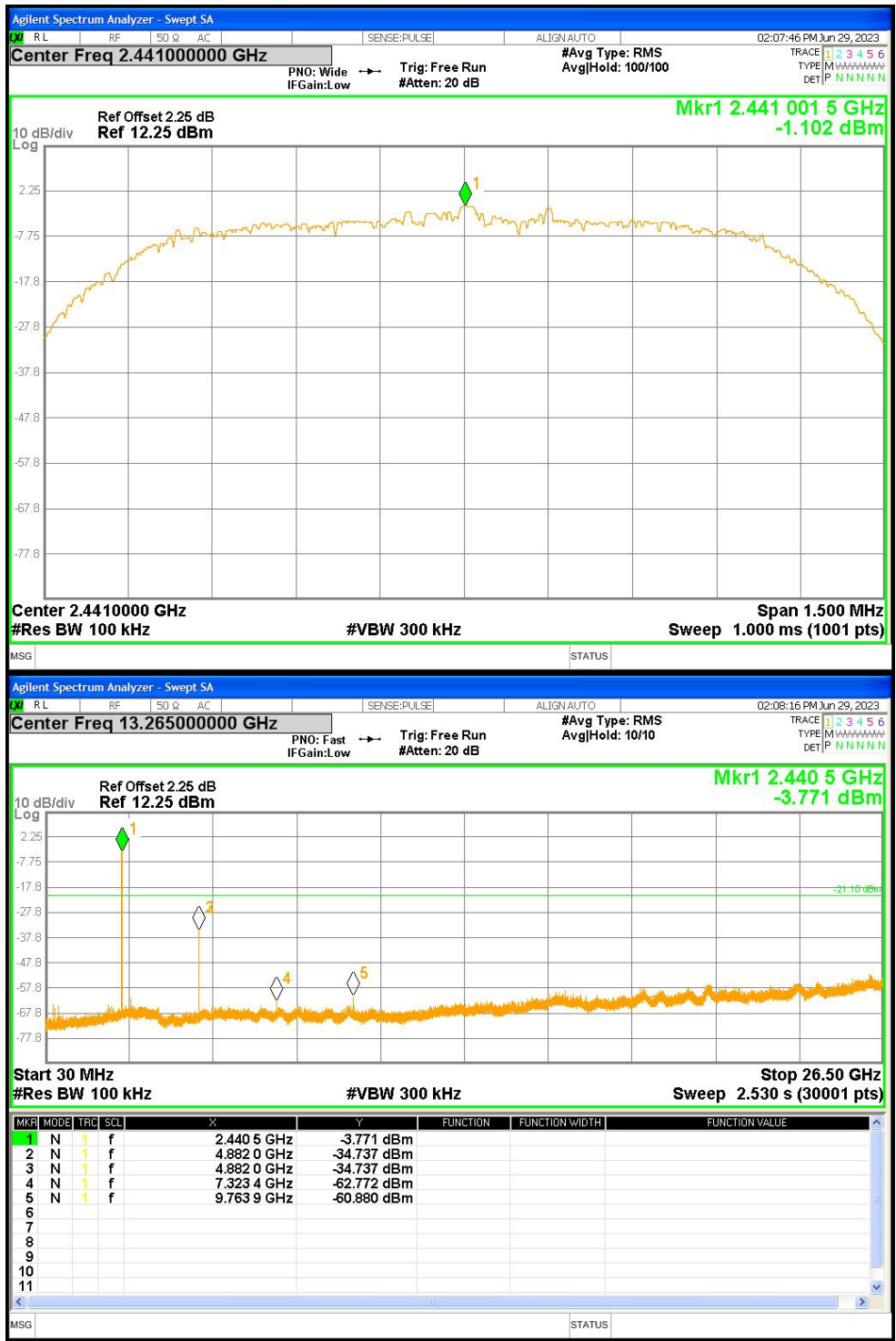

30MHz~26.5GHz

Test channel:	Highest channel
---------------	-----------------

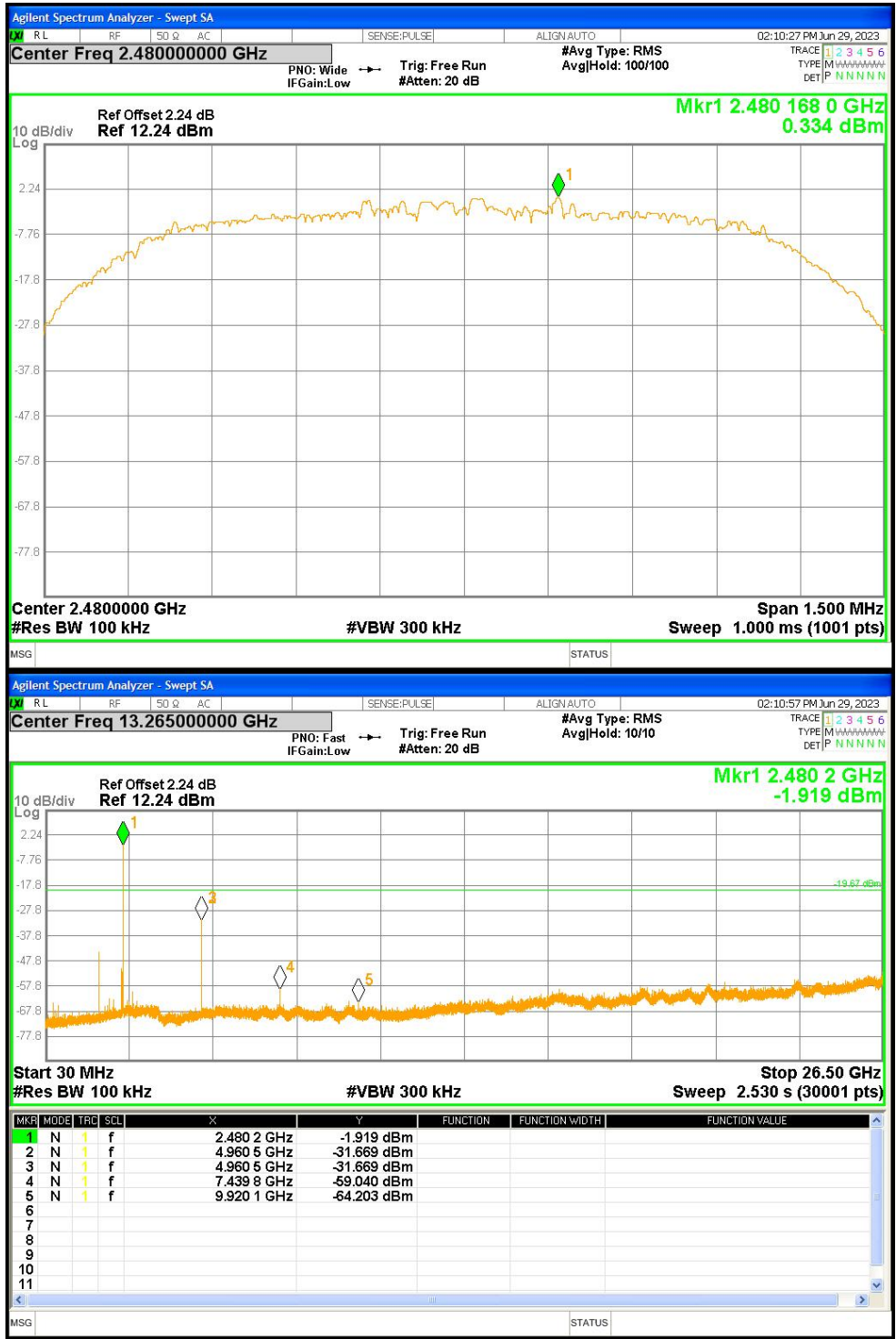

30MHz~26.5GHz

GFSK No-hopping Band edge-left side

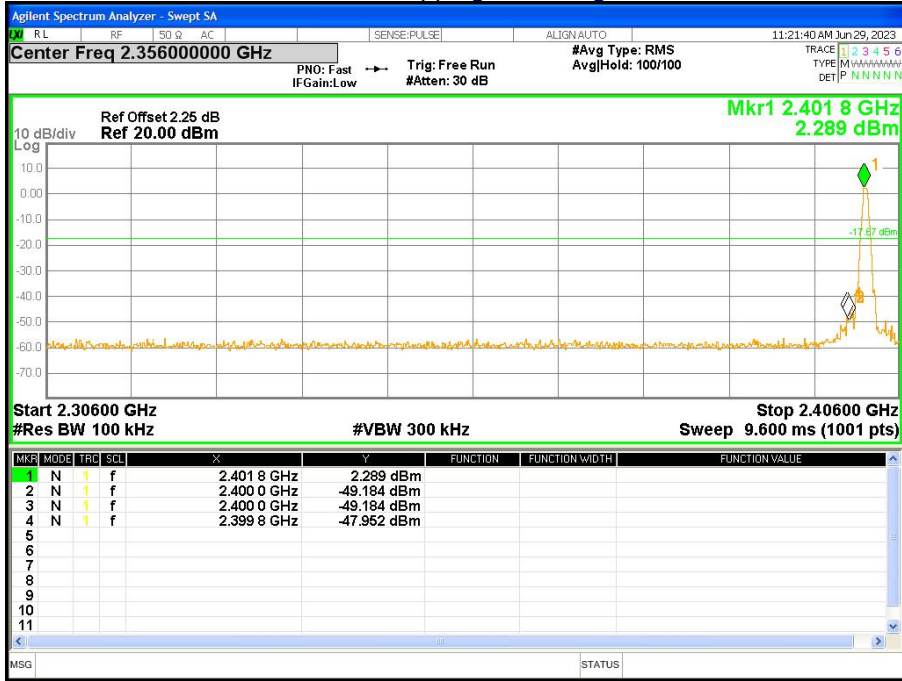

GFSK Hopping Band edge-left side

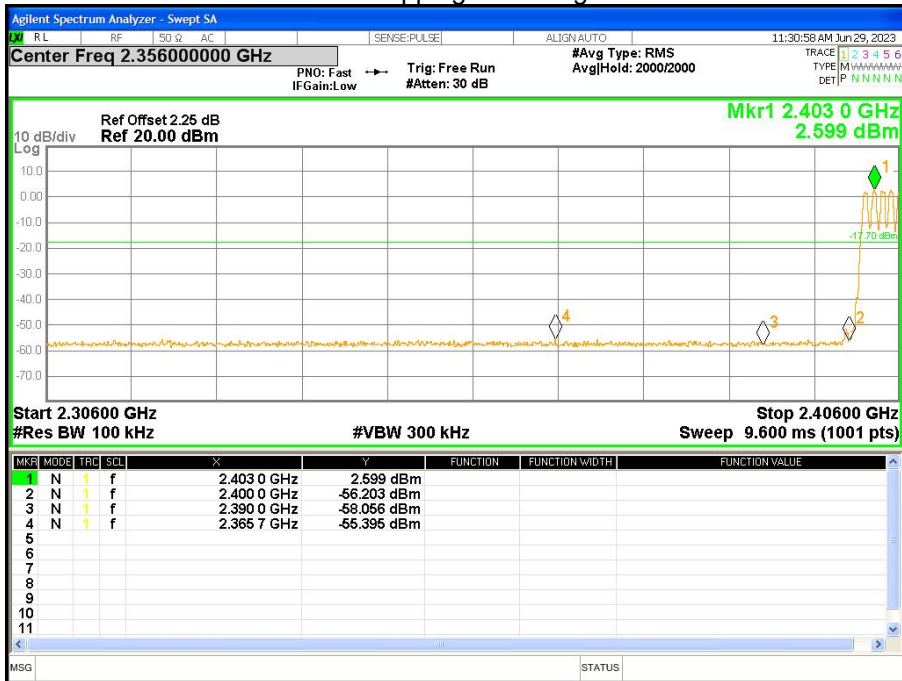

GFSK No-hopping Band edge-right side

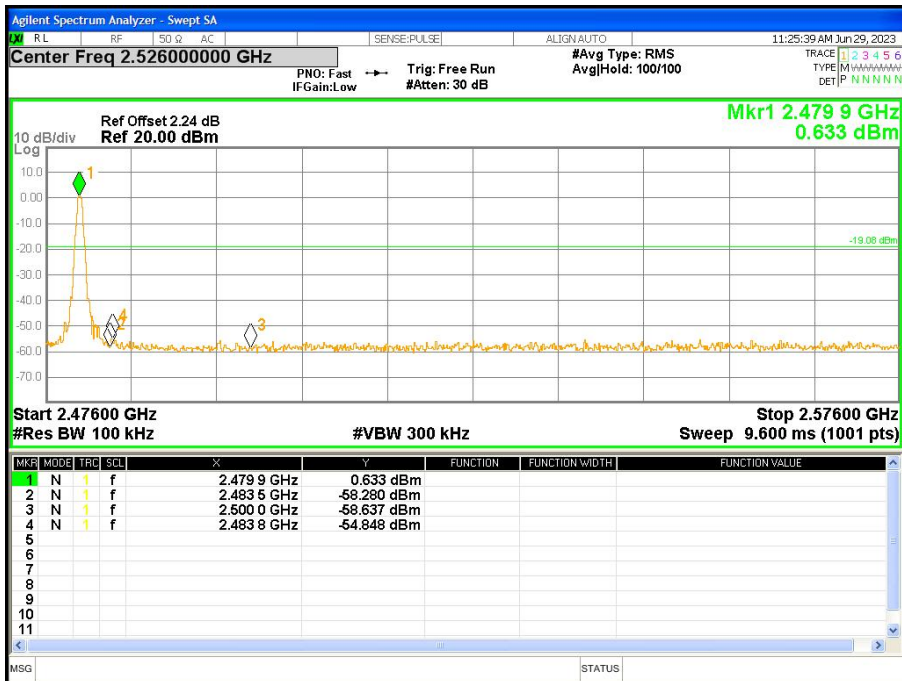

GFSK Hopping Band edge-right side

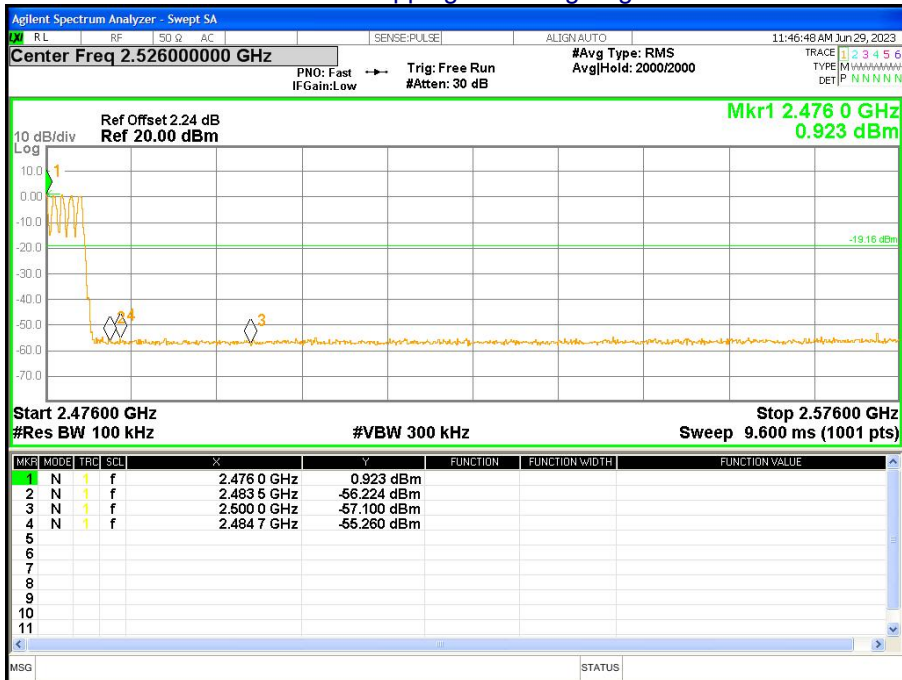

$\pi/4$ -DQPSK No-hopping Band edge-left side

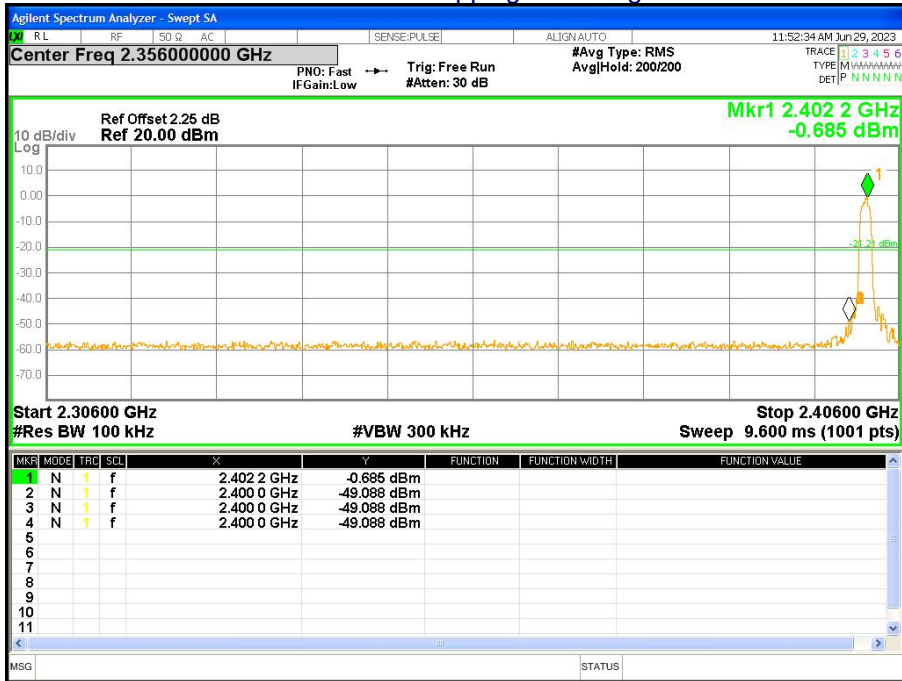

$\pi/4$ -DQPSK Hopping Band edge-left side

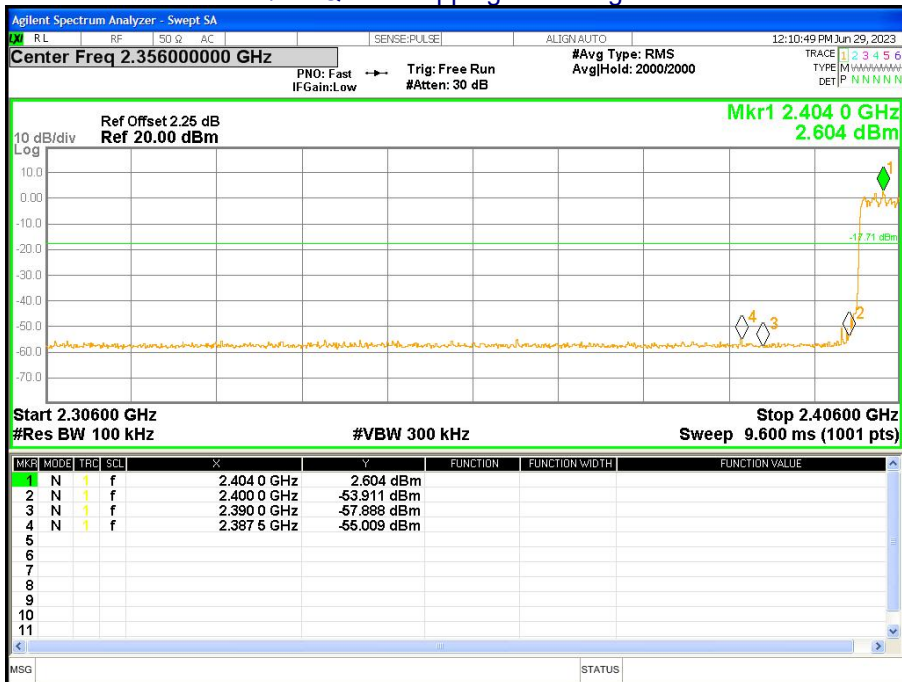

$\pi/4$ -DQPSK No-hopping Band edge-right side

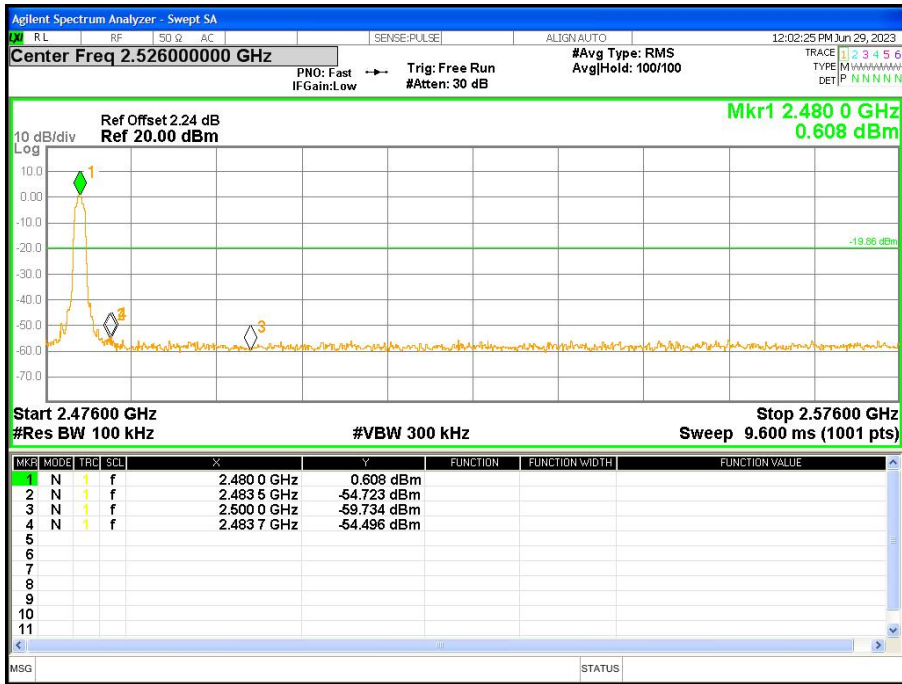

$\pi/4$ -DQPSK Hopping Band edge-right side

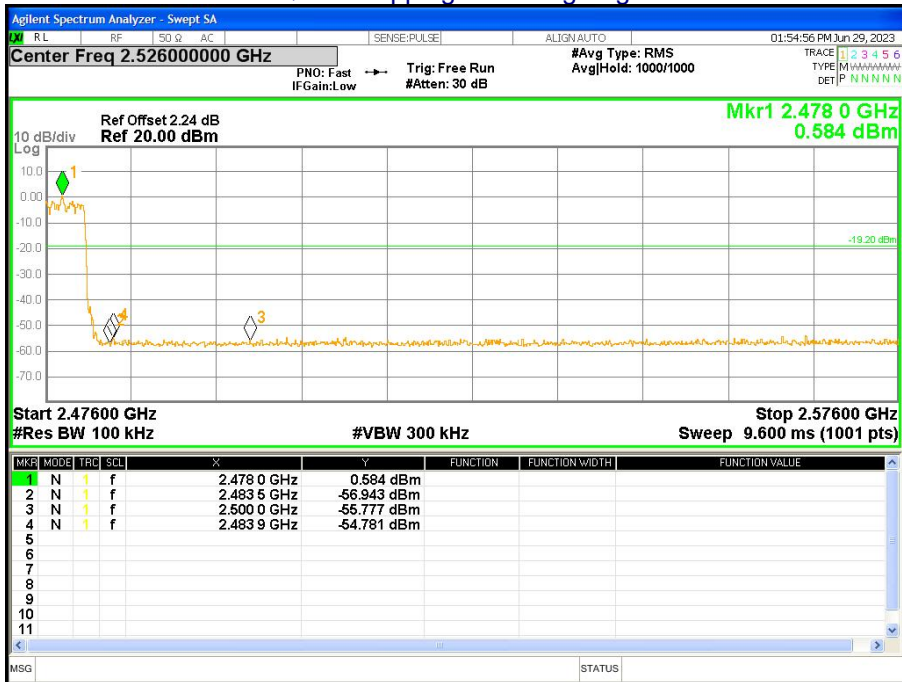

8-DPSK No-hopping Band edge-left side

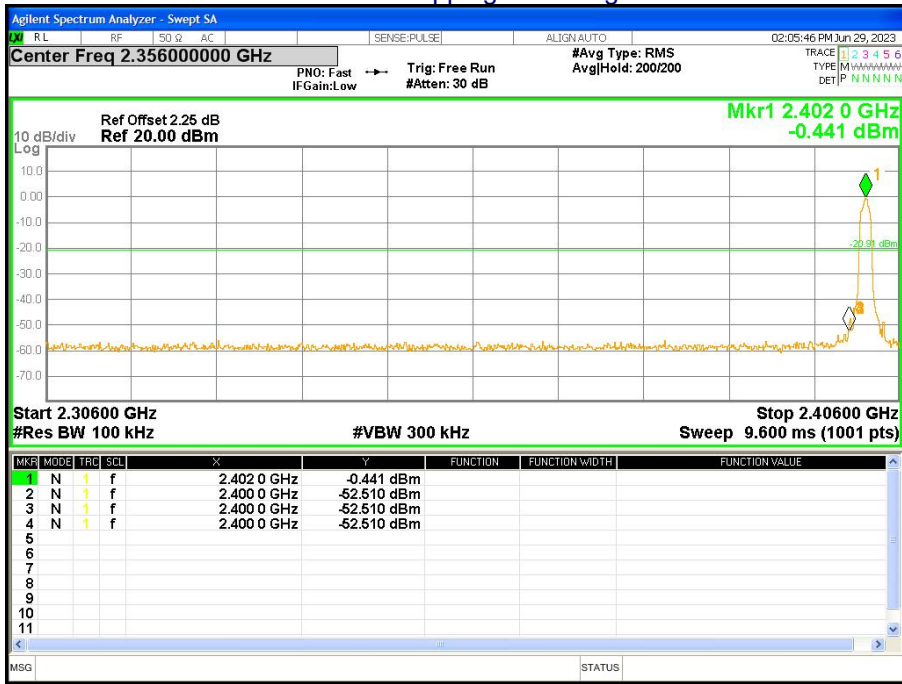

8-DPSK Hopping Band edge-left side

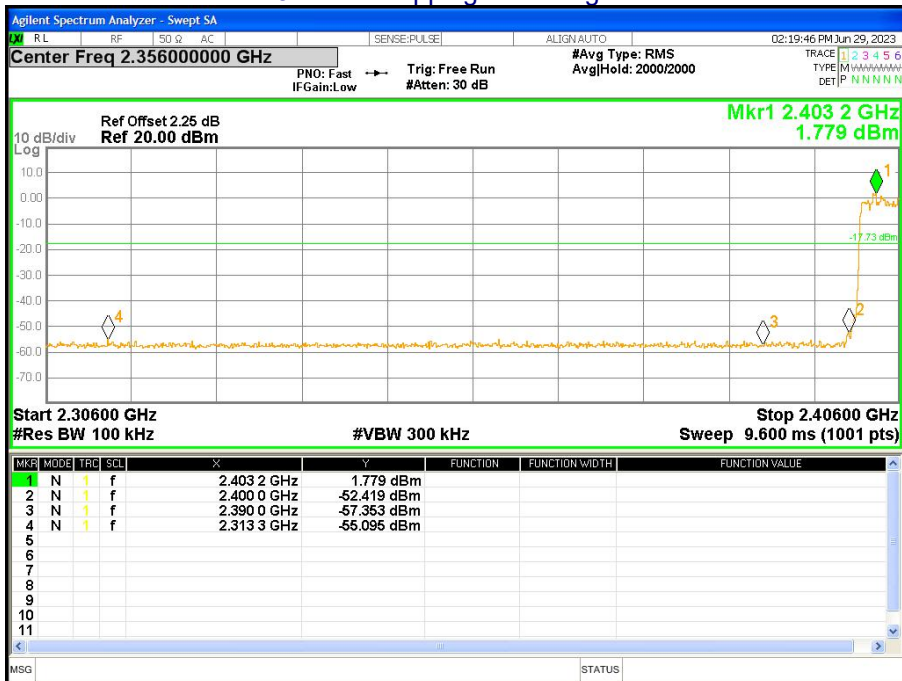

8-DPSK No-hopping Band edge-right side

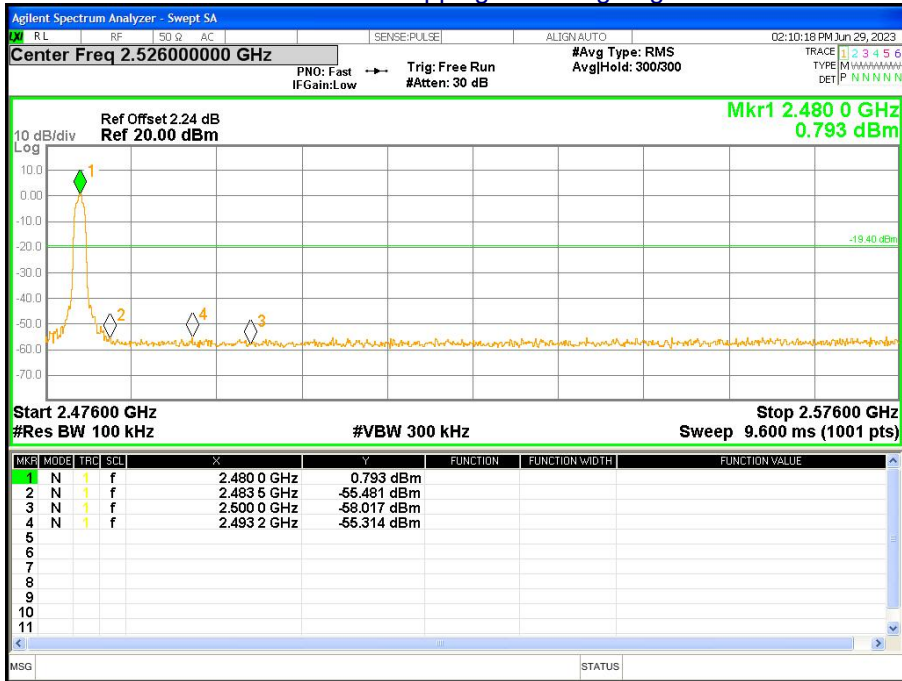

8-DPSK Hopping Band edge-right side

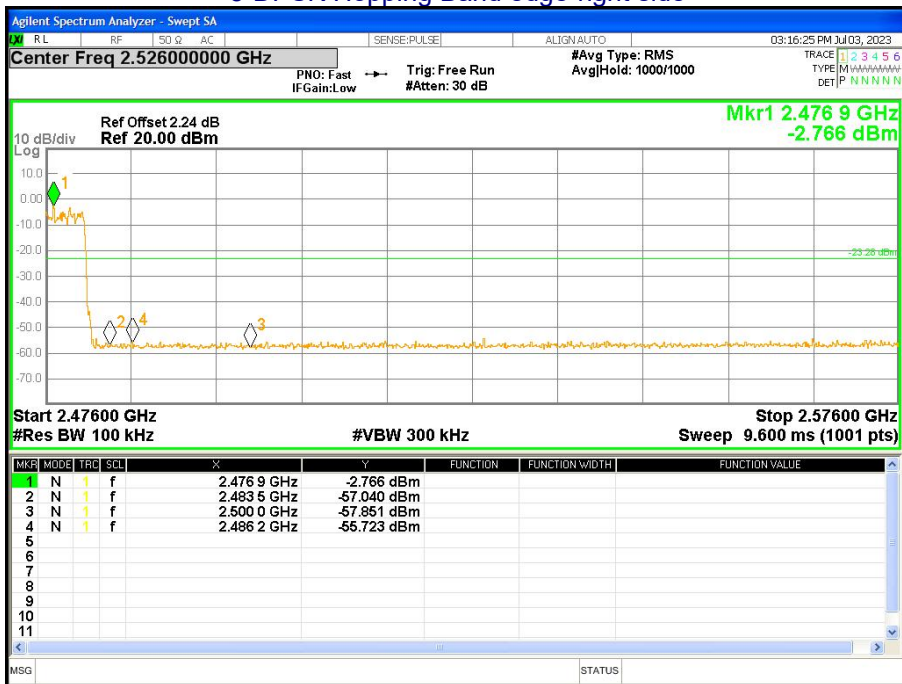

7. 20DB&99% BANDWIDTH

Test Requirement:	FCC Part15 C Section 15.247 (a)(1)
Test Method:	ANSI C63.10:2013

7.1 Test Setup



7.2 Limit

N/A

7.3 Test procedure

1. Set RBW = 30 kHz.
2. Set the video bandwidth (VBW) $\geq 3 \times$ RBW.
3. Detector = Peak.
4. Trace mode = max hold.
5. Sweep = auto couple.
6. Allow the trace to stabilize.
7. Measure the maximum width of the emission that is constrained by the frequencies associated with the two outermost amplitude points (upper and lower frequencies) that are attenuated by 6 dB relative to the maximum level measured in the fundamental emission.

7.4 DEVIATION FROM STANDARD

No deviation.

7.5 Test Result

Mode	Test channel	20dB Emission Bandwidth (MHz)	99%Bandwidth (MHz)	Result
GFSK	Lowest	0.948	0.851	Pass
	Middle	0.94	0.859	
	Highest	0.955	0.857	
$\pi/4$ -DQPSK	Lowest	1.318	1.181	Pass
	Middle	1.279	1.177	
	Highest	1.282	1.169	
8-DPSK	Lowest	1.311	1.171	Pass
	Middle	1.282	1.167	
	Highest	1.303	1.169	

Test plots

GFSK Low Channel

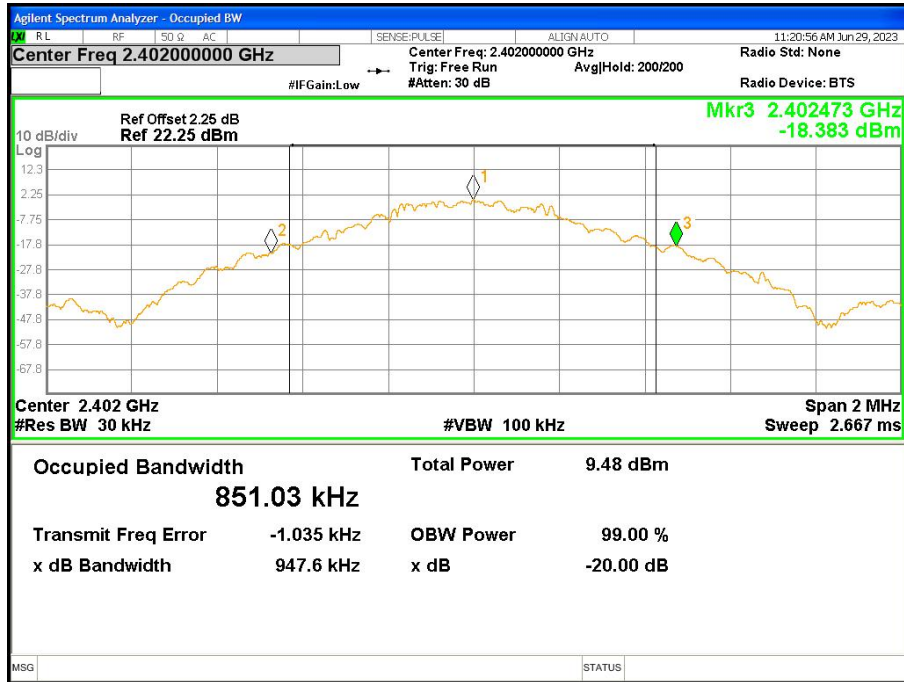

GFSK Middle Channel

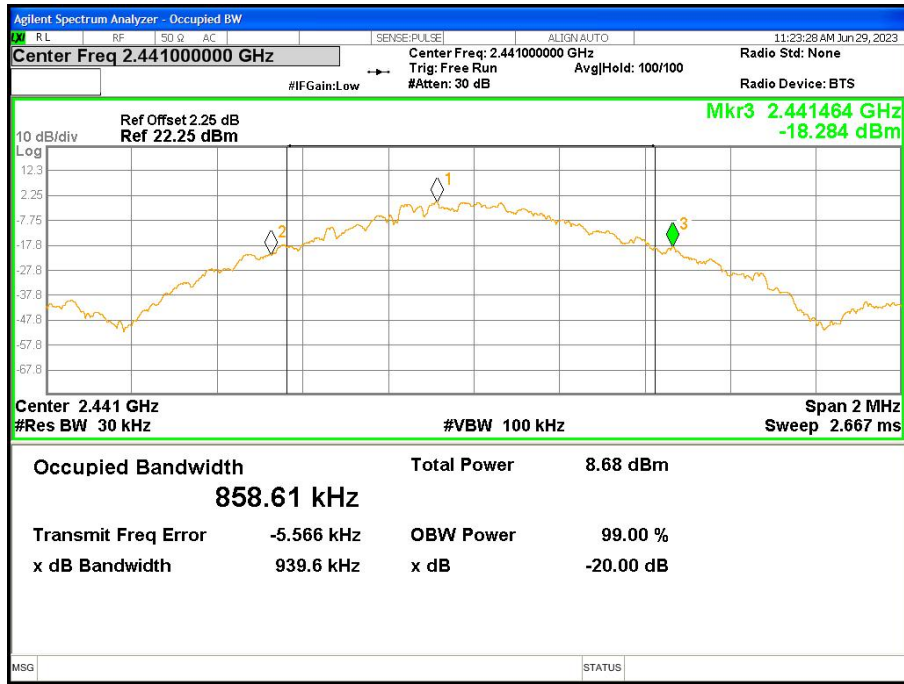

GFSK High Channel

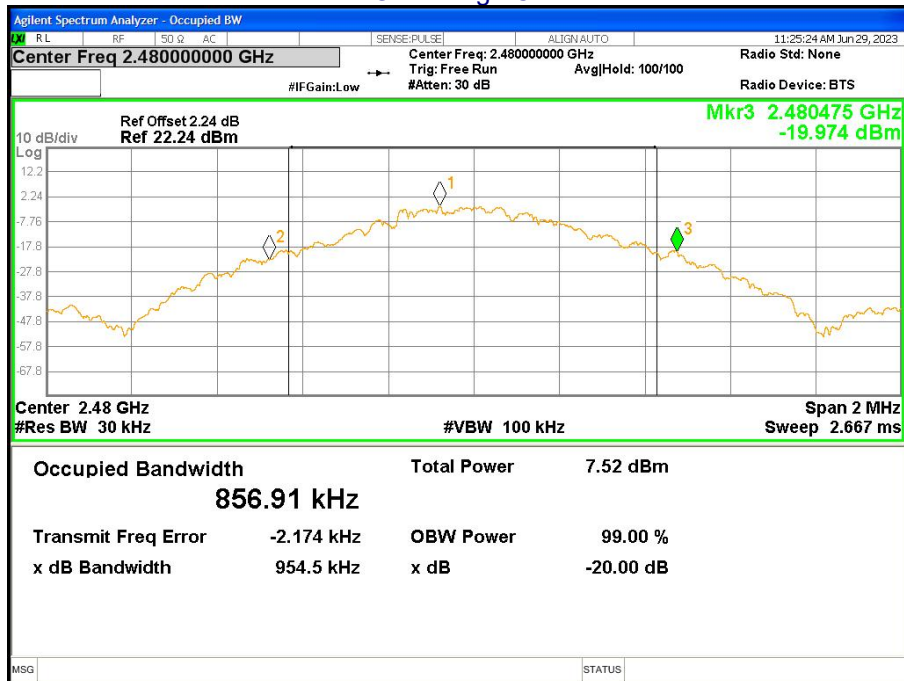

$\pi/4$ -DQPSK Low Channel

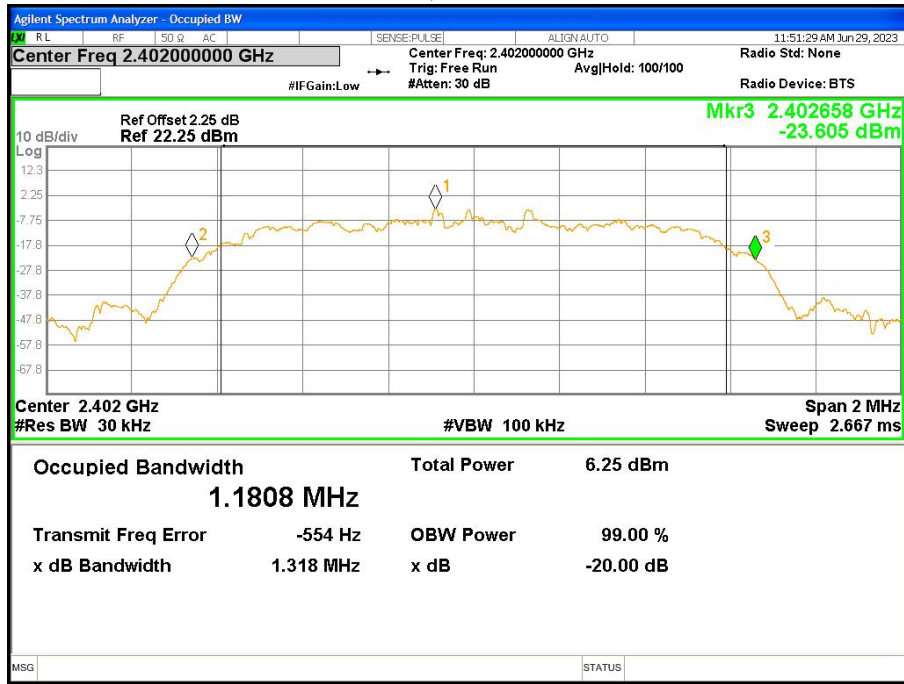

$\pi/4$ -DQPSK Middle Channel

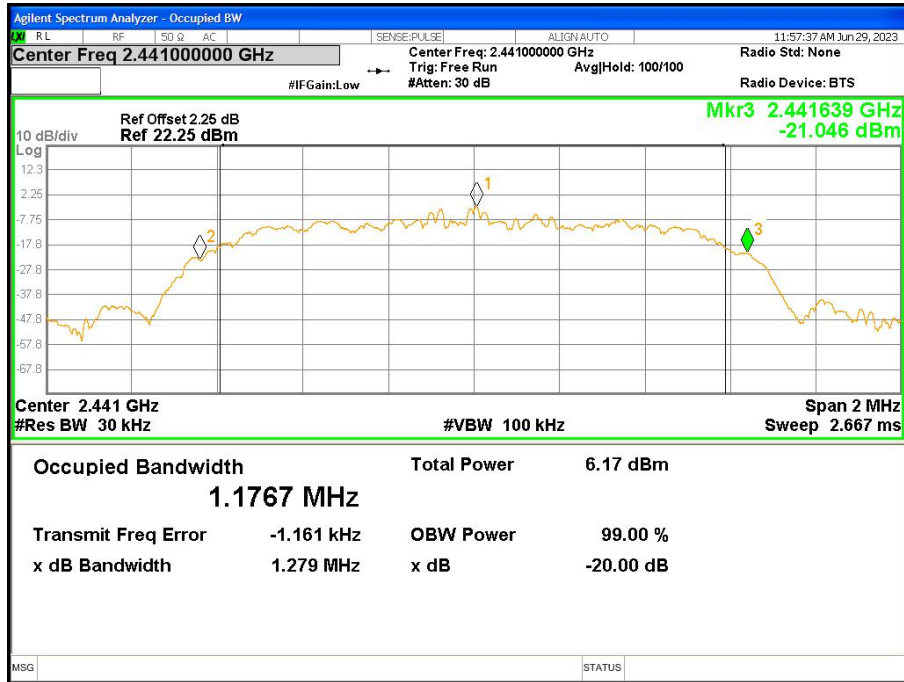

$\pi/4$ -DQPSK High Channel

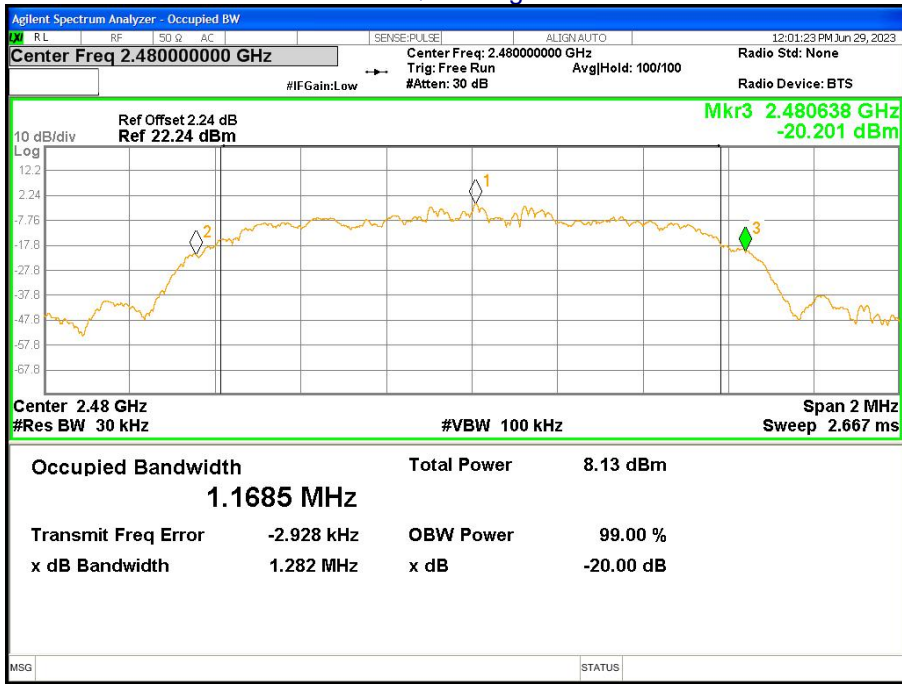

8-DPSK Low Channel

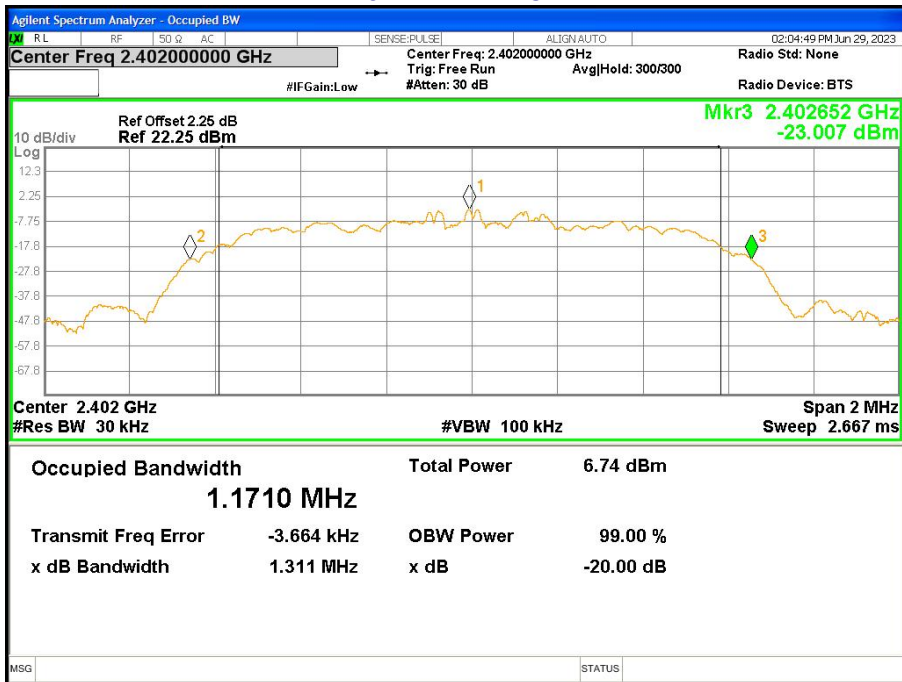

8-DPSK Middle Channel

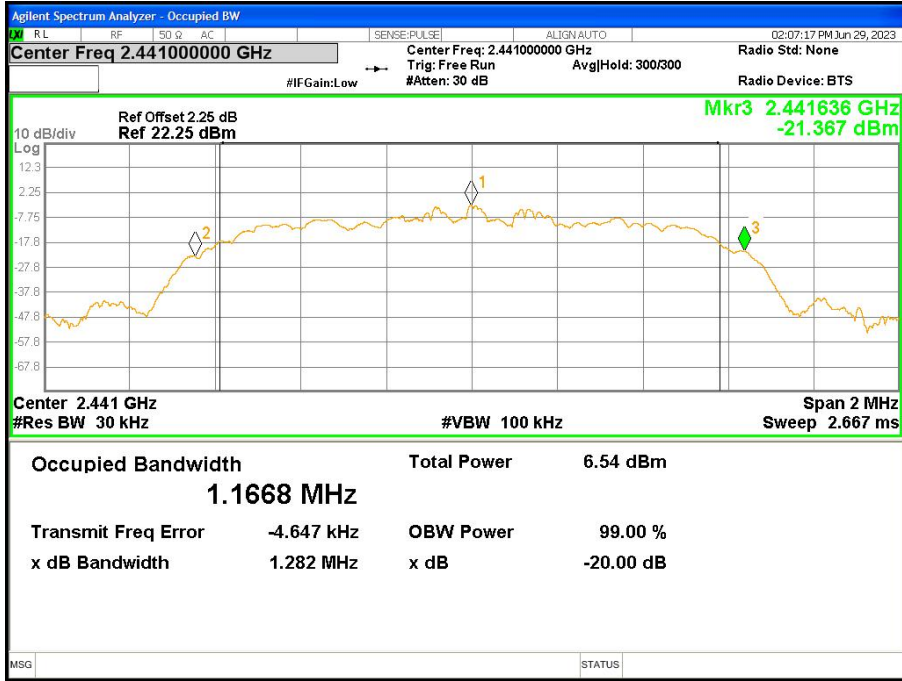

8-DPSK High Channel

